

# DENDOUMARU

## 9000 *Beast Master*

### INSTRUCTION MANUAL

Thank you for purchasing a Shimano DENDOUMARU 9000 Beast Master.  
Before using this reel, please make sure you read the manual thoroughly and keep it in a safe place for future reference.



Safety Precautions.....	2	Automatic Gunwale Stop .....	36
Features .....	8	Alarm (Gunwale) .....	37
Digital Display Component Names .....	10	Programming Target Depth and Bottom Depth.....	38
Part Names.....	11	Finding the Target Depth.....	40
Menu Button Operation .....	12	Top-Down Mode Example .....	41
Power Supply   Cord .....	14	Bottom-Up Mode Example.....	42
Learning Methods .....	16	Winding In: Rakuraku Mode   Fixed Speed Mode .....	43
Learning Methods (Flow Diagram) .....	18	Jigging Mode .....	45
Learning Methods 1. PE Line (Line with markings every meter.) .....	20	Jigging Learning.....	47
Learning Methods 2. Nylon Line (Line with no markers.).....	22	Rig Retrieval Time.....	51
Learning Methods 3. Backing Line.....	24	Line Learning Adjustment .....	52
What to do after completing Learning .....	28	Handing Instructions.....	54
Various Techniques .....	30	Specifications .....	59
Zero Setting .....	32	Troubleshooting .....	60
Adjusting Smart Line Depth .....	34	Product Inquiries /After Sales Service Information.....	62
S A-RB .....	35	Service network.....	63

# Safety Precautions

Please read these safety precautions before using the reel.



## Warning



### Caution: High Temperature

- Use only the specified voltage (DC12~24V) from a battery or the vessel's onboard power supply.  
Using voltages other than those specified may cause the reel to heat up, damage electrical components or burn your hand.
- NEVER connect the reel to a household power supply or a battery charger.  
Doing so may damage the circuit boards and cause fire and smoke.
- Stop using the reel IMMEDIATELY if the power supply connector or alligator clips become abnormally hot.

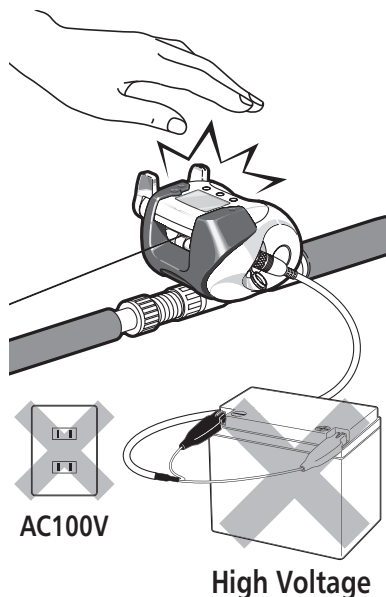

## Warning



### Warning

- If the circuit breaker in the reel is tripped repeatedly, it is possible that the specifications of the reel are not appropriate for the load from that particular species of fish or rig.  
If you continue to use the reel in such a situation, the motor or display may overheat and be damaged. Should that occur, please change to a higher specification reel.



### Warning

- If the battery mark ( **B** or **[ ]** ) lights up and starts flashing, this means that battery voltage is dropping, which will lead to a decrease in performance. It also means that excessive load is being placed on the motor and display, which may cause the reel to malfunction. Stop using the reel immediately and connect to a fully charged battery.



### Warning

- Please do NOT use the reel with a vessel's power supply or a battery that does not provide the proper voltage.  
When the battery mark ( **B** or **[ ]** ) lights up and starts flashing, winding in under heavy load (high current) may damage the electronic components in the display and cause the lens to pop out.

## Warning



### Don't get your finger caught!

- Do NOT put your finger near the level winding position when fishing as it may get caught and cause injury. If your finger does become caught, turn off the power switch on the reel immediately and disassemble the reel.
- Do NOT put your finger in between the handle and the body as it may get caught and cause injury.

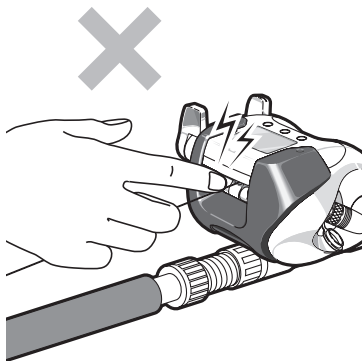

- A very weak electrical signal is produced when using the reel. This may cause medical equipment such as hearing aids and pacemakers to malfunction, causing the user to have palpitations or become dizzy.



### Warning

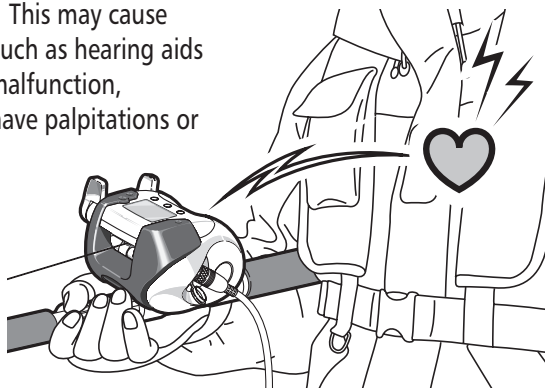

## Warning



### Warning

- Immediately remove the power cable if you see moisture or water droplets on the inside of the display. If you continue to use the reel in such a situation it may malfunction, break the tip of the rod and cause injury.
- Stop using the reel if you see a crack develop in the display or the case. If water penetrates into the case it can cause shorting to occur, which can damage the electronics and make it impossible to control the motor.

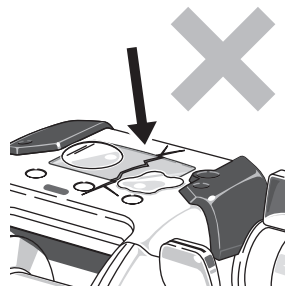

### Warning

- Stop using the reel IMMEDIATELY if a small fire or smoke is emitted from the reel or display, or if the reel becomes abnormally hot. If you continue to use the reel in this situation then the reel may catch fire.
- Disconnect the power connector or the alligator clips from the battery immediately if the motor cannot be stopped.

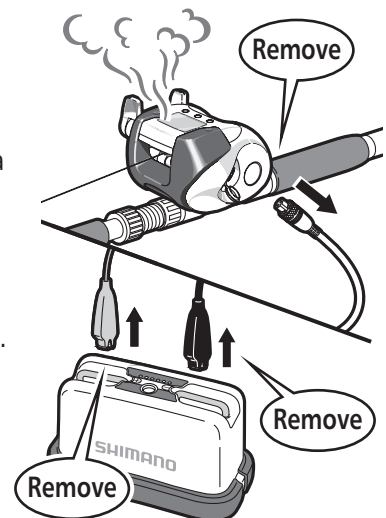



## Caution



### Caution

- If the surface of the coating on the reel comes off or if the surface of the material comes off due to a strong impact leaving a sharp edge, do NOT touch that area as it may cause injury.



### Do not get your fingers caught!

- Do NOT touch the line when it is being fed out or wound in as the line can cut or even cut off your finger.

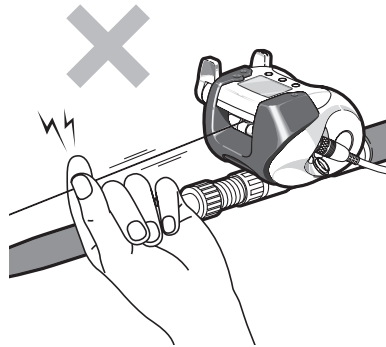

### Caution: Rotating Objects

- Do NOT touch the rotating spool as this can cause injury.

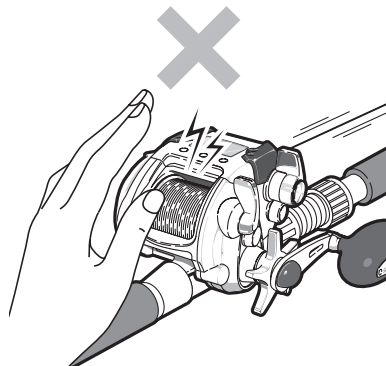

## Caution



### Caution: Rotating Objects

- Do NOT put your finger near rotating parts such as the spool as this can cut or even cut off your finger.

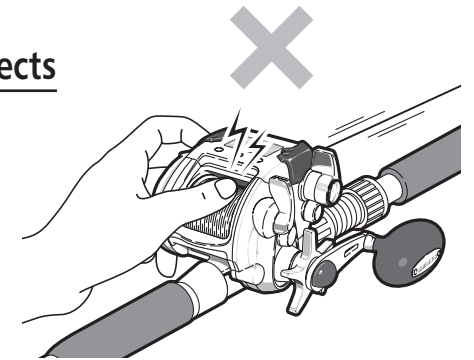

### Caution

- Please secure the reel securely to the rod. Do NOT use the reel if it is cross-threaded or not properly secured as it may come off during fishing and cause injury.

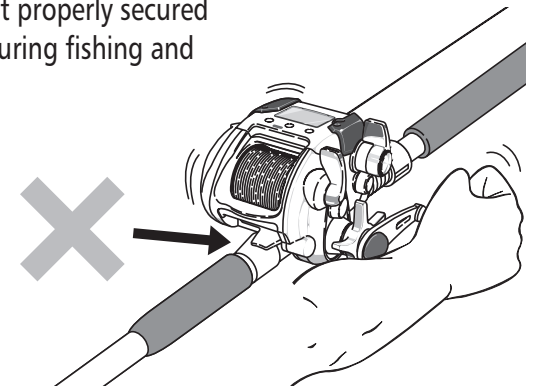



## Caution



### Caution

- Please store and use the reel out of the reach of children.

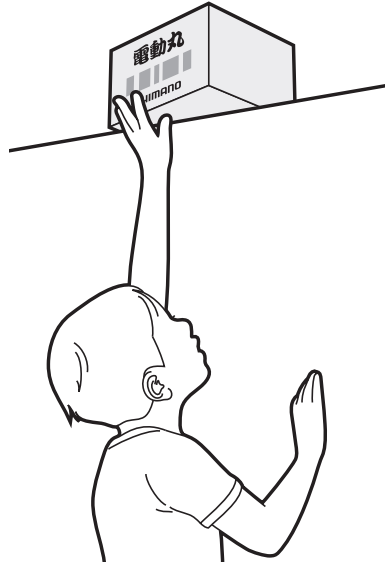

### Caution

- The reel may malfunction if it is dropped and the display damaged due to the impact. Please take care to avoid any such impacts.

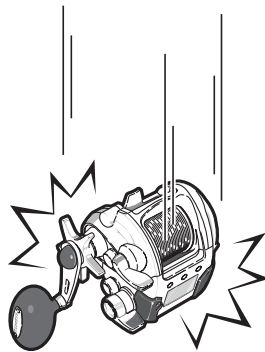

## Caution



### Caution

- Do NOT wrap the cable around your body as depending on how the fish is pulled in it may cause you to be thrown into the sea.

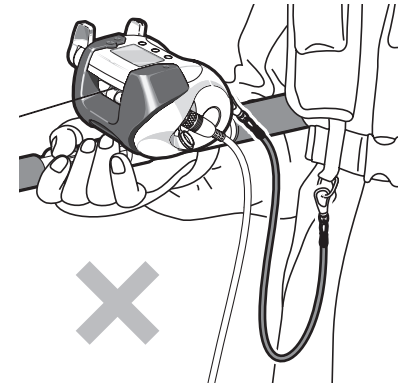

### Caution

- ALWAYS remove the cable from the battery when carrying out maintenance on the reel when it is in use as the spool may move at any time causing injury to the user or damage to the reel.

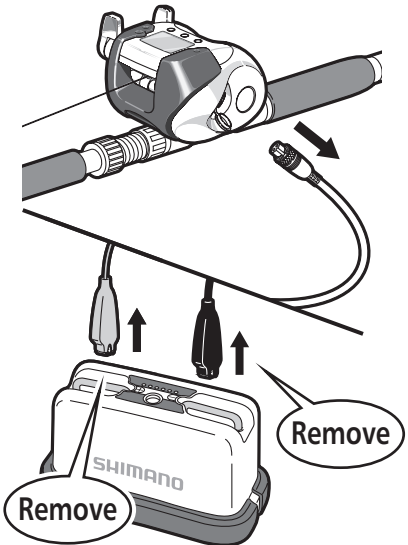



## Caution



### Caution

- Always decrease drag before connecting the power supply. There is the possibility that the rod may be damaged if the motor malfunctions, cannot be stopped and retrieves the rig.

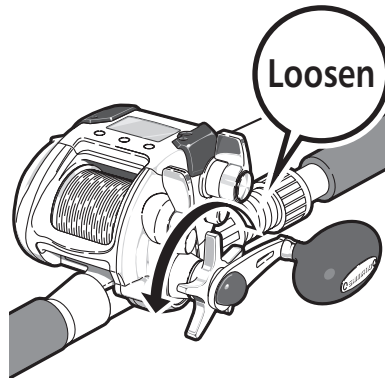

### Do NOT Disassemble

- Please do not modify the reel as this can cause performance to deteriorate and safety features to malfunction.
- Please do not modify the cable as this may cause performance to deteriorate, generate heat or result in a fire.

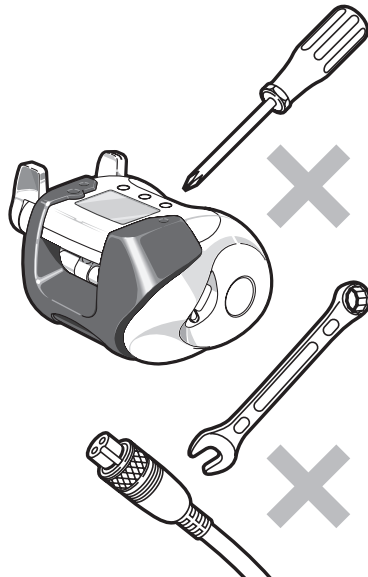

## Caution



### Caution

- The gunwale stop position may change according to factors such as retrieval tension. If the gunwale stop position changes, please reset the counter to zero again. This is just in case the gunwale stop position changes, which can break the tip of the rod.

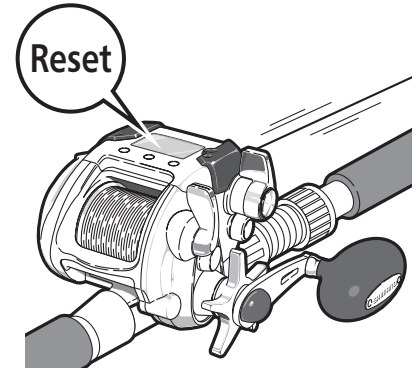

### Caution

- Please do NOT touch the metal parts of the alligator clips or the terminals of the battery or power supply with wet hands as there is the danger of electric shock.





## Caution



### Caution

- Check that the terminals are not wet before attaching the power cord to the reel. If the terminals are wet this can cause a short circuit, which may result in fire or smoke that can lead to injury.

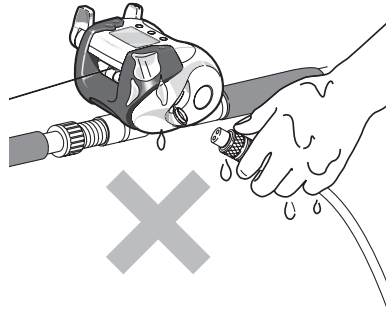

### Caution

- If your rig is caught on the bottom, wind the line around a rod holder or the gunwale and cut it rather than trying to jerk it free.



### Caution

- Do NOT try to dry the reel using a hair dryer or some other heating appliance after carrying out maintenance as this may deform the resin.

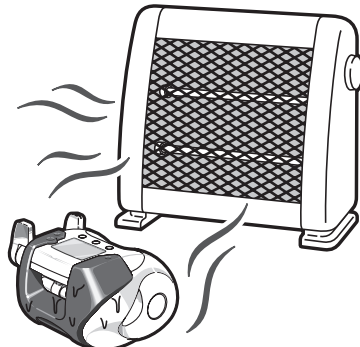

## Caution

### Caution: Motor Malfunction

- The display is water-resistant to a depth of 10m. However, if the reel is dropped or receives an impact of some kind and the display is damaged or cracked, the motor may malfunction if water is able to penetrate into the reel. As injury may occur if the motor malfunctions and suddenly retrieves the line, etc., if the display is cracked or damaged, immediately remove the power cord, stop using the reel and return it to the place of purchase. If there is no licensed Shimano dealer nearby, please enquire as to the location of your nearest service center.
- This reel operates on DC12~24V. Using a higher voltage or a household power supply may damage the electronic circuits in the display and make it impossible to control the motor. As this could also result in smoke or fire, always check the specification of the power supply before use.

# Features



**S A-RB**

Rust and Corrosion-Resistant Bearings

## Shielded Antirust Bearings Page 35

A special corrosion-resistant material is applied to the surface of conventional antirust bearings to minimize saltwater penetration and these bearings are located at strategic locations to achieve even smoother performance. Not only are these bearings resistant to rust, but they also minimize the formation of salt crystals inside the bearings, which can lead to corrosion.



Select between two modes when reeling in your fish.

## You can select between Rakuraku Mode and Fixed Speed Mode Pages 43~44

Select between Rakuraku Mode, which maintains a specific line tension, and Fixed Speed Mode, which maintains a fixed spool rotation speed, according to your situation.



## Lightweight, compact design that is among the best in its class.



## Switch between high speed and high power.



Consistently position your rig more accurately at the desired depth.

## Zero reset. Pages 32~33

The counter can be reset to zero with the rig touching the surface of the water. This allows you to more accurately position the rig at the desired depth.



## Stops retrieving the line at the point where you can raise the rod vertical and have the rig come straight to your hand. Pages 36~37

The gunwale stop position is set automatically, allowing you to raise the rod vertical and have the rig come straight to your hand.



## Displays the time remaining for the rig to be retrieved. Page 51

Displays the time remaining for the rig to be retrieved to the gunwale using the motor.



## Allows you to easily return your rig to the same depth after repairing your line if it breaks. Page 34

If you break your line, after repairing it, lower the rig to the surface and press 0 Set. The Smart Line Depth function then automatically returns your rig to the same depth it was at before it broke.



## The Technical Lever

is used to adjust retrieval speed and Rakuraku settings.  Pages 11, 43~44



## The new SLSII system requires no programming. **SLSII (Shimano Line Program System 2)**

 Pages 16~27





Correct any discrepancy between the display and the length of line used.

## Line Learning Adjustment

Pages 52~53



**An alarm sounds at a predetermined depth.**

Pages 38~39

Set the shelf or bottom depth and next time you let down your rig an alarm will sound when that depth is reached.



Select between

## Surface-Down and Bottom-Up Modes

for the display. Pages 40~42

Depth can be shown as distance from the surface or distance from the bottom to best suit factors such as fishing ground, fishing technique and target species.



Let down your line faster with  
**the Auto Casting function.**

Page 31



The reel replicates the jigging technique.

## Jigging Mode Pages 45~46

Jigging mode is a new function that enables the reel to replicate the popular jigging technique.

\* In some cases 0 Set cannot be changed in Jigging Mode. Please turn Jigging Mode OFF before pressing the 0 Set | Enter Button.



**Allows you to teach the reel your own original jigging technique, which you can then use when fishing.** Pages 47~50

\* In some cases 0 Set cannot be changed in Jigging Mode. Please turn Jigging Mode OFF before pressing the 0 Set | Enter Button.

**The following icons appear in the manual and have the following meanings:**

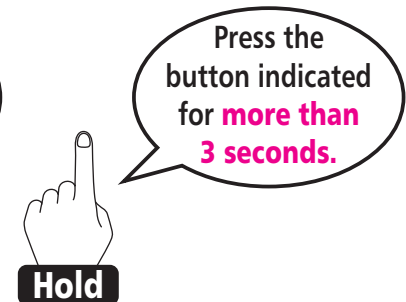

**Caution:**

The values and settings shown on the reel display in this manual are in some cases just examples. Actual values may differ.

# Digital Display Component Names

## Bottom-Up Mode (Icon: 底)

In Bottom-Up Mode ▶ will be displayed to the left of the Bottom-Up icon. If ▶ is not displayed then the reel is in Top-Down Mode.

## Present Depth

Displays depth from the surface of the water.

(In Bottom-Up mode it displays the distance from the bottom.)

\* Depth is shown in 10cm graduations.

Depths over 100m are shown in 1m graduations as shown on the right.

99.9 → 100

## Time

## Jigging Mode (Icon: さそい)

▶ is displayed to the left of the Jigging icon in Jigging Mode.

## Saved Depth

## Technical Lever Settings

Displays Rakuraku mode and Fixed Speed Mode values.

## Menu | Rakuraku/Fixed Speed Button



**Hold**

Press for more than 3 seconds to enter Menu Mode.

Once in Menu Mode, press Menu again to toggle through the menu items.

The icon for the appropriate item (time (hours)(minutes), 底 bottom-up, 糸送 casting, さそい jigging (L1)(L2), 回収 retrieval) will flash.

Press Menu again to return to Standard Mode.

Used together with the Enter button.



**Press**

Press to switch between Rakuraku Mode and Fixed Speed Mode. You can press this button even when reeling in. The mode selected will be shown on the display.

**Rakuraku Mode:** Green Backlight

**Fixed Speed Mode:** Orange Backlight (速 is displayed)

## 0 Set/Enter Button



**Press**

Press Enter to turn ON or OFF the function selected using the Menu button.



**Hold**

## Zeroing the Counter

Lower the rig to the surface of the water and zero the counter.

\* It may not be possible to zero the counter if Jigging Mode is ON. Always turn Jigging Mode OFF before zeroing the counter.

## Auto Casting Function

When lowering the rig, the motor will start automatically 5m past the gunwale stop position and spool resistance will be reduced to a minimum. The ▶ to the left of 糸送 will not be displayed when this function is OFF. (E.g. If the gunwale stop position is set at 1m then the motor will start at 6m.)

## Rig Retrieval Time

When the Rig Retrieval Time function is ON (▶ is displayed to the left of 回収), the time required to retrieve the rig will be displayed on the **Saved Depth** display.

## Memo Button



**Press**

Saves the present depth from the surface. In Bottom-Up mode, the counter shows the depth from the bottom as the **Present Depth**, starting from 0.0m.

## Mode Indication

学習 Normal | 下巻 Backing :

These icons are displayed in Learning Mode.

棚 : Displayed in Surface-Down Mode.

底 : Displayed in Bottom-Up Mode.

オート : Displayed when the Auto Depth Function is ON.

速 : Displayed in Fixed Speed Mode.

When nothing is displayed the reel is in Rakuraku Mode.



Battery and power supply voltage is indicated as shown below.



: Adequate Charge



: Slightly Flat



: Insufficient Charge (Flashes)

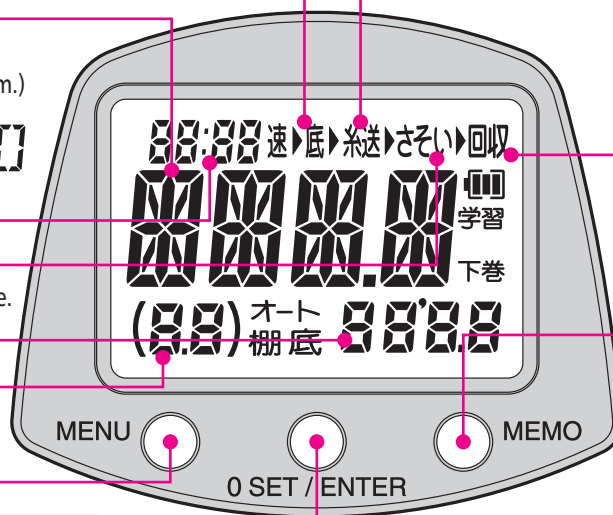

# Part Names

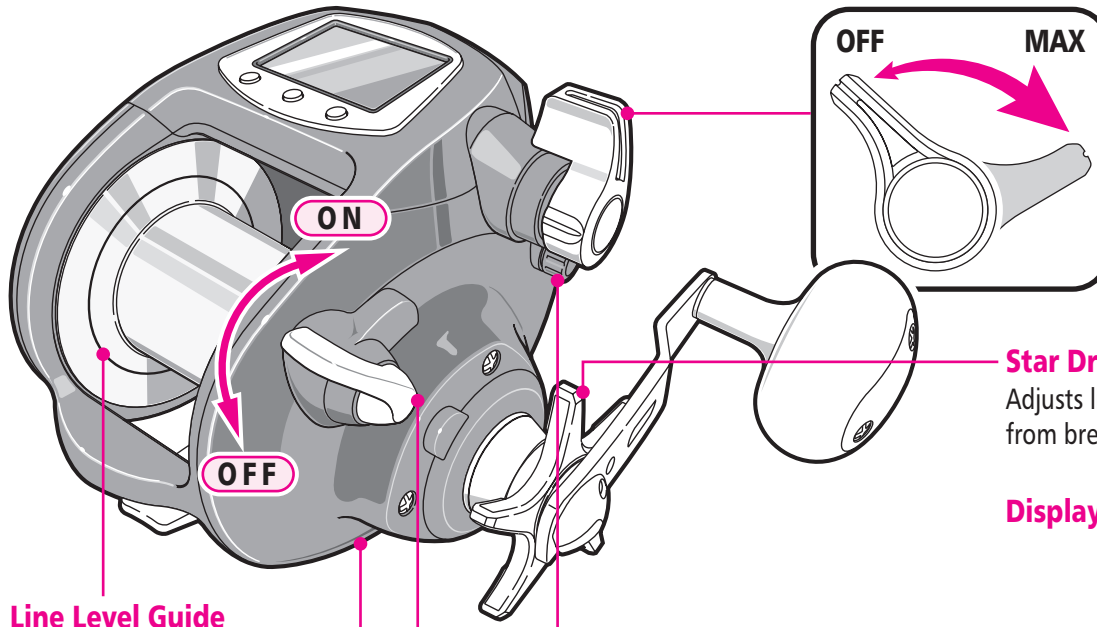

## Line Level Guide

Shows the 50% level on the spool for winding on line.

## Line Holder

Holds the line in place.

## Mechanical Brake Knob

Brakes spool rotation and prevents backlash when lowering the rig.

## Clutch Lever

ON when the handle is turned clockwise or turned by hand.

**ON** : Retrieves the rig.

**OFF** : Frees the spool and allows the rig to drop.

## DDL (Direct Drive Level Winder)

\* Be careful not to get your finger caught.

## Power Cord Socket

\* Always replace the connector cap when not using the reel.

## Technical Lever

Allows you to instantly adjust retrieval speed and Rakuraku Mode tension settings. After gunwale stop, if you want to restart the motor, then turn the lever to the OFF position once before restarting. In the interests of safety, however, this does not work if the counter displays 1.0m or less even if the lever is moved to the ON position.



## Star Drag

Adjusts line delivery tension to prevent the line from breaking when a fish is pulling hard.

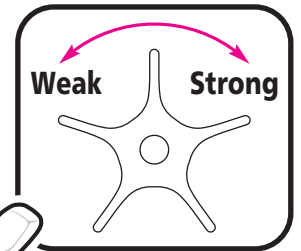

## Display

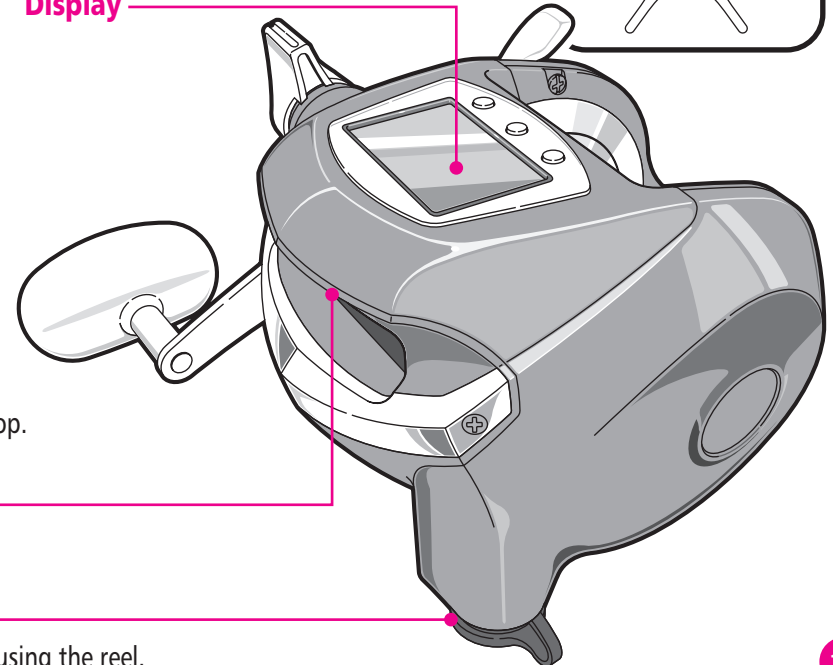

# Menu Button Operation

The Menu Button is used to set the following functions:

- Time (Hours) (Minutes)
- Bottom-Up Mode ON/OFF
- Auto Casting Function ON/OFF
- Jigging Mode ON/OFF
- Rig Retrieval Time ON/OFF

- Press Menu for more than 3 seconds in Standard Mode to enter Menu Mode. Once in Menu Mode, press Menu repeatedly (for less than 3 seconds) to toggle through the menu items. The icon for the appropriate item (time (hours)(minutes), 底 bottom-up, 糸送 casting, さそい jigging (L1)(L2), 回収 retrieval) will be displayed. Press Menu again to return to Normal Mode.
- When the desired icon is flashing, press Enter to turn that function ON or OFF. The display will then return to Standard Mode. When setting the time, firstly press Memo to adjust the hour and then Enter to set it and then press Memo to adjust the minutes followed by Enter to set it and return to Standard Mode. (When the time is flashing on the display, press Memo once to go forward one minute or hold it down for more than 3 seconds to forward more quickly.)
- When you have changed setting in Standard Mode (Startup Screen), even if you turn the power OFF the new settings will be saved.

Icons with a flashing ► on the left are ON.

The state of the functions in the example are as follows:

- Bottom-Up Mode (底) ..... OFF
- Auto Casting Function (糸送) OFF
- Jigging Mode (さそい) ..... OFF
- Rig Retrieval Time (回収) ..... OFF

## Standard Mode

This is the mode used when actually fishing. When you turn the reel ON you will be in this mode. \* Startup Screen

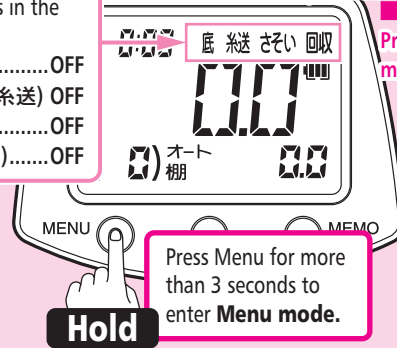

Press Menu for more than 3 seconds to enter **Menu mode**.

Press Menu to return to Standard Mode

## Menu 7: Rig Retrieval Time



Rig Retrieval Time will flash.

Press Menu to go to the next Menu without making any changes.

Press

Press 0 Set | Enter to turn the function ON or OFF.

Press

The example here shows how to turn Rig Retrieval Time ON. Repeat the same procedure to turn it OFF.



This will confirm the change and return you to **Standard Mode**.

## Menu 1: Time (Hours)



2 digits for the hours will flash.

Press Menu to go to the next Menu.

Press Menu for more than 3 seconds.

Press Menu to go to the next Menu without making any changes.

Press

Press to go forward one hour.

Press Memo to change the time.

Press Memo to scroll through the hours.

Set the correct time (24-hour display).

Hold to go forward more quickly.



Press Menu to set the hour and move on to set the minutes.

Press

Press 0 Set | Enter to set the time.

The time will be displayed normally again.

\* The time shown here is an example only.

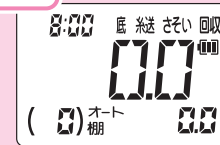

This will set the time and return you to **Standard Mode**.

Press Menu to go to the next Menu.

## Menu 2: Time (Minutes)

2 digits for the minutes will flash.

Press Menu to go to the next Menu.

Press Menu to go to the next Menu without making any changes.

Press Memo to change the time.

Press 0 SET / ENTER

Press to go forward one minute.

Hold to go forward more quickly.

Press Memo to scroll through the minutes. Set the correct time.

Press Menu to set the minutes and move to the next Menu.

Press 0 SET / ENTER to set the time.

This will set the time and return you to Standard Mode.

The time will be displayed normally again.

\* The time shown here is an example only.

## Menu 3: Bottom-Up Mode

Bottom-Up will flash.

Press Menu to go to the next Menu.

Press Menu to go to the next Menu without making any changes.

Press 0 Set | Enter to turn the function ON or OFF.

This will confirm the change and return you to Standard Mode.

The example here shows how to turn Bottom-Up Mode ON. Repeat the same procedure to turn it OFF.

## Menu 6: Jigging Mode L2

Jigging will flash.

L2 is displayed

Press Menu to go to the next Menu.

Press 0 Set | Enter to turn the function ON or OFF.

Press Menu to go to the next Menu without making any changes.

Press 0 SET / ENTER

Hold

You can input your own original jigging technique in L2. Press 0 Set | Enter for more than 3 seconds to start Jigging Learning. (Please see Pages 47~50 for more details.)

## Menu 4: Auto Casting Function

Auto Casting will flash.

Press Menu to go to the next Menu.

Press Menu to go to the next Menu without making any changes.

Press 0 Set | Enter to turn the function ON or OFF.

This will confirm the change and return you to Standard Mode.

The example here shows how to turn the Auto Casting Function ON. Repeat the same procedure to turn it OFF.

## Menu 5: Jigging Mode L1

Jigging will flash.

L1 is displayed

Press Menu to go to the next Menu.

Press 0 Set | Enter to turn the function ON or OFF.

Press Menu to go to the next Menu without making any changes.

Press 0 SET / ENTER

This will confirm the change and return you to Standard Mode.

The example here shows how to turn Jigging Mode ON. Repeat the same procedure to turn it OFF.

Press Menu to go to the next Menu.

## 1 Handling Precautions

### Power Supply

This reel can use 12~24V DC power supply with a nominal voltage of 12~24V (lithium-ion batteries, etc.). Do NOT use the reel with any kind of unspecified power supply (e.g. a vessel's on-board power supply or a AC100 household power supply). NEVER use a battery charger.

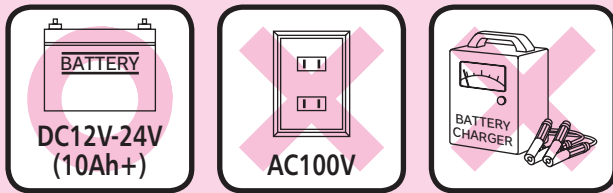

- When using a vessel's on-board power supply, always check that the voltage is DC12V~24V. If the battery terminals are corroded, the voltage may not be stable, which can cause the reel to malfunction.
- Only use a fully charged battery.
- If a battery is used for a long period of time it loses charging capacity. If that occurs get a new battery.
- NEVER use an AC power supply as it will destroy the reel's electronics.
- It may not be possible to properly attach the alligator clips to the terminals of other batteries from other manufacturers and in some cases using batteries from other manufacturers may cause damage to such batteries.
- If you use a vessel's on-board power supply there is the possibility that other powered reels may stop working.
- The recommended battery is an automobile battery with a capacity of 10Ah.

### Power Cord

Always use a genuine Shimano power cord to connect your reel to the power supply.

The power cord is a consumable. Depending on frequency of use, it may need to be changed every 2~3 years.

#### Caution

Using a power cord other than a genuine Shimano item may cause the reel to malfunction. Please do not treat the power cord in a rough manner, stand on it or fold or bend it as this can cause it to break.

This is an extremely high-powered reel.

Although power cords for powered reels from other manufacturers can be connected, please ensure that you use only a genuine Shimano power cord as electrical resistance inside the cable is especially low.

## 2 Connecting a Battery

- 1 Please use the supplied power cord to connect to the battery.

Firstly connect the red connector to the positive electrode and the black connector to the negative electrode.

- 2 Next connect the power cord to the reel.

Line up the connections and insert the power cord into the socket in the bottom of the reel, pushing it firmly in and then tightening the lock screw.

\* Please do NOT push any buttons while connecting the power cord.

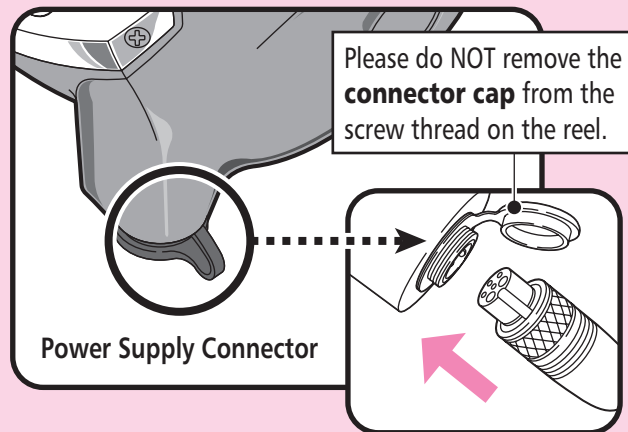

## Spooling Up the Line

- 1** Feed the line through the level winder.  
When threading the line, use the threading pin provided.

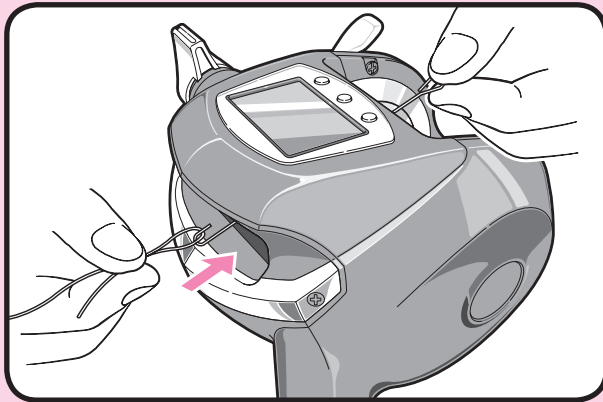

- 2** Tie the line to the spool pin.

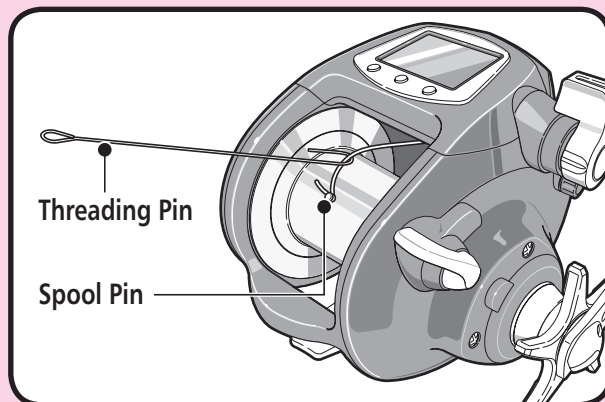

## Selecting Learning Methods

Firstly, change from standard mode to learning mode as shown below. Be sure to select the learning method that best matches the type of line you will be using.

Please refer to the following page for details regarding each learning method.

- \* This operation cannot be carried out unless a power supply is connected.
- \* Carry out this operation when the display shows less than 6m. Please reset the counter if the value displayed is greater than 6.1m.

### Caution

In some cases the display may go blank if learning is carried out at  insufficient voltage.

If this happens, replace the battery and carry out learning again from the beginning.



## Standard Mode

Used when actually fishing.  
The reel is in this mode when initially turned ON

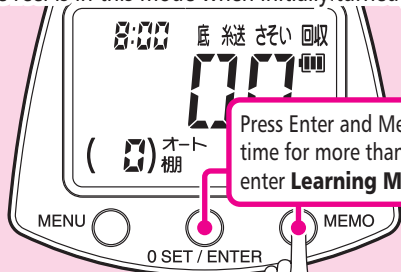

Press Enter and Memo at the same time for more than 3 seconds to enter **Learning Mode**.

**Hold**

Press Menu to return to Standard Mode

## Learning Mode (Wind Down Learning)

Used when winding backing line.

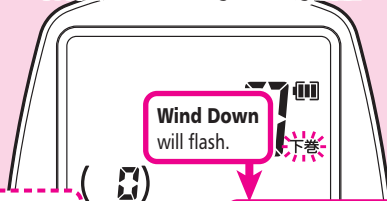

Wind Down will flash.

Press Enter to turn ON **Wind Down Learning**. The icon will be displayed.

**Press** **Press**

When not selecting Wind Down Learning, press Menu to go to the next menu.

## Learning Mode (Normal Learning)



Normal will flash.

Press Enter to turn ON **Normal Learning**. The icon will be displayed.

**Press** **Press**

When not selecting Normal Learning, press Menu to go to the next menu.

Press Menu once to go to the next menu.

# Learning Methods (Flow Diagram)



Before winding line, please look through the following flowchart to gain an understanding of the overall process. There are 3 Learning Modes. Please see the following pages for more details.

\*This operation cannot be carried out unless a power supply is connected.

When NOT using a backing line.

## 1 PE Line (See Pages 20~21.)

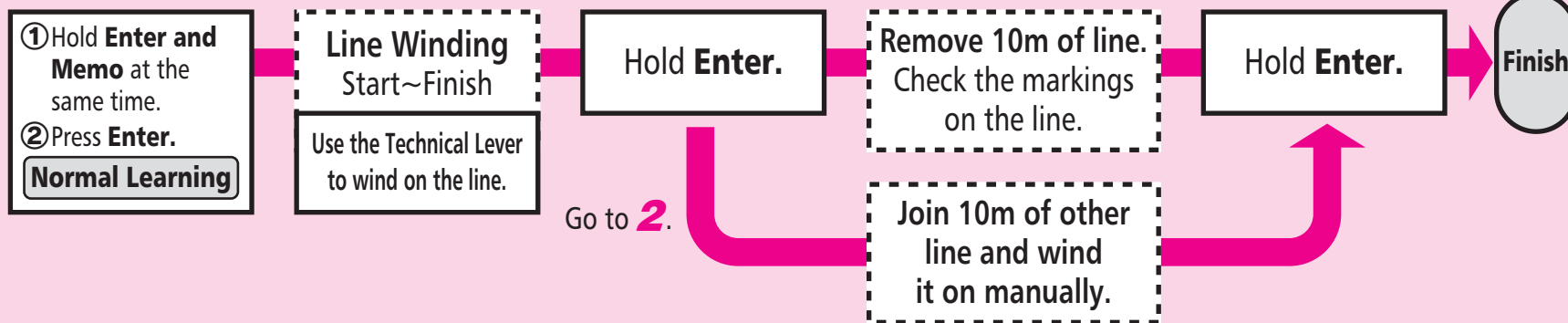

## 2 Line with No Markings (See Pages 22~23.)

## When using backing line.

- 3** There is a mark on the spool showing 50% capacity for backing line.  
Use this as an estimate when winding on backing line. (See Pages 24~27)

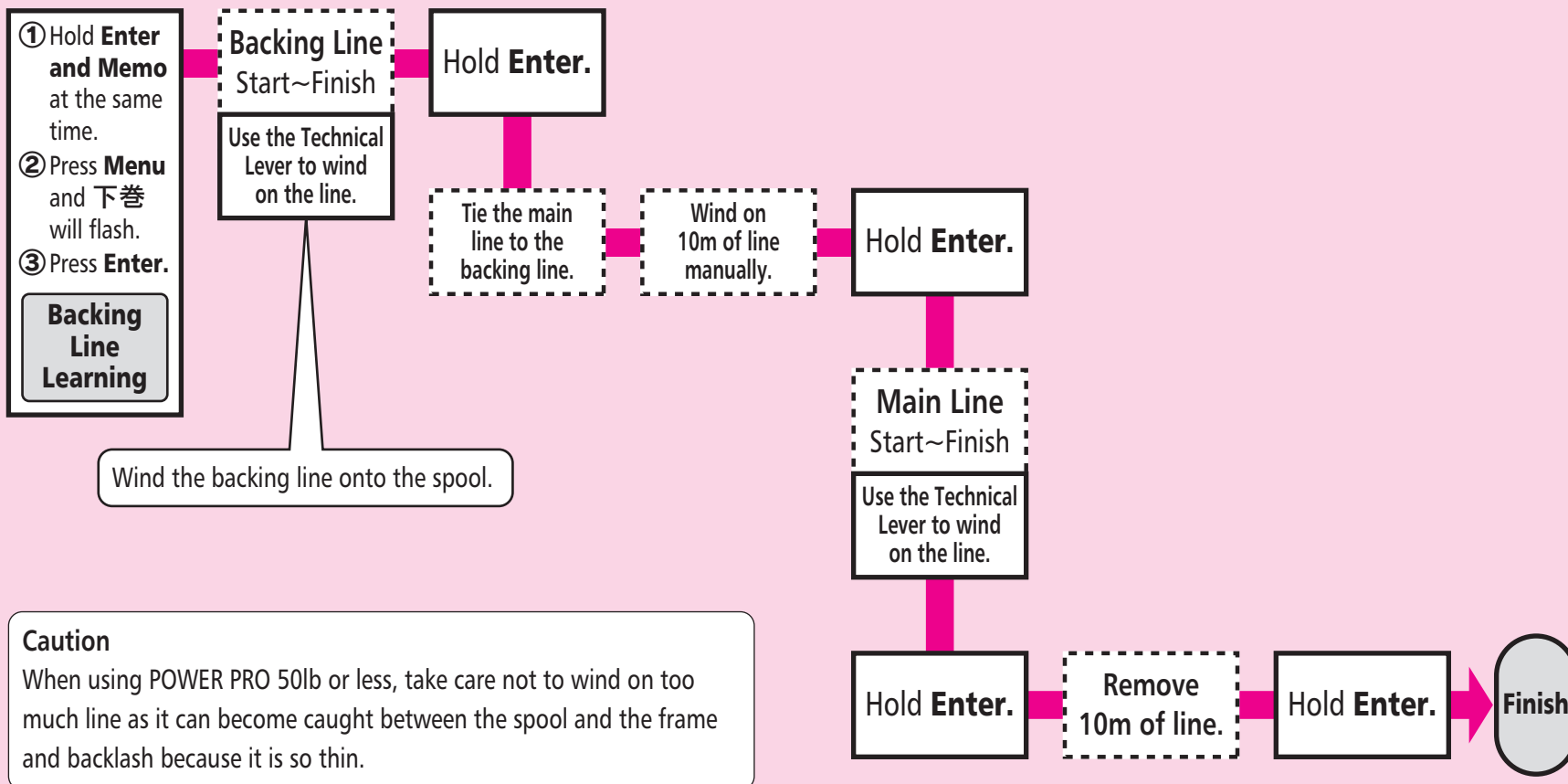

### Caution

When using POWER PRO 50lb or less, take care not to wind on too much line as it can become caught between the spool and the frame and backlash because it is so thin.

# Learning Methods (Inputting the actual value of the line use into the reel.)



## 1 PE Line (Line with markings every meter.) → Use Normal Learning. (学習)

Please see Pages 22~23 when winding lines such as nylon (line with no markings every meter).

Learning can also be carried out using backing line. **Learning Mode (Backing Line Learning)** See Pages 24~27.

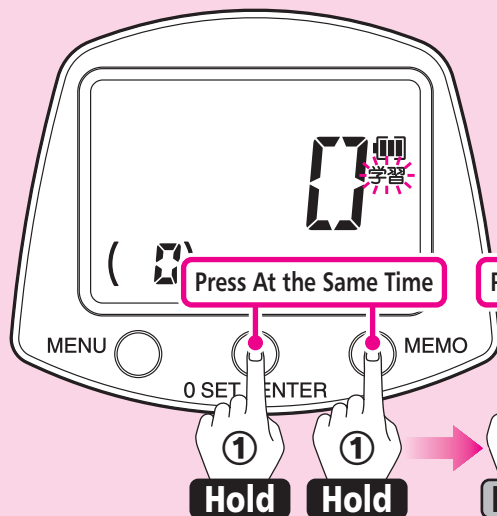
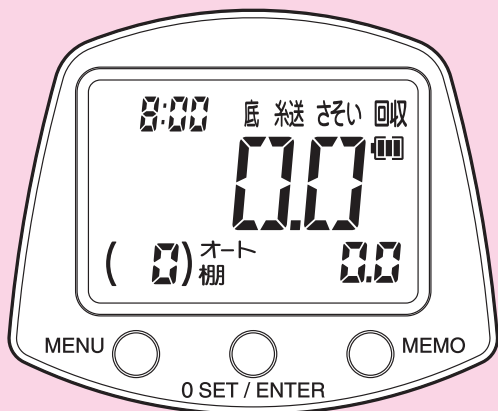

Press Enter

Use the Technical Lever to wind on the line.

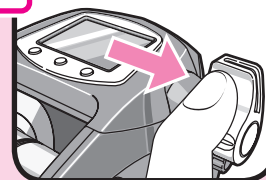

The number of spool revolutions is displayed.

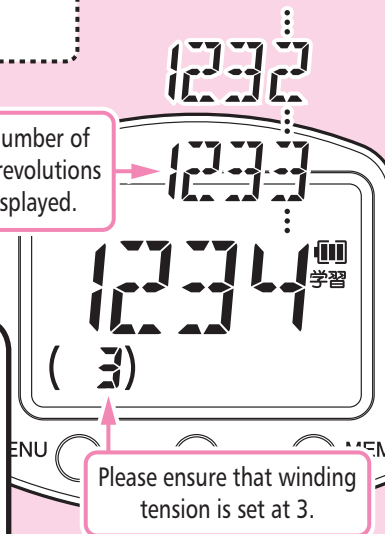

Please ensure that winding tension is set at 3.

- 1 Do this when the display shows less than 6m. Reset the counter if the display shows more than 6.1m (see Pages 32~33).

**Engage the clutch. Check the power supply.**

The display should be as shown in the diagram. (This is Standard Mode.)

- 2 Press Enter and Memo at the same time for more than 3 seconds to enter Learning Mode.

Learning 学習 (Normal Learning) will flash.

**Press Enter to select Normal Learning.**

学習 (Learning) will be displayed.

(Please see Pages 16~17 Selecting Learning Methods for details regarding how to select learning methods in Learning Mode.)

- 3 Use the Technical Lever to wind on line.

The number of spool revolutions will be displayed.

**Please ensure that winding tension is set at 3 in the brackets.**

This value refers to line tension when winding in line. The value shown is NOT in kg and is different again from the values displayed in Rakuraku Mode.

**Winding speed can be adjusted using the Technical Lever. To stop winding in, move the Technical Lever to the OFF position.**

**Caution:** The values and settings shown on the reel display in this manual are in some cases just examples. Actual values may differ.

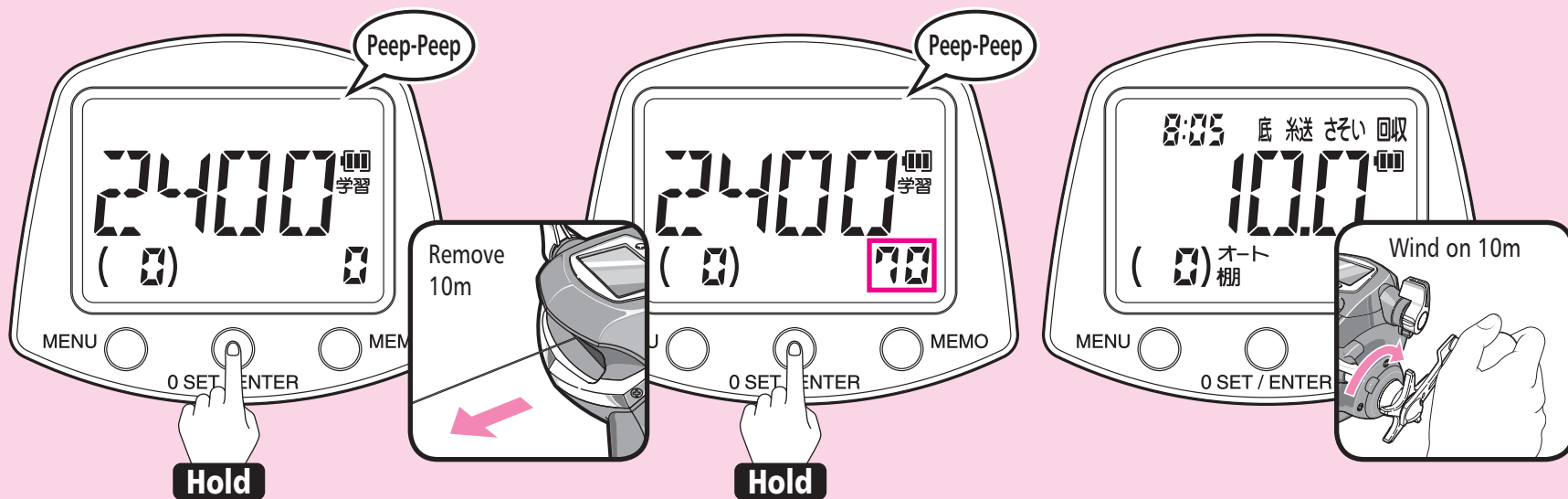

- 4** After completely finishing winding line, press Enter for more than 3 seconds. The alarm will sound (peep-peep) and the display will appear as shown in the diagram. Accurately remove 10m of line. (Check this according to the changes in line color that occur every 10m or according to the number of marks on the line that appear every meter.)

- 5** The number of spool revolutions will be displayed in the bottom right of the display (the area shown inside the square). Press Enter for more than 3 seconds to exit Learning Mode. The alarm will sound (peep-peep).  
\* If you accidentally press Menu while winding on line data will be lost and you will have to repeat the process once more from the beginning.

- 6** The display will return to Standard Mode and learning will be complete. (In some cases there may be as much as a  $\pm 3\%$  difference between the value shown on the display and the actual length of the line.)  
\* After this when actually fishing, if you think that the difference is too great, carry out Line Learning Adjustment as shown on Pages 52~53. This will enable you to position your rig more accurately.

- 7** Wind up the 10m of line that was removed.



## 2 Nylon Line (Line with no markers.) → Use Normal Learning. (学習)

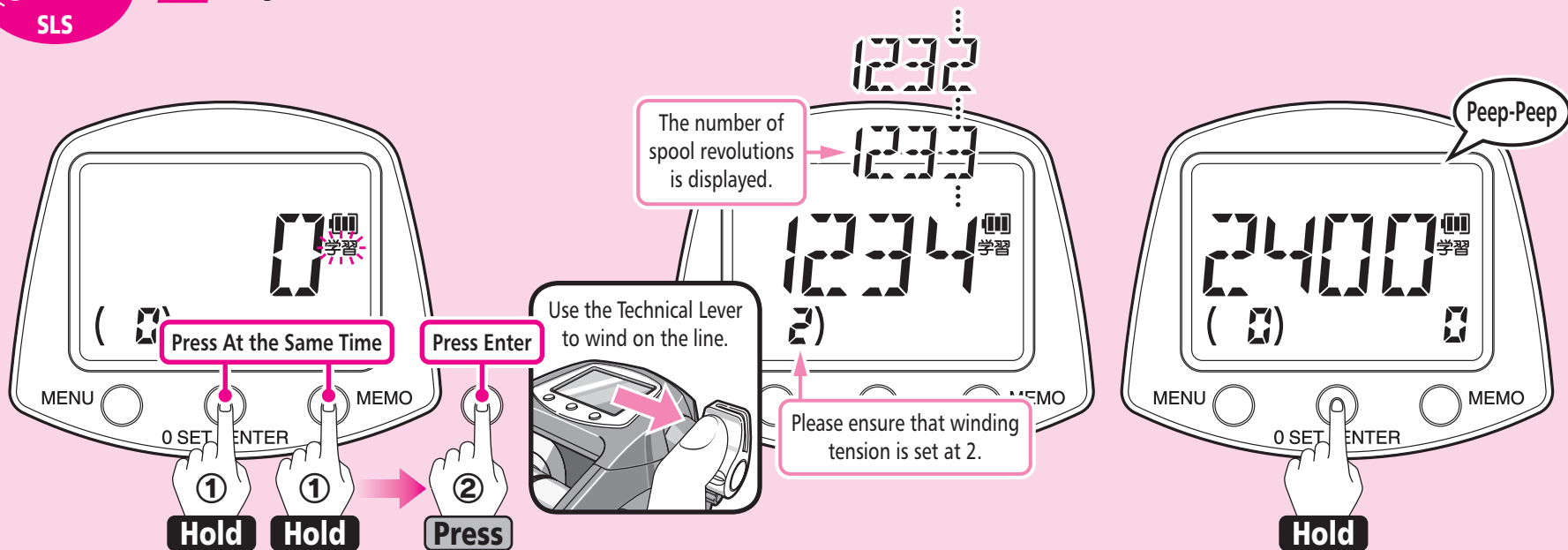

- 1** Do this when the display shows less than 6m. Reset the counter if the display shows more than 6.1m (see Pages 32~33).  
**Engage the clutch. Check the power supply. Press Enter and Memo at the same time for more than 3 seconds to enter Learning Mode.**  
Learning 学習 (Normal Learning) will flash.  
**Press Enter to select Normal Learning.**  
学習 Learning will be displayed.  
(Please see Pages 16~17 Selecting Learning Methods for details regarding how to select learning methods in Learning Mode.)

- 2** Use the Technical Lever to wind on line.  
The number of spool revolutions will be displayed.  
**Please ensure that winding tension is set at 2 in the brackets.**  
This value refers to line tension when winding in line. The value shown is NOT in kg and is different again from the values displayed in Rakuraku Mode.  
**Winding speed can be adjusted using the Technical Lever. To stop winding in, move the Technical Lever to the OFF position.**

- 3** After completely finishing winding line, **press Enter for more than 3 seconds.**  
The alarm will sound (peep-peep) and the display will appear as shown in the diagram.

**Caution:** The values and settings shown on the reel display in this manual are in some cases just examples. Actual values may differ.

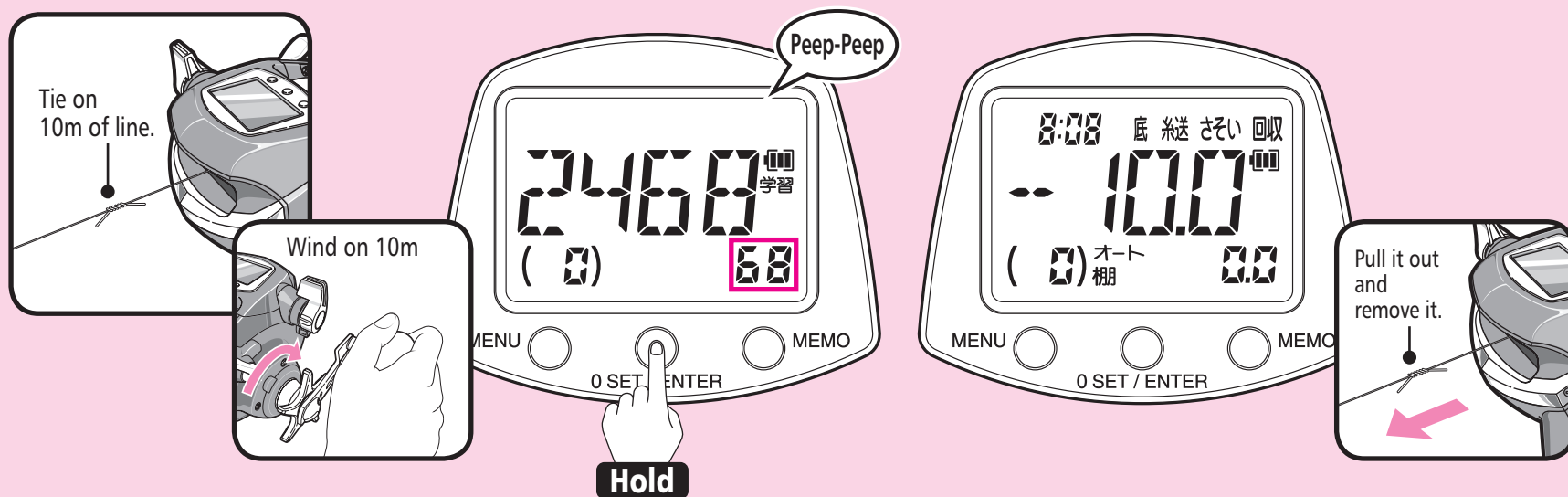

**4** Tie 10m of different line to the end of the line you wound on.

**5** Wind on the joined line manually.

The number of spool revolutions will be displayed in the bottom right of the display (the area shown inside the square).

**Press Enter for more than 3 seconds to exit Learning Mode.**

The alarm will sound (peep-peep).

\* If you accidentally press Menu while winding on line data will be lost and you will have to repeat the process from the beginning.

**6** The display will return to Standard Mode and learning will be complete.

(In some cases there may be as much as a  $\pm 3\%$  difference between the value shown on the display and the actual length of the line.)

\* The difference is the difference on the first attempt after learning has been completed.

**7** Pull out the joined line and remove it.

**Caution**

In some cases a difference of more than 3% occurs with nylon line because the tension changes with repeated winding in. Please take care to watch for tangles at the tip of the rod when using it.



## 3 Backing Line → Use Backing Line Learning. (下巻)

**Backing Line:** There is a mark on the spool showing 50% capacity for backing line. Use this as an estimate when winding on backing line.

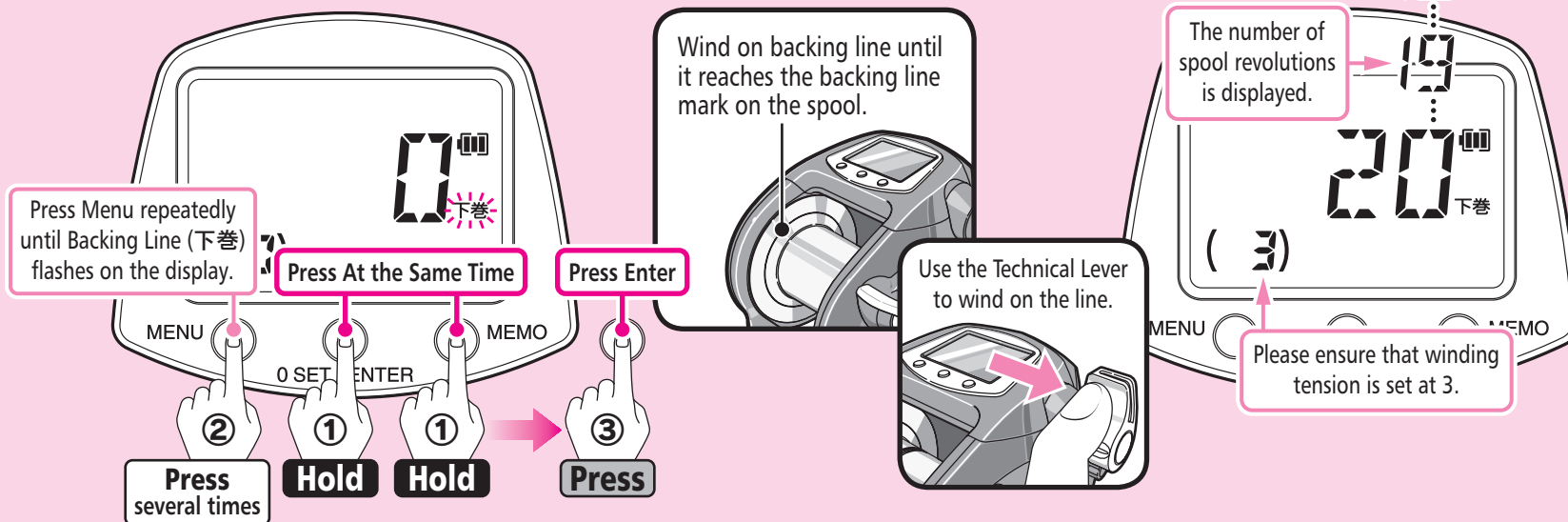

- 1 Do this when the display shows less than 6m. Reset the counter if the display shows more than 6.1m (see Pages 32~33). Press Enter and Memo at the same time for more than 3 seconds to enter Learning Mode and then press Menu repeated until Backing Line Learning (下巻) flashes on the display. Press Enter to select as shown in the diagram above and Backing Line Learning (下巻) will be displayed.

(Please see Pages 16~17 Selecting Learning Methods for details regarding how to select learning methods in Learning Mode.)

- 2 Wind on line using the backing line mark as an estimate. Use the Technical Lever to wind on the line. Please ensure that winding tension is set at 3 in the brackets. Winding speed can be adjusted using the Technical Lever. To stop winding in, move the Technical Lever to the OFF position.



**Caution:** The values and settings shown on the reel display in this manual are in some cases just examples. Actual values may differ.

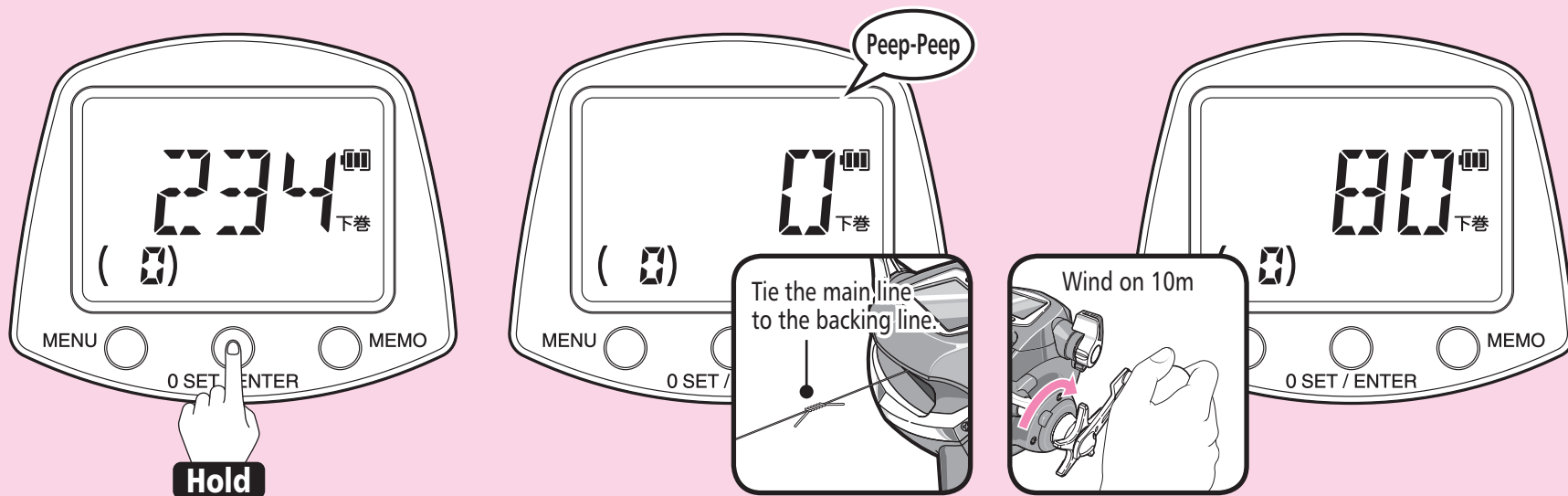

**3** When backing line learning has finished, press Enter for more than 3 seconds.

**4** The alarm will sound (peep-peep) and the display will appear as shown in the diagram. Tie the main line to the backing line.

**5** Accurately wind on 10m of main line. The number of spool revolutions will be shown on the display.

(Continued on the next page.)

**Caution:** The values and settings shown on the reel display in this manual are in some cases just examples. Actual values may differ.

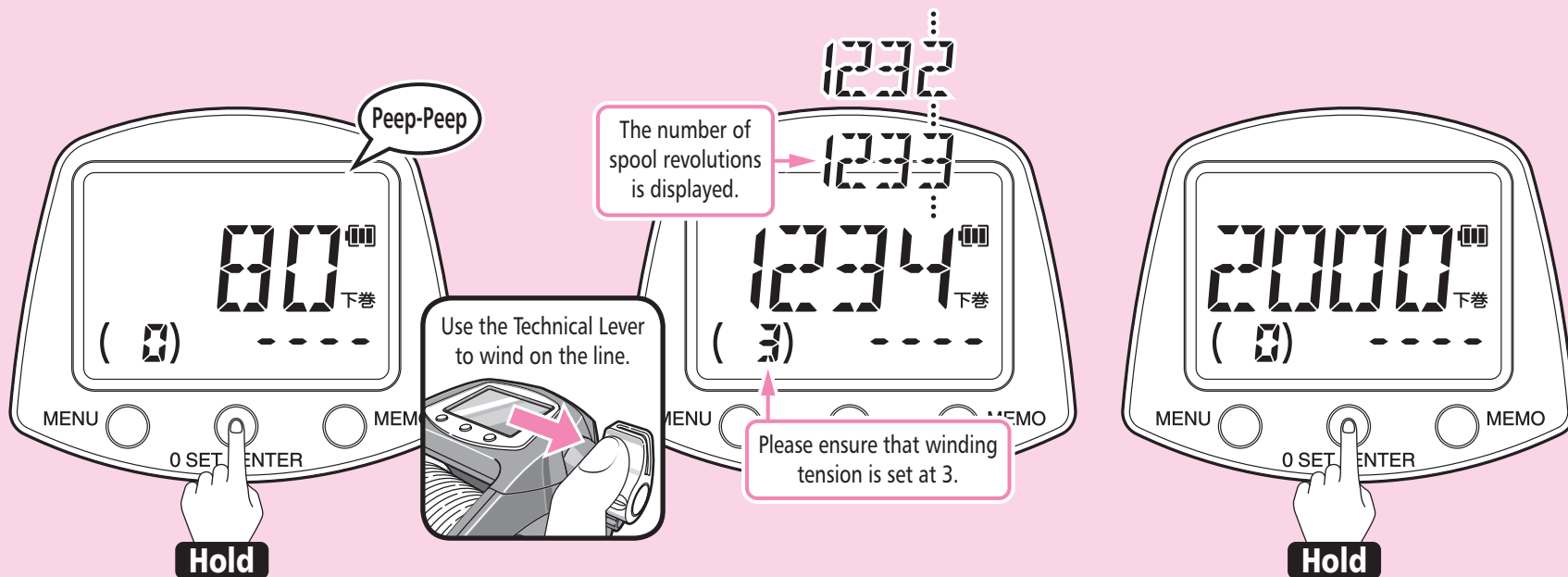

**6** Press Enter for more than 3 seconds.  
The alarm will sound (peep-peep) and the display will appear as shown in the diagram.

**7** Wind on the remainder of the rest of the main line.  
Use the Technical Lever to wind on the line. Please ensure that winding tension is set at 3 in the brackets.  
Winding speed can be adjusted using the Technical Lever. To stop winding in, move the Technical Lever to the OFF position.

**8** After completely finishing winding line, press Enter for more than 3 seconds to exit Learning Mode.

**Caution:** The values and settings shown on the reel display in this manual are in some cases just examples. Actual values may differ.

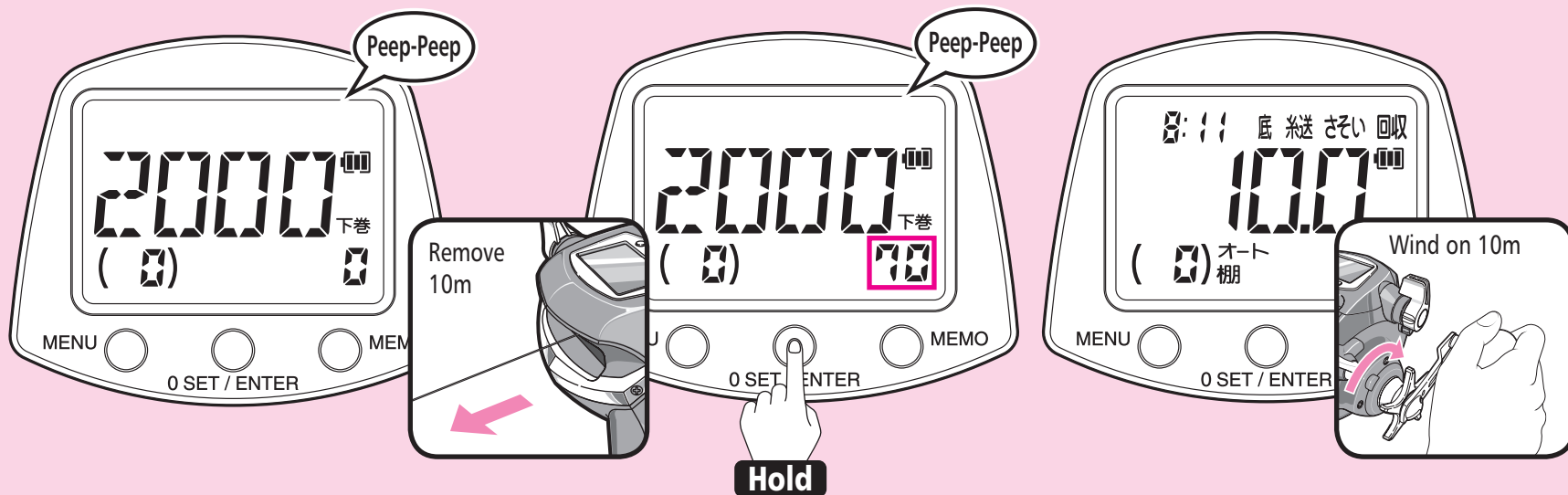

- 9** The alarm will sound (peep-peep) and the display will appear as shown in the diagram.  
**Accurately remove 10m of line.**  
(Check this according to the changes in line color that occur every 10m or according to the number of marks on the line that appear every meter.)

- 10** The number of spool revolutions will be displayed in the bottom right of the display (the area shown inside the square).  
**Press Enter for more than 3 seconds to exit Learning Mode.**  
The alarm will sound (peep-peep).  
\* If you accidentally press Menu while winding on line data will be lost and you will have to remove the line and repeat the process once more from **1** above.

- 11** The display will return to Standard Mode and learning will be complete.  
(In some cases there may be as much as a  $\pm 3\%$  difference between the value shown on the display and the actual length of the line.)  
\* After this when actually fishing, if you think that the difference is too great, carry out Line Learning Adjustment as shown on Pages 52~53. This will enable you to position your rig more accurately.
- 12** Wind up the 10m of line that was removed.

# What to do after completing Learning



## Basic

All you need to know in order to use the reel.



## Convenient

Simple and convenient features.



## Advanced

More advanced features open up a wide range of possibilities.



## Zero Reset

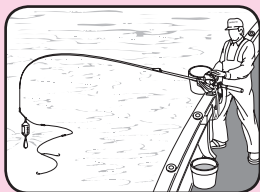

Press one button to Zero your line at the surface. Now you can accurately position your rig at your target depth.

See Pages 32~33 for details.



## Gunwale Stop

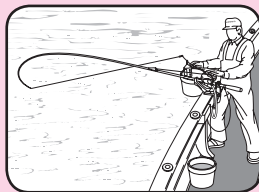

Stops retrieving the line at the point where you can raise the rod vertical and have the rig come straight to your hand.

See Pages 36~37 for details.



## Technical Lever

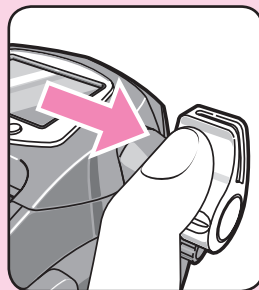

Use the Technical Lever to easily wind in your line when the bait needs to be changed or when you have hooked a fish.

See Page 11 for details.



## Auto Depth Alert

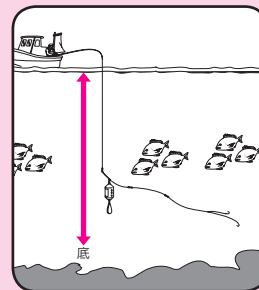

Record a specific depth and the next time you let down your rig an alarm will sound at that depth.

See Pages 38~39 for details.



## Rig Retrieval Time

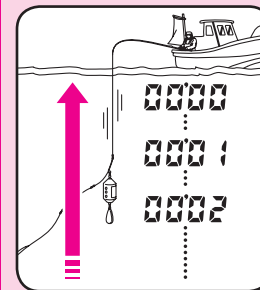

Displays the time remaining for the rig to be retrieved to the gunwale.

See Page 51 for details.



## Line Learning Adjustment



Adjust Discrepancies



Position your rig more accurately by eliminating the discrepancy between actual line markers and the counter on the display.

See Pages 52~53 for details.



## Change between Top-Down and Bottom-Up modes.

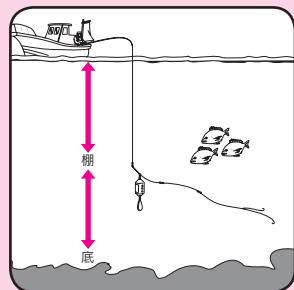

Depth can be shown as distance from the surface or distance from the bottom to best suit factors such as fishing ground, fishing technique and target species.

See Pages 40~42 for details.



## Change between Rakuraku Mode and Fixed Speed Mode.

The spool rotates at a constant speed in **Fixed Speed Mode.**

Switch between Modes

Line tension is constant in **Rakuraku Mode.**

Change between Rakuraku Mode, which maintains a constant tension and prevent line slack, and Fixed Speed Mode, which maintains spool rotation at a constant speed.

See Pages 43~44 for details.



## Jigging Mode

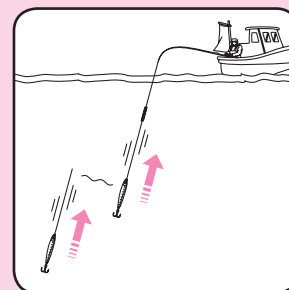

The reel replicates the popular jigging function.

See Pages 45~46 for details.



## Technique Master

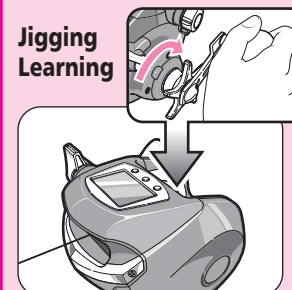

Allows you to teach the reel your own original jigging technique, which you can then use when fishing.

See Pages 47~50 for details.

# Various Techniques (You will want to learn these techniques to improve your catch.)



## Technique

### Drop Your Rig Quickly

This is an especially effective technique when fishing for squid.

- Normally, the mechanical brake knob is tightened to slightly brake the free rotation of the spool to prevent backlash due to the up/down movement of the vessel.
- To drop your rig faster, use your finger rather than tightening the mechanical brake knob.

You can also use the techniques shown below.

- This reel has an Auto Casting Function. The motor automatically starts when the rig is 5m or more past the gunwale stop position and spool resistance is minimized. The motor automatically stops when the clutch is returned.
- \* As the motor is in operation during Auto Casting, engaging the clutch will cause the line to be slightly wound in but this is not abnormal.
- Point the tip of the rod downward to reduce guide resistance as shown in the diagram on the right.

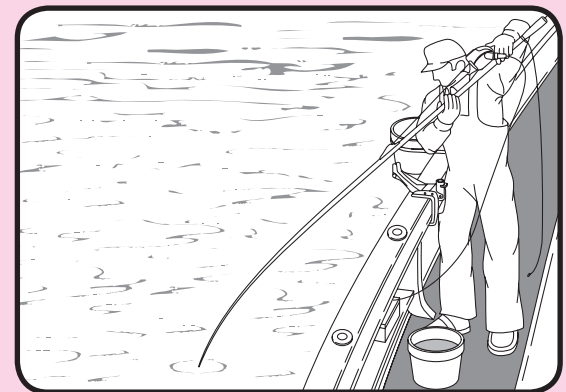
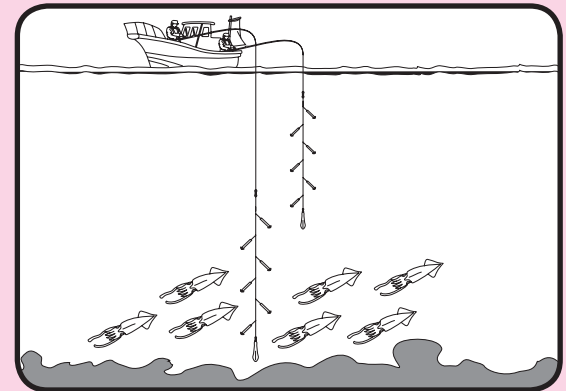

## Turning ON the Auto Casting Function

When you turn the reel ON the Auto Casting Function will be OFF.

1. With the motor stopped and the reel in Standard Mode, press MENU for more than 3 seconds to enter Menu Mode.
2. Press MENU several times until 糸送 flashes on the display.
3. Press ENTER to turn ON the Auto Casting Function. ▶ will be displayed.  
Use the same procedure to turn OFF this function if guide resistance or backlash is a problem.

Please see Pages 12~13 for details regarding menu button operation.

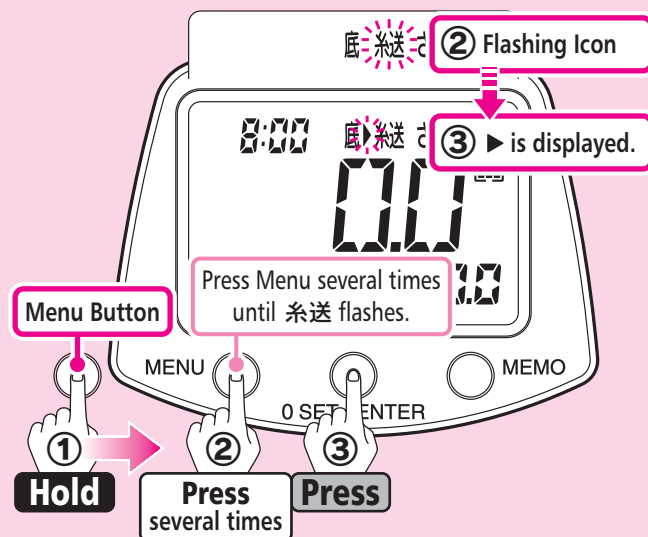

# Zero Setting (Always do this before you start fishing.)

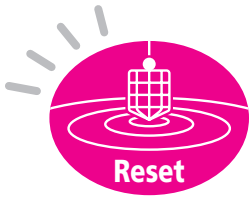

## Accurately reach your target fishing depth.

If you want to improve your catch you must be able to position your rig accurately at the target depth. Zero setting resets the counter to zero when the rig is on the surface.

Zero setting enables you to know the depth of the rig and to accurately position it at the target depth.

\* Do NOT wind too much line onto the spool as this can cause inaccurate readings when setting zero in one of the Learning Modes.

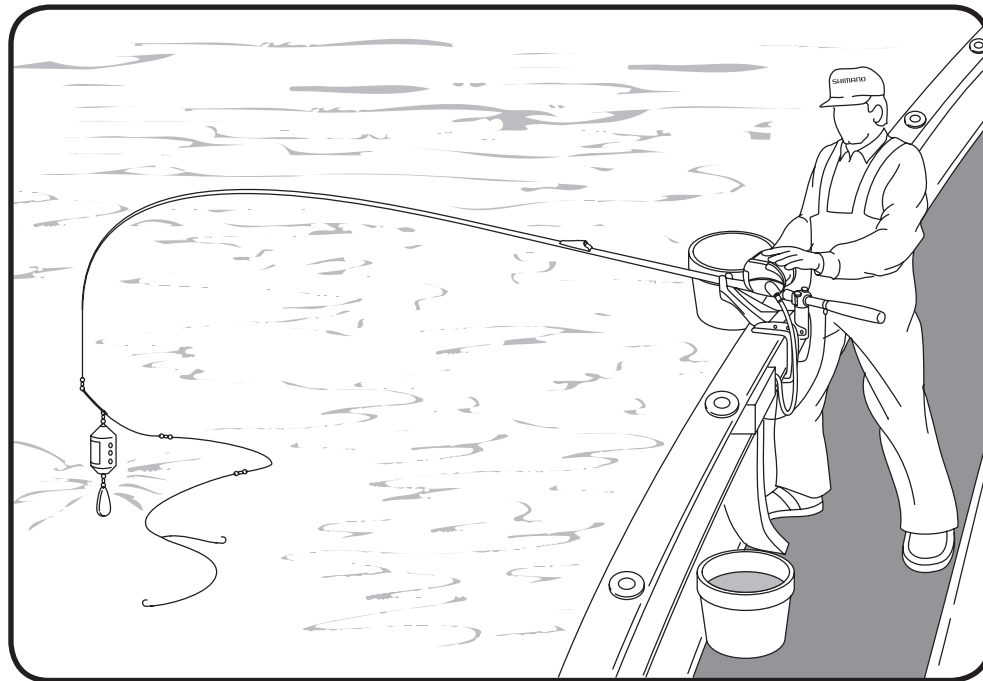

The counter can be reset to 0m when the rig is on the surface.



## Let's Try Zero Setting



- 1** Lower the rig to the surface and press 0 Set for more than 3 seconds.
- 2** The alarm will sound (peep-peep) and the display will change as shown above.
- 3** Zero setting is complete.

\* It may not be possible to zero the counter if Jigging Mode is ON.  
Always turn Jigging Mode OFF before zeroing the counter.

### **Caution**

Do NOT wind too much line onto the spool as this can cause inaccurate readings when setting zero in one of the Learning Modes.

# Adjusting Smart Line Depth

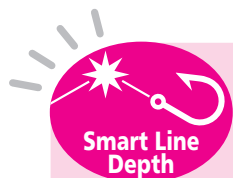

This function allows you to easily return your rig to the same depth after repairing your line if it breaks.

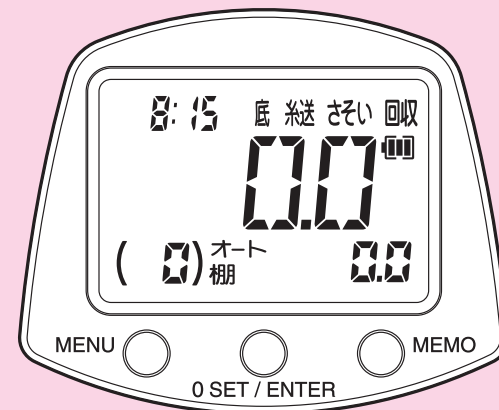

**1** If you break your line, after repairing it, lower your rig to the surface and press 0 Set for more than 3 seconds.

**2** The display will change as shown above.

**3** The computer will automatically return your rig to the same depth it was at before the line broke.

## ! Caution

Always check that Jigging Mode is turned OFF before adjusting Smart Line Depth. If it is ON and jigging starts, then the line can be wound in and cause unforeseen injuries.

## ! Caution

Do NOT adjust Smart Line Depth with an excessive amount of line wound onto the spool as this can cause inaccurate line learning.



## Shielded Anti-Rust Bearings provide even smoother operation.

A special corrosion-resistant material is applied to the surface of conventional antirust bearings to minimize saltwater penetration and these bearings are located at strategic locations to achieve even smoother performance.

These enable dramatically improved casting performance when fishing for spear squid, as well as improved float fishing performance — something that was said to be difficult to achieve with a powered reel.

This has been made possible by the optimum balance that has been achieved between the safety bar and the level winder, which is the part that is said to cause line tangles when float fishing.

Not only are these bearings resistant to rust, but they also minimize the formation of salt crystals inside the bearings, which can lead to corrosion.

**5 Ball Bearings**  
**3 Shielded Antirust Bearings**

\* There are normally only 2 bearings in the motor.



# Automatic Gunwale Stop



**When the motor stops,  
just raise your rod vertical and the rig will come straight to your hand.**

You can set the reel so that when the motor stops retrieving the line you just need to raise your rod vertical to have the rig come straight to your hand.

- \* When connecting to a power source for the first time the Gunwale Stop is set at 6m. From the second time onwards, the position at which the reel is stopped for more than 5 seconds will automatically be remembered by the computer as the Gunwale Stop position. (This feature works within the 1m~6m range. When the depth displayed is less than 1m, in the interests of safety it is set at 1m.)
- \* If there is a lot of line on the reel and the load changes greatly when retrieving the line then the rig may be wound into the end of the rod. When the reel detects major fluctuations in load, in the interests of safety, the Gunwale Stop position will be moved away from the rod to prevent the reel from malfunctioning.

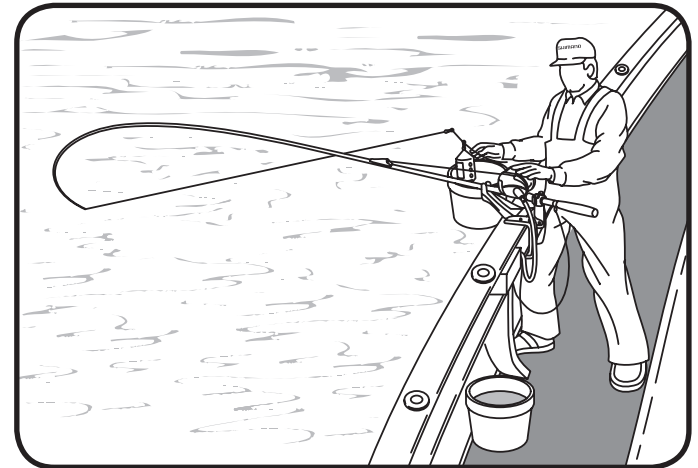

## Helpful Advice

When fishing with a short rod from the bow of a boat, if zero setting is carried out in the normal way, then the Gunwale Stop Position will be outside of the normal 1~6m range.

In such cases, wind the rig up to the end of the rod and reset zero at that point to ensure that when the motor stops the rig will come to your hand when you raise the rod vertical.

In this particular situation, as zero setting is not carried out on the surface of the water, the actual distance from the end of the rod to the surface of the water will be different.

# Alarm (Gunwale)

The alarm will sound 4m before the Gunwale Stop Position.

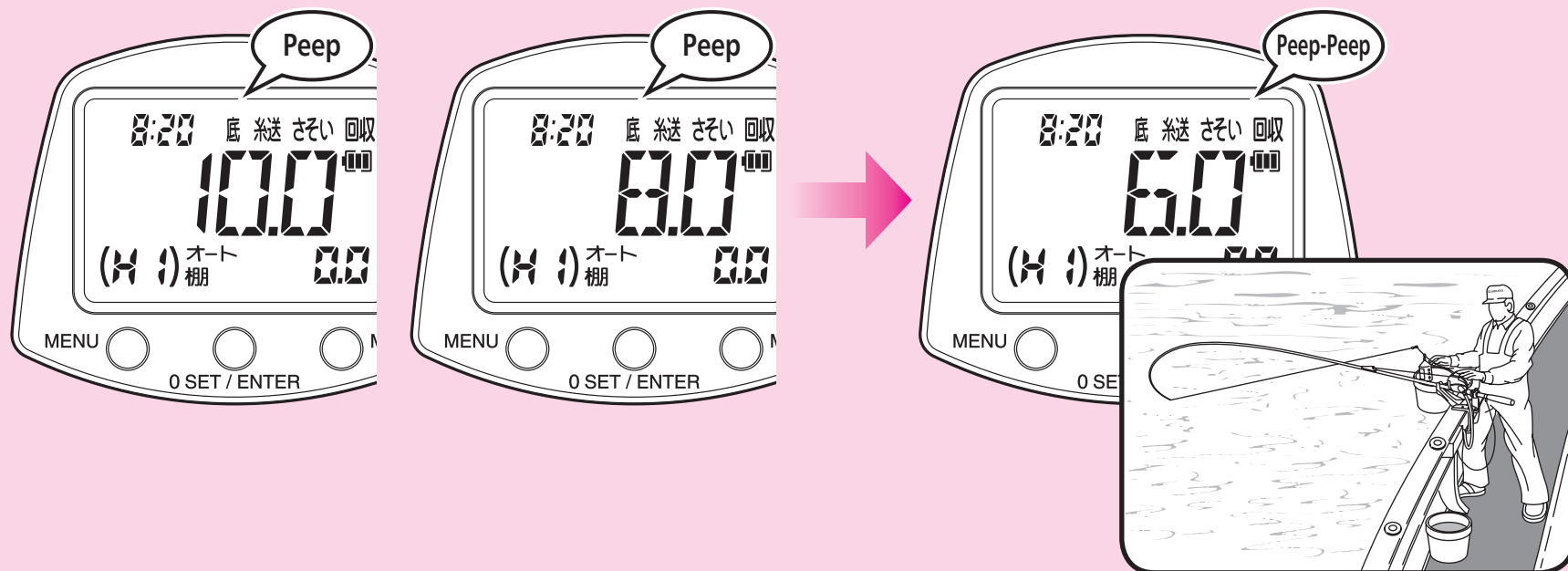

- 1** 4m before the Gunwale Stop Position the alarm will sound every 2m.  
The diagram above shows the display when winding in using the Technical Lever in HI.

- 2** At the Gunwale Stop Position (in this case at 6.0m) the alarm will sound (peep-peep) and the motor will automatically stop. After the motor has stopped you can raise the rod vertical and have the rig come straight to your hand as shown in the diagram above.

# Programming Target Depth and Bottom Depth



The Auto Depth Alert can be programmed automatically or manually.

## Auto



Any depth past 6.1m where the rig stops for more than 6 seconds is automatically saved as the target depth and is shown in the bottom right hand corner of the display when the rig is stopped at the Gunwale Stop Position (the figure shown above inside the square).

If the rig stops for more than 6 seconds more than once, the last depth is saved as the target depth. If the rig stops for less than 6 seconds then the maximum depth will be reached and saved in the memory.

The example shown in the diagram above is for Top-Down Mode. The figures shown on the display are for illustration purposes only.

## Manual



Lower the rig to the target depth (6.1m or more) and press Memo.

オート (Auto) will disappear from the display. In the diagram above, a depth of 10.2m has been saved manually (the figure shown above inside the square).

**In Bottom-Up Mode, the current depth is set to 0.0m.**

The Auto Depth Alert can be set as many times as you like.

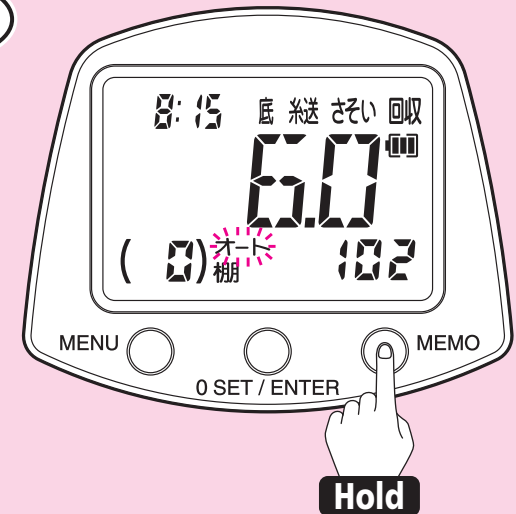

### Changing from Manual to Auto

Press Memo for more than 3 seconds when the rig is at the Gunwale Stop Position to change back to auto mode.

The alarm will sound 4m before the saved depth.



**1** When lowering the hook the alarm will sound (peep) every 2m from 4m before the saved depth.

**2** At the saved depth (in this case 100m) the alarm will sound (peep-peep).  
The alarm will only sound only once in each cast.

# Finding the Target Depth



## Choose between Top-Down and Bottom-Up Modes

The secret to improving your catch is being able to accurately position your rig at the depth where the fish are.

With the latest high-performance fish finders it is possible to see the exact depth that the fish are at. The skipper of the vessel will normally give you this information.

Depending on factors such as fishing ground,

fishing technique and target species, this position may be given as the distance from the surface or the distance from the bottom.

This reel is ideally suited to either situation as it has both a Top-Down Mode and a Bottom-Up Mode.

Select between modes according to the situation at hand.

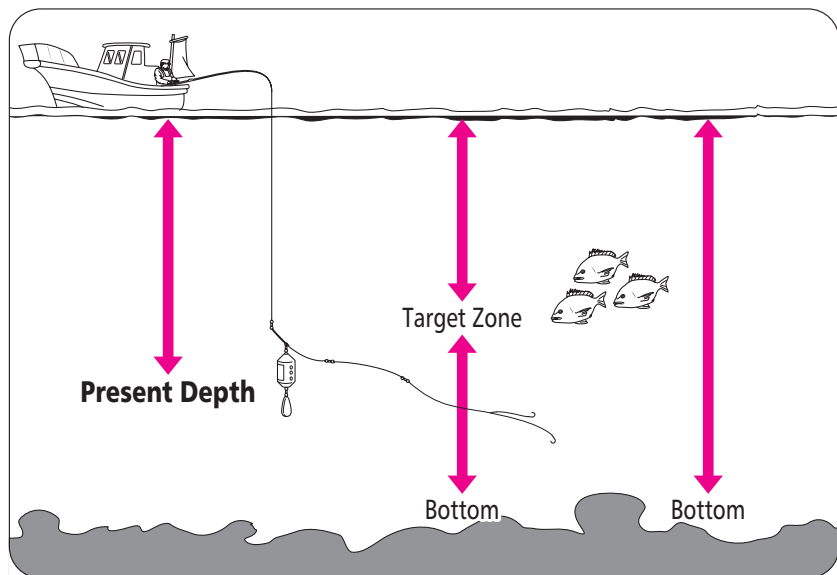

## Changing Mode

When the power is turned ON the reel will be in Top-Down Mode. Use the procedure shown below to change modes.

1. When the motor is stopped in Standard Mode, press Menu for more than 3 seconds to enter Menu Mode.
2. Press Menu repeatedly until 底 flashes on the display.
3. Press Enter and ▶ will be displayed next to 底 to indicate Bottom-Up Mode. Repeat the procedure to select to Top-Down Mode.

Please see Pages 12~13 for details regarding menu button operation.

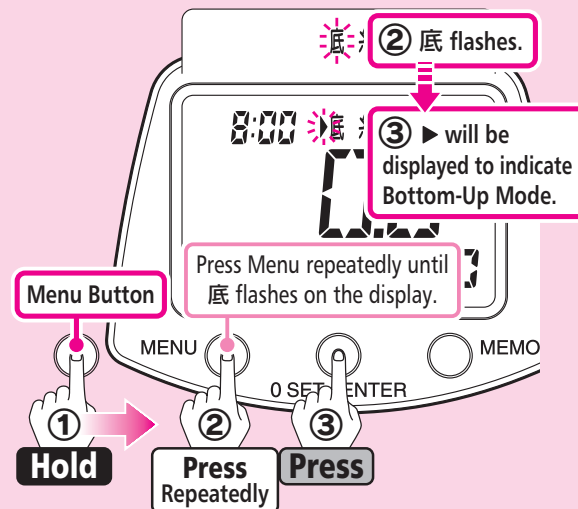



# Top-Down Mode Example

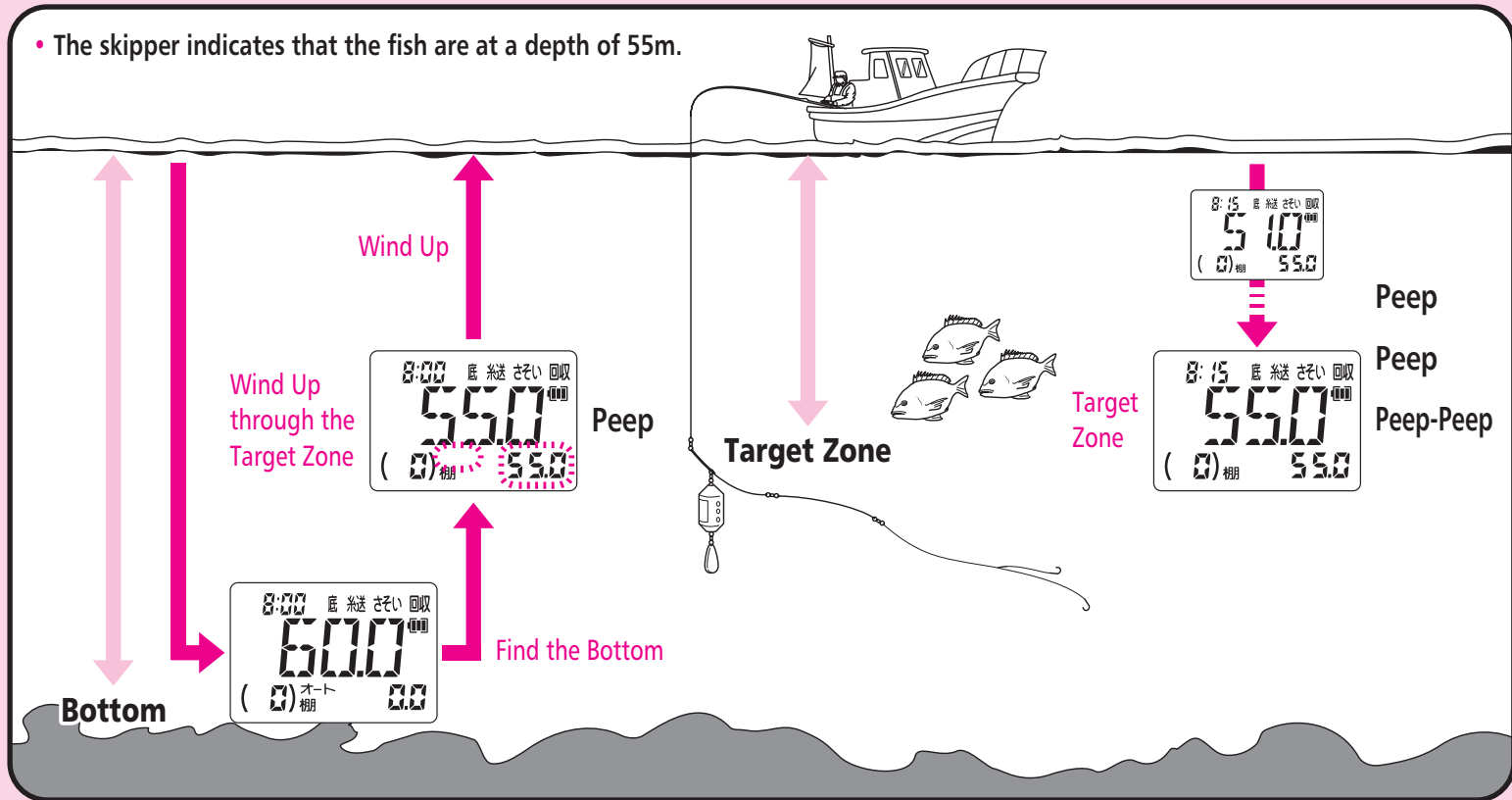

**1** Allow the rig to drop to the bottom.

**2** Wind the rig up to the target depth. Press Menu to save the target depth. The above procedure is used when you want to know the depth of the bottom. However, it is also possible to drop the rig to the target depth and then press Memo to save that depth.

**3** On subsequent drops the alarm will sound when the rig reaches the saved depth.



# Winding In: Rakuraku Mode | Fixed Speed Mode



## 1 Changing between Rakuraku Mode and Fixed Speed Mode

- Press Menu to change between Rakuraku Mode and Fixed Speed Mode. You can change modes when winding in.
- The current mode is shown on the display.  
Rakuraku Mode: Green backlight.  
Fixed Speed Mode: Orange backlight. (速 is displayed.)

## 2 What is Fixed Speed Mode?

Regardless of the size of the fish, or in other words the load on the reel, Fixed Speed Mode adjusts motor settings to wind in your fish at a set speed\*.

\* Speed is the spool rotation speed of the spool.

A circular icon with a gear and a fish, labeled "Technical Level".

**Present Mode**  
Rakuraku Mode: Green backlight.  
Fixed Speed Mode: Orange backlight (速 is displayed).

Shows the position of the Technical Lever.

A diagram of the reel's control panel. It features a digital display with various indicators and text. Below the display are three buttons: "MENU", "0 SET / ENTER", and "MEMO". A hand is shown in an inset diagram, pressing the "MENU" button. Pink lines connect the text labels to the corresponding parts of the reel.

**Technical Lever**  
Used to set Fixed Speed Mode and Rakuraku Mode.

**Rakuraku Mode | Fixed Speed Mode Button**  
Used to change between Rakuraku Mode and Fixed Speed Mode.

(Continued on the next page.)

### 3 What is Rakuraku Mode?

Rakuraku Mode maintains line tension at the level you set. In other words, the reel senses the tension (load) on the line and automatically adjusts motor rotation speed to maintain a constant tension.

  
**In other words...**

<ul style="list-style-type: none"><li>• It avoids the tug of war that occurs between the motor and the fish.</li></ul>	<ul style="list-style-type: none"><li>• This is particularly useful when fishing in rough water where it is impossible to maintain a constant tension on the line manually by using the rod.</li></ul>
<ul style="list-style-type: none"><li>• It adjusts motor speed to compensate for sudden changes in tension caused by the movement of the fish and the vessel.</li></ul>	<ul style="list-style-type: none"><li>• The motor takes up any sudden slack in the line when tension decreases due to factors such as when the rod is lowered during pumping.</li></ul>
<p><b>It makes reeling your fish in so easy that you just need to enjoy your fishing.</b></p>	

### It also has the following advantages...

- It can handle any kind of fishing other than live bait fishing. Rigs with only a light load can be recovered at maximum speed without having to worry about adjusting motor speed, which makes life easy and means that you can concentrate on fishing.
- Adjust tension can quickly and easily using the Technical Lever.
- Maximize rig strength by eliminating the tug of war that occurs between the motor and the fish.



### Setting Rakuraku Mode

- Settings are adjusted using the Technical Lever (see the previous page for details).

There are **30** tension settings that can be selected using the Technical Lever.

These are displayed as shown in the diagram.

- Settings **1~4** are for dead slow. At some tension setting the weight of the sinker can stop the rig from being wound in. In such cases increase the tension.

# Jigging Mode



## The reel can replicate the popular jigging function.

This is particularly handy when you want to fish all day using this technique.

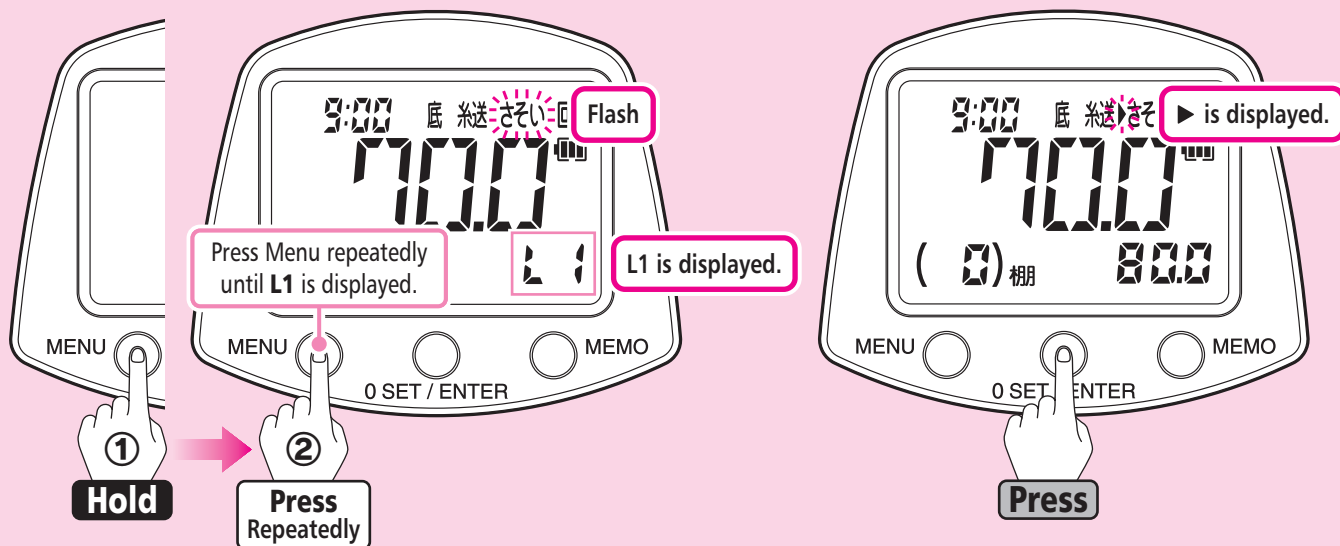

- 1 With the motor stopped and the reel in Standard Mode, press Menu for more than 3 seconds to enter Menu Mode. Press Menu repeatedly until さそい flashes on the display and L1 is displayed.

**Caution:** The settings and values shown on the display are for illustration purposes only. Actual settings and values may differ.

- 2 Press Enter and ▶ will be displayed to indicate that Jigging Mode is ON. Carry out the same procedure again when you want to turn Jigging Mode OFF. Please see Pages 12~13 for details regarding menu button operation.

### Caution

Always check that Jigging Mode is turned OFF before adjusting Smart Line Depth. If it is ON and jigging starts, then the line can be wound in and cause unforeseen injuries.

(Continued on the next page.) 

**Caution:** The settings and values shown on the display are for illustration purposes only. Actual settings and values may differ.

### Start Jigging

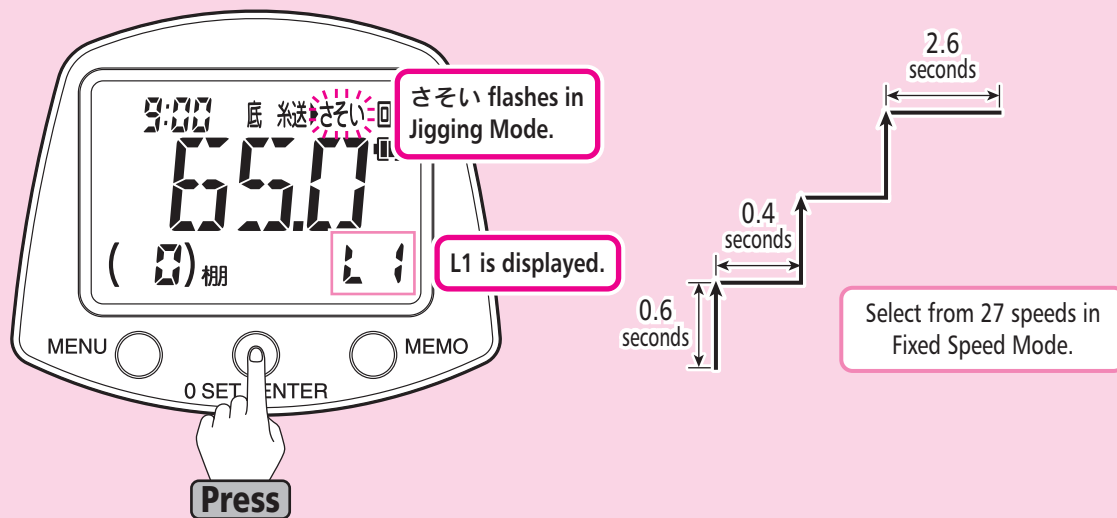

- 3** Press Enter again to repeat jigging in Jigging Mode. Press Enter again during jigging to stop and start jigging. さそい will flash during Jigging and L1 will be shown in the bottom right of the display.

- \* If you start to retrieve your rig using the Technical Lever during jigging then jigging will be cancelled.
- \* When Lure Retrieval Time is ON, after jigging movement is cancelled then lure retrieval time will be displayed.
- \* The motor will stop after the Gunwale Stop.

### Caution

**Do NOT press for more than 3 seconds.**

If you press Enter for more than 3 seconds then the reel will adjust the Smart Line Depth and an error will be shown on the display. If this happens, either carry out Line Learning again or wind the rig in manually until it gets to the surface and then reset 0m. (When carrying out this at 65m as shown above, the display will show -65m when reset.)

# Jigging Learning



## Replicate Your Own Original Jigging Technique.

Using Jigging L2 Mode you can teach the reel your own original jigging technique, which you can then use when fishing.

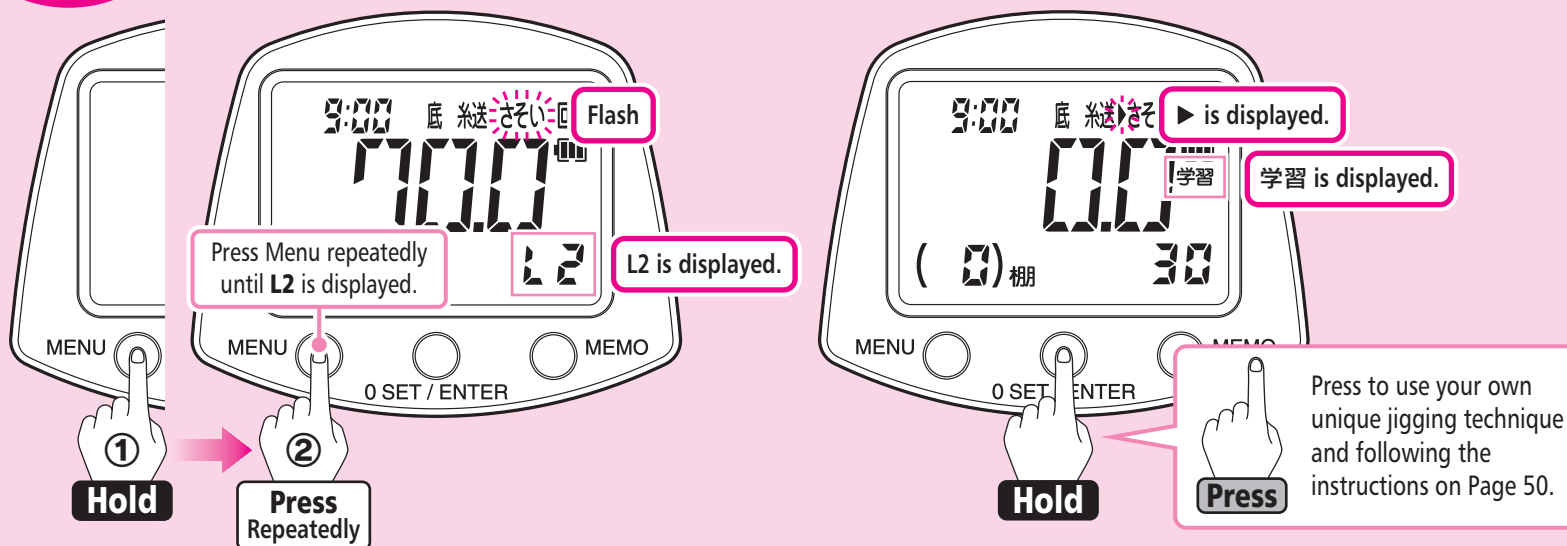

- 1 With the motor stopped and the reel in Standard Mode, press Menu for more than 3 seconds to enter Menu Mode. Press Menu several times until さそい flashes on the display and L2 is displayed.

### Caution:

The settings and values shown on the display are for illustration purposes only. Actual settings and values may differ.

- 2 Press Enter for more than 3 seconds and ▶ will be displayed together with 学習 to indicated that you are in Jigging Learning Mode.

Press Enter for less than 3 seconds to turn Jigging Mode ON and use the jigging technique you have input in L2. If no jigging technique is input then the setting will default to L1.

When you want to use this technique press Enter. Please see Page 50 for more details.

(Please see Pages 12~13 for details regarding menu button operation.)

### Caution

Always check that Jigging Mode is turned OFF before adjusting Smart Line Depth. If it is ON and jigging starts, then the line can be wound in and cause unforeseen injuries.

(Continued on the next page.)

**Caution:** The settings and values shown on the display are for illustration purposes only. Actual settings and values may differ.



**3** Jigging Learning can be carried out for a maximum of 30 seconds.

The time remaining to record your jigging technique will be displayed on the lower right of the display.

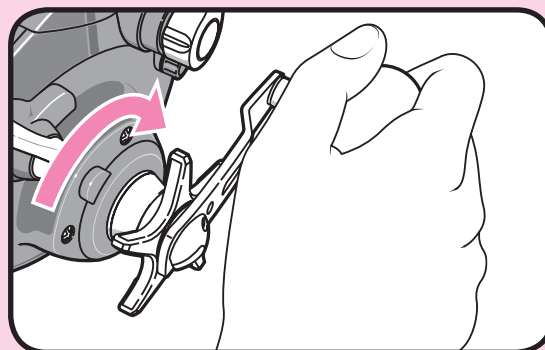

● **Learning Using the Handle**

Turn the handle at the desired speed and then rest for as long as you want.

If you take too long to turn the handle (more than 2 seconds for a single turn) then this will not be recorded.

If the spool turns faster than the maximum speed using the Technical Lever, then this will be recorded as the maximum speed for the Technical Lever.

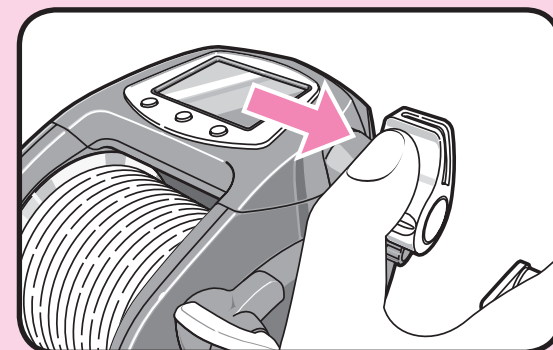

● **Learning Using the Technical Lever**

Retrieve the line at the speed and timing you desire and then rest for as long as you want.

This is only possible in Fixed Speed Mode.



**Caution:** The settings and values shown on the display are for illustration purposes only. Actual settings and values may differ.

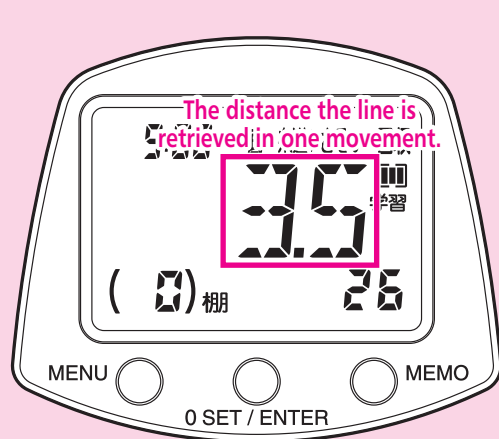

- 4** Review the technique (winding and rest times) recorded using the Technical Lever or the handle.

Learning starts when winding begins and at the same time the number of seconds remaining is shown on the display.

The distance the line is retrieved in one movement is shown in the center of the display.



- 5** Press Enter to stop Learning.

If Enter is not pressed then Learning will automatically stop after 30 seconds.

After Jigging Learning has stopped the total line retrieval distance (estimate) is displayed in the center of the display for 2 seconds as shown above.

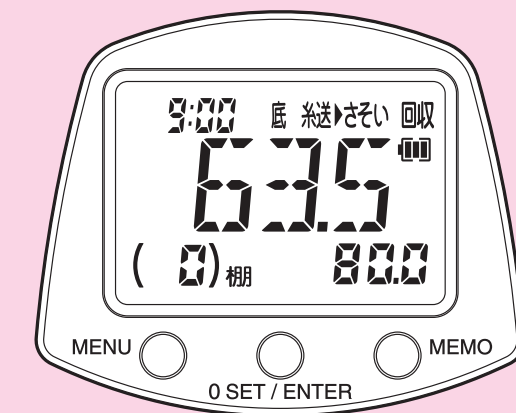

- 6** The display will return to Standard Mode

\* If you input a new technique in Jigging Learning then the old data will be erased. If you want to redo Jigging Learning then go back and repeat the process from the beginning.

▶ will be displayed to indicate that Jigging Mode is ON. The reel is now ready to use in Jigging Mode with your own original jigging technique.

(Continued on the next page.)

**Caution:** The settings and values shown on the display are for illustration purposes only. Actual settings and values may differ.

## Start Jigging

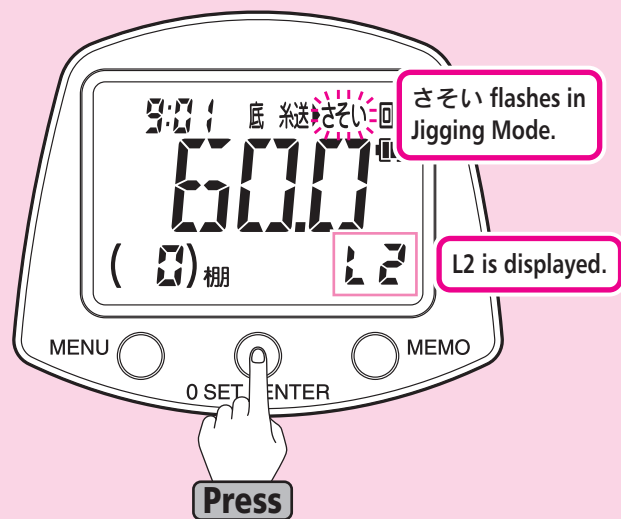

**7** Press Enter again to use the jigging technique input in Jigging Mode. Press Enter to stop and start this movement at any time. さそい will flash during Jigging and L2 will be shown in the bottom right of the display.

- \* If you start to retrieve your rig using the Technical Lever during jigging then jigging will be cancelled.
- \* When Lure Retrieval Time is ON, after jigging movement is cancelled then lure retrieval time will be displayed.
- \* The motor will stop after the Gunwale Stop.

## Caution

**Do NOT press for more than 3 seconds.**

If you press Enter for more than 3 seconds then the reel will adjust the Smart Line Depth and an error will be shown on the display. If this happens, either carry out Line Learning again or wind the rig in manually until it gets to the surface and then reset 0m. (When carrying out this at 60m as shown above, the display will show -60m when reset.)

# Rig Retrieval Time



When retrieving the rig under power, this displays the time remaining for the rig to be retrieved to the Gunwale Stop Position.

Use the procedure shown below to turn ON this function.

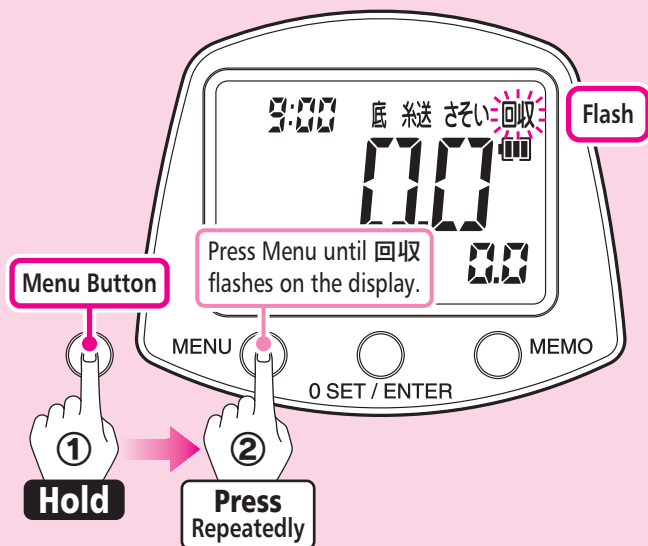

- 1 With the motor stopped and the reel in Standard Mode, press Menu for more than 3 seconds to enter Menu Mode. Press Menu repeatedly until 回収 flashes on the display.

### Caution:

The settings and values shown on the display are for illustration purposes only. Actual settings and values may differ.

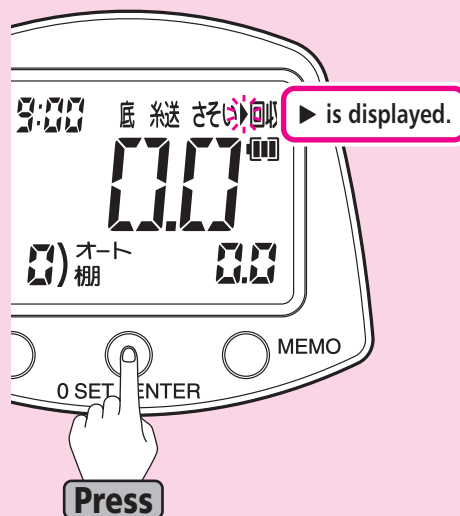

- 2 Press Enter and ▶ will be displayed to indicate that Rig Retrieval Time is ON. Carry out the same procedure again when you want to turn Rig Retrieval Time OFF. Please see Pages 12~13 for details regarding menu button operation.

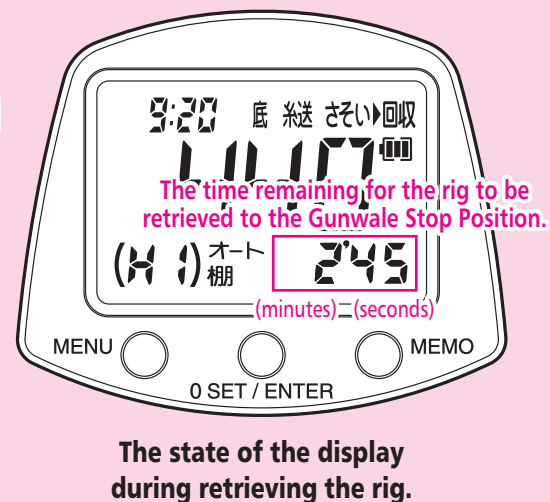

The state of the display during retrieving the rig.

When retrieving the rig under power, this displays the time remaining for the rig to be retrieved to the Gunwale Stop Position.

The display can show a maximum of 99'59 (99 minutes and 59 seconds). For times longer than that the display will flash 99'59.

# Line Learning Adjustment

Line Learning Adjustment

Set the target depth more accurately by correcting the discrepancy between the depth shown on the display and the markings on the line.

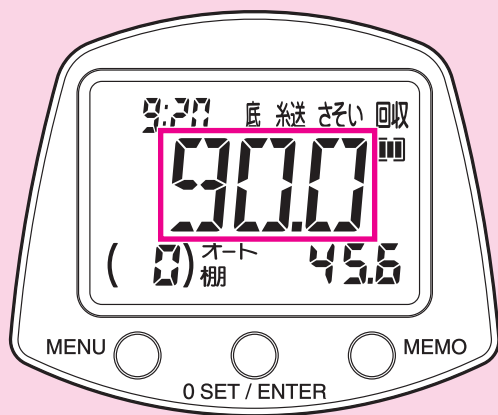

- 1 Effective at a depth of more than 10m. Round up the present depth displayed to a convenient number (round decimal points to 0) to easily match it with the markings on the line. The color of the line changes every 10m.

\* More accurate adjustment is possible at depths greater than 100m, such as when the display changes from 199m to 200m.

**Caution:** Jigging Mode needs to be turned OFF to carry out Line Learning Adjustment. Always make sure that Jigging Mode is OFF.



- 2 Press Enter and Memo at the same time for more than 3 seconds to enter Line Learning Adjustment.

The alarm will sound (peep-peep) and the depth will flash on the display. Feeding the line by hand will not affect the display at that time.

**Adjust the display to match the actual position of the line (90m in this example) on the surface of the water.**

\* Press Menu to cancel the adjustment. Using the motor (winding in the line or hooking a fish, etc.) will also cancel the adjustment. When that happens, the previous adjustment setting will be used.



- 3 Press Enter to complete the adjustment. The alarm will sound (peep-peep). The display will return to Standard Mode and the adjusted depth will be shown on the display.

Even if the power is turned OFF, Line Learning changes will be saved.

### Caution:

The values and settings shown on the reel display in this manual are in some cases just examples. Actual values may differ.

1

The depth on the display is different from the line marking!

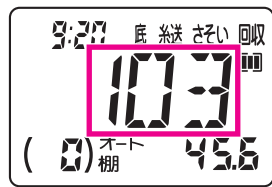

100m

2

Use Line Learning Adjustment.

What do I do?

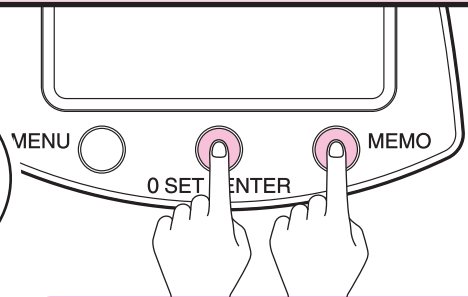

Press Enter and Memo at the same time for more than 3 seconds.

3

The depth shown on the display flashes and does not change even though I am winding in and feeding out the line.

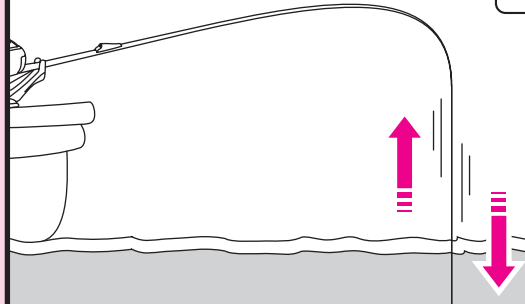
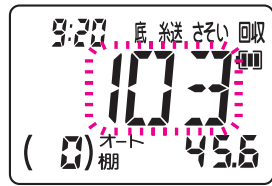

4

Just match the markings of the line with the depth shown on the display and ...

103m

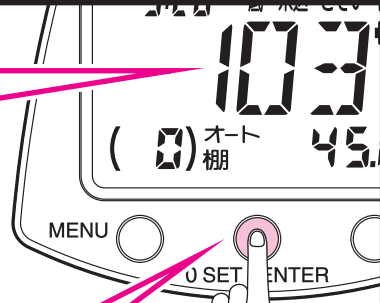

then press Enter. It will be perfectly adjusted for the next time.

# Handing Instructions

This reel consists of precision electrical components. Please read and follow the instructions below. Proper maintenance after every fishing trip is recommended to ensure that you will be able to enjoy using the reel for many years to come.

## 1 Caring for Your Reel

\* Remove the power cord and make sure that the reel has completely cooled down before you start any maintenance.

1. Tighten the drag.
2. Wash the outside of the reel with water, using a wet sponge to remove any dirt.
3. Disengage the clutch to let out 2~3m of line while washing between the spool and reel to get rid of the salt as shown in the diagram.
4. Loosen the drag completely and leave the reel to dry in a shady place.

\* Wash or lightly brush the alligator clips using freshwater to get rid of any impurities from seawater.

### \* Salt Build-Up in the Bearings

S A-RBs (Shielded AntiRust Bearings) are made from corrosion-resistant material. However, that does not entirely prevent saltwater from entering the bearings and leaving a build-up of dried salt. They will not rust, but the rumbling sound that accompanies this build-up

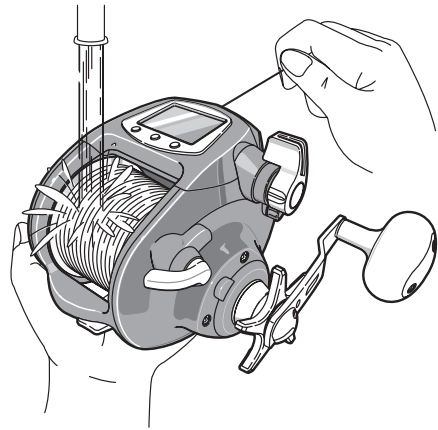

## 2 Cleaning Your Reel (When you notice a deterioration in spool rotation.)

- If the spool is not rotating as smoothly as usual even after normal maintenance then this may indicate that there is a build-up of salt in the bearing near the handle.

\* Remove the power cord.

1. Carefully immerse the reel in freshwater up to spool as shown in the diagram. Do NOT immerse the whole reel. Rotate the spool to dissolve the salt and regain performance.

Immerse up to this point.

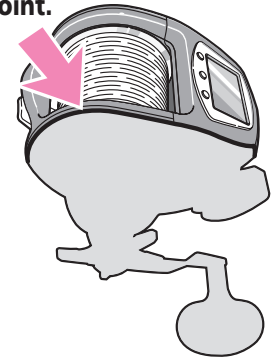

2. Remove the reel from the water and hold it up with the connector side facing down to ensure that the water completely drains from inside the reel.

If that does not improve the situation, please contact your nearest sales office to have the reel overhauled.

## 3 Precautions

- One of the characteristics of powered reels is that even though the motor is ON, sometimes line will not get wound in if a fish is hooked because the drag is slipping. This is similar to an automobile going along with the handbrake on. If this goes on for a long time, then the oil in the drag will be burn off and eventually the drag will burn out. Take care not to allow this to happen as it could destroy the entire reel.
- When the line is caught, do NOT exert excessive force on the rod or reel. Instead, please cut the line after taking care to minimize the amount of line left in the fishing ground.
- Please take care when handling the reel. Never throw it in your bag or allow it to bang against other items during transportation.
- NEVER drop or hit the reel. Treat it carefully.
- Take care not to hit the back of the reel or bend the power cord when putting the reel into a rod stand. Take special care not to trap the power cord between the reel and the gunwale.
- Some types of polarizing sunglasses make it difficult to properly view the display.
- After winding in a heavy load, take care when dropping the rig and winding it in the next time as the rig may get tangled with the tip of the rod.
- If the resin footing of the reel is secured to a metal reel mount, this may damage the resin and can ultimately damage the whole reel. Please make sure the resin protector is properly in place when attaching the reel to a metal mount.

(Continued on the next page.)



## 4 Maintaining Your Reel

- **Regular Maintenance - Please contact your nearest service center.**

The condition of the reel is greatly influenced by not only frequency of use, but also the environment in which it is used, how it is used and the target species. If any abnormality is detected, please contact your nearest service center through the nearest retailer immediately. A regular professional maintenance check once every six months is highly recommended.

- Always remove the power cord from the reel before storing it.
- Place the protective cap on connectors when the reel is not in use.
- NEVER try to disassemble the reel as this can damage internal electrical components such as the motor and circuit breaker and may cause the reel to malfunction.
- NEVER oil the drag mechanism as this may decrease performance.
- Leaving the reel in high temperature, high humidity conditions for a long period of time may cause deformation or weakness. Always store in a cool, dry place after carrying out regular maintenance.

- NEVER immerse the entire reel in water, especially the display. (Although the display is shower proof it is best to avoid immersing it in order to prevent any trouble.

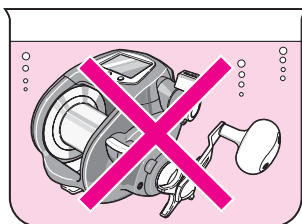

- **Removing the handle.**

1. Undo the two screws to remove the plate from the handle.
2. Undo the bolt inside the handle.

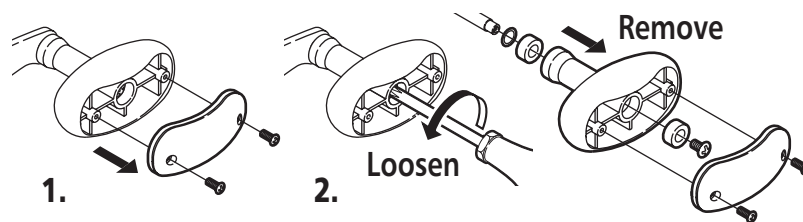

- **Attaching the Rod Clamp**

Attach the reel to the rod and hold the rod clamp under the rod while securing the clamp with the nut provided.

- \* **Reel Mount Nut Washer**

When the diameter of the rod is too small for the reel mount, the bolt will stick out too far to use the wrench provided. In such a situation use a washer.

**Caution**

Test the stability of the reel mount against the rod when attaching the rod clamp.

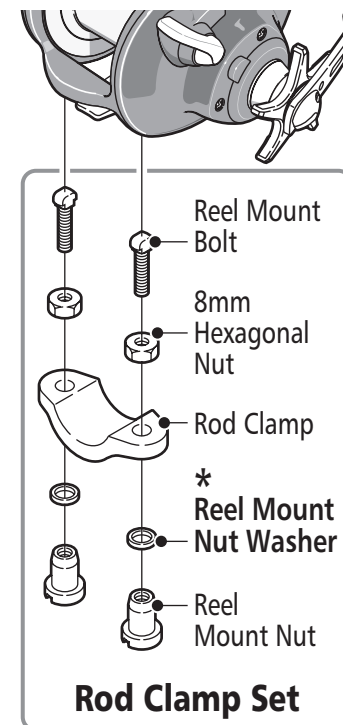



- Please use Shimano Reel Grease to extend the life of your reel.  
Apply the grease at the locations shown in **Figure 1** and **2**.

**Shimano Genuine Reel Grease Spray (SP-023A)**

**Figure 1. The end of the power cord.**

It is more effective to apply grease to the terminals in the socket of the reel.

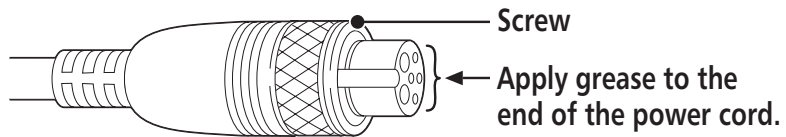

**Figure 2. The worm shaft and sides of the worm shaft.**

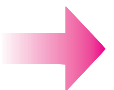
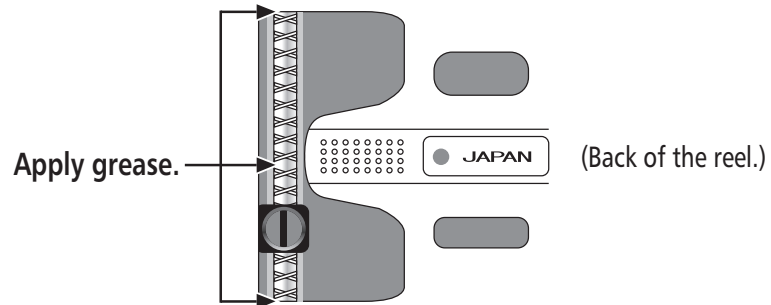

# 5 Safety Features

## ● Automatic Circuit Breaker

The motor will turn ON and OFF at 1 second intervals if there is excessive load on the reel. This is normal.

When that happens, the circuit breaker will trip and the display will flash. Leave it flashing for 5 minutes to protect the motor. Learning data will be saved even if the line is wound in or fed by hand. The motor will start to operate again when the flashing stops.

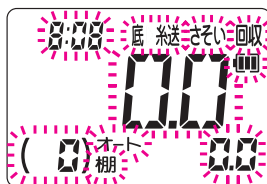

## ● Battery Status Display

When battery voltage drops below 10.5V (13.5V for the lithium-ion battery), or when the power cord is not properly connected, the battery icon on the display will flash. Check the connection first. If there is no problem with the connection then the battery will need to be charged.

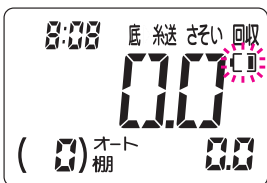

## ● Technical Lever Breakage

Please refer to the **Inquiries | After Sales Service** section to have the unit repaired if this error message is shown in the display.

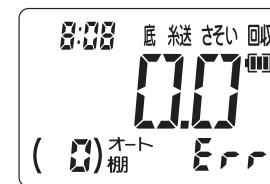

\* Do NOT wind or unwind the line when this **Err** error message is displayed. Line Learning will be inaccurate.

## ● If Voltage is Too High

This error message will be displayed if a voltage of more than DC28V is applied. Please check the power source and make sure that it provides between 12V~24V.



## ● Inaccurate Line Learning Operation

This error message indicates inaccurate Line Learning. Carry out Line Learning again.



## 6 Specifications

### Maximum Winding Strength

**90 kg**  
882N

Reference

### Maximum Drag

**25 kg**  
245N

Maximum drag for Shimano boat reels is the drag produced when a person pulls the reel with one hand.

### Maximum Winding Speed

**150 m/min.**

Retrieval speed when winding the line in with no load.

### Actual Winding Speed

1kg (Load) 2kg (Load) 3kg (Load)  
**130 m/min. 125 m/min. 123 m/min.**

The time required for bringing a rig to the surface from 100m. Actual winding speed is for example, is the speed at which a specific load can be reeled in from 100m at maximum speed using a #9000 series reel with 940m of POWER PRO 100lb.

Measuring Conditions: A 12.5V power supply at 15~20°C. (Speed will be higher if a higher voltage lithium battery is used.)

\* Measurements may fluctuate according to the environment in which the reel is used.

### Actual Maintainable Winding Strength

**15.0 kg**  
147N

The winding strength that can be maintained for an extended period of time.

The actual maintainable winding strength is the weight of the load when the circuit breaker actually trips under the gradually increasing load.

Model Number	Product Code	Gear Ratio	Weight (g)	Line Capacity (lb-m) POWER PRO	Winding Capacity (cm/1 handle rotation)	Spool Dimensions (diameter/width (mm))	Handle Length (mm)	Bearing Number (balls/roller)
DENDOMARU 9000 Beast Master	51RG 299100G	3.1	1465	50 (0.32mm) -1870, 80 (0.41mm) -1150 65 (0.36mm) -1650, 100 (0.43mm) -940	88	90/62	75	3 S A-RB + 2* / 0

\* Normally there are 2 bearings inside the motor.

### ● Standard Accessories

Power Cord, Operating Manual, Grease, Component Diagram, Line Threading Pin, Rod Clamp Set, Reel Wrench, 10m line

### ● Power Supply (DC Only)

DC12V~24V (Compatible with lithium batteries.)

### ● Caution

When using POWER PRO 50lb or less, take care not to cause backlash or the line may be caught between the spool and the frame.

# Troubleshooting

Situation	What to do	Reference
The display is black or shows all characters.	This happens when the unit is left somewhere at high temperature, such as in a car boot. It will return to normal when the temperature goes down.	
Nothing appears on the display.	Check to see if the (+) and (-) of the power cord are connected properly to the battery. Check to see if the battery has sufficient charge. Check the surface of the alligator clips for foreign objects.	P.14~P.15
Nothing appears on the display (when used in extreme cold).	When the LCD display is left in extreme cold (below -15°C), the display will not work for a while even though the power is turned on. Wait until the circuit board inside the unit warms up. When fishing in extremely cold conditions, it is recommended that the reel be kept in the cabin or under cover until it is needed.	
Line Learning cannot be set.	Please try the Line Learning process again.	P.16~P.27
The numbers on the display do not change even when line is fed out.	Please try the Line Learning process again.	P.16~P.27
There is too much discrepancy.	Please try the Line Learning process again.	P.16~P.27
The number on the display does not match the line depth marks.	Depending on the type of line, sometimes the line gets stretched, which can cause discrepancies on the display.	
The Gunwale Stop position is wrong.	This is probably due to winding tension or stretched line. Carry out 0 set. Gunwale set is only possible between 1~6m. Settings between 0~1m are rounded up to 1m for safety reasons.	P.32~P.33 P.36
The display is working but the motor is not.	Check if the battery has enough charge. When the battery does not have enough charge, the motor may work at low speed but not at high speed. Charge the battery and test the reel. If that does not improve the situation, you may need a new battery. The motor may not work when the temperature of the reel is below 0°C. When fishing in extremely cold conditions, keep the reel in the cabin or leave it ON until it is needed. Furthermore, the motor does not start when the display shows less than 1m for safety reasons.	P.14 P.11

Situation	What to do	Reference
<b>The motor stops while winding.</b>	Make sure all the screws on the power cord connector are at the connector. If the boat's power supply terminal or the reel's power cord connector is rusty, the current will not flow properly. Remove any rust and try again. Battery charge should also be checked.	P.14
<b>There is a strange sound in the reel even when not winding.</b>	A condenser is installed under the display unit to protect the reel from fluctuating current. The condenser may vibrate and make some noise when the reel is used with an unstable power supply. However, this will not affect reel function so it is OK to keep on using it.	

In order to enjoy fishing, please turn the power on and check the performance of the reel before you go.  
(The motor does not come on unless the line is fed more than 1.1m.)

If above checks still do not improve the situation, please contact the retailer you purchased the reel from and explain the problem in detail.

# Product Inquiries /After Sales Service Information

Please include your telephone number when you send us an inquiry by mail.

It is easier to explain some reel mechanisms on the phone rather than in writing.

- When the reel needs repairing, please take it to the retailer you purchased it from together with the guarantee and the power cord. We need to know detail regarding the problem. (E.g. The stopper does not work.)

A charge will be made for the necessary replacement parts and labor. We cannot compensate for damaged or lost tackle arising from a damaged Shimano product and/or fishing trip expenses.

- If you wish to order a part or replacement spool, please order from the place of purchase or your nearest retailer, specifying product name, merchandise code/product code, part name/number as shown in the component diagram. (We recommend sending in the whole reel for the repair.)

Example/

Product Name: DENDOUMARU 9000 Beast Master

Product Code: 51RG299100G

Part Number: 2

Part Name: Handle

- Shimano retains fundamental parts (i.e. the parts necessary to maintain the function of the product) for fishing rod for up to 6 years after the manufacturing of a particular model is stopped. We may not accept a request for the repair if parts are not available. Some other minor parts may not be provided even if it is less than 6 years since the manufacturing of the product has been stopped.

## ● Product Code

The top five digits of the product code is recorded on the instruction manual, component diagram, and bottom or side of the package.

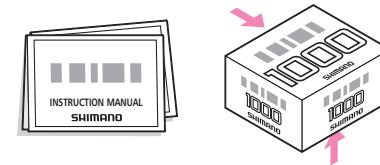

## SHIMANO

### SHIMANO EUROPE FISHING HOLDING B.V.

Industrieweg 24, 8071 CT Nunspeet, The Netherlands Phone: +31-341-272233

### SHIMANO GERMANY FISHING GMBH

Diessemer Bruch 114 F, 47805 Krefeld, Germany Phone: +49-2151-55670

### SHIMANO U.K. LTD.

Unit 1A, Vale Park Business Centre, Vale Park, Evesham, Worcestershire WR11 1GD, United Kingdom Phone: +44-1386-425824

### SHIMANO ITALY FISHING S.R.L.

Via Privata Maestri del Lavoro 29, 20025 Legnano Milano, Italy Phone: +39-0331-742711

### SHIMANO AMERICAN CORPORATION

One Holland, Irvine, CA 92618 U.S.A. Phone: +1-877-577-0600

### SHIMANO CANADA LTD.

427 Pido Road Peterborough, ON K9J 6X7, Canada Phone: +1-705-745-3232

### DUNPHY HOLDING PTY. LTD.

36 Bay Road, Taren Point, NSW 2229, Australia Phone: +61-2-9526-2144

### SHIMANO (SINGAPORE) PTE. LTD.

20 Benoi Sector, Jurong Town, Singapore 629852 Phone: +65-6265-4777

### SHIMANO INC.

3-77 Oimatsu-cho, Sakai-ku, Sakai City, Osaka 590-8577, Japan Phone: +81-72-223-3467

[www.shimano.com](http://www.shimano.com)



PRINTED IN JAPAN  
IMPRIME AU JAPON

11

# SHIMANO