

INSTRUCTION MANUAL

FIRST MADE FOR	SAP-KRV9, 12 18 and 22AG
MATERIAL OR MODEL	*PAPER-JO
DIMENSION OR MAKER	WOODFREE 55gm
COLOR	BLACK Print
NOTE	A4 SIZE

APPROVED BY
2010/OCT/31

CHECKED BY
N.Yamazaki
2010/OCT/31

DESIGNED BY
Andy Pui K. H.
2010/OCT/31

APPROVALS	DATE	REVISIONS	R.NO
△			
△			
△			
△			
△			
△			
△			
△			

DRAWN	REMARKS: SAPL ONLY	PART CODE 852-6-4181-189-00
		PART NAME INSTRUCTION MANUAL

SAP-KRV9AG & KRV9AP
SAP-KRV12AG & KRV12AP
SAP-KRV18AG & KRV18AP
SAP-KRV22AG & KRV22AP

COOL AND DRY MODEL

SANYO

INSTRUCTION MANUAL
Inverter-Controlled Split System Air Conditioner

**This air conditioner uses
the new refrigerant R410A.**

Save These Instructions!

Pub. OI-85264181 189 00

© SANYO 2010

SANYO Electric Co., Ltd.
Osaka, Japan

FEATURES

This air conditioner is an inverter type unit that automatically adjusts capability as appropriate. Details on these functions are provided below; refer to these descriptions when using the air conditioner.

 **24-hour Clock with ON/OFF Program Timer**
The remote control unit allows you to set a wide variety of timer-based operations including automatic ON/OFF with timer setting, same-time ON/OFF every day, ON timer, OFF timer and Combination timer.

 **Mild Dry**
By coupling the compressor and fan operation, intermittent drying can be precisely controlled according to room temperature so that air is efficiently dehumidified.

 **Auto Clean**
Fan operates when the unit is stopped to prevent the generation of mold and odors within the indoor unit.

 **Humanized Sleep Function**
Temperature gently rises or falls automatically to maintain comfortable room temperature, saving energy.

 **Rapid Cooling (Heating)**
The high-efficiency system cools quickly while maintaining high EER/COP.

 **Super Quiet**
Specially designed air vent efficiently reduces noise.

 **Turbo**
Powerfully cools the room.

 **Automatic Fan Operation**
Convenient microprocessor control automatically adjusts fan speed to High, Medium or Low, according to room temperature, to maintain a comfortable airflow throughout the room.

 **Air Sweep Control**
The air sweep function automatically moves the air outlet flap up and down, directing air in a sweeping motion around the room and ensuring comfort in every corner.

 **Automatic Restart Function for Power Failure**
Even when power failure occurs, preset programmed operation is reactivated once power resumes.

 **Self Diagnosis**
Error code is displayed for fast and easy maintenance, should a problem occur.

 **Low Voltage Startup (Min.198V)**
The unit starts safely even when the voltage is below the rated voltage.

 **Child Lock**
Remote controller keys are lockable to prevent misoperation.

 **Blue Fin**
Anti-corrosion blue fin is more effective than a common coil.

CONTENTS

	Page
FEATURES	2
PRODUCT INFORMATION	3
ALERT SYMBOLS	3
INSTALLATION LOCATION	3
ELECTRICAL REQUIREMENTS.....	3
SAFETY INSTRUCTIONS	3
1. USAGE POINTS	4
2. NAMES AND FUNCTIONS OF PARTS	6
3. OPERATION OF WIRELESS REMOTE CONTROL UNIT.....	7
4. CLEANING AND CARE	16
5. ADJUSTING THE AIRFLOW DIRECTION CORRECTLY	18
6. TROUBLESHOOTING	18

PRODUCT INFORMATION

If you have problems or questions concerning your Air Conditioner, you will need the following information. Model and serial numbers are on the nameplate on the bottom of the cabinet.

Model No. _____

Serial No. _____

Date of purchase _____

Dealer's address _____

Phone number _____

ALERT SYMBOLS

The following symbols used in this manual, alert you to potentially dangerous conditions to users, service personnel or the appliance:



WARNING

This symbol refers to a hazard or unsafe practice which can result in severe personal injury or death.



CAUTION

This symbol refers to a hazard or unsafe practice which can result in personal injury or product or property damage.

INSTALLATION LOCATION

- We recommend that this air conditioner be installed properly by qualified installation technicians in accordance with the Installation Instructions provided with the unit.
- Before installation, check that the voltage of the electric supply in your home or office is the same as the voltage shown on the nameplate.



WARNING

- Do not install this air conditioner where there are fumes or flammable gases, or in an extremely humid space such as a greenhouse.
- Do not install the air conditioner where excessively high heat-generating objects are placed.

Avoid:

To protect the air conditioner from heavy corrosion, avoid installing the outdoor unit where salty sea water can splash directly onto it or in sulphurous air near a spa.

ELECTRICAL REQUIREMENTS

1. All wiring must conform to the local electrical codes. Consult your dealer or a qualified electrician for details.
2. Each unit must be properly grounded with a ground (or earth) wire or through the supply wiring.
3. Wiring must be done by a qualified electrician.

SAFETY INSTRUCTIONS

- Read this Instruction Manual carefully before using this air conditioner. If you still have any difficulties or problems, consult your dealer for help.
- This air conditioner is designed to give you comfortable room conditions. Use this only for its intended purpose as described in this Instruction Manual.



WARNING

- Never use or store gasoline or other flammable vapor or liquid near the air conditioner — it is very dangerous.
- This air conditioner has no ventilator for intaking fresh air from outdoors. You must open doors or windows frequently when you use gas or oil heating appliances in the same room, which consume a lot of oxygen from the air. Otherwise there is a risk of suffocation in an extreme case.



CAUTION

- Do not turn the air conditioner on and off from the power mains switch. Use the ON/OFF operation button.
- Do not stick anything into the air outlet of the outdoor unit. This is dangerous because the fan is rotating at high speed.
- Do not let children play with the air conditioner.
- Do not cool or heat the room too much if babies or invalids are present.

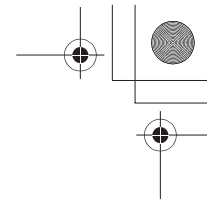
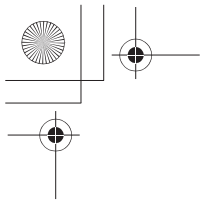

1. USAGE POINTS

1.1 Working Principle and Special Functions for Cooling

Principle:

An air conditioner (cooling) absorbs room heat and transmits and discharges it outdoors, thereby decreasing the ambient indoor room temperature. Its cooling capacity will decrease relative to an increase in the outdoor ambient temperature.

Anti-freezing Function:

If the unit is running in COOL mode and at a low temperature, frost will form on the heat exchanger; when the indoor heat exchanger temperature decreases to below 0°C, the micro-computer of the indoor unit will stop running the compressor to protect the unit.

1.2 Working Principle and Special Functions for Heating

** For Heatpump models Only **

Principle:

1. An air conditioner (heating) absorbs heat from outdoors and transmits it indoors, thereby increasing the indoor room temperature. Its heating capacity will decrease relative to a decrease in the outdoor ambient temperature.
2. If the outdoor temperature is lower than the room temperature, please operate the system with other heating/ventilating equipment.

Defrosting:

1. When the outdoor temperature is low and there is high humidity, after the unit runs for a while, frost will form on the outdoor unit and affect the heating function. At this time, the auto-defrosting function will turn on, and the heating operation will stop for 8-10 minutes.
2. While the auto-defrosting function is operating, both the fan motors of the indoor and outdoor units will stop operating.
3. While the defrosting function is operating, the indoor indicator flashes and the outdoor unit may emit vapor. This is due to the defrosting and is not a malfunction.
4. After defrosting has finished, the heating process will resume automatically.

Cold Draft Prevention:

In "HEAT" mode, the indoor blower will not act under the following 3 statuses, until the heat exchanger reaches a certain temperature. This is to prevent cool air from blowing. (Within 2 minutes)

1. When heating starts.
2. After auto-defrosting has finished.
3. Heating under low ambient temperature

Gentle Breeze:

Under the following conditions, the indoor unit may produce a gentle breeze, and the guide louver may rotate to a predetermined position:

1. In "Heat" mode with the unit turned on, until the compressor starts operating
2. In "Heat" mode with the temperature at the set value and the compressor has stopped running at about 1 minute.

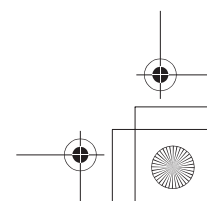
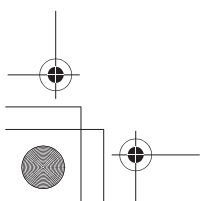
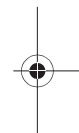

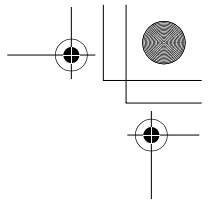
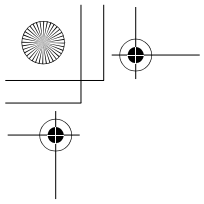

1. USAGE POINTS

1.3 Working Temperature Range

	Temperature	Indoor Air Temperature	Outdoor Air Temperature
COOLING	Max.	32°C DB / 23°C WB	43°C DB / 26°C WB
	Min.	19°C DB / 14°C WB	19°C DB

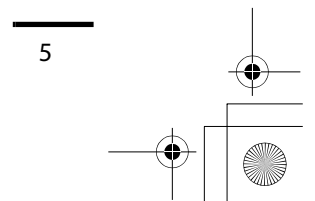
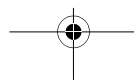
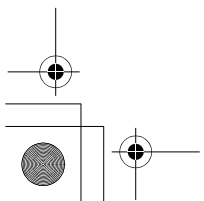
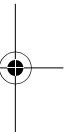
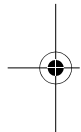

2. NAMES AND FUNCTIONS OF PARTS

Indoor Unit

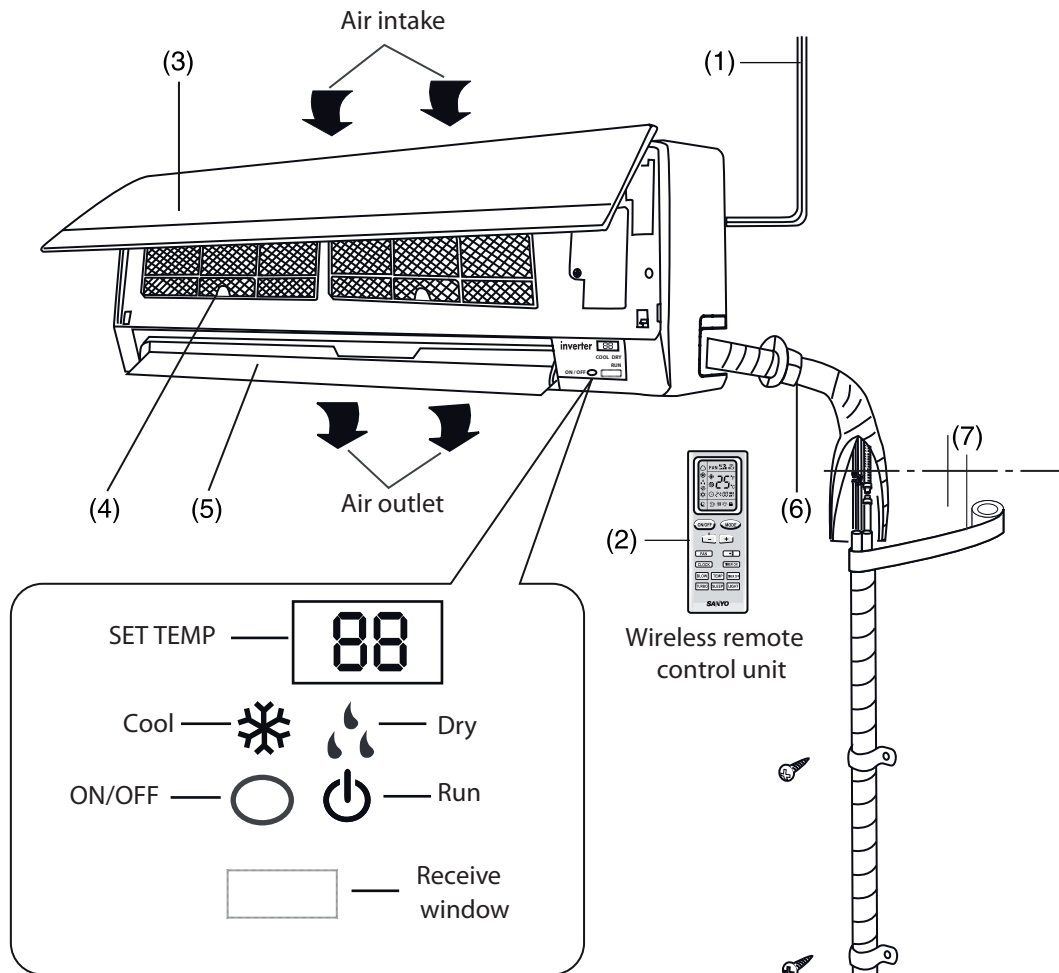

Outdoor Unit

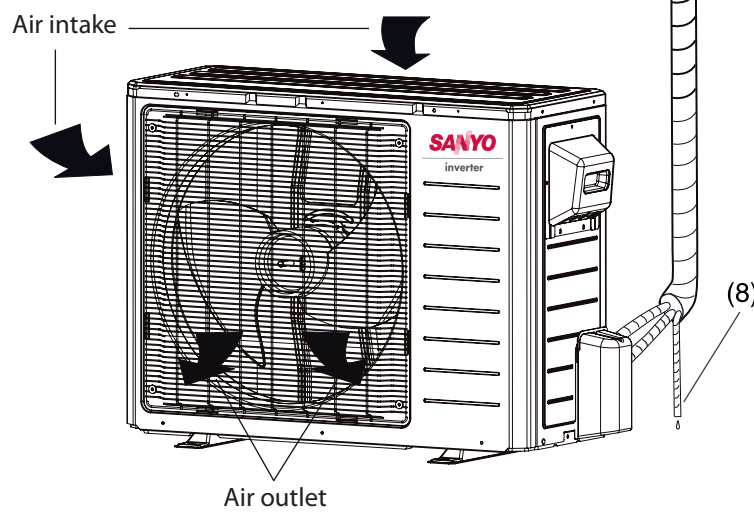

S/n	Part Name
(1)	Power cable
(2)	Remote control unit
(3)	Front panel
(4)	Filter
(5)	Guide louver
(6)	Wall pipe
(7)	Bind tape
(8)	Drainage pipe

3. OPERATION OF WIRELESS REMOTE CONTROL UNIT

3.1 Remote Control Unit (Display)

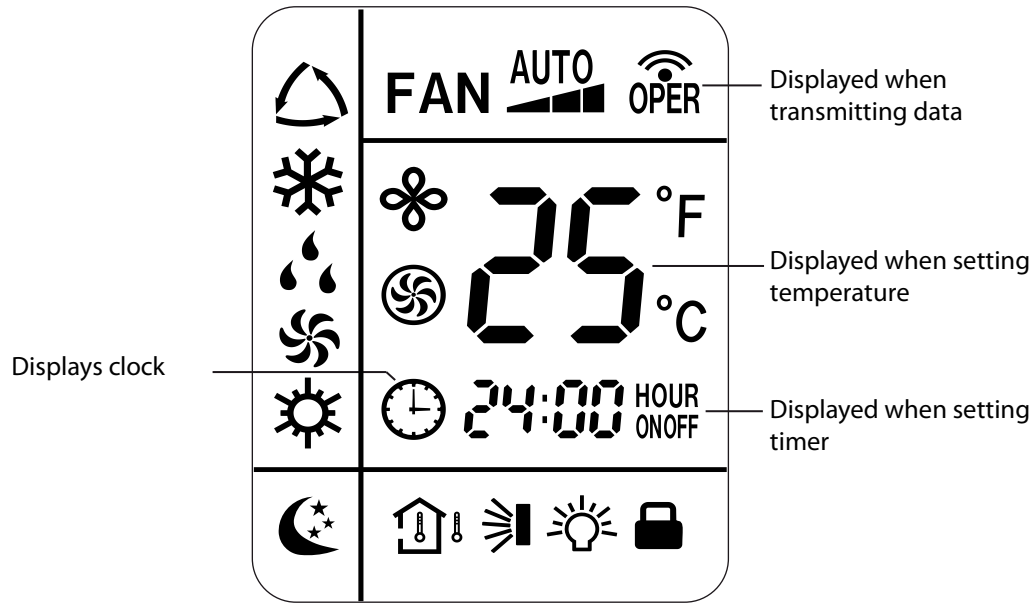

Symbols

(1) Operation mode		(4) Timer	
AUTO		24-hour ON Timer	
COOL		24hour OFF Timer	
DRY		(5) Sleep	
FAN		(6) Confirmation of transmission.....	
HEAT (for Heatpump models only).....		(7) Clock indication	
(2) Fan speed		(8) Sweep indication	
Automatic operation		(9) Light	
HIGH		(10) Blow	
MID.....		(11) Turbo	
LOW		(12) Temperature	
(3) Set temperature		(13) Lock.....	
16 – 30°C			
When set to 23 °C			

3. OPERATION OF WIRELESS REMOTE CONTROL UNIT

3.2 Remote Control Unit Functions

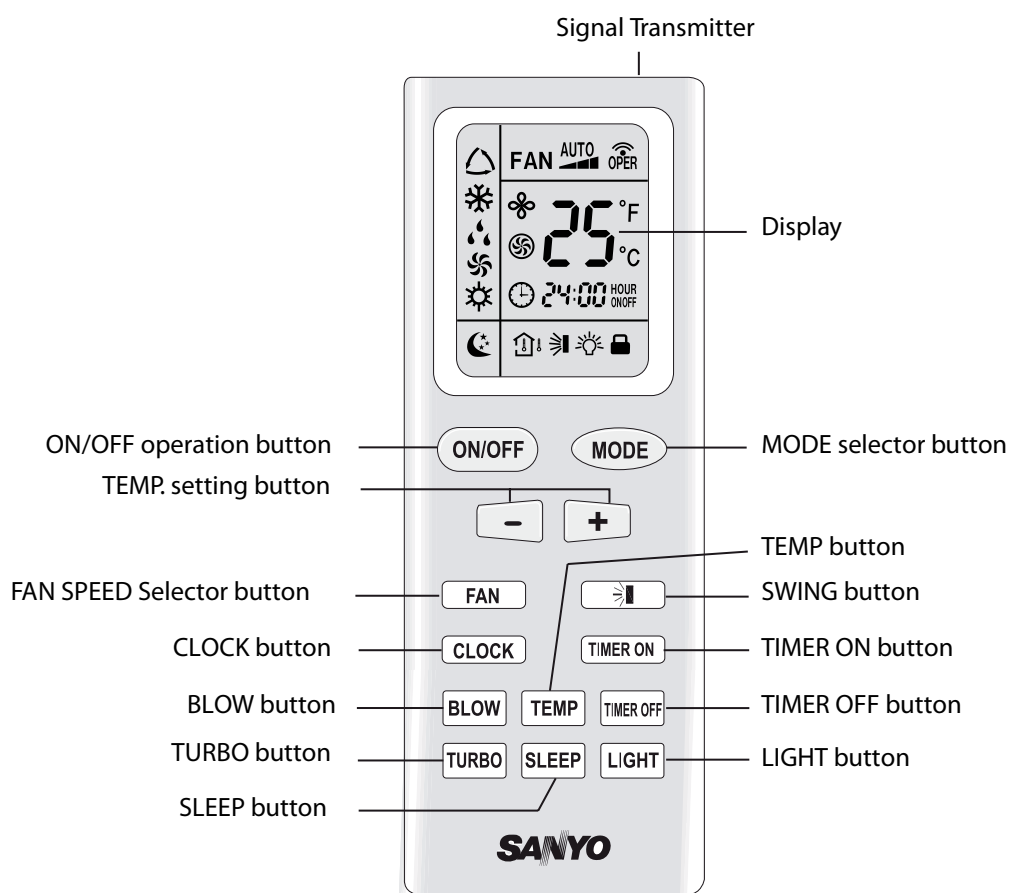

Transmitter	When you press the buttons on the remote control unit, the mark appears in the display to transmit the setting changes to the receiver in the air conditioner.
Display	Information on the operating conditions is displayed while the remote control unit is turned on. If the unit is turned off, only the current time and the operation mode temperature that has been set are displayed.
ON/OFF operation button	This button is for turning the air conditioner ON and OFF.
MODE selector button (AUTO) (COOL) (DRY) (FAN) (HEAT) (+) / (-) setting buttons	To select "AUTO" "COOL" "DRY" "FAN" or "HEAT" mode. : In this setting, the air conditioner calculates the difference between the thermostat setting and the room temperature and automatically switches to appropriate running mode. : The air conditioner makes the room cooler. : The air conditioner reduces the humidity in the room. : The air conditioner runs the indoor fan only. : The air conditioner makes the room warmer. (** only for Heatpump models **) : Press the (+) button to increase the set temperature; continue pressing for two seconds to quickly increase the set temperature. : Press the (-) button to reduce the set temperature; continue pressing for two seconds to quickly reduce the set temperature.
LOCK / UNLOCK button	: Simultaneously press the button to lock or unlock the wireless remote control unit.
TIMER ON button	ON : The air conditioner starts at the set time.
TIMER OFF button	OFF : The air conditioner stops at the set time.

3. OPERATION OF WIRELESS REMOTE CONTROL UNIT

3.2 Remote Control Unit Functions (Continued)

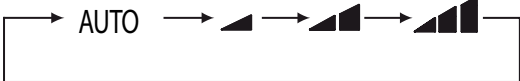
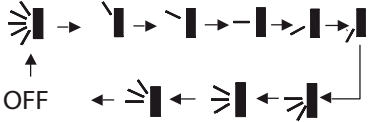
<p>FAN SPEED selector button</p>	<p>AUTO : The air conditioner automatically decides the fan speeds.</p> <ul style="list-style-type: none"> ▀ : Low fan speed. ▄ : Medium fan speed. ▄▄ : High fan speed. 
<p>TEMP button</p> <p style="text-align: right;">NOTE</p>	<p>Press to see the set temperature or indoor temperature that are displayed on the indicator lamp.</p> <ul style="list-style-type: none"> 🏠 : Display the preset temperature. 🏠 : Display the indoor ambient temperature (5 seconds) The ambient temperature will be displayed for 5 seconds, following which the preset temperature will be displayed. 🏠 : Current displaying status will not be changed. No Icon : Default display of preset temperature.
<p>BLOW button</p>	<p>Press to start or stop indoor fan drying indoor components. This function is applicable to "COOL" & "DRY" mode only. In "AUTO," and "FAN mode," "BLOW" function is not available and "BLOW" is not displayed.</p>
<p>LIGHT button</p>	<p>Press this button to turn ON/OFF indicator light display.</p>
<p>TURBO button</p>	<p>Press to quickly cool or heat the room with powerful cool or hot air.</p>
<p>SLEEP button</p>	<p>For details, see "SLEEP MODE" (page 12). When you press this button in the "DRY," "COOL" or "HEAT" mode, the 🌙 mark appears in the display and the remote control unit will automatically adjust the set temperature to save energy.</p>
<p>CLOCK Button</p>	<p>Use this button to set the clock.</p> <p>How it Works</p> <p>Press the CLOCK button once if the 🕒 indicator is not flashing. The 🕒 indication alone flashes. Within 5 seconds, press the +/- button. The time can be set in 1-minute increments. Holding down the button advances the time rapidly in 10-minute increments. Press the CLOCK button again. The 🕒 is displayed, completing the setting of the current time.</p>
<p>SWING Button</p> <p style="text-align: right;">NOTE</p>	<p>Sets the air swing direction to change circularly as below:</p>  <p>When the guide louver begins swinging up and down, if swing is turned off, the air guide louver will stop at the current position. (refer to page 14 for more details)</p>

3. OPERATION OF WIRELESS REMOTE CONTROL UNIT

3.3 General Operation

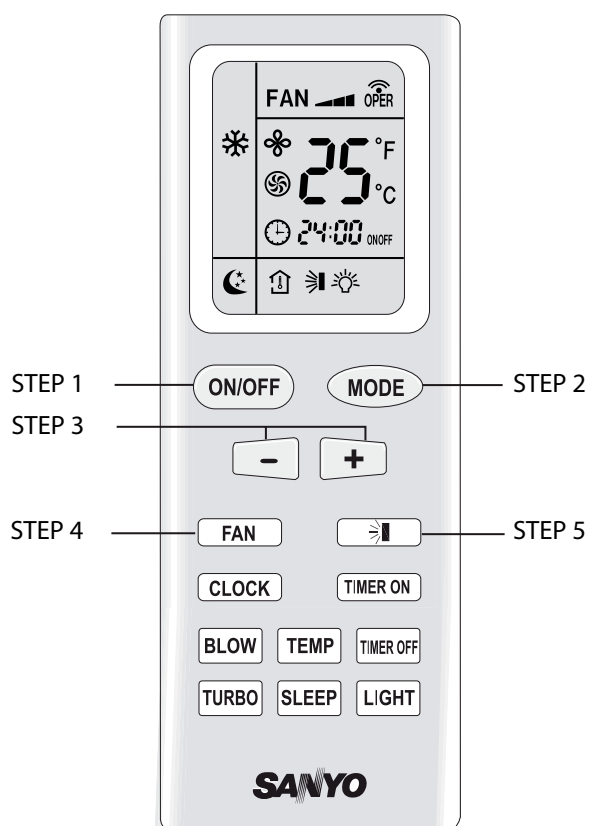

NOTE Press the setting buttons as described below and change the settings as desired.

STEP 1	To start the air conditioner, press the ON/OFF operation button.
STEP 2	Press the MODE selector button and select the desired mode. For DRY operation → For COOLING operation → For FAN only operation → For AUTO operation → For HEATING operation → (** Only for Heatpump models **)
STEP 3	Press the TEMP. setting buttons to change the temperature setting to the desired temperature. Adjustable temperature range: 30°C (86°F) max.—16°C (61°F) min. In "AUTO" mode, the temperature cannot be adjusted. In "HEAT" mode, the initial value is 28°C (82°F). (** Only for Heatpump models **) In other operation, the initial value is to 25°C (77°F).
STEP 4	Set the FAN SPEED selector button to the desired setting. AUTO: Auto fan speed. : Low fan speed. : Middle fan speed. : High fan speed. NOTE In Dry mode, the fan speed is automatically set to LOW.
STEP 5	Press the button and set the air-blow direction, as desired or automatically.

To STOP the air conditioner, press the ON/OFF operation button again.

3. OPERATION OF WIRELESS REMOTE CONTROL UNIT

3.4 Using the 24-Hour "ON" or "OFF" Timer

3.4.1 TIMER ON Mode (Example)

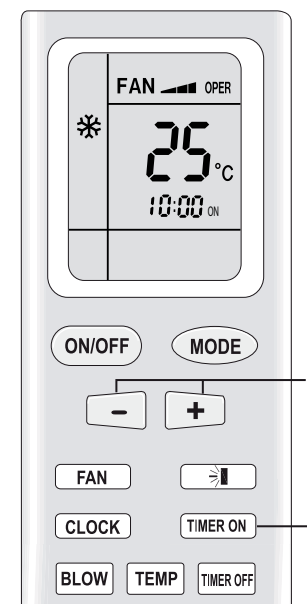

After the length of time set for TIMER ON elapses, the unit begins operating.
 The display depicted at left indicates that the air conditioner will begin operating in 10 hours.
 Setting procedure:

STEP 1	Press the "ON/OFF" button and "MODE" button to set the desired operation mode. (See "Operation with the Remote Control Unit", page 8). Press the "ON/OFF" button again to turn off the unit.
STEP 2	Press the "TIMER ON" button.
STEP 3	Press the "TIMER ON" button (which advances the clock displayed) to set the time at which you want operation to begin. The time can be set for one-minute intervals for 24 hours. Holding down the (+) / (-) button will rapidly change the time value. Press the "TIMER ON" button again to confirm the set time is 10 A.M.

- The display changes immediately to the current time, but ON indication remains.

Cancellation procedure: Press the "TIMER ON" button again to cancel

3.4.2 TIMER OFF Mode (Example)

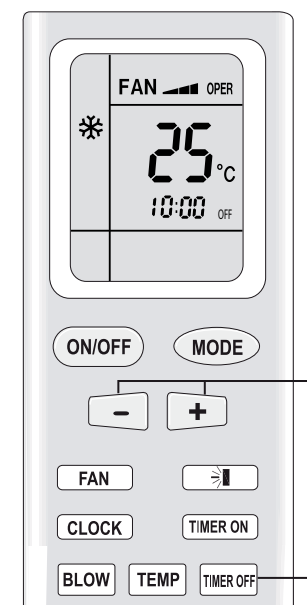

After the length of time set for TIMER OFF elapses, the unit stops operating.
 The display depicted at left indicates that the air conditioner will stop operating in 10 A.M.
 Setting procedure:

STEP 1	Press the TIMER OFF button.
STEP 2	Press the "TIMER OFF" button (which advances the clock displayed) to set the time at which you want operation to stop. The time can be set for one-minute intervals for 24 hours. Holding down the (+) / (-) button will rapidly change the time value. Press the "TIMER OFF" button again to confirm the off time is 10 A.M.

- The display changes immediately to the current time, but OFF indication remains.

Cancellation procedure: Press the "TIMER OFF" button again.

3. OPERATION OF WIRELESS REMOTE CONTROL UNIT

3.5 SLEEP Operation

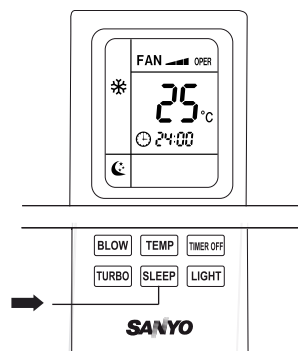

SLEEP Mode is used for saving energy.
Press the SLEEP button while operation is on.
The  mark appears in the display.

To release the SLEEP function, press the SLEEP button again.

3.5.1 In Cooling and DRY Modes: (and)

When the SLEEP mode is selected, the air conditioner automatically raises the temperature setting 1°C when 1 hour has passed after the selection was made, and then another 1°C after another 1 hour have passed, regardless of the indoor temperature when SLEEP was selected. The unit will maintain this temperature. This enables you to save energy without sacrificing comfort. This function is convenient when gentle cooling is needed.

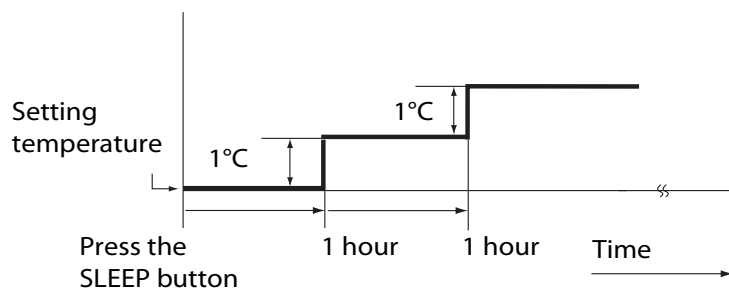

3.5.2 In Heating Mode: ()

** (Only for Heatpump Models) **

When the SLEEP mode is selected, the air conditioner automatically lowers the temperature setting 1°C when 1 hour has passed after the selection was made, and then another 1°C after another 1 hour have passed, regardless of the indoor temperature when SLEEP was selected. The unit will maintain this temperature. This enables you to save energy without sacrificing comfort. This function is convenient when gentle heating is needed.

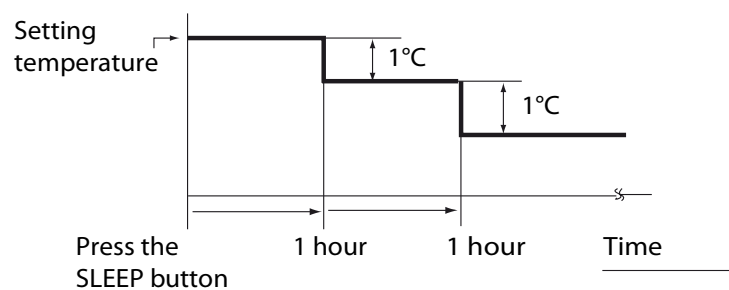

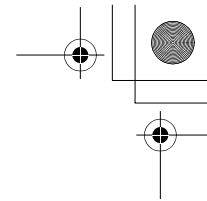
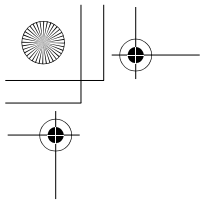

3. OPERATION OF WIRELESS REMOTE CONTROL UNIT

3.6 "SPECIAL" Features

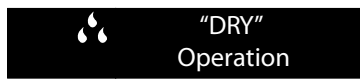

How it works

- During DRY operation, the fan speed is automatically set to LOW.
- If the room temperature is 2°C higher than the Set Temperature, the unit will run in COOL mode.
- Once the room temperature reaches ± 2°C of the level that was set, the unit automatically repeats the cycle of compressor turning "ON" for 6 minutes and turning "OFF" for 4 minutes.

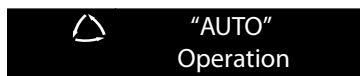

How it works

- When AUTO mode is selected, the default temperature will be displayed on the LCD, and the unit will automatically adjust to the room temperature, selecting the appropriate operation method and ambient comfort.

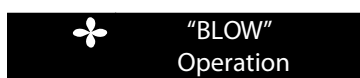

How it works

This function indicates that moisture on the evaporator of the indoor unit will be dispersed after the unit is stopped to avoid the formation of mold. Once the blow function resumes, the indoor fan will continue running for about 10 minutes at low speed even after the unit is turned off by pressing the ON/OFF button, in which case, pressing the "BLOW" button again will immediately stop the indoor fan.

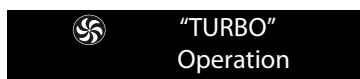

How it works

In "COOL" or "HEAT" mode, if this function is selected, the unit will run at super-high fan speed to cool or heat rapidly to enable the ambient temperature to approach the preset temperature as quickly as possible.

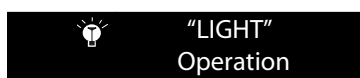

How it works

This special button is intended for users who are not accustomed to light while sleeping.

Setting the display indicator light to "ON"

When setting the light function, pressing this button will display the mark  on the remote control unit screen. The display indicator light will be turn on if the air conditioner receives this signal.

Setting the display indicator light to "OFF"

Canceling the light function will cause the mark  to disappear from the remote control unit screen. The display indicator light will be turn off if the air conditioner receives this signal.

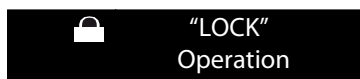

How it works

Press "+" and "-" buttons simultaneously to Lock/Unlock the keyboard. If the remote control unit is locked, the  will be displayed. In this case, press any button and the mark will flicker three times. If the keyboard is unlocked, the mark will be disappear.

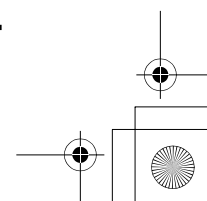
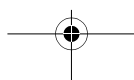
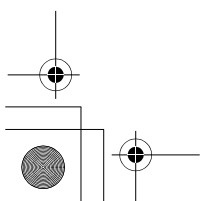
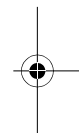

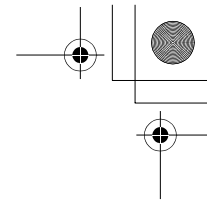
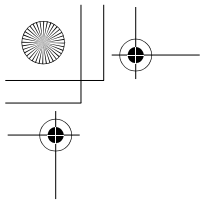



3. OPERATION OF WIRELESS REMOTE CONTROL UNIT

3.6 "SPECIAL" Features (Continued)

"SWING" Operation

How it works

About swing up and down

1. Pressing the swing up and down button continuously for at least 2 seconds will cause the main unit to swing back and forth from up to down. Release the button, and the unit will immediately stop swinging and maintain the current position of the guide louver.
2. In swing up and down mode, when the status is switched from off to , if this button is pressed again 2 seconds later,  status will immediately switch to off status; if pressed again within 2 seconds, swing status change will depend on the circulation sequence outlined below:

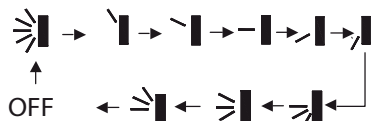

"°F" / "°C" Operation

How it works

To switch between Fahrenheit and Centigrade, in unit off status, press "MODE" and "-" buttons simultaneously and then release both buttons immediately to switch between °C and °F.

Power Failure During Operation

How it works

In the event of power failure, the unit will stop operation. When power resumes, the unit will restart automatically after three minutes.

"H1" DEFROSTING Operation

How it works
(** Only for Heatpump models **)

When the unit is in defrost status, "H1" will show on the display indicator board. Even if the unit is turned off with the remote control unit, the unit will not stop defrosting until completed. If there is any change in the set mode with the remote control unit, any new function that is set will not initiate until the defrosting process is finished.

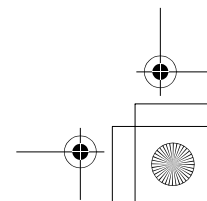
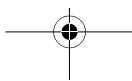
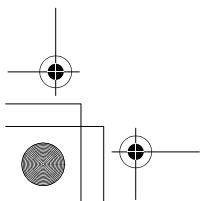
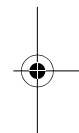
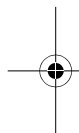

3. OPERATION OF WIRELESS REMOTE CONTROL UNIT

3.7 How to Remove and Install Batteries

1. Lightly press the place marked  in the direction of the arrow to remove the back cover of wireless remote control unit. (Fig. 1)
2. Remove the old batteries. (Fig. 1)
3. Insert two new AAA1.5V dry batteries, paying close attention to their polarity. (Fig. 2)
4. Reattach the back cover. (Fig. 2, procedure 4)

NOTE

- The batteries should last about six months. Replace the batteries when the remote control unit's display fails to light, or when the remote control unit fails to change the air conditioner's settings.
- When changing the batteries, do not use old or incorrect batteries. Use two new leak-proof type-AAA alkaline batteries to avoid causing malfunction of the wireless remote control unit.
- If the wireless remote control unit will not be used for more than one month, remove the batteries to avoid leaking liquid damaging the wireless remote control unit.
- The wireless remote control unit should be placed more than 1 m away from the TV set or stereo sound sets.
- If the remote control unit can not operate normally, please remove and then reinsert the batteries 30 seconds later. If it still cannot operate, change the batteries to new ones.
- The remote control signal can be received up to a distance of about four meters.
- Dispose of used batteries at a designated location in compliance with the applicable local ordinances.

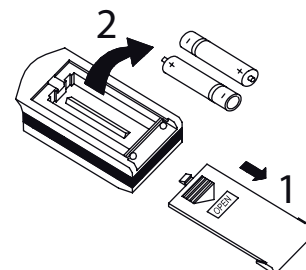

Fig. 1

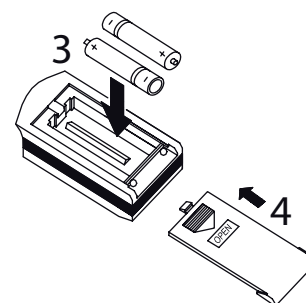

Fig. 2

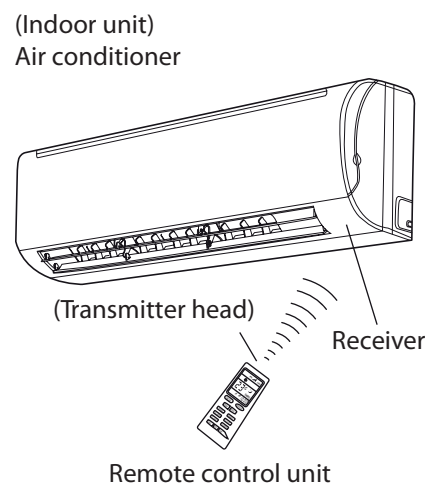

Fig. 3

3.8 Using the Remote Control Unit

When using the remote control unit, always point the unit's transmitter head directly at the air conditioner's receiver. (Fig. 3)

3.9 Emergency Operation

If the wireless remote control unit is lost or broken, please use the manual switch button. In this case, the unit will run in the "AUTO" mode, but the temperature and fan speed cannot be changed. (Fig. 4)

To open the panel, the manual switch is located on the display box. The operation is shown below:

- Turn "ON" the Unit:
By pressing the button, the unit will immediately run in Auto mode. The microcomputer will select "COOL," or "FAN" mode relative to the indoor temperature and produce a comfortable ambience.
- Turn "OFF" the Unit:
By pressing the button, the unit will stop working.

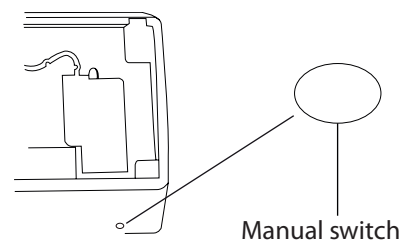

Fig. 4

4. CLEANING AND CARE



1. For safety, be sure to turn the air conditioner off and also disconnect the power before cleaning. Or it may cause an electric shock.
2. Never sprinkle water on the indoor unit and the outdoor unit for cleaning because it can cause an electric shock.
3. Volatile liquid (e.g. thinner or gasoline) will damage the air conditioner. (So wipe the units with a dry soft cloth or a cloth slightly moistened with water or cleanser.)

4.1 Clean the Front Panel

(Make sure to remove the front panel before cleaning it.)

1. Remove the Front Panel

Open the front panel until it is nearly horizontal, grasp the sections near the front panel arms on both sides, and then remove the panel by pushing the arms towards the inside while pulling the panel towards you. (Fig. 4a, 4b)

2. Washing

Clean with a soft brush, water and neutral detergent, and dry with a clean soft cloth. (Fig. 5)

NOTE Do not use water hotter than 45°C to prevent fading or deformation.

3. Replace the Front Panel

Grasp the sections near the front panel arms on both sides, and hold the front panel so that it is nearly horizontal. Push the arm shafts towards the inside so that they come into contact with the top of the indentations on the right and left sides of the air conditioner. Then push firmly until the arm shafts click into place. (Fig. 6a)

- NOTE**
- The arm at the center of the front panel slides into the groove at the front of the unit. (Fig. 6b)
 - After closing the front panel, press firmly on the panel to securely fasten the panel in place.

4.2 Cleaning the Air Filters

(Recommended once every 3 months)



1. After removing the filter, some metal edges and the fins are sharp and may cause injury if handled improperly; be especially careful when cleaning these parts.
2. The internal coil and other components of the outdoor unit must be cleaned every year. Consult your dealer or service center.

- NOTE**
1. There are microcomputer components and circuit diagram on the LCD of the front panel.
 2. If dust is significant around the air conditioner, the air filters should be cleaned more often.

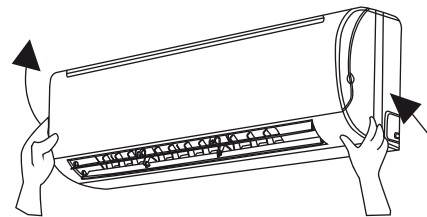

Fig. 4a

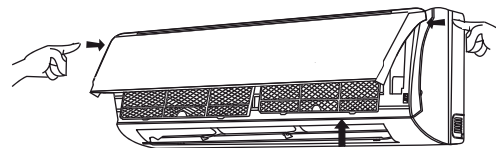

Fig. 4b

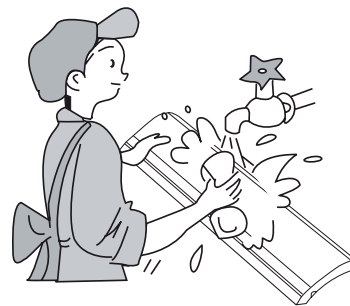

Fig. 5

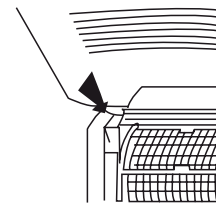

Fig. 6a

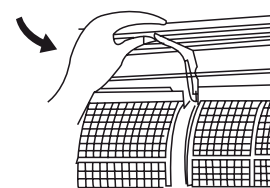

Fig. 6b

4. CLEANING AND CARE

4.2 Cleaning the Air Filters (Continued)

1. Remove the Air Filters

Pull out the panel at the angle of the bottom grooves on the panel. Next, pull the air filter upward then downward to remove it. (Fig. 7).

2. Cleaning

To clean dust adhering to the filters, either use a vacuum cleaner, or wash them with warm water (water with neutral detergent should be below 45°C) when the filters are very dirty (e.g., oil-stained), and dry them in the shade. (Fig. 8)

NOTE Do not use hot water of temperatures above 45°C to prevent fading or deformation. Do not use fire to dry the filter, to avoid fire or deformation.

3. Install the Air Filters

Insert the top of the air filter, and then fit the protrusions on the bottom of the filter all the way into the hooks on the unit.

Press the locations marked by the arrows and close the front panel. (Fig. 9)



WARNING

Since the air filter cannot remove harmful gases or vapors nor ventilate the room, open doors or windows frequently when using gas or oil heating appliances. Not doing so carries a risk of suffocation in extreme cases.

4.3 Check Before Using

1. Be sure that nothing obstructs the air outlet or intake vents. (Fig.10)
2. Check whether ground wire is properly connected or not.
3. Check whether the batteries of the air conditioner have been changed or not.
4. Check whether the installation stand of the outdoor unit is damaged or not. If damaged, please contact the dealer.

4.4 Maintenance After Use

1. Turn main power off.
2. Clean the filter, indoor and outdoor units.
3. Clear dust and obstructions from the outdoor unit.
4. Remove and repaint over any rust on the outdoor unit in order to prevent it from spreading.

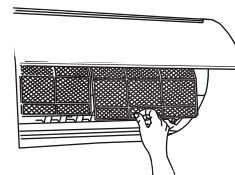

Fig. 7

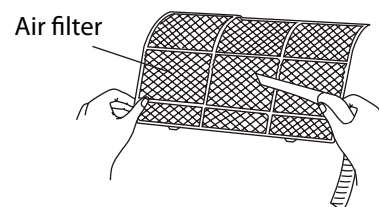

Fig. 8

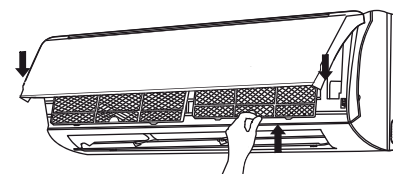

Fig. 9

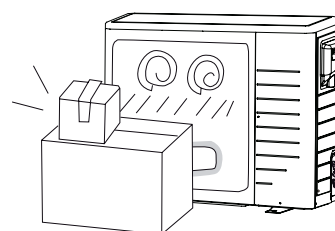
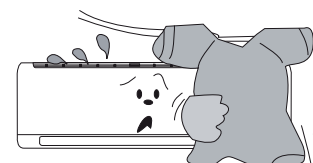

Fig. 10

5. ADJUSTING THE AIRFLOW DIRECTION CORRECTLY

1. Horizontal

The horizontal airflow can be adjusted by moving the louver with your hand to the left or right.



When the humidity is high, the vertical vanes should be in the front position during the cooling or dehumidifying operation. If the vertical vanes are positioned all of the way to the right or left, condensation may begin to form around the air vent and drip down.

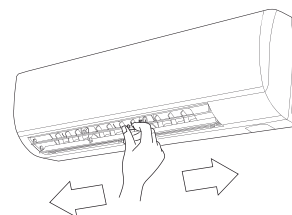

2. Vertical

The vertical airflow can be adjusted by moving the flap with the remote control unit.

Use the SWING button to set either the auto sweep or set to the recommended position.



- Use the SWING button on the remote control unit to adjust the position of the flap. If you move the flap by hand, the flap position according to the remote control and the actual flap position may no longer match. If this should happen, shut off the unit, wait for the flap to close, and then turn on the unit again; the flap position will now be normal again.
- Do not have the flap pointed down during cooling operation. Condensation may begin to form around the air vent and drip down.

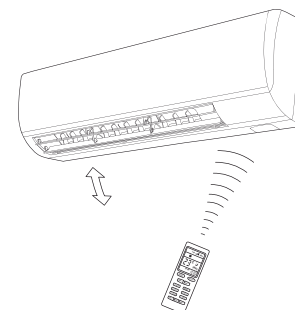

6. TROUBLESHOOTING



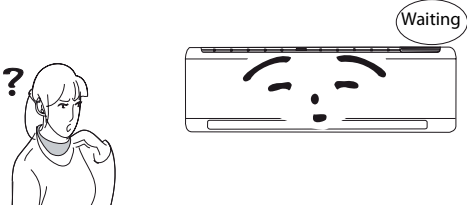

Do not attempt to repair the air conditioner by yourself, as this can cause an electric shock or fire. Please check the following items before asking for repairs, as this can save time and money.

Problem	Solution
<p>Does not operate immediately when the air conditioner is restarted.</p> 	<p>When the air conditioner is restarted immediately after being turned off, the overload protection switch will delay starting for three minutes.</p>

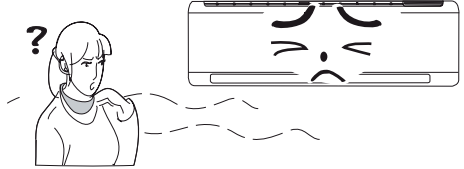
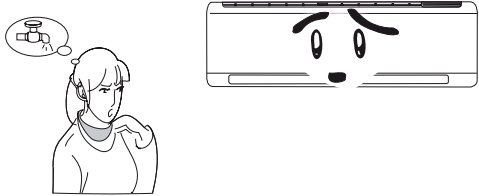
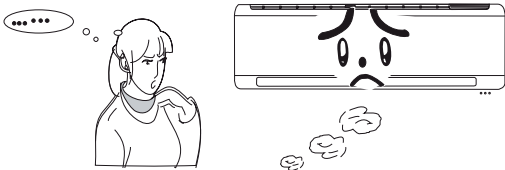
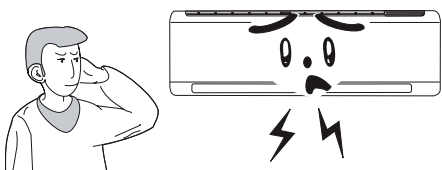
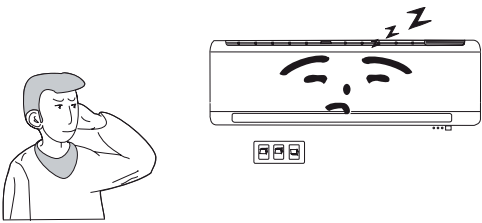
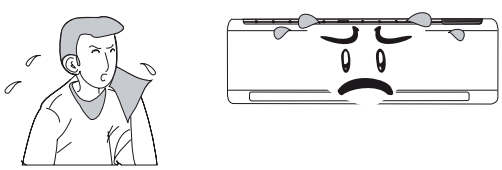
6. TROUBLESHOOTING

Problem	Solution
<p>An unusual odor is emitted from the outlet after operation is started.</p> 	<p>Clean the air filters (see page16). If the problem persists, the unit requires servicing. Please contact your authorized SANYO maintenance center.</p>
<p>Sounds of water flowing can be heard during operation.</p> 	<p>Occasionally there is a swooshing or gurgling sound when the air conditioner is started, stopped or when the compressor has started or stopped running. These sounds are due to refrigerant flowing and are not malfunctions.</p>
<p>Mist is emitted.</p> 	<p>When the indoor temperature and humidity are high, sometimes this phenomenon occurs. It is caused by the room air being swiftly cooled down. After running for a while, the indoor temperature and humidity will decrease, and the mist will disappear.</p>
<p>A creaking noise can be heard when starting or stopping the unit.</p> 	<p>This is caused by the deformation of plastic due to the change of temperature.</p>
<p>The unit will not operate.</p> 	<ul style="list-style-type: none"> • Has the power been turned off? • Is the power plug loose? • Is the voltage too high or too low? (Please ask a qualified service representative to check the voltage.) • Has the TIMER ON function been correctly operated?
<p>Cooling (Heating) efficiency is inadequate.</p> 	<ul style="list-style-type: none"> • Is the temperature setting appropriate? • Are the inlet or outlet vents obstructed? • Is the filter dirty? • Are the windows and doors closed? • Is the fan speed set to low? • Are there any heat sources in the room?

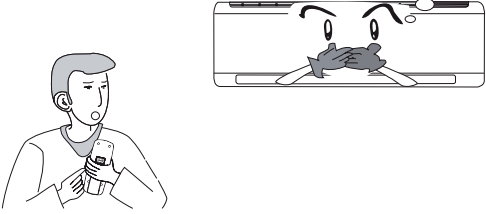
6. TROUBLESHOOTING

Problem	Solution
<p>Remote control unit does not work.</p> 	<ul style="list-style-type: none"> • If the unit is experiencing abnormal interference or the functions are being changed too frequently, wireless remote control unit may not work properly. Pulling out and firmly re-inserting the power plug should reestablish normal operation. • Is the remote control unit pointed at the receiver? Is there any obstruction? • Check if the batteries in the control unit are correct; if not, insert the correct batteries.
<p>There is water leakage from the indoor unit.</p>	<ul style="list-style-type: none"> • The air humidity is on the high side. • Condensed water has overflowed. • The indoor unit drainage pipe connection is loose.
<p>There is water leakage from the outdoor unit.</p>	<ul style="list-style-type: none"> • When the unit is operating in COOL mode, condensation will form at the connection of pipe and pipe joint due to the water being cooled down.
<p>Noise is emitting from the indoor unit.</p>	<ul style="list-style-type: none"> • This is a fan or compressor relay switching (On/OFF) sound. • When the unit is defrosting or has stopped running, sound will be emitted due to the refrigerant flowing in the opposite direction.
<p>The indoor unit does not produce airflow.</p>	<ul style="list-style-type: none"> • In dehumidifying “” mode, the indoor fan sometimes stops in order to avoid recondensation.
<p>Moisture forms on the air outlet vent.</p>	<ul style="list-style-type: none"> • If the unit is operating in high humidity for long periods of time, moisture will condense on the air outlet grill and drip off.

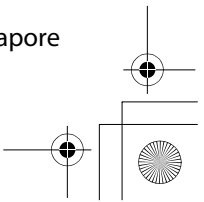
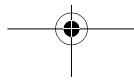
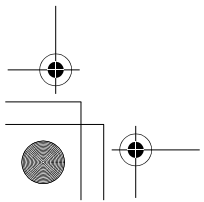
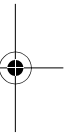
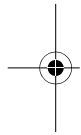
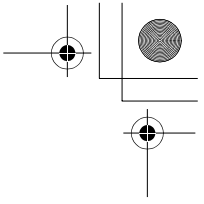
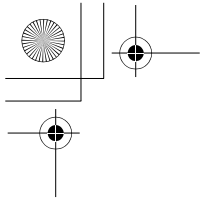

SANYO

SANYO Electric Co.,Ltd
SAPL
10/10 Printed in Singapore