

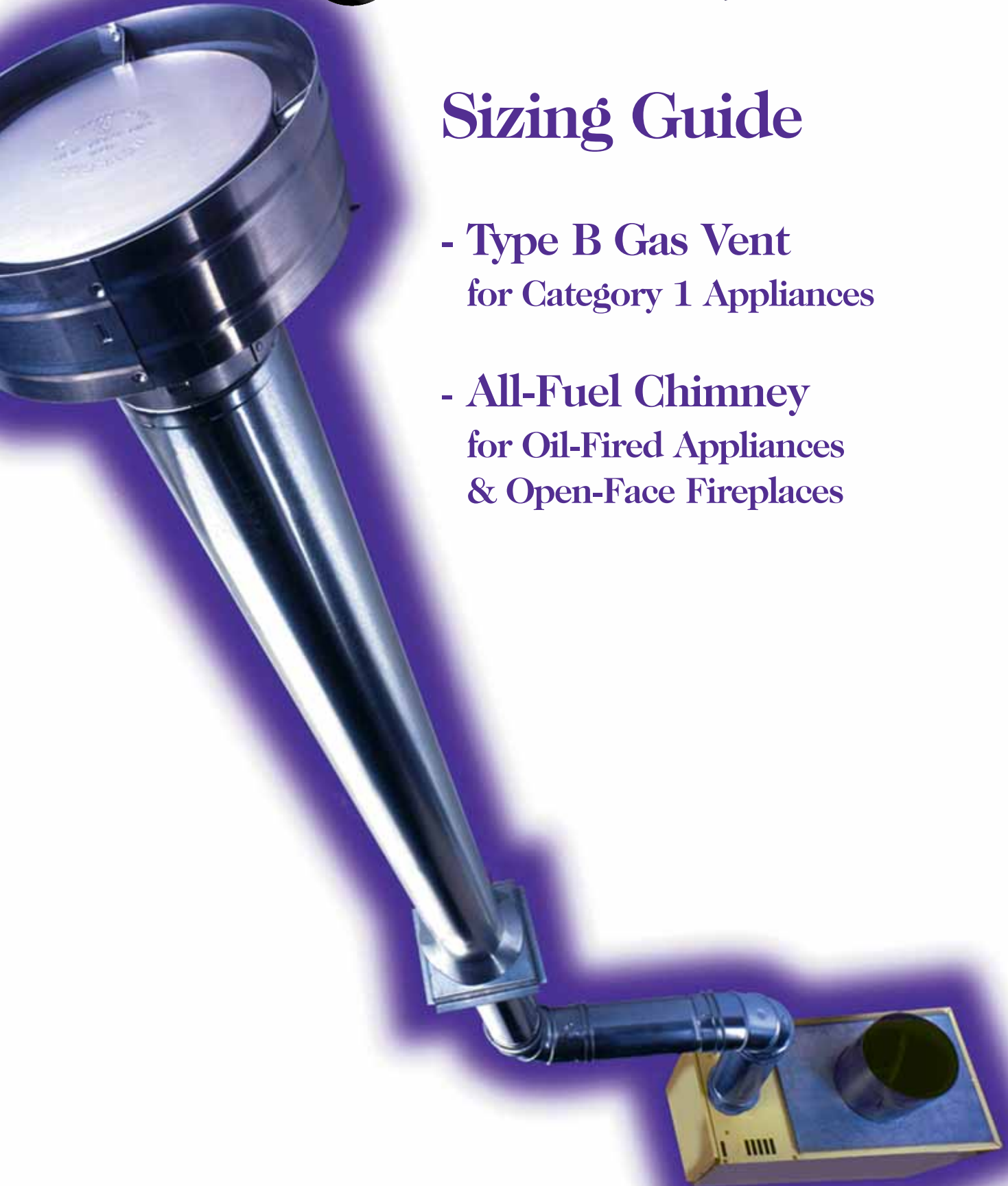

**Hart & Cooley**<sup>®</sup>  
*install confidence*

## Sizing Guide

- **Type B Gas Vent**  
for Category 1 Appliances
- **All-Fuel Chimney**  
for Oil-Fired Appliances  
& Open-Face Fireplaces





**Hart & Cooley**  
*install confidence*

Hart & Cooley, Inc. 800.433.6341 *p*  
5030 Corporate Exchange Blvd. SE 616.656.8200 *p*  
Grand Rapids, MI 49512 800.223.8461 *f*  
info@hartcool.com 616.656.6399 *f*  
www.hartandcooley.com

**Order information:**

To order Hart & Cooley products,  
please contact any authorized  
Hart & Cooley distributor or  
call 800.433.6341.

When you purchase Hart & Cooley products, you  
also receive the full support of Hart & Cooley  
technical and customer service.

**Technical and customer service:**

800.433.6341 *toll-free*  
616.656.8200 *phone*  
800.223.8461 *toll-free fax*  
616.656.6399 *fax*

**Internet address:**

<http://www.hartandcooley.com>

**Install confidence with these other quality**

**Hart & Cooley products available:**

- Registers, Grilles & Diffusers
- Type B Gas Vent Systems
- Special Gas Vent
- Model TLC All-Fuel Chimney
- Duct System Components
- Flexible Duct Systems

# Table of Contents

	<b>Page</b>
<b>Section 1</b>	
<b>Type B Double-Wall Gas Vent Systems</b>	<b>3</b>
General Rules	4
<b>Types of Systems and Definitions</b>	<b>7</b>
Single-Appliance Vents	8
Multiple-Appliance Vents	13
Multiple-Story Venting	19
<b>Section 2</b>	
<b>Factory-Built All-Fuel Chimney Systems</b>	<b>23</b>

## Foreword

This Guide is a compilation of the system design and application procedures for all Hart & Cooley® Gas Venting and Chimney products. The first section is specifically devoted to the design of Double-Wall Type B Gas Vent Systems for use with equipment certified by the American Gas Association or Canadian Gas Association for use with B Vent.

This Guide has been prepared not only for the convenience and assistance of contractors but also for the assistance of building inspectors, engineering firms and architects, as well as for training.

The basis for the material in this Guide is the standard engineering application of the scientific laws for the behavior of fluid flow and heat transfer. In addition, these methods have been proved valid by many decades of field and laboratory experience by engineers, in design and application, and utilities and code authorities.

Additional references for the development of the material in this Guide were from the following:

*National Fuel Gas Code, NFPA Standard 54 ANSI Z223.1*

*Standard for the Installation of Oil-Burning Equipment 2006 Edition, NFPA 31*

*American Society of Heating, Refrigerating and Air Conditioning Handbook, Equipment*

*International Mechanical Code*

The capacities given in the Tables for Type B Gas Venting are consistent with those found in publications by the appliance manufacturers and NFPA 54 National Fuel Gas Code.

The capacities given in Section 2 tables for all-fuel chimney are consistent with those found in NFPA 31, Standard for Oil-Burning Equipment.

For information on products for use with the systems designed by use of this Guide, refer to the various specific product literature.

**NOTE:** THIS GUIDE SHOULD BE USED IN ADDITION TO, NOT AS REPLACEMENT FOR, HART & COOLEY® INSTALLATION INSTRUCTIONS.

**CAUTION:** ALWAYS READ AND COMPLY WITH THE MANUFACTURER'S INSTALLATION INSTRUCTIONS SUPPLIED WITH THE APPLIANCE.

## **Type B Double-Wall Gas Vent Systems**

**General Rules**

**Types of Systems and Capacity Tables**

Single-Appliance Vents

Multiple-Appliance Vents

Multiple-Story Venting

# Type B Double-Wall Gas Vents

## Systems

The Tables given in Section 1 apply to system design using Hart & Cooley® Type B Gas Vents and to Model TLC Chimneys when used for venting listed Category I gas-fired, draft-hood-equipped or fan-assisted combustion appliances. At no time should a venting system for a listed Category II, III, or IV appliance be sized with these tables; instead, follow the appliance manufacturer's instructions.

## Clearance

Installations must provide the proper clearances to combustible materials as specified in the appropriate Underwriters Laboratories Inc. conditions for Listing, as stated in the product catalogs and embossed on the vent pipe. Hart & Cooley® systems to be designed using Section 1 of this Guide are shown below with their proper clearances.

## Type B

Hart & Cooley® pipe sizes 3 through 24 inches in diameter require 1 inch of airspace clearance throughout the entire length.

## Model TLC

Hart & Cooley® chimney sizes 5 through 14 inches in diameter require 2 inches of airspace clearance to combustible construction.

## Air Supply†

For satisfactory performance of appliances in confined spaces and for the venting system, an adequate supply of fresh air must be provided. When proper air supply has been provided for other appliances, such as clothes dryers, range hoods, fireplaces, etc., then the following method as provided by NFPA Standard 54, ANSI Z223.1 will provide the additional air needed for the appliances. The two grilles specified in A, B, C and D of Figure 1 *must* be installed so that one is at or below

the combustion air inlet of the appliance (within 12" from the floor) and the other above the relief opening of the draft hood (within 12" from the ceiling). The minimum dimension of air opening shall be 3". Any ducting used should have at least the same free area as the grilles determined.

One permanent opening, commencing within 12 inches of the top of the enclosure, shall be permitted where the equipment has clearances of at least 1 inch from the sides and back and 6 inches from the front of the appliance. The opening shall directly communicate with the outdoors or shall communicate through a vertical or horizontal duct to the outdoors or spaces that freely communicate with the outdoors (see Figure 1, E) and shall have a minimum free area of:

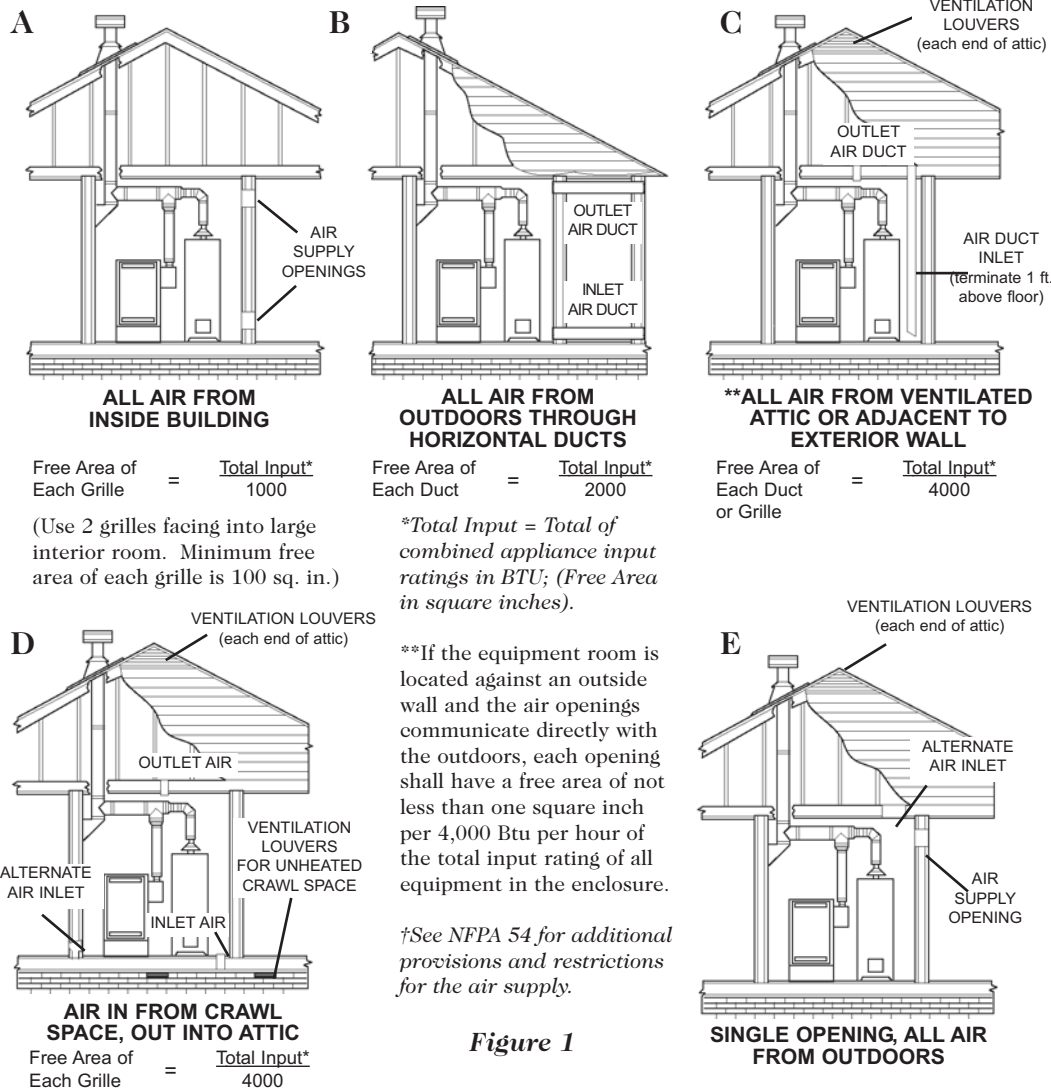

Figure 1



- a. 1 inch<sup>2</sup>/3000 Btu/hour of the total input rating of all equipment located in the enclosure, and
- b. Not less than the sum of the areas of all vent connectors in the confined space.

A combination of air supplied from both the indoors and outdoors is also permitted. See NFPA 54 for these provisions.

### Local Building Code

Should the local building code differ from recommendations given in this Guide, consult with your building inspector or other local administrative authority. As stated in the Foreword, the information given is based on the latest scientific data, which has been further verified by a long and satisfactory use history. These data and practices given herein will invariably provide better results than practices required by an obsolete code.

### Correction for Altitude

The vent system should always be designed for the sea level nameplate rating (greatest input when unit has modulated input) of the appliance, regardless of the actual derated operating input required by the local altitude.

### Outside Vents

The gas vent sizing tables are not applicable to outside (exposed) chimneys or vents below the roofline per NFPA 54. A Type B vent lining an exposed masonry chimney is considered to be an enclosed vent system, and these tables may be used.

### Connectors

Single-wall pipe (stovepipe) is not recommended for use in TYPE B venting systems. Because of the higher heat loss from the flue products, the draft is reduced and condensation can occur. The resulting moisture may corrode the pipe and will likely leak out on the building and contents, causing damage.

Where single-wall connector pipe usage is accepted local practice, the following considerations must be followed:

1. Minimum clearance to combustibles is 6 inches instead of the 1 inch required for Hart & Cooley® vent.
2. The heat loss is roughly double that for B-Vent, so **DO NOT USE IN ANY COLD OR CONCEALED SPACES, AS CONDENSATION WILL RESULT AND LEAD TO VENTING FAILURE AND POSSIBLE OTHER DAMAGE.**

### Connector Rise

The immediate vertical height from the flue collar to the first turn (connector rise) will have an important effect on

the proper functioning of a venting system. In order for a venting system to prime (for flow up the vent to start), the vent **MUST** be heated by the flue gases. If it is easier (less resistance) for the flue products to spill out the draft hood relief opening than to flow into the vent, priming can be delayed or prevented altogether. By using all of the vertical height (head room) available (NEVER less than 1 foot), a venting system will usually prime within 8 to 10 seconds. Small increases in connector rise generally have a greater impact on vent capacity than an increase in common vent height.

### Vent Cap or Termination

Use only Hart & Cooley® companion listed caps or roof assemblies. The capacity and wind resistance depends on the correct termination. Terminations on any factory-built chimney housing or other custom enclosure or chase **MUST** comply with the instructions for a roof surface.

### Appliance Type Limitations

Appliances that are NOT to be connected to TYPE B gas vents:

- **Gas Incinerators**—Use the Hart & Cooley® Model TLC Chimney. This is treated as a solid fuel-burning appliance.
- **Gas Clothes Dryers**—These produce positive pressure discharge and will cause backflow to the other connected appliances. They will also discharge lint, which may eventually block the discharge.
- **Power Burners**—Not classified as Category I or with positive draft, and are NOT allowed on TYPE B venting systems.
- **All Condensing Type**—Category IV (High Efficiency) Appliances—are NOT ALLOWED on TYPE B venting systems. Condensation will leak out and damage the structure and contents.

### Table Limitations

The Tables in Section 1 of this Guide include the following considerations:

- Low resistance Hart & Cooley® RC, RHW or RM cap
- Listed Category I appliances
- Two 90° turns except for “0” lateral

For each additional 90° elbow or equivalent beyond two, reduce the tabled capacity by 10%.

The vent connector should be routed to the vent, utilizing the shortest possible route.

- Chimneys and vents on an outside wall must be enclosed below the roofline.

\*See page 8 for definitions of gas appliance categories.

Pipe Diameter	3"	4"	5"	6"	7"	8"	10"	12"	14"	16"	18"
Pipe Area sq. in.	7.1	12.5	19.6	28.3	38.5	50.3	78.5	113.1	154	201.1	254.5

# Type B Double-Wall Gas Vents

## Condensation

The condensing of water vapor from the products of combustion of gas fuels can be minimized with the use of these sizing tables. When the vent system is designed properly, dilution air, which may enter a draft hood (if available), reduces the temperature at which water vapor will condense (dew point). Exceptions that will cause condensation are as follows:

- A. Temporarily (for a few seconds) after burner ignition, condensation will form on the cold inner liner of the vent. Before it develops to drop size, the liner will have been heated above the dew point, and this condensate will reevaporate. If the vent is located outdoors and the temperature is very low, condensation may continue. This is a good reason for avoiding this type of installation. It is also important NOT to extend the vent above the roof more than the rules require.
- B. Extremely long vents or long laterals in unheated spaces can allow the flue products to cool to the dew point. **DO NOT WRAP INSULATION AROUND B-VENT TRYING TO PREVENT CONDENSATION.** This method is not reliable and may contribute to other problems.
- C. *AIR SUPPLY*, as covered earlier, is of great importance to the proper operation of a vent. Again if sufficient make-up air is not available to replace that required by the burner and the draft hood, the system is starved. The first result is that less air enters the draft hood, and the dew point temperature rises. In other words, condensation can occur at a higher temperature. At some point in the dilution percent, condensation will start in the vent. Further starving for air can result in water running out of the vent, and damage will result to the structure and contents.

**Remember**—When in doubt for any reason, such as dimensions being questionable, a borderline chart selection, or overhead clearance for maximum connector rise in doubt, **ALWAYS USE THE NEXT LARGER SIZE** and prevent problems that might occur. This does not apply to table minimums.

## Vent Caps

Listed vent caps for double-wall Type B vents are designed to serve two purposes, (1) prevent rain and debris from entering the vent, and (2) help prevent a downdraft condition in the vent due to adverse wind conditions. These Tables apply to vents, vent caps or roof housing of the same make and style as the vent. For safe, efficient operation, **DO NOT** use combination roof jacks or caps or termination designs fabricated by

other than the vent manufacturer. **ALWAYS** install an approved vent cap immediately after installation of the vent to exclude debris and prevent damage.

## Wall Furnace Vents

Wall furnaces (vented recessed heaters) require a 12-foot minimum vent height measured from the floor to the top of the vent, or, in the case of combined vents, to the top of the vent connector. Many vented wall furnaces require connection to oval vents.

## Flashing and Top Assembly Using a Cap Model RHW/RM Metal Cap Termination

Model RHW/RM cap sizes 3" through 12" round are listed by U.L. for installation on gas vents terminating a sufficient distance from the roof so that no discharge opening is less than 2 feet horizontally from the roof surface. The lowest discharge opening shall be no closer than the minimum height shown in the Table in Figure 2. These minimum heights may be used provided that the vent is NOT less than 8 feet from any vertical wall. **This also means that no installation shall terminate by piercing a wall with a short pipe and cap.** These requirements satisfy all national codes.

**Termination Dimensions for Type RHW/RM Caps**

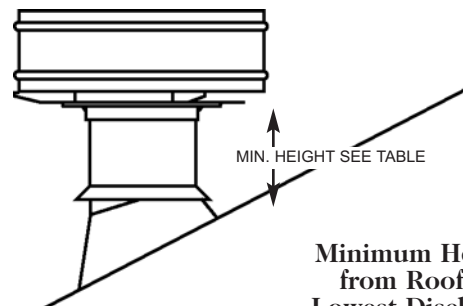

Roof Pitch	Minimum Height from Roof to Lowest Discharge Opening - Feet
Flat to 6/12	1.0
Over 6/12 to 7/12	1.25
Over 7/12 to 8/12	1.5
Over 8/12 to 9/12	2.0
Over 9/12 to 10/12	2.5
Over 10/12 to 11/12	3.25
Over 11/12 to 12/12	4.0
Over 12/12 to 14/12	5.0
Over 14/12 to 16/12	6.0
Over 16/12 to 18/12	7.0
Over 18/12 to 20/12	7.5
Over 20/12 to 21/12	8.0

Model RHW/RM caps are listed under the “Draft Loss and Wind Effect” requirements of UL Standard 441.

**Figure 2**



## Metal Cap Terminations

Cap sizes 14" through 30" diameters are for gas vents that extend at least 2 feet above the highest point where they pass through a building and at least 2 feet higher than any portion of the building within 10 feet. If any adjacent structures are within 10 feet of the vent and are higher, then the vent **MUST** terminate at least 2 feet above these structures. This recommendation should be followed unless local code requirements state otherwise.

Large offsets in the attic space are discouraged. However, small offsets (laterals) may be used to minimize the amount of vent pipe that must be exposed above the roof in order to comply with the above. NO gas vent should be terminated less than 5 feet in vertical height above the highest connected appliance draft hood outlet.

## General Termination Considerations

A cap or chimney housing offers protection against the entrance of rain, snow and debris, as well as birds, and will minimize the effect of wind on the vent. It will protect the vent from downdrafts due to a wind that impinges directly upon the vent. However, no vent cap, cowl or top can overcome the adverse effect of a region of high static pressure around the vent terminal nor the effect of an interior region of low pressure. Regions of high static pressure around the vent terminal can be avoided by following the general rule for the vent termination given above. Low or negative interior pressures in the building may be caused by (1) failure to provide for combustion air, (2) excessive use of exhaust fans, and (3) tight construction resulting in the lack of infiltration air. Vented clothes dryers and fireplaces will also remove large amounts of air from the interior, tending to produce a low interior pressure.

This also means that no B Vent installation shall terminate by piercing a wall with a short vertical or horizontal pipe and a cap.

## Definitions

**A SINGLE-APPLIANCE VENT** is an independent vent for one appliance (Figure 3).

**TOTAL HEIGHT (H)** is the vertical distance measured between the appliance collar connection and the vent termination (Figure 3).

**TOTAL LATERAL LENGTH (L)** is the actual horizontal distance or length of offset between the appliance collar and the main vertical portion of vent (Figure 3).

**MULTIPLE-APPLIANCE VENT** is a venting system combining the connectors of two or more appliances at one floor level to a common vertical vent. Connector in a combined vent system connects an individual appliance flue collar to the common vent or manifold (Figure 4).

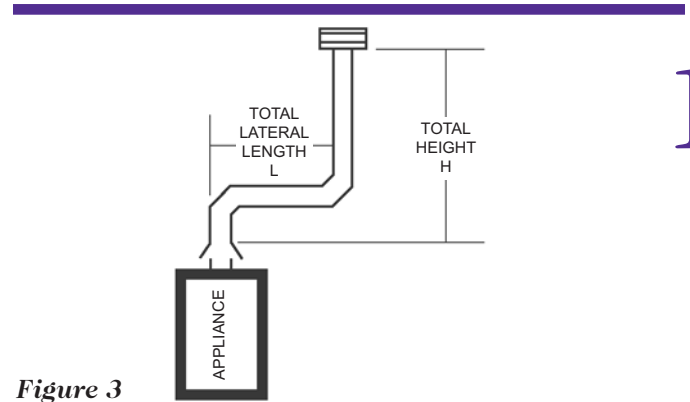

Figure 3

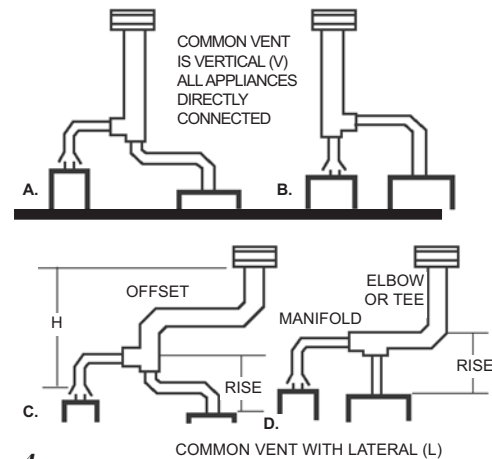

Figure 4

**MINIMUM TOTAL VENT HEIGHT** is the vertical distance measured from the tallest appliance flue collar outlet in the system to the termination of the vent (see Figures 3 and 4). This minimum height is a fixed dimension for any one vent system regardless of the number or placement of appliances in the system.

**CONNECTOR RISE** for any appliance in a vent system is the vertical distance from the flue collar outlet to the point where the next connector joins the system (see Figure 4).

**COMMON VENT** is that portion of the venting system above the lowest interconnection. When the common vent is entirely vertical, the system is called a **VERTICAL** or **V** type. All others are called **LATERAL** or **L** type (see Figure 4).

**FAN-ASSISTED COMBUSTION SYSTEM** is an appliance equipped with a fan to either draw or force products of combustion through the combustion chamber and/or heat exchanger.

**FAN MIN** refers to the minimum input rating of a Category 1 fan-assisted appliance attached to the vent.

## Type B Double-Wall Gas Vents

*FAN MAX* refers to the maximum input rating of a Category I fan-assisted appliance attached to the vent.

*NAT MAX* refers to the maximum input rating of a Category I draft-hood-equipped appliance attached to the vent. There are no minimum appliance input ratings for draft-hood-equipped appliances.

*FAN+FAN* refers to the maximum combined input rating of two or more fan-assisted appliances attached to the common vent.

*FAN+NAT* refers to the maximum combined input rating of one or more fan-assisted appliances and one or more draft-hood-equipped appliances attached to the common vent.

*NAT+NAT* refers to the maximum combined input rating of two or more draft-hood-equipped appliances attached to the common vent.

*NA* means not allowed due to physical or geometric constraints.

*DRAFT HOOD* is a device built into an appliance, or made a part of the vent connector from an appliance, which is designed to (1) provide for the ready escape of the flue gases from the appliance in the event of no draft, backdraft, or stoppage beyond the draft hood; (2) prevent a backdraft from entering the appliance; and (3) neutralize the effect of stack action of the chimney or gas vent upon the operation of the appliance.

*VENT* is a passageway used to convey flue gases from gas utilization equipment, or its vent connector, to the outside atmosphere.

*VENT CONNECTOR* is the pipe or duct that connects a fuel gas-burning appliance to a vent or chimney.

*FLUE COLLAR* is that portion of an appliance designed for the attachment of a draft hood, appliance adapter, vent connector or venting system.

*FORCED DRAFT* indicates that the combustion air fan or blower is located ahead of the burner compartment.

*INDUCED DRAFT* indicates that the combustion air fan or blower is located at or after the exit of flue products from the heat exchanger.

*CONDENSING APPLIANCE* is one which by reason of having sufficient heat removed from its products of combustion, water vapors will condense in its heat exchanger and continue to condense in the venting system.

### Definition of ANSI Categories of Appliances\*

**Gas Appliances Categories.** Vented gas appliances are classified for venting purposes into four categories as follows:

**Category I** An appliance that operates with a negative vent static pressure and with a vent gas temperature that avoids excessive condensate production in the vent.

**Category II** An appliance that operates with a negative vent static pressure and with a vent gas temperature that may cause excessive condensate production in the vent.

**Category III** An appliance that operates with a positive vent static pressure and with a vent gas temperature that usually avoids excessive condensate production in the vent.

**Category IV** An appliance that operates with a positive vent static pressure and with a vent gas temperature that causes excessive condensate production in the vent.

\*Remember that these definitions apply to the appliance and do not necessarily reflect the performance of the connected vent system.

## Single-Appliance Vent Systems

### General Rules for Venting Single Appliances.

Normally, a vent equal to the size of the draft hood outlet can be considered satisfactory for venting a single appliance. It is important to note that this rule may NOT apply to cases where an extra high vent is required, and it may be desirable to calculate the system to determine whether it is possible to reduce the size of the vent.

## How to Use Single-Appliance Vent Tables

To determine the proper vent size for a single-appliance vent, use Table 1 or 2 (pages 10-12).

- Determine *Total Height (H)* and *Total Lateral Length (L)* based on location of appliance and vent and the height to vent termination.
- Read down the *Total Height (H)* column at the left to a height equal to the *Total Height*.
- Select the horizontal row for the appropriate *Length of Lateral (L)* (zero for straight vertical vents).
- Read across to the column that represents the appliance type and shows a capacity equal to or greater than the appliance nameplate input for draft-hood-equipped appliances or that falls between the *FAN Min and Max* for *FAN-assisted* appliances.
- If the vent size shown at the top of the column containing the correct capacity is equal to or larger than the appliance draft hood, use the vent size shown by the Table.
- If the vent shown is smaller than the draft hood size, see **Draft Hood to Vent Reduction** on page 9.

### Example

A typical example of use of the Tables for Single-Appliance Venting is shown in Figure 5. The furnace has an input rating of 80,000 BTU per hour and is fan-assisted. *Total Height (H)* of the vent is 30 feet with a 10-foot *Total Lateral Length (L)*. The entire system is Type B gas vent.

### Procedure

Go down *Vent Height (H)* column of Table 1 to 30-foot height with a 10-foot lateral under the *FAN Min* and *FAN Max* column giving 37,000 and 150,000 BTUH for a 4-inch vent. Generally, the smallest diameter that

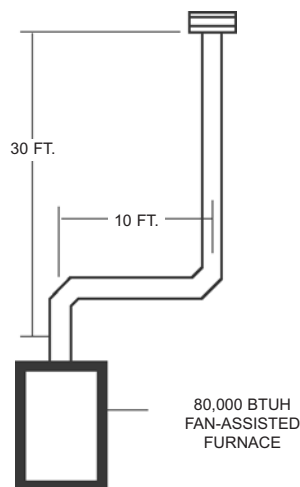

Figure 5

will do the job is preferred. Note that if this system were to have a single-wall connector, Table 2 would have to be used. However, there is no solution!

## Draft Hood to Vent Reduction

If the vent size determined from the Tables is less than the size of a draft hood outlet or flue collar, the smaller vent may be used, provided:

- The vent is at least 10 feet high. When a vent is less than 10 feet high, the vent should be at least as large as the flue collar outlet.
- Vents for draft hoods or flue collars 12 inches in diameter or less should NOT be reduced more than one pipe size. A 6- to 5-inch or a 12- to 10-inch reduction is a one- pipe size reduction. For larger gas-burning equipment, such as boilers having draft hood sizes from 14 to 24 inches in diameter, reductions of more than two pipe sizes are NOT recommended (24- to 20-inch is a two-size reduction).
- The maximum capacity listed in the tables for a fan-assisted appliance is reduced by 10 percent.
- Regardless of the size vent shown by the Tables for such appliances, DO NOT connect any 4-inch draft hoods to 3-inch vents. This provision does not apply to fan-assisted appliances.

## Additional Guidelines for Single-Appliance Vent Systems

The flow area of the vertical vent shall not exceed seven times the flow area of the appliance flue collar area or the draft hood outlet area. For instance, if:

The flue collar diameter is:	3"	4"	5"	6"	7"	8"
The maximum common vent diameter allowed is:	8"	10"	12"	14"	18"	20"

Single-appliance vent configurations with zero (0) lateral lengths in Tables 1 and 2 have no elbows in the system. For all other vent configurations with indicated lateral lengths, the vent table capacities include two 90° elbows. For each additional 90° fitting or equivalent, the maximum capacity listed shall be reduced by 10%. Two 45° elbows are equivalent to one 90° elbow. Two 90° elbows connected together are equivalent to three in the system.

Interpolation is permitted between table entries. Extrapolation beyond table entries is not permitted.

# Type B Double-Wall Gas Vent Capacities with Type B Double-Wall Connector

## Single Category I Appliance

Table 1

Vent Height H (ft)	Lateral L (ft)	Vent and Connector Diameter - D																					
		3"			4"			5"			6"			7"			8"			10"			
		Appliance Input Rating Limits in Thousands of BTU Per Hour																					
		FAN			NAT			FAN			NAT			FAN			NAT			FAN			NAT
Min	Max	Max	Min	Max	Max	Min	Max	Max	Min	Max	Max	Min	Max	Max	Min	Max	Max	Min	Max	Max	Min	Max	Max
6	0	0	78	46	0	152	86	0	251	141	0	375	205	0	524	285	0	698	370	0	1121	570	
	2	13	51	38	18	97	67	27	157	105	32	232	157	44	321	217	53	425	285	75	675	455	
	4	21	49	34	30	94	64	39	153	103	50	227	153	66	316	211	79	419	279	110	668	445	
	6	25	46	32	36	91	61	47	149	100	59	223	149	78	310	205	93	413	273	128	661	435	
8	0	0	84	50	0	165	94	0	276	155	0	415	235	0	583	320	0	780	415	0	1261	660	
	2	12	57	40	16	109	75	25	178	120	28	263	180	42	365	247	50	483	322	71	770	515	
	5	23	53	38	32	103	71	42	171	115	53	255	173	70	356	237	83	473	313	115	758	503	
	8	28	49	35	39	98	66	51	164	109	64	247	165	84	347	227	99	463	303	137	746	490	
10	0	0	88	53	0	175	100	0	295	166	0	447	255	0	631	345	0	847	450	0	1377	720	
	2	12	61	42	17	118	81	23	194	129	26	289	195	40	402	273	48	533	355	68	852	560	
	5	23	57	40	32	113	77	41	187	124	52	280	188	68	392	263	81	522	346	112	839	547	
	10	30	51	36	41	104	70	54	176	115	67	267	175	88	376	245	104	504	330	142	817	525	
15	0	0	94	58	0	191	112	0	327	187	0	502	285	0	716	390	0	970	525	0	1596	840	
	2	11	69	48	15	136	93	20	226	150	22	339	225	38	475	316	45	633	414	63	1019	675	
	5	22	65	45	30	130	87	39	219	142	49	330	217	64	463	300	76	620	403	105	1003	660	
	10	29	59	41	40	121	82	51	206	135	64	315	208	84	445	288	99	600	386	135	977	635	
15	35	53	37	48	112	76	61	195	128	76	301	198	98	429	275	115	580	373	155	953	610		
20	0	0	97	61	0	202	119	0	349	202	0	540	307	0	776	430	0	1057	575	0	1756	930	
	2	10	75	51	14	149	100	18	250	166	20	377	249	33	531	346	41	711	470	59	1150	755	
	5	21	71	48	29	143	96	38	242	160	47	367	241	62	519	337	73	697	460	101	1133	738	
	10	28	64	44	38	133	89	50	229	150	62	351	228	81	499	321	95	675	443	130	1105	710	
15	34	58	40	46	124	84	59	217	142	73	337	217	94	481	308	111	654	427	150	1078	688		
20	48	52	35	55	116	78	69	206	134	84	322	206	107	464	295	125	634	410	167	1052	665		
30	0	0	100	64	0	213	128	0	374	220	0	587	336	0	853	475	0	1173	650	0	1977	1060	
	2	9	81	56	13	166	112	14	283	185	18	432	280	27	613	394	33	826	535	54	1351	865	
	5	21	77	54	28	160	108	36	275	176	45	421	273	58	600	385	69	811	524	96	1332	851	
	10	27	70	50	37	150	102	48	262	171	59	405	261	77	580	371	91	788	507	125	1301	829	
15	33	64	NA	44	141	96	57	249	163	70	389	249	90	560	357	105	765	490	143	1272	807		
20	56	58	NA	53	132	90	66	237	154	80	374	237	102	542	343	119	743	473	160	1243	784		
30	NA	NA	NA	73	113	NA	88	214	NA	104	346	219	131	507	321	149	702	444	195	1189	745		
50	0	0	101	67	0	216	134	0	397	232	0	633	363	0	932	518	0	1297	708	0	2231	1195	
	2	8	86	61	11	183	122	14	320	206	15	497	314	22	715	445	26	975	615	41	1620	1010	
	5	20	82	NA	27	177	119	35	312	200	43	487	308	55	702	438	65	960	605	90	1600	996	
	10	26	76	NA	35	168	114	45	299	190	56	471	298	73	681	426	86	935	589	118	1567	972	
15	59	70	NA	42	158	NA	54	287	180	66	455	288	85	662	413	100	911	572	136	1536	948		
20	NA	NA	NA	50	149	NA	63	275	169	76	440	278	97	642	401	113	888	556	151	1505	924		
30	NA	NA	NA	69	131	NA	84	250	NA	99	410	259	123	605	376	141	844	522	183	1446	876		
100	0	NA	NA	NA	0	218	NA	0	407	NA	0	665	400	0	997	560	0	1411	770	0	2491	1310	
	2	NA	NA	NA	10	194	NA	12	354	NA	13	566	375	18	831	510	21	1155	700	30	1975	1170	
	5	NA	NA	NA	26	189	NA	33	347	NA	40	557	369	52	820	504	60	1141	692	82	1955	1159	
	10	NA	NA	NA	33	182	NA	43	335	NA	53	542	361	68	801	493	80	1118	679	108	1923	1142	
15	NA	NA	NA	40	174	NA	50	321	NA	62	528	353	80	782	482	93	1095	666	126	1892	1124		
20	NA	NA	NA	47	166	NA	59	311	NA	71	513	344	90	763	471	105	1073	653	141	1861	1107		
30	NA	NA	NA	NA	NA	NA	78	290	NA	92	483	NA	115	726	449	131	1029	627	170	1802	1071		
50	NA	NA	NA	NA	NA	NA	NA	NA	NA	147	428	NA	180	651	405	197	944	575	241	1688	1000		



Table 1 (continued)

Vent Height H (ft)	Lateral L (ft)	Vent and Connector Diameter - D																				
		12"			14"			16"			18"			20"			22"			24"		
		Appliance Input Rating Limits in Thousands of BTU Per Hour																				
		FAN		NAT	FAN		NAT	FAN		NAT	FAN		NAT	FAN		NAT	FAN		NAT	FAN		NAT
Min	Max	Max	Min	Max	Max	Min	Max	Max	Min	Max	Max	Min	Max	Max	Min	Max	Max	Min	Max	Max		
6	0	0	1645	850	0	2267	1170	0	2983	1530	0	3802	1960	0	4721	2430	0	5737	2950	0	6853	3520
	2	103	982	650	138	1346	890	178	1769	1170	225	2250	1480	296	2782	1850	360	3377	2220	426	4030	2670
	4	147	975	640	191	1338	880	242	1761	1160	300	2242	1475	390	2774	1835	469	3370	2215	555	4023	2660
	6	171	967	630	219	1330	870	276	1753	1150	341	2235	1470	437	2767	1820	523	3363	2210	618	4017	2650
8	0	0	1858	970	0	2571	1320	0	3399	1740	0	4333	2220	0	5387	2750	0	6555	3360	0	7838	4010
	2	98	1124	745	130	1543	1020	168	2030	1340	212	2584	1700	278	3196	2110	336	3882	2560	401	4634	3050
	5	154	1110	733	199	1528	1010	251	2013	1330	311	2563	1685	398	3180	2090	476	3863	2545	562	4612	3040
	8	180	1097	720	231	1514	1000	289	2000	1320	354	2552	1670	450	3163	2070	537	3850	2530	630	4602	3030
10	0	0	2036	1060	0	2825	1450	0	3742	1925	0	4782	2450	0	5955	3050	0	7254	3710	0	8682	4450
	2	93	1244	850	124	1713	1130	161	2256	1480	202	2868	1890	264	3556	2340	319	4322	2840	378	5153	3390
	5	149	1229	829	192	1696	1105	243	2238	1461	300	2849	1871	382	3536	2318	458	4301	2818	540	5132	3371
	10	187	1204	795	238	1669	1080	298	2209	1430	364	2818	1840	459	3504	2280	546	4268	2780	641	5099	3340
15	0	0	2380	1240	0	3323	1720	0	4423	2270	0	5678	2900	0	7099	3620	0	8665	4410	0	10393	5300
	2	86	1495	985	114	2062	1350	147	2719	1770	186	3467	2260	239	4304	2800	290	5232	3410	346	6251	4080
	5	140	1476	967	182	2041	1327	229	2696	1748	283	3442	2235	355	4278	2777	426	5204	3385	501	6222	4057
	10	177	1446	936	227	2009	1289	283	2659	1712	346	3402	2193	432	4234	2739	510	5159	3343	599	6175	4019
	15	202	1418	905	257	1976	1250	318	2623	1675	385	3363	2150	479	4192	2700	564	5115	3300	665	6129	3980
20	0	0	2637	1350	0	3701	1900	0	4948	2520	0	6376	3250	0	7988	4060	0	9785	4980	0	11753	6000
	2	81	1694	1100	107	2343	1520	139	3097	2000	175	3955	2570	220	4916	3200	269	5983	3910	321	7154	4700
	5	135	1674	1079	174	2320	1498	219	3071	1978	270	3926	2544	337	4885	3174	403	5950	3880	475	7119	4662
	10	172	1641	1045	220	2282	1460	273	3029	1940	334	3880	2500	413	4835	3130	489	5896	3830	573	7063	4600
	15	195	1609	1018	248	2245	1425	306	2988	1910	372	3835	2465	459	4786	3090	541	5844	3795	631	7007	4575
	20	217	1578	990	273	2210	1390	335	2948	1880	404	3791	2430	495	4737	3050	585	5792	3760	689	6953	4550
30	0	0	3004	1550	0	4252	2170	0	5725	2920	0	7420	3770	0	9341	4750	0	11483	5850	0	13848	7060
	2	74	2004	1310	98	2786	1800	127	3696	2380	159	4734	3050	199	5900	3810	241	7194	4650	285	8617	5600
	5	127	1981	1289	164	2759	1775	206	3666	2350	252	4701	3020	312	5863	3783	373	7155	4622	439	8574	5552
	10	164	1944	1254	209	2716	1733	259	3617	2300	316	4647	2970	386	5803	3739	456	7090	4574	535	8505	5471
	15	187	1908	1220	237	2674	1692	292	3570	2250	354	4594	2920	431	5744	3695	507	7026	4527	590	8437	5391
	20	207	1873	1185	260	2633	1650	319	3523	2200	384	4542	2870	467	5686	3650	548	6964	4480	639	8370	5310
	30	246	1807	1130	305	2555	1585	369	3433	2130	440	4442	2785	540	5574	3565	635	6842	4375	739	8239	5225
50	0	0	3441	1825	0	4934	2550	0	6711	3440	0	8774	4460	0	11129	5635	0	13767	6940	0	16694	8430
	2	66	2431	1513	86	3409	2125	113	4554	2840	141	5864	3670	171	7339	4630	209	8980	5695	251	10788	6860
	5	118	2406	1495	151	3380	2102	191	4520	2813	234	5826	3639	283	7295	4597	336	8933	5654	394	10737	6818
	10	154	2366	1466	196	3332	2064	243	4464	2767	295	5763	3585	355	7224	4542	419	8855	5585	491	10652	6749
	15	177	2327	1437	222	3285	2026	274	4409	2721	330	5701	3534	396	7155	4511	465	8779	5546	542	10570	6710
	20	195	2288	1408	244	3239	1987	300	4356	2675	361	5641	3481	433	7086	4479	506	8704	5506	586	10488	6670
	30	232	2214	1349	287	3150	1910	347	4253	2631	412	5523	3431	494	6953	4421	577	8557	5444	672	10328	6603
100	0	0	3925	2050	0	5729	2950	0	7914	4050	0	10485	5300	0	13454	6700	0	16817	8600	0	20578	10300
	2	44	3027	1820	72	4313	2550	95	5834	3500	120	7591	4600	138	9577	5800	169	11803	7200	204	14264	8800
	5	107	3002	1803	136	4282	2531	172	5797	3475	208	7548	4566	245	9528	5769	293	11748	7162	341	14204	8756
	10	142	2961	1775	180	4231	2500	223	5737	3434	268	7478	4509	318	9447	5717	374	11658	7100	436	14105	8683
	15	163	2920	1747	206	4182	2469	252	5678	3392	304	7409	4451	358	9367	5665	418	11569	7037	487	14007	8610
	20	181	2880	1719	226	4133	2438	277	5619	3351	330	7341	4394	387	9289	5613	452	11482	6975	523	13910	8537
	30	215	2803	1663	265	4037	2375	319	5505	3267	378	7209	4279	446	9136	5509	514	11310	6850	592	13720	8391
	50	292	2657	1550	350	3856	2250	415	5289	3100	486	6956	4050	572	8841	5300	659	10979	6600	752	13354	8100

# Type B Double-Wall Gas Vent Capacities with Single-Wall Connector

## Single Category I Appliance

Table 2

Vent Height H (ft)	Lateral L (ft)	Vent and Connector Diameter - D																								
		3"			4"			5"			6"			7"			8"			10"			12"			
		Appliance Input Rating Limits in Thousands of BTU Per Hour																								
		FAN NAT			FAN NAT			FAN NAT			FAN NAT			FAN NAT			FAN NAT			FAN NAT						
Min	Max	Max	Min	Max	Max	Min	Max	Max	Min	Max	Max	Min	Max	Max	Min	Max	Max	Min	Max	Max	Min	Max	Max	Min	Max	Max
6	0	38	77	45	59	151	85	85	249	140	126	373	204	165	522	284	211	695	369	371	1118	569	537	1639	849	
	2	39	51	36	60	96	66	85	156	104	123	231	156	159	320	213	201	423	284	347	673	453	498	979	648	
	4	NA	NA	33	74	92	63	102	152	102	146	225	152	187	313	208	237	416	277	409	664	443	584	971	638	
	6	NA	NA	31	83	89	60	114	147	99	163	220	148	207	307	203	263	409	271	449	656	433	638	962	627	
8	0	37	83	50	58	164	93	83	273	154	123	412	234	161	580	319	206	777	414	360	1257	658	521	1852	967	
	2	39	56	39	59	108	75	83	176	119	121	261	179	155	363	246	197	482	321	339	768	513	486	1220	743	
	5	NA	NA	37	77	102	69	107	168	114	151	252	171	193	352	235	245	470	311	418	754	500	598	1104	730	
	8	NA	NA	33	90	95	64	122	161	107	175	243	163	223	342	225	280	458	300	470	740	486	665	1089	715	
10	0	37	87	53	57	174	99	82	293	165	120	444	254	158	628	344	202	844	449	351	1373	718	507	2031	1057	
	2	39	61	41	59	117	80	82	193	128	119	287	194	153	400	272	193	531	354	332	849	559	475	1242	848	
	5	52	56	39	76	111	76	105	185	122	148	277	186	190	388	261	241	518	344	409	834	544	584	1224	825	
	10	NA	NA	34	97	100	68	132	171	112	188	261	171	237	369	241	296	497	325	492	808	520	688	1194	788	
15	0	36	93	57	56	190	111	80	325	186	116	499	283	153	713	388	195	966	523	336	1591	838	488	2374	1237	
	2	38	69	47	57	136	93	80	225	149	115	337	224	148	473	314	187	631	413	319	1015	673	457	1491	983	
	5	51	63	44	75	128	86	102	216	140	144	326	217	182	459	298	231	616	400	392	997	657	562	1469	963	
	10	NA	NA	39	95	116	79	128	201	131	182	308	203	228	438	284	284	582	381	470	966	628	664	1433	928	
15	NA	NA	NA	NA	NA	72	158	186	124	220	290	192	272	418	269	334	568	367	540	937	601	750	1399	894		
20	0	35	96	60	54	200	118	76	346	201	114	537	306	149	772	428	190	1053	573	326	1751	927	473	2631	1346	
	2	37	74	50	56	148	99	78	248	165	113	375	248	144	528	344	182	708	468	309	1146	754	443	1689	1098	
	5	50	68	47	73	140	94	100	239	158	141	363	239	178	514	334	224	692	457	381	1126	734	547	1665	1074	
	10	NA	NA	41	93	129	86	125	223	146	177	344	224	222	491	316	277	666	437	457	1092	702	646	1626	1037	
15	NA	NA	NA	NA	NA	80	155	208	136	216	325	210	264	469	301	325	640	419	526	1060	677	730	1587	1005		
20	NA	NA	NA	NA	NA	NA	186	192	126	254	306	196	309	448	285	374	616	400	592	1028	651	808	1550	973		
30	0	34	99	63	53	211	127	76	372	219	110	584	334	144	849	472	184	1168	647	312	1971	1056	454	2996	1545	
	2	37	80	56	55	164	111	76	281	183	109	429	279	139	610	392	175	823	533	296	1346	863	424	1999	1308	
	5	49	74	52	72	157	106	98	271	173	136	417	271	171	595	382	215	806	521	366	1324	846	524	1971	1283	
	10	NA	NA	NA	91	144	98	122	255	168	171	397	257	213	570	367	265	777	501	440	1287	821	620	1927	1243	
15	NA	NA	NA	115	131	NA	151	239	157	208	377	242	255	547	349	312	750	481	507	1251	794	702	1884	1205		
20	NA	NA	NA	NA	NA	NA	181	223	NA	246	357	228	298	524	333	360	723	461	570	1216	768	780	1841	1166		
30	NA	NA	NA	NA	NA	NA	NA	NA	NA	NA	NA	NA	389	477	305	461	670	426	704	1147	720	937	1759	1101		
50	0	33	99	66	51	213	133	73	394	230	105	629	361	138	928	515	176	1292	704	295	2223	1189	428	3432	1818	
	2	36	84	61	53	181	121	73	318	205	104	495	312	133	712	443	168	971	613	280	1615	1007	401	2426	1509	
	5	48	80	NA	70	174	117	94	308	198	131	482	305	164	696	435	204	953	602	347	1591	991	496	2396	1490	
	10	NA	NA	NA	89	160	NA	118	292	186	162	461	292	203	671	420	253	923	583	418	1551	963	589	2347	1455	
15	NA	NA	NA	112	148	NA	145	275	174	199	441	280	244	646	405	299	894	562	481	1512	934	668	2299	1421		
20	NA	NA	NA	NA	NA	NA	176	257	NA	236	420	267	285	622	389	345	866	543	544	1473	906	741	2251	1387		
30	NA	NA	NA	NA	NA	NA	NA	NA	NA	315	376	NA	373	573	NA	442	809	502	674	1399	848	892	2159	1318		
100	0	NA	NA	NA	49	214	NA	69	403	NA	100	659	395	131	991	555	166	1404	765	273	2479	1300	395	3912	2042	
	2	NA	NA	NA	51	192	NA	70	351	NA	98	583	373	125	828	508	158	1152	698	259	1970	1168	371	3021	1817	
	5	NA	NA	NA	67	186	NA	90	342	NA	125	551	366	156	813	501	194	1134	688	322	1945	1153	460	2990	1796	
	10	NA	NA	NA	85	175	NA	113	324	NA	153	532	354	191	789	486	238	1104	672	386	1905	1133	547	2938	1763	
15	NA	NA	NA	132	162	NA	138	310	NA	188	511	343	230	674	473	281	1075	656	447	1865	1110	618	2888	1730		
20	NA	NA	NA	NA	NA	NA	168	295	NA	224	487	NA	270	739	458	325	1046	639	507	1825	1087	690	2838	1696		
30	NA	NA	NA	NA	NA	NA	231	264	NA	301	448	NA	355	685	NA	418	988	NA	631	1747	1041	834	2739	1627		
50	NA	NA	NA	NA	NA	NA	NA	NA	NA	NA	NA	NA	540	584	NA	617	866	NA	895	1591	NA	1138	2547	1489		



## Multiple-Appliance Vent Systems

### How to Determine Each Vent Connector Size (Table 4A or 5A, pages 14-16)

- Determine the **MINIMUM TOTAL VENT HEIGHT** for the system from a sketch of the proposed system.
- Determine the **CONNECTOR RISE** for each appliance.
- Enter the **VENT CONNECTOR Table 4A or 5A** at the line showing **VENT HEIGHT** equal to or less than that determined above. Continue horizontally on that line for the first appliance **CONNECTOR RISE** using the appliance nameplate **BTUH rating** (sea level). Always use a Table entry that equals or exceeds a draft-hood appliance input or that brackets a fan-assisted appliance input. Read the connector vent size for that appliance at the top of the column.
- Using the same **VENT HEIGHT**, repeat the procedure for each appliance, using its **CONNECTOR RISE AND BTUH rating**.

**CAUTION.** NEVER use a connector size smaller than the draft-hood outlet size. (Exception: Does not apply to fan-assisted appliances.)

### How to Determine Common Vent Size (Table 4B or 5B, pages 14-16)

- Total all appliance **BTUH input ratings** that are to be connected to this common vent.
- Enter the **COMMON VENT TABLE 4B or 5B** at the same **VENT HEIGHT** used to determine the vent connector sizes above.
- Move horizontally across from this **VENT HEIGHT** figure using either the **L line** if the common vent has an offset, or has a horizontal manifold (Figure 4D), or the **V line** if the common vent is vertical with no offsets.
- Select the first value in the correct appliance combination column that is equal to or greater than the total of **BTUH ratings**.
- The size of the required **COMMON VENT** is found at the top of this column.

**CAUTION.** Regardless of the **COMMON VENT** size determined by the above procedure, the vent **MUST** be at least as large as the largest connector. If more than one connector is this same size, then use a **COMMON VENT** one size larger.

#### Example

Connect a 45,000 BTU water heater with a draft hood and 1-foot connector rise with a 100,000 BTU fan-equipped furnace with a 2-foot connector rise to a **Common Vent** with a **Minimum Total Vent Height** of 18 feet (Figure 6). All portions of the system are Type B GAS VENT.

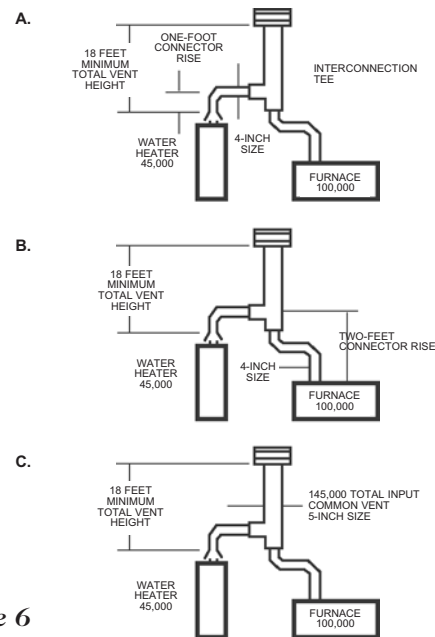

Figure 6

### Water Heater Vent Connector Size

Use *Vent Connector Table 4A* under **NAT**. Read down *Minimum Total Vent Height* column to 15 feet and read across 1 foot connector rise line to **BTU rating** equal to or higher than water heater input rating. This figure shows 53,000 BTU and is in the column for 4-inch connector. Since this is in excess of the water heater input, it is not necessary to find the maximum input for an 18-foot minimum total vent height. Use a 4-inch connector (Figure 6A).

### Furnace Vent Connector

Use *Vent Connector Table 4A*. Read down *Total Vent Height* column to 15 feet and read across 2-foot *Connector Rise* line to fan column. Note 4-inch vent size shows 96,000 BTU per hour or less than furnace input. However, with 20-foot Total Height, read across 2-foot connector rise line. Note 4-inch vent size shows 105,000 BTU per hour. Since 18-foot height is  $\frac{3}{5}$  of this:  $\frac{3}{5}(105,000 - 96,000) = 5400$ .  $96,000 + 5400 = 101,400$ , which is the maximum input for 18-foot Minimum Total Vent Height. Therefore a 4-inch connector would be the correct size for furnace, providing the furnace had a 4-inch or smaller draft hood outlet (Figure 6B).

### Common Vent Size

Total input to *Common Vent* is 145,000 BTU. Vent goes straight through roof so use **V line** of Table 4B under **FAN + NAT** column. Note that for 15-foot *Minimum Total Vent Height* maximum BTU for 5-inch vent is 164,000, which is greater than total input to the common vent. Therefore the common vent can be 5-inch diameter (Figure 6C).

# Type B Vent Connector Capacities

For Multiple Category I Appliances Connected to a Common Vent

Table 4A

Vent Height H (ft)	Connector Rise R (ft)	Vent Connector Diameter - D																					
		3"			4"			5"			6"			7"			8"			10"			
		Appliance Input Rating Limits in Thousands of BTU Per Hour																					
		FAN			NAT			FAN			NAT			FAN			NAT			FAN			NAT
Min	Max	Max	Min	Max	Max	Min	Max	Max	Min	Max	Max	Min	Max	Max	Min	Max	Max	Min	Max	Max	Min	Max	Max
6	1	22	37	26	35	66	46	46	106	72	58	164	104	77	225	142	82	296	185	128	466	289	
	2	23	41	31	37	75	55	48	121	86	60	183	124	79	253	168	95	333	220	131	526	345	
	3	24	44	35	38	81	62	49	132	96	62	199	139	82	275	189	97	363	248	134	575	386	
8	1	22	40	27	35	72	48	49	114	76	64	176	109	84	243	148	100	320	194	138	507	303	
	2	23	44	32	36	80	57	51	128	90	66	195	129	86	269	175	103	356	230	141	564	358	
	3	24	47	36	37	87	64	53	139	101	67	210	145	88	290	198	105	384	258	143	612	402	
10	1	22	43	28	34	78	50	49	123	78	65	189	113	89	257	154	106	341	200	146	542	314	
	2	23	47	33	36	86	59	51	136	93	67	206	134	91	282	182	109	374	238	149	596	372	
	3	24	50	37	37	92	67	52	146	104	69	220	150	94	303	205	111	402	268	152	642	417	
15	1	21	50	30	33	89	53	47	142	83	64	220	120	88	298	163	110	389	214	162	609	333	
	2	22	53	35	35	96	63	49	153	99	66	235	142	91	320	193	112	419	253	165	658	394	
	3	24	55	40	36	102	71	51	163	111	68	248	160	93	339	218	115	445	286	167	700	444	
20	1	21	54	31	33	99	56	46	157	87	62	246	125	86	334	171	107	436	224	158	681	347	
	2	22	57	37	34	105	66	48	167	104	64	259	149	89	354	202	110	463	265	161	725	414	
	3	23	60	42	35	110	74	50	176	116	66	271	168	91	371	228	113	486	300	164	764	466	
30	1	20	62	33	31	113	59	45	181	93	60	288	134	83	391	182	103	512	238	151	802	372	
	2	21	64	39	33	118	70	47	190	110	62	299	158	85	408	215	105	535	282	155	840	439	
	3	22	66	44	34	123	79	48	198	124	64	309	178	88	423	242	108	555	317	158	874	494	
50	1	19	71	36	30	133	64	43	216	101	57	349	145	78	477	197	97	627	257	144	984	403	
	2	21	73	43	32	137	76	45	223	119	59	358	172	81	490	234	100	645	306	148	1014	478	
	3	22	75	48	33	141	86	46	229	134	61	366	194	83	502	263	103	661	343	151	1043	538	
100	1	18	82	37	28	158	66	40	262	104	53	442	150	73	611	204	91	810	266	135	1285	417	
	2	19	83	44	30	161	79	42	267	123	55	447	178	75	619	242	94	822	316	139	1306	494	
	3	20	84	50	31	163	89	44	272	138	57	452	200	78	627	272	97	834	355	142	1327	555	

# Type B Common Vent Capacities

When Using Type B Connectors

Table 4B

Vent Height H (ft)	Vent Type	Vent Connector Diameter - D																								
		4"			5"			6"			7"			8"			10"									
		Combined Appliance Input Rating in Thousands of BTU Per Hour																								
		FAN			FAN			NAT			FAN			FAN			NAT			FAN			FAN			NAT
+FAN	+NAT	+NAT	+FAN	+NAT	+NAT	+FAN	+NAT	+NAT	+FAN	+NAT	+NAT	+FAN	+NAT	+NAT	+FAN	+NAT	+NAT	+FAN	+NAT	+NAT	+FAN	+NAT	+NAT			
6	L	74	65	52	112	93	82	163	129	117	247	198	160	323	251	210	538	416	328							
	V	92	81	65	140	116	103	204	161	147	309	248	200	404	314	260	672	520	410							
8	L	81	72	58	124	103	91	179	142	130	271	220	178	355	278	230	592	462	372							
	V	101	90	73	155	129	114	224	178	163	339	275	223	444	348	290	740	577	465							
10	L	88	78	63	135	113	98	194	155	142	294	239	193	382	302	250	640	502	396							
	V	110	97	79	169	141	124	243	194	178	367	299	242	477	377	315	800	627	495							
15	L	100	90	73	156	131	114	226	182	164	342	282	224	445	355	290	739	586	452							
	V	125	112	91	195	164	144	283	228	206	427	352	280	556	444	365	924	733	565							
20	L	109	98	81	172	146	127	251	204	182	380	315	250	497	399	325	828	661	512							
	V	136	123	102	215	183	160	314	255	229	475	394	310	621	499	405	1035	826	640							
30	L	122	110	94	195	168	147	289	238	211	438	367	290	576	468	375	967	780	592							
	V	152	138	118	244	210	185	361	297	266	547	459	360	720	585	470	1209	975	740							
50	L	134	122	107	223	195	171	337	282	248	513	438	338	683	565	440	1161	950	688							
	V	167	153	134	279	244	214	421	353	310	641	547	423	854	706	550	1451	1188	860							
100	L	140	130	NA	249	222	NA	391	337	NA	601	526	383	820	698	500	1427	1202	780							
	V	175	163	NA	311	277	NA	489	421	NA	751	658	479	1025	873	625	1784	1502	975							

Table 4A (continued)

Vent Height H (ft)	Connector Rise R (ft)	Vent Connector Diameter - D																						
		12"			14"			16"			18"			20"			22"			24"				
		Appliance Input Rating Limits in Thousands of BTU Per Hour																						
		FAN NAT			FAN NAT			FAN NAT			FAN NAT			FAN NAT			FAN NAT			FAN NAT				
	Min	Max	Max	Min	Max	Max	Min	Max	Max	Min	Max	Max	Min	Max	Max	Min	Max	Max	Min	Max	Max	Min	Max	Max
6	2	174	764	496	223	1046	653	281	1371	853	346	1772	1080	NA	NA	NA	NA	NA	NA	NA	NA	NA	NA	NA
	4	180	897	616	230	1231	827	287	1617	1081	352	2069	1370	NA	NA	NA	NA	NA	NA	NA	NA	NA	NA	NA
	6	NA	NA	NA	NA	NA	NA	NA	NA	NA	NA	NA	NA	NA	NA	NA	NA	NA	NA	NA	NA	NA	NA	NA
8	2	186	822	516	238	1126	696	298	1478	910	365	1920	1150	NA	NA	NA	NA	NA	NA	NA	NA	NA	NA	NA
	4	192	952	644	244	1307	884	305	1719	1150	372	2211	1460	471	2737	1800	560	3319	2180	662	3957	2590		
	6	198	1050	772	252	1445	1072	313	1902	1390	380	2434	1770	478	3018	2180	568	3665	2640	669	4373	3130		
10	2	196	870	536	249	1195	730	311	1570	955	379	2049	1205	NA	NA	NA	NA	NA	NA	NA	NA	NA	NA	NA
	4	201	997	664	256	1371	924	318	1804	1205	387	2332	1535	486	2887	1890	581	3502	2280	686	4175	2710		
	6	207	1095	792	263	1509	1118	325	1989	1455	395	2556	1865	494	3169	2290	589	3849	2760	694	4593	3270		
15	2	214	967	568	272	1334	790	336	1760	1030	408	2317	1305	NA	NA	NA	NA	NA	NA	NA	NA	NA	NA	NA
	4	221	1085	712	279	1499	1006	344	1978	1320	416	2579	1665	523	3197	2060	624	3881	2490	734	4631	2960		
	6	228	1181	856	286	1632	1222	351	2157	1610	424	2796	2025	533	3470	2510	634	4216	3030	743	5035	3600		
20	2	223	1051	596	291	1443	840	357	1911	1095	430	2533	1385	NA	NA	NA	NA	NA	NA	NA	NA	NA	NA	NA
	4	230	1162	748	298	1597	1064	365	2116	1395	438	2778	1765	554	3447	2180	661	4190	2630	772	5005	3130		
	6	237	1253	900	307	1726	1288	373	2287	1695	450	2984	2145	567	3708	2650	671	4511	3190	785	5392	3790		
30	2	216	1217	632	286	1664	910	367	2183	1190	461	2891	1540	NA	NA	NA	NA	NA	NA	NA	NA	NA	NA	NA
	4	223	1316	792	294	1802	1160	376	2366	1510	474	3110	1920	619	3840	2365	728	4681	2860	847	5606	3410		
	6	231	1400	952	303	1920	1410	384	2524	1830	485	3299	2340	632	4080	2875	741	4976	3480	860	5961	4150		
50	2	206	1479	689	273	2023	1007	350	2659	1315	435	3548	1665	NA	NA	NA	NA	NA	NA	NA	NA	NA	NA	NA
	4	213	1561	860	281	2139	1291	359	2814	1685	447	3730	2135	580	4601	2633	709	5569	3185	851	6633	3790		
	6	221	1631	1031	290	2242	1575	369	2951	2055	461	3893	2605	594	4808	3208	724	5826	3885	867	6943	4620		
100	2	192	1923	712	254	2644	1050	326	3490	1370	402	4707	1740	NA	NA	NA	NA	NA	NA	NA	NA	NA	NA	NA
	4	200	1984	888	263	2731	1346	336	3606	1760	414	4842	2220	523	5982	2750	639	7254	3330	769	8650	3950		
	6	208	2035	1064	272	2811	1642	346	3714	2150	426	4968	2700	539	6143	3350	654	7453	4070	786	8892	4810		

Table 4B (continued)

Vent Height H (ft)	Vent Type	Vent Connector Diameter - D																						
		12"			14"			16"			18"			20"			22"			24"				
		Combined Appliance Input Rating in Thousands of BTU Per Hour																						
		+FAN +NAT +NAT			+FAN +NAT +NAT			+FAN +NAT +NAT			+FAN +NAT +NAT			+FAN +NAT +NAT			+FAN +NAT +NAT			+FAN +NAT +NAT				
	FAN	FAN	NAT	FAN	FAN	NAT	FAN	FAN	NAT	FAN	FAN	NAT	FAN	FAN	NAT	FAN	FAN	NAT	FAN	FAN	NAT	FAN	FAN	NAT
6	L	720	557	470	1027	792	652	1388	1069	825	1802	1386	1076	2270	1744	1328	2790	2142	1576	3365	2581	1912		
	V	900	696	588	1284	990	815	1735	1336	1065	2253	1732	1345	2838	2180	1660	3488	2677	1970	4206	3226	2390		
8	L	795	618	522	1138	882	730	1542	1193	952	2006	1549	1208	2530	1951	1488	3112	2398	1760	3756	2893	2144		
	V	994	773	652	1423	1103	912	1927	1491	1190	2507	1936	1510	3162	2439	1860	3890	2998	2200	4695	3616	2680		
10	L	861	673	570	1234	960	796	1674	1300	1040	2182	1690	1316	2755	2132	1624	3393	2622	1920	4098	3166	2336		
	V	1076	841	712	1542	1200	995	2093	1625	1300	2727	2113	1645	3444	2665	2030	4241	3278	2400	5123	3957	2920		
15	L	998	789	660	1435	1128	926	1952	1528	1208	2547	1987	1525	3221	2506	1888	3977	3090	2232	4813	3736	2720		
	V	1247	986	825	1794	1410	1158	2440	1910	1510	3184	2484	1910	4026	3133	2360	4971	3862	2790	6016	4670	3400		
20	L	1124	893	733	1605	1270	1032	2178	1718	1352	2849	2238	1712	3638	2842	2112	4458	3482	2496	5399	4209	3040		
	V	1405	1116	916	2006	1588	1290	2722	2147	1690	3561	2798	2140	4548	3552	2640	5573	4352	3120	6749	5261	3800		
30	L	1326	1062	820	1898	1514	1220	2576	2046	1592	3358	2661	2016	4242	3354	2488	5231	4126	2944	6352	4998	3584		
	V	1658	1327	1025	2373	1892	1525	3220	2558	1990	4197	3326	2520	5303	4193	3110	6539	5157	3680	7940	6247	4480		
50	L	1619	1312	1024	2329	1878	1490	3171	2546	1944	4147	3319	2460	5254	4192	3040	6493	5166	3600	7870	6250	4380		
	V	2024	1640	1280	2911	2347	1836	3964	3183	2430	5184	4149	3075	6567	5240	3800	8116	6458	4500	9837	7813	5475		
100	L	2055	1705	1336	2986	2461	1960	4100	3362	2560	5399	4407	3240	6878	5589	4000	8545	6918	4736	10403	8399	5760		
	V	2569	2131	1670	3732	3076	2450	5125	4202	3200	6749	5509	4050	8597	6986	5000	10681	8648	5920	13004	10499	7200		

# Single-Wall Vent Connector Capacities

For Multiple Category I Appliances Connected to a Common Vent

Table 5A Vent Connector Capacity

Vent Height H (ft)	Connector Rise R (ft)	Vent Connector Diameter - D																					
		3"			4"			5"			6"			7"			8"			10"			
		Appliance Input Rating Limits in Thousands of BTU Per Hour																					
		FAN			NAT			FAN			NAT			FAN			NAT			FAN			NAT
Min	Max	Max	Min	Max	Max	Min	Max	Max	Min	Max	Max	Min	Max	Max	Min	Max	Max	Min	Max	Max	Min	Max	Max
6	1	NA	NA	26	NA	NA	46	NA	NA	71	NA	NA	102	207	223	140	262	293	183	447	463	286	
	2	NA	NA	31	NA	NA	55	NA	NA	85	168	182	123	215	251	167	271	331	219	458	524	344	
	3	NA	NA	34	NA	NA	62	121	131	95	175	198	138	222	273	188	279	361	247	468	574	385	
8	1	NA	NA	27	NA	NA	48	NA	NA	75	NA	NA	106	226	240	145	285	316	191	481	502	299	
	2	NA	NA	32	NA	NA	57	125	126	89	184	193	127	234	266	173	293	353	228	492	560	355	
	3	NA	NA	35	NA	NA	64	130	138	100	191	208	144	241	287	197	302	381	256	501	609	400	
10	1	NA	NA	28	NA	NA	50	119	121	77	182	186	110	240	253	150	302	335	196	506	534	308	
	2	NA	NA	33	84	85	59	124	134	91	189	203	132	248	278	183	311	369	235	517	589	368	
	3	NA	NA	36	89	91	67	129	144	102	197	217	148	257	299	203	320	398	265	528	637	413	
15	1	NA	NA	29	79	87	52	116	138	81	177	214	116	238	291	158	312	380	208	556	596	324	
	2	NA	NA	34	83	94	62	121	150	97	185	230	138	246	314	189	321	411	248	568	646	387	
	3	NA	NA	39	87	100	70	127	160	109	193	243	157	255	333	215	331	438	281	579	690	437	
20	1	49	52	30	78	97	54	115	152	84	175	238	120	233	325	165	306	425	217	546	664	336	
	2	52	55	36	82	103	64	120	163	101	182	252	144	243	346	197	317	453	259	558	709	403	
	3	55	58	40	87	107	72	125	172	113	190	264	174	252	363	223	326	476	294	570	750	457	
30	1	47	60	31	77	110	57	112	175	89	169	278	129	226	380	175	296	497	230	528	779	358	
	2	51	62	37	81	115	67	117	185	106	177	290	152	236	397	208	307	521	274	541	819	425	
	3	54	64	42	85	119	76	122	193	120	185	300	172	244	412	235	316	542	309	555	855	482	
50	1	46	69	34	75	128	60	109	207	96	162	336	137	217	460	188	284	604	245	507	951	384	
	2	49	71	40	79	132	72	114	215	113	170	345	164	226	473	223	294	623	293	520	983	458	
	3	52	72	45	83	136	82	119	221	123	178	353	186	235	486	252	304	640	331	535	1013	518	
100	1	45	79	34	71	150	61	104	249	98	153	424	140	205	585	192	269	774	249	476	1236	393	
	2	48	80	41	75	153	73	110	255	115	160	428	167	212	593	228	279	788	299	490	1259	469	
	3	51	81	46	79	157	85	114	260	129	168	433	190	222	603	256	289	801	339	506	1280	527	

# Type B Common Vent Capacities

When Using Single-Wall Connectors

Table 5B Common Vent Capacity

Vent Height H (ft)	Vent Type	Vent Connector Diameter - D																								
		4"			5"			6"			7"			8"			10"									
		Combined Appliance Input Rating in Thousands of BTU Per Hour																								
		FAN			FAN			NAT			FAN			FAN			NAT			FAN			FAN			NAT
+FAN	+NAT	+NAT	+FAN	+NAT	+NAT	+FAN	+NAT	+NAT	+FAN	+NAT	+NAT	+FAN	+NAT	+NAT	+FAN	+NAT	+NAT	+FAN	+NAT	+NAT	+FAN	+NAT	+NAT			
6	L	NA	62	51	NA	90	80	160	126	115	243	195	157	318	248	206	523	412	326							
	V	NA	78	64	NA	113	100	200	158	144	304	244	196	398	310	257	665	515	407							
8	L	NA	70	57	NA	101	90	174	138	127	265	215	174	349	274	228	584	455	368							
	V	NA	87	71	NA	126	112	218	173	159	331	269	218	436	342	285	730	569	460							
10	L	NA	75	61	130	110	96	190	151	139	286	234	189	374	295	247	630	494	390							
	V	NA	94	76	163	137	120	237	189	174	357	292	236	467	369	309	787	617	487							
15	L	97	86	70	151	127	112	220	177	160	333	274	219	435	347	286	724	574	442							
	V	121	108	88	189	159	140	275	221	200	416	343	274	544	434	357	905	718	553							
20	L	105	94	78	166	142	124	244	198	178	370	306	242	485	390	316	810	646	501							
	V	131	118	98	208	177	155	305	247	223	436	383	302	606	487	395	1013	808	626							
30	L	116	106	90	189	162	143	280	229	206	426	357	279	562	456	367	946	762	578							
	V	145	132	113	236	202	179	350	286	257	533	446	349	703	570	459	1183	952	723							
50	L	127	116	102	214	186	163	325	270	237	498	423	328	666	549	428	1134	926	670							
	V	159	145	128	268	233	204	406	337	296	622	529	410	833	686	535	1418	1157	838							
100	L	133	122	NA	238	210	NA	375	318	NA	581	506	371	799	677	485	1393	1167	758							
	V	166	153	NA	297	263	NA	469	398	NA	726	633	464	999	856	606	1741	1459	948							

### Additional Guidelines for Multiple-Appliance Venting

When common-venting, connector Tables 4A and 5A allow for connector lateral lengths of 1½ feet (18 inches) for each inch of connector diameter as follows:

#### Connector Lateral Length Allowance

Diameter	3"	4"	5"	6"	7"	8"	10"	12"	16"	24"
Length, Ft.	4½	6	7½	9	10½	12	15	18	24	36

**Table 3**

It is permissible to double the length shown by reducing the maximum connector capacity by 10%. Next, determine FAN MIN by using the corresponding single-appliance table treating each appliance and connector along with the common vent as a single-appliance vent system. If the input is still above FAN MIN, go ahead and double the connector length.

If the vent connectors are combined prior to entering the common vent (Figure 4D, page 7), the maximum common vent capacity shall be reduced by 10%. The horizontal length allowance shall not exceed 1½ feet (18 inches) for each inch of common vent manifold diameter. This length limitation also includes the common vent offset in the attic added together.

When manifolding a fan-assisted appliance with a draft-hood-equipped appliance, the fan-assisted appliance should be positioned closer to the common vertical vent.

If the common vent has a horizontal offset (Figure 4C, page 7), the maximum common vent capacity shall be reduced by 20%, the equivalent of two 90° elbows. This 20% reduction is listed in the L line in Tables 4B and 5B. The horizontal length of the common vent offset shall not exceed 1½ feet for each inch of common vent diameter. A 10% reduction in common vent capacity must be taken for each additional 90° fitting.

The common vent diameter shall be at least as large as the largest vent connector diameter.

Interpolation is permitted between table entries. Extrapolation beyond table entries is not permitted.

The “7 times rule” (page 9) also limits the size of the common vent to no more than 7 times the cross-sectional area of the smallest connected appliance vent connector or flue collar area; do not use the connector pipe area.

### Additional Guidelines for Multiple-Appliance Venting

#### Use available headroom for maximum connector rise

Always use available headroom for maximum connector rise after allowing for the listed clearance to combustibles. Obtain maximum connector rise by such methods as extending the connectors between the floor joists. Increased venting power and efficiency of the system permits reduction of vent and connector sizes.

#### Alternate ways for increasing vent height and connector rise

If a combined vent cannot be used because of limitations in connector rise or total vent height, alternatives such as those illustrated (Figure 7) may be used to secure greater connector rise or greater total vent height. Type B GAS VENT CONNECTOR must be used for Figure 7B.

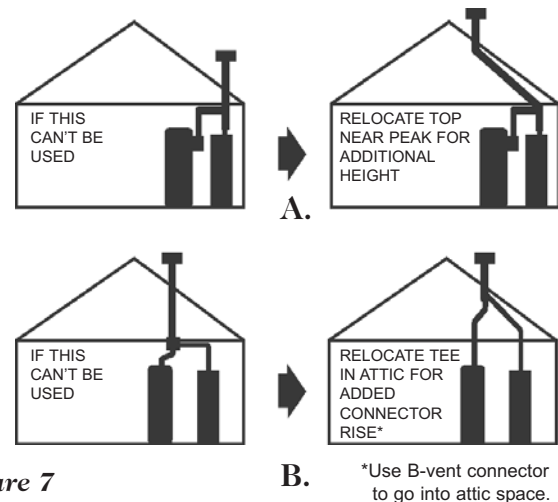

**Figure 7**



## Type B Double-Wall Gas Vents

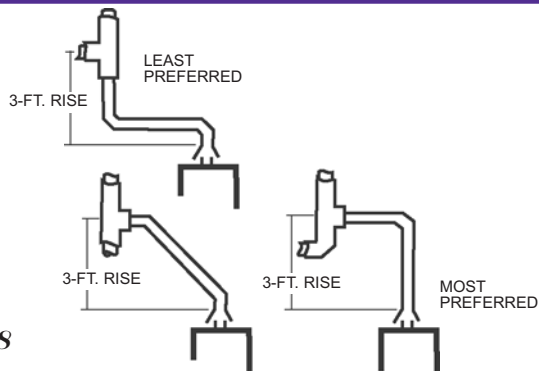

Figure 8

The configurations of the vent connector are not as important as the connector rise and length requirements being satisfactorily met. All of the illustrated methods in Figure 8 permit correct vent operation.

### For economy, consider all alternatives

It is important in a combined vent system that the cost of individual versus combined vents be considered, especially if the system is short or many fittings are needed.

Frequently, individual vents will prove more economical than a combined system in instances of this type (Figure 9).

SHORT COMBINED VENTS  
MAY REQUIRE EXCESSIVE  
FITTINGS, EXTRA LARGE  
COMMON VENT

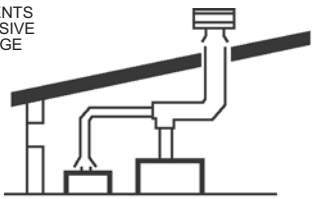

INDIVIDUAL VENTS CAN  
PROVIDE BETTER VENTING  
AT LESS COST

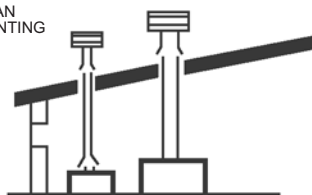

Figure 9

### Self-venting connectors sized from single-appliance vent tables

When a vent connector as a part of a combined vent system has a rise of 5 feet or more, it can be installed as though it were an individual vent by using the appropriate Single-Appliance Vent Tables. It is important when sizing self-venting connectors that allowances be made for lateral length and the number of turns.

### When in doubt use one size larger vent

It is neither possible nor practical in some cases to anticipate all installation or operational contingencies in designing a vent system. A safe rule is, when in doubt use one size larger connectors and common vents than required by the Vent Tables.

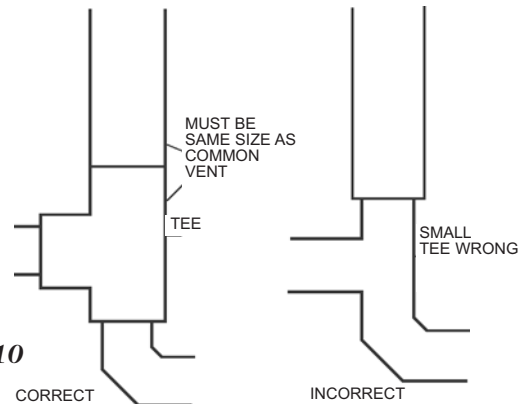

Figure 10

### Size of interconnecting tees

Interconnecting tees must be the same size as the common vent, as shown in Figure 10.

### Use of Manifolds

#### Use of Line V Capacities for Manifold Sizing

A manifold is merely a vent system that is a horizontal extension of the lower end of a common vent. The connection of a manifold to a common vent may be made by either a 90° elbow or tee. A manifold should be sized as a common vent, using the combined total capacity and applicable total height of the vent system. The V lines in the common vent table must be reduced by 10% to determine the capacity of the manifold and common vent. There is also the horizontal length limitation of 1.5 feet per inch of common vent that must be followed.

#### Horizontal Versus Sloped Manifolds

Some codes require pitched or sloped manifolds. The requirements for sloped manifolds or connectors is a necessity for vent systems having low insulating values where condensation may occur. Adequate connector rise is necessary for proper venting of all appliances; therefore, lateral manifolds should NOT be excessively sloped. Too much manifold slope may cause insufficient connector rise at the appliance farthest from the common vent, increasing the chance of draft-hood spillage.



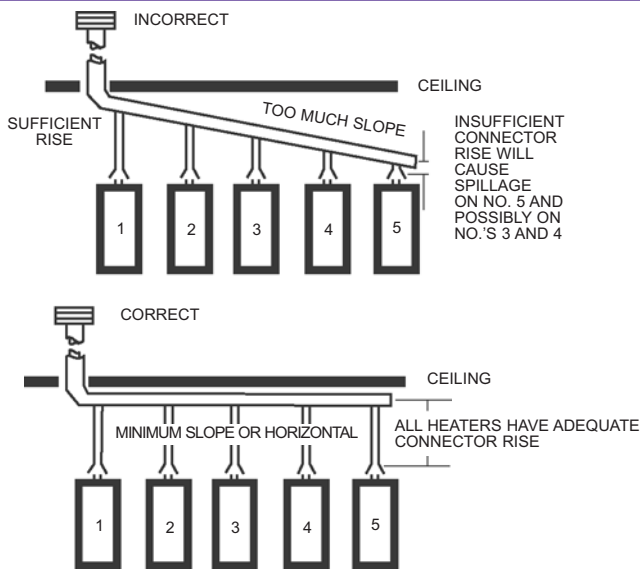

**Figure 11**

### Manifold Connectors

Vent connectors from a group of appliances on one level may enter from below or from the side of the manifold. In either case, the connector rise should be measured as the vertical distance from the draft-hood outlet to the lowest level at which the connector enters the manifold. Care must be exercised in designing these systems, especially with connector turns and lengths, because heat loss is apt to be greater for such systems causing accompanying capacity reduction.

### Sizing of Manifolds

As shown in Figure 12, manifolds may be designed either as (1) tapered or (2) constant size. Choice is dictated on the basis of convenience and cost.

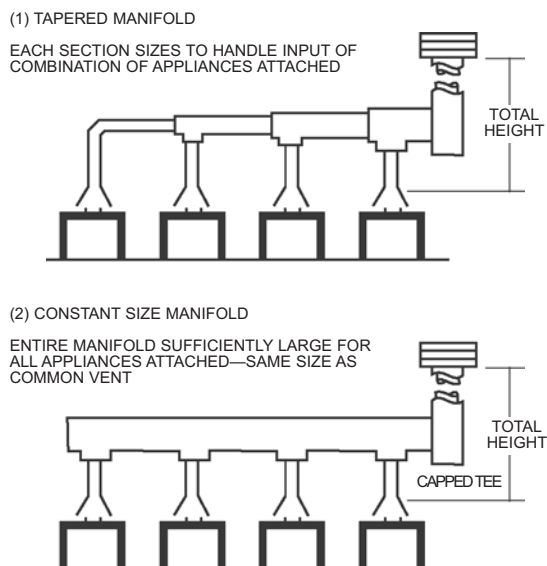

**Figure 12**

### Tapered

Use total heat input to each portion of manifold under construction, using V capacities with a 10% reduction from Common Vent Table at total vent height.

### Constant Size

Determine the required size of the common vent, based on total input and total vent height, using V capacities with a 10% reduction from Common Vent Table and then use this size for the entire manifold.

### Table Limitations

When three or more appliances are connected to the same manifold, the largest CANNOT exceed 7 times the input of the smallest one. No more than eight appliances of identical input may be connected to the same manifold, unless the Tabled Capacity is reduced by 10% or using a connector rise of at least 3 feet. Manifold lengths shall not exceed 1½ feet for each inch of manifold diameter. This length limitation also incorporates any offsets in the vertical common vent.

### Multiple-Story Venting

A multiple-story vent system serves gas appliances at two or more different levels of a building. In designing multiple-story vent systems, use the Vent Connector and Multiple-Appliance Vent Tables. When properly designed, such multiple-story vent systems will function satisfactorily when combinations of one appliance to all appliances on the system are operating.

Figures 13 and 14 illustrate the major principles of multiple-story installation, which are as follows:

- The overall system should be divided into smaller simple combined vent systems for each level, using a minimum total vent height for each level as illustrated.
- Each vent connector from the appliance to the common vent should be designed from the Vent Connector Table as in multiple-appliance vent systems.
- For sizing of the common vent section, the Common Vent Table is used. The common vent for each system must be sized large enough to accommodate the accumulated total input of all appliances discharging into it, but should NEVER be smaller in area than the largest section below it.
- The vent connector from the first floor or the lowest appliance to the common vent is designed as if terminating at the first tee or interconnection. The next lowest appliance is considered to have a combined vent that terminates at the second interconnection. The same principle continues on to the highest connecting appliance, with the top-floor appliance having a total vent height measured to the outlet of the common vent. The multiple-story system has no limit in height, as long as the common vent is sized to accommodate the total input.

**CAUTION:** It is important to keep the following points in mind.

- Common vent height must always be computed as the distance from the outlet of the connected appliance to the lowest part of the opening from the next interconnection above.
- If the connector rise is inadequate, increase connector size, always making sure of maximum available connector rise.
- Be sure that the air supply to each appliance is adequate for proper operation. A separation of appliance rooms from occupied areas and provision for outside air supply is necessary.
- If an air shaft is used for installation of the common vent, be sure that sufficient space is provided for fittings, clearance to combustibles, and access for proper assembly.
- These calculations apply ONLY when the entire system is constructed of listed double-wall Type B Vent materials.

#### Ratio of Connector Size to Common Vent Size

Whenever the area of the common vent becomes more than 7 times the area of the vent connector entering it, the connector rise must be increased one foot above the allowable vent connector rise shown in the Tables. For example, where appliance input is 90,000 BTU per hour using a 5-inch (area 20 square inches) vent connector in a system having a minimum vent height of 10 feet, the vent connector rise must be 2 feet on the lower floors where the common vent size is 12 inches (area 113 square inches) or less. However, as soon as a larger common vent size is required, such as 14 inches (area 154 square inches), the vent connector rise must be increased to 3 feet to avoid draft hood spillage.

This requirement does NOT apply when the connector rise is originally over 5 feet and consequently self-venting.

#### Offsets in Multistory Vents

A multistory common vertical vent may have a single offset, provided:

- The offset does not exceed 45°, and
- The section of common vent that contains the offset shall be reduced by 20%, and
- The horizontal length of the offset does not exceed 1½ feet for each inch of common vent diameter.

#### Economy of Parallel Systems

It may frequently prove more economical to group appliances to upper and lower common vent systems so that smaller vent sizes can be used. Even though many appliances may be connected to a single multiple-story common vent, the increase in size caused by this may prove uneconomical because of the space for access required and the need for numerous fittings. An alternate procedure is to use parallel common vents with staggered connections at alternate floors, thereby greatly increasing the minimum total vent height available to each connected appliance.

#### Example of Multiple-Story Systems

To give an example of the method of using the tables for multiple-story venting, consider Figure 14 as a four-story apartment with each natural draft heater arrangement as follows: 90,000 BTU/L input, 5" draft hood, 1-foot connector rise, 10-foot vent height for lower three floors, 6-foot vent height for top floor, B-vent being used for complete system. The Common Vent is vertical, so use V lines of Table 4B under NAT+NAT column for figuring common vent size. Table 6 shows the calculations for venting all four floors into the common vent.

CONNECTOR: SIZE (1) DEPENDS ON  
(2) DRAFT HOOD OR COLLAR SIZE  
(3) APPLIANCE INPUT  
(4) RISE  
(5) TOTAL HEIGHT

COMMON VENT SIZE (6) DEPENDS ON  
(5) TOTAL HEIGHT AND  
(7) TOTAL INPUT OR  
(8) LARGEST ENTERING  
CONNECTOR OR COMMON VENT

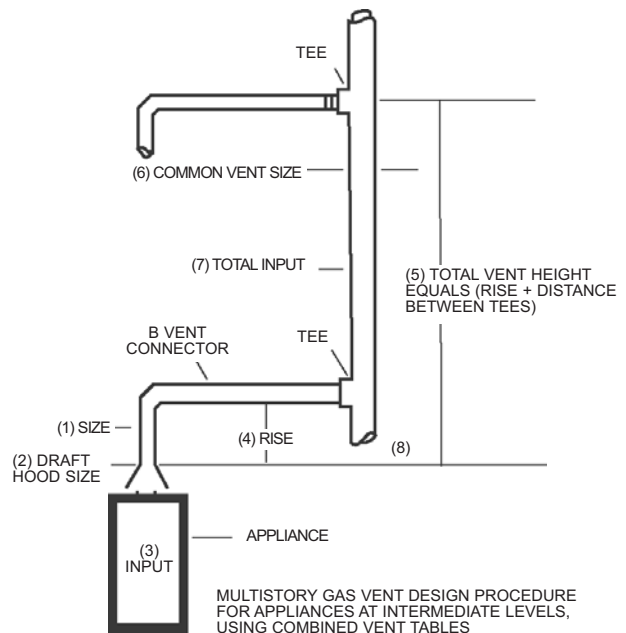
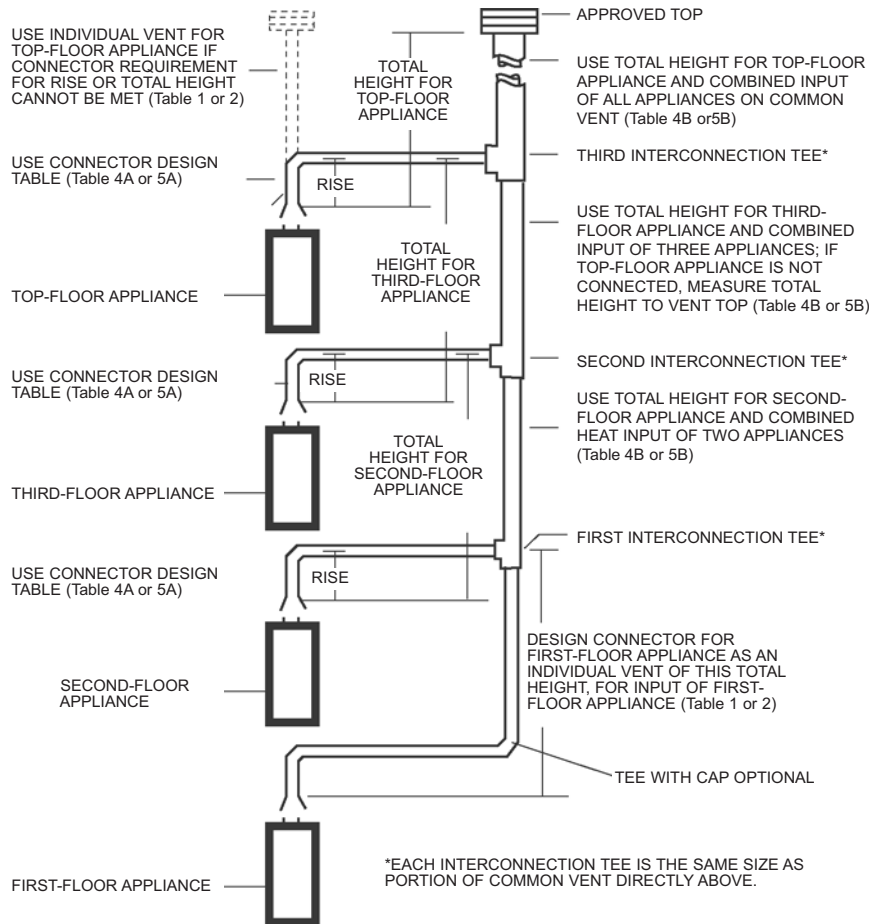

Figure 13



**Figure 14**

PRINCIPLES OF DESIGN OF MULTISTORY VENTS USING VENT CONNECTOR AND COMMON VENT DESIGN TABLES

## Type B Double-Wall Gas Vents

**Table 6**

Appliance	Input Total BTUH To Common Vent	Available Connector Rise	Min. Total Vent Height	Connector Size	Common Vent Size
1	90,000	10'	10'	5" with up to 10' lateral	self-venting connector
2	180,000	1'	10'	6"	7"
3	270,000	1'	10'	6"	8"
4	360,000	1'	6'	6"	10"

However, if the heater on the top floor is vented separately, Table 7 shows the result of increasing the *Minimum Total Vent Height* of the third-floor appliance to 16 feet and decreasing total input to the common vent to 270,000 BTU per hour.

Table 7 indicates the economics of venting the top floor separately, which eliminates the larger sizes of vent pipe and the use of costly increasing fittings.

# Type B Double-Wall Gas Vents

Table 7

Appliance	Input Total BTUH To Common Vent	Available Connector Rise	Min. Total Vent Height	Connector Size	Common Vent Size
1	90,000	10'	10'	5"	self-venting connector
2	180,000	1'	10'	6"	7"
3	270,000	1'	16'	6"	7"
4	90,000	6'	6'	5"	self-venting connector

## Special Considerations and Additional Precautions

A. *COMBUSTION AIR* requirements MUST be supplied from outside the living areas from sources such as hallways, service areas or outdoor balconies in accordance with the information in NFPA Standard 54 ANSI Z223.1. It is preferred that this air be taken into the appliance room directly from outdoors. This is important because any restriction in the common vent or termination will cause flue products of all appliances below this obstruction to spill out the draft hoods of other appliances just below this obstruction.

### B. Other Cautions

1. Provide proper clearance to combustibles around the common vent in its chase or shaft.
2. Use the highest connector rise possible. If capacity is borderline, use the next size connector.
3. The only draft effect to be considered available is due to the vertical height from the draft-hood relief opening of the highest appliance on that floor to the point where the connector for the floor above enters the common vent. NEVER USE THE HEIGHT TO THE TERMINATION except for the top floor.
4. The appliance on the first floor is considered to be self-venting (vertical height 5 feet or more), and therefore sizing is calculated using Table 2 Single-Appliance Venting.



**Factory-Built  
All-Fuel Chimney Systems  
Sizing Guide**

2

# Model TLC All-Fuel Chimney System

## Description

The Hart & Cooley® MODEL TLC all-fuel chimney system consists of straight sections and other necessary fittings, which are constructed of stainless steel outer jacket and stainless steel inner liner spaced one inch smaller to provide an enclosure for solid pack insulation. This chimney system may be fully enclosed by the structure when the minimum clearance airspace of 2 inches is maintained to all materials of the structure or contents—THIS MEANS NO INSULATION IS TO BE WRAPPED OR PACKED AROUND THIS CHIMNEY SYSTEM CLOSER THAN 2 INCHES, UNLESS USING INSULATION PROVIDED BY HART & COOLEY FOR SPECIFIC USES. Follow installation instructions.

## Appliances That May Be Connected

This system is to be used with all neutral or negative draft gas, liquid, or solid fuel-fired residential appliances and other building heating appliances that produce flue products up to 1000°F during normal operation and up to 1400°F for up to one hour of unusual firing, and to 2100°F for up to 10 minutes at a time.

This system is listed by Underwriters Laboratories as complying with Standard UL 103-HT. FOR PROPER INSTALLATION, READ AND FOLLOW THE INSTALLATION INSTRUCTIONS PACKED WITH PRODUCT.

## Preliminary Planning

Check the local building code for additional installation requirements for the area. The National Fire Protection Association Standards 31 and 211 require that the chimney extend at least 3 feet above the highest side of the roof opening through which the chimney passes AND at least 2 feet higher than any portion of the building within a 10-foot horizontal distance. See Figure 16.

- Make a sketch of the proposed chimney system.

Locate the chimney near the appliance, taking care that all structural and other obstructions are considered. Measure and note horizontal and vertical sections to be needed plus all elbows and other fittings.

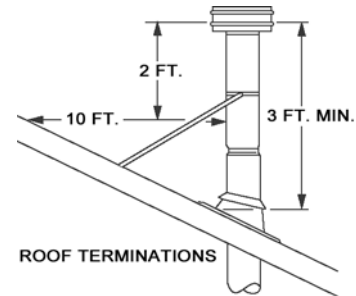

Figure 16

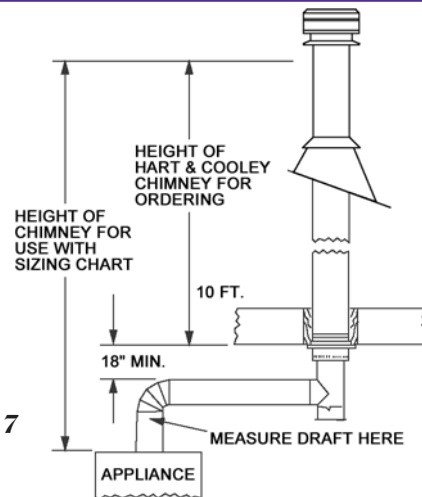

Figure 17



# Oil-Fired Appliance Chimney Sizing

(Tables based on steady state efficiency. Content from NFPA 31, 2006 Edition.)

# 2

**Chimney Sizing for 88% Steady State Appliances (10-14% CO<sub>2</sub>, 300°F gross)**

System Height, Ft.	Lateral, Ft. w/ (2) 90° turns	GPH for 6" dia	GPH for 5" dia	GPH for 4" dia
10	4	0.5-1.0	0.4-0.65	0.25
	10	0.4-0.75	NR	NR
15	4	0.65-1.25	0.4-0.75	0.4
	10	0.5-1.0	0.4-0.75	0.4
20	4	0.65-1.5	0.5-0.85	0.4
	10	0.65-1.25	0.65-0.85	0.4-0.5
25	4	0.75-1.5	0.65-1.0	0.5
	10	0.85-1.25	0.65-0.85	0.5
35	4	1.0-1.75	0.75-1.0	0.5
	10	1.0-1.5	0.75-1.0	0.5
40	4	1.25-1.75	0.85-1.0	0.65
	10	1.25-1.75	0.85-1.0	0.65

GPH (gallons per hour firing rate) \* 140,000 = BTU/hr input  
 NR: Not recommended  
 Flexible liners: reduce max GPH by 15% due to higher flow losses  
 Calculations based from draft set at -0.03" of water at appliance outlet

**Chimney Sizing for 86% Steady State Appliances (10-14% CO<sub>2</sub>, 370°F gross)**

System Height, Ft.	Lateral, Ft. w/ (2) 90° turns	GPH for 6" dia	GPH for 5" dia	GPH for 4" dia
10	4	0.4-1.25	0.4-0.85	0.25-0.5
	10	0.4-1.25	0.4-0.75	0.25
15	4	0.5-1.5	0.4-1.0	0.4-0.5
	10	0.5-1.25	0.4-0.85	0.4-0.5
20	4	0.65-1.75	0.5-1.0	0.4-0.5
	10	0.65-1.5	0.5-1.0	0.4-0.5
25	4	0.75-1.75	0.5-1.0	0.4-0.5
	10	0.75-1.75	0.65-1.0	0.4-0.5
35	4	0.85-2.0	0.65-1.25	0.5-0.65
	10	0.85-2.0	0.65-1.25	0.5-0.65
40	4	1.0-2.25	0.75-1.25	0.65-0.75
	10	1.0-2.0	0.85-1.25	0.65-0.75

GPH (gallons per hour firing rate) \* 140,000 = BTU/hr input  
 NR: Not recommended  
 Flexible liners: reduce max GPH by 15% due to higher flow losses  
 Calculations based from draft set at -0.03" of water at appliance outlet

**Chimney Sizing for 84% Steady State Appliances (10-14% CO<sub>2</sub>, 440°F gross)**

System Height, Ft.	Lateral, Ft. w/ (2) 90° turns	GPH for 6" dia	GPH for 5" dia	GPH for 4" dia
10	4	0.4-1.5	0.25-0.85	0.25-0.5
	10	0.4-1.25	0.25-0.85	0.25-0.4
15	4	0.5-1.75	0.4-1.0	0.25-0.65
	10	0.65-1.5	0.4-1.0	0.4-0.5
20	4	0.65-1.75	0.5-1.25	0.4-0.65
	10	0.65-1.75	0.5-1.0	0.4-0.5
25	4	0.65-2.0	0.5-1.25	0.4-0.75
	10	0.65-2.0	0.5-1.25	0.4-0.65
35	4	0.85-2.25	0.65-1.5	0.5-0.75
	10	0.85-2.25	0.65-1.25	0.5-0.75
40	4	1.0-2.25	0.75-1.5	0.65-0.75
	10	1.0-2.25	0.75-1.5	0.65-0.75

GPH (gallons per hour firing rate) \* 140,000 = BTU/hr input  
 NR: Not recommended  
 Flexible liners: reduce max GPH by 15% due to higher flow losses  
 Calculations based from draft set at -0.03" of water at appliance outlet

**Chimney Sizing for 82% Steady State Appliances (10-14% CO<sub>2</sub>, 505°F gross)**

System Height, Ft.	Lateral, Ft. w/ (2) 90° turns	GPH for 6" dia	GPH for 5" dia	GPH for 4" dia
10	4	0.4-1.5	0.25-1.0	0.25-0.5
	10	0.4-1.5	0.25-0.85	0.25-0.5
15	4	0.4-1.75	0.4-1.25	0.25-0.65
	10	0.4-1.75	0.4-1.0	0.25-0.65
20	4	0.5-2.0	0.4-1.25	0.4-0.75
	10	0.5-2.0	0.4-1.25	0.4-0.75
25	4	0.5-2.25	0.5-1.5	0.4-0.75
	10	0.65-2.0	0.5-1.25	0.4-0.75
35	4	0.65-2.25	0.65-1.5	0.5-0.85
	10	0.75-2.25	0.65-1.5	0.5-0.85
40	4	0.75-2.25	0.75-1.5	0.5-0.85
	10	0.85-2.25	0.75-1.5	0.5-0.85

GPH (gallons per hour firing rate) \* 140,000 = BTU/hr input  
 NR: Not recommended  
 Flexible liners: reduce max GPH by 15% due to higher flow losses  
 Calculations based from draft set at -0.03" of water at appliance outlet

**Chimney Sizing for 80% Steady State Appliances (10-14% CO<sub>2</sub>, 575°F gross)**

System Height, Ft.	Lateral, Ft. w/ (2) 90° turns	GPH for 6" dia	GPH for 5" dia	GPH for 4" dia
10	4	0.25-1.75	0.25-1.0	0.25-0.65
	10	0.4-1.5	0.25-1.0	0.25-0.65
15	4	0.4-2.0	0.4-1.25	0.25-0.75
	10	0.5-2.0	0.4-1.25	0.25-0.75
20	4	0.4-2.25	0.4-1.5	0.4-0.85
	10	0.4-2.0	0.4-1.25	0.4-0.75
25	4	0.4-2.25	0.4-1.5	0.4-0.85
	10	0.65-2.25	0.5-1.5	0.4-0.85
35	4	0.5-2.25	0.5-1.75	0.4-0.85
	10	0.65-2.25	0.65-1.5	0.4-0.85
40	4	0.65-2.25	0.65-1.75	0.5-1.5
	10	0.65-2.25	0.65-1.75	0.5-0.85

GPH (gallons per hour firing rate) \* 140,000 = BTU/hr input  
 NR: Not recommended  
 Flexible liners: reduce max GPH by 15% due to higher flow losses  
 Calculations based from draft set at -0.03" of water at appliance outlet

## Determining steady state efficiency by AFUE:

- Add 1% to AFUE for hydronic boiler.
- Add 2% to AFUE for warm-air furnace.

# Model TLC All-Fuel Chimney System

**Table 9** Chimney Sizing for Lower Efficiency Oil-Fired Appliances  
 (600°F temperature rise at 9% CO<sub>2</sub>)

Input BTUH X 1000	Chimney Diameter	90° Turns Equiv. Ft.*	Chimney Draft Specified, inches w.c.						
			0.04	0.05	0.06	0.07	0.08	0.09	0.10
			Minimum Chimney Height, Ft.						
100	6	1	6	7½	9	10½	12	13½	15
	7	1	5½	7	8½	10	11½	12½	14
	8	1	5½	7	8	9½	11	12	13½
200	6	2	6½	8½	10	11½	13½	15	16½
	7	1½	6½	8	9½	11	12½	14	16
	8	1	6	7½	9	10½	12	13½	15
300	10	1	6	7	8½	10	11½	13	14½
	6	4½	7½	9½	11	12½	15	16½	18½
	7	3	7	8½	10	12	13½	15	17
400	8	1½	6½	8	9½	11	13	14½	16
	10	1	6	7½	9	10½	12	13½	15
	12	1	6	7½	9	10½	12	13½	15
500	8	4	7½	9	11	12½	14½	16½	18
	10	2	6½	8	9½	11½	13	14½	16
	12	1	6	7½	9	10½	12	13½	15
600	14	1	6	7½	8½	10	11½	13	14½
	10	2½	7	8½	10	12	13½	16	17
	12	1½	6½	8	9½	11	12½	14	15½
700	14	1	6	7½	9	10½	12½	14	15½
	10	3½	7	9	10½	12½	14	16	17½
	12	1½	6½	8	9½	11	13	14½	16
800	14	1	6	7½	9	10½	12½	14	15½
	10	4½	7½	9½	11	13	14½	16½	18
	12	2½	7	8½	10	11½	13½	15	16½
900	14	1	6½	8	9½	11	12½	14	15½
	12	3	7	8½	10	12	14	15½	17
	14	2	6½	8	9½	11½	13	14½	16
1000	12	3½	7	9	10½	12½	14	16	17½
	14	2	6½	8½	9½	11½	13	14½	16
1100	12	4	7½	9	10½	12½	14½	16	18
	14	2	6½	8½	10	11½	13½	15	16½
1200	12	4½	7½	9½	11	13	15	16½	18½
	14	2½	7	8½	10	12	13½	15½	17
1300	14	3	7	9	10½	12	14	15½	17½
1400	14	3½	7	9	10½	12½	14	16	17½
1500	14	4	7½	9	11	12½	14½	16½	18

\*For EACH 90° turn (tee, elbow), ADD this value to Tabled Height figure to get ACTUAL vertical height required.  
 GPH x 140,000 = BTUH

## Chimney Sizing for Appliances Using Table 9

### Example

#### GIVEN:

- Input is 700,000 BTUH.
- Draft required is 0.04 inches w.c.
- System contains one 90° elbow and one tee.
- Collar size of appliance is 10 inches.

**SOLUTION:** Find Input 700 (thousand) BTUH in the left column and 0.04 inches w.c. draft at the top of the table. Adjacent to the Input column is a column giving multiple

choices of chimney sizes. For a trial, use the flue collar size of 10 inches. Adjacent to the 10-inch size is a figure 3½, which is explained as the feet that must be added for EACH 90° turn. Proceed to right from 700 figure, then the 10-inch size horizontally to the right until it intersects the 0.04 vertical column. The height shown is 7 feet. There are two 90° turns required (the 90° elbow and tee given); therefore, 7 feet must be added (2 times 3½) to the 7 feet given in the table. The required chimney height is then 14 feet (7+7). A larger size chimney will result in a lower total height if such is required.

## Chimney Sizing for Open-Face Fireplaces

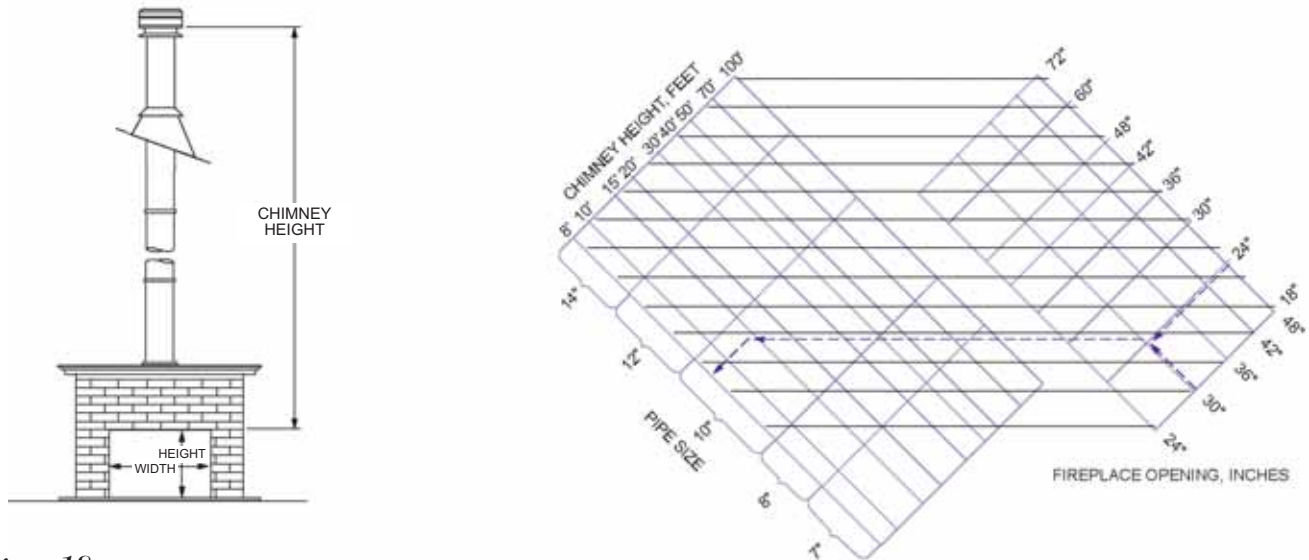

**Figure 18**

### Example—Note Purple Line

#### GIVEN:

- Fireplace opening size 30 inches x 24 inches.
- Desired height from top of opening to top of chimney 15 feet.

**SOLUTION:** At right-hand section of chart, find intersection of 30-inch and 24-inch lines. Proceed horizontally to left until 15-foot height line is intersected. This intersection occurs within the limits of a 10-inch chimney size.

## Notes

New products will be added to our line as new developments in environmental technology take place and market needs change. Hart & Cooley is committed to quality; therefore, careful research, design and testing take place before any new product release.

Hart & Cooley, Inc. has built its reputation as the industry leader on design and quality performance. We intend to keep it that way.

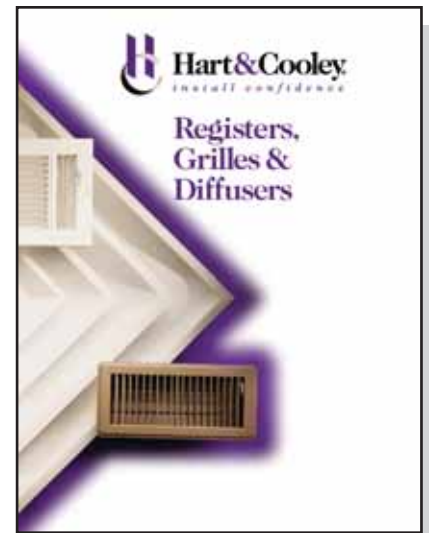

Form No. 010050

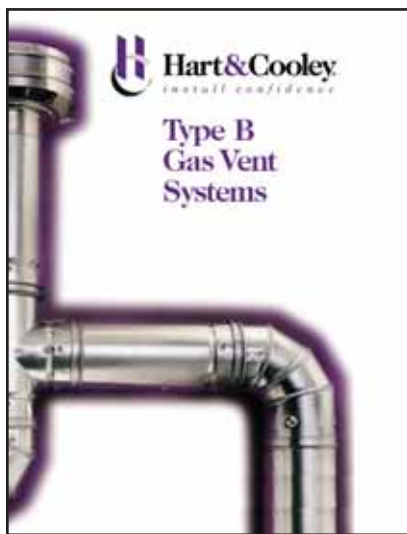

Form No. 010051

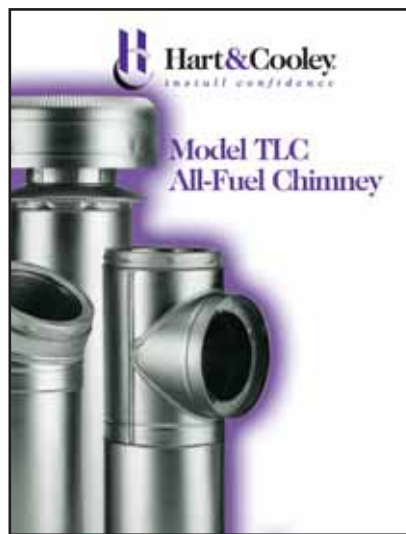

Form No. 851343

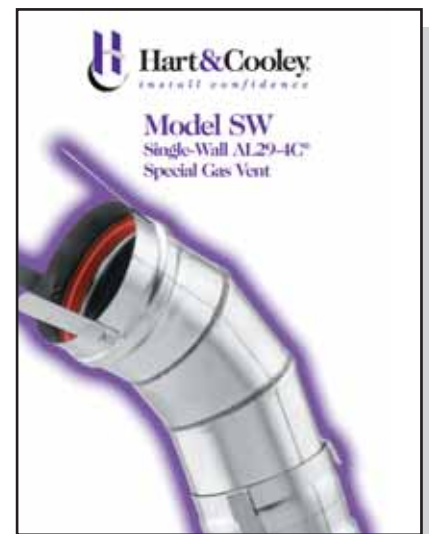

Form No. 851369

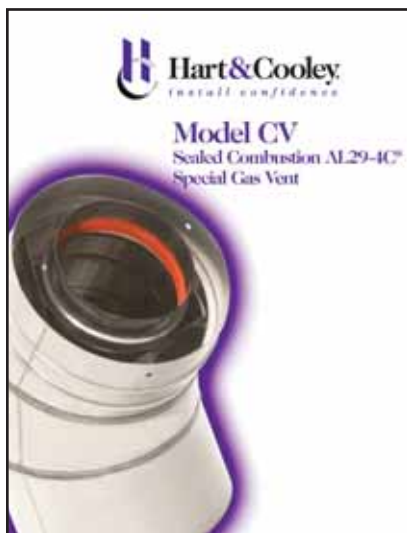

Form No. 851367



Form No. 851095

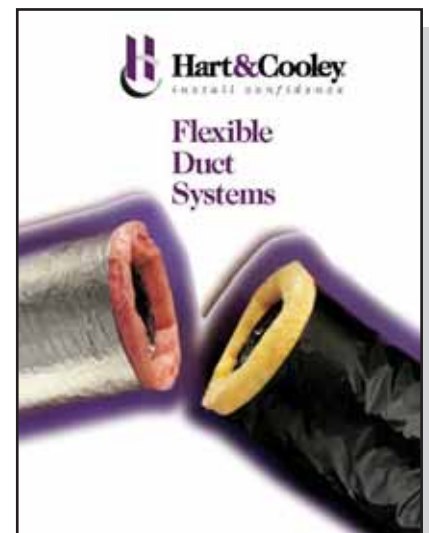

Form No. 010054

To order any of the above catalogs, please contact  
Customer Service toll-free at 800.433.6341.





**Hart & Cooley**  
*install confidence*

Hart & Cooley, Inc. 800.433.6341 *p*  
5030 Corporate Exchange Blvd. SE 616.656.8200 *p*  
Grand Rapids, MI 49512 800.223.8461 *f*  
info@hartandcooley.com 616.656.6399 *f*  
www.hartandcooley.com

Offered by:

**[www.hartandcooley.com](http://www.hartandcooley.com)**

For submittal information and other literature visit our Website.

