MILLER

AG-BAG®

OPERATOR'S MANUAL

MODEL: PB6000

DO NOT OPERATE THIS EQUIPMENT UNTIL THIS
MANUAL HAS BEEN READ AND UNDERSTOOD.

Part Number: 42.0900898
January 2007



MILLER-ST.NAZIANZ,INC.
P.O. BOX 127
ST. NAZIANZ, WI 54232
920/773-2121
FAX:920/773-1200

INTRODUCTION

This Operator's Manual is provided to acquaint the operator with the safety and operation of the Miller Ag-Bag series 6000 bagger. Complete Assembly, Operation, Lubrication and Maintenance procedures are provided. Following the recommended procedures will help you achieve many years of dependable service.

This manual is considered part of your machine and should remain with the machine at all times.

Make sure the operator reads and understands the manual before placing the bagger into operation.

Failure to follow the recommended procedures may result in injury and equipment damage, and could void the warranty.

MACHINE SERIAL NUMBER



The machine serial number is located on the rear frame next to the bag boom tube. For your convenience refer to this number and your product model number when requiring service or parts information. Record the machine serial number, model number, date of purchase and dealership name in the space provided below.

Date Purchased _____
Model No. _____ Serial No. _____
Dealership _____

Right and Left Hand sides are determined from a position standing at the rear (tunnel side) of the unit looking toward the hitch.

This Operator's Manual uses the term "Tractors" when identifying the power source for the bagger.

The Delivery and Warranty Registration Card found in the front of this manual must be completed and signed to validate your warranty protection. You must read and understand the places where you attest to having received instructions as to care, adjustments, safe operation and applicable warranty policy. The terms and conditions of the warranty are specified on the rear cover of this manual.



WARNING

SOME PHOTOGRAPHS USED HEREIN MAY SHOW DOORS, GUARDS AND SHIELDS OPENED OR REMOVED. BE SURE THAT ALL DOORS, GUARDS AND SHIELDS ARE FASTENED IN THEIR PROPER POSITION BEFORE MACHINE IS OPERATED!

Table Of Contents

BAGGER CHECK LISTS	4
SAFETY PRECAUTIONS	5-6
Power Source Shutdown Procedure	5
SAFETY DECALS	7-10
Reflective Decals	11
SET-UP AND ASSEMBLY	12-14
Assemble Bag Boom (Optional)	12
Assemble Bag Pan	13
Prepare the Backstop	14
OPERATION	16-37
Pre-Operation Checklist	16
Set The Backstop In Position	17
Assemble PTO Shaft To Bagger and Tractor	19
Hook Tractor To Tow Hitch	19
Connect Hydraulic Lines	21
Connect The Inoculant Applicator (Units so equipped)	21
Bag Identification	22
Bag Installation	23
Seal The Beginning End Of The Bag	26
Hooking Up The Backstop	27
Lower Conveyor to Operating Position	28
Bagging Operation	29
Remove Bagger From Bag	32
Venting The Bag	33
Changing Bagger To Transport Position	34
BAGGING INSTRUCTIONS	38-43
Bag Information	41
ADJUSTMENTS	44-45
Conveyor Chain	44
Rotor Drive Chain	45

Continued On Next Page

Table of Contents - continued

LUBRICATION AND MAINTENANCE	46-56
Tire Air Pressure	46
Wheel Lug Nut Torque	46
Rotor Bearings	46
Cable Drum Shaft Bearings	47
Upper Conveyor Apron Shaft Bearings	48
Lower Conveyor Apron Shaft Bearings	49
Lower Conveyor Clean Out	49
PTO Shaft	50
Bag Boom Pivot (If so equipped)	50
Wheel Bearings	51
Rotor Drive Chain	52
Gear Box Oil	53
Cable Drum Brake Pads	54
Rotor Tooth Tine Caps	55
Cables	56
Hydraulic Hand Pump	56
TROUBLESHOOTING	57-58
STORAGE	59
TORQUE SPECIFICATIONS	60-61
Tightening Hydraulic Fittings	61
MACHINE SPECIFICATIONS	62
LUBRICATION SPECIFICATIONS	63
WARRANTY	INSIDE BACK COVER

This Page Intentionally Left Blank

Bagger Check Lists

Pre-Delivery and Delivery Check Lists (customer and dealer copies) follow this page.

Customer copies can remain with this manual.

Dealer copies can be removed along perforation and remain with dealer.



A Miller St. Nazianz Co.

PB6000 / G6060 / G6070 Ag-Baggers

Dealer Pre-Delivery Check List

After the Bagger has been completely set-up, the following inspections Must be made before delivering it to the customer. Check off each item after prescribed action is taken.

- No parts of the unit have been damaged in shipment. Check for such things as dents and loose or missing parts, scratches: touch up or replace components as required.
- All bolts and fasteners are in place and tightly secured.
- The gear box is filled to proper oil level – EP 80/90 Gear Lube.
- Make sure conveyor slides properly, grease if necessary.
- All guards, shields and decals are in place and securely attached.
- All chains are properly tightened:
 - Conveyor drive and driven chain
 - Rotor drive chain
 - Hydraulic pump drive chain
- Brake system properly tightens and releases.
- Install bungee cord on tunnel & bag pan.
- String backstop – see operator’s manual
- Hook the Bagger to the appropriate RPM tractor and test run while checking that proper operation is exhibited by all components.**
- Wheels are properly attached and tires are properly inflated: 9.5L x 15 @ 44 PSI, LT 235 / 85R16 @ 80 PSI, LT 265 / 75R16 @ 80 PSI
- As applicable, the cylinders, hoses and fittings are NOT damaged, leaking or loosely connected.
- Hydraulic oil reservoir is filled to proper level.
- All grease fittings have been properly lubricated and drive chains oiled; see lubrication chapter in the owner’s manual.
- Make sure hitch fits properly in both the transport and operating positions.
- All drive & driven sprockets aligned properly:
 - Conveyor drive chain sprockets
 - Rotor drive chain sprockets
 - Hydraulic pump drive chain sprockets
- Clean brake rotor before delivery.
- Install back stop hook assembly – see operator’s manual.
- Bag boom works properly (If so equipped)

Check that:

- Transport lights work properly.
- PTO Shield turns freely.
- All drives and mechanisms are operating smoothly and properly adjusted.
- All hydraulic system components are functioning properly.

I acknowledge that pre-delivery was performed on this unit as outlined.

Dealership’s Name

Dealer Representative’s Name Date

Customer’s Signature

Delivery Date

Model Number Serial Number

(Customer Copy)



A Miller St. Nazianz Co

PB6000 / G6060 / G6070 Ag-Baggers

Delivery Check List

The following check list is an important reminder of valuable information that **MUST** be passed on to the customer at the time the unit is delivered. Check off each item as you explain it to the customer.

- Give customer their Operator's Manual. Instruct them to be sure to read and completely understand its contents **BEFORE** attempting to operate the unit.
- Explain the warranty.
- Explain and review with the customer the controls and safety equipment on the Bagger.
- Review with the customer the lubrication and maintenance chapters of the owner's manual.
- Explain and review with customer the PTO Driveline information in the separate manual provided.
- Direct the customer on how to use the Table of Contents of the owners manual as a quick page locating guide.
- Explain and review with customer the safety information in the owners manual.
- Explain that regular lubrication and proper adjustments are required for continued proper operation and long life.
- Explain and review with the customer the proper Tractor / Bagger preparation for safe operation.
- Completely fill out Owner's Registration, including customer's signature, and return them to the Company.

I acknowledge that above points were reviewed with me at the time of delivery.

Customer's Signature

Date Delivered

(Customer Copy)



A Miller St. Nazianz Co.

PB6000 / G6060 / G6070 Ag-Baggers

Dealer Pre-Delivery Check List

After the Bagger has been completely set-up, the following inspections Must be made before delivering it to the customer. Check off each item after prescribed action is taken.

- No parts of the unit have been damaged in shipment. Check for such things as dents and loose or missing parts, scratches: touch up or replace components as required.
 - All bolts and fasteners are in place and tightly secured.
 - The gear box is filled to proper oil level – EP 80/90 Gear Lube.
 - Make sure conveyor slides properly, grease if necessary.
 - All guards, shields and decals are in place and securely attached.
 - All chains are properly tightened:
 - Conveyor drive and driven chain
 - Rotor drive chain
 - Hydraulic pump drive chain
 - Brake system properly tightens and releases.
 - Install bungee cord on tunnel & bag pan.
 - String backstop – see operator’s manual
 - Wheels are properly attached and tires are properly inflated: 9.5L x 15 @ 44 PSI, LT 235 / 85R16 @ 80 PSI, LT 265 / 75R16 @ 80 PSI
 - As applicable, the cylinders, hoses and fittings are NOT damaged, leaking or loosely connected.
 - Hydraulic oil reservoir is filled to proper level.
 - All grease fittings have been properly lubricated and drive chains oiled; see lubrication chapter in the owner’s manual.
 - Make sure hitch fits properly in both the transport and operating positions.
 - All drive & driven sprockets aligned properly:
 - Conveyor drive chain sprockets
 - Rotor drive chain sprockets
 - Hydraulic pump drive chain sprockets
 - Clean brake rotor before delivery.
 - Install back stop hook assembly – see operator’s manual.
 - Bag boom works properly (If so equipped)
- Hook the Bagger to the appropriate RPM tractor and test run while checking that proper operation is exhibited by all components.**

Check that:

- Transport lights work properly.
- PTO Shield turns freely.
- All drives and mechanisms are operating smoothly and properly adjusted.
- All hydraulic system components are functioning properly.

I acknowledge that pre-delivery was performed on this unit as outlined.

Dealership’s Name

Dealer Representative’s Name Date

Customer’s Signature

Delivery Date

Model Number Serial Number

(Dealer Copy)



A Miller St. Nazianz Co

PB6000 / G6060 / G6070 Ag-Baggers

Delivery Check List

The following check list is an important reminder of valuable information that MUST be passed on to the customer at the time the unit is delivered. Check off each item as you explain it to the customer.

- Give customer their Operator's Manual. Instruct them to be sure to read and completely understand its contents BEFORE attempting to operate the unit.
- Explain the warranty.
- Explain and review with the customer the controls and safety equipment on the Bagger.
- Review with the customer the lubrication and maintenance chapters of the owner's manual.
- Explain and review with customer the PTO Driveline information in the separate manual provided.
- Direct the customer on how to use the Table of Contents of the owner's manual as a quick page locating guide.
- Explain and review with customer the safety information in the owner's manual.
- Explain that regular lubrication and proper adjustments are required for continued proper operation and long life.
- Explain and review with the customer the proper Tractor / Bagger preparation for safe operation.
- Completely fill out Owner's Registration, including customer's signature, and return them to the Company.

I acknowledge that above points were reviewed with me at the time of delivery.

Customer's Signature

Date Delivered

(Dealer Copy)

Safety Precautions



This symbol is used to call your attention to instructions concerning your personal safety. Be sure to observe and follow these instructions. Take time to be careful!



DANGER

“DANGER” indicates an imminently hazardous situation which, if not avoided, will result in death or serious injury.



WARNING

“WARNING” indicates a potentially hazardous situation which, if not avoided, could result in death or serious injury.



CAUTION

“CAUTION” indicates a potentially hazardous situation which, if not avoided, may result in minor or moderate injury. It may also alert against unsafe practices.

BEFORE you attempt to operate this machine, read and study the following safety information. In addition, **MAKE SURE** that every individual who operates or works with this equipment, whether family member or employee, is familiar with these safety precautions. Miller-St. Nazianz provides guards for exposed moving parts for the operator’s protection; however, some areas cannot be guarded or shielded in order to assure proper operation. The **OPERATOR’S MANUAL AND DECALS** on the machine itself warn you of dangers and **SHOULD BE READ AND OBSERVED CLOSELY.**

Power Source Shutdown Procedure

Before cleaning, unclogging, adjusting, lubricating or servicing this machine:

1. Disengage the tractor PTO.
2. Deactivate tractor hydraulic controls.
3. Shut off the tractor engine, remove the starter key and take it with you.
4. Wait for all machine motion to stop.
5. Remove the telescoping PTO driveline and ALL power connections from the tractor.

Failure to follow these precautions could result in death or serious injury.

Safety Precautions - continued

Know how to stop bagger operation **BEFORE** starting it.

BE ALERT for people and/or animals in front of or around machine, before you start operating the machine.

DO NOT enter the conveyor or hopper when machine is operating.

KEEP hands, feet and clothing away from conveyor when operating.

DO NOT wear loose or baggy clothing when operating this unit.

DO NOT allow people other than a qualified operator near the unit.

DO NOT allow minors to be near the machine unless properly supervised.

KEEP riders off bagger.

DO NOT unclog, adjust, lubricate or service your bagger until you disengage the tractor PTO, tractor hydraulics and shut off the tractor engine. Failure to follow this procedure may result in serious bodily injury.

AVOID high pressure fluids. Escaping fluid under pressure can penetrate skin causing serious injury.

DO NOT exceed a maximum towing speed of 20 MPH (32 KPH) while transporting the bagger.

REDUCE speed on rough or hilly ground.

BE EXTRA careful when going through fence gates or nearing confined quarters.

ALWAYS follow state and local regulations regarding use of a safety chain, slow moving vehicle signs and transport lighting, when towing farm equipment on public highways.

BE SURE the tractor is in **NEUTRAL** and the parking brake released before beginning any bagging operation.

BE SURE tractor wheels are pointed in a straight ahead position while bagging.

BE SURE the hitch jack locking pin is completely engaged and that the machine is properly blocked and prevented from rolling **BEFORE** disconnecting the bagger from the tractor.

DO NOT stand between tractor and bagger when hitching or unhitching bagger unless engine is stopped and parking brake is engaged.

ONLY operate the bagger on level ground.

STAY CLEAR of cables and cable drums at all times. Cables are under tension during bagging operations.

ALWAYS stop bagger operation and shut off tractor between loads if bagger is to be left unattended.

Safety Decals

The decals are for your protection. If your safety decals are not readable or are missing, contact your dealer for replacements.



16.20181 Warning
(Located on side of upper conveyor deflector)



340248B1 Caution
(Located on top side of hitch near jackstand)



17.01155 Warning
(One located on each side of hitch in front of jackstand)



Safety Decals - continued



⚠ WARNING	
	BEFORE YOU OPERATE THIS EQUIPMENT:
	Read the operator's manual and learn to operate this machine safely.
	Keep children away.
	Machines can be hazardous in the hands of an untrained operator.
	Failure to follow safety, operating and maintenance instructions could result in death or serious injury.
If you have questions; contact your dealer or Miller-St. Nazianz at (920) 773-2121	
<small>16.20178</small>	

16.20178 Warning
(Located on control side of hopper)

⚠ WARNING
AVOID HIGH-PRESSURE FLUIDS
AVOID THE HAZARD OF RELIEVING PRESSURE BEFORE DISCONNECTING HYDRAULIC OR OTHER LINES. TIGHTEN ALL CONNECTIONS BEFORE APPLYING PRESSURE. SEARCH FOR LEAKS WITH A PIECE OF CARDBOARD. PROTECT HANDS AND BODY FROM HIGH PRESSURE FLUIDS.
<small>21.09024</small>

21.09024 Warning
(Located on control side of hopper)

⚠ DANGER
ROTATING DRIVE LINE
Do not operate without the following:
<ul style="list-style-type: none"> - Proper drive line guards - Input shaft guards - Tractor master shield - U-Joint locked to tractor and implement shafts
Failure to heed will result in death or serious injury
<small>16.20177</small>

16.20177 Danger
(Located on each side of PTO shield)



01.71800 Warning
(Located on top of PTO shield)

	WARNING
NO STEP	



Safety Decals - continued

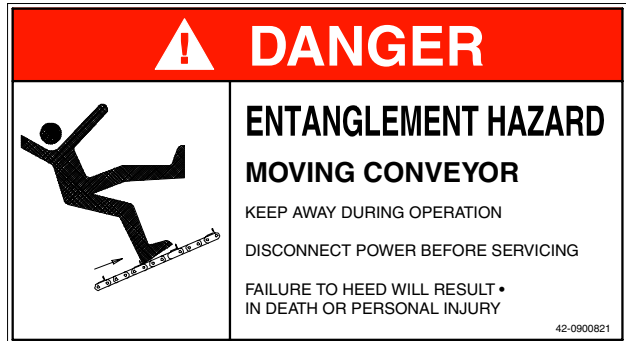

42.0900821 Danger (Located on each side of conveyor)

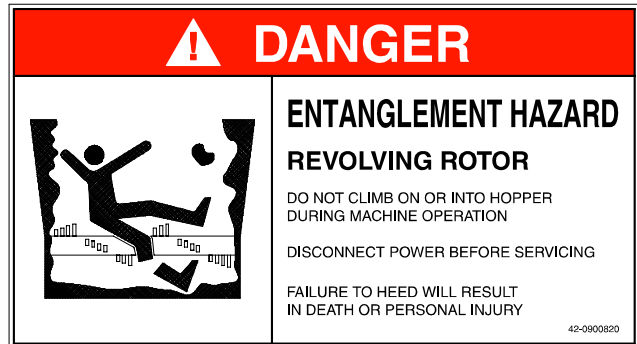

42.0900820 Danger (Located on front and side of hopper)



42.0900822 Warning (Located on frame tube below each cable drum)

Safety Decals - continued



Underside of PTO Shield



**333532B2 Warning
(Located on hitch tube next to gearbox)**



Under Rotor Drive Chain Shield

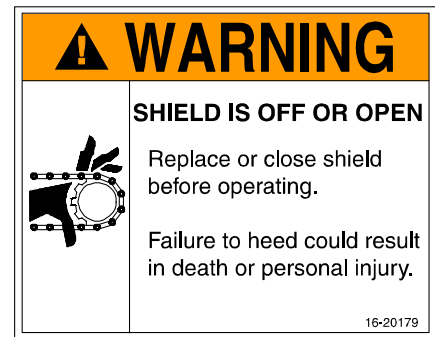

16.20179 Warning



**42.0900837 Important
(Located next to each rotor bearing grease fitting)**



**42.0900823 Important
(Located on frame next to each wheel)**

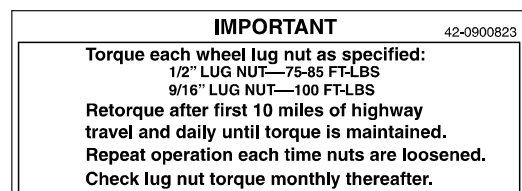

**Reflective Decals
Yellow Reflectors**



**907220 Yellow
Reflector**

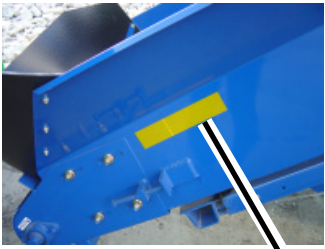

**907220 Yellow
Reflector**



**907220 Yellow
Reflector**



Red Reflectors and SMV Sign

**907224 SMV
Sign**



**907219 Red
Reflector**

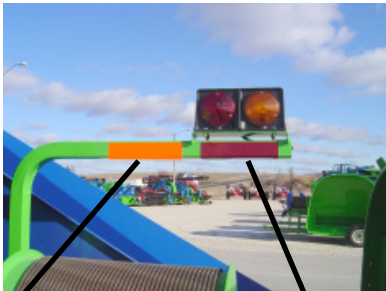

**907221 Fluores-
cent Orange**

**907219 Red
Reflector**

Set-Up And Assembly

Assemble Bag Boom (Optional)

1. Lift the bag boom up into position above the pivot tube. Place the brass spacer onto the pivot end of the bag boom and lower the pivot shaft into the pivot tube on the bagger. Grease both grease fittings after assembly and rotate bag boom back and forth to distribute the grease evenly. Do not over grease. Pivot tube is open on the bottom.
2. Use the winch to lower the cable down slightly, hook the cable end onto the bag cradle. Remove the slack from the cable.

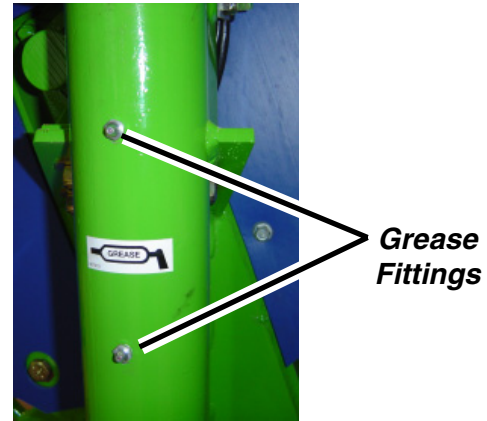
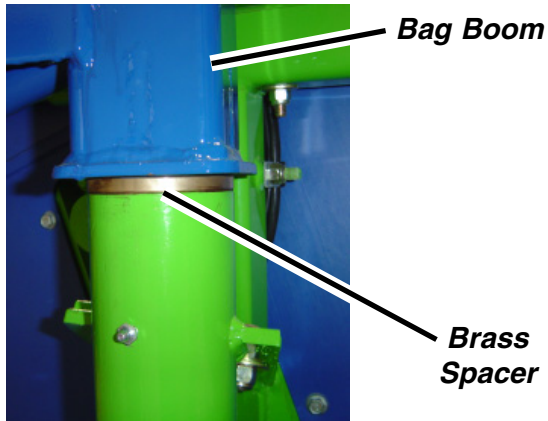

Assemble Bag Pan

1. Place the bag pan under the tunnel. Line up the holes in the bag pan mounts with the mounting holes in the bag pan tabs under and to the backside of the tunnel. Be sure the bag pan mounts are to the outside of each mounting tab under and to the backside of the tunnel. Insert the pivot bolts through the bag pan mounts and the mounting tab holes. Secure the bag pan pivot bolts in place with flat washers and locknuts. DO NOT tighten the hardware completely, bag pan must pivot freely.

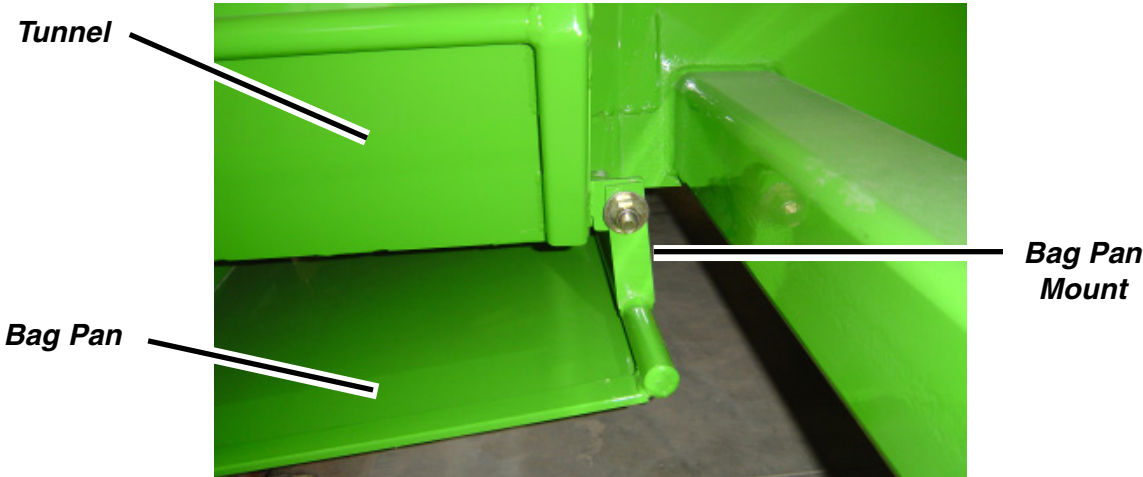

2. Lift the bag pan up and assemble the short bungee cords between the hooks on each side of the bag pan and the hooks on the frame on each side of the tunnel. Be sure to assemble both bungee cords.

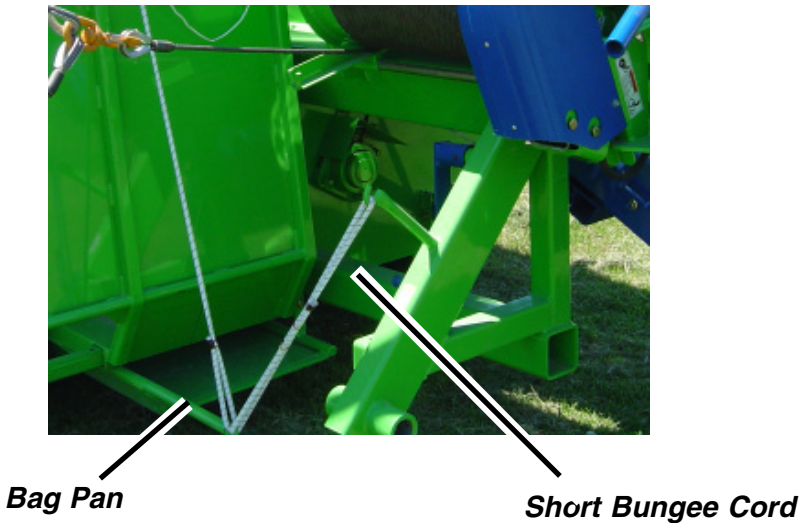

Prepare the Backstop

For ease of lacing the backstop, stand the backstop up and support with the backstop feet supplied with the bagger.

Lace the backstop

1. Use the rope supplied with the bagger.
2. Start in the upper corner of the frame. Make sure you find the middle of the rope, Do Not cut the rope.
3. Lace one end of the rope through the vertical rope eyelets going from the top to the bottom and over to the other side of the frame and end in the other upper corner.
4. Weave the horizontal rope through the vertical rope. Start at the upper corner and weave the rope through the vertical rope going from side to side and top to bottom. End at the lower corner. Make sure you can untie the knots so you can tighten the ropes as required. See the pattern below for correct lacing.
5. Stretch the rope tight and tie it off. Start by pulling the vertical lacing and then do the horizontal lacing.
6. Tighten the ropes after a few bags. This keeps the bag from sitting down on the backstop frame.

NOTE: Inspect the backstop rope occasionally, tighten or replace as needed.

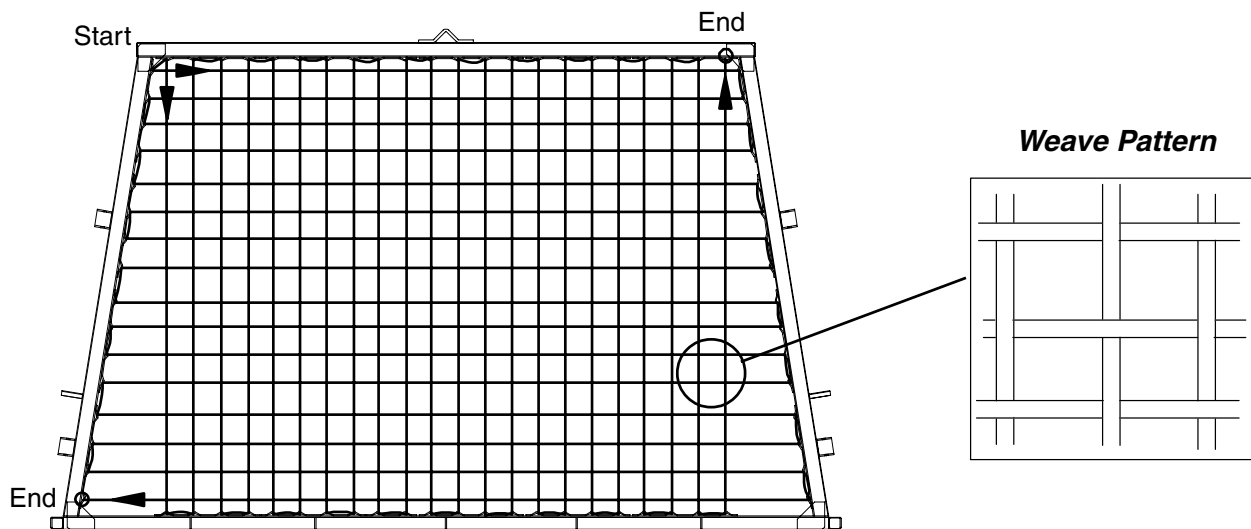

Fasten the backstop slings to the backstop.

1. Fasten the backstop slings to the sides of the backstop. Make sure you connect both sides of each sling.
2. Use the eyes on each end of each sling and bolt them into the brackets that are provided on each side of the backstop. Hardware is supplied in the parts box shipped with machine.



**Backstop Sling
(Lower Shown)**

3. Connect the slings on the backstop to the cables. Connect both sides.

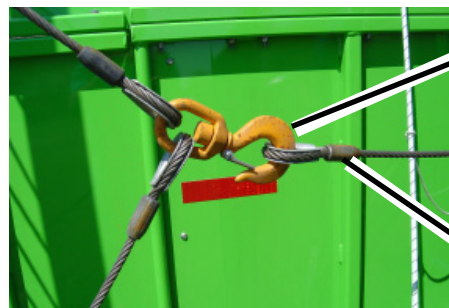

**Backstop Sling
Hook**

Cable

4. Insert the transport brackets into the tubes in the tunnel floor. Fasten in place with 3/8 x 3-1/2" bolts.
5. Place the backstop into the transport supports. Install the 1/2 x 7" bolts to secure the backstop into the transport supports.
6. Use the hand crank to tighten the cables to hold the backstop in position. On baggers with optional hydraulic cable rewind, the hand crank can be attached to the right hand cable drum. Use the hydraulic hand pump to apply pressure to the cable brake and close the needle valve to hold cables in position.

**Transport
Support**

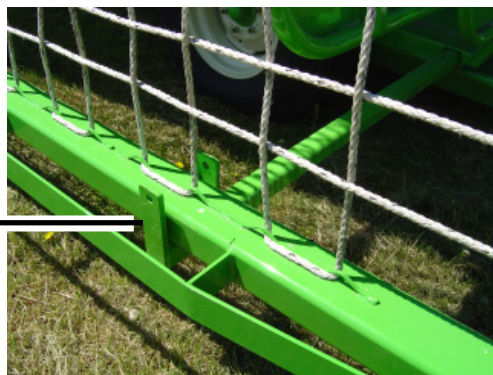

Operation

Pre-Operation Checklist

The pre-operation check list is provided for both personal safety and maintaining the mechanical condition of the bagger. Make sure each item on the list is checked prior to operating the bagger each time.

- The tractor is adequate to operate the bagger. Refer to the “Machine Specifications” section.
- Lubricate, grease and check all fluid levels. Refer to the Maintenance section of this manual.
- Check the inoculant applicator (if so equipped), make sure it is properly connected and filled.
- Check all hydraulic lines, hoses and fittings for leaks and tightness. Wipe any dirt from the hose couplers with a clean cloth before connecting to the hydraulic system on the tractor.
- Tractor is properly attached to bagger.
- PTO shaft is secure to the bagger gear box shaft and the tractor PTO shaft.
- Safety shields and guards are closed and secured in place.
- Check the rotor, conveyor and hopper to make sure no foreign objects are present.
- Check conveyor chain(s) for correct tension.
- Check brake disc. Be sure disc is clean and rust free. Clean as needed.

Set The Backstop In Position



WARNING

Backstop is heavy. Use care when moving backstop.

1. Place the bagger where the bag will begin.
2. Release the cable drum brake pressure by opening the hand pump valve.

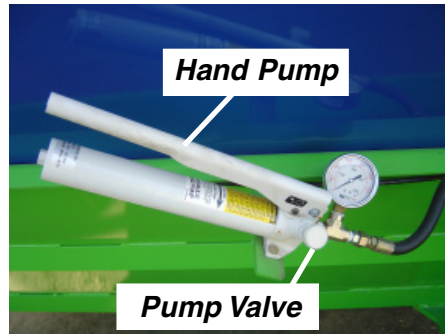

3. Unhook the backstop slings from the cables. Be sure to unhook both slings.

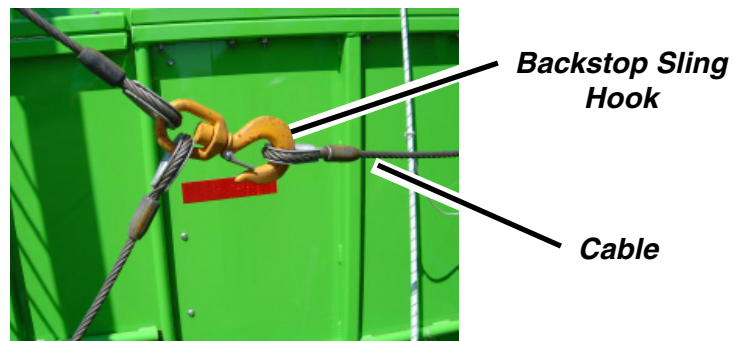

4. Remove the bolts holding the backstop to the support feet. Use the bag boom (if so equipped) or some other means to lift the backstop off the support feet. This step may not be necessary depending on how backstop has been transported.

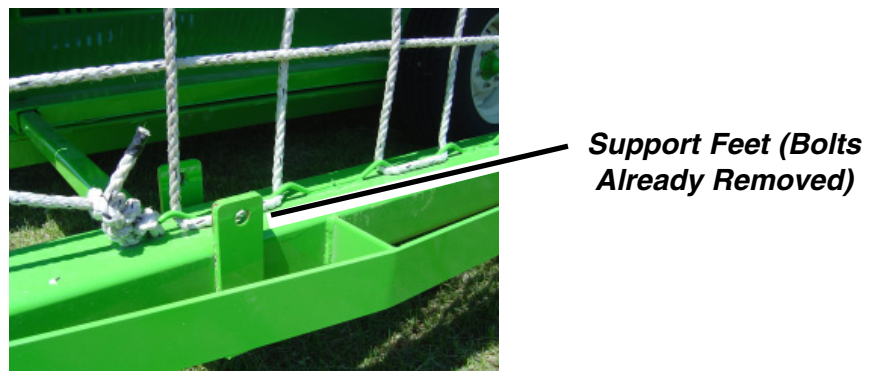

-
-
5. Reassemble the bolt and nut into the support feet tabs. Remove the support feet from the pockets in the tunnel. Insert the support feet into the pockets on the backstop with the tabs to the rear of the backstop. The feet will help hold the backstop in the upright position.

NOTE: After two loads are placed in the bag, remove the feet from the backstop and continue bagging.

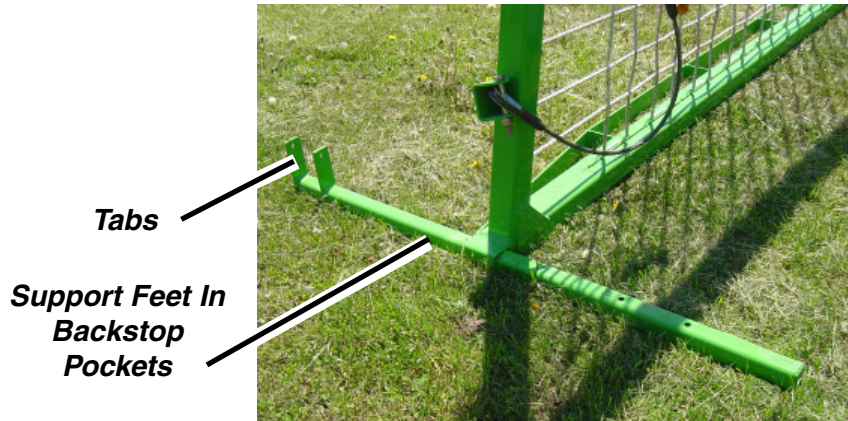

6. Pull the bagger forward, giving yourself plenty of room to install the bag onto the tunnel.

Hook Tractor To Tow Hitch

1. Crank the lift jack up or down to make the tow hitch match up with the tractor drawbar.
2. Back the tractor up to the tow hitch, be sure the tractor is in a straight line with the bagger. Line up the hitch pin holes in the tractor drawbar and bagger hitch and insert the hitch pin and hair pin.

IMPORTANT: When operating the bagger to fill the storage bag, the tractor and bagger must be in a straight line to create a straight bag.

3. Crank the lift jack down until the lift jack is off the ground. Remove the lift jack from the mount, rotate 90° and reassemble to the tow hitch with the retaining pin and hair pin.



Lift Jack In Stowed Position

Assemble PTO Shaft To Bagger and Tractor

1. Remove the PTO shaft from the transport location between the front of the hopper and the rest attached to the cable drum mount.
2. Lift the gear box shaft guard up out of the way. Be sure to lower the guard down to the operating position once the PTO shaft is assembled.



-
-
3. Attach the PTO shaft to the splined shaft of the gear box. Be sure the PTO shaft is completely locked into place. Push the locking ring toward the gear box to release the locks and push all the way on. Release the locking ring to lock in place. Pull back on the PTO shaft to be sure it is locked in place.



Gear Box Shaft

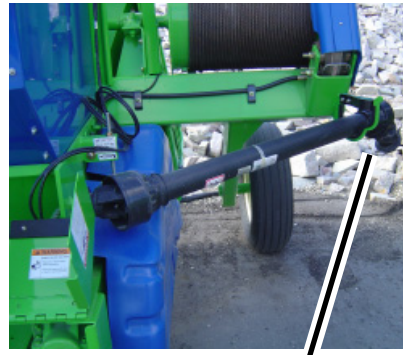

Attach Shear Bolt End Of PTO Shaft To Gear Box

4. Pull the other end of the PTO shaft toward the tractor and lock onto the splined shaft of the tractor. Pull the locking collar away from the tractor to release the locks. Push all the way on and then release the locking collar to lock in place. Pull back on the PTO shaft to be sure it is locked in place.



WARNING

To avoid contact with moving parts, lower gear box shaft guard down before operating bagger. All guards must be in place and secured.

5. Lower the PTO shaft guard down to the operating position over the gear box end of the PTO shaft.



Lower This Guard Down Before Operating

Connect Hydraulic Lines



WARNING

AVOID high pressure fluids. Escaping hydraulic fluid under pressure can penetrate the skin causing serious injury.

Refer to your tractor operators manual for hydraulic port locations and operation.

1. Clean the hose couplers and tractor ports.
2. Connect the hose couplers to the correct tractor ports.

Connect The Inoculant Applicator (Units so equipped)

Connect the inoculant applicator electrical supply to a 12 volt source on the tractor. Consult your local Ag-Bag dealer and your tractor operators manual for specific installation instructions.

Bag Identification

Remember to use only Ag-Bag® bags. They are designed to fit and function properly. They are identified by the TRI-DURA® name on the box.

Locate the bag size indicated on the box. Make sure you are using the correct size for your bagger.

Locate the arrow on the side of the box. It should be pointing toward the bagger.

IMPORTANT: Be sure to select the best surface for bag placement. Refer to bagging surface in the “Bagging Instructions” section of this manual.



***Size Of Bag
Shown Here***

***This Arrow
Points Toward
Bagger***

Bag Installation

NOTE: Remember to use only bags that are the proper size for your model.

1. Lower the bag pan by unhooking the two bungee cords (one on each side of tunnel) and allow the bag pan to rest on the ground.
2. Using the winch on the bag boom (if so equipped), lower the cable and attach to the cradle lifting lug.
3. Lift the cradle with the bag boom winch (if so equipped) or some other means from the tunnel and lower the cradle to the ground. Set the cradle on the ground to the rear of the machine and centered in the tunnel opening. Set the cradle between the tunnel and the bag box.



4. Line up the box with the back of the tunnel, making sure the arrow on the end of the box is pointing toward the tunnel. Cut the plastic bands from the box and remove the outer lid. DO NOT remove the ties around the bag until the bag is on the tunnel. Remove the inner shell and the box will flatten.





CAUTION

Caution should be used when moving bags. Weight of bags can be over 400 pounds depending on size of bag.

5. Unfold the bag and lift the top half of the bag and place it on the bag cradle. Using the winch on the bag boom, raise the bag up. Once the bag is raised, rotate the bag so the stretch measure marks are between 1 and 3 o'clock.

NOTE: Do Not roll the bag while placing on the tunnel. Keep the folds flat. Bag damage could occur if bag is not flat.

6. Crank the bag boom winch (if so equipped) up or lift the bag cradle up until the cradle is above the tunnel. Move the cradle toward the tunnel. Carefully work the bag around the tunnel, making sure the bag maintains its flat look and is flat between the tunnel and the bag pan.
7. Lower the cradle until it is resting on top of the tunnel. The cradle should rest between the two pipes on the top of the tunnel. Once the cradle is in place on the tunnel remove all the ties that hold the bag folds together.

*Pipes On
Tunnel*



*Bag Cradle In Correct
Position On Top Of
Tunnel (Bag Not Shown
For Clarity)*

-
-
- 8. Install the bungee cords. Bungee cords are supplied with bagger.
 - a. Lay the long bag bungee cord over the tunnel.
 - b. Connect the ends of the long bag bungee cord to the bag pan hooks on each side of the tunnel.
 - c. Tie the cords from the long bag bungee cord to the four loops on the tunnel. Make sure the cords are evenly spaced on the tunnel. The purpose of these four cords is to keep the main bungee cord from following with the bag as the bag is fed off the tunnel.
 - d. Lift the bag pan up and hook the two bag pan bungee cords between the bag pan and the hooks on the frame.

IMPORTANT: Maintain a minimum 3/4" gap between the tunnel and the bag pan to prevent any damage to the bag as it is fed off the tunnel.

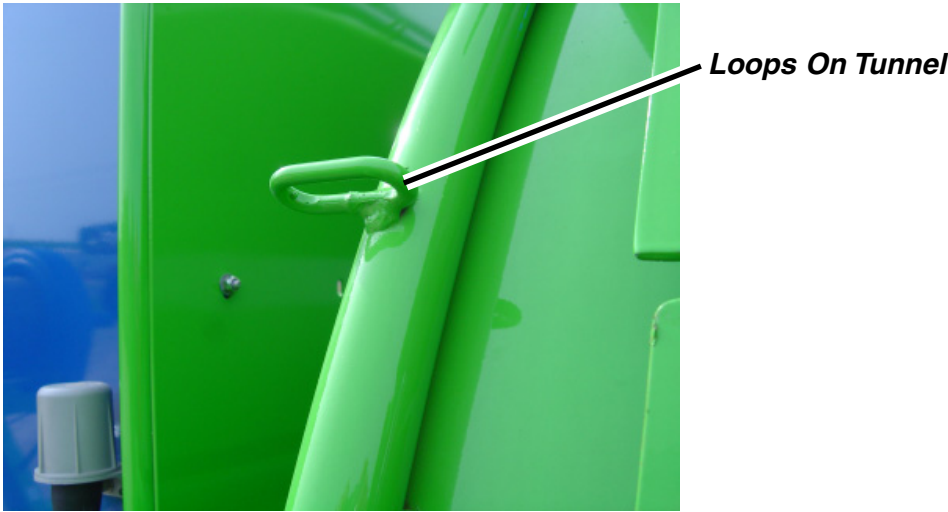
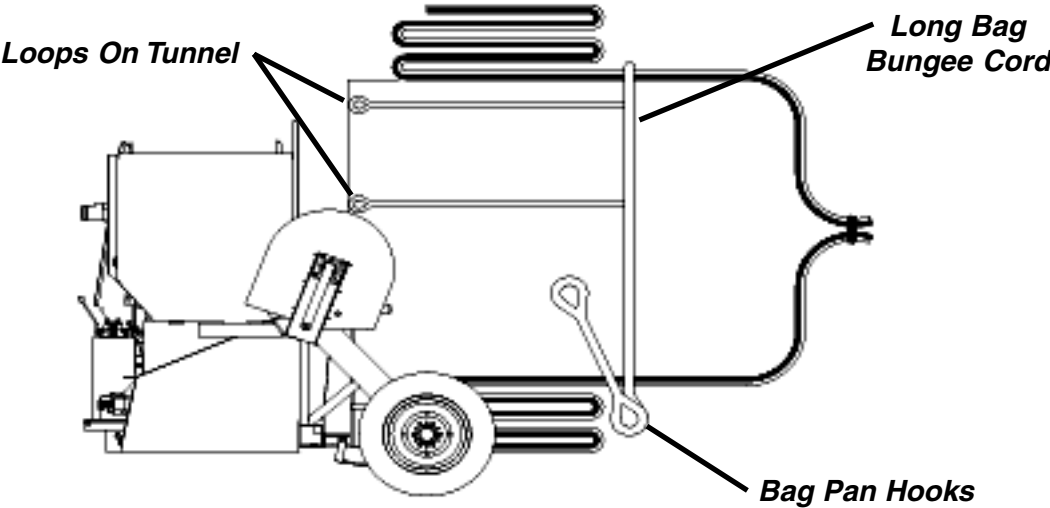

Seal The Beginning End Of The Bag

1. Pull enough bag to apply the seal. Pull from the inside folds, not the outside folds (white on the outside, black on the inside). Make sure you pull the bag under the bag bungee cord.
2. Seal the end of the bag using one of the two following methods:
 - a. Using the Master Seal®. Follow the instructions that are included with the Master Seal. Master seal and tool (Zip Tool Part Number 42.1500273) are available from your Ag-Bag dealer. See list below for your size bag:
 - Part Number 42.1500272 - 250 Ft. Roll
 - Part Number 42.1500270 - 9.5 Ft. Lengths, 4/Box
 - Part Number 42.1500267 - 14.5 Ft. Lengths, 4/Box for 8 & 9 ft. bags
 - Part Number 42.1500268 - 17 Ft. Lengths, 4/Box for 10 ft. bags
 - Part Number 42.1500269 - 20 Ft. Lengths, 4/Box for 11 & 12 ft. bags

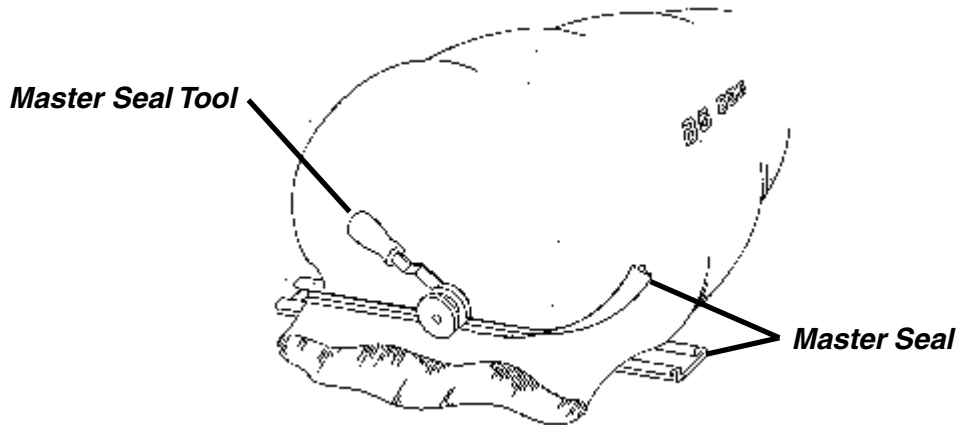

- b. Use a double knot tie. Find the end of the bag, gather the bag to the center. Twist the bag tight and tie the bag tight. Leave enough bag to fold over and tie a second time giving the bag an air tight seal.

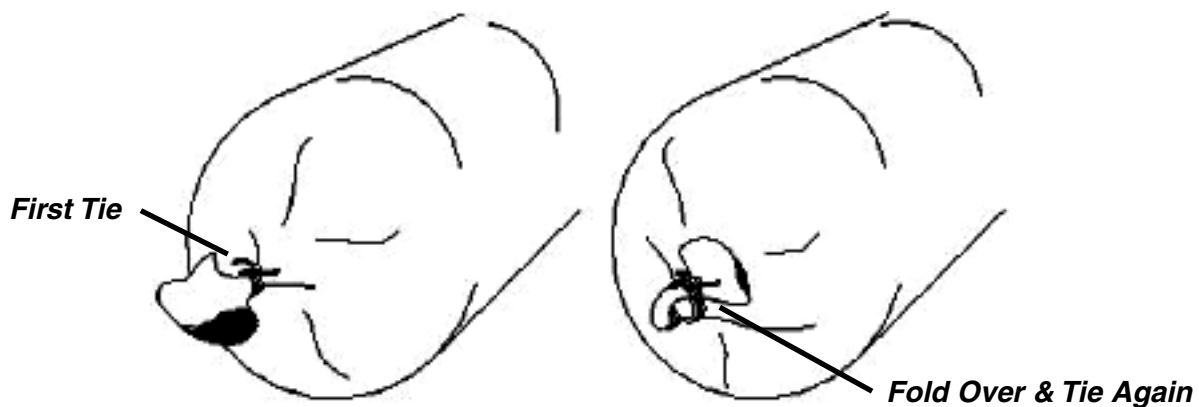

3. Slide the excess bag back onto the tunnel and bag pan. Position the knot approximately knee high.

Hooking Up The Backstop

1. Make sure the backstop is where you intend to start your bag. Back the bagger up next to the backstop. The backstop should be aligned with the tunnel opening and 1 to 2 feet behind the tunnel.

NOTE: The backstop support feet can remain in the backstop pockets for the first two loads. Then remove the support feet and the backstop should stand by itself.

2. Release the brake pressure on the cable drum brake. Using the hand crank, release some cable from the drums. Remove the cables from the rewind guides and hook the cables to the backstop slings. Do not leave the cables in the rewind guides during bagging.
3. Using the hand crank, rewind excess cable back onto the cable drums.

NOTE: To prevent bag damage. Avoid leaning the backstop against the tunnel or place cardboard between the bag and backstop.

4. Set the cable brake pressure to hold the cable drums. Adjust brake pressure as required.



Lower Conveyor to Operating Position.

Conveyor Lowering/Raising

1. Using the hand winch on the side of the conveyor, slightly raise the conveyor to remove pressure on the transport lock. Pull and rotate the transport lock to release the conveyor.
2. Lower the conveyor down to the operating position with the hand winch. The conveyor should not be resting on the ground while bagging. Keep the conveyor approximately six inches off the ground.
3. The angle of the conveyor can be adjusted by repositioning the support arm located under the conveyor.

IMPORTANT: When raising the conveyor, rotate the transport lock to the lock position. Transport lock is spring loaded and will lock into the transport hole in the conveyor once conveyor is all the way up. Be sure lock is properly seated before transporting.

4. Winch brake will hold the conveyor in the operating position.

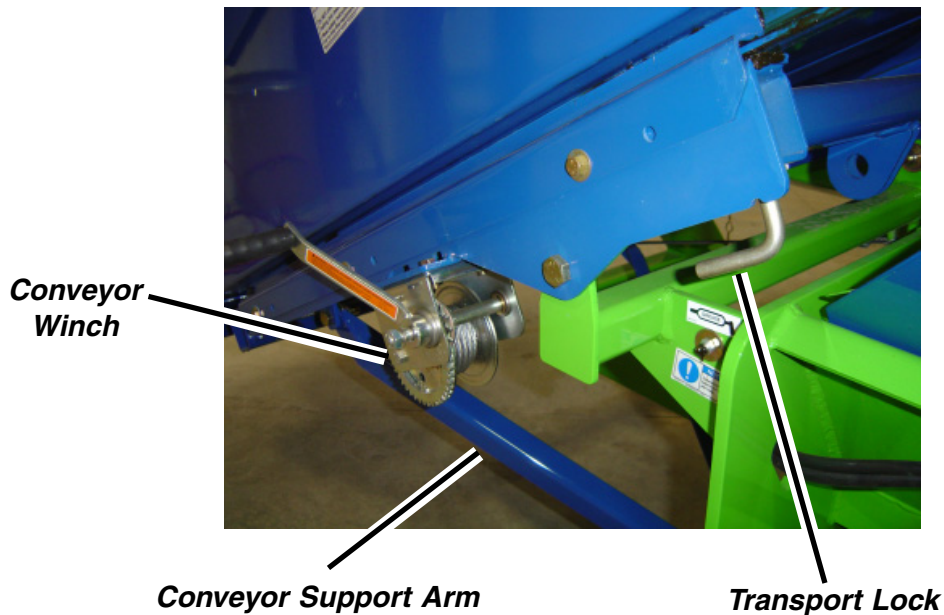

Bagging Operation

Begin Bagging



DANGER

To avoid serious injury, DO NOT climb on or in bagger or conveyor while in operation. Falling into machine will result in serious injury or death.

1. Instruct all unloading personnel how to communicate with the bagger operator.
2. Using the hydraulic hand pump, set the cable drum brake pressure between 400 - 450 psi (pump valve must be open to pump up brake pressure). Close the pump valve to hold pressure. Open the pump valve to release the brake pressure. This pressure is a starting point and may need adjustment depending on crop conditions. Refer to the “Bagging Instructions” section for a more detailed explanation on setting brake pressure.

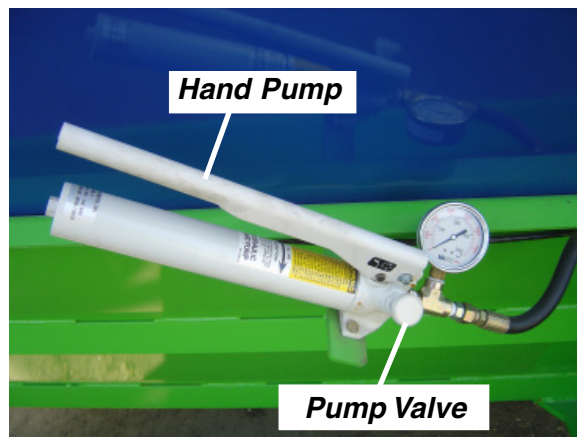

-
-
3. Connect the hydraulic hoses from the bagger to the tractor hydraulics.

CLOSED CENTER TRACTOR HYDRAULICS

- Turn the control knob on the conveyor all the way in. Start the conveyor by engaging the tractor hydraulics. The speed of the conveyor can be controlled by the tractor hydraulics.

OPEN CENTER TRACTOR HYDRAULICS

- Start the conveyor. Engage the tractor hydraulics. The speed of the conveyor can be controlled by the conveyor speed control knob.

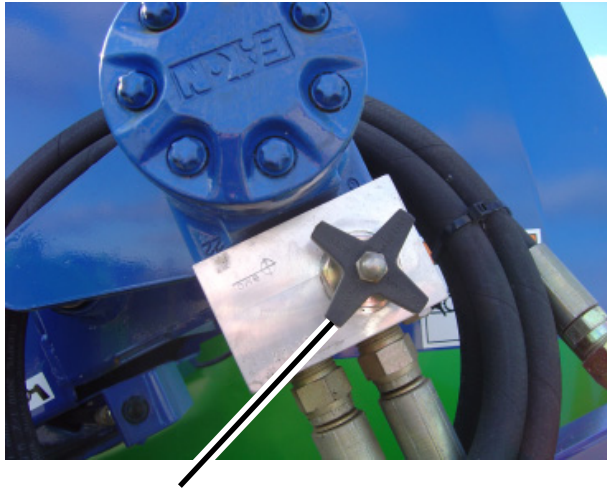

Conveyor Speed Control Knob

4. Engage the tractor pto to start the bagger.
5. Place the tractor in Neutral, release the tractor brakes and have the wheels pointing straight ahead.

-
-
6. Start unloading product onto the conveyor. The person operating the unloading equipment should watch that the conveyor or hopper does not get over loaded. Unloading equipment should be run accordingly.

IMPORTANT: Remove the support feet from the backstop after the first two loads. If support feet are left in the backstop pockets, damage to the support feet and/or pockets may result.

7. Start the inoculant applicator (if so equipped) once product is being unloaded onto the conveyor. Turn inoculant applicator off just before load is empty.
8. Check the cable drum brake pressure and adjust as required according to the following indicators:
 - a. Check the stretch bars on the side of the bag. They should not exceed the bag manufacturers recommendations. If stretch marks are greater than recommended, brake pressure needs to be decreased.
 - b. If bag does not have a smooth appearance, brake pressure may need to be increased.
 - c. Use the ground to ground measurement to check for proper bag stretch. Refer to the "Bagging Instructions" section of this manual for proper measurements.

IMPORTANT: Never allow bag to touch cables. To avoid the possibility of bag damage, place cardboard between bag and cables if contact will or has occurred.

Stop the conveyor and bagging operation when:

- a. Two or three wraps of cable remain on the cable drum
or
- b. The bag is full and 10 to 12 feet of bag is left on the tunnel (approximately four folds in most cases).

IMPORTANT: Be sure to turn off the inoculant applicator each time the conveyor is stopped.

Remove Bagger From Bag

Tunnel Clean Out

1. Using the release valve or valves on the hydraulic hand pump, slightly release the cable brake pressure and move the bagger forward about five feet. Set the tractor brakes.
2. Send more product through the hopper to help loosen the packed product inside the tunnel. Allow as much product as possible to fall out of the tunnel and into the bag before bag is removed from the tunnel.

Remove The Backstop

1. Place the backstop support feet into the pockets on the backstop to stabilize the backstop.
2. Release all pressure from the cable drum brake system.



WARNING

Backstop is heavy. Use care when moving backstop. Use equipment capable of handling the backstop.

3. Unhook the cables from the backstop slings and move the backstop away from the bag.
4. Place the cables in the cable rewind guides.
5. Rewind the cables onto the drums. Use the hand crank or the hydraulic rewind (if so equipped). Stop the cable end a few inches from the rewind guides.

Pull Bagger Forward Out Of Bag

1. Pull the bagger forward. The bag will slide off the tunnel. Grab each side of the bag on the end. Walk the bag over itself pulling the product together. Bring the bag end forward.
2. Seal the end of the bag using either Master Seal strips or the double tie method. Refer to "Bagging Instructions" for additional information.

NOTE: No matter which method is used when sealing the end of the bag, loose plastic should be weighted down. Do Not use material that will be abrasive to the bag material.

Venting The Bag

Immediately after the bag is sealed a vent must be installed to remove the gases produced by the product. A reusable vent valve and vent tool are available from your Ag-Bag dealer.

Reusable Vent Part Number 42.1500893

Vent Installation Tool Part Number 42.1500568

Insert the vent valve as follows:

1. Remove the cover from the vent cutter tool. Turn the cutting portion of the tool around (cutter away from cover), line up the notches and insert the cutter into the cover.
2. Take the threaded side of the valve, line up the notches and slide it over the cutter end of the tool. Slide the threaded portion all the way onto the cutter.

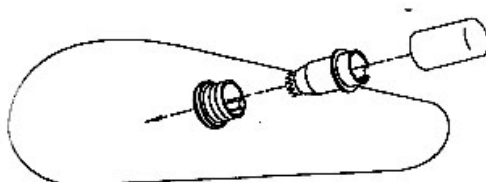

3. After you have located the spot where you want the vent to be installed, press the cutter portion of the tool into the plastic to create a hole. Push the tool with the threaded portion of the vent through the hole and pull the cutting tool out leaving the threaded end of the vent sticking out through the bag.

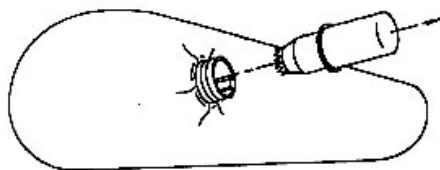

4. Assemble the valve lid onto the threaded portion. Turn the lid to the left and tighten securely.

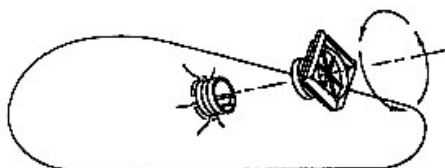

Slide the lid of the vent open enough to allow the gases to escape. Within 1-2 days, close the lid and leave the vent in the bag until that end of the bag is fed out.

NOTE: If excessive gassing occurs, leave the vent open an additional day. If the bag puffs up again after closing the valve, open the valve again until gasses recede, then close the valve.

Changing Bagger To Transport Position

Raise Conveyor Up For Transport

1. Using the hand winch on the side of the conveyor, raise the conveyor all the way up. Rotate the transport lock and allow it to seat itself in the locking hole of the conveyor.

IMPORTANT: When raising the conveyor, rotate the transport lock to the lock position. Transport lock is spring loaded and will lock into the transport hole in the conveyor once conveyor is all the way up. Be sure lock is properly seated before transporting.

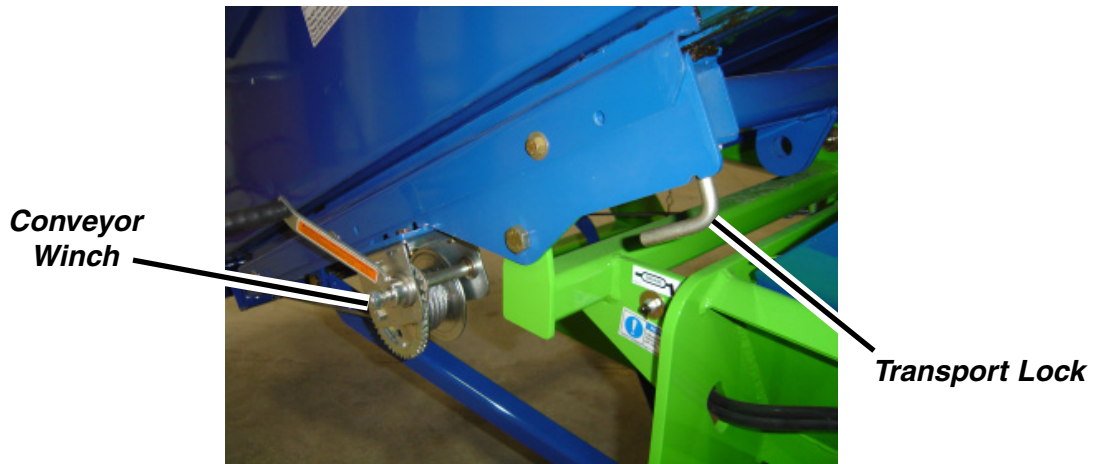

Clean Out The Tunnel



WARNING

DO NOT lubricate, adjust and/or service this machine unless the POWER SOURCE SHUT DOWN PROCEDURE (page 5) has been exercised.

1. Disengage the tractor PTO.
2. Remove excess product from the tunnel. If this has been your last bag, prepare the bagger for storage. Refer to the instructions in the “Storage” section of this manual.

Unhook Tractor From Bagger

IMPORTANT: Site for unhitching must be level to prevent bagger from rolling when unhitched from the tractor.

Turn the tractor off and wait for all moving parts to stop before proceeding.



WARNING

DO NOT lubricate, adjust and/or service this machine unless the POWER SOURCE SHUT DOWN PROCEDURE (page 5) has been exercised.

1. Disconnect the hydraulic hoses from the tractor.
2. Disconnect the inoculant applicator (if so equipped) electrical connection from the tractors electrical system.
3. Disconnect the pto shaft from the tractor. Pull the locking collar away from the tractor to release the locks and slide the pto shaft off of the tractor shaft.

-
-
4. Raise the guard over the gear box shaft to access the pto shaft locking ring. Push the locking ring toward the gear box to release the locks and remove the pto shaft from the gear box. Remove the pto shaft from the splined shaft of the gear box.
 5. Place the pto shaft in the storage position between the front of the hopper and the pto shaft transport rest mounted to the cable drum mount.
 6. Lock the tractor end of the pto shaft to the shaft on the hopper. Place the other end of the pto shaft into the transport rest and under the rubber flap.



***Gear Box Shaft Guard
In Raised Position***



PTO Shaft In Transport Position

7. Connect the transport light harness to the tow vehicle. Remove the plug from the holder on the front side of the hopper and connect to the tow vehicle.
8. Safety chains are available for your bagger from your Ag-Bag dealer. Always use safety chains when transporting the bagger on public highways.
9. Check the tire air pressure and check the lug nut torque. Refer to the “Lubrication and Maintenance” section for proper tire pressure and lug nut torque.

Secure Backstop To Tunnel

1. Place the backstop support feet into the sockets inside the tunnel. Secure the support feet in place.
2. Connect the slings to the backstop and the cables. Using the bag boom (if so equipped) or some other means, lift the backstop up and place in the ears of the support feet. Secure the backstop to the support feet with the existing hardware. Manually rewind the cables until the backstop is tight against the tunnel. Set the cable drum brake pressure at 1000 psi to hold the cables in place. Close the pump valve to hold the brake pressure.
3. Remove the bag boom cable (if so equipped) from the top of the backstop and hook the cable end into the loop at the top of the tunnel. Use the winch to snug up the cable.
4. Use the long bungee cord to tie the bag cradle to the top of the tunnel.
5. Use wire or rope and tie the bag pan up against the bottom of the tunnel. Do not rely solely on the bag pan bungee cords to hold the bag pan up.

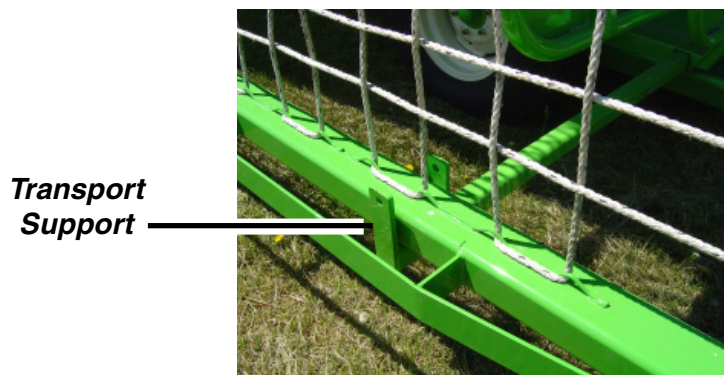
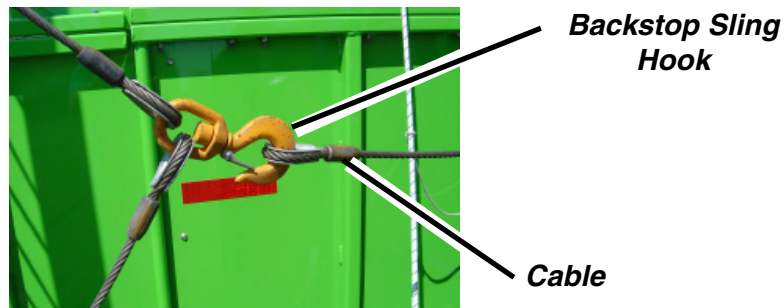

Bagging Instructions

Read and follow these procedures for proper bagging of product as well as feed out rates and bag placement.

The Crop

- a. Maturity (pre-bloom)
- b. Moisture Level (60 to 65 percent target)
- c. Crop Length (3/4" target)

Bag Location - pick an area using the following recommendations

- a. Remove rocks and sticks from the site
- b. Good drainage of site is important
- c. Concrete, asphalt, gravel or packed limestone works well under bags
- d. Pick a site away from rodents
- e. Protect your site from livestock with fencing.

Bag Installation

Enclosed in each bag box is an instruction sheet with pictures to help you properly install the bag on your bagger. Please take time to understand the best method of bag installation. The bag should be placed on the machine with the bag logo in an area between 1 and 3 o'clock.

Watch the stretch indicators on the bag. The bag is overfilled when the stretch indicator exceeds the manufacturer's recommendations.

Bagging Pressure (Cable Drum Brakes)

When filling the bag, it should not be stretched more than 2" above the tunnel nor should the bag push against the cables.

1. Less brake pressure is required when:
 - a. Bagging uphill
 - b. Bagging with a large tractor
 - c. Bagging in muddy or soft sandy soils
 - d. Bagging extremely wet feed (above 75% moisture)
 - e. Bagging dry grains (makes a flatter bag). The bag will not always reach to the top of the tunnel.
 - f. Bagging oats and winter forages. NOTE: These should only be packed to the top of the tunnel because of swelling during storage.
2. More brake pressure is required when:
 - a. Bagging on hard surfaces such as concrete, asphalt, etc.
 - b. Bagging down hill.

Correcting Bag Stretch

Ground To Ground Method Of Checking

Tie weights (hex nuts) approximately 1/4 lb to one end of a string and one weight (hex nut) approximately 1/8 lb to the opposite end of the string. The distance between the nuts need to be:

19 feet 3 inches for 8 foot bags

20 feet 3 inches for 9 foot bags

21 feet 2 inches for 10 foot bags

The distances between weights (hex nuts) for wheatlage, ryelage and oatlage (small greens) will vary from those listed above. Less cable drum brake pressure is required for these products:

19 feet for 8 foot bags

20 feet for 9 foot bags

21 feet for 10 foot bags

Straddle the string over the bag approximately 15 feet away from the bagger.

While bagging, when the single nut touches the ground, increase the cable drum brake pressure. If the nut comes off the ground more than 3 inches, reduce the cable drum brake pressure.

NOTE: Use this procedure only as a visual aid. Remember, measuring the stretch bars on the bag and maintaining appropriate stretch dimensions is more important. Keep the bag stretch indicators within the manufacturer's specifications.

Sealing and Venting - Very Important

As soon as the bag is filled seal the finished end of the bag as outlined with the Master Seal instructions. The sooner oxygen is sealed out, the sooner the fermentation process can begin. It is very important to vent the bag after sealing. Refer to "Venting The Bag" section of this manual. Order Master seal and reusable vents from your local Ag-Bag dealer. Refer to the list that follows for specific part numbers:

- Part Number 42.1500272 - 250 Ft. Roll
- Part Number 42.1500270 - 9.5 Ft. Lengths, 4/Box
- Part Number 42.1500267 - 14.5 Ft. Lengths, 4/Box for 8 & 9 ft. bags
- Part Number 42.1500268 - 17 Ft. Lengths, 4/Box for 10 ft. bags
- Part Number 42.1500269 - 20 Ft. Lengths, 4/Box for 11 & 12 ft. bags

- Part Number 42.1500893 - Reusable bag vent
- Part Number 42.1500568 - Vent installation tool

Protecting the Bag From Wind Damage

Wind damage can be caused by the wind whipping the loose end of the bag. To prevent damage, the loose bag end needs to be secured with Master Seal and by placing tires or other soft material on the end of the bag. Wind damage can cause small cracks and eventually wear a hole that allows air to penetrate, causing feed damage. A tightly secured bag will add to the life of the bag.

Bag Management and Inspection

Periodic inspection of the bag is essential to maintain the oxygen free environment inside the bag. It is recommended that repairs be made with Ag-Bag mending tape as soon as they are discovered. Repair tape can be ordered from your local Ag-Bag dealer using the following part numbers:

- Part Number 42.1500523 - 2" x 36 yard roll, 18 rolls per case
- Part Number 42.1500525 - 3" x 36 yard roll, 24 rolls per case
- Part Number 42.1501331 - 4" x 36 yard roll, 18 rolls per case

Bag Information

Bag Size	Inoculant Index	Tons/Bag 65% Alfalfa	Tons/Bag 35% Earlage	Tons/Bag 28-30% Shelled Corn	Approx Bushels Per Bag (Based On 56# Bushel)
8' x 100'	1.0	80-90	70	80	—
8' x 150'	1.4	120-140	120	130	3,825
8' x 200'	1.9	170-190	164	180	5,294
9' x 135'	1.6	140-160	134	150	4,411
9' x 150'	1.8	160-180	162	175	6,125
9' x 200'	2.2	200-225	205	230	6,765
10' x 150'	2.2	200-220	180	202	5,940
10' x 200'	3.0	270-300	247	278	8,175
10' x 250'	3.6	340-360	324	350	12,250

NOTE: The tons per bag are approximate and will vary based on moisture and length of chop and crop types. High moisture shelled corn totals are figured from bagging with a regular Ag-Bag machine. If using an Ag-Bag Grain Bagger, totals will be approximately 20% less, due to density. Also, when using the Master Seal sealing strip you can get approximately 2-4 more loads in the bag, depending on the size of the bag.

Suggested Feed Out Rates Per Day

Bag Size	Winter Rates Oct. - April		Summer Rates May - Sept.	
	Feet/Day	Tons/Day	Feet/Day	Tons/Day
8 Ft.	1 Ft.	1	2 Ft.	2
9 Ft.	1 Ft.	1	2-1/4 Ft.	2-3/4
10 Ft.	2 Ft.	3	2-1/2 Ft.	4

Capacity of Tons Per Running Foot of Bag

8 Ft. 1 Ton (approx.)
 9 Ft. 1-1/4 Tons (approx.)
 10 Ft. 1-1/2 Tons (approx.)

Bagging Surface



WARNING

Do not bag on a hillside. Tip-over or bag roll could result.

Bag up hill rather than down hill. Avoid bagging on a hillside. The bagger can drift and the bag may roll.

Surface conditions may affect bagging quality and ability. Soft ground conditions will act as a brake and may cause the bagger to sink. A hard clean and level surface is best to bag on. By cleaning the area, rodent problems can be eliminated.

Bad Weather Bags

NOTE: Remember to place bags in a location that feed out can be done when you need the feed.

Consider the surface conditions during the seasons when product will be removed from the bags. If you expect a lot of mud, you may want to put some bags on a solid surface. Have enough accessible bags to last until good weather conditions can be expected.

Bag Shape

Keep the bag away from the cables. If it appears that the cables will contact the bag, insert a piece of cardboard between the bag and the cable.

Follow the instructions included in your bag box for bag stretch guidelines.

Haylage and Corn Silage:

Apply enough cable pressure to fill the bag within 2 inches of the top of the tunnel. Keep the bag stretch indicators within the bag manufacturer's specifications.

Grains:

Grains tend not to fill the bag to the top of the tunnel, regardless of cable pressure. Regulate cable pressure by measuring your stretch bars approximately 30 feet back from the bagger. Keep the stretch indicators within the bag manufacturer's specifications.

Product Moisture

Refer to the “3M’s of Silage” supplement available from your Ag-Bag dealer for more detailed information on product moisture levels. Moisture levels play an important part of product quality.

Dry Product

Dry product makes a lumpy bag. Long dry chop is hard on the bagger. Remember when trying to make good haylage, dry feeds have more resistance. They will pack higher in the bag and less cable drum brake pressure is required.

Wet Product

Moisture levels above 70% may create excessive liquid in the hopper. This excessive liquid is OK unless the bag is outside the recommended shape. Slowly release cable drum brake pressure until the bag is within the recommended shape. Let the product wilt longer in the field if liquid does not dissipate. Wet product does not rise very high in the bag. The result will be a wide bag.

NOTE: Possibility of bag damage will result from cables contacting a wider shaped bag. Place cardboard between the bag and cables if contact will or has occurred.

Adjustments

Conveyor Chain Tension Check



WARNING

DO NOT lubricate, adjust and/or service this machine unless the POWER SOURCE SHUT DOWN PROCEDURE (page 5) has been exercised.

At the midway point of the conveyor lift the chain up. Chain should be able to be lifted 2 inches. If chain is too tight or too loose adjust as follows:

- a. At the lower end of the conveyor, loosen the four retainer bolts on each side of the conveyor.
- b. Loosen the jam nut on the adjusting bolt on each side of the conveyor.
- c. With the adjusting bolts, adjust the conveyor chain evenly on both sides.
- d. After the correct tension is reached, tighten the jam nuts on each adjusting bolt.
- e. Tighten the four retainer bolts on each side of the conveyor.

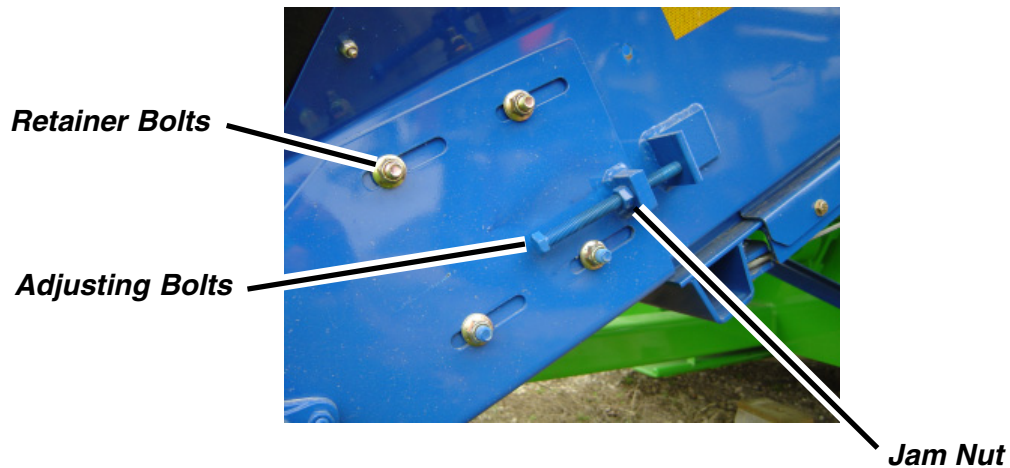

Rotor Drive Chain Tension Check and Adjustment



WARNING

DO NOT lubricate, adjust and/or service this machine unless the POWER SOURCE SHUT DOWN PROCEDURE (page 5) has been exercised.

The tensioner for the rotor chain is spring loaded. Check to be sure the tensioner is maintaining proper tension on the chain.

1. Remove the rotor drive chain guard from the side of the frame. Check and adjust spring tension as follows:
 - a. Check the spring to see if the spring is maintaining pressure on the chain (spring slightly stretched).
 - b. If spring tension needs to be increased, loosen the lower nut on the threaded adjustment rod and tighten the upper nut to increase tension.
 - c. After adjustment is complete, retighten the lower nut against the adjustment bracket.



WARNING

DO NOT operate the bagger unless all guards are secured in place. Moving parts inside could cause serious injury or death.

2. Place the rotor drive chain guard back on to the frame and secure in place before operating the bagger.



*Rotor Drive
Chain Guard*

*Threaded
Adjustment
Rod*

Upper Nut



Lower Nut

Lubrication And Maintenance

Tire Air Pressure

Interval: Daily

Check and maintain the proper air pressure. Check the air pressure daily.

Maintain the following pressures:

9.5L x 15 Implement Pressure Cold 44 psi

Wheel Lug Nut Torque

Torque each wheel lug nut per the specifications below. Check the lug nut torque and retorque after each 10 miles of highway use until the torque stabilizes. Check monthly thereafter.

Maintain the following lug nut torque:

1/2" Wheel Studs 75-85 ft.-lbs

Rotor Bearings

Interval: Per Bag

Each rotor bearing is greased by using a remote mounted grease fitting. One grease fitting is located on the drive end next to the rotor chain adjusting rod. The other grease fitting is located on the other end of the hopper below the conveyor.

Wipe off each fitting before attaching the grease gun. Grease each rotor bearing 10 pumps of grease per bag.

Rotor Bearing Grease Fitting Drive End

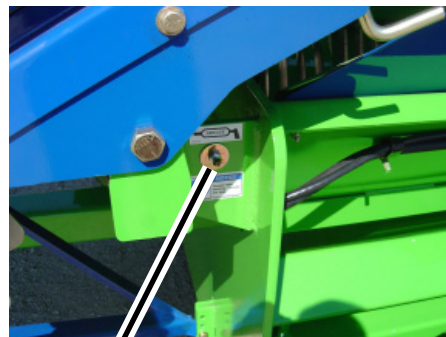

Rotor Bearing Grease Fitting (Under Conveyor)

Cable Drum Shaft Bearings

Interval: Daily



WARNING

DO NOT lubricate, adjust and/or service this machine unless the POWER SOURCE SHUT DOWN PROCEDURE (page 5) has been exercised.

Wipe off each fitting before attaching the grease gun. Grease each bearing. Wipe off excess grease when finished. There is one fitting on each side of each cable drum.



***Inner Cable Drum Shaft Bearing
Grease Fittings***

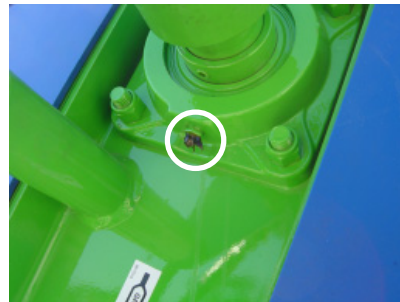

***Outer Cable Drum Shaft Bearing
Grease Fittings***

Upper Conveyor Apron Shaft Bearings

Interval: Daily



WARNING

DO NOT lubricate, adjust and/or service this machine unless the POWER SOURCE SHUT DOWN PROCEDURE (page 5) has been exercised.

Wipe off the fitting before attaching the grease gun. Grease each bearing. Wipe off excess grease when finished. There is one fitting for each bearing. Far side bearing fitting is remote mounted.

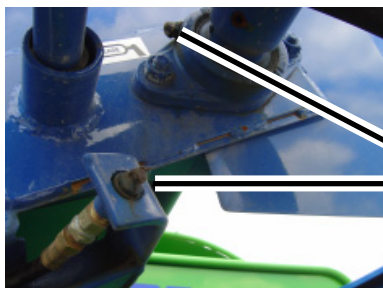

***Upper Conveyor Apron Shaft
Bearing Grease Fittings***

Lower Conveyor Apron Shaft Bearings

Interval: Daily



WARNING

DO NOT lubricate, adjust and/or service this machine unless the POWER SOURCE SHUT DOWN PROCEDURE (page 5) has been exercised.

Wipe off the fitting before attaching the grease gun. Grease each bearing. Wipe off excess grease when finished. There is one fitting for each bearing and located on each side of the conveyor.

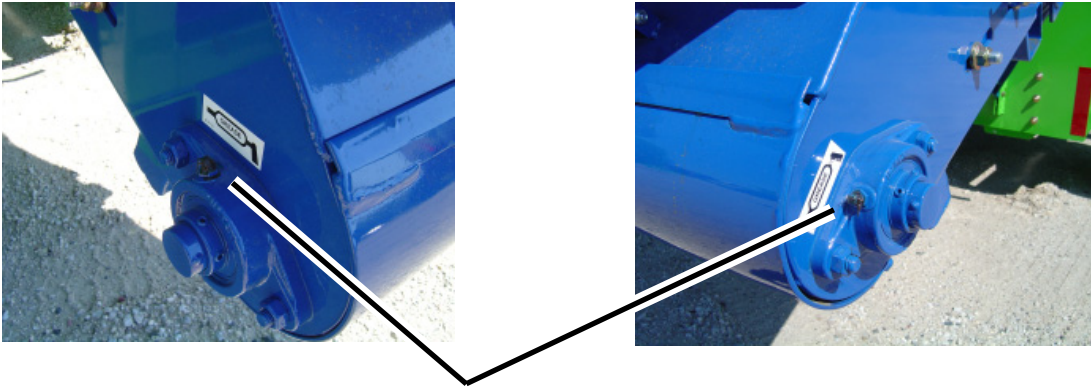

Lower Conveyor Apron Shaft Bearing Grease Fittings

Lower Conveyor Clean Out

Interval: Daily



WARNING

DO NOT lubricate, adjust and/or service this machine unless the POWER SOURCE SHUT DOWN PROCEDURE (page 5) has been exercised.

At the end of each day, open the lower conveyor clean out door and remove any product. Be sure to close and latch the clean out door before operating.

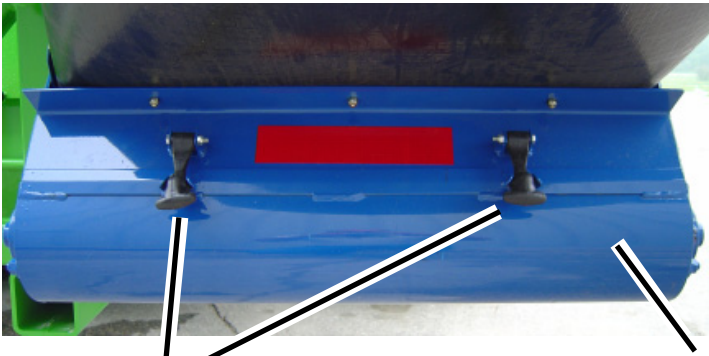

Clean Out Door Latches

Clean Out Door

PTO Shaft

Interval: Daily

Wipe off the fittings before attaching the grease gun. Grease each u-joint and the shear plates. Wipe off excess grease when finished.

Apply a coating of grease to the slide tube inside the PTO shaft at a monthly interval.

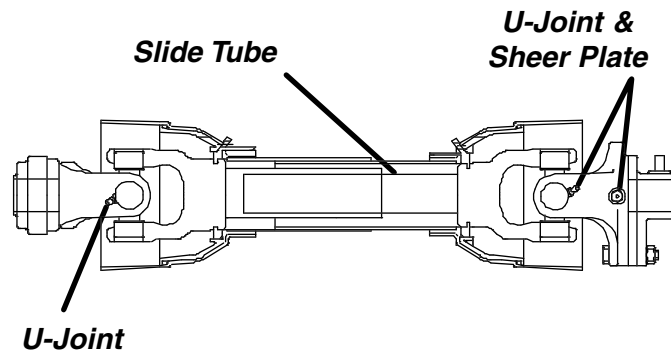

Bag Boom Pivot (If so equipped)

Interval: Monthly

Wipe off the fittings before attaching the grease gun. Grease each fitting and swing the bag boom from side to side to distribute the grease evenly. Do not over grease, the pivot tube is open on the bottom side. Wipe off excess grease when finished.

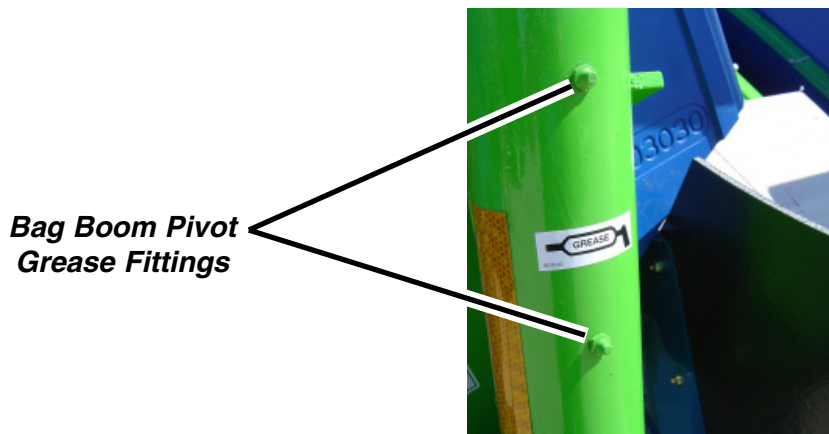

Wheel Bearings

Interval: Annually For Non Highway Use

For Highway Use Check Wheel Bearings Monthly

Type of Grease: Use a good grade of Lithium Base Wheel Bearing Grease.

Carefully raise and support each wheel as repacking is performed.

Remove the hub from the spindle and wipe old grease from all components. Inspect the inner and outer cups in the hub for signs of wear.

Pack the cones with clean grease. A pressure grease packer is recommended. To hand pack cones, force grease under cage between rollers from large end of rollers until grease shows at small end. Fill the hub with clean grease to I.D. of the cup race, then place the cone into the cup. Make sure the cone is straight!



WARNING:

Failure to correctly lubricate bearing and maintain proper lubrication may result in bearing damage which could cause wheel to lock and come off during operation.

Install new grease seal. Support the seal so as not to bend the case during installation.

Use grease to lubricate the seal lip.

Place the hub on to the spindle. Rotate the hub while doing this so that the seal lip does not fold under as the lip goes on the seat of the spindle.

Fill hub cavity with grease.

Place the outer cone on the spindle and into the cup.

Assemble the washer and nut onto the spindle and tighten the nut to 15-20 ft/lbs, while rotating the hub. Then back off nut until it aligns the next available slot with the cotter pin hole. Install the cotter pin and bend around the nut. There should be between .001" - .005" end play.



WARNING:

Failure to back off adjusting nut may cause bearing to run hot and be damaged. Wheel could then lock and come off during operation.

Grease inside of dust cover and install dust cover.

Lower the wheel to the ground and repeat for the other wheel.

Rotor Drive Chain

Interval: Once Per Bag

With the bagger idling, oil the rotor drive chain through the two round holes located in the top of the rotor drive chain guard. Oil both drive chains completely.

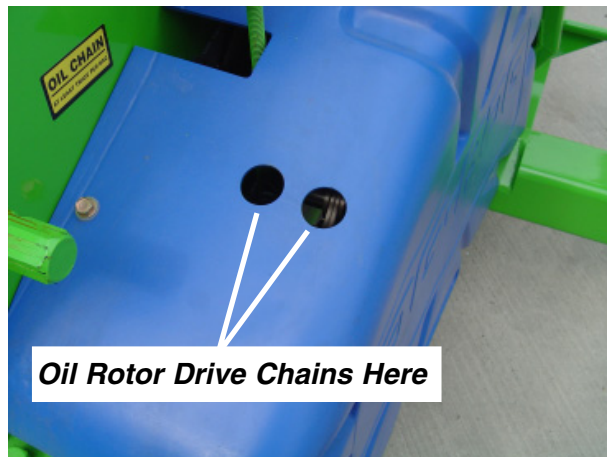

Oil Rotor Drive Chains Here

Gear Box Oil

Interval: Annually



WARNING

DO NOT lubricate, adjust and/or service this machine unless the POWER SOURCE SHUT DOWN PROCEDURE (page 5) has been exercised.

Change Gear Box Oil

1. Remove the rotor drive chain guard from the front of the hopper.
2. Place a suitable container under the drain plug located on the underside of the gear box. Remove the plug and allow all oil to drain from the gear box.
3. After all oil is drained, replace the drain plug and tighten securely.
4. On the opposite side of the gear box locate the level plug. Thoroughly clean the area around the level plug and remove.
5. On the topside of the gear box locate the fill/breather plug. Thoroughly clean the area around the fill/breather plug and remove the plug.
6. Slowly fill the gear box with **EP 80/90 Gear Lube** until the level reaches the level plug hole. Gear box capacity is 125 oz.
7. Replace the level plug and the fill/breather plug after proper level is reached. Tighten both plugs securely.



WARNING

DO NOT operate the bagger unless all guards are secured in place. Moving parts inside could cause serious injury or death.

8. Replace the rotor drive chain guard before operating.

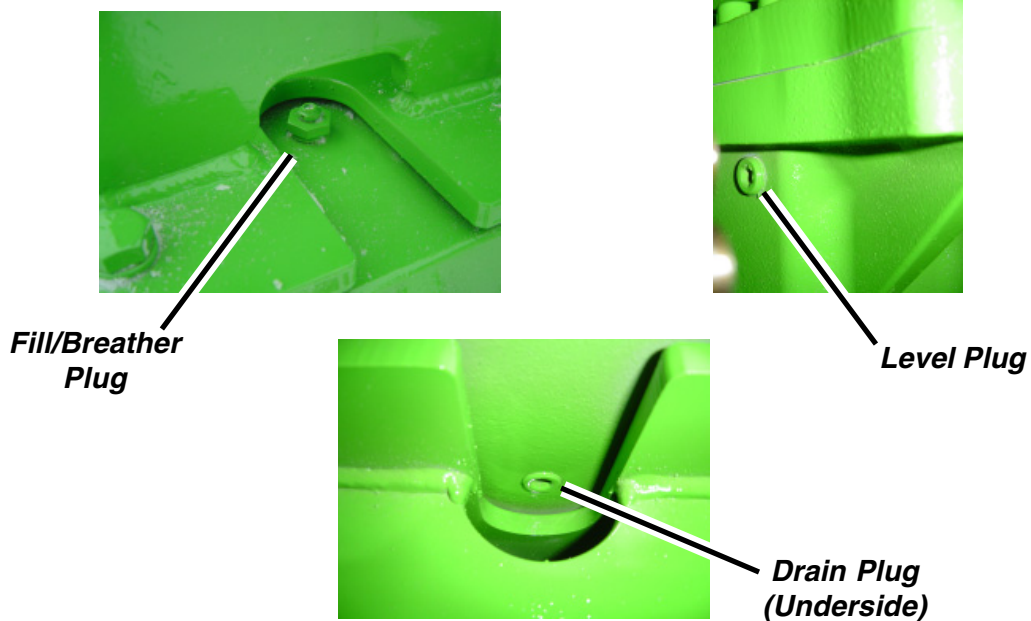

Cable Drum Brake Pads

Replace as needed

If the cable drum brake begins to lose the ability to hold the cable drums at the pressure required, the brake pads need to be replaced. Replace both pads on the cable drum.

1. Relieve the pressure in the brake system by opening the pump valve at the hand pump.

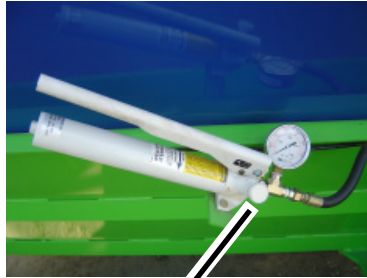

Pump Valve

2. Remove the cable drum rotor cover from the cable drum mount.

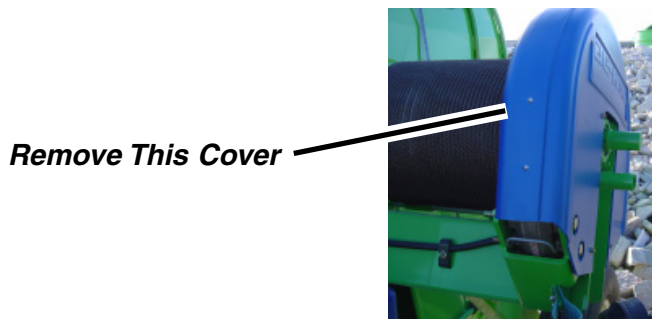

3. Replace the worn brake pads and replace with new. Replacement brake pads are available from your local Ag-bag dealer as a set of two by ordering part number 42.1500294. Before installing the new brake pads, clean the rotor of all rust and dirt. Inspect the rotor and dry off with a clean cloth before installing pads.
4. After brake pads are replaced, bleed the air from the brake system using the bleeders on the brake.

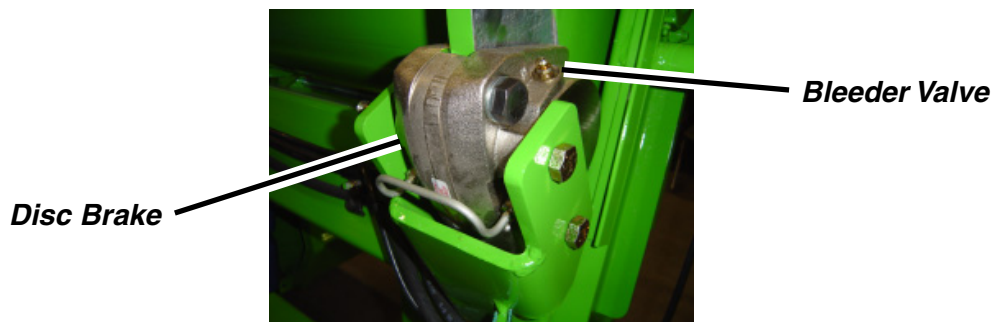

5. Replace the cable drum rotor cover before operating.

Rotor Tooth Tine Caps

Replace as needed



WARNING

DO NOT lubricate, adjust and/or service this machine unless the POWER SOURCE SHUT DOWN PROCEDURE (page 5) has been exercised.

Shut off the tractor, remove the ignition key and remove the PTO shaft from the tractor.

Periodically check the wear of the rotor tooth tine caps. Replace the caps if they show any of the following signs or wear:

- Cap is worn down and pointy.
- Sides of cap are worn to leave more than 1/8" gap between cap and stripper bar.
- Cap is bent or torn.
- Cap is missing.

Replace as follows:

1. Rotate the rotor by hand until the damaged or worn rotor cap is accessible from the tunnel side of the stripper bar.
2. Remove the existing rotor cap from the rotor tooth. Clean up the rotor tooth.
3. Place the new rotor tooth cap on top of the rotor tooth. The cap should be centered in the space between the two stripper bars. Be sure the cap is straight with the tooth and stitch weld in place (three places per side).
4. After welding is complete, make sure caps do not contact hopper or stripper bars. Grind caps to eliminate contact.

NOTE: If the space on either side of the new rotor tooth cap exceeds 1/8" the stripper bar plate may need replacement. Contact your Ag-Bag dealer.



Cables

Interval: Once Per Bag

IMPORTANT: Always wear gloves when handling or working with cables.

Check the cables at the end of each bag before the tension is released.

1. Check each cable for frayed spots, kinks, broken strands or thin spots.
2. Check the cable ends making sure the cable is not pulled from the sleeve.
3. If any damage to a cable is found, replace the cable before using again.

Depending on your bagger model and options, the cables are either 200 or 250 feet in length. The cables are 7/16" diameter.

Hydraulic Hand Pump

Interval: As Required

If the hand pump is low on oil and does not maintain the ability to pump correct pressure, the reservoir on the pump needs to be refilled.

IMPORTANT: Use only hydraulic oil in the hand pump. DO NOT use brake fluid in this system. Brake fluid will cause the seals to deteriorate and the hand pump to fail.

1. Release any pressure in the brake system by opening the pump valve.
2. Remove the filler plug.
3. Fill the pump with hydraulic jack oil to the bottom edge of the filler hole.
4. Replace the fill plug.
5. Bleed the air from the brake system using the bleeders at the calipers.

Note: Do not over fill the hand pump. An air pocket is required for pump to work properly.

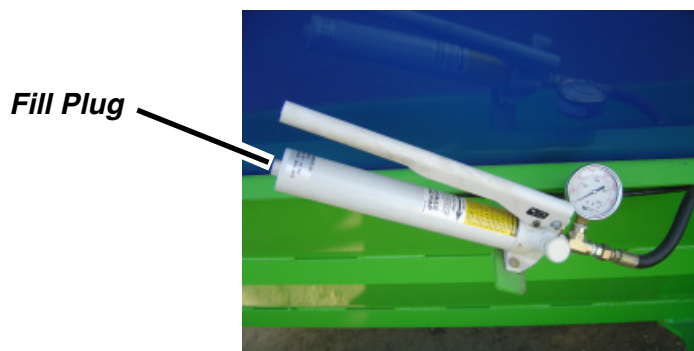

Troubleshooting

Problem	Cause	Solution
Rotor stops rotating, PTO shaft continues to turn.	Shear bolt on PTO shaft broken.	Replace shear bolt.
		Check for and remove obstruction from hopper.
		Check for further damage.
Conveyor apron slows down or stops.	Build up of product around lower apron shaft.	Open clean out door and remove product from shaft.
	Hydraulic drive motor worn or seals leaking.	Repair or replace hydraulic drive motor.
	Conveyor apron out of adjustment.	Adjust apron as required.
Brakes fail to hold cable drum at proper tension.	Cable drum brake pads worn.	Replace brake pads.
	Hand pump low on hydraulic oil.	Refill hand pump with hydraulic oil.
	Brake pad contact area on drum rotor rusty or corroded.	Clean rust or corrosion from drum rotor area.
	Air in brake lines.	Bleed air from system.
Conveyor fails to slide down to operating position.	Dirt build up on conveyor slides.	Clean and re-apply grease to slides.
Bag damage while bagging.	Cables contacting bag during operation.	Adjust cable tension to change shape of bag.
		Place cardboard between cable and bag at point of contact.
	Sharp objects on tunnel.	File or remove sharp corners or objects.

Troubleshooting (continued)

Problem	Cause	Solution
Multiple folds of bag are sliding off tunnel.	Bag pan does not have proper tension.	Tie knots in the bungee cords until proper spacing is obtained (about 3/4 inch) between bag pan and tunnel floor.
	Tunnel bungee cord not properly installed.	Check bungee installation. Make sure bungee is still hooked at both ends and that all tie strings are still in place.
Brake pressure will not increase while operating hand pump.	Too much oil in hand pump.	Loosen fill plug and operate hand pump. If this corrects problem, drain some oil from hand pump.
	Hand pump low on oil.	Refill with hydraulic oil.

Storage







Before placing the bagger into storage.

1. Remove any product or acidic juices which will cause corrosion.
2. Open the clean out door at the lower end of the conveyor and thoroughly clean out any product. Close the clean out door when complete.
3. Clean out the inoculant applicator (if so equipped).
4. Thoroughly clean and wash the entire bagger.
5. After washing and prior to placing the bagger in storage, grease and lubricate all moving parts on the bagger. Use only oils and lubricants recommended in the lubrication and maintenance or lubrication specifications sections of this manual.
6. With the bagger running at idle, grease both rotor bearings 20 pumps each to purge the bearings of old grease and any acidic juices that might still be present in or around the bearing.
7. Remove the rotor chain guard and remove the rotor chain from the sprockets. Soak the rotor chain in diesel fuel to clean the entire chain. When the chain is clean soak the entire chain in oil to lubricate the all the rollers. Check the sprockets on the bagger for any signs of wear. Repair or replace as needed. Reassemble the chain to the sprockets. Do not reassemble the rotor chain guard to the bagger until the gear box oil has been drained and refilled. See next step.
8. Drain the gear box and refill with new oil. Refer to the lubrication and maintenance or lubrication specifications sections of this manual for oil recommendations. Reassemble the rotor chain guard to the bagger.
9. Check for wear on the rotor tooth tine caps. Replace if worn down and pointy. Also replace if there is more than 1/8" spacing between the rotor tine caps and the stripper bars.
10. Remove all bungee cords from the bagger and store them inside out of the weather. Use a rope or wire to hold the bag pan up during storage.
11. Release all pressure from the drum brake system, place the pump handle in the lowered position and close the pump valve.
12. Apply a light coating of oil to the cables to prevent rusting during storage.
13. Store the bagger inside out of the weather.

Torque Specifications

NOTE: Use these torque values when tightening hardware (excluding: locknuts and self tapping, thread forming and sheet metal screws) unless specified otherwise.

All torque values are in lb-ft except those marked with an (*) which are lb-in (for metric torque value Nm, multiply lb-ft value by 1.355 or for lb-in multiply by 0.113).

Unified National Thread	Grade 2 		Grade 5 		Grade 8 	
	Dry	Lubed	Dry	Lubed	Dry	Lubed
8-32	19*	14*	30*	22*	41*	31*
8-36	20*	15*	31*	23*	43*	32*
10-24	27*	21*	43*	32*	60*	45*
10-32	31*	23*	49*	36*	68*	51*
1/4-20	66*	50*	9	75*	12	9
1/4-28	76*	56*	10	86*	14	10
5/16-18	11	9	17	13	25	18
5/16-24	12	9	19	14	25	20
3/8-16	20	15	30	23	45	35
3/8-24	23	17	35	25	50	35
7/16-14	32	24	50	35	70	55
7/16-20	36	27	55	40	80	60
1/2-13	50	35	75	55	110	80
1/2-20	55	40	90	65	120	90
9/16-12	70	55	110	80	150	110
9/16-18	80	60	120	90	170	130
5/8-11	100	75	150	110	220	170
5/8-18	110	85	180	130	240	180
3/4-10	175	130	260	200	380	280
3/4-16	200	150	300	220	420	320
7/8-9	170	125	430	320	600	460
7/8-14	180	140	470	360	660	500
1-8	250	190	640	480	900	680
1-14	270	210	710	530	1000	740
Metric Course Thread	Grade 8.8 		Grade 10.9 		Grade 12.9 	
	Dry	Lubed	Dry	Lubed	Dry	Lubed
M6-1	8	6	11	8	13.5	10
M8-1.25	19	14	27	20	32.5	24
M10-1.5	37.5	28	53	39	64	47
M12-1.75	65	48	91.5	67.5	111.5	82
M14-2	103.5	76.5	145.5	108	176.5	131
M16-2	158.5	117.5	223.5	165.5	271	200

Tightening Hydraulic Fittings



CAUTION

Escaping fluid under pressure can penetrate the skin causing serious injury. Relieve pressure before disconnecting hydraulic or other lines. Tighten all connections before applying pressure. Keep hands and body away from pin holes and nozzles which eject fluids under high pressure. Use a piece of cardboard or paper to search for leaks. **DO NOT** use your hand.

Tightening O-Ring Fittings*

1. Inspect O-ring and seat for dirt or obvious defects.
2. On angle fittings, back the locknut off until washer bottoms out at top of groove.
3. Hand tighten fitting until backup washer or washer face (if straight fitting) bottoms on face and O-ring is seated.
4. Position angle fittings by unscrewing no more than one turn.
5. Tighten straight fittings to torque shown.

* Torque values shown are based on lubricated connections as in reassembly.

Thread Size (In.)	Nut Size Across Flats (In.)	Torque Value*		Recommended Turns To Tighten (After Finger Tightening)	
		(Nm)	(lb-ft)	(Flats)	(Turns)
3/8	1/2	8	6	2	1/3
7/16	9/16	12	9	2	1/3
1/2	5/8	16	12	2	1/3
9/16	11/16	24	18	2	1/3
3/4	7/8	46	34	2	1/3
7/8	1	62	46	1-1/2	1/4
1-1/16	1-1/4	102	75	1	1/6
1-3/16	1-3/8	122	90	1	1/6
1-5/16	1-1/2	142	105	3/4	1/8
1-5/8	1-7/8	190	140	3/4	1/8
1-7/8	2-1/8	217	160	1/2	1/12

Tightening Flare Type Fittings*

1. Check flare and flare seat for defects that might cause leakage.
2. Align hose end with fitting before tightening.
3. Lubricate connection and hand tighten swivel nut until snug.
4. To prevent twisting the hose, use two wrenches. Place one wrench on the hose end body and with the second wrench, tighten the swivel nut to the torque shown in this chart.

* Torque values shown are based on lubricated connections as in reassembly.

Tube Size OD (In.)	Nut Size Across Flats (In.)	Torque Value*		Recommended Turns To Tighten (After Finger Tightening)	
		(Nm)	(lb-ft)	(Flats)	(Turns)
3/16	7/16	8	6	1	1/6
1/4	9/16	12	9	1	1/6
5/16	5/8	16	12	1	1/6
3/8	11/16	24	18	1	1/6
1/2	7/8	46	34	1	1/6
5/8	1	62	46	1	1/6
3/4	1-1/4	102	75	3/4	1/8
7/8	1-3/8	122	90	3/4	1/8

Machine Specifications

Width - Towing

Model PB6000 14 ft. - 6 in

Width - Bagging

Model PB6000 16 ft. - 8 in

Length - Towing

Model PB6000 12 ft.

Maximum Height

Model PB6000 8 ft.

Weight

Model PB6000 Approximately 5,6900 lbs

Rotor Length

Model PB6000 6 ft.

Rotor Teeth

Model PB6000 36

Maximum Bag Length

Model PB6000 200 ft.

Horse Power - Minimum

Model PB6000 70 HP Min

Horse Power - Maximum

Model PB6000 120 HP Max

Cable Length

Model PB6000 200 ft.

Lubrication Specifications

Gear Box

Type of Oil EP 80/90 Gear Oil
Capacity 125 Oz.

Hand Pump

Type Of Oil Hydraulic Jack Oil

Grease

Type Of Grease Grade 2 Lithium Complex EP Grease

Wheel Bearings

Type Of Grease Wheel Bearing Grease

Rotor Chain

Type Of Oil SAE 30

This Page Intentionally Left Blank

MACHINE WARRANTY

6000 Series Bagger

MILLER-ST. NAZIANZ, INC. warrants each new Ag-Bag® 6000 series Bagger to be free from defects in material and workmanship under recommended use and service, as stated in the Operator's Manual, as follows:

Warranty

Miller will replace, F.O.B. St. Nazianz, Wisconsin, or repair, as Miller elects, any part of a new 6000 series Bagger which is defective in material or workmanship: Without charge for either parts or labor during the first year following delivery to the original retail customer.

The warranty period for equipment used for commercial, industrial, lease, rental and custom operation or any non agricultural use is limited to 90 days from date of delivery to the first retail user.

All warranties on the new 6000 series Bagger shall apply only to the original retail purchaser from an authorized Ag-Bag dealer.

Repair Parts

Miller warrants that it will replace F.O.B. St. Nazianz, Wisconsin, or repair, as Miller elects, without charge, any genuine Ag-Bag spare part purchased after the expiration of the new 6000 series Bagger warranty, or to any subsequent owners that is defective in material or workmanship, within ninety (90) days of the installation date.

Misuse

The provisions of this warranty shall not apply to any 6000 series Bagger which has been subject to misuse, negligence, alteration or accident, or which shall have been repaired with parts other than those obtainable through Ag-Bag.

Authorized Dealer

Repairs eligible for labor warranty must be made by Ag-Bag or an authorized Ag-Bag dealer. The purchaser is responsible for transportation of the equipment to the dealership for warranty service or for any service call expense.

Exclusive Effect of Warranty and Limitation of Liability

The remedies of the customer set forth herein are exclusive. Miller neither assumes nor authorizes any person to assume any other obligation or liability in connection with the sale of covered equipment. Correction of defects and malfunctions in the manner and for the applicable period of time provided above shall constitute fulfillment of all responsibilities of Miller to the customer and Miller shall not be liable for negligence, under contract, or in any other manner with respect to such equipment. IN NO EVENT SHALL THE OWNER BE ENTITLED TO RECOVER FOR INCIDENTAL OR CONSEQUENTIAL DAMAGES SUCH AS BUT NOT LIMITED TO: LOSS OF CROPS, LOSS OF PROFITS OR REVENUE, OTHER COMMERCIAL LOSSES, INCONVENIENCE OR COST OF RENTAL OF REPLACEMENT EQUIPMENT.

THIS WARRANTY IS IN LIEU OF ALL WARRANTIES OF MERCHANTABILITY, FITNESS FOR A PURPOSE OR OTHER WARRANTIES, EXPRESS OR IMPLIED.

Warranty Requirements

To be covered by warranty, each machine must be properly registered with Miller within 30 days of date of original retail delivery.



© 2007 by Miller-St. Nazianz, Inc.
