

TRANSCAT[®]
Trust in every measure

• Largest Inventory of Fluke Tools
• Best Pricing & Fast Shipping

Request a Quote 

FLUKE[®]

724/725/726

Calibrators

Calibration Manual

PN 667581

September 1999 Rev. 3, 4/14

©1999-2014 Fluke Corporation. All rights reserved. Printed in USA
All product names are trademarks of their respective companies.

LIMITED WARRANTY AND LIMITATION OF LIABILITY

Each Fluke product is warranted to be free from defects in material and workmanship under normal use and service. The warranty period is three years and begins on the date of shipment. Parts, product repairs, and services are warranted for 90 days. This warranty extends only to the original buyer or end-user customer of a Fluke authorized reseller, and does not apply to fuses, disposable batteries, or to any product which, in Fluke's opinion, has been misused, altered, neglected, contaminated, or damaged by accident or abnormal conditions of operation or handling. Fluke warrants that software will operate substantially in accordance with its functional specifications for 90 days and that it has been properly recorded on non-defective media. Fluke does not warrant that software will be error free or operate without interruption.

Fluke authorized resellers shall extend this warranty on new and unused products to end-user customers only but have no authority to extend a greater or different warranty on behalf of Fluke. Warranty support is available only if product is purchased through a Fluke authorized sales outlet or Buyer has paid the applicable international price. Fluke reserves the right to invoice Buyer for importation costs of repair/replacement parts when product purchased in one country is submitted for repair in another country.

Fluke's warranty obligation is limited, at Fluke's option, to refund of the purchase price, free of charge repair, or replacement of a defective product which is returned to a Fluke authorized service center within the warranty period.

To obtain warranty service, contact your nearest Fluke authorized service center to obtain return authorization information, then send the product to that service center, with a description of the difficulty, postage and insurance prepaid (FOB Destination). Fluke assumes no risk for damage in transit. Following warranty repair, the product will be returned to Buyer, transportation prepaid (FOB Destination). If Fluke determines that failure was caused by neglect, misuse, contamination, alteration, accident, or abnormal condition of operation or handling, including overvoltage failures caused by use outside the product's specified rating, or normal wear and tear of mechanical components, Fluke will provide an estimate of repair costs and obtain authorization before commencing the work. Following repair, the product will be returned to the Buyer transportation prepaid and the Buyer will be billed for the repair and return transportation charges (FOB Shipping Point).

THIS WARRANTY IS BUYER'S SOLE AND EXCLUSIVE REMEDY AND IS IN LIEU OF ALL OTHER WARRANTIES, EXPRESS OR IMPLIED, INCLUDING BUT NOT LIMITED TO ANY IMPLIED WARRANTY OF MERCHANTABILITY OR FITNESS FOR A PARTICULAR PURPOSE. FLUKE SHALL NOT BE LIABLE FOR ANY SPECIAL, INDIRECT, INCIDENTAL OR CONSEQUENTIAL DAMAGES OR LOSSES, INCLUDING LOSS OF DATA, ARISING FROM ANY CAUSE OR THEORY.

Since some countries or states do not allow limitation of the term of an implied warranty, or exclusion or limitation of incidental or consequential damages, the limitations and exclusions of this warranty may not apply to every buyer. If any provision of this Warranty is held invalid or unenforceable by a court or other decision-maker of competent jurisdiction, such holding will not affect the validity or enforceability of any other provision.

Fluke Corporation
P.O. Box 9090
Everett, WA 98206-9090
U.S.A.

Fluke Europe B.V.
P.O. Box 1186
5602 BD Eindhoven
The Netherlands

Table of Contents

Title	Page
Introduction.....	1
Contacting Fluke.....	1
Read First – Safety Information.....	2
International Symbols.....	3
Specifications.....	4
DC Voltage Measurement (724 and 725).....	4
DC Voltage Measurement and Source (726).....	4
DC Voltage Source (724 and 725).....	4
DC mA Measurement and Source (724 and 725) (Measurement only for 724).....	4
DC mA Measurement and Source (726).....	5
Ohms Measurement (724 and 725).....	5
Ohms Measurement (726).....	5
Ohms Source (724 and 725).....	5
Ohms Source (726).....	6
Frequency Measurement (725).....	6
Frequency Measurement (726).....	6
Frequency Source (725).....	6
Frequency Source (726).....	7
Millivolt Measurement and Source (724 and 725).....	7
Temperature, Thermocouples (724 and 725).....	7
Temperature, Thermocouples (726).....	8
Temperature, RTD Ranges, and Accuracies (724 and 725).....	9
RTD Accuracy (Read and Source) (ITS-90) (726).....	10
Loop Power Supply.....	11
Pressure Measurement (725 and 726).....	11
Pulse Read and Pulse Source (726).....	11
Pressure Units Availability (725).....	11
General Specifications.....	12
Cleaning the Calibrator.....	12
Replacing the Batteries.....	13
Fuses.....	14
Remote Control Interface (725 and 726).....	15
Serial Command List (726).....	18
Performance Tests.....	25
Preparing for the Performance Tests.....	25
Upper Display Voltage Measurement Tests.....	26
Lower Display mV/TC Measurement Tests.....	27
Lower Display Voltage Measurement Tests.....	28
Upper Display mA Measurement Tests.....	29
Lower Display mA Measurement Tests (725 and 726).....	30

Lower Display Frequency Measurement Test (725 and 726)	31
Lower Display Frequency Source Test (725 and 726)	32
Lower Display 4-Wire Resistance Measurement Tests	33
Lower Display 3-Wire RTD Measurement	34
Lower Display Thermocouple Measurement Tests	35
Lower Display Thermocouple Source Test	36
Lower Display mA Source Tests (725 and 726)	37
Lower Display mV Source Tests	38
Lower Display Voltage Source Tests	38
Lower Display Ohms Source Tests	39
Pressure Module Input (725/726)	40
Calibration Adjustment	40
Setup	40
Initiating Communication (724 and 725 with V2.xx and Lower Firmware)	42
Calibration Adjustment Procedures (724 and 725 with V2.xx and Lower Firmware)	43
Cal Volts Input	43
Cal Volts Output	44
Cal mA Input (Fluke 725 Only)	45
Cal mA Output (725 Only)	46
Cal mV Input	47
Cal mV Output	48
Cal Thermocouples	49
Cal Ohms Hi Source	50
Cal Ohms Low Source	51
Cal RTD Low Range	52
Cal RTD Hi Range	53
Cal ISO Volts	54
Cal ISO mA	55
Calibration Adjustment Procedures (726 and 724/725 with V3.00 and Higher)	56
Initiating Communication	56
Calibrating Isolated mA Input	58
Calibrating Isolated Voltage Input	59
Calibrating mA Input (Fluke 725 and 726 only)	60
Calibrating mA Output (Fluke 725 and 726 only)	61
Calibrating Voltage Input	62
Calibrating Voltage Output	63
Calibrating Low Ohms Source	64
Calibrating High Ohms Source	65
Calibrating Ohms Measure	66
Calibrating Thermocouple mV Output	67
Calibrating Thermocouple mV Input	68
Calibrating Thermocouple CJC:	69
Replaceable Parts	70

List of Tables

Table	Title	Page
1.	International Symbols	3
2.	Upper Display Remote Commands (725 with V2.xx and lower)	16
3.	Lower Display Remote Commands (725).....	16
4.	Remote Commands for Sensor Selection (725 with V2.xx and lower)	17
5.	Serial Command List-726 and 725 V3.00 and Later.....	18
6.	Required Equipment and Software	24
7.	Upper Display Voltage Readings.....	26
8.	Lower Display mV Readings	27
9.	Lower Display Voltage Readings	28
10.	Upper Display mA Readings.....	29
11.	Lower Display mA Readings	30
12.	Lower Display 4-Wire Resistance Readings.....	33
13.	Type J Thermocouple Readings.....	35
14.	Lower Display Thermocouple Source Readings.....	36
15.	Lower Display mA Source Readings	37
16.	Lower Display mV Source Readings	38
17.	Lower Display Voltage Source Readings	38
18.	Lower Display Ohms Source Readings.....	39
19.	Replacement Parts	70

List of Figures

Figure	Title	Page
1.	Replacing the Batteries and Replaceable Fuses	13
2.	Upper Display Voltage Test Connections	26
3.	Lower Display mV and Voltage Test Connections	27
4.	Upper Display mA Test Connections.....	29
5.	Lower Display mA Test Connections	30
6.	Lower Display Frequency Test Connections	31
7.	Lower Display Frequency Source Test Connections	32
8.	Lower Display 4-Wire Resistance Test Connections	33
9.	Lower Display 3-Wire Resistance Test Connections	34
10.	Lower Display Thermocouple Test Connections	35
11.	Lower Display mA Source Test	37
12.	Lower Display Ohms Source Test Connections.....	39
13.	Volts Input Calibration Connections	43
14.	Volts Output Calibration Connections	44
15.	mA Input Calibration Connections	45
16.	mA Output Calibration Connections	46
17.	mV Input Calibration Connections	47
18.	mV Output Calibration Connections	48
19.	Thermocouples Calibration Connections	49
20.	Ohms Hi Source Calibration Connections	50
21.	RTD Low Range Calibration Connections	52
22.	ISO Volts Calibration Connections	54
23.	ISO mA Calibration Connections	55
24.	Isolated mA Input Calibration Connections	58
25.	Isolated Voltage Input Calibration Connections	59
26.	mA Input Calibration Connections	60
27.	mA Output Calibration Connections	61
28.	Voltage Input Calibration Connections.....	62
29.	Voltage Output Calibration Connections	63
30.	Low Ohms Source Calibration Connections	64
31.	High Ohms Source Calibration Connections	65
32.	Ohms Measure Calibration Connections.....	66
33.	Thermocouple mV Output Calibration Connections.....	67
34.	Thermocouple mV Input Calibration Connections	68
35.	Thermocouple CJC Calibration Connections.....	69
36.	Replacement Parts	71

Introduction

Warning

The information provided in this manual is for the use of qualified personnel only. Do not perform the verification tests or calibration procedures described in this manual unless you are qualified to do so.

This Calibration Manual provides the following information for the Fluke 724 Temperature Calibrator and the Fluke 725 and 726 Multifunction Process Calibrators (also referred to as "the Calibrator" and/or "the UUT"):

- Precautions and safety information
- Equipment required for performance tests and calibration
- Specifications
- Basic maintenance (cleaning, batteries, and fuses)
- Instructions for using the remote control interface
- Performance test procedures
- Calibration procedures
- List of replaceable parts

For complete operating instructions, refer to the appropriate *Users Manual* (located on the CD-ROM shipped with the instrument).

Caution

The Calibrator contains parts that can be damaged by static discharge. No procedure in this document requires the case to be opened. If you do so, follow the standard practices for handling static sensitive devices.

Contacting Fluke

To contact Fluke, call one of the following telephone numbers:

- Technical Support USA: 1-800-44-FLUKE (1-800-443-5853)
- Calibration/Repair USA: 1-888-99-FLUKE (1-888-993-5853)
- Canada: 1-800-36-FLUKE (1-800-363-5853)
- Europe: +31 402-675-200
- Japan: +81-3-6714-3114
- Singapore: +65-6799-5566
- Anywhere in the world: +1-425-446-5500

Or, visit Fluke's website at www.fluke.com.

To register your product, visit <http://register.fluke.com>.

To view, print, or download the latest manual supplement, visit <http://us.fluke.com/usen/support/manuals>.

Read First – Safety Information

In this calibration manual, a **Warning** identifies conditions and actions that pose hazard(s) to the user. A **Caution** identifies conditions and actions that may damage the Calibrator or the test instruments.

Warnings

To avoid possible electric shock or personal injury:

- **DO NOT** use the Calibrator if it looks damaged.
- Follow all safety procedures for the test and calibration equipment you use.
- Examine the Calibrator before use. Look for cracks in the case, missing plastic, or damaged insulation around the connectors.
- Inspect the test leads for damaged insulation or exposed metal. Check for test lead continuity. Replace damaged test leads as necessary.
- Do not use the Calibrator if it operates abnormally. Protection may be impaired. When in doubt, have the instrument serviced.
- Do not apply more than the rated voltage, as marked on the Calibrator, between terminals or between any terminal and earth ground.
- Never touch the probes to a voltage source when the test leads are plugged into the current terminals.
- Select the proper function and range for each measurement.
- Disconnect the test leads before changing to another measure or source function.
- When using probes, keep fingers behind the finger guards on the probes.
- Use caution when working above 30 V ac rms, 42 V ac peak, or 60 V dc. Such voltages pose a shock hazard.
- Connect the common lead (COM) before connecting the live test lead. When disconnecting test leads, disconnect the live test lead first.
- Always place the 5520A calibrator in Standby (STBY) mode between tests and before handling the test connections or cables.
- Remove test leads from the Calibrator before opening the battery door.
- Do not operate the Calibrator around explosive gas, vapor, or dust.
- During normal operation, only use four properly installed AA batteries to power the Calibrator.
- Make sure the battery door is closed and latched before you operate the Calibrator.
- During calibration, use only specified calibration equipment listed in Table 6.

  Warnings (cont.)

- When servicing the Calibrator, use only specified replacement parts.
- To avoid false readings, which can lead to possible electric shock or personal injury, replace the batteries as soon as the low battery indicator () appears.

 Caution















To avoid possible damage to the Calibrator or to the test instruments:

- Disconnect the power and discharge all high voltage capacitors before testing resistance, diodes, or continuity.
- Use the proper jacks, function, and range for each measurement or sourcing application.

International Symbols

International symbols used on the Calibrator and in this manual are explained in Table 1.

Table 1. International Symbols

Symbol	Meaning	Symbol	Meaning
	AC (Alternating Current)		Earth Terminal
	DC (Direct Current)		ON/OFF
	AC or DC (Alternating or Direct Current)		Conforms to European Union directives
	Pressure		Battery
	Risk of Danger. Important information. See Manual.		Conforms to relevant North American Safety Standards.
	Hazardous voltage. Risk of electric shock.		Double Insulated
	Conforms to relevant Australian EMC standards		Conforms to relevant South Korean EMC Standards
	This product complies with the WEEE Directive (2002/96/EC) marking requirements. The affixed label indicates that you must not discard this electrical/electronic product in domestic household waste. Product Category: With reference to the equipment types in the WEEE Directive Annex I, this product is classed as category 9 "Monitoring and Control Instrumentation" product. Do not dispose of this product as unsorted municipal waste. Go to Fluke's website for recycling information.		

Specifications

Performance and accuracy are specified for one year after calibration, at operating temperatures of +18 °C to +28 °C (64 °F to 82 °F), in relative humidity to 90 %, after a 5 minute warm up period.

Note

A “count” is the amount by which the least significant digit can vary.

DC Voltage Measurement (724 and 725)

Range	Resolution	Accuracy (% of Reading + Counts)
30 V (upper display)	0.001 V	0.02 % + 2
20 V (lower display)	0.001 V	0.02 % + 2
90 mV (lower display)	0.01 mV	0.02 % + 2
Temperature coefficient -10 °C to +18 °C, 28 °C to 55 °C: ±0.005 % of range per °C		

DC Voltage Measurement and Source (726)

Range	Minimum	Maximum	Accuracy, (% of Reading + Floor)
30 V (upper display)	0.000 V	30.000 V	0.010 % + 2 mV
20 V (lower display)	0.000 V	20.000 V	0.010 % + 2 mV
20 V (Source)	0.000 V	20.000 V	0.010 % + 2 mV
100 mV (Source)	0.000 V	100.000 mV	0.010 % + 10 µV
90 mV (Read)	0.000 V	90.000 mV	0.010 % + 10 µV
Maximum current output in voltage ranges is 1 mA with an output impedance of ≤ 1 Ω			

DC Voltage Source (724 and 725)

Range	Resolution	Accuracy (% of Reading + Counts)
100 mV	0.01 mV	0.02 % + 2
10 V	0.001 V	0.02 % + 2
Temperature coefficient -10 °C to +18 °C, 28 °C to 55 °C: ±0.005 % of range per °C		
Maximum load: 1 mA		

DC mA Measurement and Source (724 and 725) (Measurement only for 724)

Range	Resolution	Accuracy (% of Reading + Counts)
24 mA	0.001 mA	0.02 % + 2
Temperature coefficient -10 °C to +18 °C, +28 °C to 55 °C: ±0.005 % of range per °C		
Drive capability: 1000 Ω at 20 mA		

DC mA Measurement and Source (726)

Range	Minimum	Maximum	Accuracy, (% of Reading + Floor)
mA Read (Upper Display)	0.000	24.000	0.010 % + 2 μ A
mA Read (Lower Display)	0.000	24.000	0.010 % + 2 μ A
mA Source	0.000	24.000	0.010 % + 2 μ A
Maximum load on, mA source is 1 k Ω . With the HART resistor on, maximum load is 750 Ω . Voltage input range on simulate mode is 5 to 30 V			

Ohms Measurement (724 and 725)

Ohms Range	Accuracy, 4-Wire	Accuracy*, 2-Wire, or 3-Wire
0 Ω to 400 Ω **	$\pm 0.1 \Omega$	$\pm 0.15 \Omega$
400 Ω to 1.5 k Ω	$\pm 0.5 \Omega$	$\pm 1.0 \Omega$
1.5 Ω to 3.2 k Ω	$\pm 1 \Omega$	$\pm 1.5 \Omega$
Excitation Current: 0.2 mA Maximum input voltage: 30 V Temperature coefficient -10 $^{\circ}$C to +18 $^{\circ}$C, +28 $^{\circ}$C to 55 $^{\circ}$C: ± 0.005 % of range per $^{\circ}$ C		
* 2-wire: Does not include lead resistance. ** For Firmware V1.7 or lower, the lowest range is 15 Ω to 400 Ω . 3-wire: Assumes matched leads with a total resistance not exceeding 100 Ω .		

Ohms Measurement (726)

Ohms Range	Minimum	Maximum	Accuracy (% of Reading + Floor)
Ohms Read (low)	0.00	400.00	0.015 % + 0.05 Ω
Ohms Read (high)	400.0	4000.0	0.015 % + 0.5 Ω

Ohms Source (724 and 725)

Ohms Range	Excitation Current from Measurement Device	Accuracy
15 Ω to 400 Ω	0.15 mA to 0.5 mA	$\pm 0.15 \Omega$
15 Ω to 400 Ω	0.5 mA to 2 mA	$\pm 0.1 \Omega$
400 Ω to 1.5 k Ω	0.05 mA to 0.8 mA	$\pm 0.5 \Omega$
1.5 k Ω to 3.2 k Ω	0.05 mA to 0.4 mA	$\pm 1 \Omega$
Temperature coefficient -10 $^{\circ}$C to +18 $^{\circ}$C, 28 $^{\circ}$C to 55 $^{\circ}$C: ± 0.005 % of resistance range per $^{\circ}$ C		
Resolution		
15 Ω to 400 Ω	0.1 Ω	
400 Ω to 3.2 k Ω	1 Ω	

Ohms Source (726)

Ohms Range	Minimum	Maximum	Excitation Current from Measurement Device	Accuracy (% of Reading + Floor)
Ohms Source (low)	5.0	400.0	0.1 mA to 0.5 mA	0.015 % + 0.1 Ω
	5.0	400.0	0.5 mA to 3 mA	0.015 % + 0.05 Ω
Ohms Source (high)	400	1500	0.05 mA to 0.8 mA	0.015 % + 0.5 Ω
	1500	4000	0.05 mA to 0.4 mA	0.015 % + 0.5 Ω

Unit is compatible with smart transmitters and PLCs.
Frequency response is ≤ 5 mS

Frequency Measurement (725)

Range	Resolution	Accuracy
2.0 CPM to 1000.0 CPM	0.1 CPM	$\pm (0.05 \% + 1 \text{ count})$
1 Hz to 1000 Hz	0.1 Hz	$\pm (0.05 \% + 1 \text{ count})$
1.0 kHz to 10.0 kHz	0.01 kHz	$\pm (0.05 \% + 1 \text{ count})$

Sensitivity: 1 V peak-to-peak minimum
Waveform: Squarewave

Frequency Measurement (726)

Range	Minimum	Maximum	Accuracy (% of Reading + Floor)
CPM Read	2.0	1000.0	0.05 % + 0.1 CPM
Hz Read	1.0	1000.0	0.05 % + 0.1 Hz
kHz Read	1.00	15.00	0.05 % + 0.01 KHz

Frequency Source (725)

Range	Resolution	Accuracy (% of output frequency)
2.0 CPM to 1000.0 CPM	0.1 CPM	$\pm 0.05 \%$
1 Hz to 1100 Hz	1 Hz	$\pm 0.05 \%$
1.0 kHz to 10.0 kHz	0.1 kHz	$\pm 0.25 \%$

Waveform: 5 V p-p squarewave, -0.1 V offset

Frequency Source (726)

Range	Minimum	Maximum	Accuracy
CPM Source	2.0	1000	0.05 %
Hz Source	1.0	1000.0	0.05 %
kHz Source	1.0	10.00	0.25 %
	10.00	15.00	0.50 %

Millivolt Measurement and Source (724 and 725)

Range*	Resolution	Accuracy
-10 mV to +75 mV	0.01 mV	±(0.025 % + 1 count)
Maximum input voltage: 30 V		
Temperature coefficient -10 °C to +18 °C, 28 °C to 55 °C: ±0.005 % of range per °C		
*Select this function by pressing <input type="checkbox"/> TC. The signal is available at the thermocouple miniplug connector.		

Temperature, Thermocouples (724 and 725)

Type	Range (°C)	Measure and Source Accuracies (°C) Firmware <3.00	Measure and Source Accuracies (°C) Firmware ≥3.00
J	-200 to 0	1.0	1.0
	0 to 1200	0.7	0.7
K	-200 to 0	1.2	1.2
	0 to 1370	0.8	0.8
T	-200 to 0	1.2	1.2
	0 to 400	0.8	0.8
E	-200 to 0	0.9	0.9
	0 to 950	0.7	0.7
R	-20 to 0	2.5	2.5
	0 to 500	1.8	1.8
	500 to 1750	1.4	1.4
S	-20 to 0	2.5	2.5
	0 to 500	1.8	1.8
	500 to 1750	1.5	1.5
B	600 to 800	2.2	2.2
	800 to 1000	1.8	1.8
	1000 to 1800	1.4	1.4
L	-200 to 0	0.85	0.85
	0 to 900	0.7	0.7
U	-200 to 0	1.1	1.1
	0 to 400	0.75	0.75
N	-200 to 0	1.5	1.5
	0 to 1300	0.9	0.9
XK	-200 to 800	NA	0.8
BP	0 to 800	NA	1.5
	800 to 2500	NA	2.7
Resolution:			
J, K, T, E, L, N, U, XK, BP: 0.1 °C, 0.1 °F			
B, R, S: 1 °C, 1 °F			
* For Firmware V1.7 or lower, the type N TC has 400 °C as the upper limit.			

Temperature, Thermocouples (726)

Type	Minimum (°C)	Maximum (°C)	CJC ON Accuracy (°C)	CJC OFF Accuracy (°C)
J	-210	0.0	0.6	0.4
	0.0	800	0.4	0.2
	800	1200	0.5	0.3
K	-200	0.0	0.8	0.6
	0.0	1000	0.5	0.3
	1000	1372	0.7	0.5
T	-250	0.0	0.8	0.6
	0.0	400	0.4	0.2
E	-250	-100	0.8	0.6
	-100	1000	0.4	0.4
R	-20	0.0	2.0	1.8
	0.0	1767	1.4	1.2
S	-20	0.0	2.0	1.8
	0.0	1767	1.4	1.2
B	600	800	1.4	1.2
	800	1000	1.5	1.3
	1000	1820	1.7	1.5
C	0.0	1000	0.8	0.6
	1000	2316	2.5	2.3
L	-200	0.0	0.45	0.25
	0.0	900	0.4	0.2
U	-200	0.0	0.7	0.5
	0.0	600	0.45	0.25
N	-200	0.0	1.0	0.8
	0.0	1300	0.6	0.4
XK	-200	800	0.4	0.2
BP	0.0	800	1.1	0.9
	800	2500	2.3	2.1
			Range	Accuracy
Thermocouple in mV read			-10 mV to 75 mV	0.015 % + 10 μ V (% of Reading + Floor)
Thermocouple in mV source			-10 mV to 75 mV	0.015 % + 10 μ V (% of Reading + Floor)
Maximum current output in voltage ranges is 1 mA with an output impedance of $\leq 1 \Omega$ CJC error outside of $23 \pm 5 \text{ }^\circ\text{C}$ is $0.05 \text{ }^\circ\text{C} / \text{ }^\circ\text{C}$				

Temperature, RTD Ranges, and Accuracies (724 and 725)

Type	Range (°C)	Accuracy		
		Measure 4-wire (°C)	Measure* 2- and 3-wire (°C)	Source (°C)
Ni120	-80 to 260	0.2	0.3	0.2
Pt100-385	- 200 to 800	0.33	0.5	0.33
Pt100-392	-200 to 630	0.3	0.5	0.3
Pt100-JIS	-200 to 630	0.3	0.5	0.3
Pt200-385	-200 to 250	0.2	0.3	0.2
	250 to 630	0.8	1.6	0.8
Pt500-385	-200 to 500	0.3	0.6	0.3
	500 to 630	0.4	0.9	0.4
Pt1000-385	-200 to 100	0.2	0.4	0.2
	100 to 630	0.2	0.5	0.2

Resolution: 0.1 °C, 0.1 °F
Allowable excitation current (source): Ni120, Pt100-385, Pt100-392, Pt100-JIS, Pt200-385: 0.05 to 0.80 mA, Pt500-385: 0.05 to 0.80 mA; Pt1000-385: 0.05 to 0.40 mA
RTD Source: Addresses pulsed transmitters and PLCs with pulses as short as 5 ms. SN < 7624001 may need modification for pulses less than 15 ms.
*2-wire: Does not include lead resistance.
3-wire: Assumes matched leads with a total resistance not exceeding 100 Ω.

RTD Accuracy (Read and Source) (ITS-90) (726)

Range	Minimum	Maximum	Accuracy
Ni120 (672)	-80.00 °C	260.00 °C	0.15
Pt100 (385)	-200.00 °C	100.00 °C	0.15
	100.00 °C	300.00 °C	0.25
	300.00 °C	600.00 °C	0.35
	600.00 °C	800.00 °C	0.45
Pt100 (3926)	-200.00 °C	100.00 °C	0.15
	100.00 °C	300.00 °C	0.25
	300.00 °C	630.00 °C	0.35
Pt100 (3916)	-200.00 °C	100.00 °C	0.15
	100.00 °C	300.00 °C	0.25
	300.00 °C	630.00 °C	0.35
Pt200 (385)	-200.00 °C	100.00 °C	0.75
	100.00 °C	300.00 °C	0.85
	300.00 °C	630.00 °C	0.95
Pt500 (385)	-200.00 °C	100.00 °C	0.35
	100.00 °C	300.00 °C	0.45
	300.00 °C	630.00 °C	0.55
Pt1000 (385)	-200.00 °C	100.00 °C	0.15
	100.00 °C	300.00 °C	0.25
	300.00 °C	630.00 °C	0.35
CU10	-10.00 °C	250.00 °C	1.8

Notes: Read Accuracy is based on 4-wire input. For 3-wire input, add $\pm 0.05 \Omega$ assuming all three RTD leads are matched.

Source Accuracy is based on 0.5 to 3.0 mA excitation current (0.1 mA for pt1000 range)

Resolution: 0.1 °C, 0.1 °F

Allowable excitation current (source): Ni120, Pt100-385, Pt100-392, Pt100-JIS, Pt200-385: .05 to .80 mA, Pt500-385: 0.05 to 0.80 mA; Pt1000-385: 0.05 to 0.40 mA

RTD Source: Addresses pulsed transmitters and PLCs with pulses as short as 5 ms. SN < 7624001 may need modification for pulses less than 15 ms.

Loop Power Supply

Voltage: 24 V

Maximum current: 22 mA

Short circuit protected

Pressure Measurement (725 and 726)

Range	Resolution	Accuracy	Units	Mode (726 Only)
Determined by pressure module	4 digits	Determined by pressure module	psi, inH ₂ O@4 °C, inH ₂ O@20 °C, kPa, cmH ₂ O@4 °C, cmH ₂ O@20 °C, bar, mbar, kg/cm ² , mmHg, inHg	Pushing  for 3 seconds stores present pressure value as an offset and subtracts it from the displayed value.

Pulse Read and Pulse Source (726)

Pulse	Min	Max	Accuracy	Frequency
Source	1	10,000	1 Count	2 CPM to 10 kHz
Read		100,000		

Pressure Units Availability (725)

Unit	Availability
psi	Available on all pressure ranges
inH ₂ O	All ranges through 3000 psi
cmH ₂ O	All ranges through 1000 psi
bar	15 psi and above
mbar	All ranges through 1000 psi
kPa	Available on all pressure ranges
inHg	Available on all pressure ranges
mmHg	All ranges through 1000 psi
kg/cm ²	15 psi and above

General Specifications

Operating temperature 724 and 725 726	-10 °C to 55 °C -10 °C to 50 °C
Storage temperature	- 20 °C to 70 °C (limited by battery storage specifications)
Stability	± 0.005 % of range/°C outside of 23 ± 5 °C
Operating altitude	3000 meters above mean sea level
Relative Humidity (% RH operating without condensation)	90 % (10 to 30 °C) 75 % (30 to 40 °C) 45 % (40 to 50 °C) 35 % (50 to 55 °C) uncontrolled < 10 °C
Vibration	Random, 2 g, 5 Hz to 500 Hz
Safety and EMC	IEC 61010-1, IEC 61010-2-030, Pollution Degree 2 IEC 61326-1 (Portable), CISPR 11 (Class A)
Power requirements	4 AA alkaline batteries
Protection Class	Pollution Degree II
Electromagnetic Compatibility	Applies to use in Korea only. Class A Equipment (Industrial Broadcasting & Communication Equipment ^[1] ^[1] This product meets requirements for industrial (Class A) electromagnetic wave equipment and the seller or user should take notice of it. This equipment is intended for use in business environments and is not to be used in homes.
Size	96 x 200 x 47 mm (3.75 x 7.9 x 1.86 in)
Weight	650 g (1 lb, 7 oz)

Cleaning the Calibrator



Warning

To avoid electric shock or damage to the Calibrator, never allow water inside the Calibrator's case.

If the Calibrator requires cleaning, wipe it down with a cloth that is lightly dampened with water or a mild detergent.

Do not use aromatic hydrocarbons, chlorinated solvents, or methanol-based fluids when cleaning the Calibrator. To avoid damaging the case, never apply solvents to the Calibrator.

Replacing the Batteries

Warning

To avoid electric shock, remove the test leads from the Calibrator before opening the battery door. Close and latch the battery door before using the Calibrator.

To avoid false readings, which can lead to possible electric shock or personal injury, replace the batteries as soon as the low battery indicator () appears.

When replacing the batteries, always use four new AA batteries. Never mix new and used batteries in the Calibrator.

Note

Fuses are only in 724 and 725 Version 2.X and lower.

Four AA alkaline batteries (ANSI/NEDA 15A or IEC LR6) are used to power the Calibrator. To replace the batteries, refer to Figure 1 and do the following:

1. Turn the Calibrator off, remove the test leads from the terminals, and hold the Calibrator face down.
2. Using a flat-blade screwdriver, turn the battery door screws 1/4-turn counterclockwise and remove the battery door.
3. Remove the batteries, then install new batteries. Be sure to follow the polarity markings shown in the battery compartment.
4. Replace the battery door and secure it by turning the screws 1/4-turn clockwise.

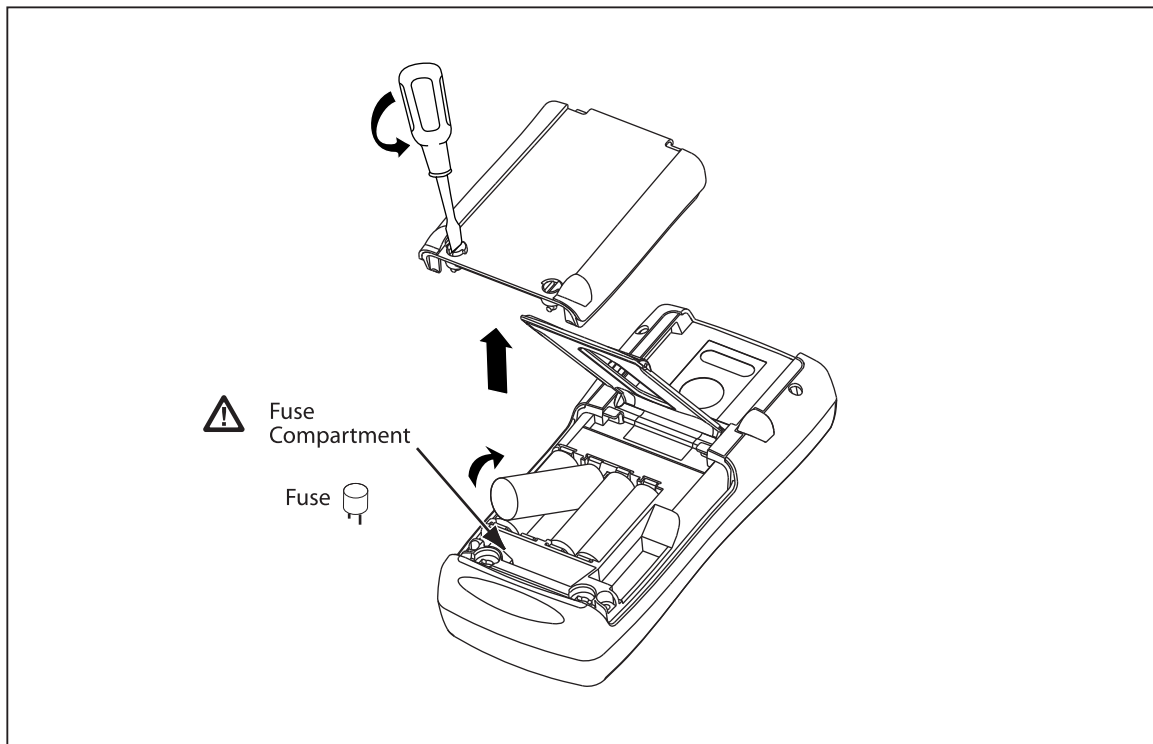

Figure 1. Replacing the Batteries and Replaceable Fuses

aal01f.eps

Fuses



To avoid electrical shock:

- **Remove the test leads from the calibrator before opening the battery door. Close and latch the battery door before using the calibrator.**
- **Use only the specified replacement fuses listed under “Replaceable Parts”.**
- **Do not allow water into the case.**

Note

724 and 725 Version 2.x and lower.

Over time, the input protection has been modified to increase reliability. There will either be self-resetting fuses, or replaceable fuses in sockets. The self-resetting fuses open when heated by a current overload, and close when they cool down. When an input's fuse is open, the input's functions will not work.

The time required for a self-resetting fuse to reset depends on the magnitude of the overload. If a self-resetting fuse does not reset, return the Calibrator to an authorized service center for repair.

If a replaceable fuse has been damaged, it needs to be replaced. The fuses can be removed and checked for resistance. A value of $< 10 \Omega$ is good.

The calibrator comes equipped with three 0.2 A 250 V socketed fuses.

- Problems while measuring with the right jacks indicate that F3 may have opened.
- Problems while measuring or sourcing with the center jacks or the TC jacks indicate that F2 may have opened.
- If you can't measure or source current with the left jacks, F4 may have opened.

To access the fuses, refer to instructions under “Replacing the Batteries”. The fuse compartment is located below the battery compartment. Use needle-nosed pliers to remove them and test them with a multimeter. Replace the fuse with the proper replacement fuse and follow the directions for reassembling the Calibrator. Refer to Figure 1.

Remote Control Interface (725 and 726)

The Calibrator's serial interface and remote control commands let you use a PC to remotely select Calibrator functions and read the Calibrator's display. This remote interface is especially useful if you want to write your own calibration software.

The 726 and 725 with V3.0 and higher firmware remote control interface is always active.

To activate the 725 with firmware V2.xx or lower remote control interface, proceed as follows:

1. Turn off the UUT; then use the Fluke 700SC serial interface cable to connect the UUT to a serial port on the PC. Push and hold 0% when the unit is turned on to find the firmware version of a 72x. Continue to hold during the 30 V warning for about 5 seconds. Then the firmware version is shown in the right-hand section of the display. If the unit does not show the 30 V warning or a firmware version, it is an early V1.xx firmware.
2. Start the terminal communication software on the PC. Create a new connection with the following properties:
 - Bits per second: 9600
 - Data bits: 8
 - Parity: None
 - Stop bits: 1
 - Flow control: None
 - Local echo on
3. Hold down the Calibrator's  button while turning the Calibrator on.
4. Use the commands given in Tables 2 through 4 to remotely control the Calibrator.

Table 2. Upper Display Remote Commands (725 with V2.xx and lower)

Remote Command	Description
i	mA measurement
L	mA Loop Power
E	Voltage measurement
B	Single broadcast of the most recent upper display value and units
(Single broadcast of most recent upper display value without header or units

Table 3. Lower Display Remote Commands (725)

Remote Command	Description
A	mA measurement
a	mA source
I	mA 2W Sim
V	Voltage measurement
v	Voltage source
M	mV measurement
m	mV source
K	kHz measurement
k	kHz source
H	Hz measurement
h	Hz source
P	CPM measurement
p	CPM source
O	Ohms measurement (default 2W)
o	Select Ohms source
W	2-wire measurement (Ohms and RTDs)
X	3-wire measurement (Ohms and RTDs)
Y	4-wire measurement (Ohms and RTDs)
T	Thermocouple measurement (default Type J). Use "S" command to select a sensor type.
t	Thermocouple source (default Type J). Use "S" command to select a sensor type
C	Selects Centigrade (T/C-RTD)
F	Selects Fahrenheit (T/C-RTD)
R	RTD measurement mode (default Pt100 385). Use "S" command to select a sensor type
r	RTD measurement mode (default Pt100 385). Use "S" command to select sensor type.
u	Increment display source value
d	Decrement display source value
<	The < arrow key PC keyboard selects left arrow on 725
>	The > arrow key PC keyboard selects right arrow on 725
0-9 -. <CR>	Enter a source value using ASCII characters 0,1,2,...9,-,.terminated by <CR> (carriage return) The 725 can receive a maximum of 10 characters prior to the carriage return.
b	Single Broadcast of most recent lower display value and units
)	Single broadcast of most recent lower display value without header or units.

Table 4. Remote Commands for Sensor Selection (725 with V2.xx and lower)

Serial Input	Selection Entry		RTD Type
	No.	Thermocouple Type	
S	1	J	Pt100 (3926)
	2	K	Pt100 (385)
	3	T	Pt100 (3916)
	4	E	Pt200 (385)
	5	R	Pt500 (385)
	6	S	Pt1000 (385)
	7	B	Ni120
	8	L	-
	9	U	-
	A	N	-
	B	mV	-

Serial Command List (726)

Table 5 lists the serial commands for the 726 and 725 Calibrator with V3.00 and higher firmware. Refer to “Remote Control Interface (725 and 726)” for activation steps.

Table 5. Serial Command List-726 and 725 V3.00 and Later

Command	Response/Actions	Command Arguments	Comment	Ch 1	Ch 2
*IDN?	Returns the ID string “FLUKE,726,0,{sw_rev}” where sw_revision is the firmware revision		Verify model number and firmware revision	X	X
FUNC?	Returns {Upper},{Lower} {Upper} responses (Channel 1) DCI, DCI_LOOP, DCV, DCI_ERROR, DCI_ERROR_LOOP {Lower} responses DCI, DCMV, DCV, DCI_SIM, TC, RTD, FREQUENCY, PULSE_TRAIN		Answers with the configured function for the upper and lower display	X	X
VAL?	Returns the measured value with base units for the upper and lower display {upper_val},{upper_units},{lower_ val},{lower_units}, upper_units: V, A, PERCENT lower_units: V, CEL, FAR, A, OHM, CPM, HZ, COUNT			X	X
UPPER_MEAS		1 argument, valid settings: DCI, DCI_LOOP, DCV, DCI_ERROR, DCI_ERROR_LOOP	Set upper channel measure mode	X	

Table 5. Serial Command List-726 and 725 V3.00 and Later (cont.)

Command	Response/Actions	Command Arguments	Comment	Ch 1	Ch 2
OUT		Arguments: {value} {units} Multipliers: u for micro, m for milli, and k for kilo are accepted. Units: -V used for mV and Volts, the V_range command can be used to switch ranges -CEL used for RTD, TC AND TC mV -FAR used for RTD and TC -A used for mA (see SIM for mA SIM) -OHM used for RTD ohms, RTD_TYPE must be set to ohms -CPM used for frequency -HZ used for HZ and KHZ frequency (unit will auto range) -COUNT used for pulse	Configures the output source function. If the {value} and {units} are valid, this command will change modes if necessary and set the output value to {value} and {units} in that mode.		X
OUT?	Returns the output (source) value with units or none.		Verify the output function and units		X
FREQ_UNIT		1 argument: CPM, HZ or KHZ	Set the output frequency range		X
FREQ_UNIT?	Returns CPM, HZ, KHZ		Verify the frequency range		X

Table 5. Serial Command List-726 and 725 V3.00 and Later (cont.)

Command	Response/Actions	Command Arguments	Comment	Ch 1	Ch 2
LOWER_MEAS		1 argument, Valid Modes: DCI, DCMV, DCV, TC, RTD, FREQUENCY, PULSE_TRAIN	Configures the measurement function. Sets the specified measure mode		X
SIM		1 Argument {value} Multipliers u for micro, m for milli, and k for kilo are accepted. A is for amps	If the value is valid, this command will change modes if necessary and set the output value to {value} in that mode.		X
SIM?	Returns the simulate value in Amps with units or none		Verify the SIM output		X
V_RANGE		1 Argument VOLTS or MVOLTS	Sets the voltage range		X
V_RANGE?	Returns the voltage range VOLTS or MVOLTS		Verify the voltage range		X
PULSE_FREQ		2 arguments {number}{units}. (units CPM ,Hz ,Khz)	Sets the pulse output frequency and range		X
PULSE_FREQ?	Returns the pulse output frequency with units.		Verify the pulse frequency		X
FREQ_LEVEL		1 Argument, valid values: 1-20V	Sets the pulse output and frequency output voltage		X
FREQ_LEVEL?	Returns the pulse output and frequency output voltage 1-20V		Verify the frequency voltage level		X
TRIG (726 only)	Toggles the pulse mode and totalize trigger for read and source.		Initialize totalized pulse measurement or output		X
TRIG? (726 only)	Returns the state of the pulse mode trigger, TRIGGERED, UNTRIGGERED or NONE.		Verify TRIG state		X

Table 5. Serial Command List-726 and 725 V3.00 and Later (cont.)

Command	Response/Actions	Command Arguments	Comment	Ch 1	Ch 2
TC_TYPE		One argument, valid settings: B, C, E, J, K, L, N, R, S, T, U, BP, XK, MV	Set TC type		X
TC_TYPE?	Returns TC type B, C, E, J, K, L, N, R, S, T, U, BP, XK, MV		Verify TC type		X
TSENS_TYPE		1 argument TC or RTD	Sets the sensor type TC or RTD		X
TSENS_TYPE?	Returns the sensor type TC or RTD		Verify is set for RTD or TC		X
CJC_STATE		One argument ON or OFF	Thermocouple cold junction compensation		X
CJC_STATE?	Returns ON or OFF		Verify CJC state		X
RTD_TYPE		1 argument: NI120, PT392_100, PT385_100, PTJIS_100, PT385_200, PT385_500, PT385_1000, CU_10, CUST1, CUST2, CUST3, OHMS	Sets RTD type		X
RTD_TYPE?	Returns RTD type NI120, PT392_100, PT385_100, PTJIS_100, PT385_200, PT385_500, PT385_1000, CU_10, CUST1, CUST2, CUST3, OHMS		Verify the RTD type setting		X
CPRT_R0 (726 only)		2 arguments {number} OHM. Sets the custom CPRT R0.	RTD_TYPE must be either CUST1, CUST2 or CUST3		X
CPRT_R0? (726 only)	Returns CPRT R0 with units OHM.				X
CPRT_MIN_T (726 only)		2 arguments {number} CEL.			X
CPRT_MIN_T? (726 only)	Returns {number} CEL.				X
CPRT_MAX_T (726 only)		2 arguments {number} CEL.			X

Table 5. Serial Command List-726 and 725 V3.00 and Later (cont.)

Command	Response/Actions	Command Arguments	Comment	Ch 1	Ch 2
CPRT_MAX_T? (726 only)	Returns {number} CEL.				X
CPRT_COEFA (726 only)		1 argument. Sets the custom CPRT Coefficient A.			X
CPRT_COEFA? (726 only)	Returns the custom CPRT Coefficient A.				X
CPRT_COEFB (726 only)		1 argument. Sets the custom CPRT Coefficient B.			X
CPRT_COEFB? (726 only)	Returns the custom CPRT Coefficient B.				X
CPRT_COEFC (726 only)		1 argument. Sets the custom CPRT Coefficient C.			X
CPRT_COEFC? (726 only)	Returns the custom CPRT Coefficient C.				X
RTD_WIRE		1 argument, 2W, 3W or 4W. Sets RTD read wire.			X
RTD_WIRE?	Returns RTD read wire.		Verify connection setting		X
TEMP_UNIT		1 argument. Sets temperature units, CEL or FAR	CEL: Celsius FAR: Fahrenheit		X
TEMP_UNIT?	Returns temperature units, CEL or FAR				X
CUST1_ALIAS (726 only)		1 argument, sets screen name for CUST1 RTD.			X
CUST1_ALIAS? (726 only)	Returns screen name for CUST1 RTD		Verify RTD 1 alias		X
CUST2_ALIAS (726 only)		1 argument, sets screen name for CUST2 RTD.			X
CUST2_ALIAS? (726 only)	Returns screen name for CUST2 RTD.		Verify RTD 2 alias		X
CUST3_ALIAS1 (726 only)		1 argument, sets screen name for CUST3 RTD.			X

Table 5. Serial Command List-726 and 725 V3.00 and Later (cont.)

Command	Response/Actions	Command Arguments	Comment	Ch 1	Ch 2
CUST3_ALIAS? (726 only)	Returns screen name for CUST3 RTD.		Verify RTD 3 alias		X
HART_ON	Turns HART mode on.		Switches in 250 Ω resistor	X	X
HART_OFF	Turns HART mode off.		Switches out 250 Ω resistor	X	X
HART?	Returns state of hart mode, ON or OFF			X	X
*CLS	Clear the error queue			X	X
FAULT	Returns error code FILO			X	X
ERROR CODES:	NONNUMERIC_ENRTY (100) EBUFFER_OVERFLOW (101) INVALID_UNITS_CODE (102) ENTRY_OVER_RNG (103) ENTRY_UNDER_RNG (104) MISSING_PARM (105) INVALID_UNIT_PARM (106) INVALID_SENSOR_TYPE (108) UNKNOWN_COMMAND (110) BAD_PARM_VALUE (111) INPUT_BUFF_OVERFLOW (112) MSG_BUFF_OVERFLOW (113) OUTPUT_BUFF_OVERFLOW (114) OUTPUT_OVERLOAD (115)			X	X
CAL_START	Initiates a password protected calibration (726 password = 627, 725 password = 527)			X	X

Required Equipment

Equipment and software required to perform the procedures in this manual are identified in Table 6. If the recommended equipment model is not available, other equipment can be substituted if it meets the specifications indicated.



To avoid safety hazards and equipment damage during the calibration procedures, use the specified calibration equipment listed in Table 6. Using unspecified equipment can give unreliable results and pose safety hazards.

Table 6. Required Equipment and Software

Equipment	Minimum Specifications	Recommended Model
Multi-Product Calibrator	DC voltage: 0 V to 30 V Accuracy: $\pm 0.005\%$ DC current: 0 mA to 24 mA Accuracy: $\pm 0.005\%$ Temperature: Type-J thermocouple 90 day accuracy: $\pm 0.2\text{ }^{\circ}\text{C}$ Resistance accuracy: $\pm 0.006\%$ Frequency accuracy: $\pm 0.01\%$	Fluke Model 5520A Multi-Product Calibrator only— <i>no substitute</i>
MET/CAL [®] Metrology Software (see MET/CAL Installation and Upgrade Guide for minimum hardware requirements)	Version 6.0 or later	Contact Fluke for the latest version.
Digital Multimeter	DC voltage: 0 V to 24 V Accuracy: $\pm 0.0013\%$ DC voltage: 0 mA to 24 mA Accuracy: $\pm 0.005\%$	Fluke 8508A
Pressure Module (725 and 726)	In working condition; for establishing communication only	Fluke 700PXX Series
Test Leads	Two sets of stackable low thermal EMF banana test leads	2 red leads: Fluke PN 105809 2 black leads: Fluke PN 105806
Thermocouple Test Lead	2 Type-J male miniplugs with ~12" (30.5 cm) of 20-gauge Type-J thermocouple wire	Fluke Model 80CJ-M male miniplugs (package of two) 20-gauge Type-J thermocouple wire is available through an electronic supply outlet
Personal computer	Windows [®] 3.1 or later with terminal communication software	486 (or later) IBM-compatible
PC interface cable (725 and 726)	Fluke 700SC serial interface cable assembly (LEMO to DB-9 female)	Fluke PN 667425
Calibration cable	Fluke 724/725 Calibration Cable	Fluke PN 1556747
Standard Thermometer	0.1 % accuracy	

Performance Tests

Warning

Some of the performance tests involve the use of high voltages and should be performed by qualified personnel only.

To avoid electric shock, always set the calibration source (5520A) to Standby (STBY) mode between tests and before handling the test connections or test cables.

Performance tests confirm the complete operability of the Calibrator and check the accuracy of each function against the Calibrator's specifications.

Note

If the Calibrator fails any performance test, it needs calibration adjustments. If the Calibrator continues to fail after calibration adjustments, send it to an authorized Fluke Service Center for repair.

The Calibrator's performance and accuracy are specified for one year after calibration at operating temperatures of +18 °C to +28 °C (64 °F to 82 °F), in relative humidity to 90 %. The specifications assume the Calibrator has been warmed up for five minutes before use.

It is not necessary to open the case for the performance tests. No mechanical adjustments are necessary. Make the required connections, source the designated values, and determine if the reading on the Calibrator or the multimeter falls within the acceptable range indicated.

Preparing for the Performance Tests

Notes

Performance tests for the Calibrator can be performed manually, or they can be computer-automated (using Fluke Metrology Software). The Metrology Software automates all of the performance verification tasks, except for connection of the standards to the Calibrator. This document provides the procedures necessary for manual performance tests. Contact Fluke for information on Metrology Software.

These performance tests assume that the person performing them knows how to use the Calibrator and the required equipment.

Do not attempt to perform these tests unless you are qualified to do so.

Throughout the performance tests, "UUT" (unit under test) refers to the Calibrator; the word "multimeter" is reserved for the digital multimeter identified in the required equipment listed in Table 6.

Unless otherwise indicated, all connection diagrams for the verification tests in this manual showing a calibrator or digital multimeter use a Fluke 5520A Calibrator or Fluke 8508A DMM. If you are using a different DMM, make the connections appropriate for your instrument.

To prepare the UUT for the performance tests, do the following:

1. Make sure that you have the required equipment available, see Table 6.
2. Make sure the UUT has fresh batteries. See "Replacing the Batteries" earlier in this manual.
3. Warm up the multimeter as required by its specifications.
4. Remove all test leads from the front of the UUT.
5. Make sure that the UUT is in a stable ambient temperature between 18 °C and 28 °C (64.4 °F and 82.4 °F) and that it has been warmed up for five minutes.

Upper Display Voltage Measurement Tests

1. Press **RESET** on the 5520A.
2. Press $\boxed{\frac{V}{mA}}_{\text{LOOP}}$ on the UUT until **V** appears on the upper display.
3. Make the connections shown in Figure 2.
4. Set up the 5520A to output each of the voltages in Table 7 and verify that the UUT readings are within the limits shown.
5. Press **STBY** on the 5520A.

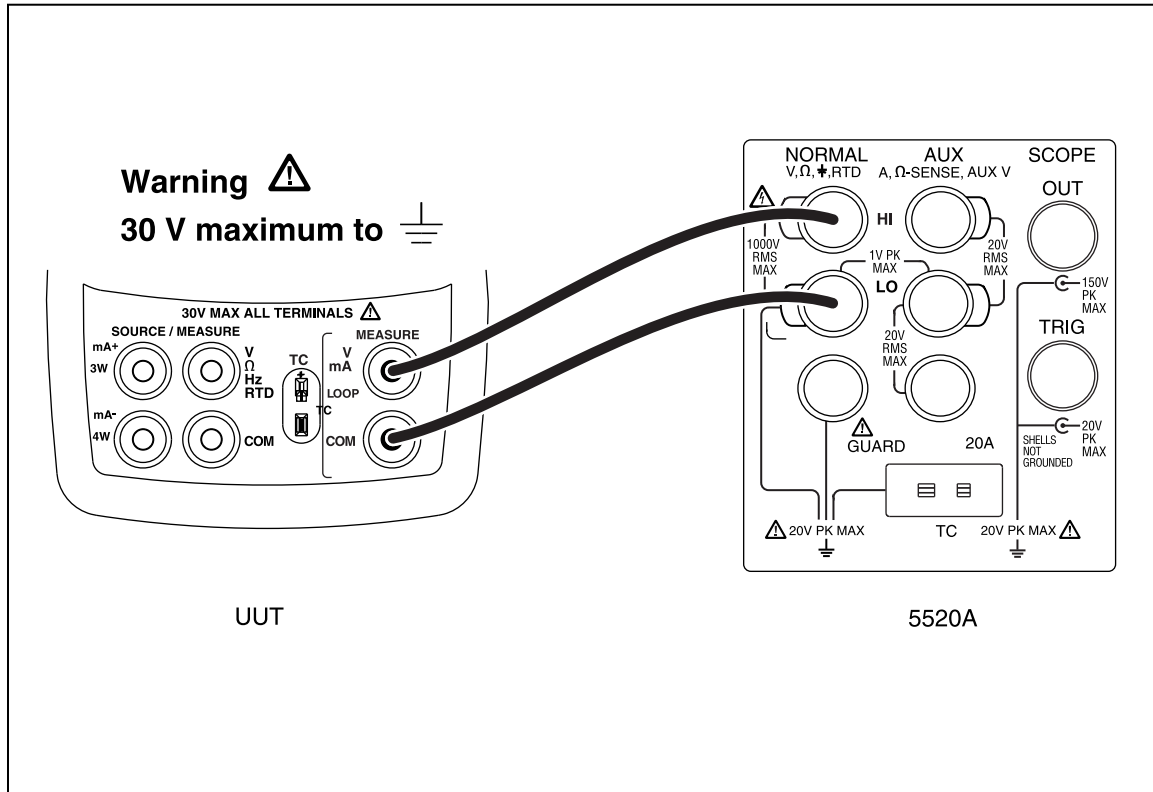

Figure 2. Upper Display Voltage Test Connections

aal03f.eps

Table 7. Upper Display Voltage Readings

5520A Outputs	724/725 UUT Readings	726 UUT Readings
0.000 V	-0.002 V to +0.002 V	-0.002 V to +0.002 V
15.000 V	14.995 V to 15.005 V	14.996 V to 15.004 V
30.000 V	29.992 V to 30.008 V	29.995 V to 30.005 V

Lower Display mV/TC Measurement Tests

1. Press **RESET** on the 5520A.
2. Press **V mA** on the UUT until **MEASURE** and **mV** appear on the lower display.
3. Make the connections shown in Figure 3.
4. Set up the 5520A to output each of the voltages in Table 8 and verify that the UUT readings are within the limits shown.
5. Press **STBY** on the 5520A.

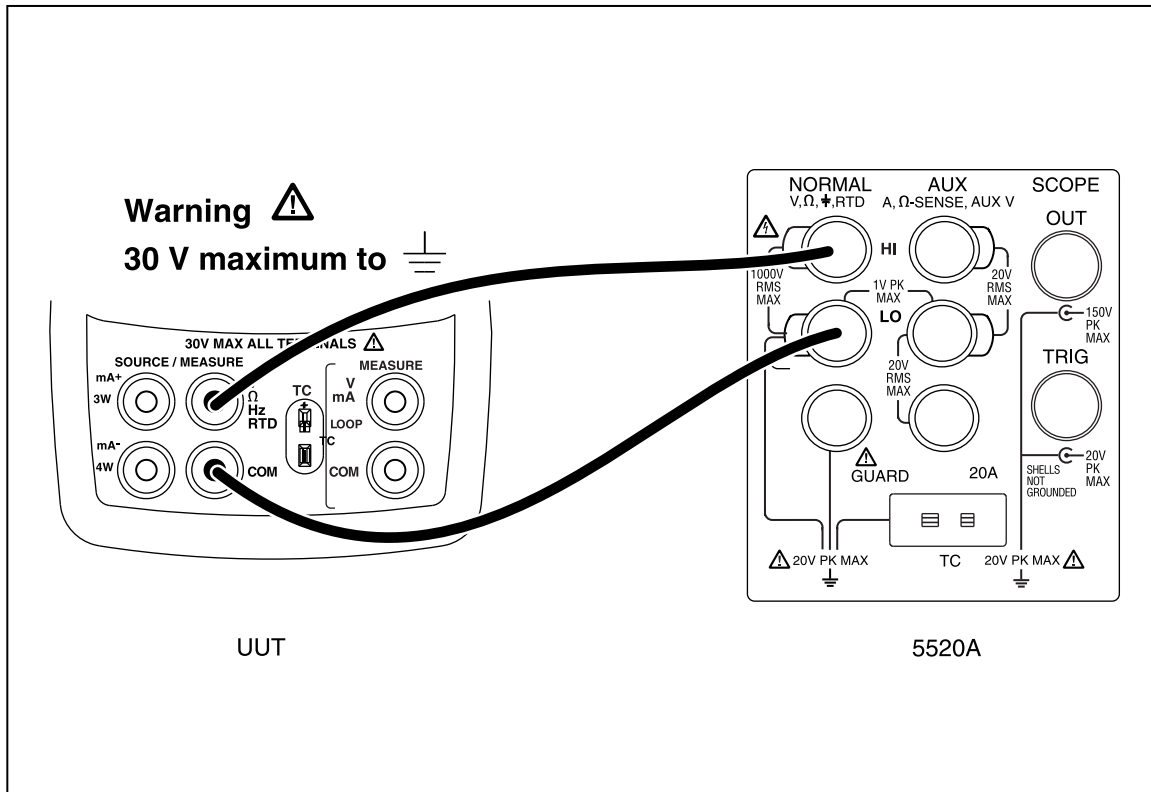

Figure 3. Lower Display mV and Voltage Test Connections

aal04f.eps

Table 8. Lower Display mV Readings

5520A Outputs	724/725 UUT Readings	726 UUT Readings
0.00 mV	-0.02 mV to +0.02 mV	-0.0100 mV to +0.010 mV
45.00 mV	44.97 mV to 45.03 mV	44.986 mV to 45.014 mV
89.00 mV	88.96 mV to 89.04 mV	88.981 mV to 89.019 mV

Lower Display Voltage Measurement Tests

1. Press **RESET** on the 5520A.
2. Press **V mA** on the UUT until **MEASURE** and **V** appear on the lower display.
3. Make the connections shown in Figure 3.
4. Set up the 5520A to output each of the voltages in Table 9 and verify that the UUT readings are within the limits shown.
5. Press **STBY** on the 5520A.

Table 9. Lower Display Voltage Readings

5520A Outputs	724/725 UTT Readings	726 UTT Readings
0.000 V	-0.002 V to +0.002 V	-0.002 V to +0.002 V
10.000 V	9.996 V to 10.004 V	9.997 V to 10.003 V
20.000 V	19.994 V to 20.006 V	19.996 V to 20.004 V

Upper Display mA Measurement Tests

1. Press **RESET** on the 5520A.
2. Press $\left[\begin{smallmatrix} V \\ \text{mA} \\ \text{LOOP} \end{smallmatrix} \right]$ on the UUT until **MEASURE** and **mA** appear on the upper display.
3. Make the connections shown in Figure 4.
4. Set up the 5520A to output each of the voltages in Table 10 and verify that the UUT readings are within the limits shown.
5. Press **STBY** on the 5520A.

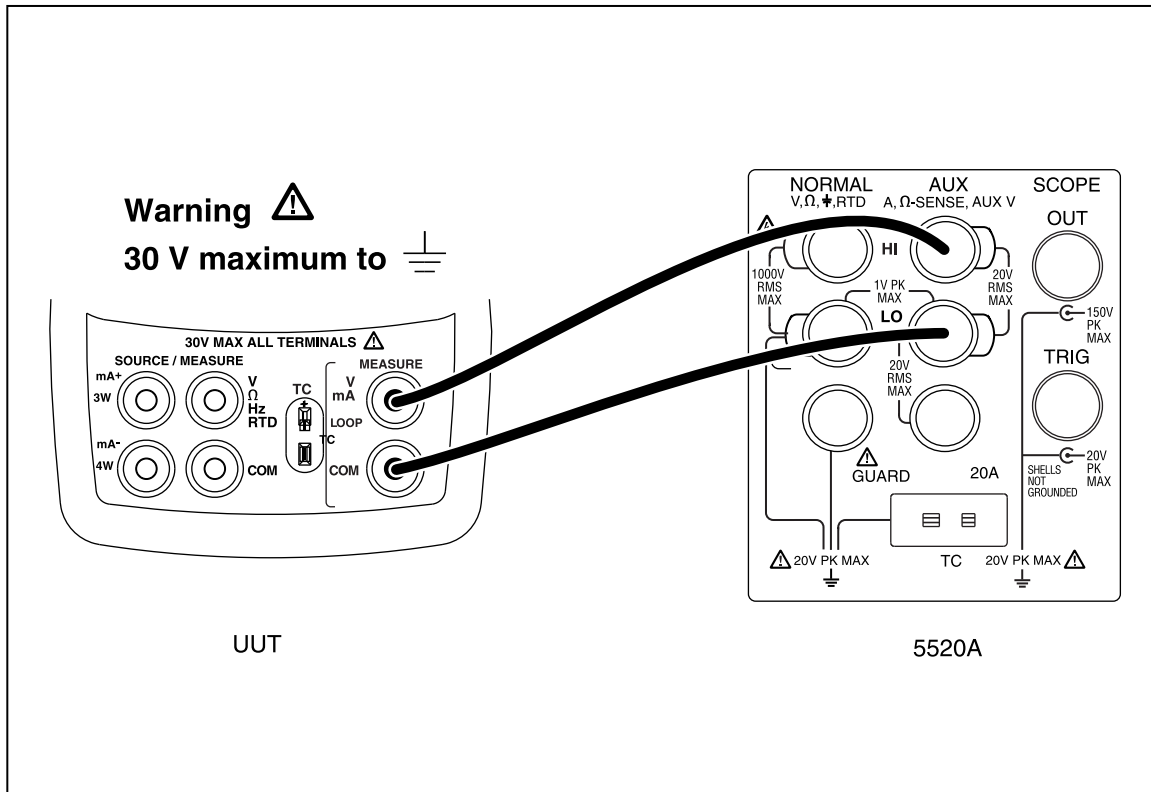

Figure 4. Upper Display mA Test Connections

aal05f.eps

Table 10. Upper Display mA Readings

5520A Settings	724/725 UUT Readings	726 UUT Readings
4.000 mA	3.997 mA to 4.003 mA	3.997 mA to 4.003 mA
12.000 mA	11.995 mA to 12.005 mA	11.997 mA to 12.003 mA
24.000 mA	23.993 mA to 24.007 mA	23.995 mA to 24.005 mA

Lower Display mA Measurement Tests (725 and 726)

1. Press **RESET** on the 5520A.
2. Press $\boxed{V_{mA}}_{\text{LOOP}}$ on the UUT until **MEASURE** and **mA** appear on the lower display.
3. Make the connections shown in Figure 5.
4. Set up the 5520A to output each of the voltages shown in Table 11 and verify that the UUT readings are within the limits shown.
5. Press **STBY** on the 5520A.

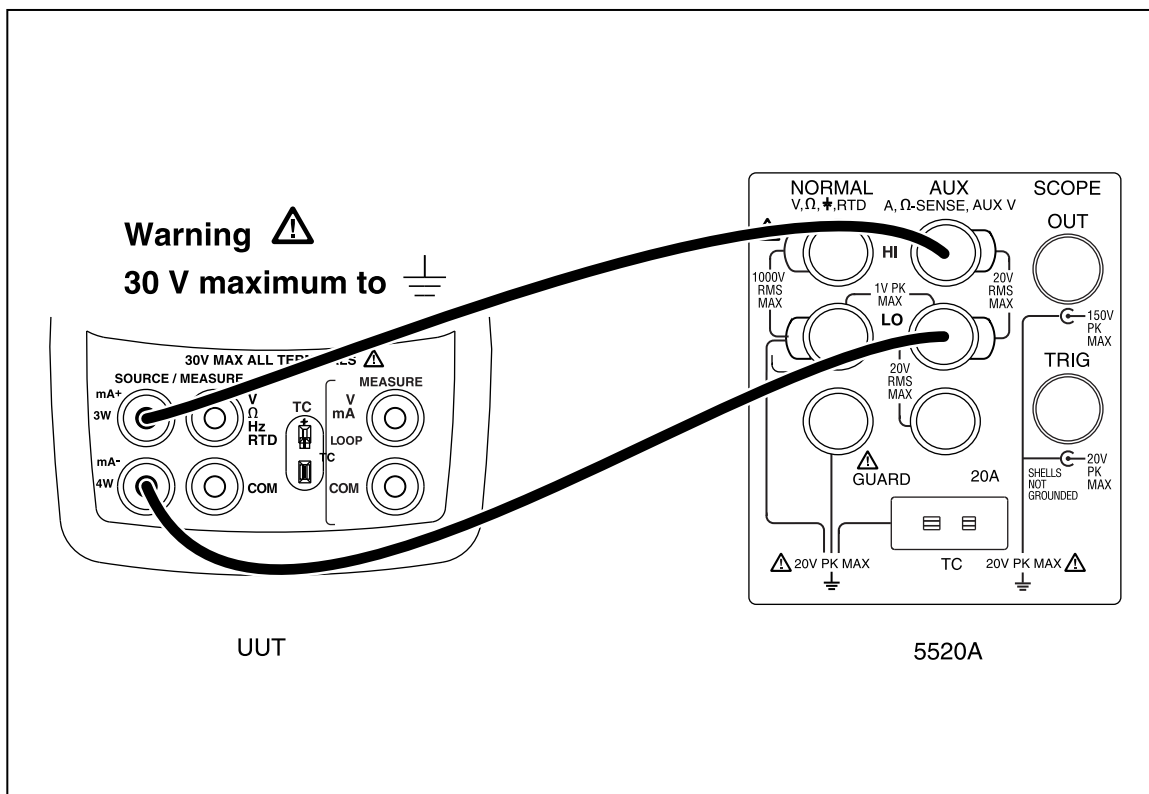

Figure 5. Lower Display mA Test Connections

aal06f.eps

Table 11. Lower Display mA Readings

5520A Outputs	724/725 UUT Readings	726 UUT Readings
4.000 mA	3.997 mA to 4.003 mA	3.997 mA to 4.003 mA
12.000 mA	11.995 mA to 12.005 mA	11.997 mA to 12.003 mA
24.000 mA	23.993 mA to 24.007 mA	23.995 mA to 24.005 mA

Lower Display Frequency Measurement Test (725 and 726)

1. Set the 5520A to source a 10 kHz, 1 V peak-to-peak square wave (use the blue softkey under the wave type to change the wave shape).
2. Press **Hz Ω** on the UUT (**FREQ** for 726) until **MEASURE** and **kHz** appear on the lower display.
3. Make the connections shown in Figure 6.
4. Verify that the UUT frequency reads between 9.98 kHz and 10.02 kHz.
5. Press **STBY** on the 5520A.

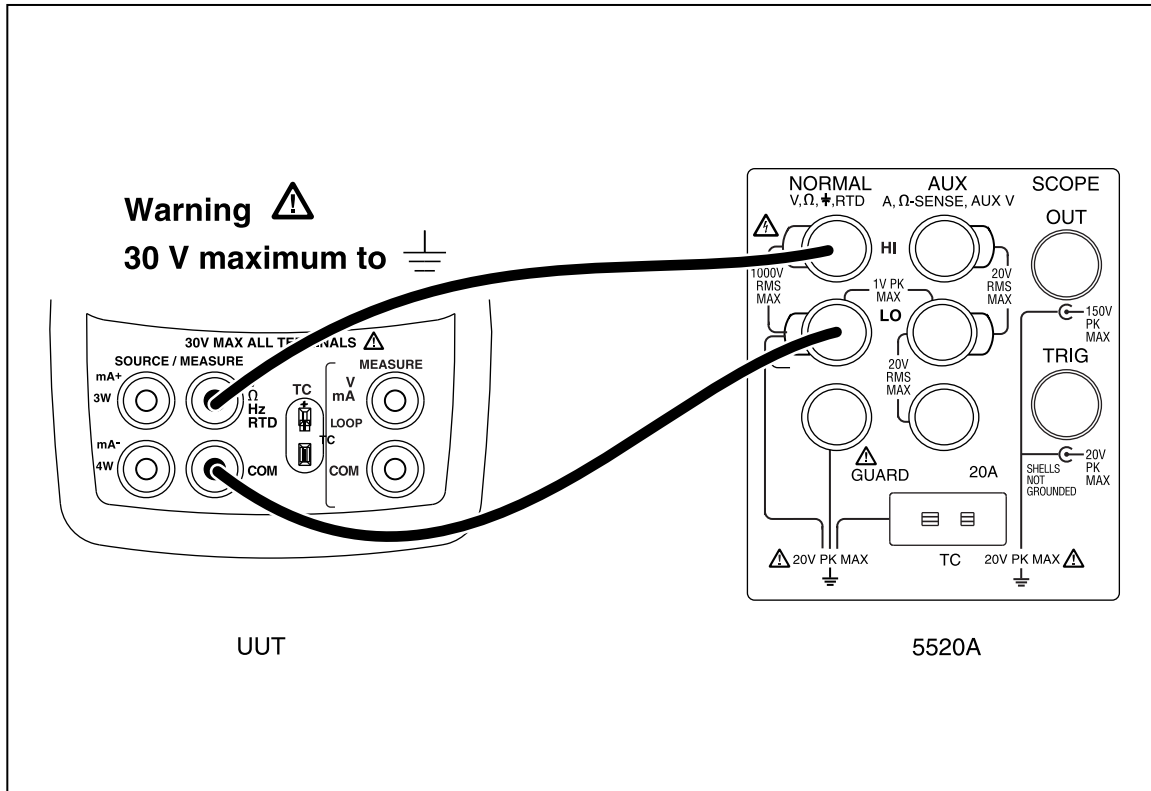





Figure 6. Lower Display Frequency Test Connections

aal04f.eps

Lower Display Frequency Source Test (725 and 726)

1. Press  on the UUT until **SOURCE** appears on the lower display.
2. Press  on the UUT ( for 726) until **Hz** appears on the lower display.
3. Configure the Fluke 8508A to measure frequency; then make the connections shown in Figure 7.
4. Use the arrow keys on the UUT to set the UUT output 10 kHz at 5 V and verify that the Fluke 8508A readings are within the limits 9.975 Hz to 10.025 kHz.
5. Press  on the UUT to disable the sourcing function.

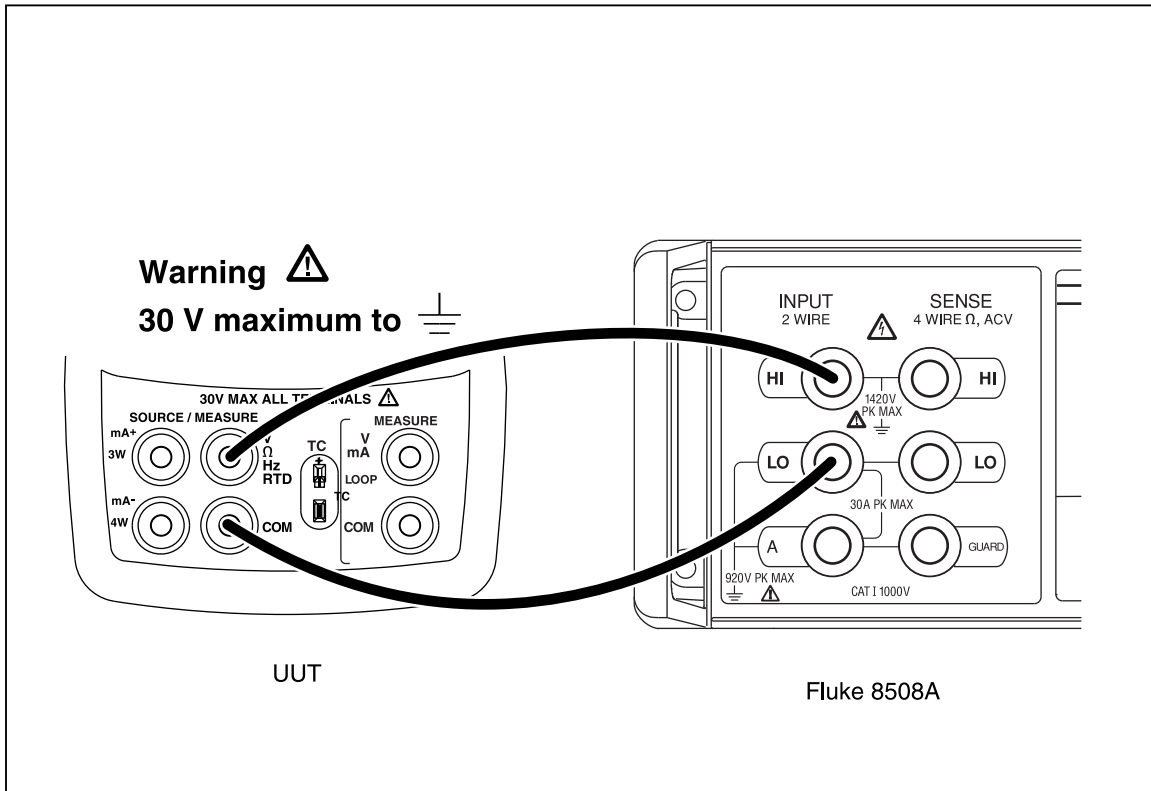

Figure 7. Lower Display Frequency Source Test Connections

aal08f.eps

Lower Display 4-Wire Resistance Measurement Tests

1. Press $\text{Hz } \Omega$ on the UUT (RTD) on 726) until Ω appears on the lower display. If necessary, use MEAS to get to the measure mode, and use MODE to get to the 4W mode. (**MEASURE** should also appear on the lower display).
2. Set the 5520A to 2-wire output with 2-wire compensation off; then make the connections shown in Figure 8.
3. Set the 5520A to source the resistance values in Table 12 and verify that the UUT resistance readings are within the limits shown.
4. Press **STBY** on the 5520A.

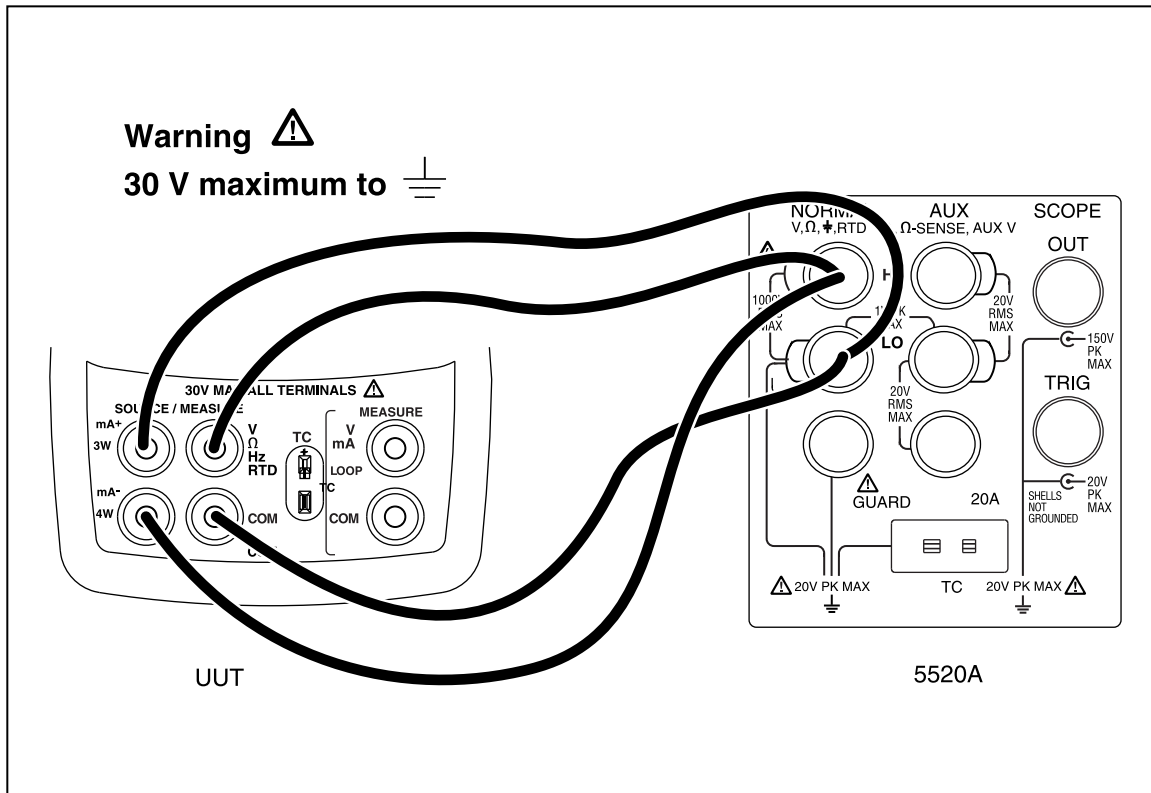

Figure 8. Lower Display 4-Wire Resistance Test Connections

Table 12. Lower Display 4-Wire Resistance Readings

5520A Outputs	724/725 UUT Readings	726 UUT Readings
15.00 Ω	14.90 Ω to 15.10 Ω	14.94 Ω to 15.06 Ω
350.00 Ω	349.90 Ω to 350.10 Ω	349.90 Ω to 350.10 Ω
500.00 Ω	499.5 Ω to 500.5 Ω	499.375 Ω to 500.625 Ω
1500.0 Ω	1499.5 Ω to 1500.5 Ω	1499.2 Ω to 1500.8 Ω
3200.0 Ω	3199.0 Ω to 3201.0 Ω	-
3800.0 Ω	-	3798.9 Ω to 3801.1 Ω

Lower Display 3-Wire RTD Measurement

1. Press Ω on the UUT (RTD on the 726) until Ω appears on the lower display. If necessary, use MEAS to select the measure mode, and use RTD on the 726) to get to the **3W** mode. (**MEASURE** should also appear on the lower display.)
2. Set the 5520A to 2-wire output with 2-wire compensation off; then make the connections shown in Figure 9.
3. Set the 5520A to source 350 Ω and verify that the UUT resistance readings are within the 349.80 to 350.2 Ω .
4. Press **STBY** on the 5520A.

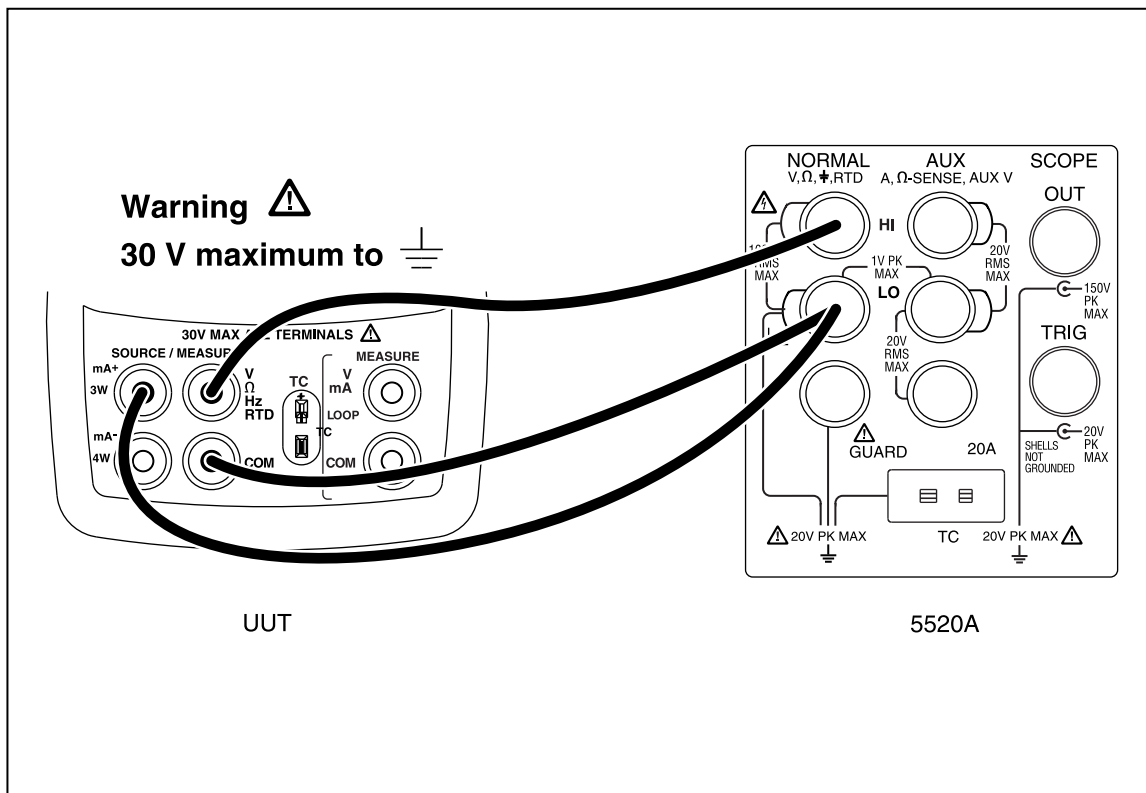

Figure 9. Lower Display 3-Wire Resistance Test Connections

aal10f.eps

Lower Display Thermocouple Measurement Tests

1. Remove the test leads from the UUT terminals; then connect a Type-J thermocouple lead between the TC jack on the UUT and the TC jack on the 5520A, as shown in Figure 10.
2. Press **TC** on the UUT until **J** appears on the lower display. If necessary, press **C F** (use the configuration menu on the 726) so the temperature is displayed in °C.
3. Set the 5520A to output the Type-J thermocouple voltages shown in Table 13 and verify the UUT temperature readings are within the limits shown (values use the ITS-90 curves).
4. Press **STBY** on the 5520A.

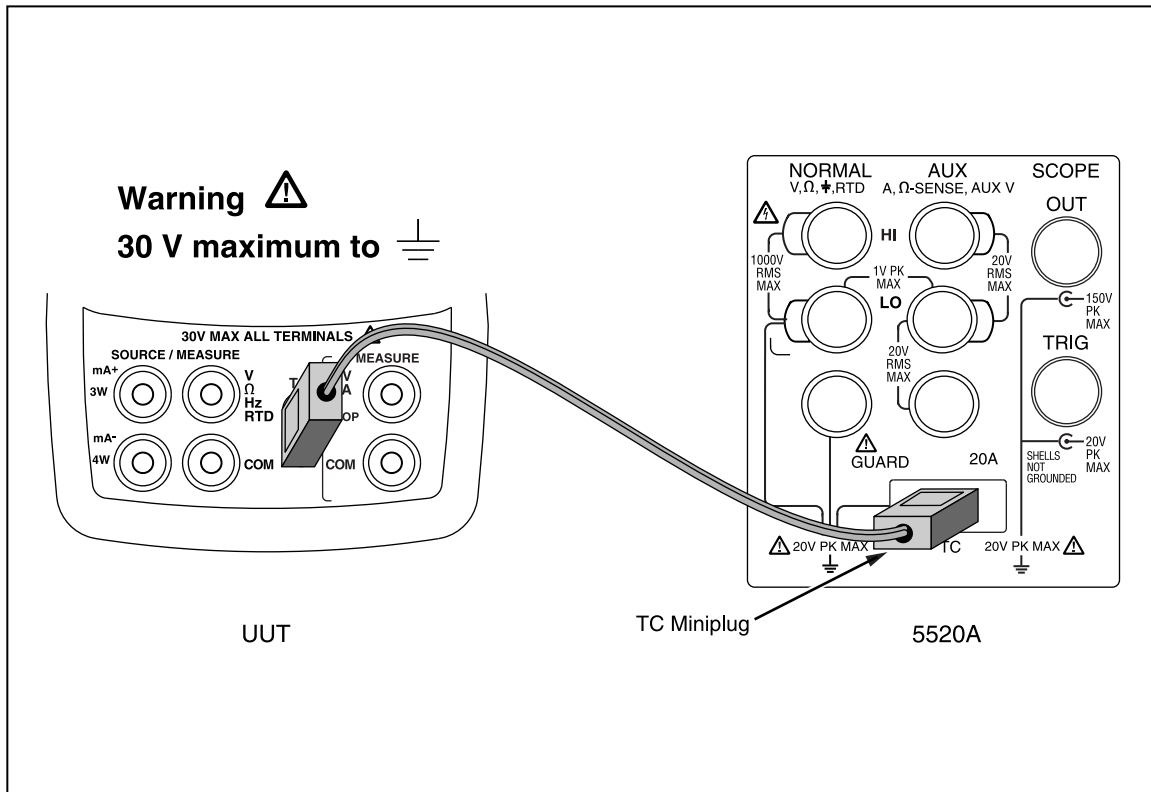

Figure 10. Lower Display Thermocouple Test Connections

aal11f.eps

Table 13. Type-J Thermocouple Readings

5520A Settings (referenced to 0 °C)	724/725 UUT Readings	726 UUT Readings (CJC On)
0.0 °C (0.000 mV)	-0.7 °C to +0.7 °C	-0.4 °C to +0.4 °C

Lower Display Thermocouple Source Test



1. Set the 5520A to measure Type-J thermocouple voltages.
2. Press  on the UUT until **SOURCE** appears on the lower display. If necessary, press  on the UUT until **J** appears on the lower display and press  (use the configuration menu on the 726) so the temperature is displayed in °C.
3. Use the arrow keys to set the UUT outputs to the temperatures in Table 14 and verify that the 5520A temperature readings are within the limits shown.
4. Press **STBY** on the 5520A. Remove the TC lead from the 5520A and the UUT.

Table 14. Lower Display Thermocouple Source Readings

UUT Settings	724/725 5520A Readings	726 Readings (referenced to 0 °C)
0.0 °C	-0.7 °C to +0.7 °C	-0.4 °C to +0.4 °C

Lower Display mA Source Tests (725 and 726)

1. Press **MEAS SOURCE** on the UUT until **SOURCE** appears on the lower display; then press **V mA** until **mA** appears on the lower display. If necessary, press **MEAS SOURCE** until **SOURCE** appears on the lower display.
2. Set the Fluke 8508A to measure dc current.
3. Connect the UUT and the Fluke 8508A as shown in Figure 11.
4. Use the arrow keys on the UUT to set the UUT to the currents in Table 15 and verify that the Fluke 8508A readings are within the limits shown.

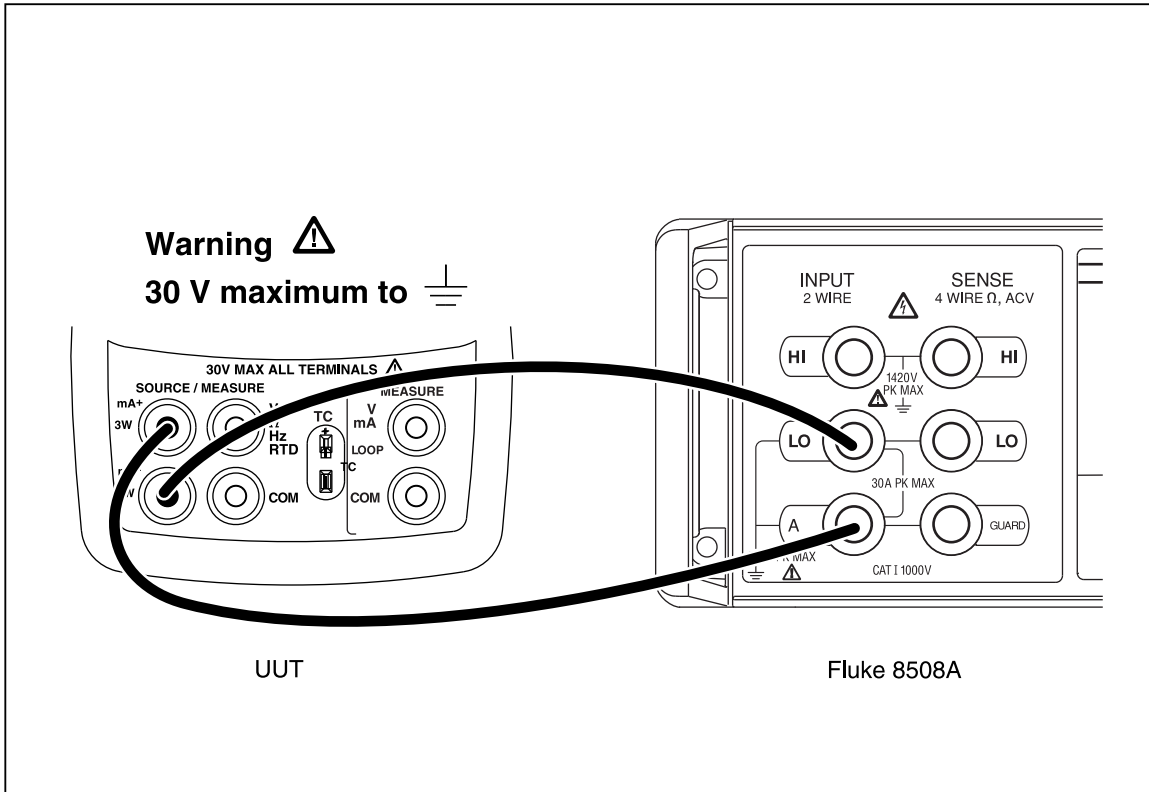

Figure 11. Lower Display mA Source Connections

aal12f.eps

Table 15. Lower Display mA Source Readings

UUT Outputs	724/725 Fluke 8508A Readings	726 Fluke 8508A Readings
4.000 mA	3.9972 mA to 4.0028 mA	3.9976 mA to 4.0024 mA
12.000 mA	11.9956 mA to 12.0044 mA	11.9968 mA to 12.0032 mA
24.000 mA	23.9932 mA to 24.0068 mA	23.9956 mA to 24.0044 mA

Lower Display mV Source Tests



1. Press  on the UUT until **SOURCE** appears on the lower display; then press  until **mV** appears on the lower display.
2. Set the Fluke 8508A to measure dc voltage in the 200 mV range.
3. Connect the UUT to the Fluke 8508A as shown in Figure 7.
4. Use the arrow keys on the UUT to set the UUT output to the current values in Table 16 and verify that the Fluke 8508A readings are within the limits shown.
5. Press  on the UUT to disable the sourcing function.

Table 16. Lower Display mV Source Readings

UUT Outputs	724/725 Fluke 8508A Readings	726 Fluke 8508A Readings
0.00 mV	-0.020 mV to +0.020 mV	-0.010 mV to +0.010 mV
45.00 mV	44.970 mV to 45.030 mV	44.986 mV to 45.014 mV
100.00 mV	99.960 mV to 100.040 mV	99.980 mV to 100.020 mV

Lower Display Voltage Source Tests



1. Press  on the UUT until **SOURCE** appears on the lower display; then press  until **V** appears on the lower display.
2. Set the Fluke 8508A to measure dc voltage in the 20 V range.
3. Connect the UUT to the Fluke 8508A as shown in Figure 7.
4. Use the arrow keys on the UUT to set the UUT outputs to the currents in Table 17 and verify that the Fluke 8508A readings are within the limits shown. You can use a lower voltage range on the Fluke 8508A to verify the 0 V range.

Table 17. Lower Display Voltage Source Readings

UUT Outputs	724/725 Fluke 8508A Readings	726 Fluke 8508A Readings
0.000 V	-0.002 V to +0.002 V	-0.002 V to +0.002 V
5.000 V	4.9970 V to 5.0030 V	-
10.000 V	9.9960 V to 10.0040 V	9.997 V to 10.003 V
19.000 V	-	18.9961 V to 19.0039 V

Lower Display Ohms Source Tests

1. Press $\text{Hz } \Omega$ (RTD on the 726) on the UUT until Ω appears on the lower display. If necessary, press MEAS until **SOURCE** appears on the lower display.
2. Set the Fluke 8508A to measure 4-wire resistance.
3. Set the Fluke 8508A to 2 k range with LOI off for 72x resistance < 400 Ω , to 20 k Ω with LOI off range for 400 Ω or more.
4. Make the connections shown in Figure 12.
5. Use the arrow keys on the UUT to set the UUT output to the resistance values in Table 18 and verify that the Fluke 8508A readings are within the limits shown.

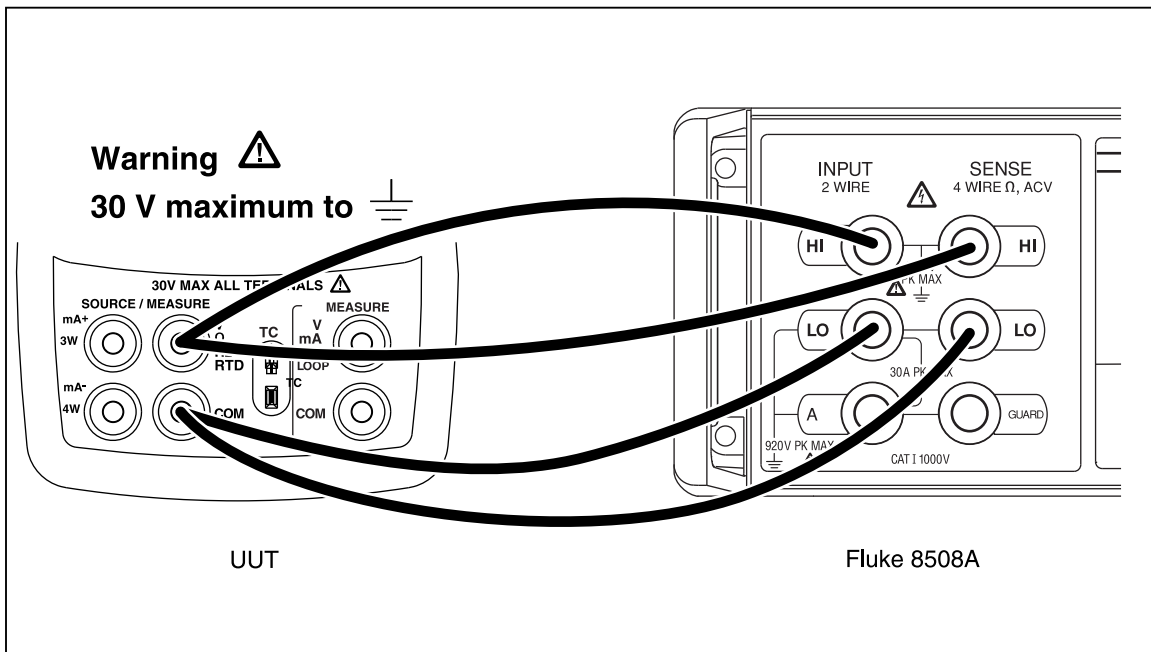

Figure 12. Lower Display Ohms Source Test Connections

aal13f.eps

Table 18. Lower Display Ohms Source Readings

UUT Settings	724/725 Fluke 8508A Readings	726 Fluke 8508A Readings	Range
15.0 Ω	14.9 Ω to 15.1 Ω	14.94775 Ω to 15.05225 Ω	2 k Ω
360.0 Ω	359.9 Ω to 360.1 Ω	359.896 Ω to 360.104 Ω	2 k Ω
500 Ω	499.5 Ω to 500.5 Ω	499.375 Ω to 500.625 Ω	20 k Ω
1500 Ω	1499.5 Ω to 1500.5 Ω	1499.275 Ω to 1500.725 Ω	20 k Ω
3200 Ω	3199.0 Ω to 3201.0 Ω	-	20 k Ω
3800 Ω	-	3798.93 Ω to 3801.07 Ω	20 k Ω

The performance tests for the 724 are now complete. Disconnect and secure all test equipment.

Pressure Module Input (725/726)

1. Connect a Fluke 700 Series Pressure Module to the 5-pin LEMO connector at the top of the UUT; then press .
2. Verify that the display first shows -----psi, then changes to a pressure value.
3. Disconnect the pressure module from the UUT.

The performance tests for the 725 and 726 are now complete. Disconnect and secure all test equipment.

Calibration Adjustment

The Calibrators have electronic calibration. There are no mechanical adjustments and the calibration is done case closed. The calibration is done via serial communications port, by sending and receiving commands and readings. For the 725 and 726 serial port connection, you may use the 700SC Serial Interface Cable, PN 667425. This will permit communication through the pressure port connection. The 724/725 Calibration Cable, PN 1556747 is required for the 724, and can be used with the 725 and 726.. This connects to the 10-pin header in the battery compartment.

Throughout these procedures, the Calibrators are referred to as “UUT” (Unit Under Test). Two methods of calibration are available for the UUT: using a serial-based program via a PC (see Table 6 for requirements), and using a Met/Cal calibration procedure. This manual only describes the serial-based PC program. The automated Met/Cal procedures are available from the Fluke Metrology Group. For more information on the automated Met/Cal procedures contact Fluke or visit the Fluke Web site at www.fluke.com.

As long as the calibrators have been within at a stable temperature within the range of 18 °C to 28 °C for an hour or more, they only need 5 minutes to warm up. If temperature conditions were previously below 10 °C or higher than 40 °C, then the Calibrator must be allowed to stabilize for a minimum of 3 hours prior to calibration.

The Calibrators should be calibrated at the required interval (defined by the factory as 1 year).

Setup

Setup the PC and UUT as follows:

1. Ensure that the terminal communications software is installed on the PC (such as Hyper Terminal or PcPlus).
2. Connect the interface cable to the appropriate connector on the UUT. Remove the jumper beside the ten-pin connector when using the 724/725 Calibration Cable on a 725. Replace the jumper after calibration is complete.
3. Connect the 9-pin 'D' connector to the PC serial port. An adapter may be needed for PCs that use 25-pin 'D' serial connectors.
4. Verify the settings on the PC are as follows:
 - Bits per second: 9600
 - Data bits: 8
 - Parity: None
 - Stop bits: 1
 - Flow control: None
 - Local echo on

To begin calibration, or to select a particular calibration step, type the cal step (letter or number), then press Enter on the PC keyboard. It is not necessary to run all of the calibration steps when in the calibration mode. However, for the 726, certain dependencies exist in that certain functions must be calibrated before others can be calibrated. These dependencies are related to calibration only.

You must first calibrate mV Input and mV Output before calibrating thermocouples for the 724, 725, and 726. At the end of each step on the calibration menu, the new calibration constants for that step are saved, but not actually used until power is recycled.

When calibrating a measurement function, you must enter an input signal. For the 724 and 725, when the signal is connected and stable, press the space bar to start the adjustment. For the 726, press the Enter key. Usually, the UUT will display a calibration constant, then prompt for a second input value. Apply the new input value, then press the space bar or Enter key depending on the Calibrator. After the adjustment is complete, press the proper key to return to the Calibration Menu.

When calibrating a source function, you must enter the value of a reading. Type in the numerical value of the calibration desired. This will put the UUT into the desired calibration mode. When entering the calibration data for any source mode calibration, be sure to enter the value in the units listed, but don't enter the units (mV, mA, etc.). After the adjustment is complete, press the proper key to return to Calibration Menu. The calibration values will vary slightly, unit to unit. The constants used in this procedure may not appear exactly the same as on your UUT, but they should be approximately the same.

Later 724 and 725 have the same adjustment instructions as the 726. For 724 or 725 with V3.00 or later firmware, go to the instructions later in the manual for the adjustment of the 724-726

To find the firmware of a 72x, push and hold 0% when the unit is turned on. Continue to hold during the 30 V warning, about 5 seconds. The firmware version will then be shown in the right-hand section of the display. If the unit does not show the 30 V warning, or a firmware version, it is an early V1.xx firmware.

Initiating Communication (724 and 725 with V2.xx and Lower Firmware)

Starting with the UUT off, push and hold **RECALL** while turning the UUT on. Continue to hold **RECALL** until "Cal mode" is displayed. "Enter Password:" appears on the display of all Calibrators that have firmware version V1.91 or higher. A password has been added to prevent users from accidentally changing the calibration of the Calibrator. The password for all 724 Calibrators is 427. The password for all 725 Calibrators is 527.

The calibration menus, as seen on the PC screen, are as follows:

725 Calibration Menu

Calibrate Menu

- 1 - Cal Volts Input
- 2 - Cal Volts Output
- 3 - Cal mA Input
- 4 - Cal mA Output
- 5 - Cal mV Input
- 6 - Cal mV Output
- 7 - Cal Thermocouples
- 8 - Cal Ohms Hi Source
- 9 - Cal Ohms Low Source
- A - Cal RTD LOW Range
- B - Cal RTD HI Range
- C - Cal ISO Volts
- D - Cal ISO mA

Enter Selection :

724 Calibration Menu

Calibrate Menu

- 1 - Cal Volts Input
- 2 - Cal Volts Output
- 3 - Cal mV Input
- 4 - Cal mV Output
- 5 - Cal Thermocouples
- 6 - Cal Ohms Hi Source
- 7 - Cal Ohms Low Source
- 8 - Cal RTD LOW Range
- 9 - Cal RTD HI Range
- A - Cal ISO Volts
- B - Cal ISO mA

Enter Selection :

Calibration Adjustment Procedures (724 and 725 with V2.xx and Lower Firmware)

The following sections detail the calibration procedures for the earlier 724 and 725 with V2.xx and lower firmware.

Cal Volts Input

Connect the UUT as shown in Figure 13.

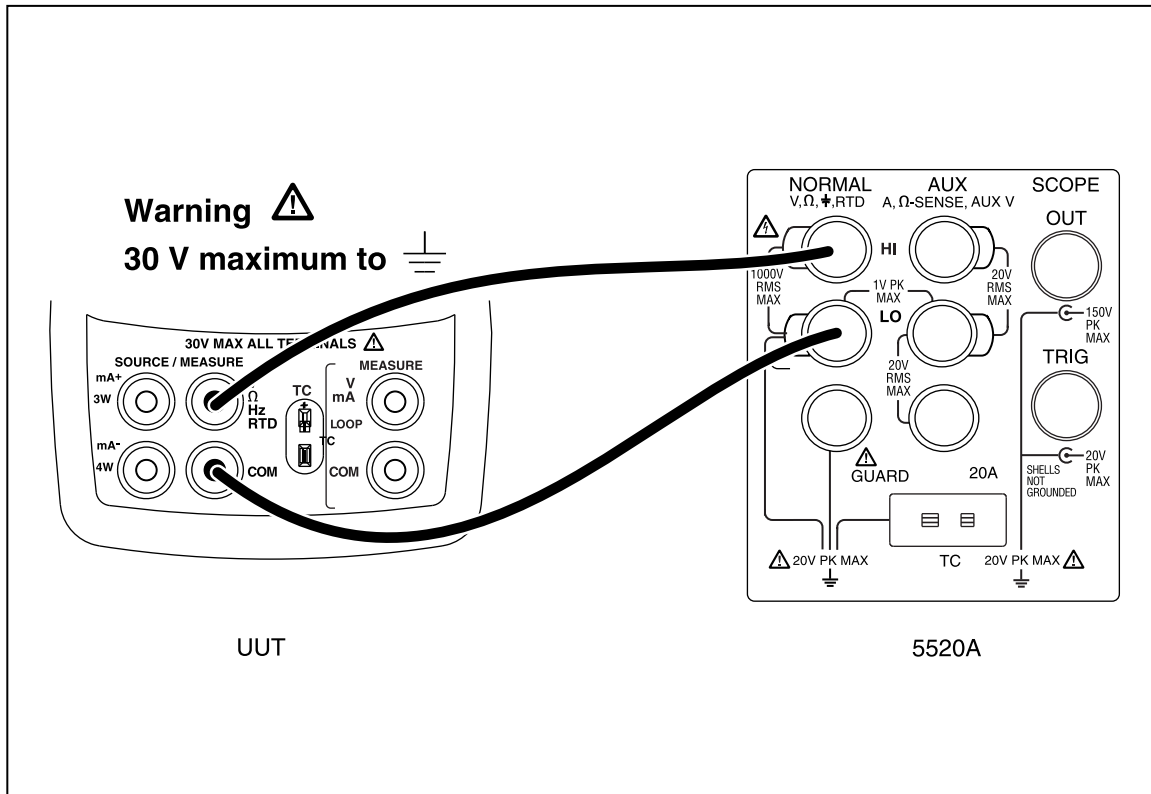

Figure 13. Volts Input Calibration Connections

aal04f.eps

From the Calibration Menu, type the cal step for Cal Volts Input. The PC displays:

```
Enter 0 Volts - press " the proper key" to continue
```

Set the Fluke 5520A to output 0.0000 V, then press the space bar. After a short while, the following calibration constant and prompt are displayed on the PC:

```
Offset = -40
Enter 10.00 Volts - press space bar to continue
```

Set the Fluke 5520A to output 10.0000 V, and press the space bar. After a short while, the following calibration constants and prompt are displayed on the PC:

```
diff = (Counts - Offset)
3032676 = 3032636 - -40
Volts per count = 0.000003
- press space bar to continue
```

Press the space bar to return to the Calibration Menu.

Cal Volts Output

Connect the UUT as shown in Figure 14.

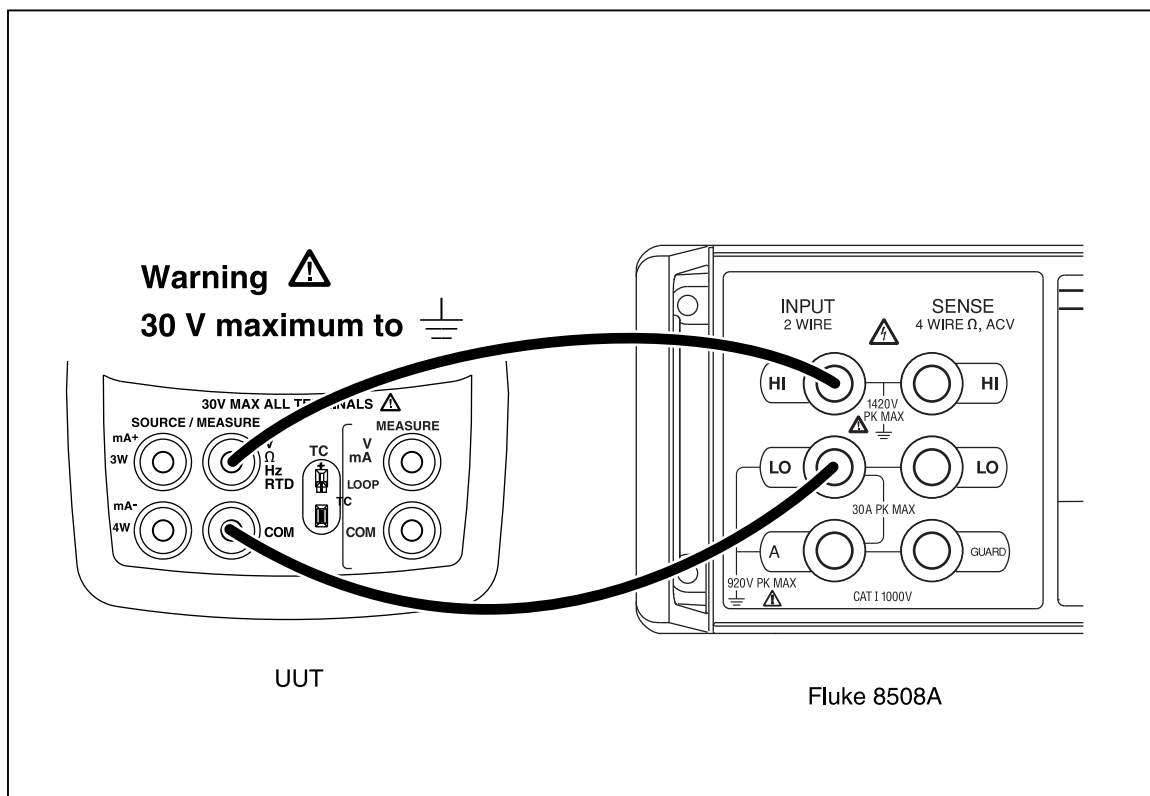

Figure 14. Volts Output Calibration Connections

From the Calibration Menu, type the number or letter for Cal Volts Output. The PC displays:

```
Zero into DAC. Enter the Volts displayed :
```

Set the Fluke 8508A to read V DC. When the reading on the 8508A has stabilized, enter the value in volts on the PC, and press Enter. You only need to enter four places past the decimal point and do not need to enter the units (V). After a short while, the PC displays:

```
Max value into DAC. Enter the Volts displayed :
```

Enter the voltage reading (four places past the decimal) from the Fluke 8508A on the PC, then press Enter. After a short while the PC displays the following calibration constants and new prompt:

```
0.000170 = 11.071999 - 0.000000 )/ 65279.00  
- press space bar to continue
```

Press the space bar to return to the Calibration Menu.

Cal mA Input (Fluke 725 Only)

Connect the UUT as shown in Figure 15.

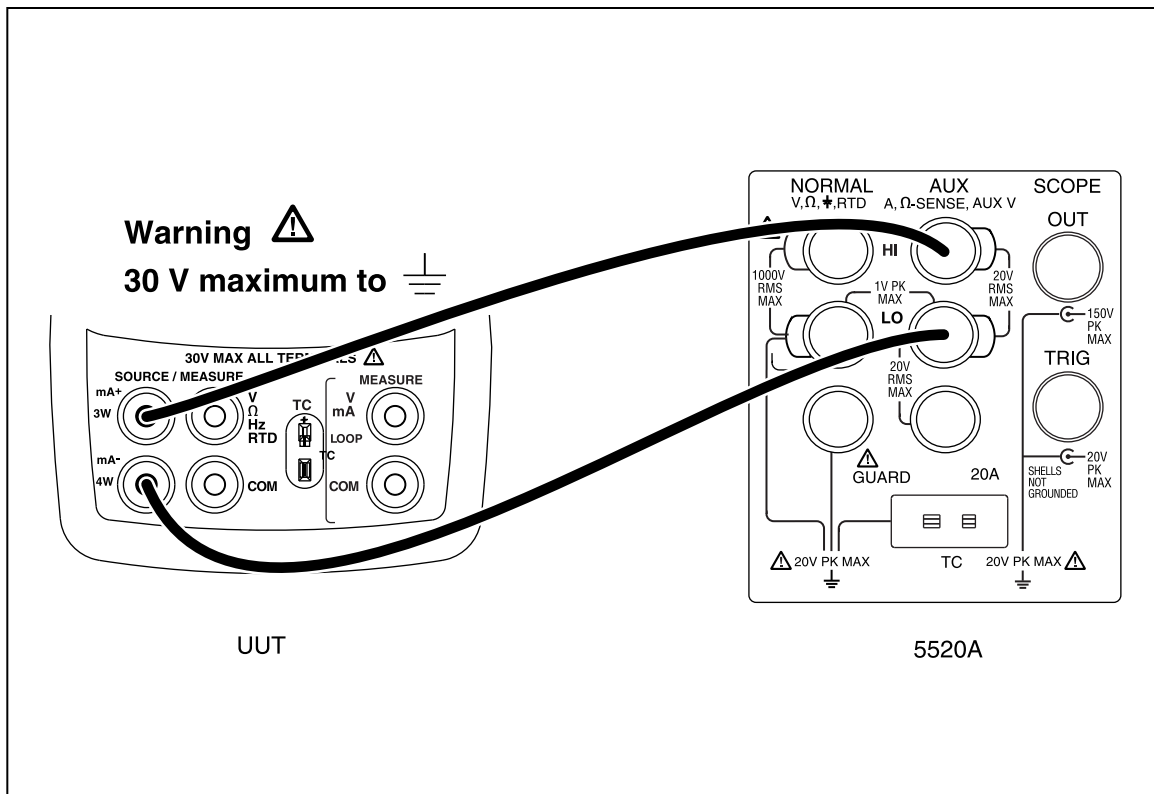

Figure 15. mA Input Calibration Connections

aal06f.eps

From the Calibration Menu, type the cal step for Cal mA Input. The PC displays:

```
Enter 0 ma - press space bar to continue
```

Set the Fluke 5520A to output 0.000 mA, let the reading settle a few seconds, then press the space bar on the PC. After a short while, the PC displays the following calibration constant and new prompt:

```
Offset = -337
Enter 24.00 ma - press space bar to continue
```

Set the Fluke 5520A to output 24.000 mA, let the reading settle a few seconds, then press the space bar on the PC. After a short while, the UUT displays the following calibration constants and new prompt:

```
diff = (Counts - Offset)
8106924 = 8106587 - -337
mA per count = 0.000003
press space bar to continue
```

Press the space bar to return to the Calibration Menu.

Cal mA Output (725 Only)

Connect the UUT as shown in Figure 16.

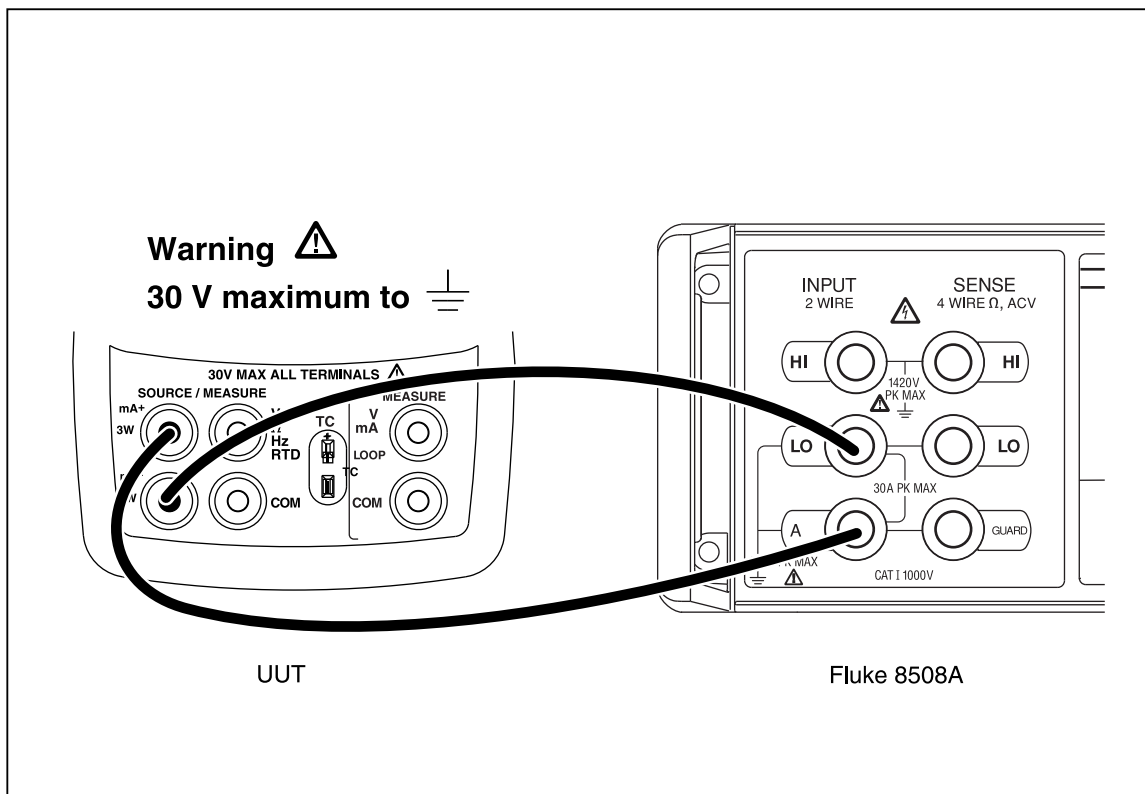

Figure 16. mA Output Calibration Connections

aal12f.eps

From the Calibration Menu, enter the cal step for Cal mA Output. The PC displays:

```
Zero into DAC. Enter mA displayed :
```

Set the Fluke 8508A to read DC current. When the reading on the Fluke 8508A has stabilized, enter the value in milliamps on the PC, then press Enter. You only need to enter four places past the decimal point and do not need to enter the units (mA). Wait for the following prompt on the PC:

```
Max value into DAC. Enter mA value displayed :
```

Enter the current reading from the Fluke 8508A in the PC, then press Enter. After a short while, the following calibration constants and new prompt are displayed on the PC:

```
-1.628906 = ( 24.735999 - 0.076400 ) / 65279.00
mA per count = -1.628906
- press space bar to continue
```

Press the space bar to return to the Calibration Menu.

Cal mV Input

Connect the UUT as shown in Figure 17.

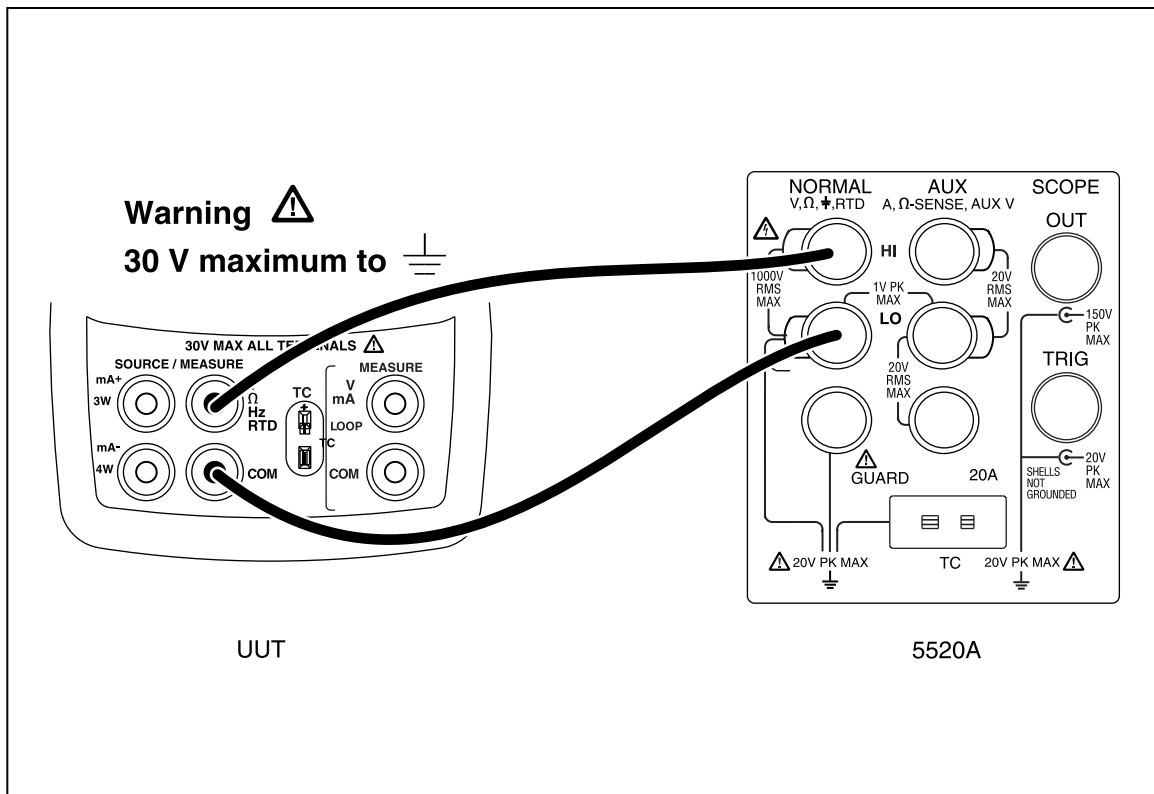

Figure 17. mV Input Calibration Connections

From the Calibration Menu, type the number or letter for Cal mV Input. The PC displays:

```
Enter 0 mV - press space bar to continue
```

Set the Fluke 5520A to output 0.000 mV, let the output settle then press the space bar on the PC. After a short while, the PC displays the following calibration constant and new prompt:

```
Offset = -714
Enter 90.00 mV - press space bar to continue
```

Set the Fluke 5520A to output 90.000 mV, let the output settle, then press the space bar on the PC. After a short while, the PC displays the following calibration constants and new prompt:

```
diff = (Counts - Offset)
7513104 = 7512390 - -714
mV per count = 0.000012
-press space bar to continue
```

Press the space bar to return to the Calibration Menu.

Cal mV Output

Connect the UUT as shown in Figure 18.

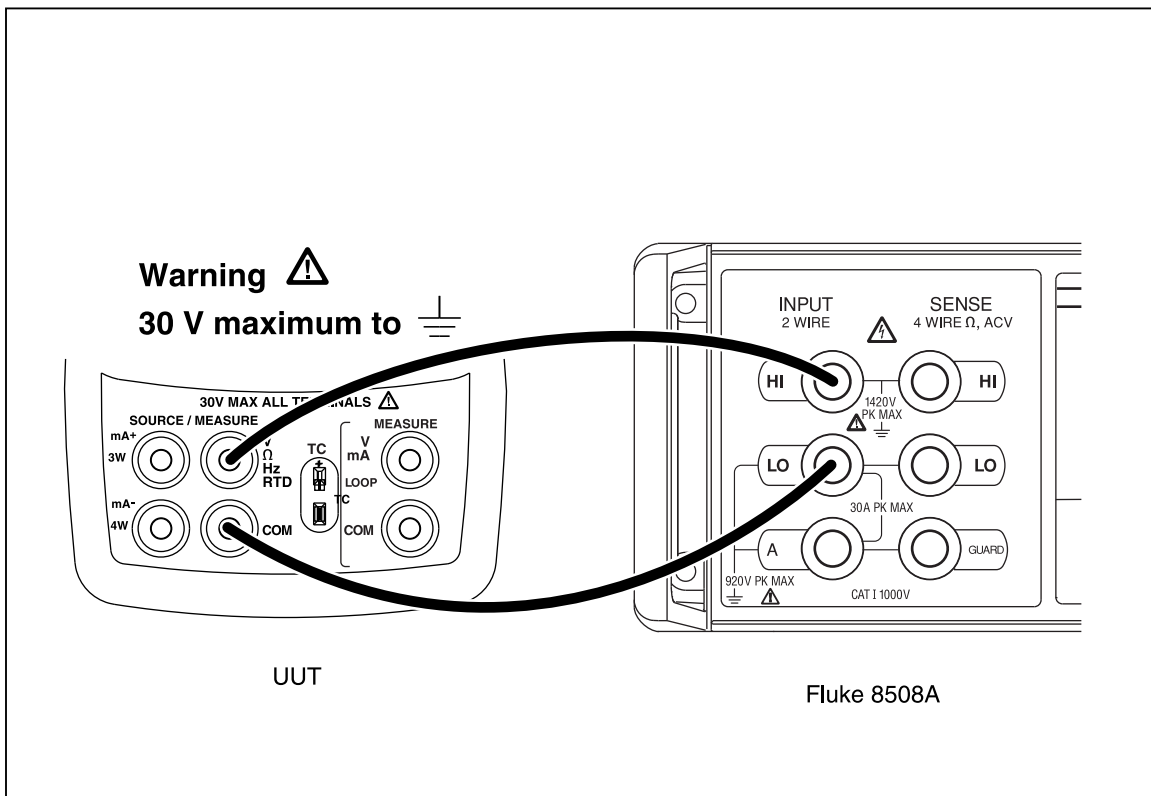

Figure 18. mV Output Calibration Connections

From the Calibration Menu, enter the cal step for Cal mV Output. The PC displays:

```
Zero into DAC. Enter mV displayed :
```

Set the Fluke 8508A to read V DC. When the reading on the Fluke 8508A has stabilized, enter the value in millivolts on the PC, then press Enter. You only need to enter four places past the decimal point and do not need to enter the units (mV). After a short while, the PC displays:

```
Max value into DAC. Enter mV value displayed :
```

Enter the mV reading from the Fluke 8508A on the PC, press Enter, then press the space bar. After a short while, the PC displays the following calibration constants and new prompt:

```
6537.086487 = 111.874998 - -12.450000 )/ 65279.00 mV per count = 6537.0864  
87  
- press space bar to continue
```

Press the space bar to return to the Calibration Menu.

Cal Thermocouples

Connect the UUT as shown in Figure 19.

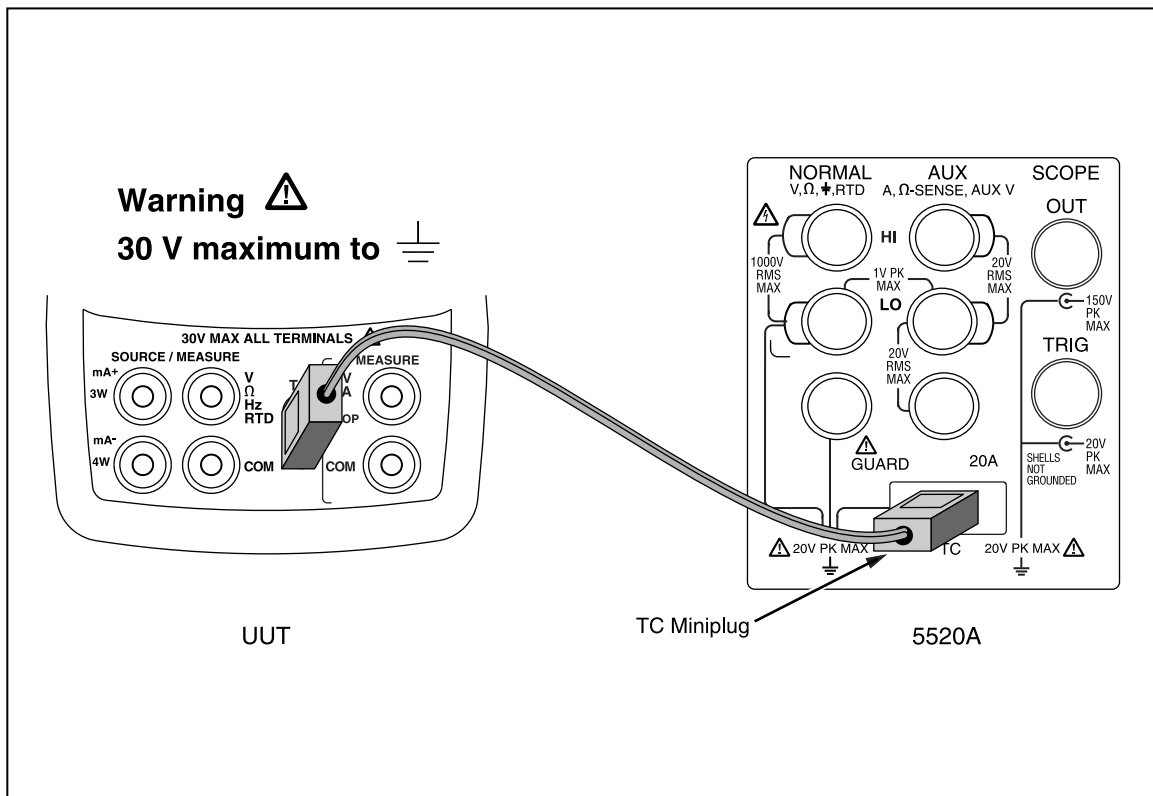

Figure 19. Thermocouples Calibration Connections

aal11f.eps

From the Calibration Menu, enter the cal step for Cal Thermocouples. The PC displays:

```
Connect accurate T/C source : TYPE-J thermocouple
Simulate 0.0 degrees C
- press space bar to continue
```

Set the Fluke 5520A to output 0.00 degrees C for a type-J thermocouple using the ITS-90 standard, then press the space bar on the PC. After a short while, the PC displays the following calibration constant and new prompt:

```
CJC Temp Read = 27.359071
Type 2
CJC mV = 1.400393

mV Read = -1.260579

CJC = 0.139814, (cjc - type_j) = 2.736758
- press space bar to continue
```

Press the space bar to return to the Calibration Menu.

Cal Ohms Hi Source

Connect the UUT as shown in Figure 20.

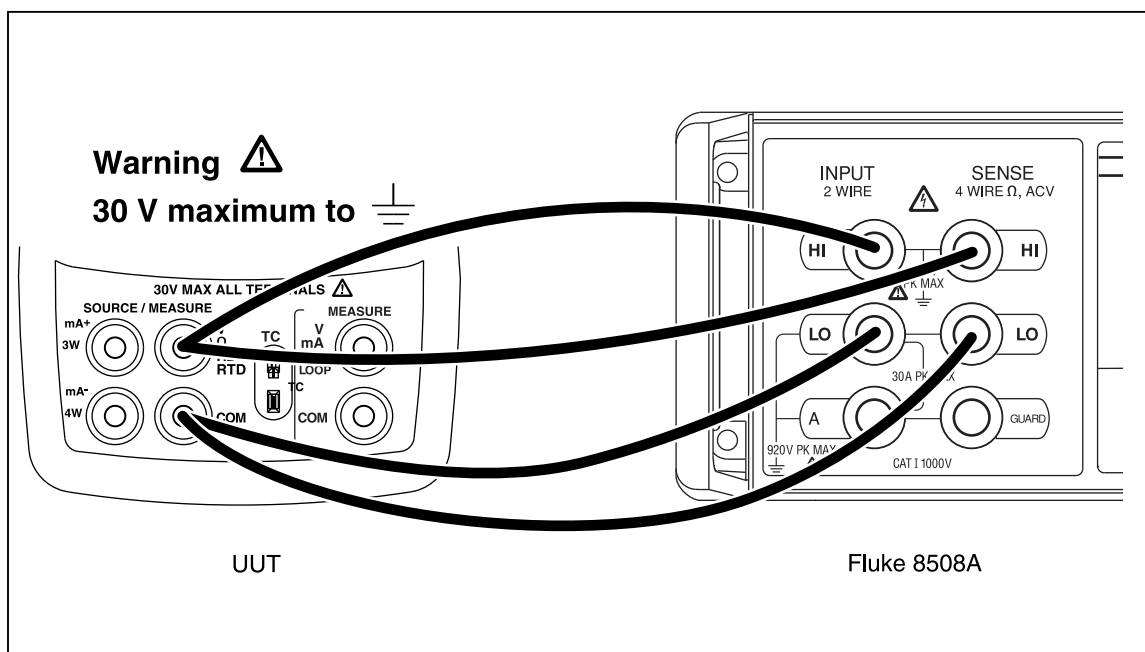

Figure 20. Ohms Hi Source Calibration Connections

aal13f.eps

From the Calibration Menu, enter the cal step for Cal Ohms Hi Source. The PC displays:

```
2500 into DAC. Enter Ohms displayed :
```

Set the Fluke 8508A to read 4-terminal Ohms. Lock the 8508A 20 kΩ range with LOI off. When the reading on the Fluke 8508A has stabilized, enter the value in Ohms on the PC, then press Enter. After a short while, the PC displays:

```
Max value into DAC. Enter Ohms value displayed :
```

Enter the resistance reading from the Fluke 8508A in the PC, then press Enter. After a short while, the PC displays the following calibration constants and new prompt:

```
0.050685 = 3309.000015 - 0.365000 )/ 65279.00 Ohms per count = 0.050685  
- press space bar to continue
```

Press the space bar to return to the Calibration Menu.

Cal Ohms Low Source

The UUT connection is the same as cal Ohms Hi Source, it is shown in Figure 20.

From the Calibration Menu, enter the cal step for Cal Ohms Low Source. The PC displays:

```
2500 into DAC. Enter Ohms displayed :
```

Set the Fluke 8508A to read 4 terminal Ohms. Lock the 8508A 2 k Ω range with LOI off. When the reading on the Fluke 8508A has stabilized, enter the value in Ohms on the PC, then press Enter. After a short while, the PC displays:

```
Max value into DAC. Enter Ohms value displayed :
```

Enter the resistance reading from the Fluke 8508A in the PC, then press Enter. After a short while, the PC displays the following calibration constants and new prompt:

```
Gain = 0.006910  
y intercept = -57  
= 451.459980 - 17.670000 ) / 65279.00 - press space bar to continue
```

Pressing the space bar will return to the Calibration menu.

Cal RTD Low Range

Connect the UUT as shown in Figure 21.

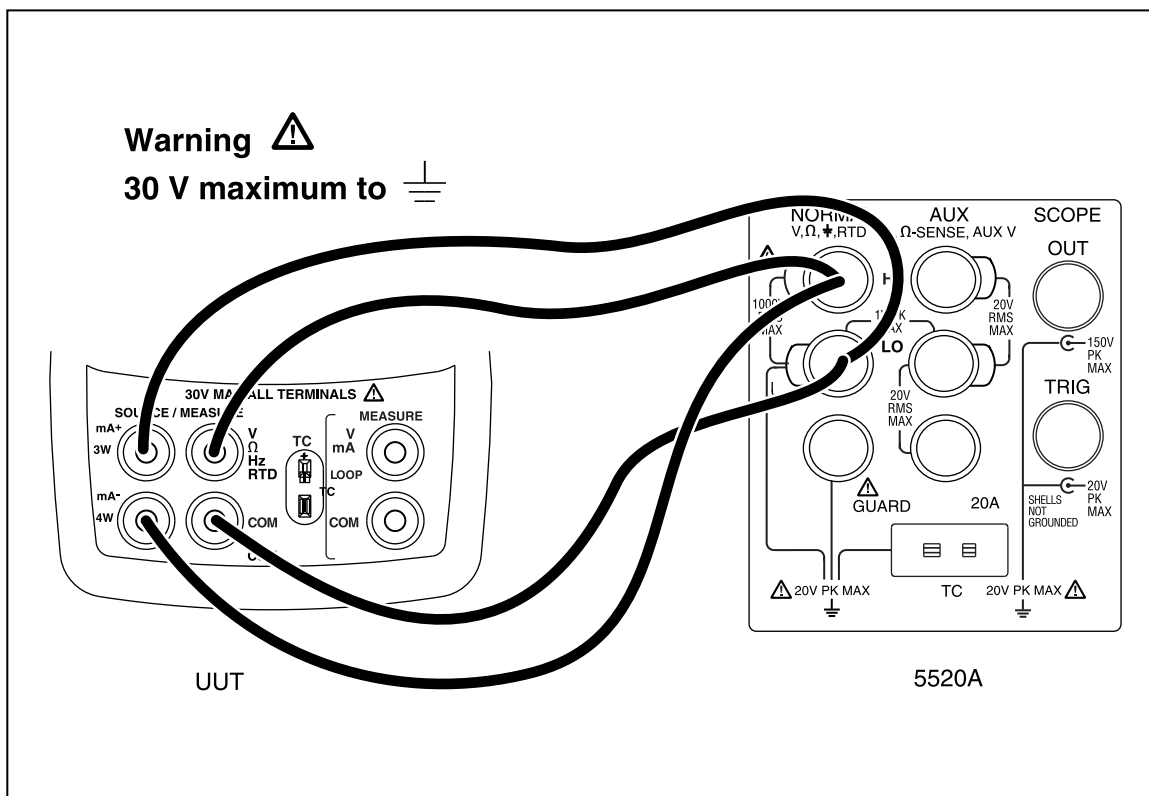

Figure 21. RTD Low Range Calibration Connections

From the Calibration Menu, enter the cal step for Cal RTD Low Range. The PC displays:

```
Apply 15 ohms to 4 wire jacks  
press space bar to continue
```

Set the Fluke 5520A to output 15.00 Ohms, 2-wire output with 2-wire comp off, then press the space bar on the PC. After a short while, the PC displays:

```
Apply 350 ohms to 4 wire jacks  
press space bar to continue
```

Set the Fluke 5520A to output 350.00 Ohms then press the space bar on the PC. After a short while, the Calibrator will return to the Calibration Menu.

Cal RTD Hi Range

The UUT connection is the same as Cal RTD Low Range, it is shown in Figure 21.

From the Calibration Menu, enter the cal step for Cal RTD Hi Range. The PC displays:

```
Apply 500 ohms to 4 wire jacks  
press space bar to continue
```

Set the Fluke 5520A to output 500.0 Ohms, 2-wire output with 2-wire comp off, then press the space bar on the PC. After a short while, the PC displays:

```
Apply 3200 ohms to 4 wire jacks  
press space bar to continue
```

Set the Fluke 5520A to output 3200.0 Ohms, then press the space bar on the PC. After a short while, the Calibrator will return to the Calibration Menu.

Cal ISO Volts

Connect the UUT as shown in Figure 22.

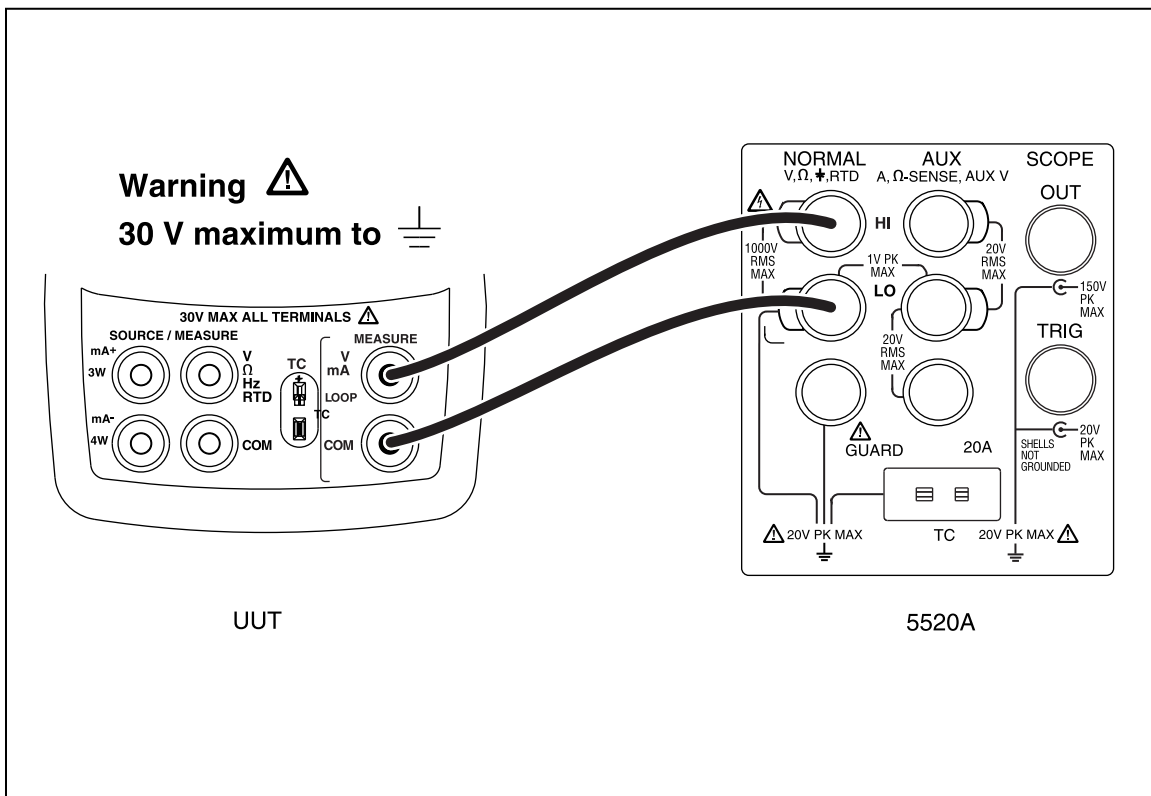

Figure 22. ISO Volts Calibration Connections

aal03f.eps

From the Calibration Menu, enter the cal step for Cal ISO Volts. The PC displays:

```
Enter 0 Volts - press space bar to continue
```

Set the Fluke 5520A to output 0.0000 V, then press the space bar on the PC. After a short while the PC displays the following a calibration constant and new prompt:

```
Offset = -324
Enter 30.00 Volts - press space bar to continue
```

Set the Fluke 5520A to output 30.0000 V, then press the space bar on the PC. After a short while, the PC displays the following calibration constants and prompt:

```
diff = (Counts - Offset)
30700 = 30376 - -324
Volts per count = 0.000977
- press space bar to continue
```

Press the space bar to return to the Calibration Menu.

Cal ISO mA

Connect the UUT as shown in Figure 23.

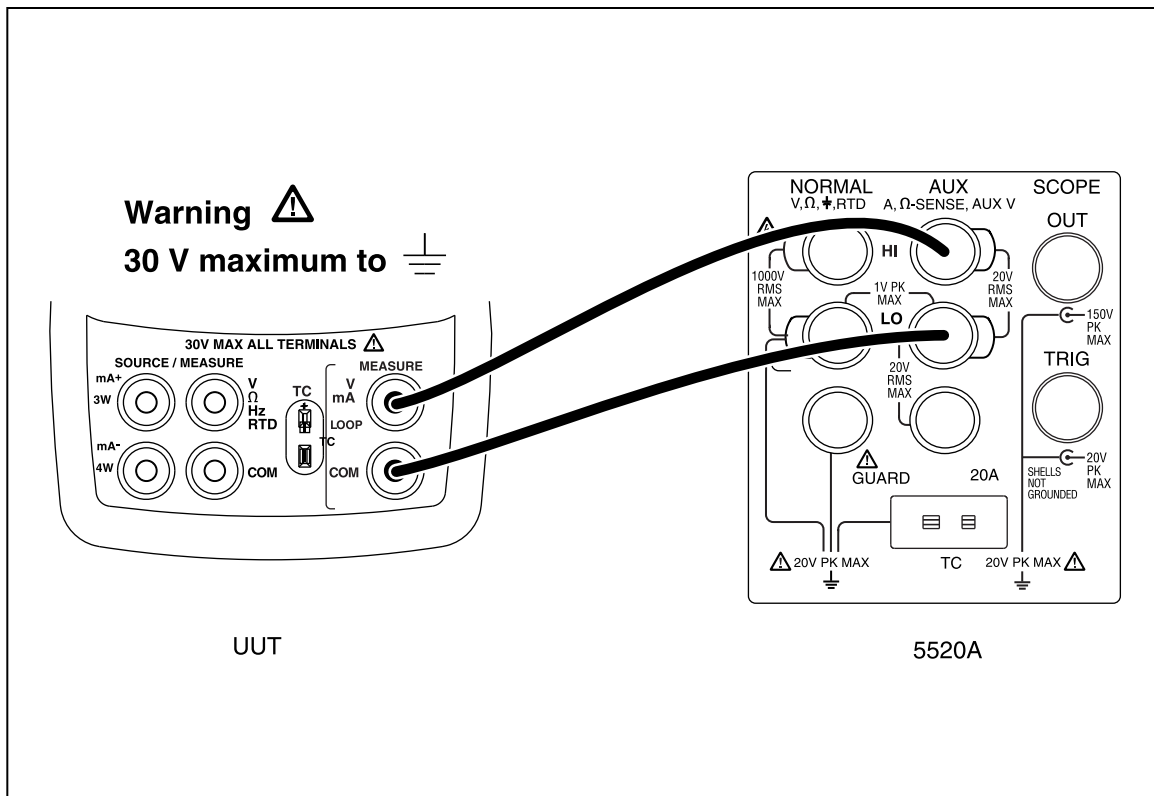

Figure 23. ISO mA Calibration Connections

aal05f.eps

From the Calibration Menu, enter the cal step for Cal ISO mA. The PC displays:

```
Enter 0 ma - press space bar to continue
```

Set the Fluke 5520A to output 0.0000 mA. After a short while, the PC displays the following calibration constants and prompt:

```
Offset = -323
Enter 24.00 ma - press space bar to continue
```

Set the Fluke 5520A to output 24.0000 mA then press the space bar on the PC. After a short while, the PC displays the following calibration constants:

```
diff = (Counts - Offset)
32133 = 31810 - -323
mA per count = 0.000747
- press space bar to continue
```

Press the space bar to return to the Calibration Menu.

Adjustment is completed. Turn the UUT off, then back on, to return to normal operation.

Calibration Adjustment Procedures (726 and 724/725 with V3.00 and Higher)

Note

This procedure does not cover the verification of the unit. The Calibrator should never use up more than 50 % of its specifications immediately after calibration. When calibrating the 726, you can also exit and enter calibration mode while performing the verification, subject to the dependencies listed in the procedure.

Initiating Communication

The subsequent sections detail the calibration procedures for the 726 and 725/724 firmware V3.00 or higher.

To initiate calibration-mode communication, use the terminal to send the CAL_START command. Enter the required password.

- The password for all 726 Calibrators is 627.
- The password for all 725 Calibrators is 527.
- The password for all 724 Calibrators is 427.

One of the calibration menus (below) will then be shown on the terminal.

726 Calibration Menu

```
Calibration Menu
 1:  ISO mA Input
 2:  ISO Volts Input
 3:  mA Input
 4:  mA Output
 5:  Volts Input
 6:  Volts Output
 7:  Low Ohms Source
 8:  High Ohms Source
 9:  Ohms Measure
10:  TC mV Output
11:  TC mV Input
12:  TC CJC
13:  Exit
```

Enter Selection:

725 Calibration Menu

Calibration Menu

- 1: ISO mA Input
- 2: ISO Volts Input
- 3: mA Input
- 4: mA Output
- 5: Volts Input
- 6: Volts Output
- 7: Low Ohms Source
- 8: High Ohms Source
- 9: Ohms Measure
- 10: TC mV Output
- 11: TC mV Input
- 12: TC CJC
- 13: Exit

Enter Selection:

724 Calibration Menu

Calibration Menu

- 1: ISO mA Input
- 2: ISO Volts Input
- 3: Volts Input
- 4: Volts Output
- 5: Low Ohms Source
- 6: High Ohms Source
- 7: Ohms Measure
- 8: TC mV Output
- 9: TC mV Input
- 10: TC CJC
- 11: Exit

Enter Selection:

Calibrating Isolated mA Input

Connect the UUT as shown in Figure 24.

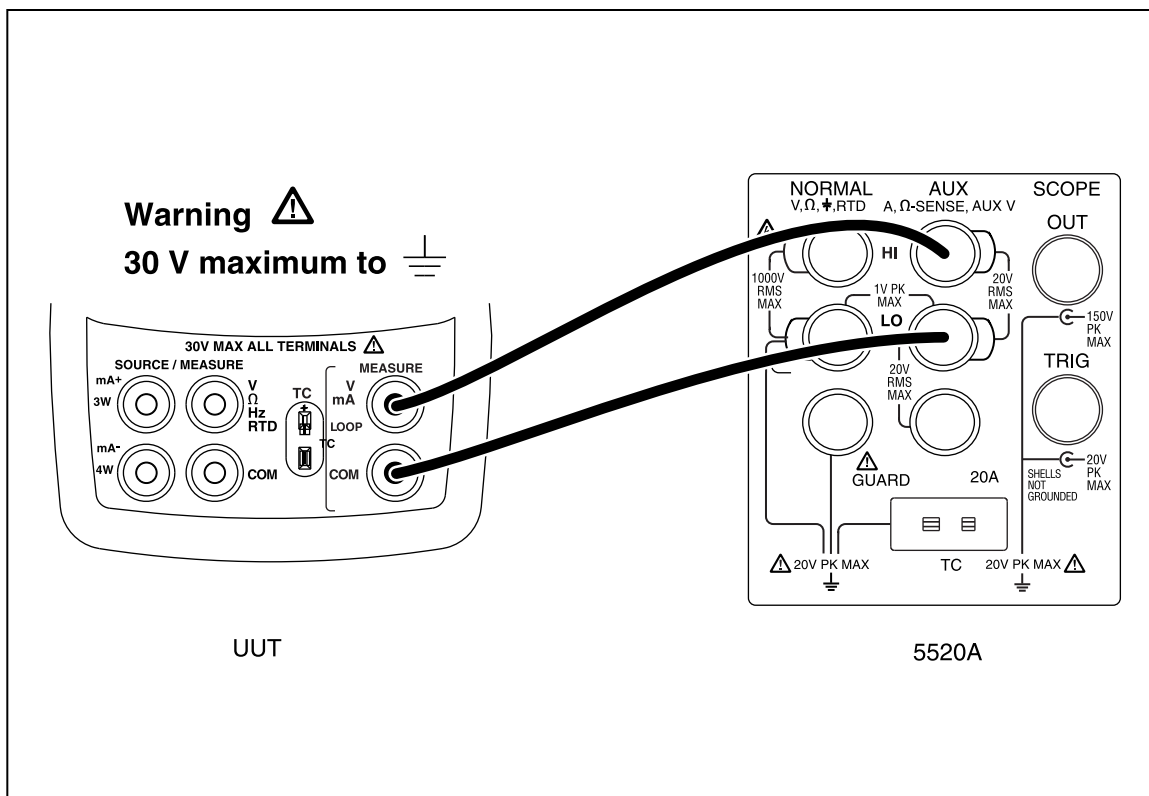

Figure 24. Isolated mA Input Calibration Connections

aal05f.eps

After the proper connections have been made, type “1” (the first calibration step) then press the Enter key on the PC keyboard. Input directions are displayed at the bottom of the calibration menu:

```
Enter Selection:  
Input 0 mA, Press Enter When Stable  
Input 24 mA, Press Enter When Stable
```

Use the 5520A to input 0 mA and then 24 mA.

Calibrating Isolated Voltage Input

Connect the UUT as shown in Figure 25.

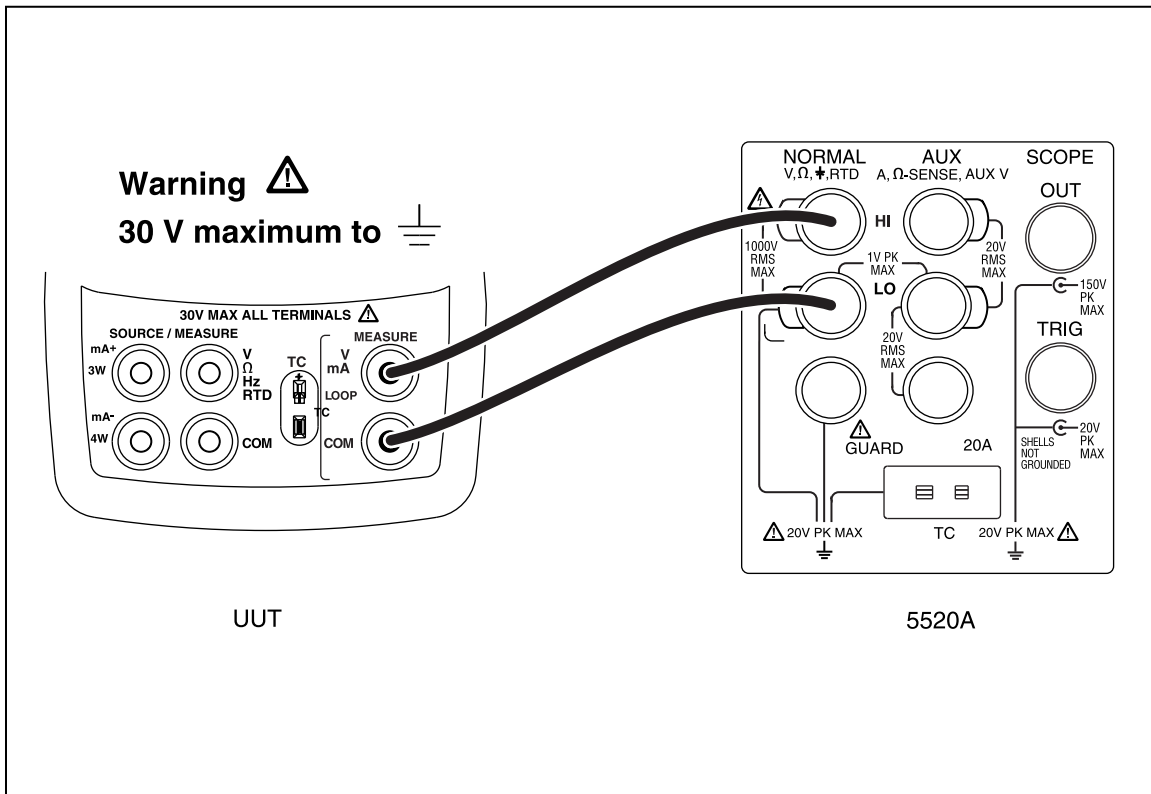

Figure 25. Isolated Voltage Input Calibration Connections

aal03f.eps

After making the proper connections, type “2” then press the Enter key on the PC keyboard. Input directions are displayed at the bottom of the calibration menu:

```
Enter Selection:
Input 0 Volts, Press Enter When Stable
Input 30 Volts, Press Enter When Stable
```

Use the 5520A to input 0 V and then 30 V.

Calibrating mA Input (Fluke 725 and 726 only)

Connect the UUT as shown in Figure 26.

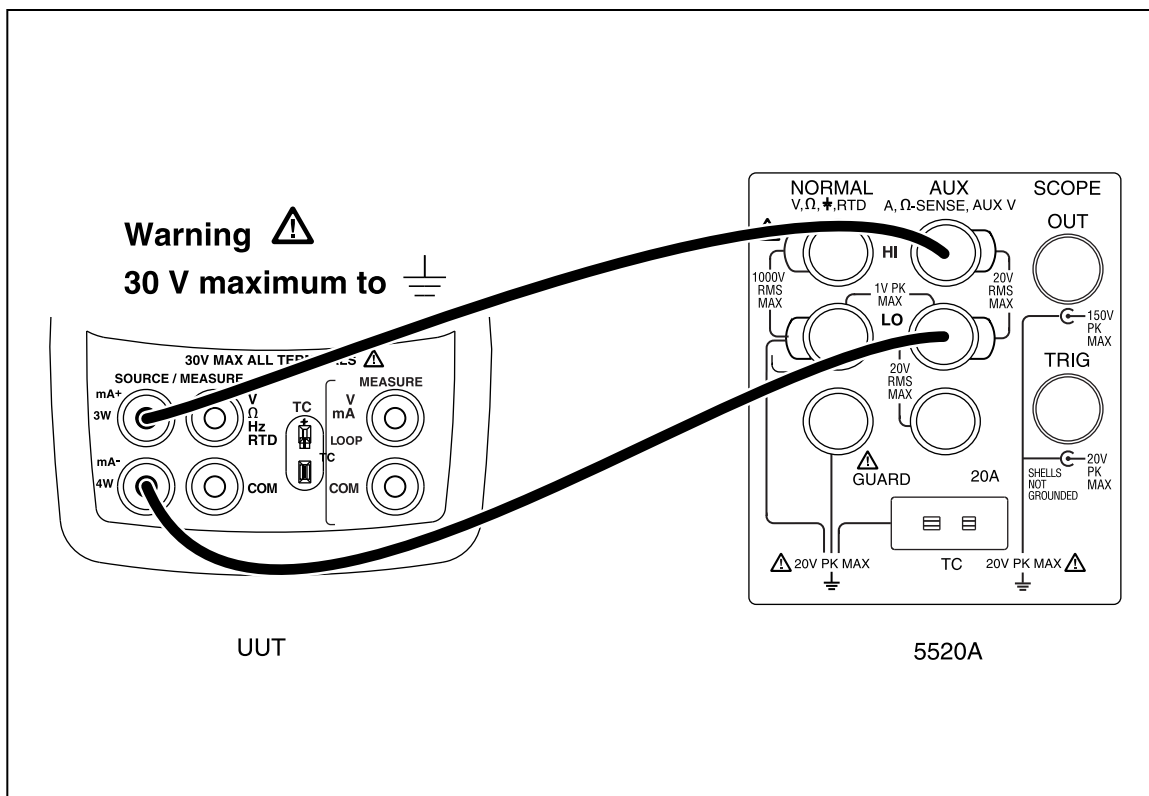

After making the proper connections, type “3” then press the Enter key on the PC keyboard. Input directions are displayed at the bottom of the calibration menu:

```
Enter Selection:  
Input 0 mA, Press Enter When Stable  
Input 24 mA, Press Enter When Stable
```

Use the 5520A to input 0 mA and then 24 mA.

Calibrating mA Output (Fluke 725 and 726 only)

Connect the UUT as shown in Figure 27.

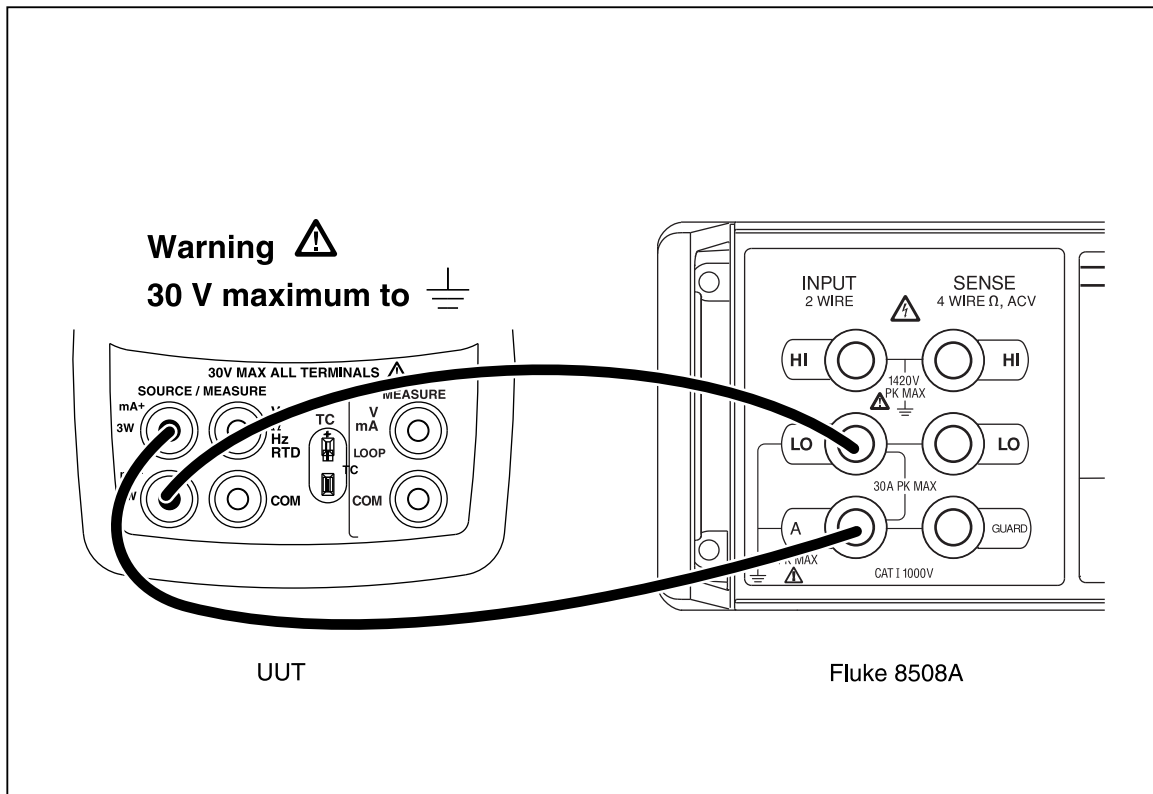

Figure 27. mA Output Calibration Connections

After making the proper connections, type “4” then press the Enter key on the PC keyboard. Input directions are displayed at the bottom of the calibration menu:

```
Enter Selection:  
First Calibration Point. Enter mA displayed:  
Second Calibration Point. Enter mA displayed:
```

Use the 8508A to measure the two calibration points. Enter each of the two calibration points as prompted.

Calibrating Voltage Input

Connect the UUT as shown in Figure 28.

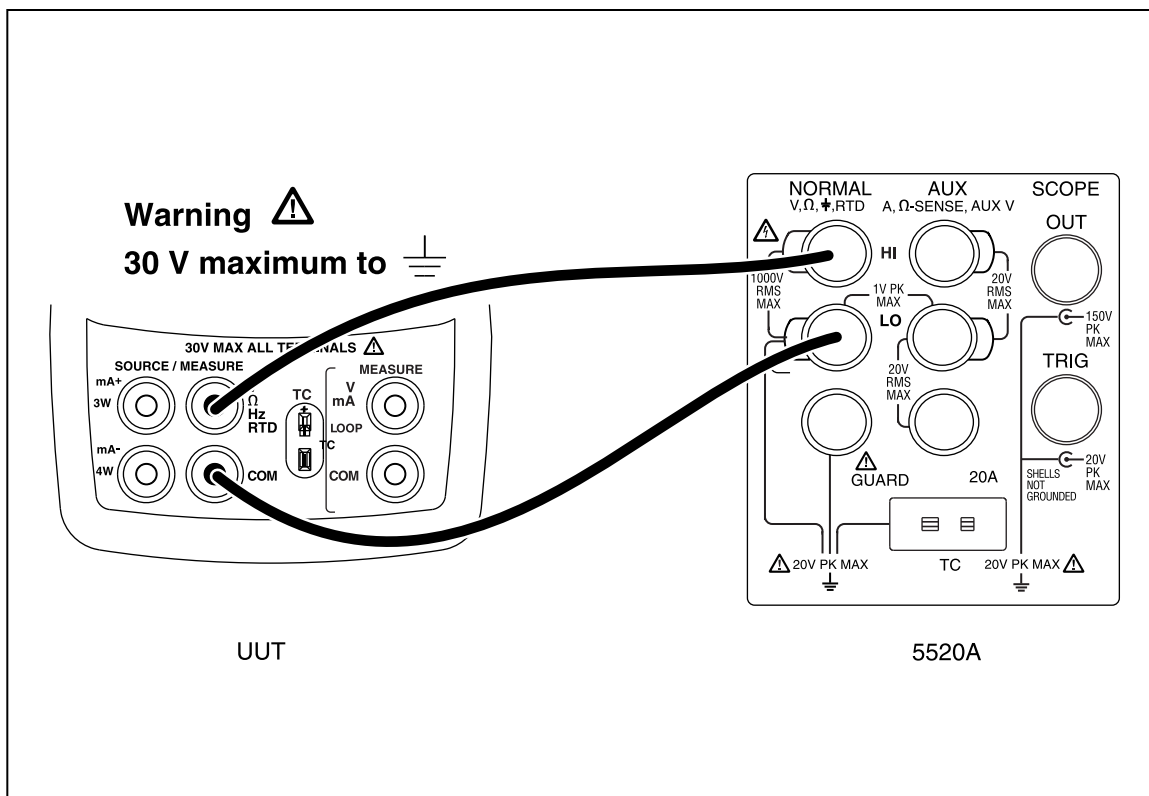

Figure 28. Voltage Input Calibration Connections

aal04.eps

After making the proper connections, type “5” for 726/725 or “3” for 724, and then press the Enter key on the PC keyboard. Input directions are displayed at the bottom of the calibration menu:

```
Enter Selection:  
Input 0 Volts, Press Enter When Stable  
Input 20 Volts, Press Enter When Stable
```

Use the 5520A to input 0 V and then 20 V.

Calibrating Voltage Output

Connect the UUT as shown in Figure 29.

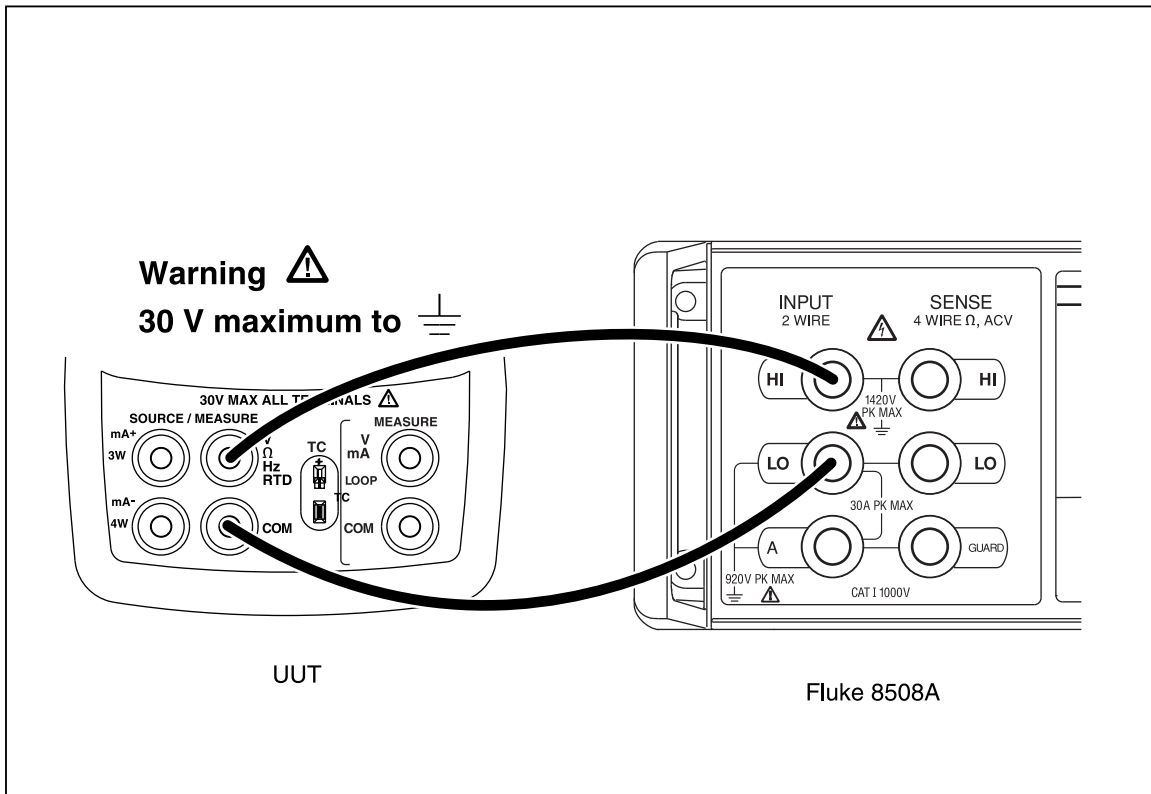

Figure 29. Voltage Output Calibration Connections

aal08f.eps

After making the proper connections, type “6” for 726/725 or “4” for 724, and then press the Enter key on the PC keyboard. Input directions are displayed at the bottom of the calibration menu:

```
Enter Selection:
First Calibration Point. Enter Volts displayed:
Second Calibration Point. Enter Volts displayed:
```

Use the 8508A to measure the two calibration points. Enter each of the two calibration points as prompted.

Calibrating Low Ohms Source

Connect the UUT as shown in Figure 30.

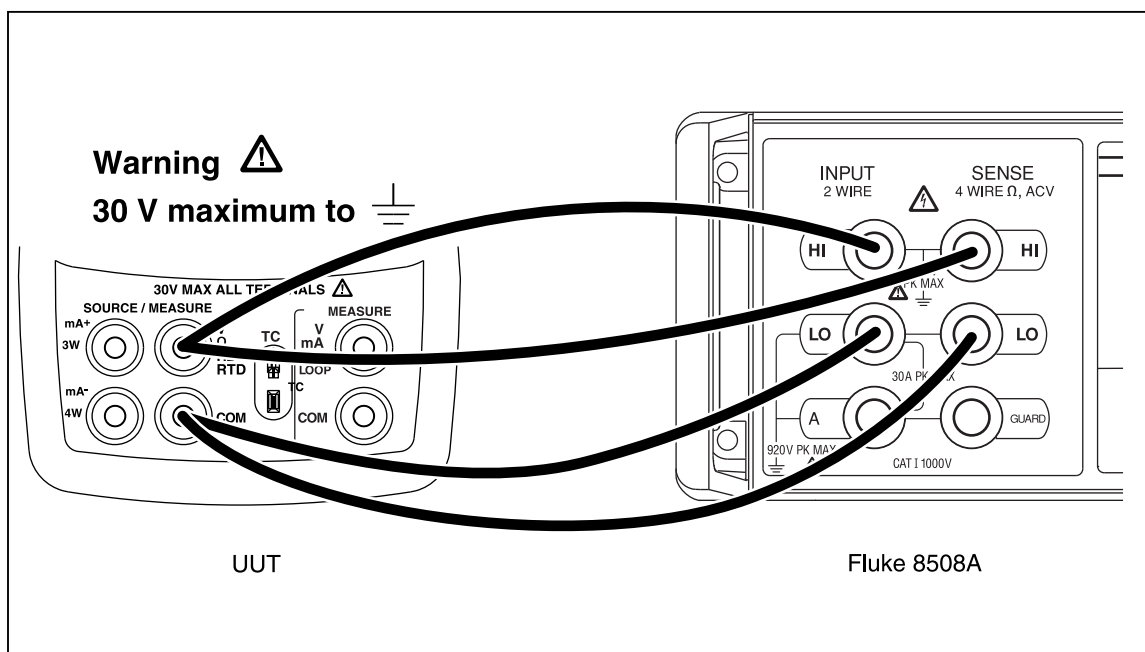

Figure 30. Low Ohms Source Calibration Connections

aal13f.eps

After making the proper connections, type “7” for 726/725 or “5” for 724, and then press the Enter key on the PC keyboard. Input directions are displayed at the bottom of the calibration menu:

Enter Selection:

First Calibration Point. Enter Ohms displayed:

Second Calibration Point. Enter Ohms displayed:

The 8508A should be locked in the 2 kΩ range (1.0 mA excitation). Enter each of the two calibration points as prompted.

Note

For best accuracy, use 8508A 2 kΩ range, 4-wire, LOI Off

Calibrating High Ohms Source

Connect the UUT as shown in Figure 31.

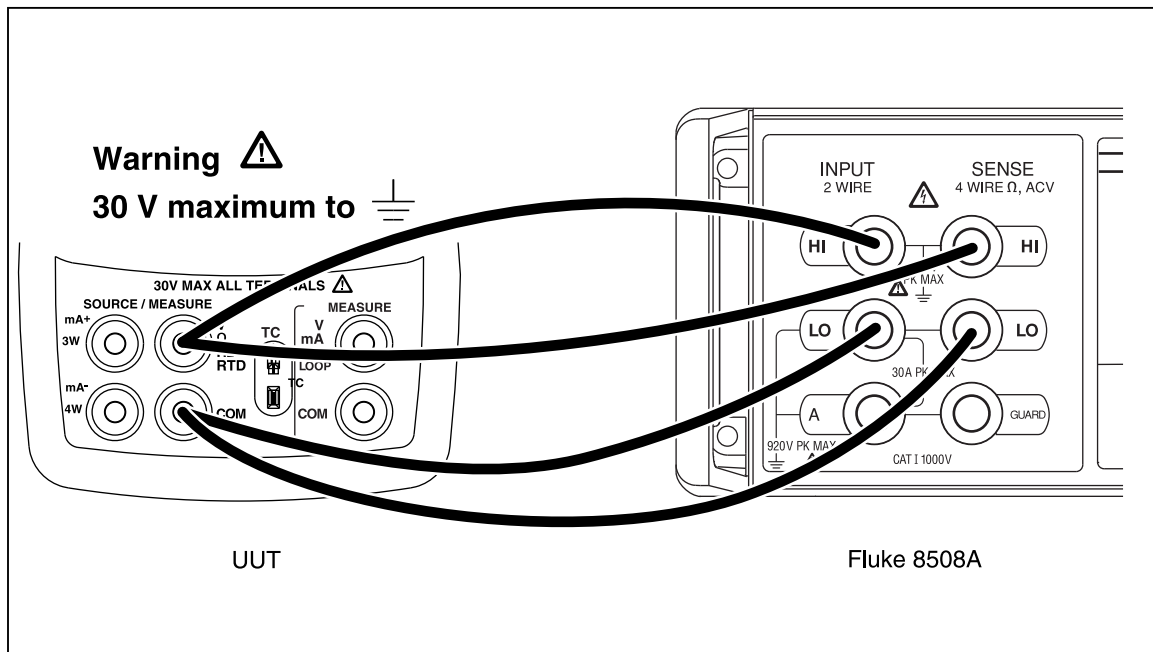

Figure 31. High Ohms Source Calibration Connections

aal13f.eps

After making the proper connections, type “8” then press the Enter key on the PC keyboard. Input directions are displayed at the bottom of the calibration menu:

```
Enter Selection:
First Calibration Point. Enter Ohms displayed:
Second Calibration Point. Enter Ohms displayed
```

The 8508A should be locked in the 20 kΩ range (0.1 mA excitation). Enter each of the two calibration points as prompted.

Note

For best accuracy, use 8508A 20 kΩ range, 4-wire, LOI Off

Calibrating Ohms Measure

Connect the UUT as shown in Figure 32.

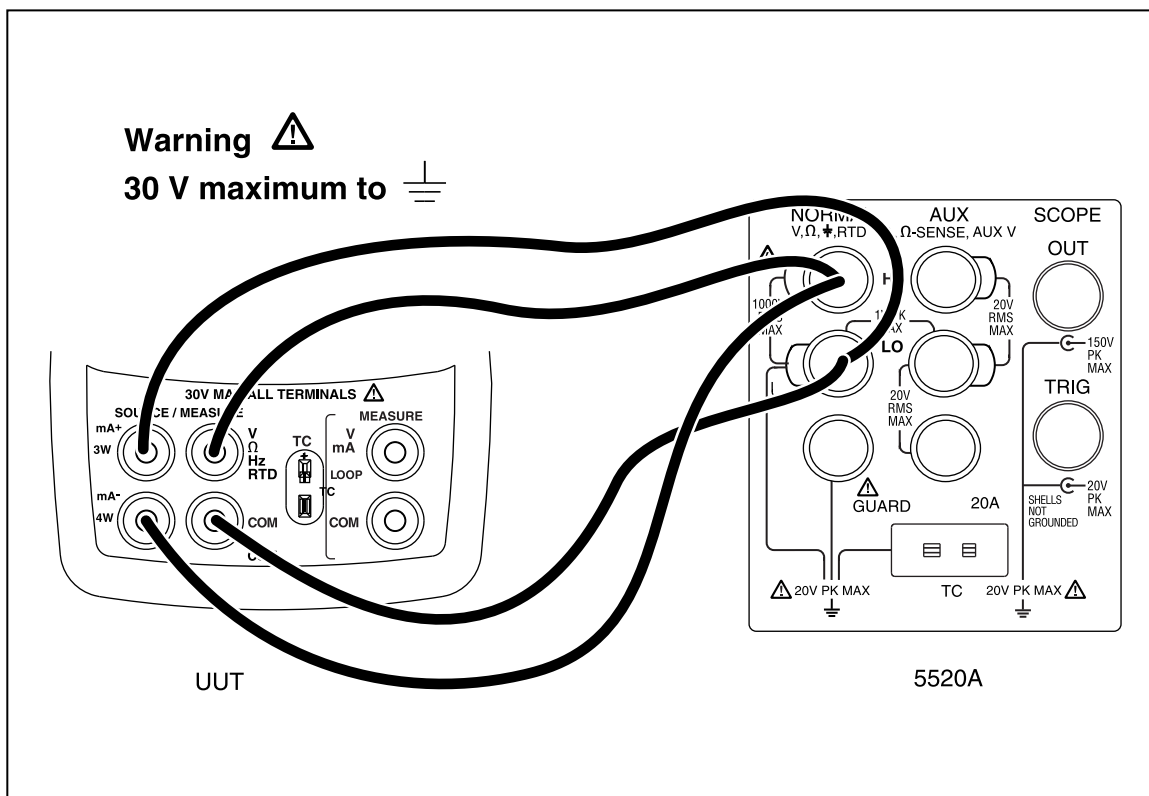

Figure 32. Ohms Measure Calibration Connections

After making the proper connections, type “9” for 726/725 or “6” for 724, and then press the Enter key on the PC keyboard. Input directions are displayed at the bottom of the calibration menu:

```
Enter Selection:  
Input 15 Ohms, Press Enter When Stable  
Input 400 Ohms, Press Enter When Stable  
Input 4000 Ohms, Press Enter When Stable
```

Use the 5520A to input 15 Ω, 400 Ω, and finally 4000 Ω. The Enter key must be applied prior to advancing between steps.

Calibrating Thermocouple mV Output

Connect the UUT as shown in Figure 33.

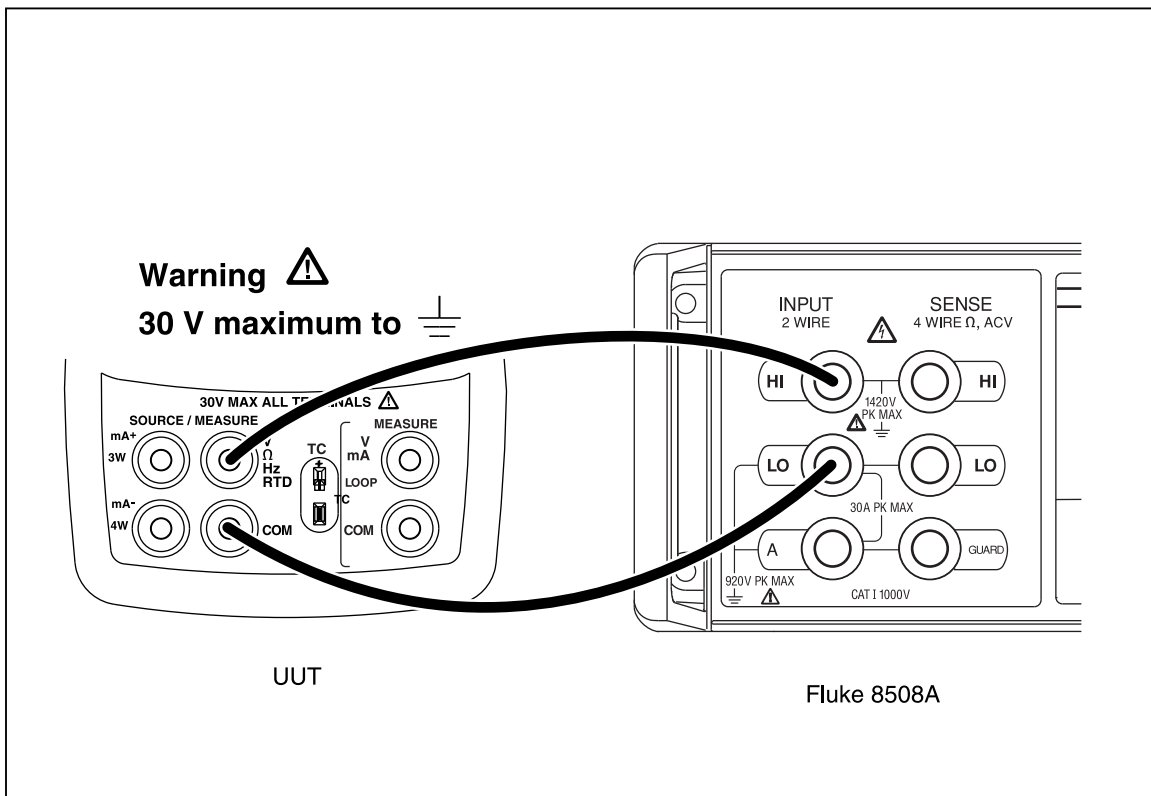

Figure 33. Thermocouple mV Output Calibration Connections

aal08f.eps

After making the proper connections, type “10” for 726/725 or “8” for 724, and then press the Enter key on the PC keyboard. Input directions are displayed at the bottom of the calibration menu:

```
Enter Selection:
First Calibration Point. Enter mV displayed:
Second Calibration Point. Enter mV displayed:
```

Use the 8508A to measure the two calibration points. Enter each of the two calibration points as prompted.

Calibrating Thermocouple mV Input

Connect the UUT as shown in Figure 34.

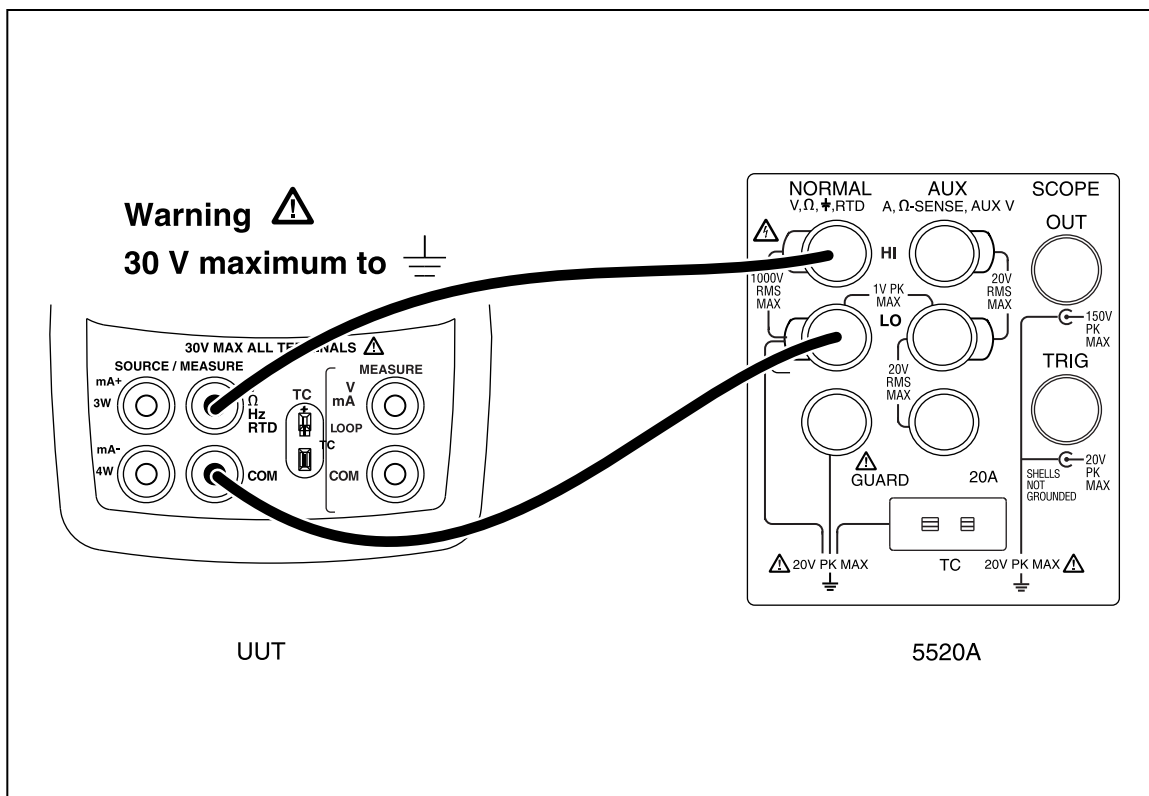

Figure 34. Thermocouple mV Input Calibration Connections

After making the proper connections, type “11” for 726/725 or “9” for 724, and then press the Enter key on the PC keyboard. Input directions are displayed at the bottom of the calibration menu:

```
Enter Selection:  
Input -10mV, Press Enter When Stable  
Input 90mV, Press Enter When Stable
```

Use the 5520A to input -10 mV and then 90 mV.

Note

A 725 with V3.0 prompts for 75 mV, but 90 mV should be applied. V3.1 shows the correct 90 mV applied.

Calibrating Thermocouple CJC:

Connect the UUT as shown in Figure 35. For the lag bath setup, see Figure 36.

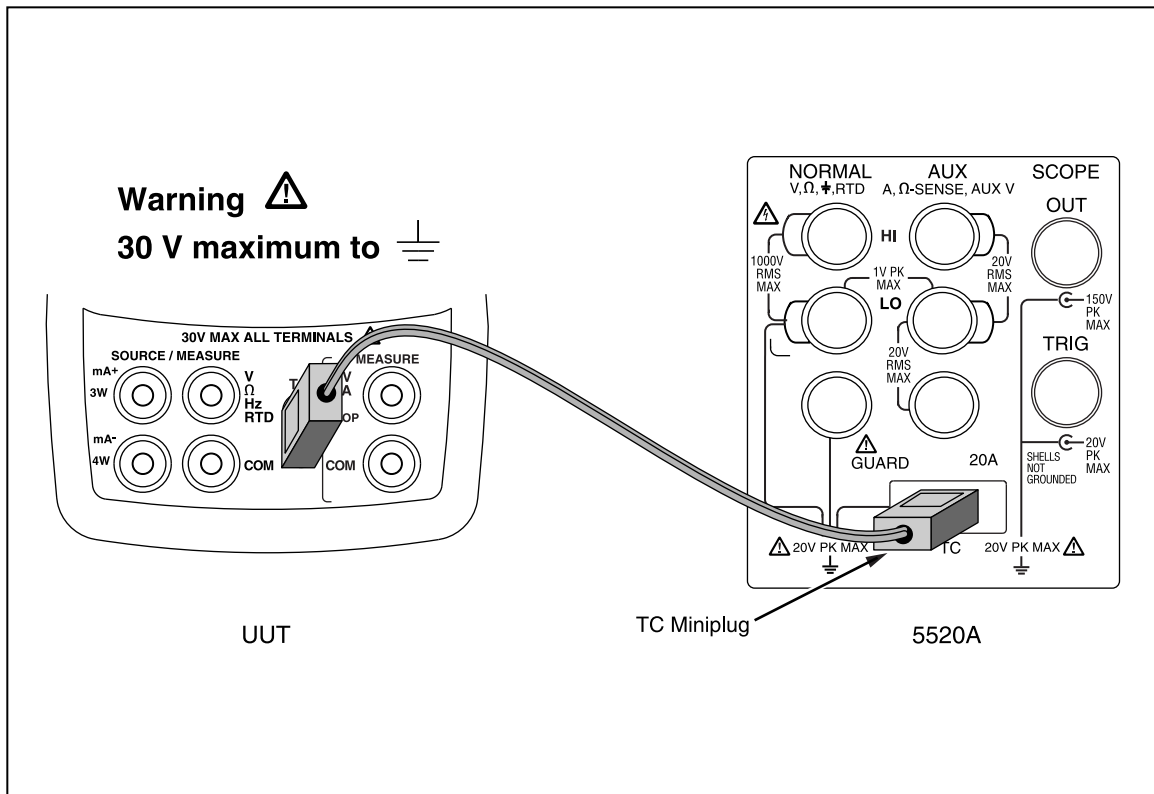

Figure 35. Thermocouple CJC Calibration Connections

The calibration of the TC CJC (Cold Junction Compensation) is a critical part of the calibration process, it is important that the thermocouple junction be allowed to completely stabilize. Usually this takes a minimum of five minutes.

After the proper connections have been made, type “12” for 726/725 or “10” for 724, and then press the Enter key on the PC keyboard. Use a lag bath to source a stable temperature the 726. Enter the value of the temperature and the main calibration menu will reappear. The temperature scale used is ITS-90.

Replaceable Parts

When servicing this Calibrator, use only the replacement parts specified. User-replaceable parts are listed in Table 19 and shown in Figure 36.

Table 19. Replacement Parts

Item	Description	Fluke No.	Quantity
①	724-725 Case top 726 Case top	664232 2491880	1
②	724 LCD mask 725 LCD mask 726 LCD mask 724 LCD mask for new LCD (FW rev 3.00+) 725 LCD mask for new LCD (FW rev 3.00+) 726 LCD mask for new LCD (FW rev 3.00+)	1548383 664273 2491914 4413712 4413701 4413720	1
③	Elastomeric strips	802063	2
④	724 Input/output bracket 725 - 726 Input/output bracket	1549921 691391	1
⑤	LCD bracket	658390	1
⑥	Mounting screws	494641	11
⑦	Backlight	690336	1
⑧	724 - 725 LCD for V2.xx or lower 726 LCD with V1.4 or lower 724-725 with V3.xx or higher 726 with V1.5 or higher	690963 2544712 4413845 4413845	1
⑨	724 Keypad 725 Keypad 726 Keypad	1548126 690955 2461532	1
⑩	Case bottom	664235	1
⑪	AA alkaline batteries	376756	4
⑫	Case screws	832246	4
⑬	Battery door	664250	1
⑭	Accessory mount	658424	1
⑮	Tilt stand	659026	1
⑯	Battery door 1/4-turn fasteners	948609	2
Not Shown	Test leads	Variable ^[1]	1
Not Shown	alligator clip, red	Variable ^[1]	1
Not Shown	alligator clip, black	Variable ^[1]	1
⑰	724 Case top decal 725 Case top decal 726 Case top decal	1548329 690948 2530988	1

Table 19. Replacement Parts (cont.)

Item	Description	Fluke No.	Quantity
⑱	724 Product Overview Manual	1547851	1
	725 Product Overview Manual	1549644	1
	726 Product Overview Manual	2441588	1
⑲	724 CD-ROM (contains Users Manual)	1547849	1
	725/726 CD-ROM (contains Users Manual)	1549615	1
Not Shown	700SC serial interface cable	667425	Optional accessory

[1] See www.fluke.com for more information about the test leads and alligator clips for your region.

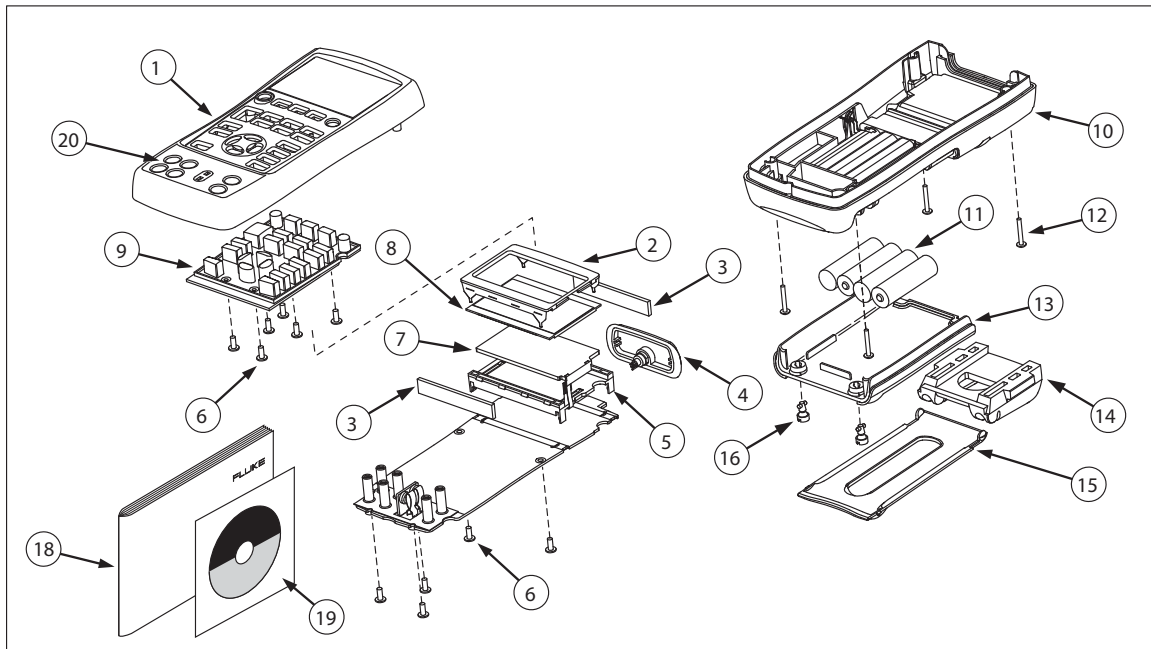

Figure 36. Replacement Parts

aal02f.eps

