

Presentation overview

- **Introduction and Key Objectives**
 - Brian Ray
- **Historical Overview of Highway Geometric Design**
 - Brian Ray
- **AASHTO and TRB Strategic Research Objectives**
 - Hermanus Steyn
- **NCHRP Report 785 Overview and Application**
 - Julia Knudsen and Hermanus Steyn
- **NCHRP Report 839 Overview**
 - Rich Coakley
- **Questions and Discussion**
 - Dr. John Mason

Introduction and Key Objectives

- Two significant steps in advancing the profession's approach to multimodal geometric design
 - NCHRP Report 785, *Performance-Based Analysis of Geometric Design of Highways and Streets*
 - Provides an approach to incorporate performance-based analysis into the project development process.
 - NCHRP Report 839, *Developing an Improved Highway Geometric Design Process*
 - Developed a comprehensive, flexible design process.
 - Update to AASHTO's *Guidelines for Geometric Design of Very Low-Volume Roads*.

...Allowing professionals to adapt to any project context

Historical Overview of Highway Geometric Design

- What are the origins of “standards”?
- What are “standards”?
- Recent National Funding Acts

What are the origins of our “standards”?

- Railroad engineering
- Early motoring



*What were the design controls back in the day?
From where do today's standards originate?*

What are “standards”?

- **Uniform approaches to provide consistency in design**
- **Methods to match criteria to similar design environments**
- **Representative approaches that represent the standards of care of our profession**
- **Anything else?**

What are “standards”?

“Standards” have become safety surrogates

Are the following true?

- If it meets standards it must be safe
- If it doesn't meet standards it is not safe
- If there is no standard for it, it must not be allowable
- If a design exception is needed it must be “bad”
- If we meet standards, we won't be sued

...but what is the research behind our standards?

What are the origins of our “standards”?

Late 1930s and 1940 -- Bureau of Public Roads and AASHO

- Looking for uniformity on roadway designs
- No research done to establish “standards of care”
- A synthesis of practical knowledge to address issues
 - i.e., Physics to cover vehicles in motion on a curve
- “Pamphlets” based on consensus of the practice
- Compiled in a 3 ring notebooks

...These were combined to form “policies” based on committee’s, agency leader’s, and professional’s consensus of the practice

What are the origins of our “standards”?

Late 1950s and 1970s -- FHWA and AASHTO

- **Interstate system founded on military applications**
 - Pavement studies
 - Roadway clearances
 - Bridge capacities
- **Initially primarily focused on rural design (“blue book”) but urban freeways and arterials needs expanded (“red book”)**

...Need for consistency in Interstate system led to policies that were still not necessarily based on research

What are the origins of our “standards”?

1980s The origins of AASHTO’s “Green Book”

- Combine “Blue Book” and “Red Book”
- “Purple Book” at that time was for 3-R Guidance
- Hence the birth of the “Green Book” in 1984

1980s-1990s

- NCHRP research efforts on new and emerging topics; exploring basis of some existing topics (i.e., Sight Distance)

2000’s

- Numerous supplemental guidance documents for topics of interest.

Recent National Funding Acts

- **2005 – Safe, Accountable, Flexible, Efficient Transportation Equity Act: A Legacy for Users (SAFETEA-LU)**
- **2012 – Moving Ahead for Progress in the 21st Century Act (MAP-21)**
 - Performance Measures
- **2015 – Fixing America’s Surface Transportation Act (FAST Act)**
 - Recognizing the NACTO Urban Street Design Guide
 - Applying the Highway Safety Manual

Key Elements: Multimodal, Safety, Urban Form, Environment, Freight Movement, Economic Vitality, and Implementation

Recent National Funding Acts

Funding that considers:

- Multimodal,
- Safety,
- Urban Form,
- Environment,
- Freight Movement,
- Economic Vitality, and
- Implementation

Supports metrics such as:

- Livability,
- Heritage,
- Historical context,
- Community values,
- Right-sized projects,
- Practical solutions, and
- Other softer metrics

...These soft metrics are fueling flexible design demands

....Performance-based approaches provide the means for us to adapt to our contemporary project needs.

Presentation overview

- Introduction and Key Objectives
- Historical Overview of Highway Geometric Design
- **AASHTO and TRB Strategic Research Objectives**
 - Hermanus Steyn
- NCHRP Report 785 Overview and Application
- NCHRP Report 839 Overview
- Questions and Discussion

AASHTO and TRB Strategic Research Objectives

- Research projects originate with purpose and planning
- TRB and AASHTO collaboration creates projects that meet the needs of transportation professionals nation-wide.
- Two topics were generated back in 2004.
 - NCHRP Report 785 was meant as the first step to advance the practice
 - NCHRP Report 839 was a longer term perspective to look at a new start
 - TRB led the research needs statement development with AASHTO input. AASHTO funded the research.

Research Topic Development Timeline

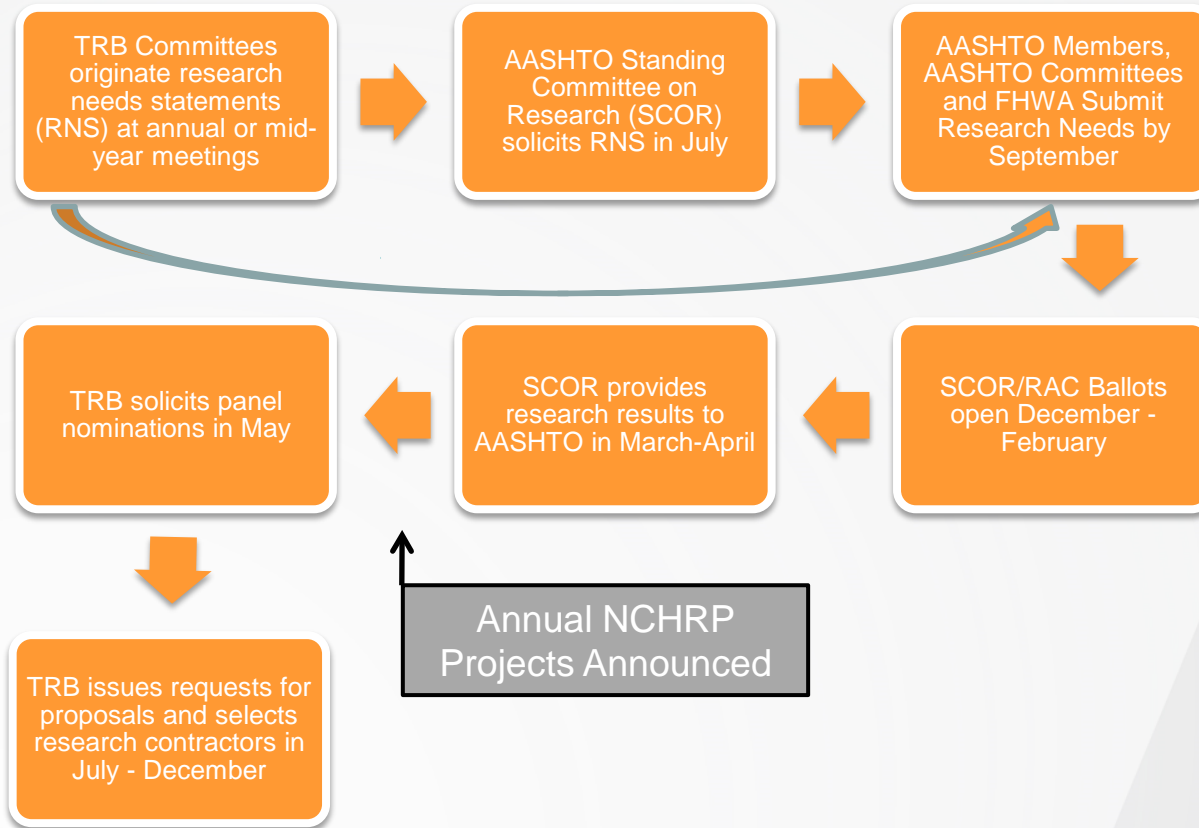

- **AASHTO/TRB meet regularly**

Presentation overview

- Introduction and Key Objectives
- Historical Overview of Highway Geometric Design
- AASHTO and TRB Strategic Research Objectives
- **NCHRP Report 785 Overview and Application**
 - Julia Knudsen
- NCHRP Report 839 Overview
- Questions and Discussion

NCHRP Report 785

- Chapter 1 – Introduction
- Chapter 2 – Overview
- Chapter 3 – Identify Project Outcomes
- Chapter 4 – Geometric Design Elements
- Chapter 5 – Process Framework
- Chapter 6 – Project Examples

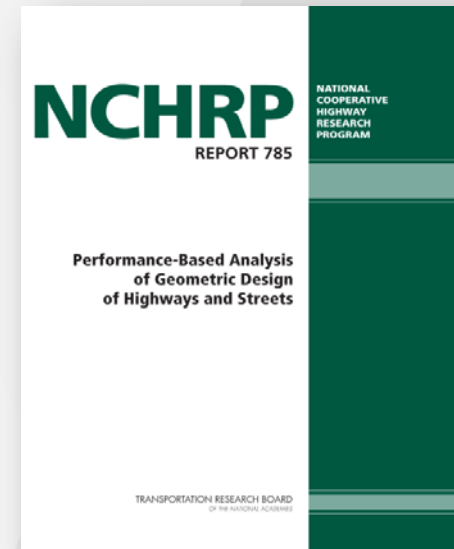

NCHRP Report 785 Model

- Fundamental model of the approach

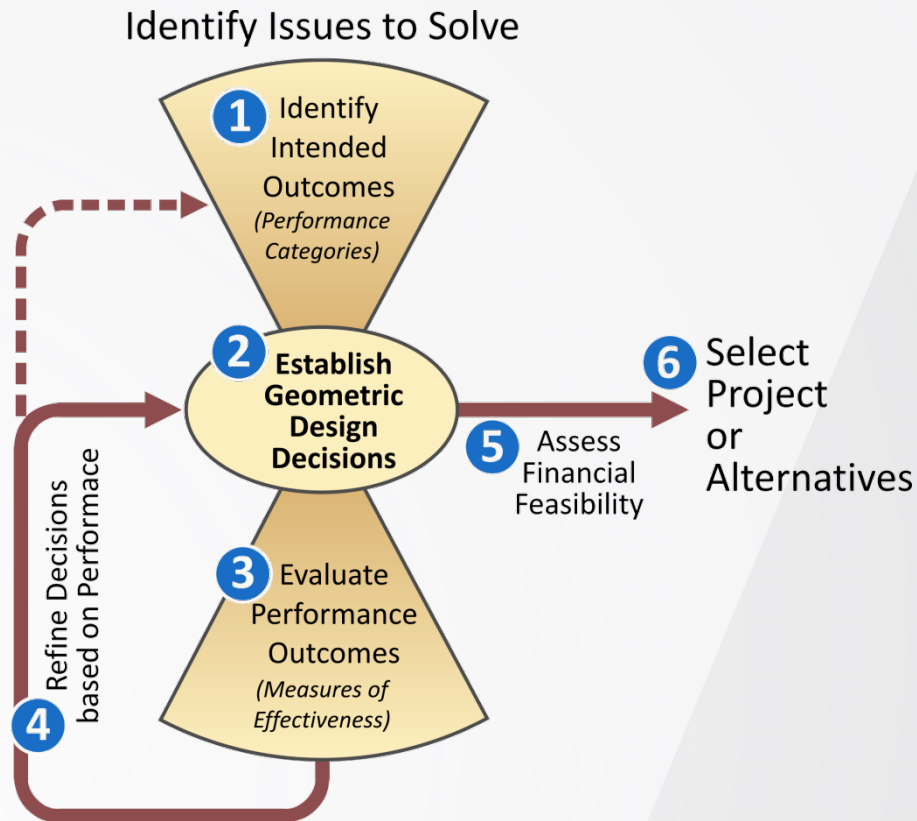

NCHRP Report 785

- Overview of geometric design decisions

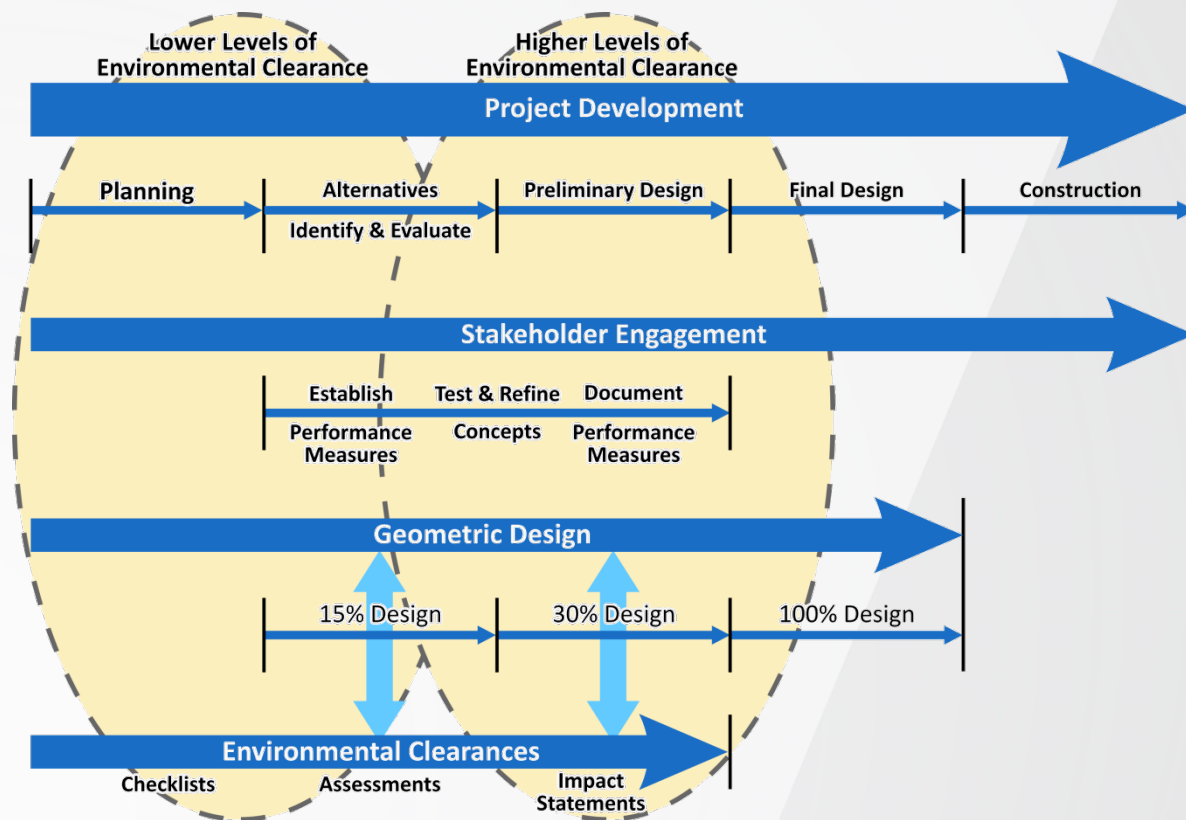

NCHRP Report 785

- Relationship between project-level and performance measures

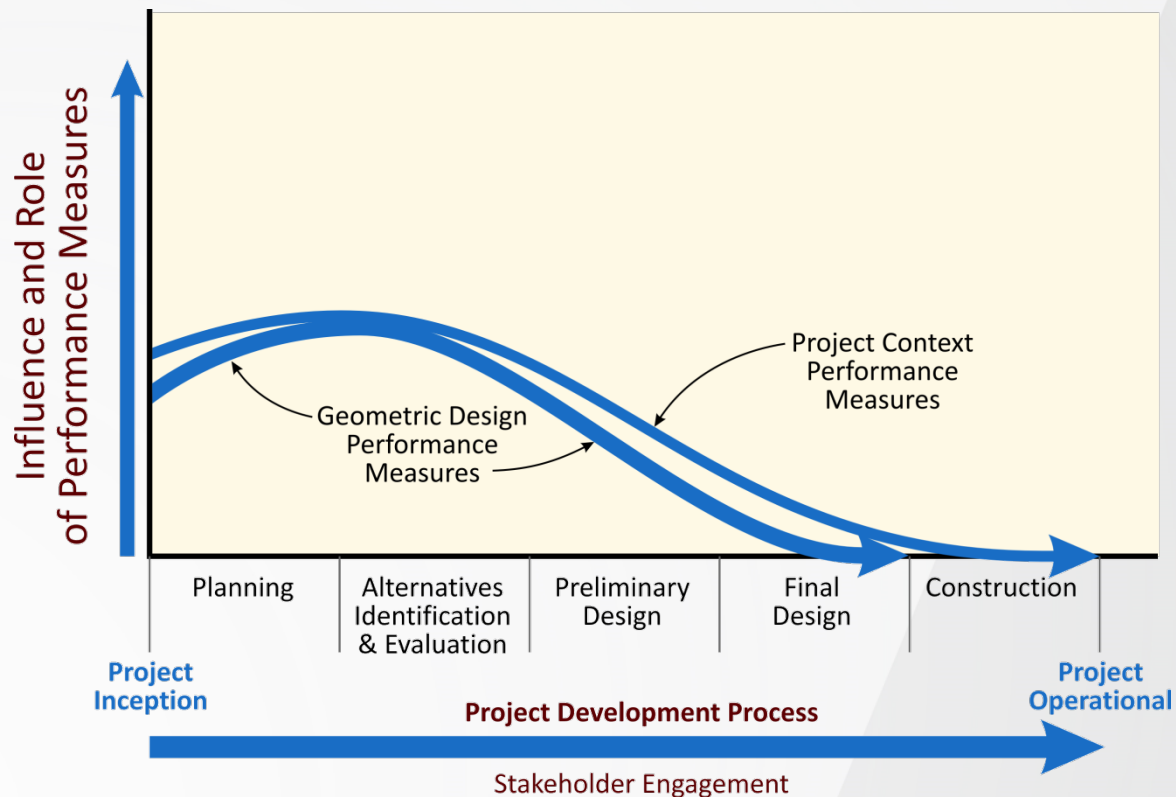

Chapter 3 – Identify Project Outcomes

- **Fundamentally: Whom are we serving?**
 - Whom are we serving?
 - Identifying the key road users and stakeholders for a given project and project context
 - What are we trying to achieve?
 - Identifying and articulating the core desired outcomes from the project

Establishing project context—Users and Performance

Chapter 3 – Identify Project Outcomes

■ Geometric Design Performance Categories

- Accessibility
 - Ability to approach a desired destination or potential opportunity for activity using highways and streets (including the sidewalks and/or bicycle lanes).
- Mobility
 - Ability to move various users efficiently from one place to another using highways and streets.
- Quality of Service
 - Perceived quality of travel by a road user.
- Reliability
 - Consistency of performance over a series of time periods.
- Safety
 - Expected frequency and severity of crashes occurring on highways and streets.

Chapter 3 – Identify Project Outcomes

■ Geometric Design Decisions

- Consider overall intended project outcomes, project performance, and transportation performance.
 - **How do the features influence performance measures related to accessibility, mobility, quality of service, reliability, and safety?**
- May have incremental and cumulative effects
- Discrete choices may impact broader concepts
 - **Sustainability, economic competitiveness, or livability**
- Identifying project design controls
 - **Leads to appropriate design criteria to meet those design control needs**

Chapter 4 – Geometric Design Elements

- **Introduction**

- Summarize critical or high priority known relationships between design elements and performance
- Document the general relationship
- Identify possibly performance trade-offs
- Present resources and tools that can be used

This information can be expanded with future research

Chapter 4 – Geometric Design Elements

- **Expected relationships between geometric design elements and performance categories**
 - Segments
 - Nodes – Intersections and Interchanges
-
- = expected direct effect
 - = expected indirect effect
 - = expected not to have an effect
 - * = relationship can be directly estimated by existing performance prediction tools
 - ◇ = relationship can be indirectly estimated using more than one existing tool
 - x = relationship cannot be estimated by existing tools

Segment Geometric Elements/Characteristics	Accessibility	Mobility	Quality of Service	Reliability	Safety
Access points and density	●*	●*	●*	□ [∅]	●*
Design speed and target speed	--	□ [∅]	□ [∅]	□ [∅]	□*
Horizontal alignment	--	● [∅]	● [∅]	□ [∅]	●*
Number of travel lanes	●*	●*	●*	□*	●*
Sidewalk and pedestrian facilities	●	●*	●*	□ ^x	● ^x
Bicycle accommodation features	●	●*	●*	□ ^x	● ^x
Median provisions	● [∅]	●*	●*	□ [∅]	●*
Travel lane width(s)	● [∅]	●*	●*	□*	●*
Auxiliary lane width(s)	● ^x	● ^x	● ^x	□ ^x	● ^x
Type and location of auxiliary lanes	● [∅]	●*	●*	□ [∅]	●*
Shoulder width(s) and composition	● [∅]	●*	●*	□*	●*
Shoulder type(s)	● [∅]	● ^x	● ^x	□ [∅]	●*
Lane & shoulder cross slopes	--	--	--	□ ^x	● ^x
Superelevation	--	● ^x	● ^x	□ [∅]	●*
Roadside design features	● ^x	● ^x	● ^x	□ ^x	●*
Roadside barriers	● [∅]	●*	●*	□ [∅]	●*
Minimum horizontal clearances	● [∅]	●*	●*	□ [∅]	●*
Minimum sight distance	● ^x	● ^x	● ^x	□ ^x	● ^x
Maximum grade(s)	□ [∅]	□*	□*	□ [∅]	□*
Minimum vertical clearances	● [∅]	□ ^x	□ ^x	□ ^x	□ ^x
Vertical alignment(s)	--	●*	●*	□*	●*
Bridge cross section	● [∅]	●*	●*	□*	●*
Bridge length/ termini	--	--	--	□ [∅]	●*
Rumble strips	● [∅]	--	--	□ ^x	●*

Chapter 4 – Geometric Design Elements

- **Tables summarize the design elements/decisions and their relationship to performance measures from each of the transportation performance categories:**
 - Accessibility
 - Mobility
 - Quality of Service
 - Reliability
 - Safety

For example: Accessibility

Chapter 4 – Geometric Design Elements *Accessibility*

Facility Type	Performance Measure	Definition	Geometric Design Elements	Basic Relationship	Potential Performance Tradeoffs
Segment	Driveway Density	Number of driveways per mile	Access points and density	Higher density of driveways associated with higher motor vehicle access	Degrade bicycle LOS, Increase crash likelihood, Increase average travel speed
Urban/ Suburban Segment	Transit stop spacing	Distance between transit stops along a roadway segment	Transit accommodation features	Higher frequency increases access for transit riders	Increases transit travel time and may degrade mobility for other vehicle modes
Segment	Presence of Pedestrian Facility	Presence of a sidewalk, multiuse path or shoulder	Sidewalk and pedestrian facilities	Greater connectivity and continuity of pedestrian network increases access for pedestrians	Implementing pedestrian facilities in a constrained environment may require removing capacity or parking for vehicle mode
Segment	Presence of Bicycle Facility	Presence of bicycle lanes, multiuse path, or shoulder	Bicycle accommodation features	Greater connectivity and continuity of bicycle network increases access for bicyclists	Implementing bicycle facilities in a constrained environment may require removing capacity or parking for vehicle mode

Chapter 5 – Process Framework

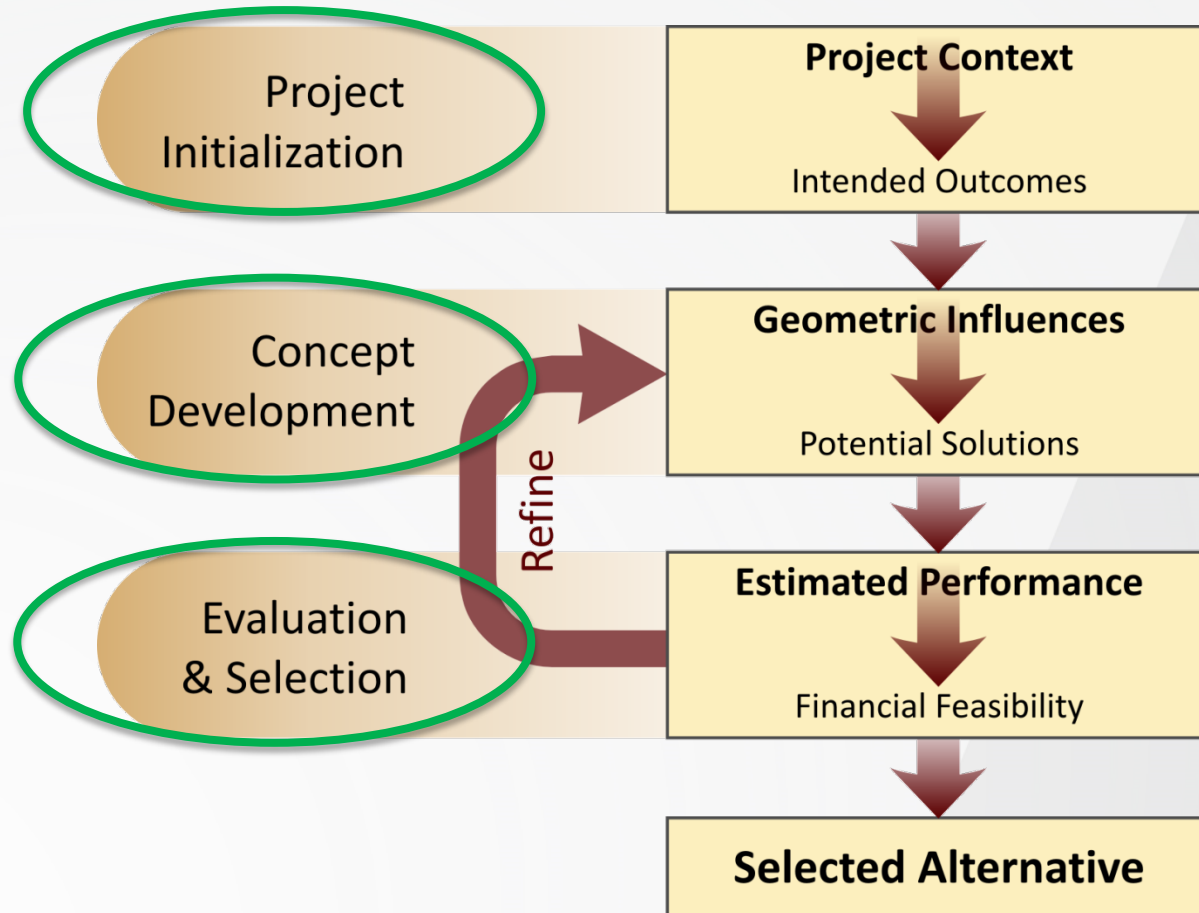

Chapter 5 – Process Framework

■ Project Initiation

– Project Context

- Existing site constraints
- Current performance
- Surrounding land uses
- Planned improvements
- Anticipated form and function

– Intended Outcomes

- Clarity of the characteristics defining the current and desired future of the site;
- A clear and concise understanding of the primary project purpose; and
- A set of performance measures to be used to evaluate a design's impact on the desired project purpose.

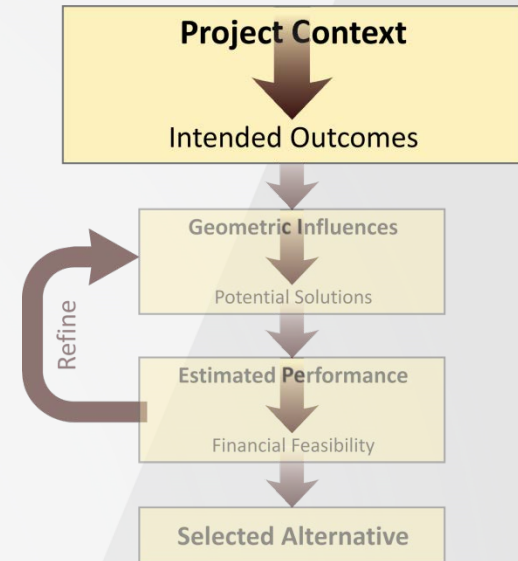

Chapter 5 – Process Framework

■ Concept Development

- Geometric Influences
 - Identify the geometric characteristics that influence a project's performance
 - Identify the geometric characteristics or decisions influenced by the desired performance of a project.
- Potential Solutions – specific awareness of the:
 - Project context
 - Intended outcomes
 - Geometric characteristics and decisions

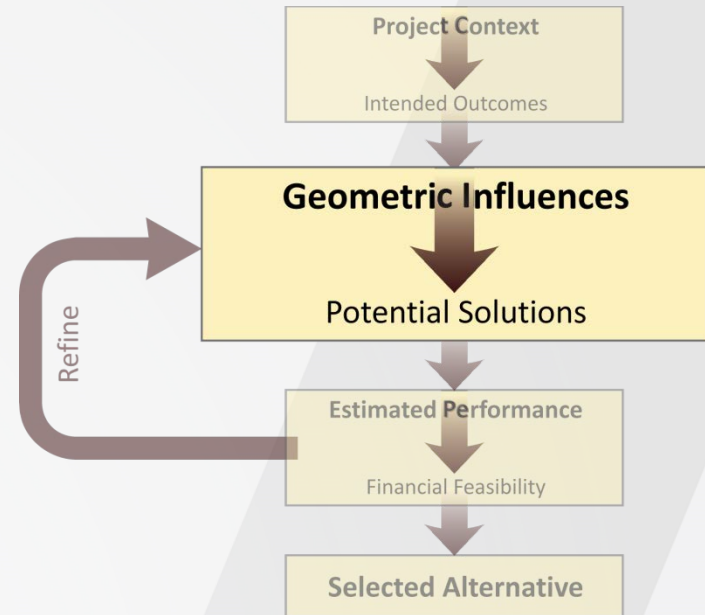

Chapter 5 – Process Framework

- **Evaluation and Selection**
 - Estimated Project Performance
 - **Selecting the evaluation resource**
 - For the stage in the project development process.
 - Applicable to the project context
 - Financial Feasibility
 - **Total construction and maintenance cost**
 - **Cost effectiveness**
 - **Benefit/Cost ratio (B/C ratio)**
 - Interpreting Results
 - **Estimated Project Performance**
 - **Financial Feasibility**

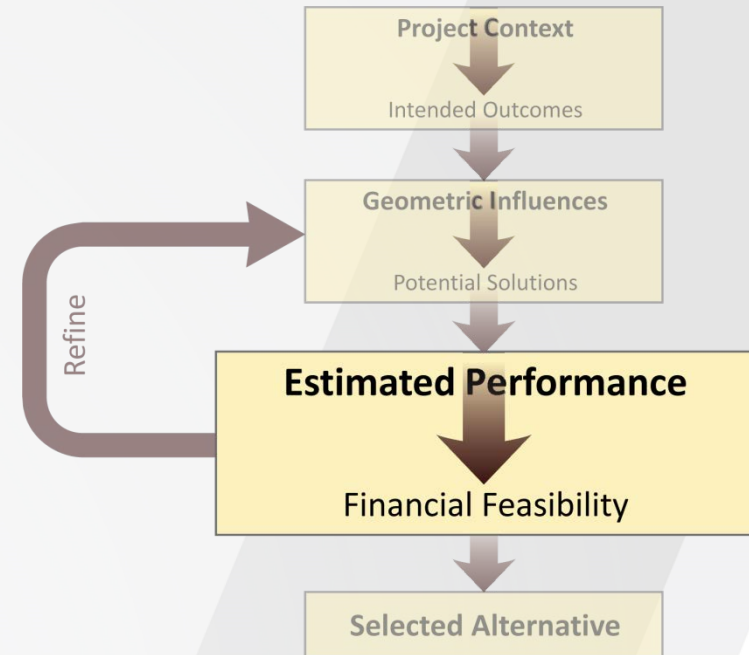

Chapter 5 – Process Framework

■ Selection

- Are the performance evaluation results making progress towards the intended project outcomes?
- Do the alternatives serve the target audience and achieve the desired objectives?
- Are there reasonable adjustments that can be made to the geometric design elements most significantly influencing project performance?
- Do the performance measures help differentiate between the alternatives?

■ Environmental Review Process

- Environmental checklists, assessments and impact statements

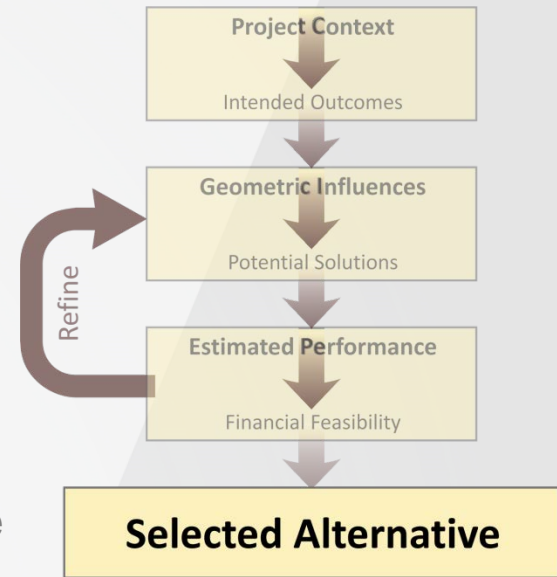

Cha

Site - Area and Facility Type	Project Development Stage	Performance Categories	Project Type
US 21/Sanderson Road - Rural Collector (Two-Lane Highway)	Alternatives Identification and Evaluation	Safety	Intersection – Consider alternative intersection control to improve safety.

Example#	Site - Area and Facility Type	Project Development Stage	Performance Categories	Project Type
1	US 21/Sanderson Road - Rural Collector (Two-Lane Highway)	Alternatives Identification and Evaluation	Safety	Intersection – Consider alternative intersection control to improve safety.
2	Richter Pass Road - Rural Collector	Preliminary Design	Safety, Mobility	Segment – Consider alternative horizontal curve radii to improve safety while minimizing costs and maintaining appropriate speed.
3	Cascade Ave - Suburban/Urban Arterial	Preliminary Design	Safety, Mobility, Reliability, Accessibility, Quality of Service	Corridor – Retrofitting an existing auto-oriented urban arterial to incorporate complete street attributes. Focus on alternative street cross-sections.
4	SR 4 - Rural Collector	Preliminary Design	Safety, Reliability, Quality of Service	Segment – Consider alternative shoulder widths and sideslopes to minimize impact to an environmentally sensitive area.
5	27 th Avenue - Urban Minor Arterial	Alternatives Identification and Evaluation	Quality of Service, Safety, Accessibility	Segment – Alignment and cross-section considerations for new urban minor arterial being constructed to entice employers to a newly zoned industrial area.
6	US 6/Stonebrook Road - Rural Interchange	Alternatives Identification and Evaluation	Safety, Mobility	Interchange - Converting an at-grade intersection to a grade-separated interchange. Focus on selecting the appropriate interchange form and location.

Presentation overview

- Introduction and Key Objectives
- Historical Overview of Highway Geometric Design
- AASHTO and TRB Strategic Research Objectives
- **NCHRP Report 785 Overview and Application**
 - Hermanus Steyn
- NCHRP Report 839 Overview
- Questions and Discussion

NCHRP Report 785 - Applications

- **Montana Department of Transportation (MDT) Road Design Manual**
- **Project Approach**
 - Work collaboratively to generate design material that reflects current design research, updated project development processes, and best practices for road design
 - **Performance-Based Design**

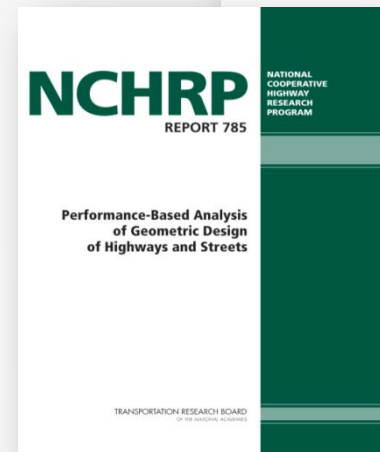
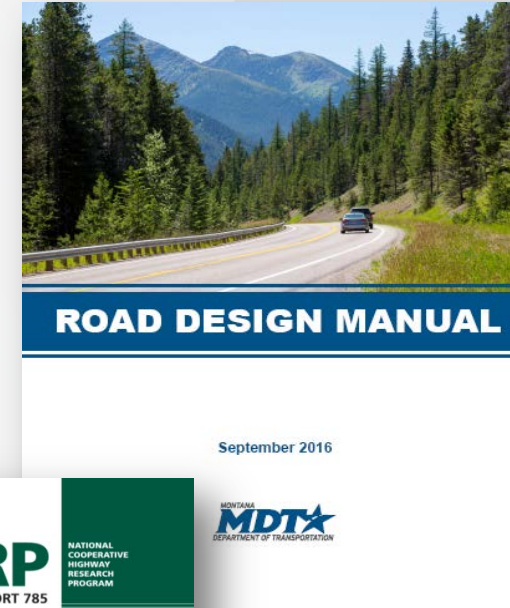

MDT Road Design Manual Chapter 1 – Road Design Guidelines and Procedures

- **Integrating performance-based design throughout manual**
 - Coordination with State DOTs, local agencies, and stakeholders
 - Road design principles
 - **Focus on performance vs. dimensions**
 - Using performance based-design approach to make informed decisions and understand tradeoffs
 - **Balance safety, design, and operations**
 - Working collaboratively to generate ideas and solutions
 - **Apply principles to accomplish the goal**

MDT Road Design Manual

- Chapter 1 – Road Design Guidelines and Procedures
 - Integrating a performance based design approach

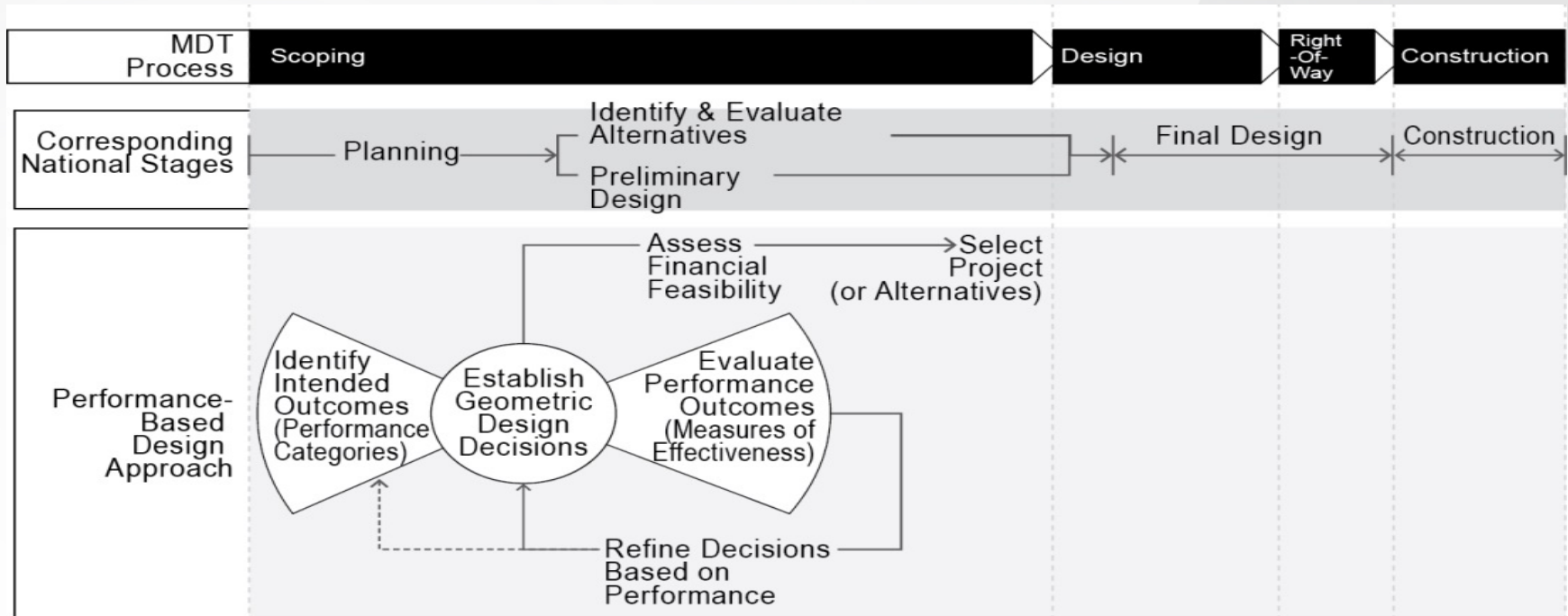

MDT Road Design Manual

- Author Notes in Margins through Manual referencing Performance-based Design
 - Excerpt from Chapter 3

**Chapter 1, Section 1.2
provides additional
information on applying
a performance-based
design approach.**

The *MDT Geometric Design Standards* provide the design team with design criteria for the horizontal design elements (1). The criteria provide a starting point for the design team to make a thoughtful evaluation of the project needs in consideration of the specific context. Design decisions may result in reasonable exceptions to the design criteria in order to meet the overall project purpose. A performance-based design framework can provide tools for making these decisions and design exceptions can help document these design choices.

NCHRP Report 785 - Applications

- Consistent with FHWA Performance-Based Practical Design (PBSD)
- FHWA PBSD Website
- <https://www.fhwa.dot.gov/design/pbsd/>
 - Overview
 - Fact Sheets
 - Case Studies
- FHWA Designing for Operations
 - Illustrative Examples
 - Complete Streets Examples
 - High-Occupancy Toll Lanes
 - Urban Freeway Reconstruction
 - Others

INTRODUCTION TO PERFORMANCE-BASED PRACTICAL DESIGN



FACT SHEET: #1

AUGUST 2015 • www.fhwa.dot.gov/Go9HRP2/

Performance-Based Practical Design (PBSD)

What is PBSD?
PBSD is a decision-making approach that helps agencies better manage transportation investments and serve system-level needs and performance priorities with limited resources. Building upon Context Sensitive Solutions, flexibility in design, Practical Design, Asset Management, and Value Engineering, PBSD helps agencies expand the focus from cost-saving, short-term solutions to improving and evaluating overall system performance.

How is PBSD Different?
The PBSD approach uses quantitative analyses to guide decision-making throughout the project development process. Advances in data collection technology have improved the availability and reliability of data. The use of such data is stressed in the data-driven performance measures in Moving Ahead for Progress in the 21st Century Act (MAP-21) legislation. Emerging growth of analysis tools using such data enables agencies to better evaluate projects within important program areas. As a result, the Federal Highway Administration (FHWA) encourages States to plan and develop projects with a system performance mindset. This is not new regulation, but rather a mindset that considers all roadway users, including pedestrians and bicyclists.

Operational and Safety Analysis Tools

ANALYSIS TOOLS	
Safety	Operational
Safety Analyst	Traffic Simulation
Highway Safety Manual	Highway Capacity Manual
Interactive Highway Safety Design Model	Integrated Corridor Management

Analysis is a key component of PBSD. Many projects include a stated or implied goal of improving operations or safety; however, the State or local agency does not always have enough data to know whether a proposed project would actually accomplish that goal or whether a completed project has achieved its stated purpose. The use of appropriate analysis tools, as shown in the table, will allow agencies to effectively evaluate and compare the performance of various alternatives.

PBSD Resources

FHWA embraces the PBSD approach and developed a team specifically designated to raise awareness of PBSD by supporting States interested in PBSD, promoting the use of existing design flexibility along with performance analysis tools, and developing and disseminating information. The best place to find PBSD information is on FHWA's website: <http://www.fhwa.dot.gov/design/pbsd/>. This website includes:

- A recorded webinar with a full overview of PBSD
- Case studies highlighting PBSD in action
- Links to design guides, reports, publications, and performance analysis tools
- Information about training and hosting a PBSD workshop
- Contact information for technical assistance in deploying PBSD

FHWA Contacts

Robert Mooney
202-368-2221
Robert.Mooney@dot.gov

George Merritt
404-852-3811
George.Merritt@dot.gov



US Department of Transportation
Federal Highway Administration

Presentation overview

- Introduction and Key Objectives
- Historical Overview of Highway Geometric Design
- AASHTO and TRB Strategic Research Objectives
- NCHRP Report 785 Overview
- **NCHRP Report 839 Overview**
 - Rich Coakley
- Questions and Discussion

Introduction to NCHRP 15-47 – NCHRP Report 839

A Performance Based Highway Geometric Design Process

The recommended geometric design process reflects an understanding of:

- History of highway design
- Growth in knowledge of design effects on roadway performance,
- Changes in emphasis and importance of road design and all road users
- Legal framework that shapes implementation of public infrastructure,
- Advances in technology that facilitate roadway design
- Growing and seemingly permanent condition of limited resources for
 - **Construction**
 - **Operation**
 - **Maintenance of roads**

Early Research Findings

Alternative Design Processes and Initiatives

Important Insights for the Design Process

	Complete Streets	CSS	Performance-Based Design	Practical Design	Design Matrix	Safe Systems	Travel Time Reliability	Value Engineering	Designing for 3R	Designing for VL/LR
Roads serve more than just motor vehicles	●	●								
Road design involves many different disciplines	●	●	●			●		●	○	
Context matters and it varies	●	●	○	○	●	○	○	○		●
Performance (operational, safety) is important		○	●	●	●	●	●	○		
Performance may have many dimensions	●	●	●	●	●		●	○	○	
Safety performance should focus on elimination or mitigation of severe crashes			○	○	○	●		○		○
Speed and crash severity are closely linked			●			●				
Existing roads with known problems are different from new roads				●	●				●	○
Traditional design approaches (full application of AASHTO criteria) are believed by professionals to yield suboptimal results	●	●		●	●			○		
Focusing on identifying and addressing the problem(s) should be central to developing design solutions	○	○	●	●	●		○	●	○	
Safety risk and cost-effectiveness are related to traffic volumes			●		●				○	●

The current mental model of designers –

‘Design Standards = Safety’

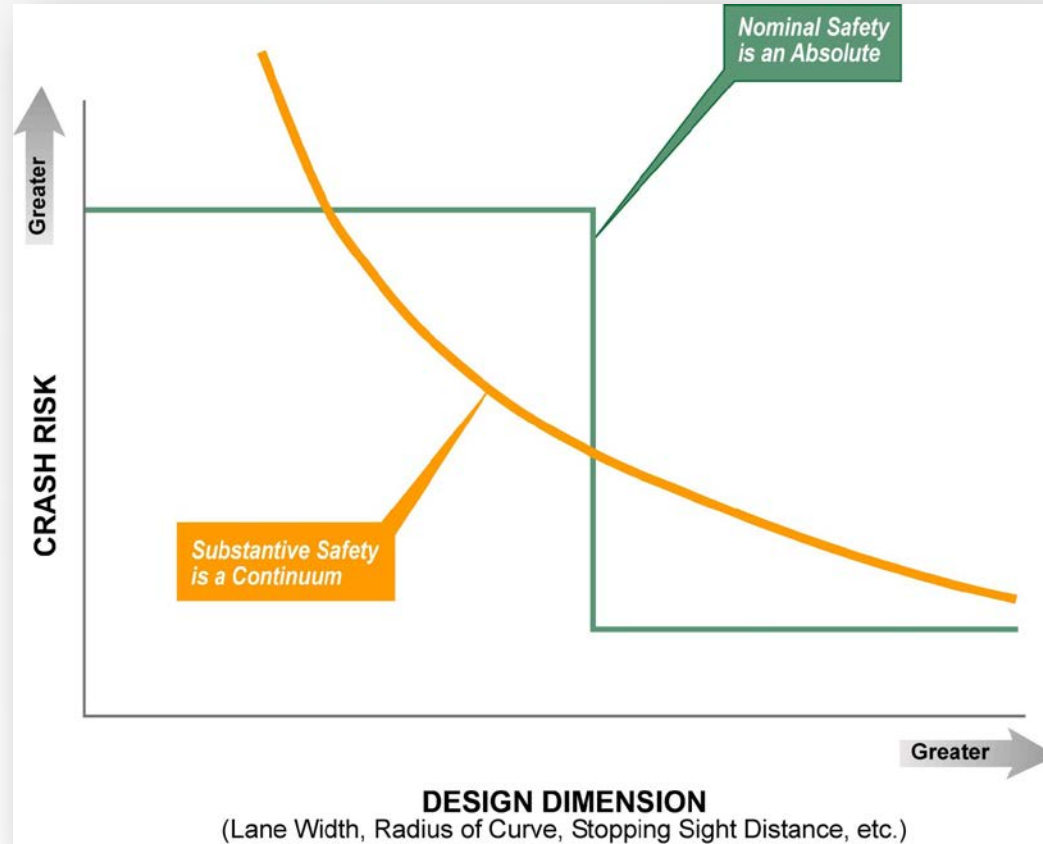

Fundamental Bases for Roadway Design

- Roadway design projects begin with a stated transportation problem. The purpose of geometric design is to provide the necessary three-dimensional framework for a facility to address the problem by providing the appropriate service to the users.
- Dimensional and other design standards and criteria are a means to an end. The end is transportation performance, such performance to include mobility, accessibility, safety, and state-of-good repair.
- Highway design criteria should be objectively related to one or more measures of transportation performance.

Solving objectively defined transportation problems is the reason for any and every project

Replacement of infrastructure in disrepair



Mobility or traffic operational problems; and accessibility



Safety problems (crash prevention and/or severity mitigation)



Design Standards and Problem Definition

- The presence of one or more geometric design features that fail to meet current design criteria is **NOT** a transportation problem...
- It is merely a condition of the context of a reconstruction or 3R project.

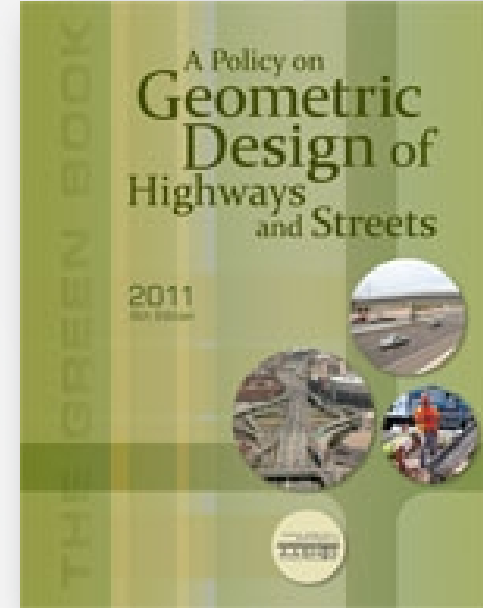

Design must consider needs of all legal roadway users

47



- **Vehicle types**
 - passenger cars
 - trucks (freight)
- **Buses and transit**
- **Non-motorized users**
 - pedestrians
 - bicyclists
 - disabled

Guiding Principles for an Updated Highway Design Process

■ Fundamental Bases

- Solutions Should Address Objective, Quantitative Measures of Transportation Performance
- Explicitly Address All Potential, Legal Road Users
- Integrate Operational Solutions with Geometric Elements
- Forward Looking
- Context Sensitive to the Extent Possible
- Financially Sustainable

■ Social and Public Policy Framework

- Accountability and Responsibility
- Legal Framework
- Support the Financial Sustainability of the Agency's Program

■ Necessary Attributes

- Efficiency
- Scalability
- Executable
- Transparency and Defensibility

Simplified Geometric Design Process

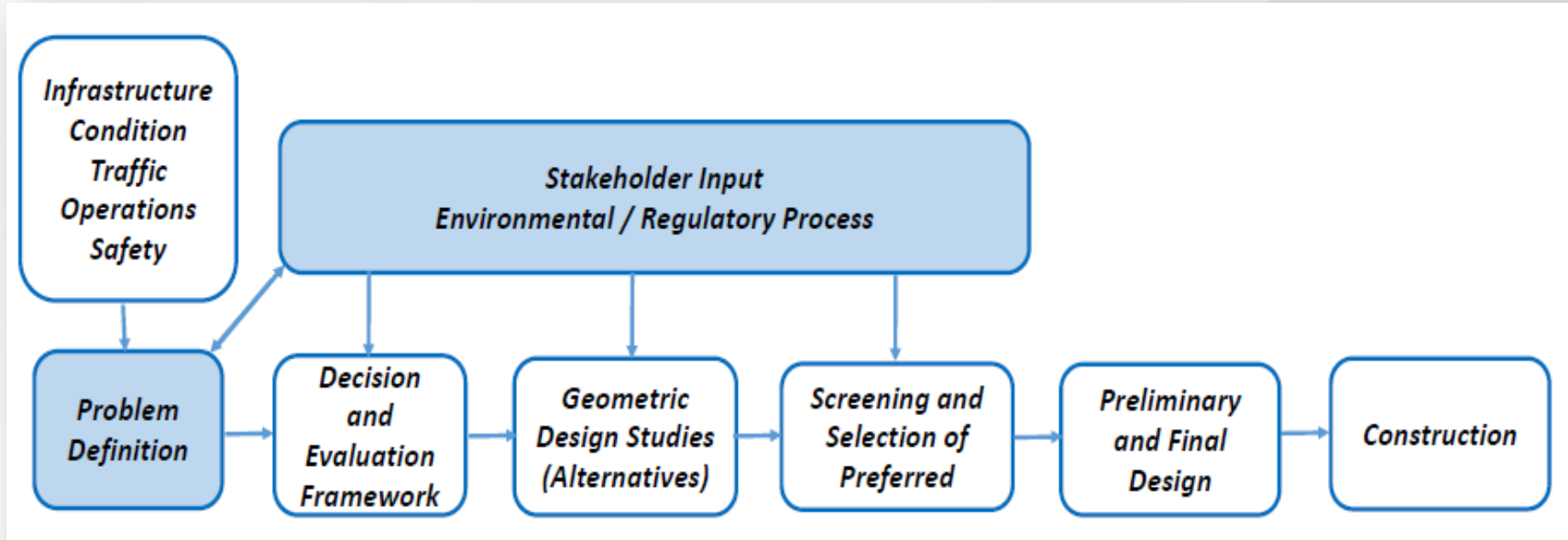

Performance-Based Highway Design Process

Step 1 - Define the Transportation Problem or Need

Step 2 – Identify and Charter Stakeholders

Step 3 - Develop the Project Scope

Step 4 - Determine Project Type and Design Development Parameters

Step 5 – Establish the Project Context and Geometric Design Framework

Step 6 – Apply the Appropriate Geometric Design Process and Framework

Performance-Based Highway Design Process - continued

52

Step 7 – Design the Geometric Alternatives

Step 8 – Design Decision-Making and Documentation

Step 9 – Transition to Preliminary and Final Engineering

***Step 10 – Agency Operations and Maintenance Database
Assembly***

***Step 11 - Monitoring and Feedback to Agency Processes
and Database***

Highway design does not occur in a vacuum – the ‘context’ matters... *and it varies considerably*



CSD_173_2

Roadway Context Zones

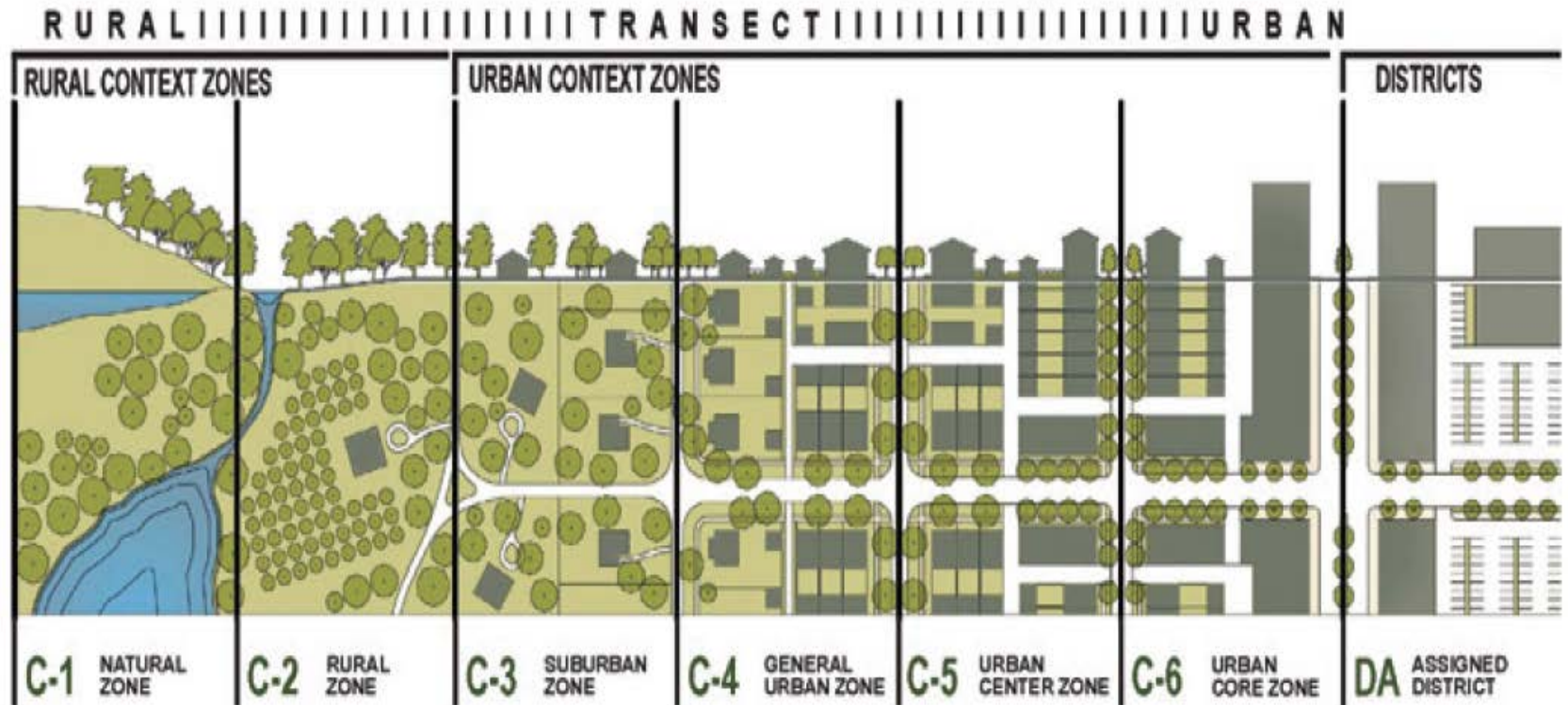

Typical or Critical Substantive Safety Issues Governing Geometric Design by Context

Roadway Type	Rural Natural Zone	Rural Zone	Suburban Zone	General Urban Zone	Urban Center Zone	Urban Core Zone
Local	Single-vehicle Run-off-road (low speed, low frequency)		Multi-vehicle Intersection and driveway-related; pedestrian and bicycle; low speed		Pedestrian -- intersections and mid-block	
Collector	Single-vehicle Run-off-road (high speed, higher frequency); multivehicle intersection-related		Multi-vehicle Intersection and driveway-related; median and access related		Pedestrian -- intersections and mid-block; multivehicle intersection-related	
Arterial	Single-vehicle Run-off-road; truck involved; merging and exiting (interchanges); cross median		Single-vehicle Run-off road; weaving, entering and exiting (interchange related)	Multi-vehicle weaving, entering and exiting; congestion-related rear-end and sideswipe		
Freeway						

Characteristics of Fatal and Injury Crashes by Context Zone

**Roadway Segments,
Context Zones 1 & 2,
Highway Safety Manual***

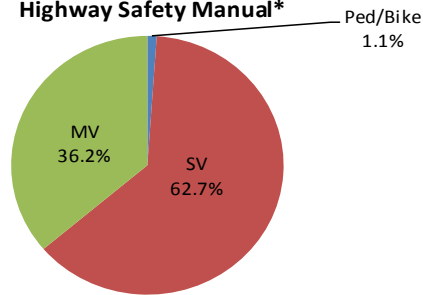

*Table 10-4. Default Distribution by Collision Type for Specific Crash Levels on Rural Two-Lane, Two-Way Roadway Segments (Total Fatal and Injury)

**Roadway Segments in Chicago,
Context Zones 4, 5 & 6**

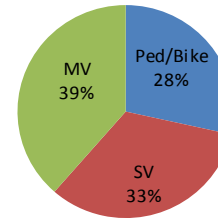

3,293 Severe Crashes on 8,666.5 Lane-Miles
K and A-Injury Crashes for Segments (2007-2009)

**Roadway Segments in Cook County (Chicago excluded),
Context Zones 3 & 4**

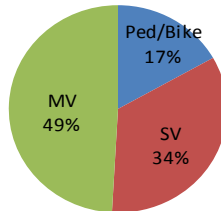

2,659 Severe Crashes on 17,563.5 Lane-Miles
K and A-Injury Crashes for Road Segments (2007-2009)

**Roadway Segments in Downtown Chicago,
Context Zone 6**

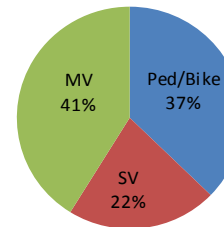

51 Severe Crashes on ~61.75 Lane-Miles
K and A-Injury Crashes for Segments in Chicago, Urban Core (2007-2009)

Typical or Critical Operational Issues Governing Geometric Design by Context

Roadway Type	Rural Natural Zone	Rural Zone	Suburban Zone	General Urban Zone	Urban Center Zone	Urban Core Zone
Local	Accessibility to adjacent land uses with minimal cost and environmental disruption		Access to land uses for motor vehicles and vulnerable users		Access to land uses by pedestrians, transit users and bicyclists; access for freight and goods delivery. Travel time reliability for transit buses and taxis; mobility for pedestrians	
Collector	Mobility and reliability of traffic service (travel time and travel time variance) for reasonable range of vehicle types		Mobility for full range of road users including motor vehicles, bicycles and pedestrians			
Arterial						
Freeway	Minimization and reliability of minimization of total costs of motor vehicle trips of all types (including especially freight), such costs to include both vehicle operating and travel time costs					

Basic Design Controls

- **Design Year Traffic**
- **Service Life Traffic**
- **Design or Target Speed**
- **Design Operating Conditions**
 - Design Level of Service
 - Travel Time Reliability
- **Road User Attributes**

Project Types and Transportation Problems

Project Type	Transportation Problem			
	Mobility	Access	Safety	State-of-good Repair
New Location	X	X		
3R				X
Reconstruction	X	X	X	X

New Construction vs reconstruction



New Construction

- Unknown Safety Performance
- Unknown Operational Performance
- Available R/W of Sufficient Width
- Minimal Impacts to Adjacent Development
- Construction Costs are Quantity Based

Reconstruction

- Known Crash History
- Known Operational Performance Known
- Limited R/W
- Adverse Impacts to Adjacent Development
- Maintenance of Traffic/Local Access Drive Construction Cost

Problem-based Unified Highway Design Process

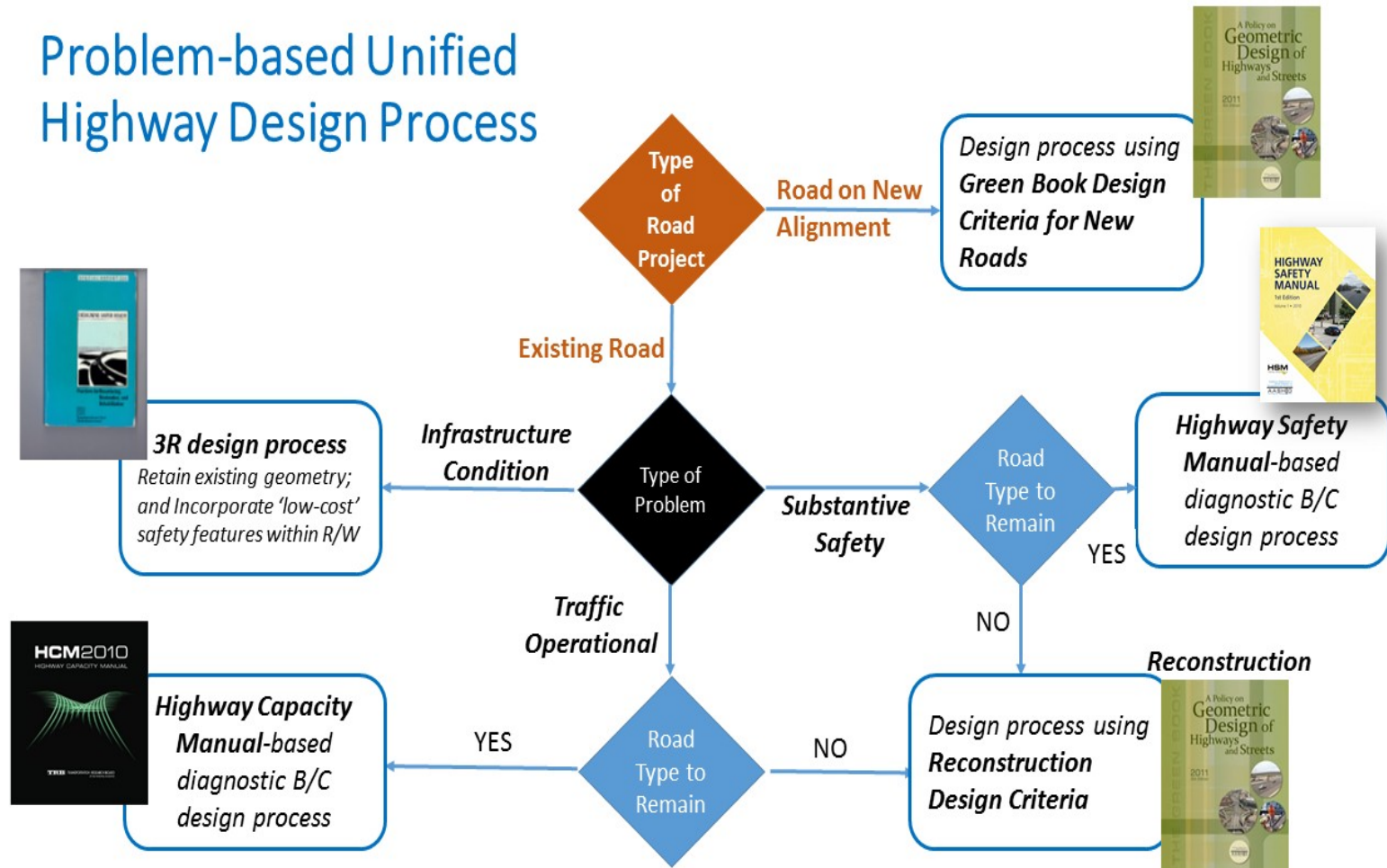

Strawman Framework for Design of Lane Widths for Road Types by Context

Roadway Type	Rural Natural Zone	Rural Zone	Suburban Zone	General Urban Zone	Urban Center Zone	Urban Core Zone
Local			10-ft minimum; additional width where bicycles are to be considered	10 to 11-ft widths; greater dimension where bicycles, on-street parking, bus and loading zones occur		
Collector			10- 12 ft; additional width where bicycles are to be considered	10 to 11-ft widths; greater dimension where bicycles, on-street parking, bus and loading zones occur		
Arterial			10- 12 ft; additional width where bicycles are to be considered	10 to 11-ft widths; greater dimension where bicycles, on-street parking, bus and loading zones occur		
Freeway			12-ft lane widths; full right shoulders	11 to 12-ft lanes; consider total width of shoulders and develop optimal solution given right-of-way, maintenance and performance analysis		

Comparison of four lane standard and five lane reduced width cross sections ⁶⁴

Alternative 1:

4 – 12 ft lanes with 10 ft right shoulders and 10 ft left shoulders

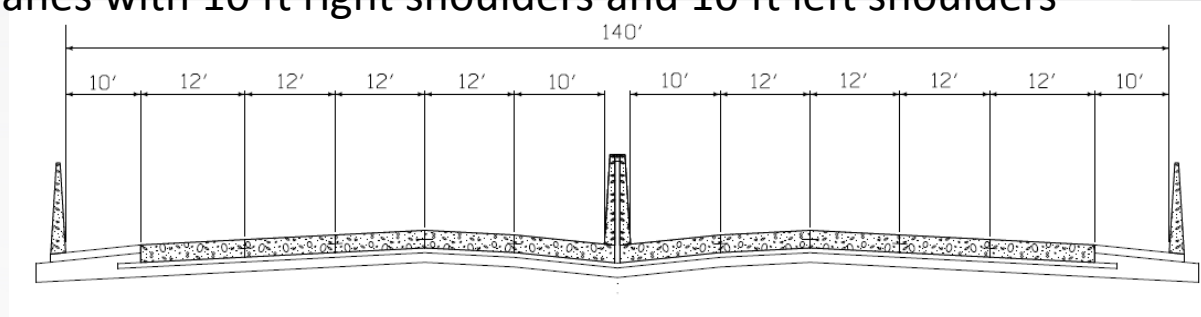

Alternative 2:

5 – 11 ft lanes with 10 ft right shoulders and 3 ft left shoulders

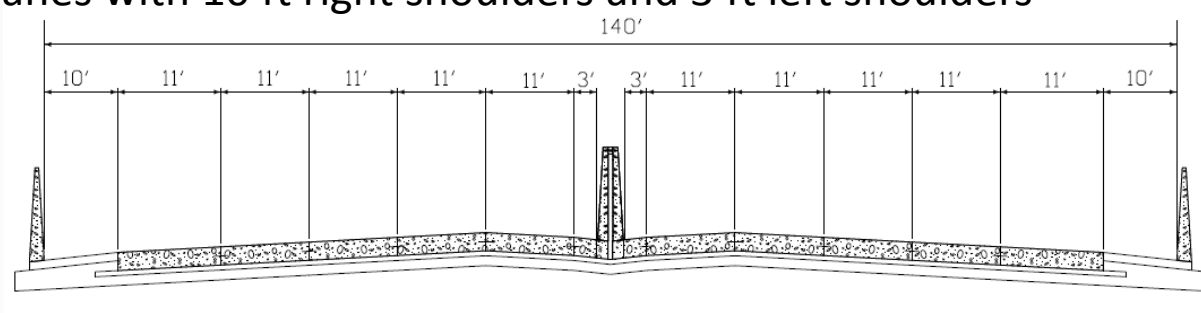

Comparison of four lane standard and five lane reduced width cross sections

Alternative	Capacity Analysis results		
	Level of Service	Density (pc/mi/ln)	Speed (mph)
1	F	61.3	43.7
2	E	35.5	60.5

LOS was determined using HCS 2010 Freeways Version 6.60

Alternative	Predicted Crashes per mile per year					
	Total	K	A	B	C	PDO
1	46.8	0.2	0.6	3.2	9.7	33.2
2	40.1	0.3	0.6	3.5	8.1	27.7

Predicted crashes were determined using ISATe (Build 6.10) (uncalibrated model without crash data input)

Functional Basis for Curve Design	Design Vehicle Assumption	Speed Input Assumptions	Potential Geometric Interactions	Comments	Research Issues
<i>Driver Comfort</i>	Passenger Car	Requires Design Speed Assumption	None	Current AASHTO approach; requires updated data and model	Replicate studies using current vehicles and drivers; or potentially use SHRP2 naturalistic driver database
<i>Vehicle Overturn Potential</i>	Single Unit or Semi-trailer	Requires Design Speed Assumption	Could be combined with grade	May be appropriate for Special purpose roads, loop ramps, or roads with high proportion of large vehicles (TBD)	Determine relationship of curvature to overturn risk
<i>Driver Loss of Control</i>	Passenger Car	Requires Design Speed Assumption	Could be combined with grade	Apply models of actual driver behavior through curves; establish margin of safety for range of pavement friction based on studies or agency policy	Apply models of vehicle path and speed behavior (validate and update); potentially use SHRP2 naturalistic database; collect pavement performance data
<i>Off-tracking of Critical Design Vehicle</i>	Semi-trailer or other long vehicle	None -- would by definition apply to low speed roads with minimal risk of severe crashes	Could be combined with roadway or lane width	May be appropriate for very low speed and/or low volume roadways	Develop radius and width for low speed turns based on AUTOTURN or other computer models
<i>Off-tracking at speed of Frequent Design Vehicle</i>	Bus, semi-trailer or single unit truck	None -- would by definition apply to moderate speed roads irrespective of speed	Could be combined with roadway or lane width	May be appropriate for collectors and urban arterials up to 40 to 45 mph	Confirm and validate insensitivity of horizontal curvature to crashes on urban and suburban arterials; Conduct field studies observing offtracking at moderate speeds
<i>Cost Effectiveness Analysis; Quantitative Safety and Operating Cost vs. Construction and Maintenance Cost</i>	None	None -- process tests incrementally larger radii curves for their quantitative benefits	Could be combined with shoulder width and roadside; automatically incorporates radius and length (or central angle)	May be appropriate for 2-lane highway reconstruction projects	Model operating costs (fuel consumption, wear and tear); incremental safety benefits using HSM models for various road types)
<i>Cost Effectiveness Analysis; Quantitative Safety and Operating Cost vs. Construction and Maintenance Cost; including effects of curvature on capacity and throughput</i>	None		Could be combined with shoulder width and roadside; automatically incorporates radius and length (or central angle)	May be appropriate for reconstruction of high volume urban freeways	Model operating costs (fuel consumption, wear and tear); incremental safety benefits using HSM models for various road types); study effects of curvature on capacity and include these

Strawman Framework for Design of Horizontal Curvature for Road Types by Context

Strawman' Framework for Design of Horizontal Curvature for Road Types by Context						
Roadway Type	Rural Natural Zone	Rural Zone	Suburban Zone	General Urban Zone	Urban Center Zone	Urban Core Zone
Local	Based on off-tracking requirements of larger design vehicles (nominal DS = 20 to 30 mph) or loss of control from skidding (DS = 40 mph)		Based on loss of control from skidding	Based on off-tracking requirements of typical large vehicles (perhaps vary by road type and context zone) at very low speeds; urban buses, single unit trucks, semi-trailers		
Collector	Based on loss of control from skidding					
Arterial	Based on volume-sensitive, cost-effective design criteria derived from safety performance, operating cost; and infrastructure life-cycle cost; include interactive effects of grade as appropriate		Based on loss of control from skidding	Based on off-tracking requirements of typical large vehicles (perhaps vary by road type and context zone) at moderate speeds		
Freeway			Based on volume-sensitive, cost-effective design criteria derived from safety performance, operating cost, and throughput/capacity; and infrastructure life-cycle cost; include interactive effects of grade; include consideration of decision or stopping sight distance limited by horizontal			

Predicted Changes in Annual Crashes for Changes in Radius

Change in Radius of Curve	Predicted Annual Crashes for Central Angle of 45 Degrees		
	4000 vpd	7000 vpd	10,000 vpd
500 to 1000	0.06	0.104	0.149
500 to 1500	0.038	0.144	0.206
500 to 2000	0.096	0.168	0.240
1000 to 2000	0.036	0.064	0.091
1000 to 3000	0.054	0.095	0.136

Transition in skills, knowledge and approach

- The 'old model' geometric designer
 - Understands basics of vehicle-centric AASHTO models
 - Applying the policy and standards to produce a solution that fully meets criteria
 - Calculation of alignment
 - Balancing of earthwork
 - Detailing of construction plans
 - Compiling quantities for contract documents
- The 'new model' geometric designer
 - Engaging multiple stakeholders (some non-technical)
 - Proficient in application of tools, models and evaluation methods for operational and safety effects of design (HCM, HSM, IHSDM)
 - Always testing multiple alternatives
 - Able to design in range of speed and land-use contexts
 - Fully knowledgeable in environmental regulations, laws, and processes
 - Applying multi-attribute decision models
 - Knowledgeable in economic analysis; B/C principles

GUIDELINES for GEOMETRIC DESIGN of LOW-VOLUME ROADS



More than 80% of the roads in the United States have traffic volumes of 2000 vehicles per day or less

Update of the *AASHTO Guidelines for Geometric Design of Very Low-Volume Local Roads*

The first edition published in 2001 addressed roads with traffic volumes of 400 vehicles per day or less

The second Edition is the *AASHTO Guidelines for Geometric Design of Low-Volume Roads*

For projects on existing roads, the second edition increases the traffic volume threshold to which the guidelines are applicable from 400 to 2,000 vehicles/day

Results of the survey:

- Approximately 40 percent of respondents supported expanding the guidelines to an AADT higher than 400 vehicles/day
- This support was generally from states that have substantial lower volume road networks
- Agencies that supported an increase in the AADT threshold were asked what that revised threshold should be:
 - responses ranged from 500 to 2,500 vehicles/day
 - the most common response was 1,000 vehicles/day

Definition of Terms

- The current guide defines a “very low-volume road” as having an AADT of 400 vehicles/day or less
- In the past, research has defined a “low-volume road” as having an AADT of 2,000 vehicles/day or less
- If we were to adopt a threshold between 400 and 2,000 vehicles/day, what term would be use for roads below that threshold that would not be confusing?

Existing Roads vs. New Construction

- For new construction, these guidelines apply for traffic volumes up to 400 vehicles/day;
- For new construction in the range of traffic volumes from 400 to 2,000 vehicles/day, normal Green Book design criteria apply
- For projects on existing roads, the guidelines apply for traffic volumes up to 2,000 vehicles/day

Relevant material from these documents referenced in the Low-volume Road guidelines:

- 2004 and 2011 editions of the *AASHTO Green Book*
- Chapter 5 of the *Manual on Uniform Traffic Control Devices*
- *AASHTO Highway Safety Manual*
- *AASHTO Roadside Design Guide*
- *AASHTO Guidelines for Design, Operation, and Maintenance of Pedestrian Facilities*
- *AASHTO Guidelines for Development of Bicycle Facilities*
- U.S. Access Board *Public Rights-of-Way Guidelines*

Questions

Brian Ray, PE

bray@kittelson.com

Julia Knudsen, PE

jknudsen@kittelson.com

Hermanus Steyn, Pr.Eng., PE

hsteyn@kittelson.com

Richard Coakley, PE, PTOE

Richard.Coakley@CH2M.com