

**WESTCHESTER MODULAR HOMES, INC.**

AN EMPLOYEE OWNED COMPANY

# Product Catalog





# **WESTCHESTER MODULAR HOMES, INC.**

AN EMPLOYEE OWNED COMPANY

## Table of Contents

Page:

3	Shaw Carpet
5	Dal Tile
10	Fireplaces
14	400 Series Windows
21	200 Series Windows
24	Smooth Star Ext Doors
29	Fiber Classic Oak Ext Doors
31	Fiber Classic Mahogany Ext Doors
33	Classic Craft Fir Ext Doors
34	Exterior Door Hardware
37	Exterior Patio Doors
42	Sky lights
43	Light Fixture Packages
48	Recessed Lights
49	Central Vac System
51	Interior Masonite Doors
56	Interior Door Hardware
57	Interior Trim Options
59	Merillat Cabinets
88	Merillat Kitchen Upgrade Options
90	Laminate Countertop Options
95	Kitchen Sink Options
96	Delta Kitchen Faucet Options
98	Range Hoods
99	Whirlpool Appliances
101	Cultured Marble & Granite Vanity Options
106	Medicine Cabinets
107	Vanity Lights
108	Bath Vanity Layouts
110	Bath Fans
114	Delta Bath Faucet Options
116	Bath Accessories
119	Bath Fixture Options
120	Tub & Shower Options
124	Delta Tub/Shower Faucets
126	Jacuzzi Tubs
127	Delta Roman Tub Faucet Options/ Additional Bath Options
129	Exterior Siding Selections
136	Exterior Corner Posts
138	Shutters
139	TruDefinition Duration Shingles
142	Exterior Options



# Shaw Carpet®

## Your Choice 25 oz. (Standard) Solid & Tweed



00104 Cottage (Solid)



00152 Cascade (Solid)



00153 Abalone (Solid)



00550 Pewter Solid (Solid)



00700 Wood Bridge (Solid)



00701 Bungalow (Solid)



00702 Fawns Leap (Solid)



00754 Harbor Town (Solid)



00120 Ecru (Tweed)



00121 Almond (Tweed)



00521 Pewter Tweed (Tweed)

# Go Softly 34 oz. (Upgrade)

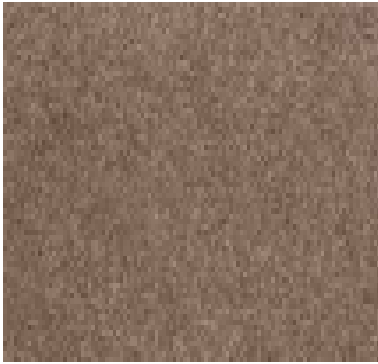

723 Iced Coffee



710 Kodiak Bear



701 Natural Wood



740 Pueblo



770 Riverbank



702 Travertine



730 Twig



722 Warm Oatmeal



250 Wheat



# Dal-Tile® (Upgrade)

## 12 X 12 Heathland



WHITE ROCK HL01



RAFFIA HL02



AMBER HL03



EDGEWOOD HL04



ASHLAND HL05\*



SAGE HL06\*

## 12 X 12 Skybridge



Off White SY95



Gray SY98



Beige SY96



Brown SY97

## 12 X 12 Avondale



Chateau Crème AD01



West Tower AD02



Castle Rock AD03

## 12 X 12 Esta Villa



Garden White EV97



Terrace Beige EV98



Cottage Brown EV99

## 12 X 12 Florentine



Carrara FL06



Marfil FL07



Argento FL08



Nociolla FL09

# 12 X 12 Affinity



Cream AF01



Beige AF02



Gray AF03



Brown AF04



# Grout Colors

## Available Colors



#38 - River Rock



#56 - Desert Khaki



#55 - Tawny



#59 - Espresso

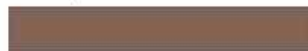

#46 - Quarry Red



#35 - Mocha

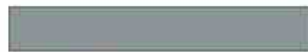

#91 - Slate Grey



#53 - Twilight Blue



#22 - Midnight Black



#85 - Almond



#27 - Hemp



#60 - Dusty Grey



#92 - Saitillo

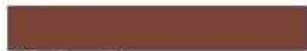

#58 - Terra Cotta



#67 - Autumn Green



#34 - Sandstone



#42 - Platinum

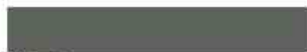

#45 - Raven



#44 - Bright White



#39 - Mushroom



#23 - Antique White



#40 - Latte



#43 - Chocolate Truffle



#66 - Chestnut Brown



#18 - Sauterne



#88 - Silver Shadow



#90 - Light Pewter



#78 - Sterling Silver



#57 - Hot Cocoa



#81 - Butter Cream



#17 - Marble Beige



#61 - Parchment



#30 - Sand Beige



#03 - Silk



#16 - Siltstone

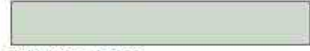

#50 - Sea Glass



#89 - Smoke Grey



#24 - Natural Grey



#41 - Kashmir



#52 - Toasted Almond



**WESTCHESTER MODULAR HOMES, INC.**  
AN EMPLOYEE OWNED COMPANY

# Fireplace, Mantle, & Surround Selections



Westchester Modular Homes, Inc.  
30 Reagans Mill Road  
Wingdale, NY 12594  
800-832-3888 + [WestchesterModular.com](http://WestchesterModular.com)

**heatilator**  
*The first name in fireplaces*

Rev. 12/17

# MANTLE OPTIONS



Kenwood

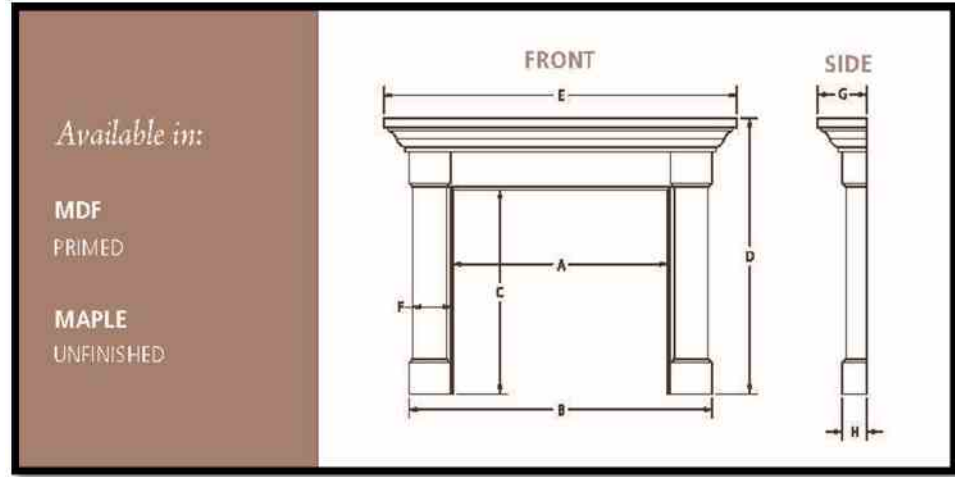

Kenwood (Without Base)	A OPENING WIDTH	B OUTSIDE WIDTH	C OPENING HEIGHT	D OUTSIDE HEIGHT	E TOP WIDTH	F LEG WIDTH	G SHELF DEPTH	H LEG DEPTH	I RECOMMENDED SET SIZE
A SIZE	44"	60"	36-1/2"	48-3/4"	69-1/2"	8"	9-3/4"	5"	6
B SIZE	48"	65"	39-1/2"	51-3/4"	74-1/2"	8"	9-3/4"	5"	1
C SIZE	53"	70"	42"	54-1/4"	79-1/2"	8"	9-3/4"	5"	1



Battlefield

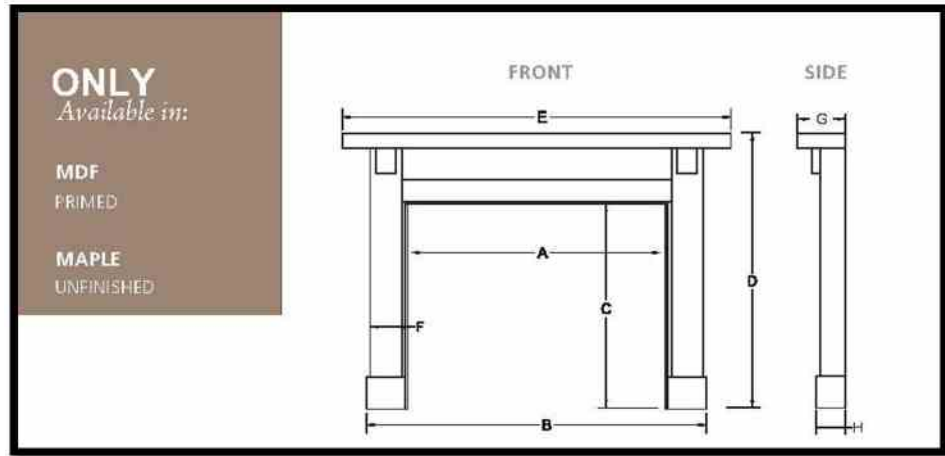

Battlefield	A OPENING WIDTH	B OUTSIDE WIDTH	C OPENING HEIGHT	D OUTSIDE HEIGHT	E TOP WIDTH	F LEG WIDTH	G SHELF DEPTH	H LEG DEPTH	I RECOMMENDED SET SIZE
B SIZE	48"	65"	39-1/2"	54"	75"	6-1/2"	9"	5-1/4"	1
C SIZE	53"	70"	42"	56-1/2"	80"	6-1/2"	9"	5-1/4"	1

# MANTLE OPTIONS



Acadia

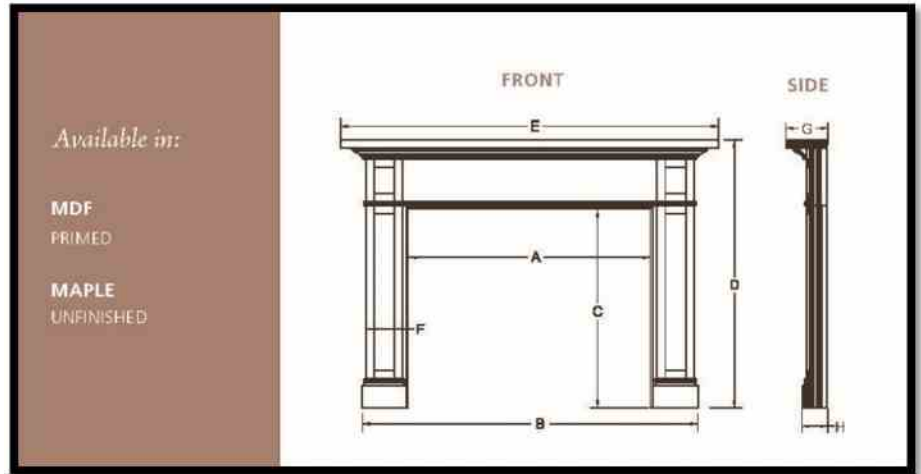

Acadia	A OPENING WIDTH	B OUTSIDE WIDTH	C OPENING HEIGHT	D OUTSIDE HEIGHT	E TOP WIDTH	F LEG WIDTH	G SHELF DEPTH	H LEG DEPTH	I RECOMMENDED SET SIZE
A SIZE	44"	61-1/2"	36-1/2"	49"	69"	6-3/4"	7-1/2"	3-3/4"	1
B SIZE	48"	65-1/2"	39-1/2"	52"	73"	6-3/4"	7-1/2"	3-3/4"	1
C SIZE	53"	70"	42"	54-1/2"	78"	6-3/4"	7-1/2"	3-3/4"	12

## Wood Species



MDF  
Primed



Maple  
Unfinished

## Stone Surround Options



Absolute Black



Caledonia Granite



New Venetian Granite



# Fireplace Rough Openings

## Accelerator

36" Wood Fireplace

MODEL	FRONT WIDTH		BACK WIDTH		HEIGHT		DEPTH		FIREPLACE OPENING
	Actual	Framing	Actual	Framing	Actual	Framing	Actual	Framing	
A36C/A36R	42	43	28-1/4	43	41-1/4	41-1/2	22-3/4	23	36 x 23-3/8

## Accelerator

42" Wood Fireplace

MODEL	FRONT WIDTH		BACK WIDTH		HEIGHT		DEPTH		FIREPLACE OPENING
	Actual	Framing	Actual	Framing	Actual	Framing	Actual	Framing	
A42C/A42R	48	49	30-7/8	49	41-1/4	41-1/2	22-3/4	23	42 x 23-3/8

## Novus

36" Direct Vent Gas Fireplace

MODEL	FRONT WIDTH		BACK WIDTH		HEIGHT		DEPTH		VIEWING AREA
	Actual	Framing	Actual	Framing	Actual	Framing	Actual	Framing	
NDV3630	35	36	8-5/8	36	35-1/4	34-7/8	19-1/8	19-5/8	30 x 22-5/8

## Novus

42" Direct Vent Gas Fireplace

MODEL	FRONT WIDTH		BACK WIDTH		HEIGHT		DEPTH		VIEWING AREA
	Actual	Framing	Actual	Framing	Actual	Framing	Actual	Framing	
NDV4236	41	42	14-5/8	42	35-1/4	34-7/8	19-1/8	19-5/8	36 x 22-5/8



**Modular Homes**

AN EMPLOYEE OWNED COMPANY

[westchestermodular.com](http://westchestermodular.com)

800-832-3888

# Andersen® 400 Series Windows (Standard)

- **White or Optional clear Pine interior**
- **Screens & “Snap-In” Grills are standard**
- **Six exterior optional colors**
- **Energy efficient**
- **Dual-layer, compressible bulb weather-stripping seals out dust, wind and water**



## Tilt-Wash Double Hung

Double-hung windows have two sash in a single frame which slide up or down to provide ventilation. Because their sash remain flush with the wall while the window is open, they are a good choice for placement adjacent to patios, decks and walkways. Our best-selling double-hung window, the Andersen® 400 Series tilt-wash double-hung window is extremely energy efficient and gives you a wide array of decorative and performance options, including Stormwatch® protection.



### Bow Window

Bow windows are window combinations that curve gradually and gracefully outside a home. These dramatic combinations can add space, volume and light to a room and add more personality to any home—inside and out. Andersen® 400 Series bow window units utilize all of the individual qualities of our casement windows.



### Angle Bay

Bay windows are window combinations that project outward from a home. These dramatic combinations can add space, volume and light to a room and add more personality to any home—inside and out. Andersen® 400 Series tilt-wash double-hung bay windows are extremely energy efficient and give you a wide array of decorative and performance options.



## Casement Windows

Casement windows are hinged on the side and open outward to the left or right, allowing you to catch breezes and direct the flow of fresh air into your home. Usually taller than they are wide, their entire sash opens to provide top-to-bottom ventilation. This also makes them a frequent choice for use as egress windows—ones that can be used as an emergency exit.

Andersen® 400 Series casement windows start with a design that is extremely energy efficient. Add to that a solid-wood sash covered inside and out by low maintenance Perma-Shield® cladding to protect against water damage. It's easy to see why they have become our best-selling casement window of all time.





## Awning Windows

Awning windows are hinged at the top and open outward. Usually wider than they are tall, their entire sash opens to provide full side-to-side ventilation, allowing them to catch breezes from any direction. They are often used above, below or alongside stationary windows to provide ventilation because, when open, their sash can function like a roof, providing a measure of shelter from light rain.

Andersen® 400 Series awning windows start with a design that is extremely energy efficient. Add to that a solid-wood sash covered inside and out by low maintenance Perma-Shield® cladding to protect against water damage. Then give them rich, natural pine interiors for windows that are as beautiful as they are functional and reliable.



## Picture Windows

Andersen® 400 Series complementary picture windows are rectangular and stationary (non-opening) windows characterized by their dramatic sizes. They can be used to provide singular points of light and architectural accents, or combined to create a signature statement



### Circle Top Windows

Andersen® 400 Series curved specialty windows are stationary (non-opening) windows characterized by their curved shapes. They can be used to provide singular points of light and delicate architectural accents, or combined to create a signature statement.



### Oval Windows

Andersen® 400 Series circle and oval specialty windows are stationary (non-opening) windows characterized by their special shapes. They can be used to provide singular points of light and delicate architectural accents, to create a signature statement.



### AFFW606 Curved Specialty Window

Andersen® 400 Series complementary curved specialty windows are stationary (non-opening) windows characterized by their curved shapes. They can be used to provide singular points of light and delicate architectural accents, or combined to create a signature statement.

## Andersen® 400 Series Exterior Window Colors

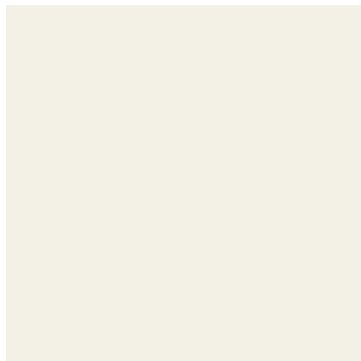

White (Standard)

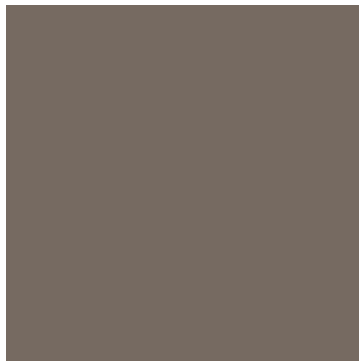

Terratone (Upgrade)



Sandtone (Upgrade)

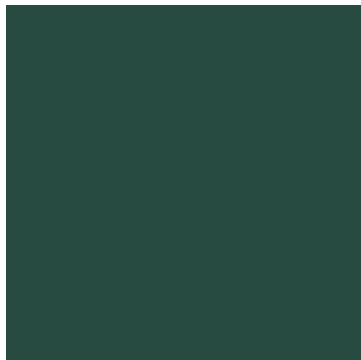

Forest Green (Upgrade)

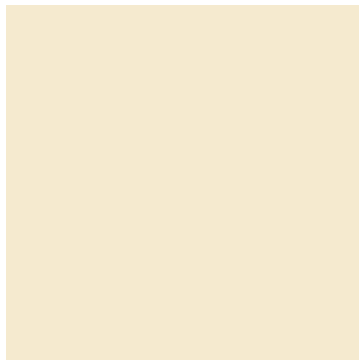

Canvas (Upgrade)



Dark Bronze (Upgrade)



Black (Upgrade)



# Andersen 200<sup>®</sup> Series Windows (Optional)

- **White or optional pine interior**
- **“Grills between glass” and screens are standard**
- **Available in best-selling sizes with most popular options**
- **Low-maintenance Perma-Shield<sup>®</sup> exteriors**



**Double Hung Window**

Double-hung windows have two sash in a single frame which slide up or down to provide ventilation. Because their sash remain flush with the wall while the window is open, they are a good choice for walls adjacent to patios, decks and walkways.

The Andersen<sup>®</sup> 200 Series tilt-wash double-hung windows feature low maintenance Perma-Shield<sup>®</sup> exteriors along with clear pine interiors to bring the warmth of natural wood into your home. Or, if you prefer, choose a factory-painted white interior with an ultra-smooth low maintenance finish. Either way, they come in our most popular sizes and give you our most requested options, along with our renowned Owner-2-Owner<sup>®</sup> warranty.

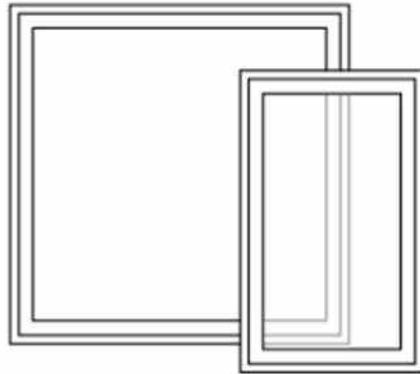

## Picture Windows

Picture windows are stationary, non-opening windows that allow light into the room. Andersen® 200 Series picture windows come with low-maintenance exteriors and real wood or prefinished white interiors along with the security of our renowned Owner-2-Owner® warranty.



## Circle Top Windows

Specialty windows are stationary windows characterized by their curved shapes. Andersen® 200 Series specialty windows are half-circle windows that can be used along with our double-hung windows to make a signature statement in your home and provide a delicate lighting accent.

# Andersen® 200 Series Exterior Window Colors

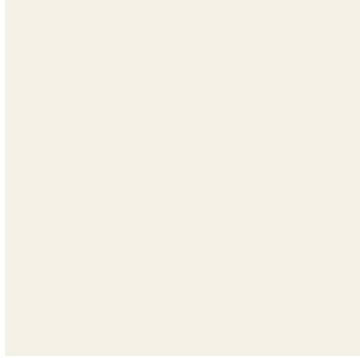

White (Standard)



Sandtone (Upgrade)

# Therma Tru® Smooth Star Entry Doors

STANDARD DOOR



S210



S255



S108



S118



S262



S960



S205



S770



S606



S296



S206

# Smooth Star 14" Sidelights



263SL (Standard)



210SL



308SL



100SL



606SL



# Fire Doors (6'-8" tall)



SE210HD



SE1005HD



SE514

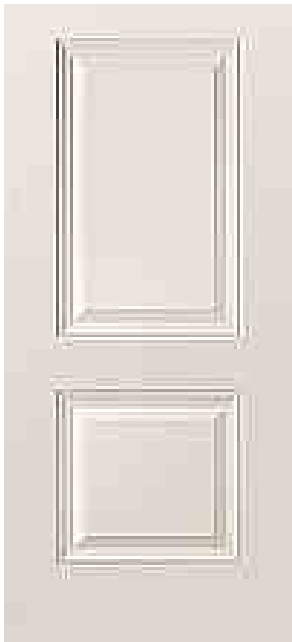

SE978HD

# Transoms (Optional)



19020T



19420T



19220T



19230T



19200T

Therma Tru®

Fiber Classic- Oak Entry Doors (Upgrade)  
(With clear glass)



FC60



FC65

## 14" Sidelights (Optional)



FC63SL



FC48SL



FC18SL



FC47SL

# Fiber Classic- Mahogany (Upgrade)



FCM60



FCM608



FCM65



FCM606 "Craftsman"

# 14" Sidelights (Optional)



FCM65SL



FCM62SL



FCM12102SL



FCM12101SL



# Therma Tru® Classic Craft- Fir



CCA230



CCA260

## 14" Classic Craft Fir Sidelights



CCA220SL



CCA210SL



CCA3400SL



CCA3450SL

# Schlage® Exterior Knobs & Levers



Satin Nickle (Standard)



Aged Bronzed (Upgrade)



Satin Nickle (Standard)



Aged Bronze (Upgrade)

## Schlage® Thumb Latch (Upgrade)



Plymouth Oil Rubbed Bronze



Plymouth Satin Nickel

# Therma-Tru® Multi-Point Locking Systems (Upgrade)

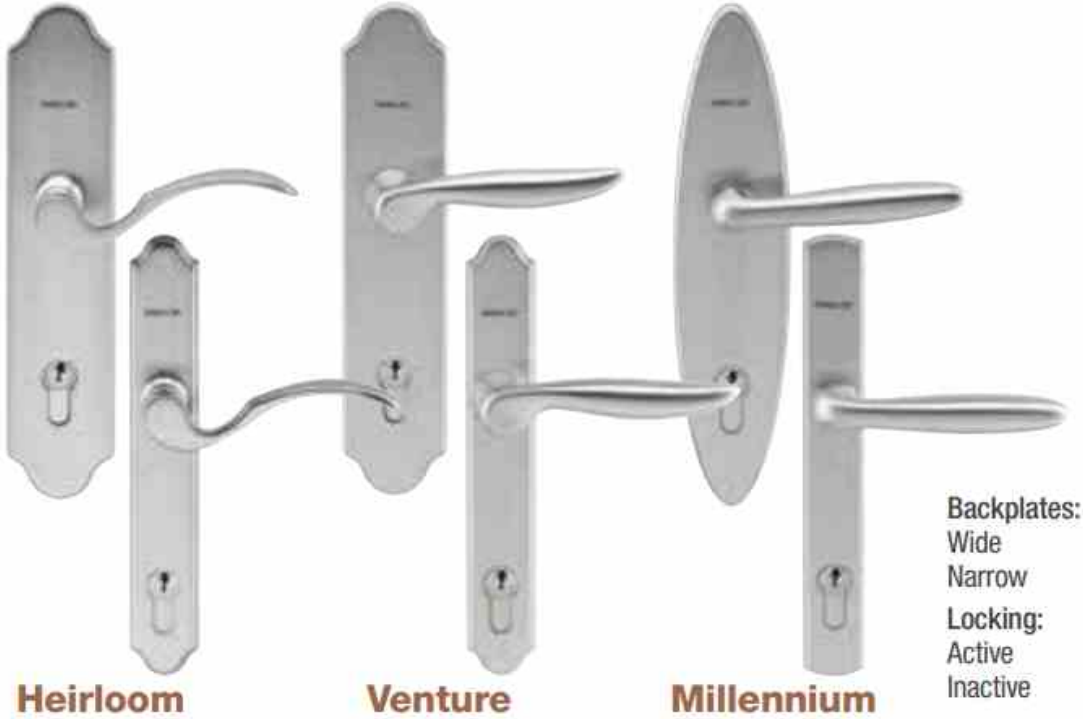

## Finish Options



## Exterior Patio Doors (Optional)

### Terrace Doors Therma-Tru® Smooth Star

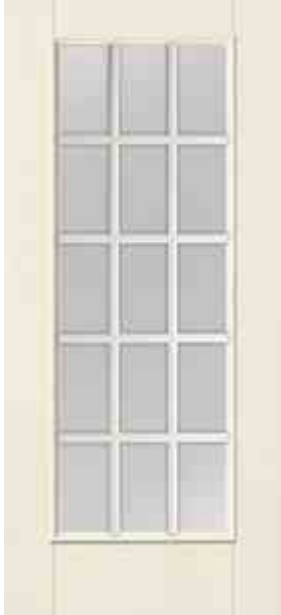

S108



S118

### Sliding Glass Doors Andersen® Perm-Shield



# Andersen® Perma-Shield Colors

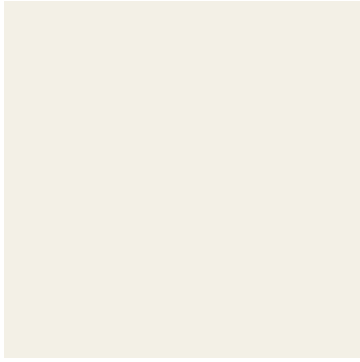

White



Terratone



Sandtone

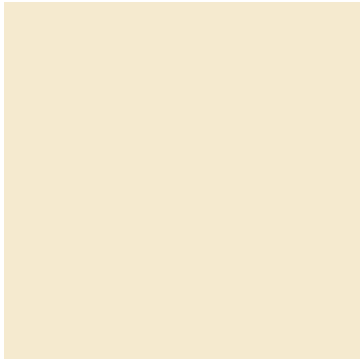

Canvas



Dark Bronze



## Andersen® Frenchwood Swing Doors



Grills (Optional)

## Andersen® Frenchwood Gliding Doors



Grills (Optionals)

# Andersen® Frenchwood Colors



White

Terratone

Sandtone

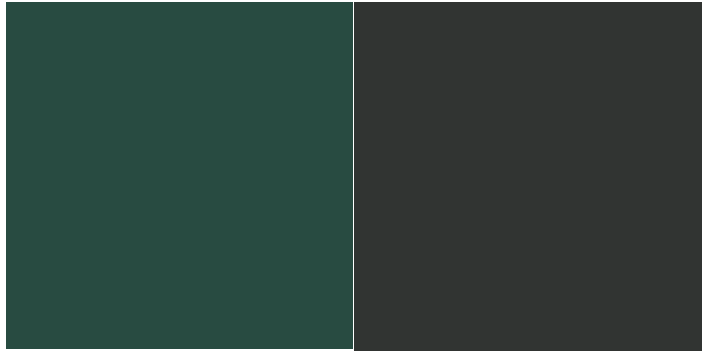

Forest Green

Black (Upgrade)

# Andersen® Frenchwood Hardware



Satin Nickel Finish  
Standard



Oil Rubbed Bronze  
Upgrade

# Andersen® Perma-Shield Hardware



White (Only) Standard

## Upgrade Hardware



Oil Rubbed Bronze



Satin Nickel

Skylights (Optional)  
Vented (VS C04)



Fixed Non-Vented (FS C04)



# Light Fixture Packages

## Holman Interior Collection

### Brushed Nickel



#### Dining Room

**31808-962**

Brushed Nickel Finish

Satin Etched Glass

D: 20" H: 12.5"

(5) Medium Base 60w Max

10' of wire pre-laced through 3' of chain



#### Foyer Two-Story Open

**5233-962**

Brushed Nickel Finish

D: 16.75" H: 29.75"

(6) Candelabra Base 60w Max

Clear Bulb Recommended

12' of wire pre-laced through 88" of chain



#### Breakfast Nook

**65806-962**

Brushed Nickel Finish

Satin Etched Glass

D: 15" H: 12.25"

(1) Medium Base 100w Max

10' of wire pre-laced through 3' of chain



#### Foyer - Hanging

**5231-962**

Brushed Nickel Finish

D: 9.5" H: 16"

(3) Candelabra Base 40w Max

Clear Bulb Recommended

12' of wire pre-laced through 4' of chain

# Holman Interior Collection

## Brushed Nickel



**Foyer - Flush / Optional Bedroom**  
**77064-962**

Brushed Nickel Finish  
Satin Etched Glass  
D: 13.25" H: 6.25"  
(2) Medium Base 60w Max



**Kitchen**  
**75943-15**

White Finish  
Alabaster Glass  
D: 15" H: 7"  
(3) Medium Base 60w max.

**Hall Closet**  
**5328-962**

Brushed Nickel Finish  
Smooth White Glass  
D: 9.5" H: 5.25" E: 5.25"  
(2) Medium Base 60w Max



**Optional Wall Sconce**  
**41036-999**

Brushed Nickel Finish  
Satin Etched Glass  
D: 8" H: 8.25" E: 4"  
(1) Medium Base 100w max.  
Meets ADA Requirements



**Optional Mini-Pendant**  
**61806-962**

Brushed Nickel Finish  
Satin Etched Glass  
D: 5.25" H: 6.56"  
(1) Medium Base 60w max.  
10' of wire, (3) 12" Stems, 12" Chain



# Holman Interior Collection

## Bell Metal Bronze



### Dining Room

**31808-827**

Bell Metal Bronze Finish

Satin Etched Glass

D: 20" H: 12.5"

(5) Medium Base 60w Max

10' of wire pre-laced through 3' of chain



### Foyer Two-Story Open

**5233-782**

Heirloom Bronze Finish

D: 16.75" H: 29.75"

(6) Candelabra Base 60w Max

Clear Bulb Recommended

12' of wire pre-laced through 88" of chain



### Breakfast Nook

**65806-827**

Bell Metal Bronze Finish

Satin Etched Glass

D: 15" H: 12.25"

(1) Medium Base 100w Max

10' of wire pre-laced through 3' of chain



### Foyer - Hanging

**5231-782**

Heirloom Bronze Finish

D: 9.5" H: 16"

(3) Candelabra Base 40w Max

Clear Bulb Recommended

12' of wire pre-laced through 4' of chain

# Holman Interior Collection

## Bell Metal Bronze



**Foyer - Flush / Optional Bedroom**  
**77064-782**

Heirloom Bronze Finish  
Satin Etched Glass  
D: 13.25" H: 6.25"  
(2) Medium Base 60w Max



**Kitchen**  
**75943-15**

White Finish  
Alabaster Glass  
D: 15" H: 7"  
(3) Medium Base 60w max.

**Hall Closet**  
**5328-782**

Heirloom Bronze Finish  
Smooth White Glass  
D: 9.5" H: 5.25" E: 5.25"  
(2) Medium Base 60w Max



**Optional Wall Sconce**  
**82006-782**

Heirloom Bronze Finish  
Satin Etched Glass  
D: 8" H: 8.25" E: 8"  
(1) Medium Base 60w Max  
Meets ADA Requirements



**Optional Mini-Pendant**  
**81808-817**

Heirloom Bronze Finish  
Satin Etched Glass  
D: 10.5" H: 10"  
(1) Medium Base 60w Max  
Meets ADA Requirements

# Jamestowne Exterior Collection

## Antique Bronze



### Exterior - Front

**8457-71**

Antique Bronze Finish

Clear Beveled Glass

W: 5.25" H: 12.5" E: 5.75"

(1) Medium Base 100w Max

Clear Bulb Recommended



### Exterior - Rear

**8592-71**

Antique Bronze Finish

Clear Glass

W: 4.25" H: 8.25" E: 5.5"

(1) Medium Base 100w max.

Clear Bulb Recommended

# Lancaster Exterior Collection

## Antique Bronze

## (Optional Upgrade)



### Upgrade Exterior - Front

**8039-71**

Antique Bronze Finish \*

Clear Beveled Glass

W: 10" H: 20.5" E: 9.5"

(2) Candelabra Base 40w Max

Clear Bulb Recommended



### Upgrade Exterior - Rear

**8037-71**

Antique Bronze Finish \*

Clear Beveled Glass

W: 7" H: 12" E: 7"

(1) Medium Base 100w max.

Clear Bulb Recommended

*\*Also available in  
brushed nickel  
(8039-965 &  
8037-965 respectively)*

# Recessed Lighting



"Generic" Snap-In

Standard

W: 7.625" H: 4.5"

Spring clips for easy installation (snaps to drywall)

IC Airtight Rating

Suitable for wet locations



Nicor DEB56

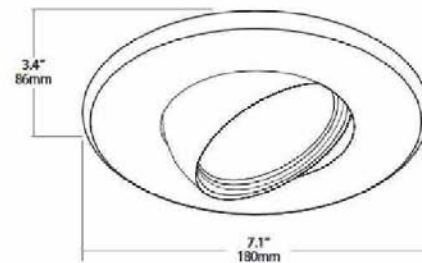

DLR56 and DEB56 fixtures to be installed in a recessed housing

Incandescent IC Airtight Housing  
Suitable for shower light

D: 5.625" L: 13.5" W: 8.875" H: 5.5"



# Central Vacuum System's (Optional)



Standard System PP500  
500 Watt Cyclonic Power Unit



Upgrade System PP600  
600 Watt Cyclonic Power Unit

# Central Vacuum Accessories (Included)



Turbine Brush 11" cleaning width



Deluxe Tool Set

# Interior Masonite® Doors

\* Offered in Hollow Core & Solid Core



6 Panel Hollow Core (Standard)



6 Panel Pine (Upgrade)

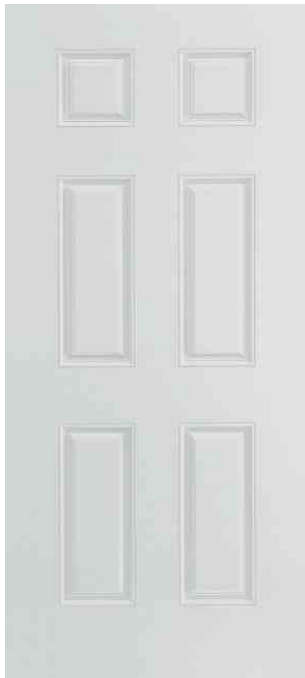

6 Panel Solid Core (Upgrade)



2 Panel Square (Upgrade)\*



Roman Style (Upgrade)\*



Cheyenne (Upgrade)\*



4 Panel (Upgrade)\*



# Masonite® Heritage Series Solid Core Doors (Upgrade)



Lincoln Park (1 Panel)



Logan (2 Panel)



Winslow (3 Panel)

# Interior French Doors (Upgrade)

Doors come primed white standard. Available in clear finish



3' 15 Light Door



4' 20 Light Double Doors

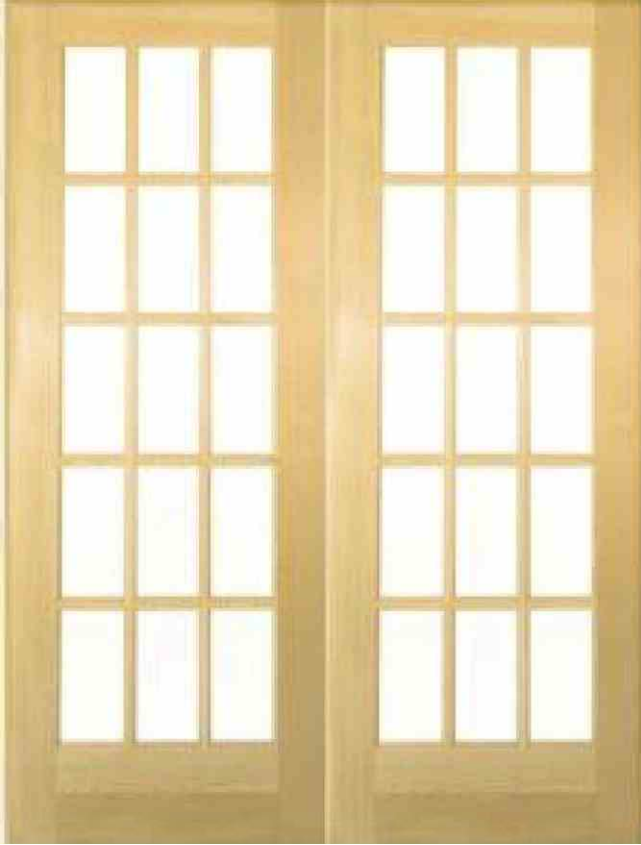

5' & 6' 30 Light Double Doors

# Interior Door Hardware Schlage® Knobs & Levers



Brushed Nickle (Standard)



Aged Bronzed (Upgrade)



Brushed Nickle (Standard)



Aged Bronze (Upgrade)

# Trim Options

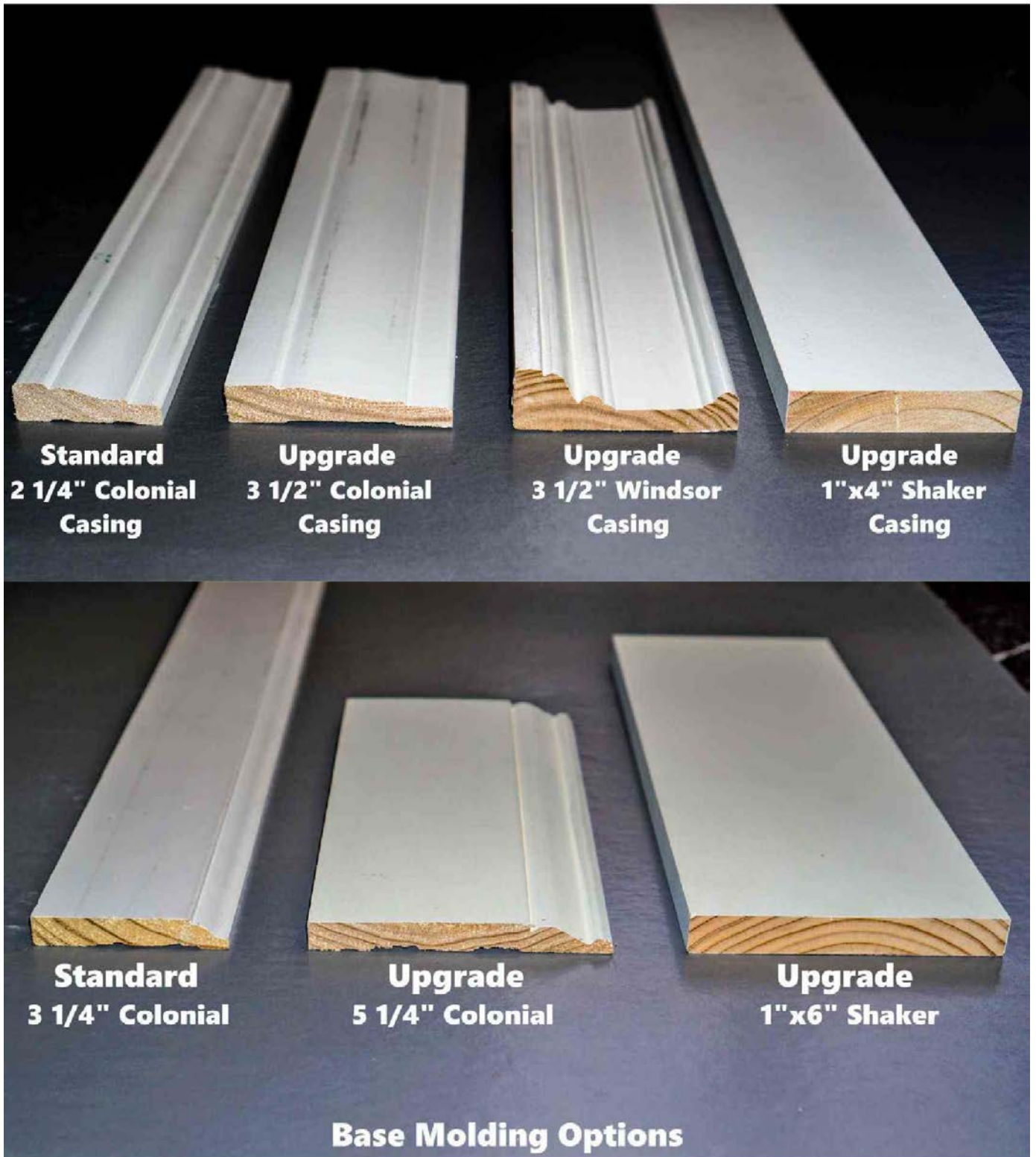

# Chair Rail



3" Chair Rail (Upgrade)

# Crown Molding

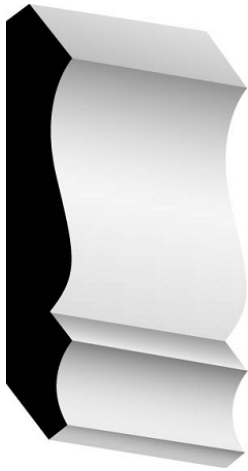

3 5/8" Crown Molding (Upgrade)



5 1/4" Crown Molding (Upgrade)

# Merillat™ Cabinets Classic Series

## Marlin (Standard Cabinets) Hardwood



Kona



Pecan



Cotton (Upgrade)

# Spring Valley Square (Standard) Oak

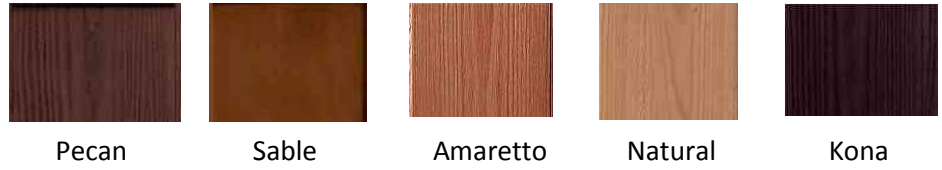

# Glen Arbor (Standard) Oak





# Avenue Maple



Solid Drawer Front



5 Piece Drawer Front

## STAINS



Natural



Toffee



Sable



Sedona

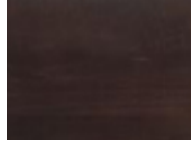

Kona



Hazelnut



Pecan



Dusk



Basalt

## PAINTED

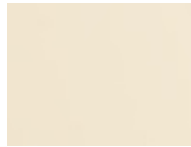

Chiffon



Shale

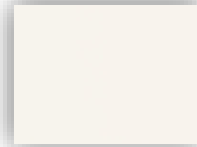

Cotton



Mist



Graphite



Nightfall

## GLAZES Only Available in 5 Piece Drawer Fronts



Cotton w/Java Glaze



Cotton w/Tuscan Glaze



Chiffon w/Tuscan Glaze



Chiffon w/Desert Glaze



Mist w/Desert Glaze

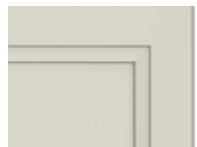

Mist w/Tuscan Glaze



Graphite w/Desert Glaze



Graphite w/Tuscan Glaze



Shale w/Desert Glaze



Shale w/Ebony Glaze

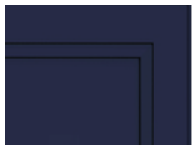

Night Fall w/Ebony Glaze



Sable w/Ebony Glaze



Hazelnut w/Java Glaze



Natural w/Java Glaze

# Avenue Cherry



Solid Drawer Front



5 Piece Drawer Front



Amaretto



Pecan



Amaretto Java Glaze

# Fox Harbor Maple



Solid Drawer Front



5 Piece Drawer Front

## STAINS



Natural



Toffee



Sable



Sedona



Kona



Hazelnut



Pecan



Dusk



Basalt

## PAINTED

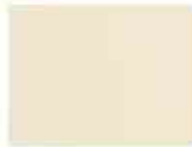

Chiffon



Shale



Cotton



Mist



Graphite



Nightfall

## GLAZES



Cotton w/Java Glaze



Cotton w/Tuscan Glaze



Chiffon w/Tuscan Glaze



Chiffon w/Desert Glaze



Mist w/Desert Glaze



Mist w/Tuscan Glaze



Graphite w/Desert Glaze



Graphite w/Tuscan Glaze



Shale w/Desert Glaze



Shale w/Ebony Glaze



Night Fall w/Ebony Glaze



Sable w/Ebony Glaze



Hazelnut w/Java Glaze



Natural w/Java Glaze

# Fox Harbor Cherry



Solid Drawer Front



5 Piece Drawer Front



Amaretto



Pecan



Amaretto Java Glaze

# Fusion Maple



## STAINS



Natural



Toffee



Sable



Sedona



Kona



Hazelnut



Pecan



Dusk



Basalt

## PAINTED



Chiffon



Shale



Cotton



Mist



Graphite



Nightfall

# Fusion Cherry



Amaretto



Pecan

# Glen Arbor Maple



**STAINS**



**PAINTED**



**GLAZES**



Cotton w/Java Glaze   Cotton w/Tuscan Glaze   Chiffon w/Tuscan Glaze   Chiffon w/Desert Glaze   Mist w/Desert Glaze  
 Mist w/ Tuscan Glaze   Graphite w/ Desert Glaze   Graphite w/Tuscan Glaze   Shale w/Desert Glaze   Shale w/Ebony Glaze  
 Night Fall w/Ebony Glaze   Sable w/Ebony Glaze   Hazelnut w/Java Glaze   Natural w/ Java Glaze

# Glen Arbor Cherry



Amaretto



Pecan

# LaBelle Maple



## STAINS



## PAINTED



## GLAZES





# LaBelle Cherry



Amaretto



Pecan



Amaretto Java Glaze

# Lanielle (Laminate)



Whisper



Cavern

# Portrait Maple

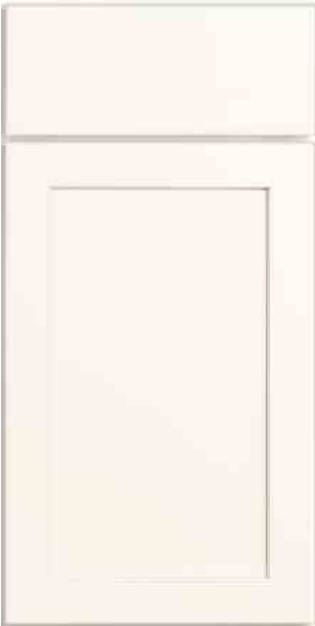

Solid Drawer Front



5 Piece Drawer Front

### STAINS



Natural



Toffee



Sable



Sedona



Kona



Hazelnut



Pecan



Dusk



Basalt

### PAINTED

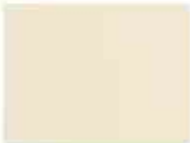

Chiffon



Shale



Cotton



Mist



Graphite



Nightfall

# Portrait Oak



Pecan



Kona



Amaretto



Sable

# Portrait Cherry



Solid Drawer Front



5 Piece Drawer Front



Amaretto



Pecan

# Ralston Maple



Solid Drawer Front



5 Piece Drawer Front

## STAINS

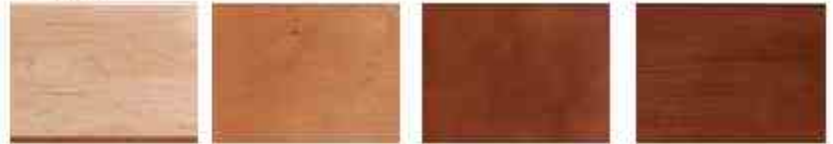

Natural

Toffee

Sable

Sedona



Kona

Hazelnut

Pecan

Dusk



Basalt

## PAINTED



Chiffon

Shale

Cotton

Mist



Graphite

Nightfall

## GLAZES



Cotton w/Java Glaze



Cotton w/Tuscan Glaze



Chiffon w/Tuscan Glaze



Chiffon w/Desert Glaze



Mist w/Desert Glaze



Mist w/Tuscan Glaze



Graphite w/Desert Glaze



Graphite w/Tuscan Glaze



Shale w/Desert Glaze



Shale w/Ebony Glaze



Night Fall w/Ebony Glaze



Sable w/Ebony Glaze



Hazelnut w/Java Glaze



Natural w/Java Glaze

# Ralston Cherry



Solid Drawer Front



5 Piece Drawer Front



Amaretto



Pecan



Amaretto Java Glaze

# Rowan Maple



Natural



Graphite w/ 5 pc drawer front

## STAINS



Natural



Toffee



Sable



Sedona



Kona



Hazelnut



Pecan



Dusk



Basalt

## PAINTED

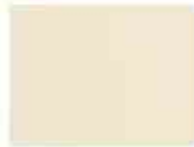

Chiffon



Shale



Cotton



Mist



Graphite



Nightfall

## GLAZES



Cotton w/Java Glaze



Cotton w/Tuscan Glaze



Chiffon w/Tuscan Glaze



Chiffon w/Desert Glaze



Mist w/Desert Glaze



Mist w/Tuscan Glaze



Graphite w/Desert Glaze



Graphite w/Tuscan Glaze



Shale w/Desert Glaze



Shale w/Ebony Glaze



Nightfall w/Ebony Glaze



Sable w/Ebony Glaze



Hazelnut w/Java Glaze



Natural w/Java Glaze

# Rowan Cherry



Solid Drawer Front



5 Piece Drawer Front



Amaretto



Pecan



Amaretto Java Glaze

# Seneca Ridge Maple



Square Drawer Front



Arch Drawer Front

**STAINS**



Natural



Toffee



Sable



Sedona



Kona



Hazelnut



Pecan

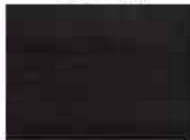

Dusk



Basalt

**PAINTED**

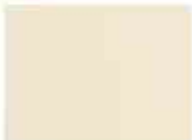

Chiffon



Shale



Cotton



Mist



Graphite



Nightfall

**GLAZES - Not Available in Arch Drawer Fronts**



Cotton w/Java Glaze



Cotton w/Tuscan Glaze



Chiffon w/Tuscan Glaze



Chiffon w/Desert Glaze



Mist w/Desert Glaze



Mist w/Tuscan Glaze



Graphite w/Desert Glaze



Graphite w/Tuscan Glaze



Shale w/Desert Glaze



Shale w/Ebony Glaze



Night Fall w/Ebony Glaze



Sable w/Ebony Glaze



Hazelnut w/Java Glaze



Natural w/Java Glaze



# Seneca Ridge Cherry



Square Drawer Front



Arch Drawer Front



Amaretto



Pecan

# Seneca Ridge Oak



Square Drawer Front



Arch Drawer Front



Pecan



Sable



Amaretto



Natural



Kona

# Somerton Hill Maple



Square Drawer Front



Arch Drawer Front

## STAINS



Natural



Toffee



Sable



Sedona



Kona



Hazelnut



Pecan

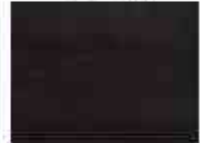

Dusk



Basalt

## PAINTED

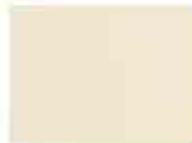

Chiffon



Shale



Cotton



Mist



Graphite



Nightfall

## GLAZES



Cotton w/Java Glaze



Cotton w/Tuscan Glaze



Chiffon w/Tuscan Glaze



Chiffon w/Desert Glaze



Mist w/Desert Glaze



Mist w/Tuscan Glaze



Graphite w/Desert Glaze



Graphite w/Tuscan Glaze



Shale w/Desert Glaze



Shale w/Ebony Glaze



Night Fall w/Ebony Glaze



Sable w/Ebony Glaze



Hazelnut w/Java Glaze



Natural w/Java Glaze

# Somerton Hill Cherry



Square Drawer Front



Arch Drawer Front



Amaretto



Pecan



Amaretto Java Glaze

# Spring Valley Maple



## STAINS



Natural

Toffee

Sable

Sedona



Kona

Hazelnut

Pecan

Dusk



Basalt

## PAINTED



Chiffon

Shale

Cotton

Mist



Graphite

Nightfall

## GLAZES



Cotton w/Java Glaze



Cotton w/Tuscan Glaze



Chiffon w/Tuscan Glaze



Chiffon w/Desert Glaze



Mist w/Desert Glaze



Mist w/ Tuscan Glaze



Graphite w/ Desert Glaze



Graphite w/Tuscan Glaze



Shale w/Desert Glaze



Shale w/Ebony Glaze



Night Fall w/Ebony Glaze



Sable w/Ebony Glaze



Hazelnut w/Java Glaze



Natural w/ Java Glaze

# Spring Valley Cherry



Amaretto



Pecan

# Spring Valley Hickory



Natural

# Spring Valley Oak



Pecan



Sable



Amaretto



Natural



Kona

# Sutton Cliffs Maple



## STAINS



Natural

Toffee

Sable

Sedona



Kona

Hazelnut

Pecan

Dusk



Basalt

## PAINTED



Chiffon

Shale

Cotton

Mist



Graphite

Nightfall

# Sutton Cliffs Cherry



Amaretto

Pecan

# Sutton Cliffs Oak



Pecan



Sable



Amaretto



Natural



Kona

# Sutton Cliffs Hickory



Natural



# Tolani Maple



Solid Drawer Front



3 Piece Drawer Front



5 Piece Drawer Front

## STAINS



Natural



Toffee



Sable



Sedona



Kona



Hazelnut



Pecan



Dusk



Basalt

## PAINTED -Not Available in 3 Piece Drawer Fronts



Chiffon



Shale



Cotton



Mist



Graphite



Nightfall

# Tolani Cherry



Solid Drawer Front

3 Piece Drawer Front

5 Piece Drawer Front



Amaretto

Pecan

# Tolani Oak



Solid Drawer Front

3 Piece Drawer Front

5 Piece Drawer Front



Pecan

Sable

Amaretto

Natural

Kona

## Vance (Laminate)



White



Grey w/ 5 pc drawer

## Whitebay II Laminate

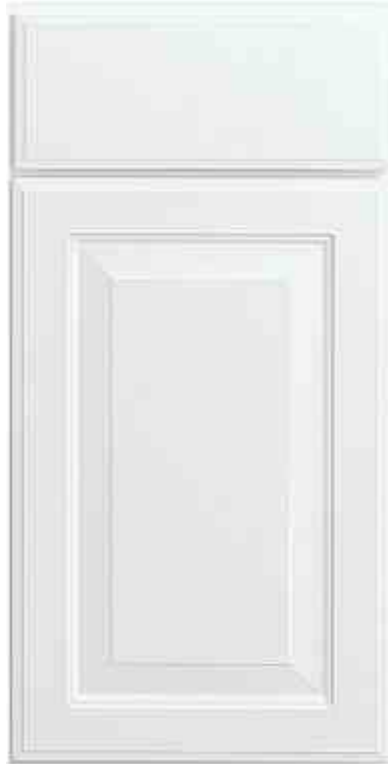

# Merillat™ Kitchen Upgrade Options



Tilt-Out Trays for Sink Base



Trash Hamper



Roll-Out Tray Divider



(Dovetail Drawer)

- Undermount Drawer Guide with SoftAction Drawers
- Plywood Construction



Coreguard® Sink Base Liner

## Crown Molding Optional



Cove Crown Molding

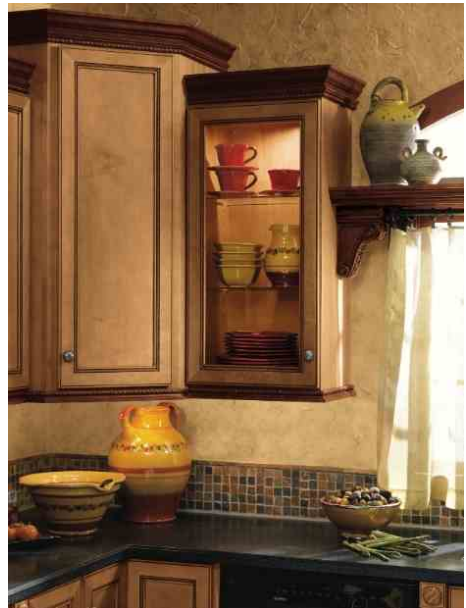

Classic Crown Molding

# Kitchen & Bath Counter Tops

## Wilsonart®

### Standard Laminate



Almond Leather 2932-60

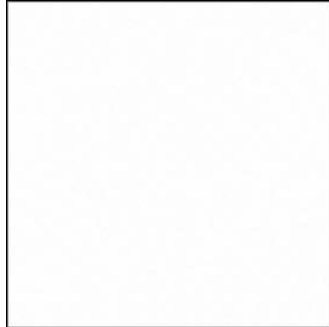

Designer White D354-60



Mystique Dawn 4762-60



Tumbled Rocca 4835-38



White Carrara 4924-38



Sable Soapstone 4883-38



Green Soapstone 4885-38



Pearl Soapstone 4886-38



Tan Soapstone 4887-38



Spicewood Springs 4905-38



# Upgrade Laminate



Bronze Fusion 1796-07



Calcutta Marble 4925-07



Smoky Topaz 4589-07



Jeweled Coral 4866-52



Andorra Fog 4999K-22



Italian White Di Pesco 4954K-22



Andorra Shadow 4998K-22



Serrana 1890K-22

# Deluxe Option Laminate

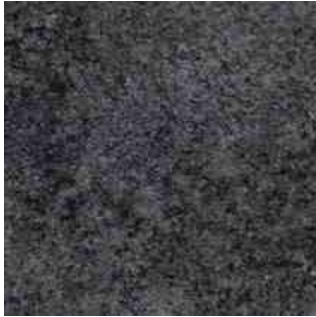

Deepstar Slate 1818-35



Winter Carnival 1874-35

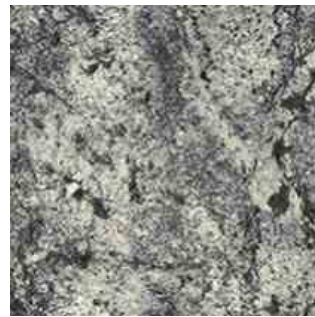

Trinidad Lapidus 1879-35



Bianco Romano 1872-35



Sedona Trail 1826-35



Summer Carnival 1875-35



Canyon Passage 1842-45



Cipollino Grigio 1882K-35



Cipollino Bianco 1881K-35



# Laminate Countertop Edging



Standard Edge



Beveled Edge- Upgrade



Milano Mahogany  
4728K-52

Crescent Edge- Upgrade



Wood Beveled Edge- Upgrade



Radius End Top



Angle Clipped Corners

# Kitchen Sink Options

## Stainless Steel



Double Bowl Stainless Steel Sink  
(STANDARD)

Stainless Steel Double Bowl- (Standard)



Standard 8" Deep  
Stainless Steel Sink

Stainless Steel Single Bowl- (Standard)



Stainless Steel Single Bowl Undermount Sink- (Upgrade)



Stainless Steel Double Bowl Undermount Sink- (Upgrade)

# Kitchen

## Standard



Model No: 4453-DST  
Finish: Chrome  
Linden Single Handle Kitchen Faucet with Spray

## Options



Model No: 4453-AR-DST  
Finish: Arctic Stainless  
Linden Single Handle



Model No: 9113-DST  
Finish: Chrome  
Essa Single Handle



Model No: 9113-AR-DST  
Finish: Arctic Stainless  
Essa Single Handle



Model No: 9113-RB-DST  
Finish: Venetian Bronze  
Essa Single Handle



Model No: 9113-BL-DST  
Finish: Matte Black  
Essa Single Handle

# Kitchen

## Additional Options



Model No: 1903-DST  
Finish: Chrome  
Classic Single Handle Bar/Prep



Model No: 2131LF  
Finish: Chrome  
Classic Two Handle Laundry

# Range Hoods



413001 Non-Ducted White (Standard)  
403001 Ducted White (Upgrade)



413023 Non-Ducted Black (Standard)  
403023 Ducted Black (Upgrade)

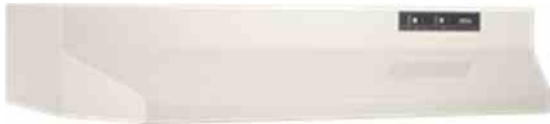

413008 Non-Ducted Bisque (Standard)  
403008 Ducted Bisque (Upgrade)

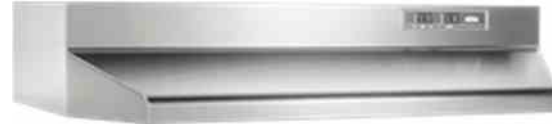

413004 Non-Ducted Stainless Steel (Upgrade)  
403004 Ducted Stainless Steel (Upgrade)

# Whirlpool® Appliances Dishwashers (Optional)



White



Black



Stainless Steel

# Microwaves (Optional)

## WMH31017A



Biscuit on Biscuit



Black on Black



Stainless Steel (Upgrade)



White on White



# Rynone<sup>®</sup> Bath Countertops

## Cultured Marble

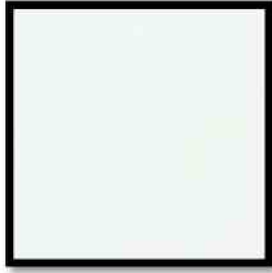

White on White (Standard)

## Cultured Marble Granite (Upgrade)



Oatmeal 301



Ecru 332



Fashion Grey 331



Lace 317



Pewter 336



Mocha 316



Coco 339



Sand 323

# Granit Vanity Top (Upgrade)

## Group 1



Burlywood



Wheat

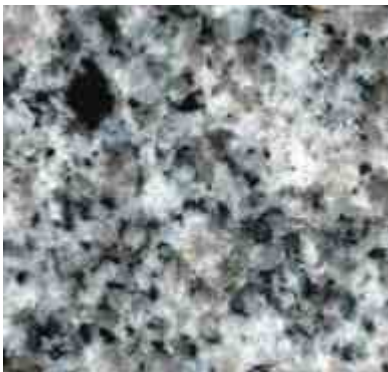

Meteorite



Tiger Skin White

## Group 2



Ubatuba



Elysian



Rio Roca

## Group 3



Absolute Black



Marron Desert



Luna Bai

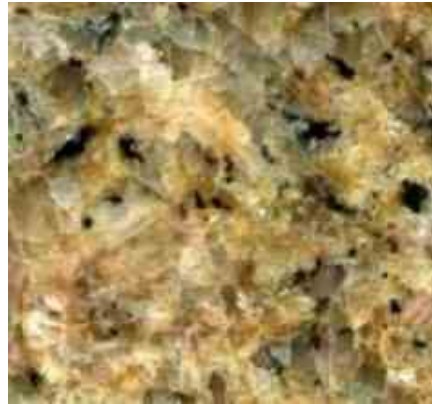

Venice Gold

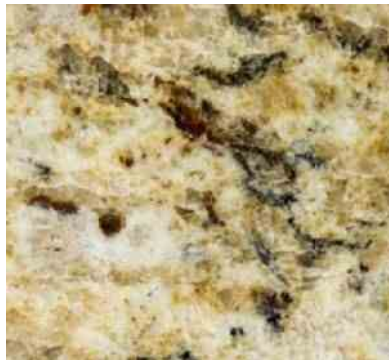

Sandstorm



# Rynone<sup>®</sup> Quartz Vanity Tops

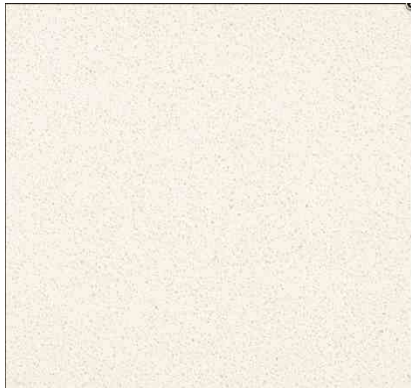

Polar White 3001

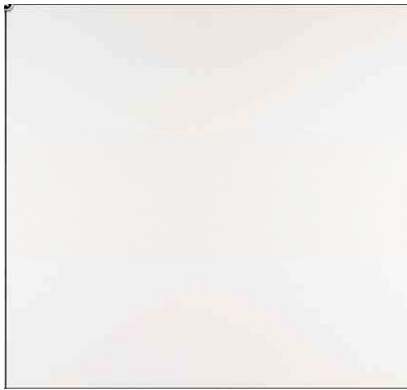

Porcelain White 3007



Iceberg 3010



Tempest Carrara 1007



Ocean Grey 1002



Stormy Grey 3011



Terra Grey 3012



Copper Sand 3013



Grey Pearl 3006



Toast 3008

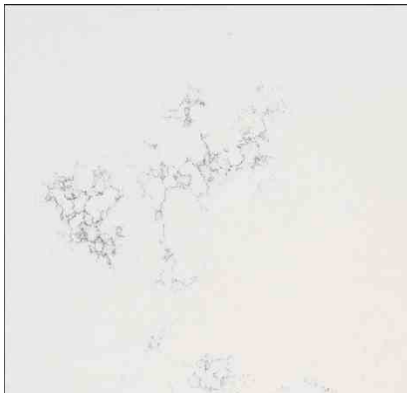

Carrara Verta 3009

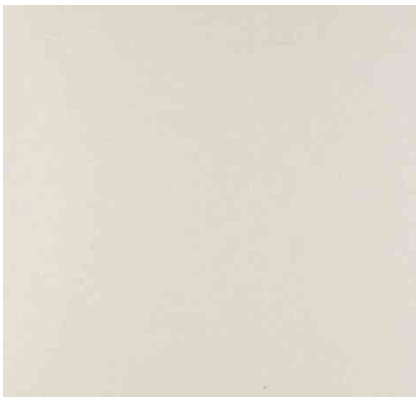

White Pearl 3003

## Medicine Cabinets (Optional)



14" Mirrored Medicine Cabinet (Standard)

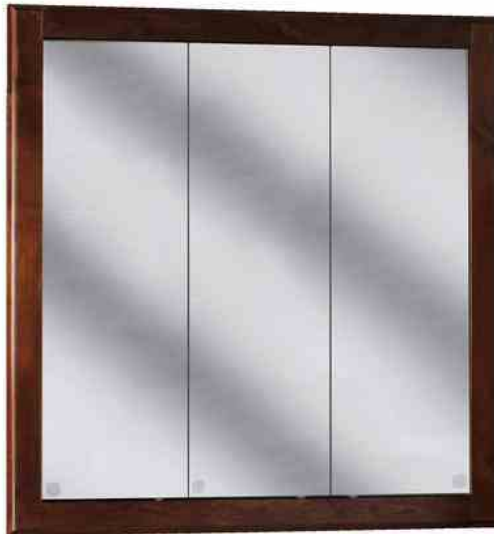

Merillat Matching Triple Mirror Medicine Cabinet (Upgrade)  
Available 24", 30", & 36"

# Vanity Lights

## Bath Collection

### Brookchester



#### Bath

**4871-05**

Chrome Finish

Clear Ribbed Glass

W: 13.25" H: 7.75" E: 7.5"

(2) Medium Base 100w Max  
Clear Bulb Recommended



#### Bath

**4872-05**

Chrome Finish

Clear Ribbed Glass

W: 17" H: 6.5" E: 7.25"

(3) Medium Base 100w Max  
Clear Bulb Recommended



#### Bath

**4873-05**

Chrome Finish

Clear Ribbed Glass

W: 20.5" H: 7.25" E: 8"

(4) Medium Base 100w Max  
Clear Bulb Recommended

### Alexandria (upgrade)



#### Bath

**40010-773**

Two-Tone Nickel Finish

Clear Satin Etched Glass

W: 13" H: 7.75" E: 7.5"

(2) Medium Base 100w Max  
Clear Bulb Recommended



#### Bath

**40011-773**

Two-Tone Nickel Finish

Clear Satin Etched Glass

W: 18.25" H: 7.5" E: 7.5"

(3) Medium Base 100w Max  
Clear Bulb Recommended



#### Bath

**40012-773**

Two-Tone Finish

Clear Satin Etched Glass

W: 24.75" H: 7.75" E: 7.5"

(4) Medium Base 100w Max  
Clear Bulb Recommended

### Montreal (upgrade)



#### Bath

**41181-710**

Burnt Sienna Finish

Café Tint Glass

W: 17.5" H: 8.25" E: 9.75"

(2) Medium Base 100w Max  
Clear Bulb Recommended



#### Bath

**41182-710**

Burnt Sienna Finish

Café Tint Glass

W: 27" H: 8.25" E: 9.75"

(3) Medium Base 100w Max  
Clear Bulb Recommended



#### Bath

**41183-710**





Burnt Sienna Finish

Café Tint Glass

W: 36.75" H: 8.25" E: 9.75"

(4) Medium Base 100w Max  
Clear Bulb Recommended

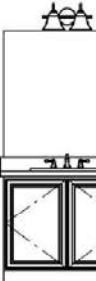
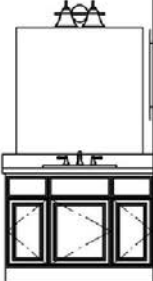
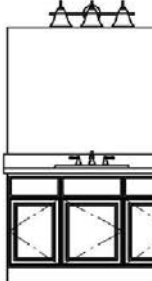
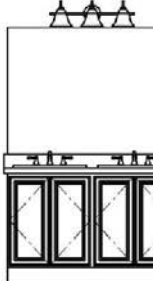
# Bath Vanity Layouts

TYPICAL* BATH VANITY LAYOUTS				
MERILLAT CLASSIC SERIES - VANITIES AND DRESSING TABLES				
				
V-24 (VB24)** 24" x 36" Mirror 2-Bulb Tulip Light	V-30 (VB30) 30" x 36" Mirror with MG14 2-Bulb Tulip Light	V-36 (VB36) 36" x 36" Mirror with MG14 2-Bulb Tulip Light		
				
V-42 (V5B42-2D) 36" x 36" Mirror with MG14 2-Bulb Tulip Light	V-48 (V5B48-2D) 48" x 36" Mirror with MG14 3-Bulb Tulip Light	V-48 Double Bowl** or Offset Single Bowl (2-VB24) 48" x 36" Mirror 3-Bulb Tulip Light		
				
36" Dressing Table (VD12 AD24) 36" x 36" Mirror 2-Bulb Tulip Light			54" Dressing Table (2-VD15 AD24) 48" x 36" Mirror 3-Bulb Tulip Light	

\*NOTE - Typical layouts are for standard laminate tops. Layouts may vary with cultured marble or corian tops.

\*\*NOTE - There must be 15" clearance from the center of a sink to a wall or any other object.

Therefore, V24 and V48 double-bowl vanities cannot be located against a wall on either side.



# TYPICAL\* BATH VANITY LAYOUTS

## MERRILLAT CLASSIC SERIES - VANITIES AND DRESSING TABLES

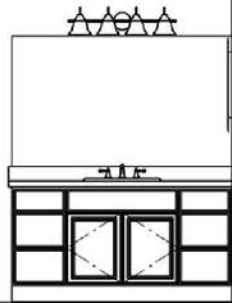

V-60 (VCD60)  
60" x 36" Mirror with MC14  
4-Bulb Tulip Light

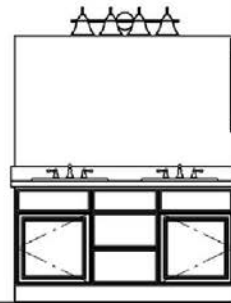

V-60 Double Bowl (VSB60-3D)  
(2) 24" x 36" Mirrors with MC14  
(2) 2-Bulb Tulip Lights

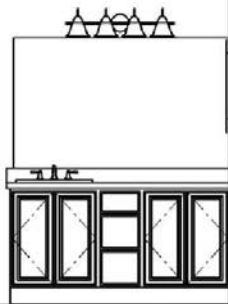

V-60 Offset Single Bowl (2-VB24 VD12)  
60" x 36" Mirror with MC14  
4-Bulb Tulip Light

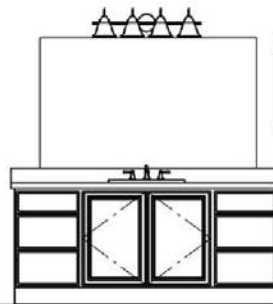

V-72 (2-VD18 VB36)  
60" x 36" Mirror with MC14  
4-Bulb Tulip Light

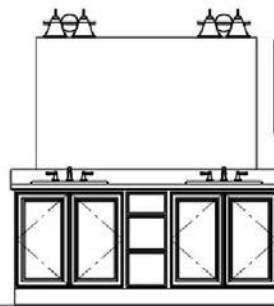

V-72 Double Bowl or Offset Single Bowl (2-VB30 VD12)  
(2) 30" x 36" Mirrors with MC14  
(2) 2-Bulb Tulip Lights

\*NOTE - Typical layouts are for standard laminate tops. Layouts may vary with cultured marble or corian tops.

# Bath Fans

Broan® A70L  
(Standard)



# MODELS A50L, A70L INVENT™ SERIES FAN / LIGHTS

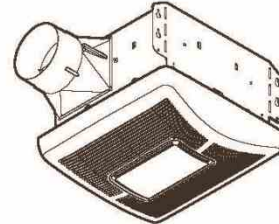

### DESCRIPTION

#### BLOWER:

- Plug-in, permanently lubricated motor - engineered for continuous operation
- Dynamically balanced centrifugal blower wheel for quiet, efficient performance
- Low RPM for quiet operation

#### HOUSING:

- Rugged, 26 gauge, galvanized steel construction
- Polymeric, 4" duct connector with tapered sleeve and no metallic clatter
- 5-3/4" height allows for 2" x 6" ceiling installations
- Sturdy, easy, four-point mounting directly to joist
- Can be mounted in ceilings up to 7/12 pitch

#### GRILLE:

- Polymeric construction
- Innovative design - the result of extensive research with designers and consumers
- 100W max. incandescent A19 type bulb or energy efficient equivalent bulb with Maximum Overall Length (M.O.L.) of 4.4" or less (bulb not included)
- Durable steel reflector with white enamel finish

#### CONTROLS (Purchase separately):

- Refer to Broan's catalog for a complete line of accessories to effectively adapt these fans to your construction requirements.

U.L. Listed for use over bathtubs and showers when connected to a GFCI protected branch circuit (ceiling mount only).

U.L. Listed for use in insulated ceilings (TYPE I.C.)

1-Year Warranty

### TYPICAL SPECIFICATION

Fan / Light shall be Broan Model A50L (A70L).

Fan / Light shall have corrosion resistant galvanized steel housing with four-point mounting capability. It shall be ducted to a roof or wall cap using 4" round ductwork.

Blower assembly shall be removable, have a centrifugal-type blower wheel and a permanently lubricated motor designed for continuous operation.

Non-metallic damper/duct connector shall be included.

Bulb shall be 100W max. A19 type incandescent or energy efficient equivalent bulb with Maximum Overall Length (M.O.L.) of 4.4" or less (bulbs not included).

Air delivery shall be no less than the airflow values and no greater than the sound level values listed in the HVI Performance Specifications provided in this specification (see following chart). All air and sound ratings shall be certified by HVI.

Ceiling Ventilator shall be U.L. Listed for use in insulated ceilings (Type I.C.) and for use over bathtubs and showers when connected to a GFCI protected branch circuit.



Broan-NuTone LLC Hartford, Wisconsin www.broan.com 800-558-1711

REFERENCE	QTY.	REMARKS	Project
			Location
			Architect
			Engineer
			Contractor
			Submitted by Date

Panasonic® FV-08-11VFL5  
(Upgrade)



# WhisperFit<sup>®</sup> EZ

VENTILATION FAN

FV-08-11VFL5

## Specification Submittal Data / Panasonic Ventilation Fan/Light

### Description:

Ventilating fan/light shall be low sone ceiling mount rated for continuous operation. Fan shall be ENERGY STAR<sup>®</sup> rated and certified by the Home Ventilating Institute (HVI). Evaluated by the Underwriters Laboratories and conform to both UL and cUL standards.

### Motor/Blower:

- Four-pole totally enclosed condenser AC motor rated for continuous use.
- Fan ventilation rates shall be manually adjustable for 80 or 110 CFM.
- Power Rating shall be 120 volts and 60 Hz.
- Fan shall be UL and cUL listed for tub/shower enclosure when GFCI protected.
- Motor equipped with thermal cutoff fuse.
- Removable, permanently lubricated, plug-in motor.

### Housing:

- Rust proof epoxy and polyester resin coating, 26 gauge galvanized steel body.
- 4" diameter duct with optional 3" adapter included.
- Built in backdraft damper.
- Articulating and expandable extension bracket up to 24".

### Grille:

- Attractive design using Poly Pro material.
- Attaches directly to housing with torsion springs.

### Light:

- Two 13 Watt self-ballasted GU24 base compact fluorescent lamps included.
- One 4-Watt night-light included.
- FCC Part 18 compliant.

### Warranty:

- ALL Parts: 3 years original purchase date.
- CFL: 3 years. Night Light: No Warranty.

### Architectural Specifications:

Ventilation fan and light shall be ceiling mount, ENERGY STAR<sup>®</sup> rated with built-in speed selector. Select from 80/110 CFM and no more than 0.4/1.0 sone as certified by the Home Ventilating Institute (HVI) at 0.1 wg with no less than 72/102 CFM and no more than 0.7/1.3 sone as certified by HVI at 0.25 w.g. Power Consumption shall be no greater than 20.9/26.6 watts at 0.1 w.g. and 20.5/26.5 watts at 0.25 w.g. with efficiency of no less than 3.8/4.2 CFM/watt at 0.1 w.g. and 3.5/3.9 CFM/watt at 0.25 w.g. The motor shall be fully enclosed, four pole condenser type engineered to operate continuously for no less than 30,000 hours. Power rating shall be 120v/60Hz. Housing material shall be no less than 26 gauge galvanized steel with rust proof epoxy and polyester resin coating. Duct diameter shall be no less than 4" (3" if using the included duct adapter). Fan shall be UL and cUL listed for tub shower enclosure when GFCI protected. Fan can be used to comply with ASHRAE 62.2, LEED, ENERGY STAR<sup>®</sup> IAP, EarthCraft, California Title-24 and WA Ventilation Code. Lamps shall be of the compact fluorescent type with the fan utilizing no less than two 13W ENERGY STAR<sup>®</sup> rated self ballasted GU24 base compact fluorescent lamps, 3500 Kelvin, >80 CRI/998 Lumens per lamp/75 Lumens Per Watt/10,000 hours rated average life. Night-light feature shall be included.

3" or 4" Duct

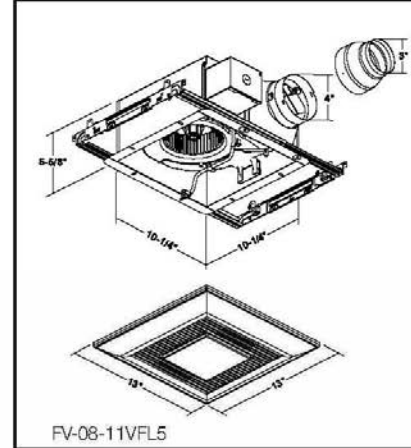

### See Following Page for Performance Curves



(2) 13W self-ballasted GU24 base CFL lamps included. 3500 Kelvin, >80 CRI/998 Lumens per lamp/75 Lumens Per Watt/10,000 hours rated average life.

Specifications: <b>WhisperFit<sup>®</sup> EZ</b> FV-08-11VFL5		110 CFM Setting		80 CFM Setting					
		4" Duct	3" Duct	4" Duct	3" Duct				
Ventilation Fan Characteristics (HVI Certified Data)	Static Pressure In inches w.g.	0.1	0.25	0.1	0.25	0.1	0.25	0.1	0.25
	Air Volume (CFM)	110	102	100	86	80	72	70	60
	Noise (sones)	1.0	1.3	1.3	1.5	0.4	0.7	0.6	1.0
	Power Consumption (Watts)	26.6	26.5	26.4	25.8	20.9	20.5	20.8	20.2
	Energy Efficiency (CFM/Watt)	4.2	3.9	3.9	3.4	3.8	3.5	3.7	3.2
	Speed (RPM)	1033	1240	1270	1399	905	1164	1085	1263
	Current (amps)	0.23	0.22	0.22	0.22	0.17	0.17	0.17	0.17
	MAX. Current (amps)	0.23		0.23		0.18		0.18	
	Power Rating (V/Hz)	120/60		120/60		120/60		120/60	
	ENERGY STAR rated	YES		YES		YES		YES	

For complete Installation Instructions visit [us.panasonic.com/ventfans](http://us.panasonic.com/ventfans)

0.25-Installed Performance

Model	Quantity	Comments	Project:
			Location:
			Architect:
			Engineer:
			Contractor:
			Submitted by:
			Date:

Panasonic Eco Solutions North America  
Eco Products Division  
Two Riverfront Plaza  
Newark, NJ 07102

[us.panasonic.com/ventfans](http://us.panasonic.com/ventfans)



# Panasonic



# Bath

## Lavatory

### Standard



Model No: 2532LF-MPU  
Finish: Chrome  
Woodhurst Two Handle Centerset

### Options



Model No: 2532LF-SSMPU  
Finish: Stainless  
Woodhurst Two Handle Centerset



Model No: 2538-SSMPU-DST  
Finish: Stainless  
Lahara Two Handle Centerset



Model No: 2564-SSMPU-DST  
Finish: Stainless  
Ashlyn Two Handle Centerset



Model No: 2532LF-RBMPU  
Finish: Venetian Bronze  
Woodhurst Two Handle Centerset



Model No: 2538-RBMPU-DST  
Finish: Venetian Bronze  
Lahara Two Handle Centerset



Model No: 2564-RBMPU-DST  
Finish: Venetian Bronze  
Ashlyn Two Handle Centerset

# Bath

Lavatory

Options



Model No: 2564-MPU-DST  
Finish: Chrome  
Ashlyn Two Handle Centerset



Model No: 2564-BLMPU-DST  
Finish: Matte Black  
Ashlyn Two Handle Centerset

# Bath Accessories Chrome



Towel Ring



Towel Bar



Paper Holder



# Satin Nickle



Towel Ring



Towel Bar



Paper Holder

# Dark Bronze



Towel Ring



Towel Bar



Paper Holder

# Bath Fixture Options

## American Standard® Toilets



Low Flow Water Saving (White Only) – (Standard)  
(1.28 gpf) (15" Height off Floor)

Elongated Right-Height Water Closet w/Seat- (Upgrade)  
(1.28 gpf) (16 ½" Height off Floor)

## Pedestal Sinks



Pedestal Sink (Standard)

## Bath Fixture Color Options



White



Linen



Bone

# Tubs & Showers



48" Shower (Standard)  
48" x 35" x 72"  
Towel Bar not Incl.



36" Shower (Optional)  
36" x 36" x 72"



60" Shower (Optional)  
60" x 35" x 72"  
Towel Bar not Incl.



60" Princeton Americast Tub (Optional)  
(White Only)  
60" x 30" x 14"



Cambridge Americast Tub (Upgrade)  
60" x 32" x 17- $\frac{3}{4}$ "



Neo Angel Corner Shower (Optional)  
38" x 38" x 72"



60" Tub/Shower (Standard)  
60" x 32" x 72" Towel Bar not Incl.

## Bath Fixture Color Options



White



Linen



Bone

# Full ADA Tub & Shower Stalls



36" Full ADA Shower  
1363-BFS-ADA



60" Full ADA Shower  
1603-BFSD-ADA



60" Full ADA Tub  
2603-SMTE-ADA

# Reinforced Tub and Shower Stalls

(Stall only does not include seat, grab bars, and hand shower)



36" Reinforced (**Shower Stall Only**)  
1363-BFS



60" Reinforced (**Shower Stall Only**)  
1603-BFSD



60" Reinforced (**Tub-Shower Stall Only**)  
2603-SME

# Bath

## Tub/Shower

### Standard



Model No: T13420-SOS  
Finish: Chrome  
Classic Monitor 13 Series

### Options



Model No: T14438-SOS  
Finish: Chrome  
Lahara Monitor 14 Series



Model No: T14438-SSSOS  
Finish: Stainless  
Lahara Monitor 14 Series



Model No: T14438-RBSOS  
Finish: Venetian Bronze  
Lahara Monitor 14 Series



Model No: T14494-SOS  
Finish: Chrome  
Linden Monitor 14 Series



Model No: T14494-SSSOS  
Finish: Stainless  
Linden Monitor 14 Series



Model No: T14494-RBSOS  
Finish: Venetian Bronze  
Linden Monitor 14 Series



# Bath

## Tub/Shower

### Options



Model No: T14464  
Finish: Chrome  
Ashlyn Monitor 14 Series



Model No: T14464-SS  
Finish: Stainless  
Ashlyn Monitor 14 Series



Model No: T14464-RB  
Finish: Venetian Bronze  
Ashlyn Monitor 14 Series



Model No: T14464-BL  
Finish: Matte Black  
Ashlyn Monitor 14 Series

# Jacuzzi® Hydro Massage & Soaking Tubs (Upgrade)



6032 Skirted



7242 Drop-In Oval



Bianca-Special Quote



6060 Drop-In

## Color Options



White



Almond

# Bath

## Roman Tub

### Standard



Model No: T2738  
Finish: Chrome  
Lahara Roman Tub

### Options



Model No: T2738-SS  
Finish: Stainless  
Lahara Roman Tub



Model No: T2793-SS  
Finish: Stainless  
Linden Roman Tub



Model No: T2764-SS  
Finish: Stainless  
Ashlyn Roman Tub



Model No: T2738-RB  
Finish: Venetian Bronze  
Lahara Roman Tub



Model No: T2793-RB  
Finish: Venetian Bronze  
Linden Roman Tub



Model No: T2764-RB  
Finish: Venetian Bronze  
Ashlyn Roman Tub

# Bath

## Roman Tub

### Options



Model No: T2764-BL  
Finish: Matte Black  
Ashlyn Roman Tub

# Bath

## Additional Options



Model No: 52001-DS  
Finish: White  
Universal Slide Bar Hand Shower (ADA Compliant)



Model No: 58480-PK  
Finish: Chrome  
H2Okinetic In2ition 5-Setting



Model No: RP52688  
Finish: Chrome  
H2Okinetic 3-Setting Raincan

# Exterior Siding Selections

## MainStreet (WMH Stock Colors) Standard

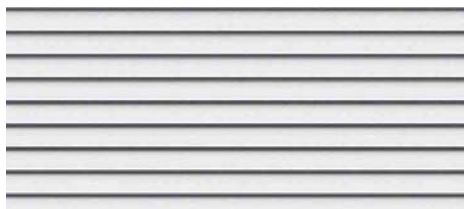

Colonial White



Cypress



Desert Tan

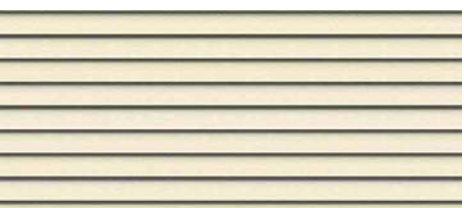

Heritage Cream

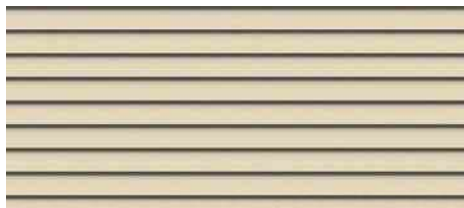

Light Maple



Natural Clay

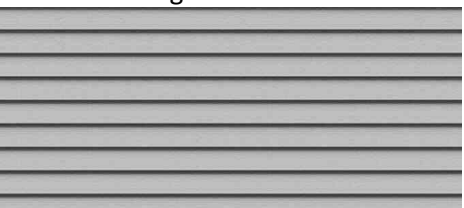

Sterling Gray

# MainStreet (WMH Non-Stock Colors) Upgrade

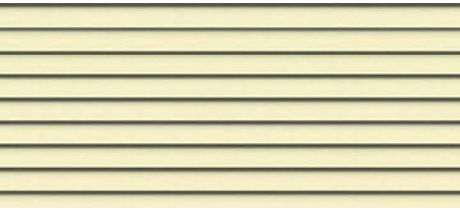

Autumn Yellow

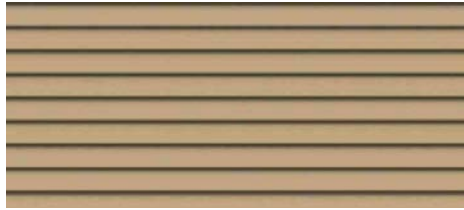

Buckskin



Granite Gray

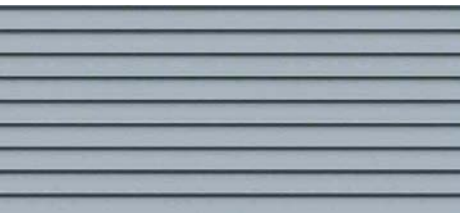

Oxford Blue

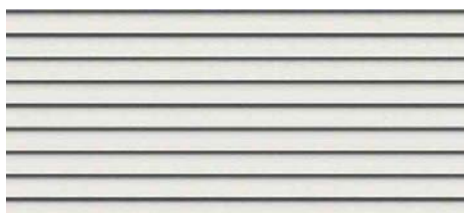

Sandstone Beige



Savannah Wicker

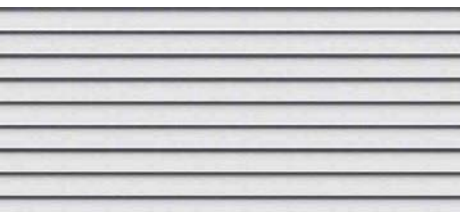

Snow



Seagrass

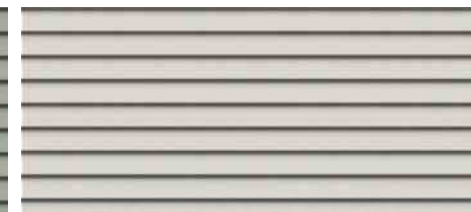

Herringbone

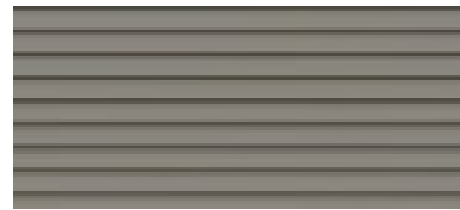

Castle Stone

# MainStreet Deluxe (Upgrade)



Autumn Red



Charcoal Gray



Flagstone



Forest

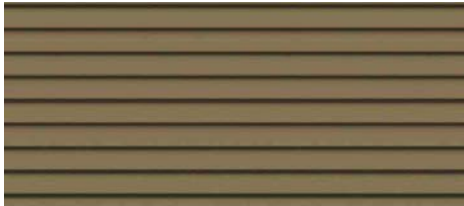

Hearthstone



Spruce



Pacific Blue



Sable Brown

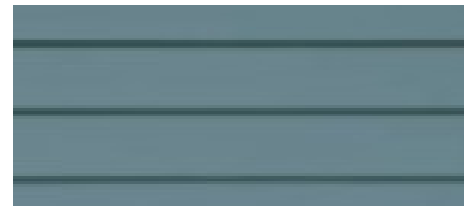

Wedgewood Blue

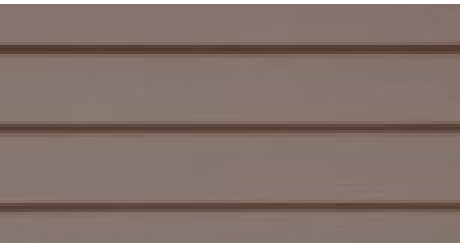

Weathered Wood



# Monogram (Upgrade)

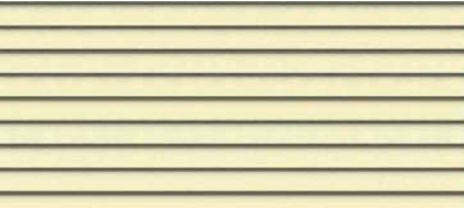

Autumn Yellow



Buckskin



Desert Tan

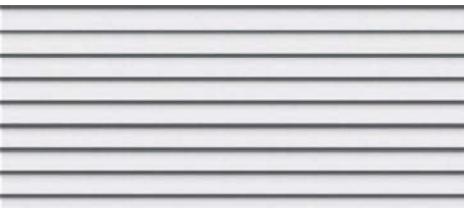

Colonial White

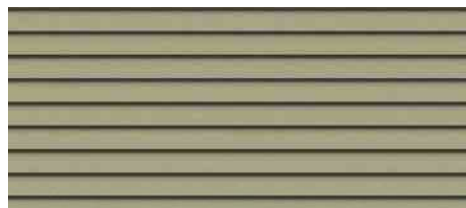

Cypress

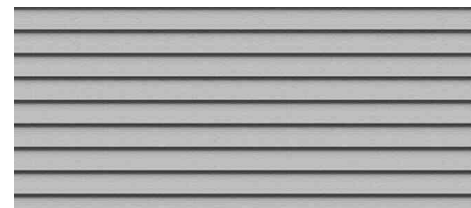

Sterling Gray



Granite Gray

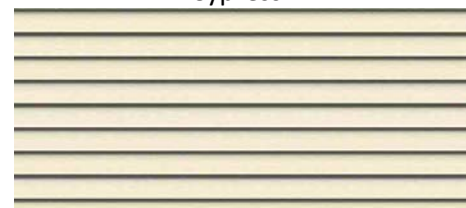

Heritage Cream



Castle Stone



Herringbone

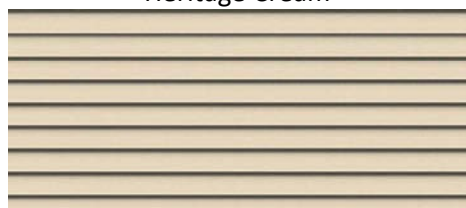

Light Maple



Sandstone Beige

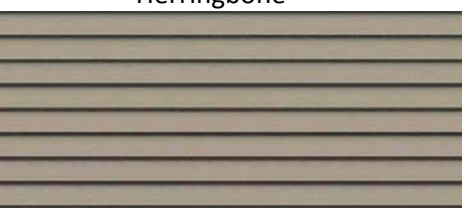

Natural Clay



Oxford Blue



Seagrass

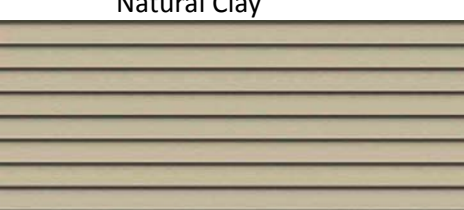

Savannah Wicker



# Monogram Deluxe Colors (Upgrade)



Autumn Red

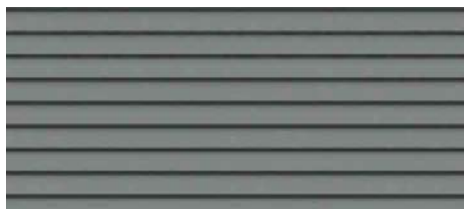

Charcoal Gray

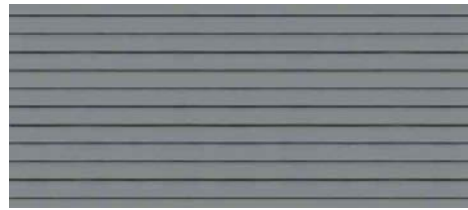

Flagstone



Forest



Hearthstone



Sable Brown



Mountain Cedar



Pacific Blue



Slate



Spruce



Midnight Blue



Espresso

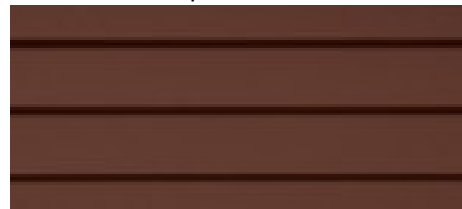

Brownstone

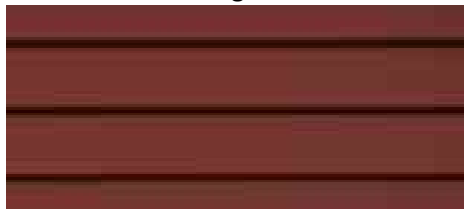

Melrose

# Monogram Premium (Upgrade)



Arbor Blend



Frontier Blend



Weathered Blend



Rustic Blend



Natural Blend

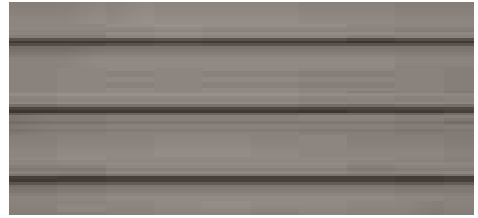

Driftwood Blend



Cedar Blend

# Northwoods (Upgrade)



Autumn Red



Buckskin



Colonial White



Cypress



Desert Tan



Flagstone



Granite Gray



Natural Clay



Pacific Blue



Sable Brown

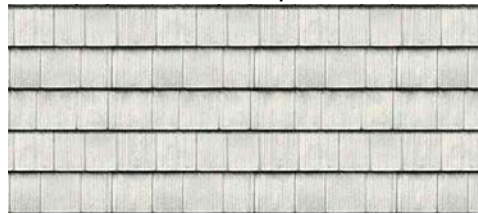

Savannah Wicker



Sterling Gray

# Corner Posts



3 ½" Snap on Corner White Only (Standard)

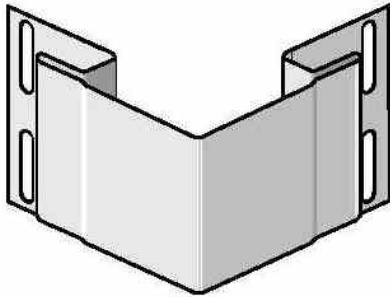

Monogram 3 ½" Nail-On Corner (Upgrade)  
(All Available Siding Colors Available to Match)

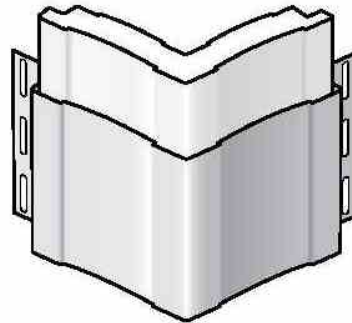

5" Smooth Super Corner (Upgrade)

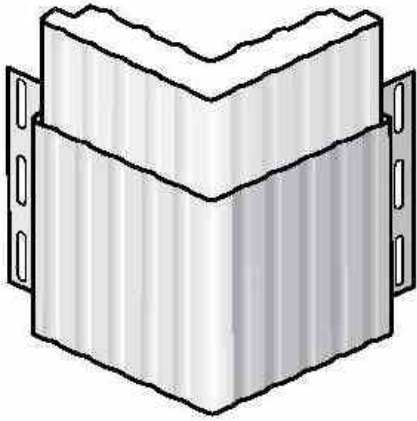

Fluted 5 1/2" Super Corner (Upgrade)

# Ply Gem® Shutters

## Louvered or Panel



White #11



Black #33



Gray #16



Brown #59



Green #55



Vineyard Red SK



Blue #41



# TruDefinition® Duration® Shingles

## Standard Colors



Brownwood



Chateau Green



Desert Tan



Driftwood



Estate Gray



Onyx Black



Sierra Gray



Teak



Terra Cotta



# Non-Stock Colors (Upgrade)



Amber



Colonial Slate



Shasta White



Harbor Blue



Quarry Gray



Slatestone Gray



# Designer Colors (Upgrade)



Pacific Wave



Sand Dune



Storm Cloud



Summer Harvest



Merlot



Aged Copper



Sedona Canyon

# Exterior Options

## PVC Picture Frame (Upgrade)

