

102 Electrical Energy Innovations

Gary Vesperman (Author)

Advisor to Sky Train Corporation

www.skytraincorp.com

588 Lake Huron Lane

Boulder City, NV 89005-1018

702-435-7947

garyvesperman@yahoo.com

www.padrak.com/vesperman

www.commutefaster.com/vesperman.html

<http://the-door.net/the-colorado-center/radioactivity-neutralization-methods-and-more/>

TABLE OF CONTENTS

<u>Title</u>	<u>Page</u>
INTRODUCTION.....	1
BRIEF SUMMARIES.....	2
LARGER GENERATORS.....	12
Hydro-Magnetic Dynamo	12
Tesla’s Global Wireless Transmission of Electrical Power	26
Focus Fusion.....	38
BlackLight Power’s Hydrino Generator.....	40
IPMS Thorium Energy Accumulator	42
Thorium Power Pack.....	42
Magneto-Gravitational Converter (Searl Effect Generator)	43
Induction Coil Coating Increases Generator Electrical Output by One-Third.....	45
Wind Turbine Conversion.....	46
Direct Energy Conversion	46
Electrino Fusion Power Reactor	52
Plasma Biomass Gasification	60
Nano-Membrane Pyro-Gasification Process.....	61
Super Steam Technology	63
Gas-Phase Catalytic Fusion	65
SMALLER GENERATORS.....	66
Casimer-Layered Electrodynamic Generator	66
Thin-Film Power Generating Disks	66
Magnetic Drive Generator.....	66
Hybrid Cold Fusion Hydrogen Reactor	67
Energy Catalyzer	67

Self-Recharging Energy Generating Gel Cells	69
Electronically Shaded Photo-Voltaic Glass	69
MuTask Dome Multiple-Output Omni-Directional Solar Power Generator	70
High Expansion Magnetohydrodynamic Liquid Metal Generator	71
Power Chip Thermo-Ionic Generator	71
Advanced Solar Photo-Voltaic Crystal Lattice Cells	72
Closed-Loop Phase-Change Gas System	75
Self-Recharging Capacitive Discharge Thermal Generator	75
Ceramic Electrodynamic Wafer	75
Organic Quinone-Based Redox Flow Battery	75
Solid Oxide Fuel Cell.....	76
Method and Apparatus for Splitting Water Molecules	78
Motionless Electromagnetic Generator.....	78
Dynaflux Alternator	80
Cosmic Induction Generator	81
Radiant Energy Pump/Electricity Generator	82
Hendershot Magnetic Motor	85
N-1 Homopolar Generator	86
Trombly-Kahn Closed-Path Homopolar Generator	86
Trombly-Farnsworth Solid-State Oscillating Electromagnetic System	86
Fossil-Fueled Generator Combo of Induction Coil Coating, Moe-Joe Orgone Energy Cell, and Fuel Mule.....	87
High-Voltage Injection of Rain Water into Cold Fog	88
Remediating Nuclear Waste with Electron-Captured Protons with Significant Net Energy Gain	88
LUMELOID™ Light-Polarizing Photovoltaic Film	88
LEPCON™ Femto Diode Photovoltaic Glass Sheet	89
Three Environmental Heat Engines	90

Rauen Cycle and Superclassical Cycle Environmental Heat Engines	90
Environmental Heat Engines could Power Cooling Pumps for 700 Nuclear Reactors after Carrington-Class Solar Flare.....	95
Capacitive step-down Transformer	101
MISCELLANEOUS	102
Super-Conductive Manganite Substrates	102
Amplified Ionization Filtration Technologies.....	102
Sola-Q Self-Focusing Omni-Directional Solar Cooker	102
Aaftaab Furnace	103
Domestic Lens.....	103
Hydrosonic Pump.....	103
IPMS-Chernovitsky Super Ceramics	106
IPMS Micro-Channels and Filters.....	107
IPMS-Kiev and Arzamas-16 Super Magnets.....	108
ADVANCED SELF-POWERED ELECTRIC TRANSPORTATION VEHICLES	109
AuroraTek’s Self-Charging Electric Bike	109
Richardson Fuel-Less Electrical Generator	111
Richardson Blade-Less Tesla-Type Steam Turbine	111
Switched Reluctance Motor	112
Water-to-Energy Electrolysis Process	112
Nova Langmuir Engine	112
Clem Over-Unity Vegetable Oil Engine.....	113
Multi-Chambered Rotary Compression Engine.....	113
Modified Cold Fusion Energy Cell	113
Conical Vortex Heat Exchange Engine.....	113
Volcheck: Engine Powered by Gas with Unusual Expansion Properties.....	114
Liquid Electricity Engine	114

Muller Motor/Generator.....	114
Perm-Mag Motor.....	114
Motive Power Generating Device.....	115
Walden Amplified Magnetic Motor.....	115
Orgone Energy Motor.....	117
Torsion Field Radio.....	118
IPMS Thermal Electric Cooling Devices.....	118
Cool Chips Thermo-Ionic Refrigerator.....	119
Compressed Air-Driven Air Conditioner/Heater.....	120
Low-Temperature Diamond or Titanium Nitride Coating of Vehicle Parts.....	120
Advanced Computer-Controlled Suspension Systems.....	120
IPMS High-Temperature Gas Plasma Detonator.....	122
BATTERIES/ENERGY ACCUMULATORS.....	124
Quantum High Energy Density Storage or Retrieval Device.....	124
Casimer Effect Self-Charging Energy Cell.....	124
Bedini Battery Charger.....	125
Catalyst Induced Hydrino Transition Cell.....	125
Maxwell Technologies Ultra-Capacitor.....	125
IPMS Crystal Lattice Energy Storage/Battery Device.....	126
Nickel-Iron Battery.....	136
NiMH Batteries; Solid-State Lithium-Ion Batteries.....	137
Liquid Metal Battery.....	138
Hutchison Self-Charged Battery.....	139
Endless Electric Field Generator.....	140
Joe’s Orgone Energy Cell.....	141
Moe-Joe Orgone Energy Cell.....	145
Thin-Film Electrolytic Cells.....	147

Please respect the intellectual property rights of the current copyright/patent holders pertaining to these inventions by obtaining their written permission before using or selling their inventions.

INTRODUCTION

A portfolio of 102 disruptive electrical energy-related innovations has been accumulated after two decades of research and collaboration with numerous inventors – a few of whom may be among the world’s most creative. Some of these inventions are so radical that they could require tens of millions of dollars each to fully exploit. It seems likely that some of these inventions of new energy sources actually work as claimed and are suitably practical for worldwide deployment. An ideal energy source satisfies all these requirements:

- Is practical, economical, and scalable from 1 kilowatt through 1000 megawatts.
- No rare elements for construction or fuel are needed.
- Operates standalone or needs minimal fuel or auxiliary energy input.
- Does not pollute.
- Can be stored and operated reliably and safely without burdensome maintenance in Death Valley during summer and the South Pole during winter.
- Is quiet.
- Inventor(s) is (are) reasonable to do business with.

Other energy researchers can provide similarly extensive compilations of new energy technologies. Tom Valone’s Integrity Research Institute (see <http://users.erols.com/iri/>), <http://www.newenergytimes.com/>, Sterling Allan’s <http://FreeEnergyNews.com/>, <http://www.infinite-energy.com/>, Jerry Decker’s <http://escribe.com/science/keelynet/>, Bruce Meland’s <http://www.electrifyingtimes.com/>, and Russia’s <http://www.faraday.ru> have all accumulated large databases of reports and comments on energy. Robert A. Nelson, P.O. Box 19250, Jean, Nevada 89019 amassed 10,000 pages on energy inventions and other scientific and technological subjects in his www.rexresearch.com – the contents of which are available on a \$13 CD.

Development and commercial manufacturing of a proven new energy source requires competent people, a doable business plan, integrity, and sufficient money to carry the enterprise until it reaches profitability. Each energy invention may be burdened with the baggage of its own unique little tale. Some energy inventors may be brilliant, of course, but are otherwise incompetent businesspeople. Development may be hampered by unethical investors or associates, an inventor’s illness or death, or suppression by existing energy industries and the tangle-footed US federal government. Shortcomings in the energy invention itself may need further research to be mitigated or eliminated, if possible.

New energy sources typically do not qualify for financial support from venture capital, large corporations restricted to operating within their chosen missions, charitable foundations, and governments unaware of or even hostile to unconventional energy sources. Some state governments have chosen to encourage innovation by offering to compensate private investors for their losses if any.

\$1 billion would establish a comprehensive energy inventions evaluation and development organization including a Nevada Headquarters, Corporate Library, Teaching Institute, Technical Advisory Board, Consultants, and Incubator of Russian Inventions. Divisions would include Large Generators, Small Generators, Miscellaneous, Advanced Self-Powered Vehicles, Batteries/Energy Accumulators, and Radioactive Waste Treatment. Examples: \$10 million for the fourth prototype of the hydro-magnetic dynamo which would safely generate 1 – 5 megawatts without fuel nor pollution; \$100 million for a prototype safe fuel-less electrino fusion power reactor which would generate a net of 1880 megawatts; \$1 million for preparing Moe-Joe orgone energy cells for sale as a quick fix for reducing gasoline consumption of existing cars by a third to half; and a half billion for advanced self-powered electric cars with several attractive new features such as compressed air-driven air-conditioner/heater, basalt/carbon fiber foam body/frame, and torsion field radio.

BRIEF SUMMARIES

LARGER GENERATORS

Hydro-Magnetic Dynamo – Hydro-magnetic dynamos are scalable from 100 kilowatts to 1,000 megawatts. For comparison Hoover Dam’s 17 turbines have a total nameplate capacity of 2080 megawatts. One doughnut-shaped, fuel-less 1000-megawatt hydro-magnetic dynamo is about the size of a two-car garage and could reliably run continuously for 25 years or more with little or no maintenance, no external fuel source, and no pollution. Russian patent 2,183,899 granted June 20, 2002. Needs \$10 million and two years to research and build a 1 – 5 megawatts fourth prototype.

Tesla’s Global Wireless Transmission of Electric Power – Nikola Tesla invented wireless transmission of electrical power. Tesla’s ultimate goal was to power global civilization with a single mammoth wireless power transmission system.

Radio and TV transmitters can broadcast to an unlimited number of receivers within range. Similarly there is no limit to the number of wireless power receivers but with no limit to the range globally.

Tesla built in Colorado Springs in 1899 an experimental wireless electrical power transmission system. It had a tower 80 feet high and was topped by a 122-foot mast with a large copper ball at the end. The system was based on a 12-million-volt 'magnifying transformer' – a giant high-frequency air core induction coil. Tesla demonstrated it by wirelessly lighting up 200 250-watt electric bulbs at the distance of 25 miles.

The physics of wireless power transmission is analyzed.

Wireless transmission of power is being replicated in Russia with modern equipment and materials based on Tesla’s design.

Focus Fusion – ‘Focus Fusion’ is the aneutronic fusion of hydrogen and boron (pB^{11}) fuel using the dense plasma fusion to create green energy. Focus fusion is much less expensive and more practical than hot fusion. Focus fusion uses a pulse of electricity that generates a plasma in a shape that makes it kink itself into a tiny little ball of lightning hot enough to fuse the atoms of hydrogen and boron. Over a million amperes of current is driven across a pair of cylindrical electrodes, creating a dense plasma where fusion reactions occur.

A powerful beam of electrically charged helium nuclei is released that is directly converted into electricity with over 80% efficiency. The second part of the energy comes out in the form of X-rays which are captured in an onion-like array of photoelectric receptors. They collect the X-ray energy and again convert that to electricity. Focus fusion produces no radioactive waste. The waste product of focus fusion is harmless, useful helium gas. Focus fusion generators will be only 5 MW, enough for 3500 homes. A 5 MW focus fusion generator may cost around \$300,000 and produce electricity for only one-third of a cent per kWh.

BlackLight Power’s Hydrino Generator – BlackLight Power, Inc., developed a catalytic reaction which causes hydrogen atoms to form lower-energy-state hydrogen atoms called “hydrinos”. Energy is released which in magnitude is between chemical and nuclear energy. Plans include retrofitting fossil-fueled and nuclear power plants and licensing nonpolluting electric cars that have a range of 1500 miles on a single liter of water.

IPMS Thorium Energy Accumulator – The I.N. Frantsevich Institute for Problems of Materials Science (IPMS), Kiev, Ukraine, developed free-standing thorium-232 isotope electricity generators. They can be scaled to power a single home and large enough to power whole communities. They also can operate for up to 300 years with no refueling and minimal maintenance. They pose absolutely no risk for critical melt-downs.

Thorium Power Pack – The thorium power pack generates 50 to 1000 kilowatts of electricity at one-tenth of current electricity prices. Thorium is sufficiently abundant that the entire planet can be powered for millennia. After ten years of continuous operation, a trace amount of U-233 is produced. U-233 recovery to re-purify the thorium is easily accomplished.

A thorium-powered reactor is inherently safe. It doesn't run the risk of 'meltdown' or explosion nor can even a dirty bomb be created. Its nuclear reaction simply stops when its neutron exciter is turned off. The simplest and smallest 'table top-sized' neutron exciter design is close to the size of a 4-D cell flashlight, and starts at about 500-kilovolt neutron output. Maintenance would be minimal.

Magneto-Gravitational Converter (Searl Effect Generator) – The Searl effect generator comprises of three concentric magnetic rings with magnetic rollers rolling around the rings. Both the rollers and rings are comprised of four layers of titanium, iron, nylon, and neodymium. A 45 x 45-cm unit can generate an output of 11 kilowatts of free electrical power.

Induction Coil Coating Increases Generator Electrical Output by One-Third – Coating the induction coils of generators with a proprietary material increases their output by one-third using the same amount of fuel.

Wind Turbine Conversion – The gearbox and brake mechanism is removed. The propeller blades are redesigned to operate at wind speeds in excess of 60 mph. Because the integrated system is able to deliver on demand during peak hours and during the night time when the wind is NOT blowing, this system would qualify for long-term power production contracts on a par with coal and gas-fired systems. The installed cost is reduced by more than 60%, and the maintenance costs are reduced by as much as 90%.

Direct Energy Conversion – New high-performance, low-cost method of generating electrical energy is possible using existing quantum physics principles and new materials. The device is solid-state and harnesses Type II superconductor technology to perform the same work function as a rotating armature.

Electrino Fusion Power Reactor – A clean electrino fusion power reactor fuses electron sub-particles, "electrinos", to generate 1880 megawatts for 100 years until shut down for refueling with 155 pounds of brass. By reversing the order-to-disorder arrow in the second law of thermodynamics, a \$50,000,000 electrino fusion power reactor could be built which may also reverse all aging and disease processes within a one-mile radius.

Plasma Biomass Gasification – Plasma biomass gasification systems produce a variety of combustible gases from a wide variety of municipal waste, biomass waste, sewage and other materials containing high concentrations of hydrocarbons with an over-unity energy efficiency of between 125%-150%. South Africa produces 100% of its diesel fuel and gasoline with two plants which operate on these principles.

Nano-Membrane Pyro-Gasification Process – Fly ash from burning coal is processed to recover carbon residue for making more electricity. Valuable ferrous and non-ferrous metal deposits are extracted from the fly ash. 551 pounds of high-grade methanol is produced from each ton of carbon dioxide which is totally recaptured from flue gases. The technology can also be applied to garbage, tires, sewage sludge, and agriculture waste.

Super Steam Technology – The "super steam" machine combines compressed air, untreated or even polluted water, and almost any combustible fuel to produce steam at any pressure or temperature. The response is instant compared with a conventional boiler taking hours to reach operating pressure and temperature. The efficiency is over 90%, which compares favorably with a conventional boiler's efficiency of 40%. Maintenance costs, fuel consumption, and air pollution all go way down. Electricity can be generated for 1 cent per kilowatt-hour. Super steam technology can be scaled from the size of a one-pound coffee can to a house. 3500 applications have been found for super steam technology.

Gas-Phase Catalytic Fusion – Activated carbon catalysts are loaded with palladium (by weight, in the range of 0.1% to 0.5%) and heated. When such catalysts are exposed to several atmospheres of deuterium gas, pairs of deuterium atoms are fused to produce waste helium-4 atoms plus abundant clean heat.

With suitable insulation, the process, once started, is self-heating. Temperatures can rise well above the boiling temperature of water. Engineered with efficient heat exchangers, thermal/electrical energy generators can be built in sizes for applications ranging from mobile homes to large centralized generating stations.

SMALLER GENERATORS

Casimer-Layered Electrodynamic Generator – A Casimir array consisting of stacked CD-ROM type disks is coated with alpha-emitter isotopic thin film, which have been super-compressed to provide room temperature super-conductivity. Controlled oscillation of the stack will produce ion flow which can be rectified and used.

Thin Film Power Generating Disks – An alpha-emitter isotope is combined with a proprietary thin film applied to a disk superficially similar to a CD which has been treated to produce a substrate with room-temperature super-conductive properties. The electrical function would be that of a self-recharging capacitor producing 2.25 volts DC at amperage that depends only on surface area. This generator would consume no fuel.

Magnetic Drive Generator – The magnetic drive generator is designed to produce 5 kilowatts. It is about 3 feet cubed. The power source is magnetic with no other power source. It produces power through magnetic induction only. The coil used in this generator is a special toroidal coil generating 10 amperes per volt. These coils have only negligible voltage drop with applied load. As load increases the voltage remains the same and amperage rises. As amperage rises the magnetic field increases thereby decreasing the resistance of the conductor. Commercial production is planned for 2015.

Hybrid Cold Fusion Hydrogen Reactor – The hybrid cold fusion hydrogen reactor is intended to be an economical super-efficient heater for buildings and greenhouses and as a hot water heater.

Energy Catalyzer – The Energy Catalyzer is a nickel-hydrogen fusion reactor which produces a few kilowatts of thermal energy with only at most a few hundred watts of electrical energy.

Self-Recharging Energy Generating Gel Cells – Nano-particulated alpha-emitter isotope materials are intercalated with conventional electrolytic materials in the presence of advanced anodic materials in a gel cell environment to produce self-recharging energy generating cells. The alpha-emitter thorium-232 increases the cell's energy density to more than 1500 watt-hours/kilogram – more than double the energy density of gasoline.

Electronically Shaded Photo-Voltaic Glass – A special layer of material between clear glass panes allows electronically controlled darkening, fully blocks infrared transmission, and generates electricity in daylight.

Multask Dome Multiple Output Omni-Directional Solar Power Generator – A simple cheap hemispherical lens made from proprietary special high impact-resistant glass, the sun's rays from any direction can be collected with minimal heat loss. Temperatures up to 1600 F. can be used to heat air and liquids. Sunlight is focused on centrally placed photovoltaic cells which do not need tracking systems and that generate electricity with more efficiency than flat panels or parabolic arrays. The MulTask Dome can also generate electricity from thermo-ionic "Power Chip" modules, magneto-hydro-dynamic devices, and Stirling heat engines.

High Expansion Magnetohydrodynamic Liquid Metal Generator of Electricity With a thermal-to-electrical energy conversion efficiency that exceeds 70%, two-phase LMMHD energy conversion systems have potentially significant advantages over conventional systems such as higher thermal efficiency and substantial simplicity with lower capital and maintenance costs. Electrical power outputs are in the 20 kilowatts range. Generator efficiency exceeds 71 percent.

Power Chip Thermo-Ionic Generator – A solid-state device that uses the physical mechanism of thermionics and quantum thermo-tunneling, Power Chips could generate electrical power directly from heat more efficiently than any current technology. Power Chips could capture heat that is now wasted and thus enable power plants to produce at least 20% more power with no increase in fuel consumption or emissions. In automobiles and other vehicles, Power Chips could replace the alternator, using waste heat from the radiator and exhaust and greatly increasing the efficiency of the internal combustion engine. Power Chips will make possible safe, efficient distributed power, enabling buildings or factories to generate their own electricity.

Closed-Loop Phase-Change Gas System – Produces 25 KW continuous output based on Langmuir reactor core thermal source, rotary compression engine, and (proprietary) input apparatus without consuming fuel.

Self-Recharging Capacitive Discharge Thermal Generator – Optimized ceramet devices are integrated with other highly capacitive elements in the presence of deuterium oxide to produce self-recharging high-density charge cluster emissions as a means to thermally charge high-density anodic targets. The heat is used to support several types of thermal exchange-based apparatus.

Ceramic Electrodynamic Wafer – An alpha-emitter isotope is combined with a proprietary thin film to produce a homogeneous crystalline material on an inert substrate. When subjected to a continuous magnetic field flux, the ions emitted by the isotopic material can be collected and rectified to perform work functions. Its output is 2.25 volts DC @ 10 - 20 micro-amperes/cm².

Organic Quinone-Based Redox Flow Battery – The organic quinone-based redox flow battery is an eco-friendly battery that replaces metal catalysts with quinone – an organic molecule that stores and transfers energy and can be found in fungi, bacteria, and even our bodies. This battery is expected to be 10 times cheaper to make and will last five times longer than a lithium-ion battery. First, two types of quinone molecules are modified to make them water soluble; then they're dissolved in separate tanks of water. The solutions are pumped through a power cell containing a membrane. That triggers a chemical reaction that generates electricity. Reverse the process, and the battery can store electricity at a cost of current batteries.

Solid Oxide Fuel Cell – Legacy fuel cell technologies like proton exchange membranes, phosphoric acid fuel cells, and molten carbonate fuel cells, have all required expensive precious metals, corrosive acids, or hard-to-contain molten materials. With inexpensive ceramic materials and high electrical efficiencies, Bloom Energy's solid oxide fuel cells can much more economically convert renewable or traditional fuels into electricity.

Method and Apparatus for Splitting Water Molecules – U.S. Patent No. 4,394,230 for method which would split water molecules into hydrogen and oxygen with a net energy gain,

Motionless Electromagnetic Generator – The motionless electromagnetic generator with strong magnets, coils, nanocrystalline cores, and an electronic controller unit may (or may not) produce net energy gain of 5.0.

Dynaflux Alternator – Every generator on Earth attempts to run as a motor in a direction which provides resistance to the prime mover. The DynaFlux alternator forces magnetic flux to move along a path parallel to the axis of rotation, rather than perpendicular to it. As a result the opposing force applies an axial thrust to the rotor, rather than an opposing torque.

The net result is that the Dynaflux alternator has consistently demonstrated conversion efficiencies far greater than 100%.

Cosmic Induction Generator – The cosmic induction generator is apparently a fundamentally new important technology with many potential applications one of which is an audio speaker made out of an electrical flame with extremely high fidelity across all frequencies. Another objective is to put a bulb containing a gas conducive to plasma creation in the middle of the intense dielectric field. The intense lines of dielectric induction cause a plasma to form which takes on the shape and form of a galaxy in space (the cosmic aspect).

Radiant Energy Pump/Electricity Generator – Like a radio receiver except that it generates usable power, it basically comprises of a large antenna connected to a complex series of high-voltage capacitors, transformers, and semiconductors. A 55-kilogram version could constantly produce 50 kilowatts of power for several days.

Hendershot Magnetic Motor – The Hendershot magnetic motor cuts the Earth’s magnetic field to develop a rotary motion. A prototype motor self-rotated at a constant speed of 1800 RPM while producing 45 horsepower.

N-1 Homopolar Generator – The N-1 homopolar electricity generator, also called the “N-Machine”, could provide cheap, inexhaustible, self-sustaining and non-polluting energy. The N-Machine uses principles that flout conventional physics and are still not fully understood. A 100-kilowatt N-1 homopolar generator prototype could power inventor Bruce DePalma’s whole house without fuel.

Trombly-Kahn Closed-Path Homopolar Generator – The Trombly-Khan closed-path homopolar generator’s output power exceeds its power input by a factor of 4.92. Coal-fueled power generators can be retrofitted to run without fuel.

Trombly-Farnsworth Solid-State Oscillating Electromagnetic System – This solid-state resonant device produces over fifty times greater electrical output than input power.

Fossil-Fueled Generator Combo of Induction Coil Coating, Moe-Joe Orgone Energy Cell, and Fuel Mule – A stationary gasoline or diesel-fueled generator’s efficiency could be nearly doubled by the simultaneous installation of three inventions: The generator’s efficiency could be increased by one-third by coating its induction coils with a proprietary material (see above). The installation of a Moe-Joe orgone energy cell could increase the generator’s output of electricity per gallon of fuel by one-third (see below). Installation of Scott Machuta’s Fuel Mule may also increase the generator’s output of electricity per gallon of fuel by 20 to 25%. A 1999 Ford Expedition with a 4.6 liter V-8 engine used 17.6 liters of gasoline in 94 kilometers without a Fuel Mule, old oil, and no tune-up. It then used only 9.0 liters in the same 94 kilometers after installation of a Fuel Mule, all new filters, oil change, and tune-up.

High-Voltage Injection of Rain Water into Cold Fog – This system converts chemical bond energy into kinetic energy by injecting rain water with a high voltage discharge of 39.8 joules. The output energy doubles that of the input energy. The energy output can be captured to drive a motorized conversion system.

Remediating Nuclear Waste with Electron-Captured Protons with Significant Net Energy Gain – Nuclear waste is remediated with electron-captured protons to generate at least nine times more energy (in the form of photons as light and electrons as heat) than is required to power the apparatus.

LUMELOID™ Light-Polarizing Photovoltaic Film – LUMELOID™ is a light-polarizing photovoltaic film about 0.3 microns thick which mimics photosynthesis. Light energy is absorbed in a molecular antenna which converts it to electron energy. The electron energy is then rectified by a molecular tunnel diode comprising an electron donor, an insulating space and an electron acceptor. Voltage and current is generated in the plane of the film parallel to the stretch axis. LUMELOID™ has a theoretical efficiency of 72%.

LEPCON™ Femto Diode Photovoltaic Glass Sheet – LEPCON™ femto diode photovoltaic glass sheets absorb light energy with a molecular antennae structure, and rectify the electron energy by electron tunneling. LEPCON™ panels covering a 150-kilometer x 150-kilometer area in a desert region could produce over 250,000 MW of electric power. Computer circuitry could be miniaturized 100-fold, efficient laser lighting devices could be produced, and high-definition 2-D to 3-D TV flat-panel displays could be vastly improved.

Three Environmental Heat Engines – The Stewart cycle environmental engine, Wise cycle environmental heat engine, and Ralph J. Lagow's patent for “Method of Generating Power from a Vapor” use ambient heat to expand a working fluid such as Freon or ammonia and move pistons through sealed chambers – resulting in net rotary output power.

Rauen Cycle and Superclassical Cycle Environmental Heat Engines – The Rauen cycle and superclassical cycle environmental heat engines use ambient heat to expand a working fluid such as Freon or ammonia and move pistons through sealed chambers – resulting in net rotary output power.

Environmental Heat Engines could Power Cooling Pumps for 700 Nuclear Reactors after Carrington-Class Solar Flare – Every century or two the sun aims towards Earth an solar flare intense enough to disable satellites, electronics and the power grids worldwide. Without electricity from the grid, the cooling pumps for 700 nuclear reactors would fail – leading to core meltdowns ala Chernobyl and Fukushima. Environmental heat engines could utilize the intense natural heat from a reactor's radioisotope decay to power auxiliary generators.

Capacitive step-down Transformer – The capacitive step-down transformer is a simpler, cheaper, lighter, smaller, nearly 100% efficient alternative to inductive transformers. Capacitive step-down transformers do not have inductive, noise, heat and sound losses of inductive transformers. Short circuits do not damage them.

MISCELLANEOUS

Super-Conductive Manganite Substrates – A substrate comprised of an alpha-emitter isotope intercalated with manganite crystalline materials is super-compressed to create room temperature super-conductive substrate materials.

Amplified Ionization Filtration Technologies – Alpha-emitter isotopic materials are deposited on the surfaces of permanently magnetized metallic foam of proprietary design to amplify ionization energies exhibited by molecules of air and fuels as they are fed to power various kinds of combustion apparatus. Each apparatus type is accommodated and tested separately using the common ionization filtration technique in various form factors.

Sola-Q Self-Focusing Omni-Directional Solar Cooker – The Sola-Q self-focusing omni-directional solar cooker, with its unique, bubble-shaped lens, collects solar rays from all angles to quickly and cleanly cook food with less hassle than with a solar box oven.

Aaftaab Furnace – The Aaftaab Furnace™ is a segmented solar collector-concentrator for melting and processing materials. Parts can be made from melting local sand (mixed with other components) and assembled together to make hemispherical lens. The Aaftaab Furnace™ could be used to make more of the same parts to be utilized for energy production, manufacturing, steam generation etc.

Domestic Lens – The Domestic Lens™ is a large, lightweight, thin and inexpensive lens for the optical industry. Telescopic large-diameter lenses can have adjustable focal lengths. To be used in telescopes, photographic, viewing and other applications at a fraction of the cost of large diameter lenses. The abrasion

resistant Domestic Lens™ would be as much as 50 times lighter than traditional lenses. They would be of higher resolution than Fresnel lens.

An inexpensive proprietary manufacturing technique allows manufacturing in most focal lengths in a very short time for large observatory telescopes. Telescopic focal lengths can be adjustable to some extent.

Hydrosonic Pump – The hydrosonic pump is a zero-pressure boiler, not a pump. Mechanical input power rotates the shaft, and plain water is converted to steam without the need for hot surfaces. Collapsing microscopic bubbles momentarily create extremely high pressures and temperatures due to fusion – technically called “sono-luminescence”. The energy conversion efficiency is around 130%.

IPMS-Chernovitsky Super Ceramics – IPMS-Chernovitsky developed uniform moldable, machine-able, ultra-high temperature, super-hard, and strategic metal-alloyed ceramic substances. These can be utilized in entirely ceramic internal combustion engines, high-speed turbines and self-lubricating bearing surfaces.

IPMS Micro-Channels and Filters – This is a family of micro-channel and filter materials with uniformly controllable orifices as small as .5 micron from combinations of carbon-fiber, basalt, ceramic and strategic metals – including stainless steel, scandium and chromium. Applications include heat exchangers, catalysts and separation of gases on a molecular level.

IPMS-Kiev and Arzamas-16 Super Magnets – Arzamas-16 in Khazakstan and IPMS-Kiev have developed a family of powerful magnets that can operate at high temperatures – up to 250 degrees centigrade.

ADVANCED SELF-POWERED ELECTRIC TRANSPORTATION VEHICLES – The fundamentally key difference from conventional electric vehicles is having an on-board battery charger or other energy source which eliminates the necessity for a half ton of batteries and for charging stations spaced along roadways.

AuroraTek’s Self-Charging Electric Bike – AuroraTek, Inc., exhibited at the 2014 International Consumer Electronics Show their self-charging electric bike which never needs to be recharged at an electrical outlet.

Richardson Fuel-Less Electrical Generator – Two pairs of electromagnets warp a permanent bar magnet’s magnetic fields back and forth across output field coils to induce a DC output voltage. With additional resonant circuit components, over-unity electrical energy conversion gain is achieved.

Richardson Blade-Less Tesla-Type Steam Turbine – Frank Richardson’s blade-less Tesla-type steam turbine has a closed-loop cycle which is far more efficient than the electric motor in terms of converting electrical energy into rotational energy for application to a vehicle’s drive wheels. The water heater’s electricity comes from the aforementioned Richardson fuel-less electrical generator. Both inventions installed on a Volkswagen Beetle enabled driving around during the early 1970’s without gasoline, oil changes, and tune-ups.

Switched Reluctance Motor – The switched reluctance motor is an old motor design reworked with modern switching components. Simple and easy to manufacture, it is to be used for powering electric vehicles.

Water-to-Energy Electrolysis Process – Water-to-energy electrolysis processes use a pulsed electrical signal.

Nova Langmuir Engine – The Nova Institute of Technology has developed its proprietary Nova Langmuir Engine. They have already completed much of the engineering and laboratory testing for the engine.

Clem Over-Unity Vegetable Oil Engine – The 200-pound Clem vegetable engine self-runs on vegetable oil at 300 degrees and is started by a 12-volt battery. The heat is internally generated by the engine. Motorists could change its eight gallons of vegetable oil only every 150,000 miles and never buy any gasoline. The engine has a hollow shaft and a custom cone with enclosed spiral channels.

Multi-Chambered Rotary Compression Engine – The prototype was designed to produce 25 kilowatts continuous output based on input from (a) air, (b) phase change gases, (c) saturated steam, and (d) other fluids demonstrating thermal values in the range of 120⁰ F – 180⁰ F.

Modified Cold Fusion Energy Cell – The modified cold fusion energy cell creates self-sustaining heat in a scalable configuration. When this thermionic cell is married to the aforementioned low-temperature closed cycle Freon/rotary engine, engines could be manufactured in a series of scalable configurations that never need fuel of any kind and can run till the bearings melt.

Conical Vortex Heat Exchange Engine – The prototype was designed to produce 25 kilowatts continuous output based on truncated conical vortex engine design concepts without consumption of extrinsic fuel.

Volcheck: Engine Powered by Gas with Unusual Expansion Properties – The special gas expands 10,000 times from 390 to 395 degrees Fahrenheit to 450 pounds pressure. Volchek used this gas in a modified Franklin aircraft engine which behaved more like a steam engine.

Liquid Electricity Engine – A single flask of liquid electricity could power a large truck for 25,000 miles.

Muller Motor/Generator – Bill Muller's magnetic motor/generator eliminates back electromotive force.

Perm-Mag Motor – The "perm-mag" motor is an over-unity energy converter claimed to have a gain of up to several times of shaft rotational power over electrical input power. The super-efficient permanent magnetic motor generates 1 horsepower per pound of weight.

Motive Power Generating Device – The Motive Power Generating Device generates more than three times as much power as its input power.

Walden Amplified Magnetic Motor – Michael Walden's Amplified Magnetic Motor runs on minimally small input power for its control electronics, but all torque and rotational motion is provided by the permanent magnets on the rotor and stator. The Walden amplified magnetic motor meets the basic requirements for electric vehicles.

Orgone Energy Motor – Dr. Wilhelm Reich in 1948 built a "synchro" type of electrical spinner motor to run from both an orgone energy accumulator and an orgone-charged high-vacuum tube.

Torsion Field Radio – The theoretical maximum capacity of torsion field communications is apparently 40 billion radio and television channels through the entire earth without attenuation at a speed of one billion times the speed of light. A radio station could broadcast from its studio anywhere in the world via the torsion field.

IPMS Thermal Electric Cooling Devices – The IPMS developed specially designed capacitors which absorb energy when subjected to a flow of electrical current – producing a cooling effect. All other known materials generate heat from electric current. Temperatures of -259 degrees Fahrenheit have been produced.

Cool Chips Thermo-Ionic Refrigerator – The solid-state Cool Chips™ thermo-ionic refrigerator is more efficient than an air conditioning compressor, resulting in increased fuel efficiency. It can be miniaturized for localized cooling of microelectronic components. Cooling devices with embedded Cool Chips can be positioned anywhere in a vehicle, enabling flexibly located on-board refrigerator/freezer and food warmers, individual drink coolers/heaters, and efficient and inexpensive seat cooling and heating. Inexpensive and simple to manufacture and requiring only non-exotic materials with moderate contamination tolerance, the cost of Cool Chips could be as low as pennies per watt capacity.

Compressed Air-Driven Air Conditioner/Heater – The compressed air-driven air conditioner/heater separates cold air molecules from warm air molecules. It can be switched between providing 90% cold air and 10% warm air, or 10% cold air and 90% warm air. Combined with an on-board battery charger, the advanced self-powered electric vehicle would have the exceptionally nice feature of continuous climate control, even while parked!

Low-Temperature Diamond or Titanium Nitride Coating of Vehicle Parts – Nondestructively coating vehicle parts such as shock absorbers with diamond or titanium nitride would enhance durability. The diamond deposition system and process can also be used to manufacture diamond-based semiconductor devices.

Advanced Computer-Controlled Suspension Systems – Computer-controlled hydraulic shock absorbers as well as the computer-controlled air ride suspension system would be supplied by Aimrite Systems International, Inc. The vehicle body is automatically leveled at all four corners, even when parked on an uneven surface.

IPMS High-Temperature Gas Plasma Detonator – A test vehicle made with IPMS-manufactured basalt/carbon fiber foam body/frame parts was reportedly the only vehicle ever tested that can cut through a cast-iron London taxicab in a collision.

BATTERIES/ENERGY ACCUMULATORS

Quantum High-Density Storage or Retrieval Device – The thin battery-like solid-state Quantum High Energy Density Storage or Retrieval device (QUENSOR™) has an energy density comparable to gasoline.

Casimir Effect Self-Charging Energy Cell – As electromagnetic energy is drawn out of the Casimir effect self-charging energy cell, when inserted in an electrical circuit, energy is drawn in from the surrounding ether.

Bedini Battery Charger – Bedini's rotary magnetic device recharges batteries, and even sometimes "dead" batteries. A Bedini battery charger was demonstrated by electrically powering a boat on a lake.

Catalyst Induced Hydrino Transition Cell – The Catalyst Induced Hydrino Transition (CIHT) cell generates electricity directly from hydrogen. A CIHT electric car may have a range of 1500 miles on a liter of water.

Maxwell Technologies Ultra-Capacitor – Maxwell Technologies' ultra-capacitors can deliver ten times the power of ordinary batteries. They can supply repeated bursts of power for fractions of a second to several minutes. They are especially useful for supercharging power for accelerations or climbing.

IPMS Crystal Lattice Energy Storage/Battery Device – Requiring only 15 to 30 minutes to recharge, IPMS crystal lattice batteries produce the same current and voltage levels throughout 98% of their discharge cycle. They produce no heat during discharge, regardless of the rate at which they are discharged. Their quick recharge capability allows them to easily capture regenerative braking energy, extending the vehicle's range. Their energy densities of between 850 and 1050 watt-hours/kg are about a third more than gasoline's energy

density of between 550 and 600 watt-hours/kg. They operate well in the temperature range of -40 to +60 degrees centigrade. A side benefit is that they are made only of proprietary materials which are environmentally friendly, plentiful, and inexpensive.

Nickel-Iron Battery – Power Technology, Inc., has developed a superior new battery with none of the drawbacks of all other types of batteries such as temperature sensitivity. It is actually a modern version of inventor Thomas Edison's nickel-iron battery. Increasing the surface area of the electroplates by up to 1000 times greatly increases current output and allows much quicker charge/discharge rates. Different chemistry reduces the weight of the battery by 50%, reduces cost, and is much more environmentally friendly than lead.

NiMH Batteries; Solid-State Lithium-Ion Batteries – The Panasonic M95 solid-state lithium-ion battery got 1000-2000 deep cycles and 100,000-150,000 miles on a battery pack and gave a range of 160 miles to the General Motors EV-1 and 110 miles to the Toyota RAV4 EV. Much more advantageous than the liquid lithium-ion car batteries now used, they can be easily mass produced roll-to-roll like printing mylar off a printing press.

Liquid Metal Battery – Invented at MIT, the high-temperature liquid metal battery has a negative electrode made of magnesium, a molten salt electrolyte, and a positive electrode of antimony. The all-liquid construction avoids cycle-to-cycle capacity fade because the liquid electrodes are reconstituted with each charge. All materials used are cheap and abundant. Modular construction allows integration to the size of a shipping container rated at 500 kilowatts with 2 megawatt-hours of storage capacity. The liquid metal battery may be especially useful for smoothing out electricity supplies from erratic solar and wind generators.

Hutchison Self-Charged Battery – John Hutchison's self-charged battery generates a perpetual DC voltage without external recharging. By stacking enough self-charged batteries into a single DC generator, the generator's DC voltage can be converted to regulated AC electricity and thereby silently electrify a house without fuel or emission of pollutants. The DC voltage could also power an electric vehicle's DC motor.

Endless Electric Field Generator – The solid-state "Endless Electric Field Generator" produces a permanent electric voltage (similar to a permanent magnet) that does not break down and is resistant to short circuits. Its permanent electric voltage can sustain a constant current through a load. A postage stamp-sized device could endlessly output one watt of constant electrical power – enough to power a cell phone for twenty years or more. Appliances and electric cars could be constantly powered without fuel and pollution. Various manufacturing techniques will use only materials that are cheap, non-toxic and in abundance.

Joe's Orgone Energy Cell – The Joe's orgone energy cell comprises of two metal containers, one inside the other. Both containers are filled with specially charged and cleaned water with the inner container perforated to allow water to freely move between the inside and outside of the inner container. The outside container is electrically connected to the anode of a battery, and the inner container connected to the battery's cathode. The outside container is closed except for an orifice to which a thin pipe is attached. The other end of the pipe is attached to the outside housing of the carburetor. Orgone energy is transferred to the carburetor through the pipe. At least fourteen vehicles in Australia have been fitted with different versions of Joe's orgone energy cells to be driven without fuel nor battery charging. The engine's power doubles over that when petrol-fueled.

Moe-Joe Orgone Energy Cell – The Moe-Joe orgone energy cell is a spherical version of the Joe's orgone energy cell. In spring 2008 a Moe-Joe orgone energy cell was installed in a 1993 Saturn. Orgone energy was transferred from the cell through a tube into the engine via its PCV valve intake. The Saturn's mileage jumped from 30 MPG to 47 MPG, and exhaust pollutants dropped by 90%. Standalone non-computerized diesel and gasoline-fueled electricity generators would consume much less fuel with a Moe-Joe orgone energy cell.

Thin-Film Electrolytic Cells – These thin-film electrolytic cells have energy densities exceeding 250-400 watt-hours per kilogram. A 1-kilowatt cell in a satellite would have only 500 cubic centimeters of active electrode.

Torsion Field Energy Applications – Sandia Laboratories in Los Alamos, New Mexico, has developed a thin-film solid-state energy storage device with an energy density in the range of 250-400 watt-hours/kilogram.

LARGER GENERATORS

Hydro-Magnetic Dynamo

Performance Claims

The electrostatic charge converter ‘hydro-magnetic dynamo’ is a doughnut-shaped ‘toroidal’ fuel-less producer of massive amounts of DC electricity. (‘Generators’ produce Alternating Current (AC) electricity; ‘dynamos’ produce Direct Current (DC) electricity.) Water is electromagnetically propelled around inside the toroid. Its theory originated from a Russian study of ball lightning in water.

Hydro-magnetic dynamos are scalable from 100 kilowatts to 1,000 megawatts. One 1000-megawatt hydro-magnetic dynamo is projected to be about the size of a two-car garage. For comparison, Hoover Dam’s 17 generators have a total nameplate capacity of 2,080 megawatts. Seven 1000-megawatt hydro-magnetic dynamos could be vertically stacked to comprise a single 7000-megawatt hydro-magnetic dynamo.

The hydro-magnetic dynamo is a doughnut-shaped emission-free standalone electrical dynamo which does not require external fueling and operates safely, reliably and cleanly at moderate temperatures. A hydro-magnetic dynamo potentially could reliably run continuously for 25 years or more with little or no maintenance, no external fuel source, and no pollution. The hydro-magnetic dynamo seems capable of powering larger transportation vehicles such as buses, trucks, ships, and locomotives. Doubt remains about making hydro-magnetic dynamos compact enough to power automobiles.

If a hydro-magnetic dynamo’s output is 1,000,000 watts, its total input power is approximately 10,000 watts. So the dynamo’s energy efficiency is 10,000%, or 100 to 1. Unlike nuclear and hot fusion reactors, the hydro-magnetic dynamo does not accumulate any radioactive components or waste.

Retired Lockheed physicist Dr. Patrick Bailey, webmaster of www.padrak.com, has suggested that if placed in a horizontal plane, and paired with another hydro-magnetic dynamo stacked on top of it with water moving in the opposite direction, the combination might lose some weight due to artificial gravity.

Third Armenian hydro-magnetic dynamo prototype

Page 1 of “Hydro-Magnetic Dynamo” PowerPoint presentation (see www.padrak.com/vesperman) shows a photograph of Russian physicist and hydro-magnetic dynamo inventor Oleg V. Gritskevich lecturing on his hydro-magnetic dynamo to the 1999 New Energy conference in Salt Lake City, Utah. Gritskevich has about 70 inventions and 20 Russian patents including a Russian hydro-magnetic dynamo patent.

A photograph of the Armenian prototype hydro-magnetic dynamo in its protective plastic jacket is shown below and also as page 3 of the Hydro-Magnetic Dynamo PowerPoint presentation. Page 2 of the Hydro-Magnetic Dynamo PowerPoint presentation shows the internal surface of the toroid being polished by a machine tool in Armenia in 1991.

Its output averaged 6,800 amperes at 220 volts DC. Its input power requirement was approximately 1% of the output power. This third prototype hydro-magnetic dynamo produced energy in Armenia from 1992 until January of 1997, when it was destroyed by fanatic Muslim militants.

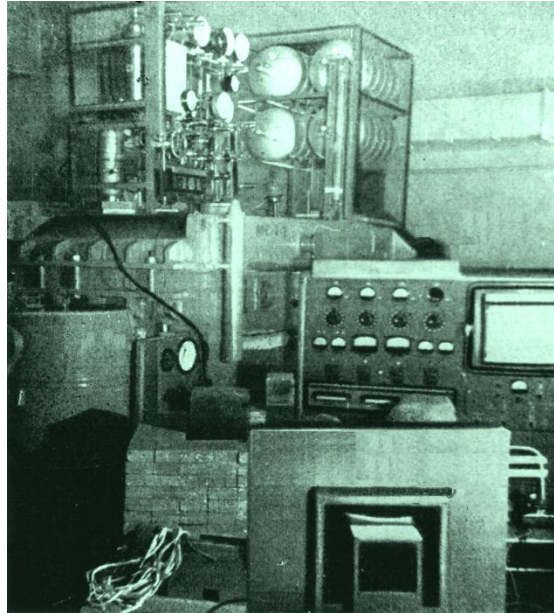

Armenian Hydro-Magnetic Dynamo in its Protective Plastic ‘Jacket’

A system layout of what would be a new 2 megawatts hydro-magnetic dynamo prototype is shown below and also in page 5 of the Hydro-Magnetic Dynamo PowerPoint presentation.

The circumstantial evidence for the Russian inventor’s aforementioned performance claims for his hydro-magnetic dynamo is reasonably strong. While three experimental prototypes have been built with Russian and Armenian expertise and equipment, a fourth demonstration prototype needs to be built with more modern Western engineering expertise and equipment to verify hydro-magnetic dynamo performance claims and to further explore the dynamo’s potential capabilities.

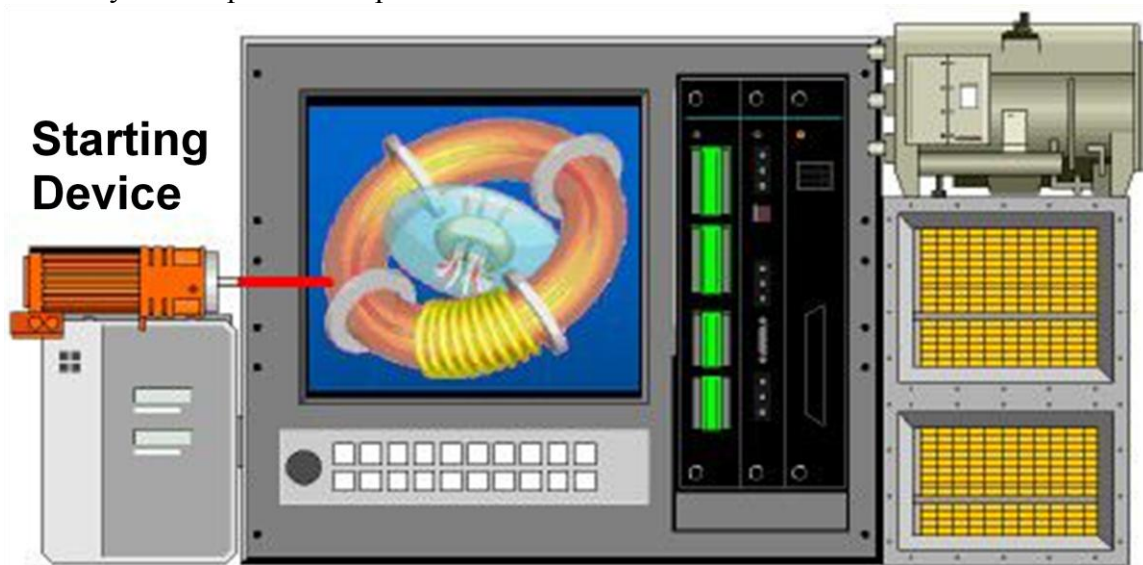

Capacitors

Two Megawatts System Layout

Source of hydro-magnetic dynamo's massive electrical output

The result of the dynamo's processes is conversion of electrostatic fields to direct current. The clear understanding of the terms like 'Coulomb's conversion' and also 'liquid Van de Graaf generator' is very important. Schematically, the dynamo is an electrostatic transformer, or in other words an electrostatic voltage multiplier. One version of the dynamo has been designed which uses lasers for starting.

The source of the hydro-magnetic dynamo's massive electrical output is a nuclear reaction which is not generally known to mainstream science. However, it is known that the dynamo produces alpha particles which are helium nuclei made from fused deuterium, an isotope of hydrogen with one proton and one neutron. The electrons missing from the helium nuclei are what seem to provide a copious 'sink' of electricity, and which happen to be the secret to the dynamo's ability to generate an exceptionally large amount of electricity.

It is known that the hydro-magnetic dynamo uses high-density charge clusters. High-density charge clusters are the basis of plasma-injected transmutation of elements and also one or more methods of neutralization of radioactive materials.

History of hydro-magnetic dynamo

The beginning for this project came as an outcome of one popular Russian magazine article (Tyehnika Maladiozhi (Youth's Technique), 1972, #8, August issue, by A. Kaldamasov, entitled "Sharovaya Molniya v Zhidkosti" (Spheroid-style Lightning in a Liquid)). This article came to the attention of Oleg V. Gritskevitch and Michail Razovskii in 1974. Oleg's group of volunteers and enthusiasts was looking for a new source of energy. This article served as a start-up point for the understanding of chemical-physical processes occurring in water.

In 1976-1978, in the basement of the city hospital in Vladivostok, in the radiological lab, Oleg and others (Vladilen Bulgakov, radiology physician, and Michail Razovskii, theoretician in the plasma physics field) spent one year assembling a device (Fig. 1) which was supposed to try to more efficiently separate water into oxygen and hydrogen. During the experiments, instead of what been expected, it produced electricity. The input for the experiment was 800 watts from a pure water pump. The output was 1400 watts. This device was assembled using plastic pipes connected with hoses, where the water was circulating in a loop. Further this lead to the idea of creating the second device as generator-toroid.

The second generator was assembled in the workshop of the Ocean Research Institute (Director Academician Viktor Ilichov) in Vladivostok, and it was transported in the summer of 1990 to the testing station of the Ministry of Electronics Industry in Vladivostok (for details please see two letters in the appendix). This lab was well-equipped with all necessary sets of instruments. At the same time patent papers were filed in the USSR's State Committee of Inventions (for details please see the appendix). In the spring of 1991 in Vladivostok arrived the State Commission, led by Yurii Lebedev, chairman of the Innovation Council at the Chairman of the RSFSR Council of Ministers. This commission arrived in town for two reasons: To recommend a request for funds for manufacturing the dynamo; and to recommend that the RSFSR's State Committee for Inventions classifies this energy source as a "Discovery" (document #14-451).

After the next government's change the financing for the project was terminated. The first article on the dynamo was published in the March 1990 issue of the Russian magazine ("Tyehnika Maladyozhi", 1990, #3, March issue, Page 17, entitled: "Idyei Innovatora" (Innovator's Ideas)).

Several Armenian physicists, after reading the aforementioned March 1990 article, sent Oleg a letter requesting to meet with him in Vladivostok for negotiations about the dynamo (please see the appendix). Their correspondence grew. They then arrived in March 1991 and made observations of the second generator, which was in working condition at this time. Oleg flew into Armenia, and the work on the third generator started in the fall of 1991. It was completed in the fall of 1992. It was working and was producing energy until January of 1997, when it was dismantled. Its output averaged 6,800 amperes at 220 volts DC. Its input power requirement is approximately 1% of the output power.

Oleg was an invited speaker of the Meeting of the Alternative Energy Institute (Dr. Fox) in Salt Lake City in August 1999. Oleg wants to note that the official announcement about his speech has several mistakes (for example, the name of Armenia was changed to Romania). This official message (with some incorrect information) was published on the web under the following URL:

http://www.altenergy.org/ine-99/Oleg_Gritskevitch /oleg_gritskevitch .html .

Oleg V. Gritskevitch's explanation of hydro-magnetic dynamo (translated from Russian)

The electrostatic dynamo-converter 'hydromagnetic dynamo' works at the expense of the process of strengthening (amplification) or maintenance stationary, in particular, oscillatory condition of electromagnetic field by hydrodynamic movements of conducting environment. The stator-toroid is produced from materials with high dielectric permance (metalloceramics). A liquid rotor comprises of pure (clean) water with high molecular connections, driven at the expense of the ordered high-voltage categories and running electromagnetic field.

Note that 7 natural and chemical laws are involved in this work:

Processes occurring in the dynamo:

Electrostatic phenomena, as in the Van de Graf's dynamo, where the isolating tape is replaced with water:

Occurs infinite wash-off of a surface by electrons from dividing layer: Kulon's conversion is going on.

Obvious "sucking" of from ions and electrons occurs from environmental space because of a huge electrostatic field (10 million volts per centimeter).

Electrostatic clamp of cavitation-vacuum structures occurs in the water.

And other processes: The installation works as one circuit, the low-frequency dynamo in a kind of coaxial circuit with a resonant points (one or more than one?) and power-driven substation inside with extremely high resonant properties.

Oleg V. Gritskevitch's email (edited) re hydro-magnetic dynamo

In my dynamo are interconnected the old and new theories, laws in physics and chemistry. I repeatedly argued with many Russian scientists concerning this invention, which consider that all physical laws and theories not shaken. They do not take into account, that these laws and theories were invented too by the people, and any scientist-person can/will make an error. The time has come to correct these errors now. I shall try to add to you the informations to that, that I gave in the brief description of the scheme and principles of activity HMD in the first letter. I shall try to give an easier description of some important moments in the scheme of activity of the dynamo.

The dynamo has the form toroid or "boublik" (I have given it such simple title). Its body is produced from a material with high dielectric characteristics (for example, most simple – optical polystyrene). On an internal surface there is raised dust – a layer of other material (is possible some versions) with higher dielectric properties. This material will interact with a liquid ‘rotor’ – pure water with high molecular weight connections, which is boosted inside the dynamo (start-up and momentum of the water – one of the most difficult phases of activity of a "boublik"). This interaction results in formation of an electrostatic field of very high voltage, which promotes ionization of water. Thus, a part of this flow is the wave of electrons that is possible to name as an ‘live’ electric current.

BaTiO₃ is evaporated on the internal surface of dynamo (torus). This layer is separating layer. The motion water collect from this layer electrons and another electrostatics charges.

The total amount of BaTiO₃ is near 1000 gram in monocrystal form. Dielectric constant is 6000. Specific impedance is 18,000,000 Ohm/cm.

The polar fluid consists only of dipoles. We used and we shall use ultra-pure water, because it is widespread, cheap and effective polar fluid. Oleg says there is more to explain.

All processes happening inside the dynamo serve the main purpose – a transformation (conversion) of an electrostatic field to a direct current. We can name the dynamo schematically as the ‘electrostatic transformer’. In this case, acts the physical law: In - how many time we reduce voltage, in - so much is increased force of a current. But it’s only an analogy – where instead of an iron yoke (the usual transformer) is used a water - energy-lifting substation. The removal of an electric current from the dynamo and transformation to an alternating current (if it is necessary) is in this case only engineering solution.

In answer to your question on the uniqueness of the HMD: Its uniqueness is that it is a new and absolutely alternative power source.

Advantages:

- Ecological safety. Radioactive materials are not used. During activity there is a small radiation of alpha-particles, but this problem to decide very easily. At the final physical destruction of a dynamo there is no contamination of the environment.
- Durability (longevity) and functionability. The scheme of the dynamo allows with use of modern materials and process engineerings to work constantly during 20-25 years. It does not require a large number of attendants. Creation of the computer system of control is possible in the long term.
- Low-cost production of electrical energy.
- Broad orb of applications. Maintenance by the electrical energy of apartment houses and industrial firms. Creation of separate dynamos by the order. A capability of application on any kind of transportation vehicle.

Email from Oleg V. Gritskevitch (edited and truncated)

To describe the HMD simply, a cluster is a complex ion consisting of simple ions (positive and negative) simultaneously in a complex with atoms, molecules and other particles. I have invented for it the title - "mush" from particles. In the HMD the dipoles of a water (H₂O), molecule of hydrogen (H₂), hydrooxical group (OH) and oxygen (O₂) enter in this "mush". The rather small dissociation energy of cluster ions results that they can

effectively fail and to be organized at small energies. It creates a large variety of cluster ions depending on a series of conditions (temperature, pressure, voltage, etc.). The important value is that in this case cluster ions play a role of the kernel of condensation ‘vapor’ of water in the closed volumes. In my case, in low-temperature plasma (water during activity in an HMD) the clusters displace ionization balance and consequently ion-exchange responses flow past easily!

During the years of my activity with the HMD I in many respects have revised the laws of physics and chemistry. I now had the theory of a construction of separate atom, periodic system, and substance as a whole. In more detail about all it we shall talk behind a glass of good Californian wine. I can tell you not only about the scientific theories, but also the histories from my life which will be interesting not only to you. For example: I worked some years with the person (he was my chief) who has left the USA and has helped the Soviet Soyuz in development of the nuclear weapon, and he was the ‘father’ of the Soviet electronic industry. His name was Phillip Staros and was my teacher.

Wet electron: exploring electron transport in polar liquids

In this project, we have studied the extra electron state in polar liquids, specially in liquid water. Different from other anionic solutes in polar liquids, the quantum nature of this system shows many dramatic departures from its classical counter-parts. As a result, first principle studies have been seen crucial to understanding this system.

Recent first principle studies of a wet electron in small water clusters have shown that the wet electron makes virtual hydrogen bonds to non-hydrogen bonded hydrogens. This novel concept of virtual hydrogen bonds implies that faster transport and larger structural deformation are allowed in the system. However, the huge calculational load in first principle calculation has been a big barrier in carrying calculations in bulk systems and confirming claims.

Following the same spirit of pseudopotentials for ions, we have developed pseudopotentials for water molecules to tackle this problem. The result illustrates that the concept of virtual bonds is valid and, in fact, plays a key role in the enhanced electron transport through newly founded transport mechanism. This work will be published soon.

In future, we are going to extend our project to include small electro-active molecules in the system to answer several pending questions in biological reactions.

More details to come...

Third Armenian prototype of hydro-magnetic dynamo

There were three hydro-magnetic dynamo prototypes built. The first two small experimental prototypes were built in Vladivostok, Russia. Work on the creation of the third experimental prototype was begun in September 1991 in Armenia and came to an end in March 1992. The third and last prototype continuously generated electricity, except when turned off to incorporate improvements, from 1992 to January 1997. (It was sadly destroyed during an armed rebellion by local religious fanatics who were unhappy with the Armenian government.)

The prototype hydro-magnetic dynamo (toroid plus water) weighed about 900 kilograms. The diameter of the toroid was about 2 meters. The toroid was made of impact-resistant clear polystyrene. The toroid consisted of two halves, which were turned on the merry-go-round machine.

BaTiO₃ crystals can be arranged as ferric or non-ferric geometries. As pure cubic crystals, yes, they are used in optical switching circuits, frequency selective filters, etc. But, by polycrystal rearrangement and proper electrical poling, one can change the basic BaTiO₃ cubic crystal form to the tetragonal, monoclinic, rhombohedral, or orthorhombic form. Mono-crystalline barium titanate (BaTiO₃) was sprayed on the internal surface of the toroid. Its dielectric permittivity was 6000. The thickness of the layer was about 1 micron.

The toroid was filled with water which was purified to the specific resistance of 18,000,000 ohms/cm. (Distilled water is a good dielectric with permittivity of about 81. Tap water is not a dielectric.) The polar liquid (pure water) consists of dipoles only, i.e. strictly oriented charged molecules. Some deuterium is added into the pure water for additional ionization.

In addition to the barium titanate deposited on the teflon-coated inner surface of the polystyrene toroid, the water itself also contains tiny barium titanate crystals with diameters of 0.001 mm or less which are suspended in the water. Ultrasound at 25,000 cycles per second is propagated through the water to form micro-bubbles on the surfaces of the suspended barium titanate crystals. Again due to the barium titanate's piezoelectric action, very high electrostatic fields are also developed within the micro-bubbles at the surface of the crystals. The electrons from the nuclear reaction are added to the electrons generated at the toroid's interior surface. The total amount of mono-crystalline barium titanate in the Armenian hydro-magnetic dynamo was nearly 1000 grams.

Stimulation coils are wound inside the toroid. By applying electricity to these windings, a running magnetic field is created which moves the water in one direction inside the toroid.

During the interaction of ionized pure water with the layer of BaTiO₃ an electrostatic field greater than 10 millions volts/cm is formed.

32 electrodes were installed uniformly around the toroid – oriented vertically with respect to the plane of the toroid and protruded through the toroid. The electrodes were made of palladium metal tubes with a diameter of about 5 mm and weighed a total of 2 kilograms. The high-voltage discharges of the 32 electrodes ionize the partially pre-ionized water further. These electrodes ‘ignite’ the hydro-magnetic dynamo. The Russian patent for the hydro-magnetic dynamo shows four electrodes indicated with the number ‘4’.

For the Armenian prototype hydro-magnetic dynamo, two 10-farad condenser jars (from Russian military radar stations) were used to provide the initial water motion (acceleration and excitation of water). Their diameter was about 50 centimeters, and their weight about 20 kilograms. Using a total energy of 20,000 joules, 100,000 volts with 0.05 amperes of current were applied to the 32 palladium electrodes for 3 - 5 minutes for starting its generation of electricity.

The reason for the very high voltage provided by the large Russian radar capacitors, when starting the hydro-magnetic dynamo, appears to be to polarize the microcrystals of barium titanate coated on the inner surfaces of the toroid and also suspended in the water. One comparison is with the electronic ignition on a gas stove. Once the barium titanate crystals are polarized, the hydro-magnetic dynamo is running.

After these Russian radar capacitors were used to jump-start the Armenian prototype hydro-magnetic dynamo, a bank of buffer batteries sustained continuous operation when water motion and ionizing occurs. This battery bank contained 8 powerful 12-volt 150-ampere lead batteries.

An electrostatic field is coupled with the action of the BaTiO₃ layer. When we apply an electrical field to the BaTiO₃ layer, this layer creates sound vibrations of about 25,000 Hz. These vibrations help to destroy the molecules of water and facilitate the further destruction of molecular-atomic structures of the water. Due to the perpetual electrostatic discharges breakdowns in cavitation vacuum structures occur and the reaction of cold

nuclear fusion proceeds. With this fusion the energy of 500 kilo-joules/mole is liberated in vacuum and the energy of 6 kilo-joules/mole is liberated in water. Thus, new hydrogen bindings form in vacuum with the energy liberation of about 20 kilojoules/mole. Due to this process the acceleration of ionization of polar liquid takes place. In addition the constant ‘washing out’ of the incomplete electron bindings from the layer of barium titanate occur, i.e., free electrons form. Due to this process the polar liquid transforms to the ordered flow of electrons and negative ions, which can be called very simply as an ionic-electric current.

During the movement of the water stream, free electrons are created, and an additional energy gets emanated because of the water's friction (viscosity) against the BaTiO₃ layer coated on the inside surface of the toroid, because of electrostatic breakdowns of cavity-vacuum structures, and because of the ongoing nuclear reaction.

The Armenian hydro-magnetic dynamo's sustaining input power was 14,400 watts. The Armenian prototype nominally generated a constant direct current of 6,800 amperes at 220 volts DC. That multiplies out to 1,490 kilowatts. The prototype's minimum power output had been 500,000 watts, and maximum power output had been 2,500,000 watts during winter experiments due to better cooling.

Additional power was received from four resonance windings. This 8 – 10 Hz alternating current after being rectified was used to charge the back-up battery. Thus, the total output power constituted more than 1,500,000 watts.

The low-frequency voltage was obtained from the load windings, and the direct current was obtained from the stabilization chamber.

The faster the water is moving through the toroid, the more electricity is generated. Once, the output current was accidentally increased to 40,000 amperes for almost a minute. Fortunately, the power was reduced to a safe level before the water started to boil. Internal coils (windings) control water velocity and therefore hydro-magnetic dynamo power.

The toroid's cooling system was a closed circuit with circulatory purified water. Copper tubes were used in this system, which were covered with glass insulation. They also were the turns of load winding. Cooling water is circulated through copper pipes wrapped around the toroid. The heat is expelled from the cooling water with a heat exchanger. This heat could profitably be utilized to generate even more electricity with an environmental heat engine such as the four environmental heat engines described below coupled to an alternator. The temperature of the toroid was maintained between 20 and 60 Celsius degrees. The working temperature was typically 36 degrees.

If the dynamo's temperature reaches up to a critical level, or its pressure is too high, due to current level (as a signal to sensor) the buffer battery will be turned off. The power supply to the winding will stop. If the water movement is supported by a combination of different energy sources, then battery will be automatically turned, and the lasers will also be turned off if lasers are used in the dynamo.

Inventor Oleg Gritskevitch has written:

The electrostatic dynamo – converter ‘hydromagnetic dynamo’ works at the expense of the process of strengthening (amplification) or maintenance stationary, in particular, oscillatory condition of electromagnetic field by hydrodynamic movements of conducting environment. The stator-toroid is produced from materials with high dielectric permance (metalloceramics). A liquid rotor is “a pure (clean) water“ with high molecular connections, driven at the expense of the ordered high-voltage categories and running electromagnetic field.

Note that 7 natural and chemical laws are involved in the hydro-magnetic dynamo.

The main processes in the hydro-magnetic dynamo are:

- A principle of Van der Graaf's electrostatic generator, where the solid insulating tape/belt was changed to the liquid one.
- A perpetual washout of the surface electrons from the spacer layer takes place;
- The Coulomb's transformations take place;
- Obvious 'sucking' of from ions and electrons occurs from environmental space because of a huge electrostatic field (10 million volts per centimeter). (In other words the dynamo operates as a huge 'sink' of electricity which can sustain an equally huge load of toaster ovens, heaters, lights, etc.)
- A single-turn low-frequency generator works as a coaxial circuit with 4 resonance points and energy carrying substance inside it that has very high resonance properties;
- Electrostatic breakdowns of cavitation vacuum structures in water take place.

Email from Louisiana materials research engineer and oil field lab manager (truncated and edited)

Date: Tue, 12 Feb 2002

I became aware of Dr. Gritskevitch's work through Faraday Labs publication "New Energy Technologies". Also through Hal Fox and Patrick Bailey's Alternative Energy Institute. After they invited Dr. Gritskevitch to speak at the 1999 Alternative Energy conference in Salt Lake City and introduce his hydro-magnetic dynamo (HMD) concept, they immediately demanded proof. They wanted him to produce the surviving Armenian witnesses as well as produce detail drawings etc. ad nauseum.

After the presentation, the inquisition began. Learned and respected men in the alternative energy field i.e., Hal Fox and Patrick Bailey and other researchers did not believe Dr. Gritskevitch and were skeptical. They accused him of not answering their e-mail after he went back to Russia. This is absurd! Dr. Gritskevitch and Boris have answered every e-mail that I sent them in a timely manner when their computer was functioning properly.

Their skepticism is highly suspect. Here's why:

- * Every cold fusion researcher in the USA has access to the entire database of studies and papers since 1987 from the same source.
- * The database information shows conclusive proof with experimental measurements for the major processes that occur in the HMD's cold fusion processes.
- * The scientific literature for electrostatic charge conversion and transformation is huge and readily available to anyone.
- * The micro-cavitation low energy nuclear fusion reaction literature with studies, experiments and measurements is huge and readily available. Not to mention numerous granted sono-fusion patents that are readily available from the US Patent Office. I know, because I have every one of them on my hard drive in TIFF. format.
- * The literature on piezoelectric ionization and activation of polar liquids, i.e., water, is large and readily accessible.
- * The literature on high-density charge clusters is huge. Their generation, manipulation and control in air, vacuum and underwater are the basis for no less than 20 - 30 patents – most notably Ken Shoulders' patents.

NOTICE THAT THE POINTS I MADE ABOVE DESCRIBE ALL THE MAJOR PROCESSES THAT ARE OCCURRING IN DR. GRITSKEVITCH'S HMD. THIS IS WHY I AM SO IMPRESSED WITH HIS WORK!

THE HMD IS A BEAUTIFUL SYNTHESIS OF MULTIPLE PROCESSES OCCURRING CONCURRENTLY THAT YIELD A DIRECT CONVERSION OF ENERGY TO ELECTRICAL OUTPUT. TRULY INGENIOUS!

I UNDERSTAND MOST ASPECTS OF DR. GRITSKEVITCH'S HMD. I will find out sooner or later the function and purpose of the four rings. My plan is to build a static cutaway model of approximately one meter in diameter. I will compile a theory presentation on the above points as to HMD processes functioning and will present this to the management of the largest electrical utility in the US. My brother works for them. In addition, I will do the same to the new technologies committee of the ELECTRIC POWER RESEARCH INSTITUTE (the Electric Utility Industry Research Consortium).

I am currently in the process of organizing a team of my associates and friends to build a one-meter functional prototype. I am calling in some favors and have secured shop space. In addition, I am having these people scavenge up various materials and parts to reduce the cost to us. The building program will be done in stages as our jobs and families permit. I already have access to the copper tubing, heavy water (which I can buy or make myself), barium titanate, batteries, huge 10.0 KJoule capacitors and other items. I am planning to incorporate what I believe is an improvement, by utilizing a "nested toroid" concept. I will place the inner segmented drive windings on a soft iron toroid and then place a polystyrene toroid shell around the windings to isolate them from the water. The outer surface will have the same barium titanate lining as the inner surface of the outer polystyrene toroid. In this manner, the distilled water/heavy water/barium titanate water rotor will flow in the toroidal annular space and be in contact with two barium titanate linings that are subjected to 25 kilohertz signals. This will allow even more powerful ultrasonic action on the water. The running magnetic field of the switched DC segmented drive coils will be more powerful since they will be iron cored instead of air cored.

Manufacturing and marketing of hydro-magnetic dynamos

After a hydro-magnetic dynamo is assembled in a factory or on site, the water is literally jump-started (by discharging a large bank of capacitors) to moving around the toroid. The hydro-magnetic dynamo's controls could be temporarily set to generating enough of a modest amount of electricity to sustain itself – even while being transported from the factory to its site (if small enough to ship as an assembled tested unit).

After a dynamo is assembled, the water is literally 'jump-started' (by discharging a large bank of capacitors) to moving around the toroid. The start impulse pressure is as high as 400 atmospheres. The dynamo's controls are temporarily set to generating enough of a modest amount of electricity to sustain itself, possibly even while being transported from the factory to the place of its future operation. The control circuits are simple as only sensors and a control computer are used. The continuous presence of technical maintenance personnel is not needed.

Internal coils (windings) provide the control of water velocity and therefore control dynamo power. The faster the water is moving, the more electricity the dynamo generates. Once the water stops circulating around the toroid, the dynamo must be jump-started again to a minimum power level before it can sustain its electricity generation with its own output power.

One of the most difficult fabrication stages of the dynamo is the process of manufacturing a working toroid. The toroid should be of absolutely ideal form and quality of processing. Inventor Oleg Gritskevitch knew only two versions of production: Manufacturing with machine tools or smelting.

Note that the hydro-magnetic dynamo, if small enough to transport as one assembled tested unit, can always be producing electricity once it is manufactured and jump-started at the factory. Whenever a locomotive is parked in sub-freezing weather, its hydro-magnetic dynamo's electricity output could be used to heat the dynamo's containment to prevent its water-filled toroid from freezing. The hydro-magnetic dynamo's excess electrical output could also be sold to the local power grid.

The hydro-magnetic dynamo's production cost is estimated at \$500 per kilowatt which is competitive to nuclear power's capital costs of \$5,000 per kilowatt, windmill capital costs of \$4,000 per kilowatt, etc. A well-run nuclear power plant can generate power for 1.5 cents per kilowatt-hour, coal 1.8 cents, natural gas 3.4 cents, and oil 4.1 cents, on the average. The hydro-magnetic dynamo's operating cost would be approximately .1 cent per kilowatt-hour with no external fuel needed and without pollution.

Hydro-magnetic dynamos could replace all nuclear power plants, solar installations, wood-burning furnaces, hydro-electric dams, windmills, fossil-fueled power plants, etc. Locomotives, heavy trucks, buses, and ships are obvious transportation applications. It does not seem that hydro-magnetic dynamos can be made compact enough to power electric cars although it certainly would be worth trying.

A Forbes article states that PECO (formerly Philadelphia Electric Company), with an income stream to back it up, was able to sell on Wall Street \$4 billion worth of bonds paying 5.8 per cent. A hydro-magnetic dynamo manufacturer could simply sell bonds to build and operate hydro-magnetic dynamos at a low interest rate. Hydro-magnetic dynamo loan payback times may be in the ball park of a half-year to a year, depending on the local electricity market price. As soon as a hydro-magnetic dynamo is paid for, the revenue from that time on would be almost pure profit.

Once a track record is established by successfully installing a few hydro-magnetic dynamos, the hydro-magnetic dynamo company could raise money to build more hydro-magnetic dynamos by simply selling billions of dollars of bonds instead of stock. So therefore, there wouldn't be any dilution of ownership.

The worldwide electrical energy market has been estimated at \$800 billion (US) per year and rising. 'There are 2 billion people who still lack electricity today, and the world demand in developing countries is doubling every eight years.' (World Watch Institute, May 1997)

An IEEE Spectrum article a decade ago claimed that world demand for electricity increases approximately 500 megawatts every day. To put this in perspective, the equivalent of another Hoover Dam would have to be built every four days to keep up with world electricity increase demands. Or, a hydro-magnetic dynamo factory would have to build another 500-megawatt hydro-magnetic dynamo every single day of the year to keep up with world electricity increase demand in addition to replacing all existing generators fueled by hydro, nuclear, wind, solar, geothermal, and fossil fuels.

Summary of hydro-magnetic dynamo patent description

The following is a highly condensed summary of the "Description" of the hydro-magnetic dynamo's Russian patent IPC H 02 K 44/00 for "Method of Deriving of Electrical Energy and Organization of Gritskevich's MHD-Generator for its Realization":

The dynamo is a sealed toroid filled with distilled water with heavy water (deuterium oxide) added. Movement of water inside the closed loop and use of unique properties of water as a polar liquid causes a release of electrical energy as an outcome of a rupture of hydrogen connections. Additional electrical energy is drawn from nuclear reactions and micro-cavitational processes. The liquid gets ionized and moving around the toroid

at start-up time by a running magnetic field with the help of stimulating electromagnetic windings.

A layer of segnetoelectrical material covers the internal surfaces of the toroid. 32 electrodes made from a hard-alloy material are inserted into the toroid at equal distances apart. These 32 electrodes are connected to a power supply. Additional stimulation windings are also connected to the power supply.

The partially pre-ionized (on the part of the heavy water) water gets ionized further by the high-voltage discharges by the 32 electrodes. With the help of the stimulation windings, a running magnetic field is created which moves the water in one direction inside the toroid. An electromotive force gets created by the electromagnetic induction in a separate set of windings. During the movement of the water stream free electrons get created, and an additional energy gets emitted because of the water's friction (viscosity) against the layer coated on the inside surface of the toroid, because of electrostatic breakdowns of cavital-vacuum structures, and because of the ongoing nuclear reaction. 100 times as much electrical energy is generated as required for electrical energy input.

(End of patent summary)

The complete translated text of the hydro-magnetic dynamo Russian patent with two drawings is available in www.padrak.com/vesperman.

The hydro-magnetic dynamo's inventor Oleg V. Gritskevich is no longer with us. His hydro-magnetic dynamo work is being carried on by his son Boris Gritskevich with the assistance of his partner Alexander Alevanau. Alevanau wrote the following paper on the physics of the hydro-magnetic dynamo:

About mechanisms of generation of energy in HMD of Oleg V. Gritskevich

Due to specialty of construction of HMD, there are two interconnected mechanisms of energy generation in the device joined with the way to extract energy out of the device in mostly usable form.

1. Main mechanism is supposed to be based on nuclear synthesis on nuclei of deuterium and hydrogen. To make it happen with non-zero probability in super pure water diluted by heavy water, the following peculiarities of HMD construction and operation come to work:
 - a) The device is fired to continuous work by series of discharges made inside its torus together with application of accelerating magnetic field running along the torus with maximums of its intensity around currents of the discharges.

This joint action creates two effects:

- I. Penetration of atoms of hydrogen and deuterium into crystal lattice of palladium electrodes, used for discharges. The atoms are released from water molecules due to rapid electrolysis in discharges.
- II. Ejection of palladium micro particles takes place from electrodes in the discharges. Action of Lorentz force on moving current carriers and the particles partially doped by hydrogen and deuterium atoms is directed to the side from the channel of the discharge. It gives mechanical impulse to the water for rotation along the torus.
 - b) The doped particles of palladium accelerate water in torus and become distributed in the whole its volume. Then these particles take part in so-called mechano-induced nuclear reactions due to possibility for nuclei to approach each other while being incorporated into the crystal lattice of palladium subjected to mechanical shocks and

destruction^{1,2}. The phenomenon was researched and approved by detection of high energy electrons and gamma photons emitted by deuterium possessing crystals subjected to mechanical crashes.

- c) Mean for perturbation of crystal lattice of palladium particles doped by atoms of deuterium and hydrogen in water is provided by shocks emitted from collapsed bubbles created by cavitation.

The latter phenomenon has both hydrodynamic and acoustic origins due to overall rotation of liquid inside the torus and due to segneto- and piezoelectric properties of layer of BaTiO₃, which is manufactured on the internal surface of the torus. Both spontaneous electric and piezoelectric acoustic impulses from parts of the layer excited by discharges and hydrodynamic instabilities in the flow provide with the same effect for palladium crystal lattice, as it was in the beginning of the process with initial discharges. It obtains doping by atoms of deuterium and hydrogen and it receives mechanical perturbations and crushes both from shocks from collapsing cavitation bubbles and shocks from micro discharges or sparks near the layer of BaTiO₃. The small palladium particles also serve as centres for the bubbles to grow and collapse on.

2. Another physical mechanism works simultaneously or even without mechano-emission of high energy elementary particles from palladium lattice. It was proven by experiments with acoustical shocks from application of high power electrical impulse to arc shaped wire in porous heavy water filled by bubbles of D₂^{3,4}. Such an application explodes the wire and creates shock waves collapsing the bubbles of deuterium (D₂). It generates simultaneously registered burst of neutrons from the media.

We assume, as it was stated in many works on sono-luminescence and in experimental investigations of cavitation, that internal moving surface of the collapsing bubbles becomes highly and non-uniformly electrified and may be considered as set of excited and rotating dipoles during collapse of the bubbles. High internal electrifying of the bubbles may create partial screening of the Coulomb repulsive potential thus increasing probabilities for hydrogen and deuterium nuclei to penetrate the barrier.

The rotating and collapsing dipoles in the bubbles form vortex micro currents interacting with external magnetic field. This interaction plays main role in the mechanism allowing energy to be extracted from the device.

Thus the main source of energy generation in the device is the well known nuclear reactions of synthesis on both deuterium and hydrogen nuclei taking place simultaneously with motion of excited electrical dipoles formed in collapsing cavitation bubbles, which are distributed in the whole torus volume and in proximity to the double charged layer near the segnetoelctric layer of BaTiO₃.

As the dipoles rotate during collapse of the bubbles alone and in proximity to micro particles of palladium doped by atoms of deuterium and hydrogen, the short-time vortex currents are created. These currents interact with magnetic field from accelerating coils around the torus.

¹ Deryagin B.V., Kluev V.A., Lipson A.G., Toporov Y.P, About possibility of nuclear reactions during destruction of solids, Colloidal Journal, 1986, №1, P. 12-14.

² Дерягин Б.В., Ключев В.А., Липсон А.Г, Топоров Ю.П. О возможности ядерных реакций при разрушении твердых тел. - Коллоидный журнал, 1986, № 1, с. 12-14.

³ Biturin V.A., Bykov A.A., Velikodny V.Y., Dyrenkov A.V., Tolkunov B.N. , Theoretical and experimental investigation of action of shock wave on deuterized porous liquid, Electronic Journal "Physico-chemical kinetics in gas dynamics", T6, 2008, <http://www.chemphys.edu.ru/article/133/> .

⁴ Битюрин В.А., Быков А.А., Великодный В.Ю., Дыренков А.В., Толкунов Б.Н., Теоретическое и экспериментальное исследование воздействия ударной волны на дейтерированную пористую жидкость, Электронный журнал «Физико-химическая кинетика в газовой динамике», Т6, 2008 <http://www.chemphys.edu.ru/article/133/>.

The currents receive mechanical energy for ones acceleration from nuclear reactions taking place in centres of bubble growth and collapse.

Such centres might be in a form of palladium particles mechanically excited and crashed by the shocks from collapsing bubbles. Another form of the centres is the hydrodynamic instabilities created by turbulence, acoustical and electrical shocks in the medium in its overall motion.

The bubbles receive mechanical energy for ones faster rotation in collapse from reaction of synthesis in both cases.

3. Due to interaction with external alternative magnetic field, part of the bubbles obtains inducted *Foucault* vortex currents, which will interact with accelerated by nuclear reactions collapsing vortex currents. As spatial directions and planes of these vortex currents are chaotic, the inducted currents and the field itself will partially orient the vortex currents in the planes of accelerating coils.

The oriented and chaotic currents will interact with external magnetic field providing the medium with mechanical impulses along its motion or in opposite. The impulses will transmit energy obtained from nuclear reactions to the flow. The fact that the liquid is already moving allows one to say that impulse of force ($dF = dPdt$) transmitted to the liquid along its motion will exceed the impulse in opposite. That is due to the fact that time of interaction with water of collapsed vortex currents and excited dipoles pushed by magnetic field along direction of overall motion in the torus will exceed the same in regard to the opposite direction.

Additional source of mechanical impulse given to the water from the reactions and magnetic field exists due to possibilities for the described nuclear reactions to take place in proximity to micro discharges near the layer of BaTiO₃ in excited double electrical layer of interface with super pure water.

As these reactions give more mechanical energy to motion of the charges in the discharges, their energy is immediately transmitted to motion of the liquid by action of Lorentz force acting on all the discharges from the layer. This action provides liquid with mechanical impulse to the direction of overall liquid motion. The main reason for presence of the patented condition for dielectric constant of the layer to be higher than that of the liquid is in possibility to have all the micro sparks in the same direction in relation to the layer.

As the layer of BaTiO₃ works also as dielectric in the condenser made up by the first plate as one part of the double electrical layer and the second plate as metal of the induction coils on external surface of the torus, the hydrodynamic instabilities near the layer join with spontaneous segneto-electric electrifying of BaTiO₃ and create possibility for induction of electromotive force along the second plate of the condenser.

In such a way of induction the main condition for creation of electromotive force is motion of highly and non-uniformly charged layer of the liquid being constantly disturbed by discharges of micro sparks. Such a liquid has to be super pure for that. These conditions are created in the device and are necessary both for generation and for extraction of energy from the device.

Distinctive role in all the described mechanisms belongs to acoustic excitation of the layer of BaTiO₃ during initial discharges between the palladium electrodes. Such an excitation may create initial uneven distribution of charges along internal surface of the layer and start micro discharges interacting with magnetic field from accelerating coils. This interaction may give initial mechanic impulse for the liquid on periphery of the torus.

Joined with the same action on currents from the discharges between the electrodes, this acceleration may provide with enough speed for the liquid to create more hydrodynamic instabilities both for cavitation and for acoustic excitation of the layer. The later one creates positive feedback for assisted by acoustic shocks creation

and collapse of the bubbles with further conditions necessary for driving of nuclear reactions and water inside the torus.

(End of hydro-magnetic dynamo physics article)

The hydro-magnetic dynamo's use of extremely scarce palladium limits its potential applications. Experimental studies of similarly energetic particles emitted from hydrogen/deuterium loaded palladium and titanium indicate that palladium could be replaced with more abundant titanium. These experiments were conducted by Professor George H. Miley, Department of Nuclear, Plasma and Radiological Engineering, University of Illinois at Urbana and Champaign, Illinois, and four Russian scientists. Their report is titled "Phenomenon of an Energetic Charged Particle Emission from Hydrogen/Deuterium Loaded Metals" and is available at www.padrak.com/vesperman.

On page 8 of the aforementioned Hydro-Magnetic Dynamo PowerPoint presentation, Boris Gritskevich estimates that to research and build with Western engineering a fourth prototype of modern components with an output of 1 to 5 megawatts, it would take approximately two years at a cost of \$10 million.

This paper includes a comparison of water as a polar liquid and benzene as a non-polar liquid:

<http://www.phasedynamics.com/OscPull.HTM>

<http://www.worldscientific.com/worldscibooks/10.1142/2619> - "Dielectric Relaxation and Dynamics of Polar Molecules"

<http://www.free-energy-info.tuks.nl/Issue2.pdf>

<http://www.scribd.com/doc/76068285/Free-Energy-Inventions-Dossier-2>

<http://www.spiritofmaat.com/archive/mar2/fox.htm> (To read the text without the strange vertical black bar, select the entire text with Control A.)

www.rexresearch.com/gritskevich/gritskevich.htm

Russian Patent, Priority: RU 99118347 filed 24.08.1999; now – Patent RU 2183899 granted on 20.06.2002

www.padrak.com/vesperman – "Hydro-Magnetic Dynamo PowerPoint presentation",

"Phenomenon of an Energetic Charged Particle Emission from Hydrogen/Deuterium Loaded Metals",

"Complete translated text with two drawings of Hydro-Magnetic Dynamo Russian Patent IPC H 02 K 44/00"

Tesla's Global Wireless Transmission of Electrical Power

Nikola Tesla built in Colorado Springs in 1899 an experimental wireless electrical power transmission system. It was located in a field near the Colorado School for the Deaf and Blind on the east side of town. The outlandish structure had a tower 80 feet high and was topped by a 122-foot mast with a large copper ball at the end. The system was based on a 12-million-volt 'magnifying transformer' – a giant high-frequency air core induction coil. Famous early photographs show Tesla seated in his laboratory amidst spectacular electrical sparks emanating from the magnifying transformer. A comprehensive Tesla photo gallery can be found by googling "photographs of Tesla and his magnifying transformer",

The lab was designed to carry out research on electromagnetics and to test his new theory of wireless power transmission. Toward that end, he had perfected what he considered his greatest invention: a magnifying transmitter – a high-voltage, high-frequency device.

When the time came to test his grand theory of wireless power transmission, he installed a bank of 200 250-watt bulbs at Palmer Lake, 20 miles away. After injecting voltage into the ground at the lab site, bolts of electricity shot upward from the mast of the lab in a dazzling display of pyrotechnics. More importantly, Tesla was overjoyed to see a golden glow on the northwest horizon as the bulbs at Palmer Lake illuminated.

Tesla considered the experiment a great success; however, area residents were not as enthusiastic about the performance. The surge of power burned out a city generator and threw the entire town in darkness.

Dr. Donald Lesiak is quoted in <http://www.teslasociety.com/teslabanquet.htm>: “The transmission of wireless electricity through the air and ground is possible. Tesla lit up 200 electric bulbs at the distance of 25 miles in Colorado Springs, Colorado, 1899. This wirelessly transmitted electricity could be used to power electric automobiles and other electrical vehicles without gasoline engines and gas tanks. This could be done by installing an antenna and power receiver in the vehicles.”

An unlimited number of radio and television receivers can receive signals from transmitting towers. However, radio and TV signals weaken with increased distance from the transmitters (and occasionally also because of interfering hills or structures in the line of sight between tower and receiver).

The electrophysics of wireless electrical power transmission are very different from radio and television signal transmission. The power received from wireless electrical power transmitters would NOT significantly decrease with distance. Thus an unlimited number of power-consuming receivers such as appliances, air conditioners, industrial machinery, and electric vehicles could receive power from wireless power transmitters. In fact Tesla's ultimate goal was to electrically energize global civilization with a single wireless electrical power transmission system.

In 1901 Nikola Tesla began building a much larger magnifying transmitter at Wardenclyffe on the east end of New York's Long Island. The colossal magnifying transmitter was to have an output of 10,000 horsepower at 100,000,000 volts. The wood-framed tower was 186 feet (57 m) tall, and the 55-ton metal cupola (dome) was 68 feet in diameter and 34 feet tall.

The transmitter itself was to have been powered by a 200-kilowatt Westinghouse alternating current industrial generator. A massive underground structure grounded the transmitter. Beneath the tower, a shaft sank 120 feet (37 m) into the ground. Sixteen iron pipes were placed one length after another 300 additional feet (94.4 m) in order for the machine, in Tesla's words, "to have a grip on the earth so the whole of this globe can quiver”.

Indicative of stupendous power was Tesla's test starting on July 15, 1903 and for the next couple of nights. The transmitting tower was still a mere skeleton – nowhere close to being finished. Tesla set up a few additional poles (antennas), and then fired up the generators that brought the wireless plant to life.

From the poles and the top of the dome of the tower bolts of lightning shot out for miles which actually lit up the sky and could be seen for literally hundreds of miles. At times the surrounding area was filled with streaks of lightning shooting into the darkness. The residents of the area were literally treated to an electrical fireworks display.

Tesla's plan was to power the magnifying transmitter with electricity from Niagara Falls or with on-site steam-powered turbine generators. Then this single magnifying transmitter was to power all of global civilization with radio-broadcast electricity. See http://en.wikipedia.org/wiki/Wardenclyffe_Tower and http://www.teslasociety.com/tesla_tower.htm.

Gary Vesperman's websites www.padrak.com/vesperman and www.commutefaster.com/vesperman.html link to a truncated reproduction of Eric Dollard's "Representations of Electric Induction" that was originally published in pages 2-25 through 2-82 of the "Proceedings of the 1986 International Tesla Society Symposium". Only pages 2-25 through 2-63 are included in this copy of Dollard's article. It was truncated both to reduce the size of the file and because the highly mathematical remainder of Dollard's article may be of interest only to a limited

readership. Dollard explains much of the theory of electromagnetism. Dollard also presents the physics of Nikola Tesla's wireless electrical power transmission system.

Vesperman's two websites also link to his compilation of "Space Travel Innovations". This ebook includes a chapter titled "The Magnetic Force is Faster than Light". Its Brief Summary is copied as follows:

The Magnetic Force is Faster than Light – The phase-conjugate-resonator Tesla coil is a relativistic force magnifying transmitter with no theoretical limit to its effective coherence length. The author models a topological-time constraint that can uniquely define a system of past-directed and future-directed wave-fronts in terms of a hypothetical 'T-plasma'. The transmitted energy reaches receivers *without the slightest dispersion*, so that an incomparably greater amount of energy can be collected than is radiated.

One important application of wireless energy would be for powering flying machines without ground connection. Tesla developed a safe, small and compact 'aerial flyer' capable of rising and descending vertically. Buildings and transportation vehicles, e.g. cars and drones, could also be remotely powered.

Stimulated excess entropy-production results in the cold nuclear fusion of aluminum into silver and the release of 'frozen' electronic charge similar to ball lightning.

(End of excerpt)

Gary Vesperman's websites www.padrak.com/vesperman and www.commutefaster.com/vesperman.html link to "A Technical Analysis of Tesla's Extra Coil as a Slow-Wave Helical Resonator". This enlightening technical analysis characterizes the magnifying transformer's 'extra coil' as a distributed circuit or loaded transmission line, and not in terms of lumped circuit elements.

Additional source: "Terrestrial Night Light", R. James McCabe, Exotic Research Report, April/May/June 1999, pp. 40-47.

Toby Grotz has authored "Wireless Transmission of Power" – see <http://uncletaz.com/library/scimath/tesla/wiretra.html>. Grotz reports that 1972-1973 Robert Golka built a prototype high-powered energy tower which had some similarities to Tesla's wireless power transmitting tower. It was used by the US Air Force until 1982 to test the vulnerability of fighter planes and other aircraft to lightning.

Robert K. Golka, 400 Warren Avenue Brockton, MA 02403, a physicist and former director of Project Tesla at Wendover Air Force Base in Utah, is an authority on large-scale Tesla coil operation. During the period from 1973 to 1982, he operated the world's largest Tesla coil (25 million volts) in order to test military aircraft. His other interests include the search for the elusive answer to one of nature's most spectacular mysteries fireballs.

The purpose of the program was to evaluate the Tesla coil as a laboratory tool for lightning effects research on aircraft. The ability of a Tesla coil to generate high-voltage pulses at high repetition rates results in the capability to create artificial lightning-like streaming and long electrical discharge arcs and makes it a desirable alternative to the high-voltage impulse generators currently in use. Another characteristic of a Tesla coil is that many long arcs can be generated over a very short time period. These Tesla coil characteristics are highly desirable in lightning effects research using full scale (e.g. an actual aircraft) test specimens. See Figure 1 which includes a sketch of Golka's Tesla coil.

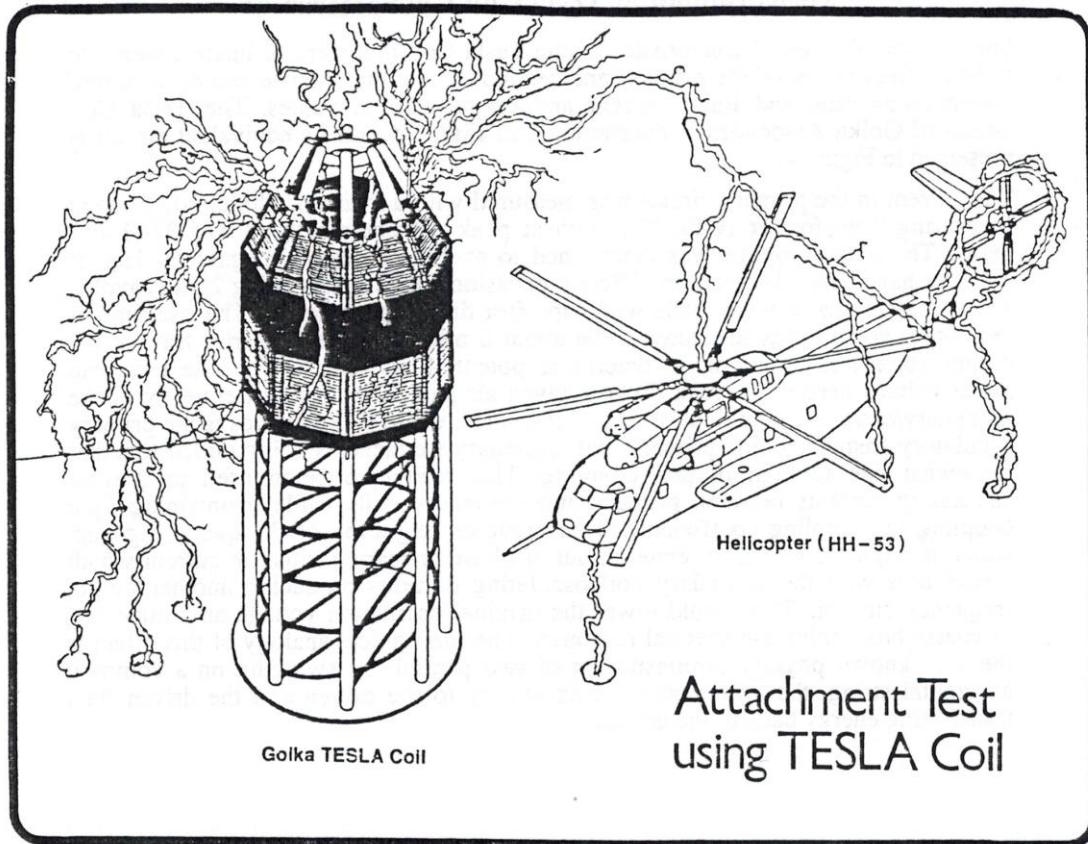

Figure 1. Aircraft Attachment Test Using a Golka Tesla Coil

During the attachment tests when the model aircraft was fairly near the discharge electrode and the Extra Coil, an arc attached to the canard and swept up the aircraft to the nose. This phenomenon cannot be duplicated by Marx Generators. The reason for it appears to be due to the magnetic field sweeping the Extra Coil. The fields outside the coil near the center (half way up) loop outward, with the frequency of the output and the magnetic flux changing, the arc is being pushed away from the coil, thus protecting its insulation to a degree from the corona and low current sparks. This may be an application for swept stroke testing and should be investigated.

Measurement of Tesla Coil Characteristics

Some of the physical characteristics of the Tesla coil that were of interest were the resonant frequencies of the primary and secondary circuits, the rise and delay times, commutation rate, and input current and output current values. The Tesla coil circuit of Golka Associates is diagrammed in Figure 2, and its equivalent circuit is presented in Figure 3.

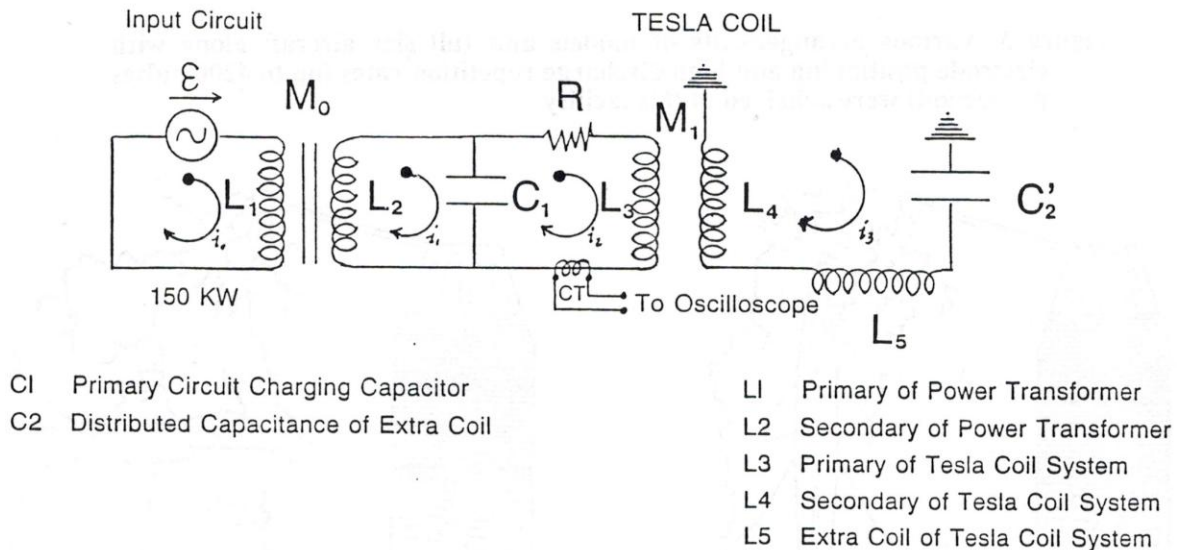

Figure 3. Equivalent circuit of Golka Associates Tesla Coil.

The current in the primary circuit was measured with a Pearson Model 301 Current Measuring Transformer (CT). The highest peak current measured was 3240 amperes. The output voltage was determined to average about 10 megavolts. Higher voltages had been observed on different occasions – the highest being 25 megavolts. These measurements were made with capacitor divider techniques. The rise time of the output voltage was measured to be about 5 microseconds. The rise time of the output voltage is important to determine potential arc length. The rise time can affect the voltage needed to break down a given air gap. The ringing frequency of the secondary/extra coil combination is 50 kilocycles, while 30 kilocycles is the primary oscillatory frequency; the primary and secondary frequencies being pulled together somewhat due to high mutual coupling. This technique was used to prevent circulating currents between primary and secondary coils while maintaining tight coupling (.6 coupling coefficient). This prevents reignition of the quenching gap, which if reignited would generate an out-of-phase primary oscillation current which would beat with the secondary coil oscillating currents – producing another output frequency current. This would lower the original oscillation voltage amplitude and of course broaden the spectral response. The mechanical analogy of this effect is the well known physics demonstration of two pendulums swinging on a common horizontal string – the driver transferring energy to the driven, and the driven then transferring energy back to the driver.

Source of Golka's Tesla coil information: "Long Arc Simulated Lightning Attachment Testing Using A 150Kw Tesla Coil", Proceedings of the 1986 International Tesla Society Symposium, pp. 2-103 to 2-109.

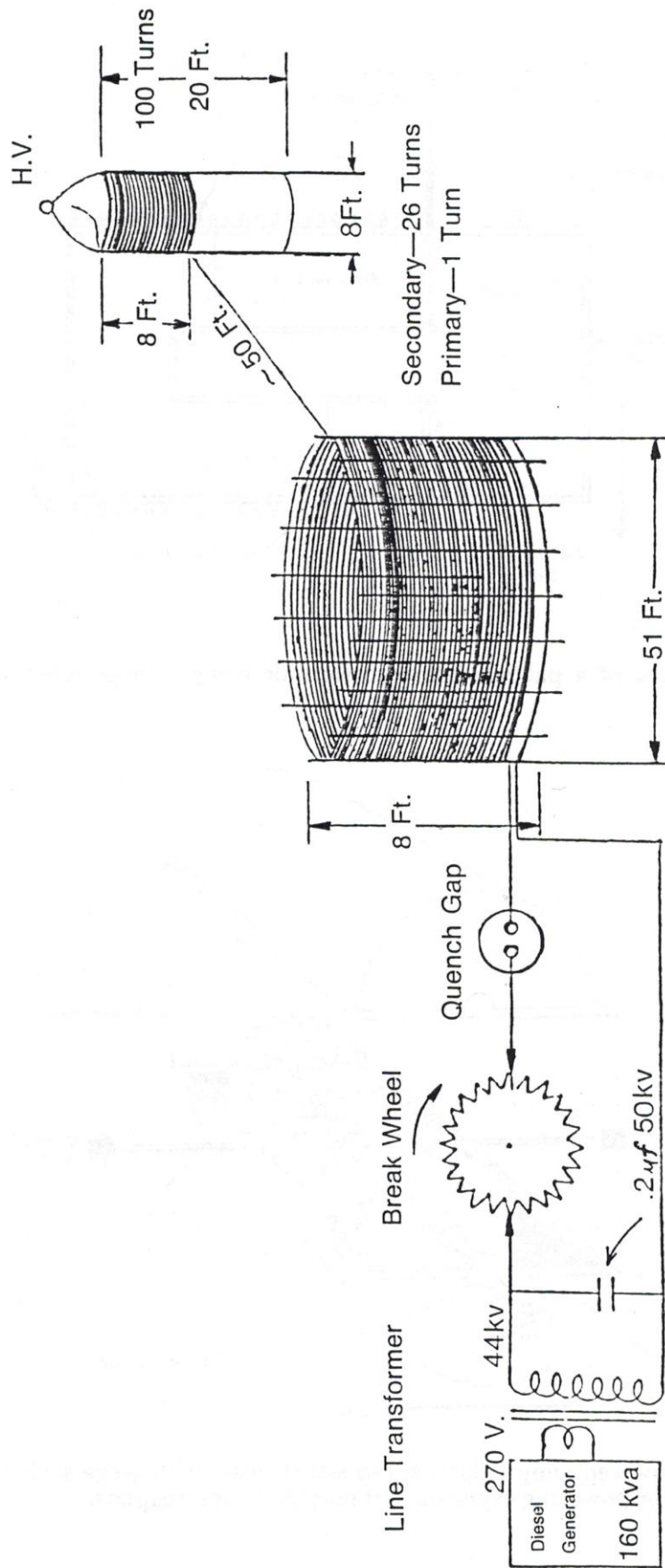

Figure 2. Schematic Diagram of Golka Apparatus at Wendover

The 'Planetary Energy Transmitter' is to be a modern replication of Tesla's global wireless electrical power transmission system. See <https://www.indiegogo.com/projects/lets-build-a-planetary-energy-transmitter> and <http://globalenergytransmission.com/index.php/en/latest-news/61-simplified-explanation-of-the-working-principle-of-planetary-energy-transmitter>. The following was extracted from these two websites:

Nikola Tesla had left us a very detailed description of the design of his Magnifying Transmitter system and the physical principles of its operation. We are a group of modern-day physicists – trained in many areas related to the operation of his Worldwide Energy System. We've conducted a thorough scientific expertise of his works and came to the conclusion that Tesla was on the right track. Moreover, the experimental data accumulated by modern physics after the departure of The Inventor by means of satellites and ground observations proves that the System may be a key to the next big step in building energy systems for the humankind – **harnessing the energy of Solar emission reaching our planet as he had envisioned it more than a century ago**. Modern materials and equipment provide us with an incredible opportunity to re-implement the invention of Tesla and build a solution of the energy transmission problem Today! **We've re-designed a version of Tesla's Wardencllyffe tower based on his principles but using modern materials and advanced electronic components and are ready to build it**. We have a detailed plan of physical experiments with this first tower of the Worldwide Energy System that will sure be built in the future and are asking for your support and contributions to start this research program.

We have great news for you – this time has come! Our research team is already building the 'new Wardencllyffe' tower right now. We've conducted the fundamental research studies, implemented the computational models and designed all the parts of the experiment. We will be able to perform energy transmission and measure the results. Will it be 'global' as Tesla suggested? Based on the research that we've already done – we believe it will be, and we going to prove it experimentally.

We are planning to erect the tower in August-September of 2014. It will happen right in front of your eyes!

We will be able to get the first results in a few months after the completion of the tower and we are really in need for substantial financial support due to the large scale of this research program which will result **in reviving the heritage of The Inventor - Nikola Tesla that had devoted all his life for the sake of the whole humankind. We urge you to become a part of this exciting research program or sponsor it**. Help us to inherit the helm of the great scientist. Let the new solutions in a field of energy development to become reality. Support our project!

Did you know that...

- The weight of the original Tesla Tower's prototype was more than 60 tons. It was heavy... With the modern materials and design we were able to implement a light-weight tower's design with the weight of only 2 tons; all the important parameters of this prototype strictly adhere to those that were described in the Tesla's patents! The project information is available here.
- Our research team elaborated and described the physical concept of the Tower's working principle and it strictly complies with the modern principles of physics. This concept is very well described in plain language in our article «Examining Working Principle of Tesla Tower».
- The direct computation by means of the software package Ansoft HFSS demonstrate the concept of the resonance of standing waves produced by a system like ours. The model demonstrates that it is possible to transmit energy globally by means of using the Tesla's Magnifying Transmitter.

- We spent over 5 years to conduction of the theoretical research and experimental studies. The results of our work were publicly discussed at the open seminar which was held in the General Physics Institute of the Russian Academy of Science with the support of the Tesla's Heritage Foundation (located in Serbia)
- Ten kilometers of the aluminum strip with the width of 16 mm will be used for the resonator's winding in the erected tower. Thus, the coil about 20 m high will be built.
- Our research team is involved into elaboration of the power source for the Tower. Hence, we implemented the power unit, which has unique specifications.

For the safety reasons, the Tower's power unit will be controlled remotely by means of the RC unit via fiber-optic cable.

- This is the second round of funding. In the end of 2013, we ran the crowdfunding campaign to obtain the kick-off funding in the Russian platform. We managed to collect around \$40K. Now, as the first round of our research work is approaching its final stage, we are finally ready to disseminate the research results that were achieved so far. Thus, we would like to announce full-scale research program. Our main goal is to collect the funds which are necessary for conducting the further investigation on this matter. We would be able to do it if you would help us to move forward!

How it works

In short, Tesla system on energy transmission uses the ground surface as well as the Earth-Ionosphere waveguide like a sort of analogue of simple wire, which can be used for transmission of electrical energy over large distances. At that, transmission of considerable amount of an energy via such 'wire' (upper layers of the ground plus waveguide The Earth-Ionosphere) is possible due to existing coupling between resonance circuits (Tesla Towers) and with high efficiency factor value, yet with causing no harm to environment.

Simplified explanation of the working principle of such system can be found at the link.

We suggest that those with knowledge in the subject area would take a look at the article where the working principle of Transmitter is described in details.

What is the Planetary Energy Transmitter? It means a whole wealth of opportunities!

- It is a great opportunity to become **independent of the transmission lines!**
- It is a chance for agility. Planetary Energy Transmitter will ensure **energy provision anywhere in the world!!**
- its use allows **drastic improvement of environmental health** as well as **employing the desert's energy!!!**

If it happens so that we will collect a sum above the expected we will be able to translate and study the materials which are carefully preserved in the Tesla's museum located in Serbia. In this case, we will surely provide open access for all related materials regarding the matter. Believe it or not, but the greatest part of the oldest materials being preserved in the Tesla's archives has never been studied by the scientists. It is hard to imagine what kind of amazing things can be discovered during a thorough examination of his works! We might be able to learn something new and exciting from the unknown works of the great scientist as well as make these works available for the vast numbers of enthusiasts that are interested in these kinds of things. This is really big, complicated and very important work that can be done with your help! And with our great passion towards Tesla's works, as well!

You are free to believe or be skeptical about global energy transmission via the entire Planet. Our goal is a bit different – we think that **it is very important to recreate these Tesla's works**, conduct their examination on a large scale and, maybe not only prove that he was right, but also to unleash new pages in the history of mankind. As a matter of fact, Tesla devoted all his life to this work...

In turn, we can guarantee that every donated dollar will be used for conduction of the research works, acquisition of the required equipment, collaboration with the best professionals, design and implementation of the prototypes as well as conduction of the building and construction works in order to expand the boundaries of the known matters and continue further investigations, thus, treasuring the Tesla's heritage.

All the works as well as obtained results will be disseminated in Internet, at the project homepage, and in mass media. The time has come to help people to regain something that was sometimes invented by Tesla for them!

You know...We are building museums and memorials in honor of the Greatest Serbian of All and this is great! However, Tesla would be more than pleased if people would be able to realize the great promise of his works and move forward in this direction. **Today we've got such a chance.** That is why we are asking You ALL – help to our research team to make the next step despite all the skepticism and because of all the rational thinkers willing to contribute into this matter. Maybe then our children will be able to live in a better place.

Get involved! Support our research!

The Team

Leonid Plekhanov – Founder & Project Leader

About myself: I was born in Siberia (Russia) in the Krasnoyarsk region. In 1999, I started studying at the Moscow Institute of Physics and Technology (MIPT) and graduated from the Faculty of Physical and Quantum Electronics in 2005. I graduated with a M. Sc. degree in Applied physics and mathematics. I've been dealing with innovative and project management in different fields since 2007. I am married with one daughter. I am really passionate about everything in the projects that further the development of innovative technologies as well as humankind.

Sergey Plekhanov – Scientific Project Leader

I was born in Siberia (Russia) in the Krasnoyarsk region. Since the childhood I was interested in physics. In 1997-2003, I attended the Moscow Institute of Physics and Technology (MIPT the Faculty of Physical and Quantum Electronics), then graduated with M. Sc. degree in applied physics and mathematics. I am married. I am always looking for new, unusual, and unknown things, that is, for something that can change me, or something that I can change myself.

The Advisers

Alex Fedotov – Adviser

I've been working in Plasma Physics (Physics Institute, then General Physics institute of the Academy of Sciences in Moscow) since 1978 and finished my Ph.D. in 1989. At that time I was building high-power relativistic electron beam accelerators and using them in my research of beam-plasma and high-power microwave interactions with atmosphere, rarified gases and the ionosphere. I'm really fascinated by Sergey's and Leonid's effort to re-start the research of Nikola Tesla suspended after his death and am advising them on

the practical issues of building high-power systems and the plasma physics of electromagnetic interactions in the Magnifying Transmitter system devised by Tesla. The vast array of experimental data accumulated in the past couple of decades by means of satellites and ground-based systems shows that nonlinear transformations of the energy of waves and oscillations in the Solar Wind into waves in the ionosphere are possible and can probably be triggered (or ‘Magnified’) artificially with the help of a worldwide system like the Tesla’s Magnifying Transmitter. This would give the humankind access to a totally different source of energy and fulfill his original idea of a worldwide energy system. In a shorter run this experimental research program can help us understand the effects of space weather on the ground based systems and detect the new mechanisms of interaction between the plasma of the solar wind and the plasma surrounding our planet (plasmasphere, magnetosphere and ionosphere).

The Participants and Contributors

The Design Bureau “Radar” is serving as a contractor and the main supplier of the Power Unit.

We are getting a lot of support from other enthusiasts and organizations that really care about this project, and can contribute to its’ success.

Perks

This is a large-scale and long-term project; we would like to express our gratitude to you at least somehow. That is why we prepared interesting and fun perks for all of you, **we hope that you’ll enjoy them and would like to express our outmost gratitude to all our donors!**

We are open to cooperation with ...

Scientists

If you are passionate about the research in this field and would like to contribute your knowledge and experience, have time to spend on the systematic research that we will be conducting with the help of our experimental set-up, we would be more than glad to cooperate with you. Especially if your field of interests spans: high-power VLF waves in medium, ionosphere and ‘solar wind’, geo-physics and geo-electrodynamics or similar aspects of the Worldwide Energy System.

Contact us directly at: science@globalenergytransmission.com

Engineers

We would be more than glad if more engineers, who know how to design and build high-power high-voltage systems would join us. If you are passionate about the systems that we are building have suggestions after looking at our blueprints or would like to contribute into the design and building of our experimental set-up, contact us directly at: engineering@globalenergytransmission.com

Enthusiasts passionate about Tesla’s legacy

We keep researching the Tesla’s legacy to get more clues about his way of thinking about the systems similar to the one we are building. We’ve studied every letter of the ‘Colorado notes’ and related patents, but maybe you can give us additional clues. Contact us directly at: legacy@globalenergytransmission.com

Inventors

Nikola Tesla was The Inventor of the 20th century, his ideas will be sure be continued. Drop us a line that you are inventing the ‘next step’ of his Magnifying Transmitter or have a similar idea that may work better. Contact us directly at: inventions@globalenergytransmission.com

Critics

We are open to criticism. This is the invaluable part of making this project open for everybody from the start. Tell us why 'it will not work'; drop us a line at: criticism@globalenergytransmission.com

Companies that would like to use these inventions

We are absolutely sure that these inventions can only be implemented with the help and contributions of energy producing and energy transmitting companies. We will be more than glad to discuss this experiment and other possible implementations. Contact us at: corp@globalenergytransmission.com

General public

We will be posting the updates about our project on our website and on our pages in social networks. Still, don't hesitate to tell us what you think about this initiative and we will be glad to answer your inquiry. Drop us a line at: public@globalenergytransmission.com

Simplified explanation of the working principle of Planetary Energy Transmitter

In short, Tesla's energy transmission system uses ground surface as a "wire" by means of which it is possible to transmit electric energy to the large distances. An idea of using the Earth as a conductor is not new as such. In the very beginning of the era of electrical engineering, the Earth was actively used as a second wire (direct current was transmitted to the consumer via one wire while the ground was used as a second wire so that the current could return back to the power source). However, transmission of considerable amount of an electrical energy through Earth to the large distances and with high efficiency factor value is possible only by means of Tesla Tower due to coupling of resonance circuits, that is, Tesla Towers. And all of that does not cause any environmental harm.

In a broad sense, two Tesla Towers work in the following way. Imagine simple wire with the metal balls located in the both ends of it (the balls serve as the charge integrators, or as the capacities so to speak). That is, we can arrange alternating charging of the ball-the charge integrator or sort of pump in and out the electrons from the wire into the ball. In this case, the current is going to flow across the wire, reach its other end and evoke similar alternating charging of the second charge integrator. Take a look at the example of corresponding setup as shown below.

Such simplest experiment allows to understand the main working principle of the system consisting of two Tesla Towers (in this case the Earth surface serves as a wire and the Towers itself are serving as balls-the charge integrators). The Tower-Transmitter creates alternating charge on its integrator. It evokes the currents in the ground around the Tower, which scatter away from the Tower. Next, these currents make the second Tower-Receiver resonating and this allows to get an energy from such receiver. Following such scheme, Tesla itself conducted his early experiments on single-wire energy transmission.

In simple words, energy transmission happens in a same way as in the usual transmission lines, that is, via wire. The only difference is that it requires one wire instead of two. Superficial layer of the Earth with depth of about 100 to 1000 m (together with Earth-Ionosphere waveguide) acts as such wire. The Tower-Transmitter literally 'oscillates' the currents flowing across the Earth ground to different sides away from the Tower and the Tower-Receiver 'collects' the energy from these currents. It happens exactly likewise it is shown in picture below, where 'the wire from water' is used instead of 'the wire from ground' as the water is well known for its good conductivity (the picture is taken from the website indicated above).

Current waves' propagation in 'the wire from ground' via very large distances is possible. At that, energy attenuation in such wave is very small due to small resistance of the ground surface (and due to very large sectional area of such conductor) as well as the presence of so-called Earth-Ionosphere waveguide and

considerable spacious charge in the lowest atmospheric levels (which decrease the energy losses to the emission created by the alternating current in the ground).

It would be impossible to transmit the energy with good efficiency factor value if the energy would be just 'pumped' into the planetary resonance, that is, to the current waves in the wire-ground of the Earth and would be sort of 'taken away' in some other place. Energy amount would quickly decrease as the distance from the Tower-Transmitter would grow like it happens, for instance, during working process of the conventional antennas. So, receiver could get only very tiny amount of energy.

Fortunately, in our case, the energy is propagating not like conventional radio waves do, that is, not in all directions, but via single-wire transmission line (i.e., via wire consisting from ground surface). Both transmitter and receiver function in similar way, and receiver creates the current waves flowing away via ground. So receiver creates similar current waves flowing away from the receiver. Such 'secondary' wave (in case of certain location of both transmitter and receiver) acts upon transmitter changing transmitter's impedance, and forces the transmitter to give greater amount of energy to the currents in ground. In that way, so-called coupling of resonance circuits takes a start. As a result, the Tower-Receiver cannot be considered as a passive setup. In opposite, it strongly acts upon the Tower-Transmitter. And that allows to get high value of the efficiency factor of energy transmission.

Project Witricity can serve as an excellent example of using the coupled resonance circuits as it allows to arrange wireless energy transmission with high efficiency factor value exactly based on the principle of the resonance-coupled circuits:

So in a broad sense Tesla's Tower is a global analog of Witricity, and the WiTricity technology is similar to the idea of our experiment. WiTricity employs near field resonant inductive coupling of two resonant circuits to achieve a high power-transmission efficiency. The scope of our approach is practically same. However, there is no distance limitation like in case of WiTricity due to usage of single-wire transmission line (the Earth, i.e. ground wave and earth-ionosphere waveguide) for the transmission of energy by conventional currents.

As the issue is about the currents flowing in the thick layers of the Earth ground, the certain questions may arise concerning the safety of such energy transmission method. Fortunately, as the current is distributed over the large section of such single-wire transmission line (ground surface), current value is so small in any certain place that can be hardly detected and such small current density does not affect any kind of processes or any live substances. That is, the current values in such system will be much smaller than those of the vertical currents that are constantly flowing between ground and ionosphere (and in which every organism is safely living). The only place, where the current values reach great numbers, is located in the immediate surrounding of the Tower to which the human access should be certainly restricted.

It is certain that everything described above is just an attempt of describing the main working principle of the Tower in extremely simple terms and without complicating it with some important details. More detailed description of such principle can be found in the article called as "Examining Working Principle of Tesla Tower".

What is the Tesla Tower NOT about:

- This is NOT 'planetary microwave'. Tesla Tower does not emit anything on its own; it just creates the currents in the ground, which scatter in every direction away from the tower. So it is total absurd thought to call the Tower that way – as it is the same like calling the usual wires with alternating current a microwave.

- This is NOT an antenna. The Tower does not emit anything and the field is generated by the currents that flow in the ground and scatter away from the Tower. So that the Tower is just an efficient charge integrator for a charge that has to be literally ‘ripped away’ from the ground to create the currents in that. In case of Tesla's Tower the antenna consists from many kilometers long ‘layer’ of the ground around the Tower and the currents scatter away from the Tower along this ‘layer’ (or sort of ‘plate’).
- This is NOT the device that breaks the common physics laws. All the processes evoked by the Tower's work 100% corroborate with the basics of physics and electrical engineering. Therefore, physical part of the Tesla Tower's functioning process does not require involvement of any alternative terms (though part of the processes related to the Tower's working process can be described in terms, which are a bit different than common physics ones. Yes, this is rather about interpretation of its work, not about the phenomenon itself). At that, Tesla himself was claiming that the waves, which are being generated by the Tower, are not radio waves itself, but, in fact, are the current waves (Tesla was directly referring to these waves of currents in his research works and the patents).

Quote

“The date I shall never forget – when I obtained the first decisive experimental evidence of a truth of overwhelming importance for the advancement of humanity [...] **No doubt whatever remained: I was observing stationary waves.**”

“That electrical energy can be economically transmitted without wires to any terrestrial distance, I have unmistakably established in numerous observations, experiments and measurements, qualitative and quantitative. These have demonstrated that is practicable to distribute power from a central plant in unlimited amounts, **with a loss not exceeding a small fraction of one per cent**, in the transmission, even to the greatest distance, twelve thousand miles — to the opposite end of the globe.”

Nikola Tesla

Focus Fusion

‘Focus Fusion’ is fusion of hydrogen and boron (pB^{11}) fuel using dense plasma fusion to create green energy. Focus fusion will be *aneutronic*, meaning ‘no neutrons’ and **no pollution**. The fuel employed won't be radioactive. It will be a combination of regular hydrogen and boron (like that found in laundry detergents) that when fused only creates alpha particles, better known as helium.

Apparently focus fusion is much less expensive and more practical than hot fusion which is wastefully funded with hundreds of millions of dollars by the U.S. Department of Energy.

Focus fusion uses a pulse of electricity that generates a plasma in a shape that makes it kink itself into a tiny little ball of lightning hot enough to fuse the atoms of hydrogen and boron. Over a million amperes of current is driven across a pair of cylindrical electrodes, creating a dense plasma where fusion reactions occur.

Instead of constantly having to fight the plasma’s natural instability, advantage is taken of the instability. The device uses a pulse of electricity that generates plasma in a shape that makes it kink itself into a tiny little ball of lightning hot enough to fuse the atoms. This process releases a powerful beam of energy that can be directly converted into electricity.

A powerful beam of electrically charged helium nuclei is released that is directly converted into electricity with over 80% efficiency. The second part of the energy comes out in the form of X-rays which are captured in an onion-like array of photoelectric receptors. They collect the X-ray energy and again convert that to electricity.

Focus Fusion energy produces no radioactive waste. There will be no more deadly oil spills or nuclear fission accidents. The waste product of focus fusion is harmless, useful helium gas.

Focus fusion generators will be only 5 MW, enough for 3500 homes. A 5 MW focus fusion generator may cost around \$300,000 and produce electricity for only one-third of a cent per kWh. Focus Fusion would be about ten times cheaper than any existing energy source.

The goal for Focus Fusion, within reach in the next few years, is to reasearch, prototype and manufacture individuat commerciat fusion units (small enough to fit in a garage or shipping container) that are able to provide energy for a few thousand homes at least ten times cheaper than any known energy source.

You say you can convert the energy directly into electricity. How?

Most of the energy comes out in the form of an ion beam. The beam goes into a form of a high-tech transformer which collects the energy into an electric circuit. The process of induction used here has been employed in electrical technology since the 19th century. Recent work by other researchers has shown this can be done for an ion beam with over 80% efficiency.

The second part of the energy comes out in the form of X-rays which are captured in an onion-like array of photoelectric receptors. They collect the energy and again convert that it electricity. Again, the photoelectric process is well known.

Since both of these devices are very compact, they can be much cheaper than the large and complex steam turbines now used to produce electricity.

Focus Fusion generators would produce electricity very differently. The energy from fusion reactions is released mainly in the form of a high-energy, pulsed beam of helium nuclei. Since the nuclei are electrically charged, this beam is already an electric current. All that is needed is to capture this electric energy into an electric circuit. This can be done by allowing the pulsed beam to generate electric currents in a series of coils as it passes through them. This is much the same way that a transformer works, stepping electric power down from the high voltage of a transmission line to the low voltage used in homes and factories. It is also like a particle accelerator run in reverse. Such an electrical transformation can be highly efficient, probably around 70%.

What is most important is that it is exceedingly cheap and compact. The steam turbines and electrical generators are eliminated. A 5 MW Focus Fusion generator may cost around \$300,000 and produce electricity for 1/3rd of a cent per kWh. This is ten times less than the cheapest current technology. Fuel costs will be negligible because a 5 MW plant will require only five pounds of fuel per year.

No, the ion beam is accelerated by an ultra-powerful electric field that is directed along the axis of the plasmoid, in turn aligned with the axis of the device. The beam's own magnetic fields focus it and prevent it from expanding. These beams have been observed in plasma focus devices for decades.

The x-rays **are** radiated in all directions and must be captured by a cylindrical or spherical photoelectric device, consisting of thousands of layers of thin metal films to emit electrons when the x-rays strike them and grids to capture the electrons.

Source: <http://www.focusfusion.org/>

For more on ball lightning and two other applications of ball lightning to producing energy see “Ball Lightning Fusion Reactors” in www.padrak.com/vesperman or www.commutefaster.com/vesperman.html. One such device is the self-confined thermonuclear reactor. The other is the colliding plasma toroid fusion reactor.

BlackLight Power’s Hydrino Generator

BlackLight Power, Inc., is developing an exotic new source of clean energy from ordinary water as a fuel. A catalytic reaction causes hydrogen atoms to form lower-energy-state hydrogen atoms called “hydrinos”. When the hydrinos are formed, energy is released which in magnitude is between chemical and nuclear energy. BlackLight Power, Inc., has ambitious plans for retrofitting fossil-fueled and nuclear power plants and licensing the production of nonpolluting electric cars that have a range of 1500 miles on a single liter of water. The company’s website is <http://blacklightpower.com>.

Sustainable Energy with Water as Fuel

BlackLight Power, Inc., is the inventor of a commercially competitive, nonpolluting new primary source of energy that forms a prior undiscovered form of hydrogen called “hydrino”. The hydrino is very likely the identity of the dark matter of the universe.

Proprietary electrochemical reactants or solid fuels undergo reaction to cause hydrogen to form hydrino with energy released as electricity or heat, respectively. The net energy released from this "BlackLight Process" may be two hundred times that of combustion of the hydrogen fuel with power densities and performance comparable to those of batteries and conventional central power plants, respectively.

Water can be used as the stored hydrogen, generated on demand by electrolysis using less than 1% of the electrical output. With the elimination of fuel and fuel infrastructure costs, the operational cost of BlackLight Power generators is likely to be very inexpensive. Moreover, the process does not give rise to pollution, greenhouse gases, nor radiation as conventional systems do.

The CIHT Hydrogen Fuel Cell

BlackLight Power, Inc., has developed three systems for producing electricity powered by forming hydrinos: one electrochemical and two thermal systems. A Catalyst Induced Hydrino Transition (CIHT) cell generates electricity directly from hydrogen. But, unlike a conventional hydrogen fuel cell, the cost is forecast at \$25 per kilowatt compared to thousands of dollars per kilowatt for a fuel cell. This is in part due to the CIHT cell’s electrical energy released per hydrogen being over 200 times greater, and the CIHT materials being inexpensive.

Moreover, fuel cells can’t use water as the source of hydrogen, since their product is water. For CIHT, no fuel infrastructure is required to provide on-site power – allowing the CIHT cell to be autonomous.

BlackLight Power is focused on advancing CIHT technology to produce power to ultimately sell directly to consumers under power purchase agreements. Rapid dissemination at nominal historic cost is expected by deploying many autonomous distributed units that circumvent the huge barriers of entry into the power markets such as developing and building massive billion-dollar power plants requiring enormous thermally-driven mechanical generators with their associated power distribution infrastructure. This is especially advantageous in emerging markets.

Distributed Infrastructure

Essentially all power sources of all sizes – thermal, electrical, marine, rail, aviation, aerospace, as well as automotive sources – become untethered from an electrical distribution or fuel infrastructure and are also independent of the sun, wind, or other external variable power sources.

A CIHT electric car is expected to have a range of 1500 miles on a liter of water. This direct application of the BlackLight Process to motive power has the potential of unsurpassed capability in terms of range, capital cost, power, logistics, and pollution abatement to zero, including zero carbon dioxide emission.

Moreover, the compact automotive unit could be plugged into the electrical panel to power the owner's home with enough power to spare to also power the neighborhood. BlackLight plans to pursue licensing, strategic partnerships, and leasing in motive power markets.

Thermal Systems

In addition, BlackLight Power, Inc., has developed thermal-producing solid-fuel chemistries that in turn can be thermally regenerated. Thus, BlackLight Power, Inc., believes that continuous generation of power liberated by forming hydrinos is commercially feasible using simplistic and efficient systems that concurrently maintain regeneration as part of the thermal energy balance. The system is closed except that only hydrogen consumed in forming hydrinos needs to be replaced.

Chemistries and engineering designs have been developed using the corresponding experimental parameters for power and regeneration for two thermal-Rankine systems. One comprises a multi-tube thermally interacting bundle of cells wherein cells producing power provide heat to those undergoing regeneration. As a system, the power output is constant. The capital costs are projected to be about \$1400 per kilowatt electric. The other comprises an array of reactor cells wherein power and regeneration chemistries occur synchronously, and each cell outputs constant power. The capital costs are projected to be about \$1050 per kilowatt electric.

BlackLight Power, Inc., is non-exclusively licensing its thermal process to make power for a fixed royalty payment per kilowatt-hour of thermal or electric. To date, BlackLight Power, Inc., has licensed the rights to produce approximately 8,250 megawatts of new electrical power to seven companies, including five electrical utilities and two independent power producers. Collectively, these utility companies own, purchase, or manage electric power production of approximately 7,600 megawatts and service nearly one million customers. The avoided fuel costs from these agreements could be in excess of \$2 billion per year.

Independent Validation

Electrical power from the CIHT cells, thermal power from the solid fuels and their thermal regeneration, hydrinos from both synthesis reactions and as a product of the CIHT cells and the solid fuels, as well as the light signature of the formation of hydrinos, and other signatures of the BlackLight process have been independently validated and published in scientific journals and reports.

A Classical Theory of Nature

The theory upon which BlackLight Power's technology has been developed is based on the classical laws of physics. BlackLight Power, Inc., recently released the finalized Grand-Unified Theory of Classical Physics that comprehensively addresses many of the basic problems in chemistry and physics using these physical laws without using approximations or pure mathematics, devoid of physics, as is the case for the incumbent atomic theory of quantum mechanics.

BlackLight Power's wholly owned subsidiary, Millsian, Inc., is dedicated to developing computational, chemical-design software tools based on solving molecular structures using these laws. The essentially real-time, analytical solutions of the precise physical structure of molecules of boundless extent and complexity, not possible using quantum mechanics, further validates the classical theory relied on by BlackLight Power, Inc.

The inventor of the process is Randall L. Mills, M.D. For an overview with diagrams, see his PowerPoint presentation “Thermally Reversible Hydrino Catalyst Systems as a New Power Source” which is available for viewing at <http://blacklightpower.com/new.shtml>.

IPMS Thorium Energy Accumulator

The I.N. Frantsevich Institute for Problems of Materials Science (IPMS), Kiev, Ukraine, from 1951 through 1991 secretly employed 6600 of the most brilliant theoretical physicists in the entire Soviet Union to work for nearly 50 years with complete freedom. They were able to develop whole new sciences, technologies and materials unknown in the West.

Their models of non-linear quantum mechanics, plasma physics, atomic engineering, nuclear physics and related mathematical and theoretical constructs, which made their development possible, are so unique that they challenge the validity of the most fundamental assumptions embodied in the Copenhagen Interpretation model currently held in general acceptance in the West.

For example, Western-developed particle/wave quantum mechanics is described by Einstein's $E = MC^2$. The Soviet nonlinear model of quantum mechanics is described by the formula $E = M_K V$ [Energy = Mass @ rest as a function of a mathematical constant where the velocity of C approaches zero].

Einstein's theory of relativity assumes that the speed of light is constant. However, recent measurements of the Alpha Constant have been reported to show that the speed of light has slowed down 7 per cent over the past two centuries. (See http://worldnetdaily.com/news/article.asp?ARTICLE_ID=39733.) Einstein's famous equation is therefore not based on the real world of peer-reviewed experimental results. Consequently, the more correct Soviet model has enabled numerous technical advances not yet dreamed of by Western science.

Among several energy inventions developed by the IPMS are free-standing thorium-232 isotope electric power generating plants. They can be scaled to power a single home and large enough to power whole communities. They also can operate for up to 300 years with no refueling and minimal maintenance. The beauty of such systems is that they pose absolutely no risk for critical melt-down since Th-232 cannot achieve criticality on its own in a nuclear pile.

Thorium Power Pack

Bob Dratch's thorium power pack would generate electricity at approximately one-tenth of the cost of current methods of producing electricity. Thorium is sufficiently abundant that the entire planet can be powered for millennia. After ten years of continuous operation, a trace amount of U-233 is produced. U-233 recovery to re-purify the thorium is easily accomplished. Thorium thus lasts a long time when recycled and consequently is a very efficient energy source. After extraction from ore, thorium does not require energy-intensive enrichment as is the case with uranium.

A thorium-powered reactor is inherently safe. It doesn't run the risk of "meltdown" or explosion nor can even a dirty bomb be created. Its nuclear reaction simply stops when its neutron exciter is turned off. The simplest and smallest "table top-sized" neutron exciter design is something close to the size of a 4-D cell flashlight, and starts at about 500-kilovolt neutron output. In fact this smallest most cost-effective system can run off 4 D cells for its power.

A thorium power pack's neutron exciter does not use radioactive flux components as conventionally done for portable systems. Instead it relies on Dratch's invention of a novel method of resonant phonon pair cleavage using specifically designed nuclear lattice holo-forms (holographic waveforms) to induce neutron imbalance in a host atom where the host atom then attempts to establish "balance" through the liberation of neutrons. Dratch demonstrated the first model of this novel design back in 1966.

Commercial thorium power packs can be developed with 50 or 100 kilowatts of output for home use, and up to 1 megawatt for industrial use. They actually are "power amplifiers" with estimated power outputs of 60 times over input power. Maintenance would be minimal.

Inventor: Robert J. Dratch, USA www.bob-dratch.org
padrak.com/vesperman "Locomotive Power Sources"

Magneto-Gravitational Converter (Searl Effect Generator)

The Searl Effect Generator (SEG) can be used to charge the batteries in a self-powered electric vehicle. A solid-state device, the heart of an SEG is a series of three concentric magnetic rings with magnetic rollers going around the rings. Both the rollers and rings are comprised of four layers of titanium, iron, nylon, and neodymium.

The magnetic fields impressed on the rollers have both AC and DC components. The AC component is for floating the rollers so they don't touch the rings. The DC component is to prevent them from flying off. The innermost set contains a minimum of 12 rollers for the same reason that a linear motor will not operate with less than 12 phases.

The inner set of rollers travel around at 250 miles per hour, the middle set travels at approximately 600 miles per hour, and the outer set at approximately 1500 miles per hour. Hundreds of millions of volts are generated the energy of which is picked up by brushes positioned all around the outside set of rollers.

An SEG also creates an anti-gravity field. An uncontrolled SEG will rise about 50 feet as the rollers increase speed, emit a light blue halo which indicates energy is being extracted from the ether, and then shoot up into the sky gaining speed, never to be seen again. At least one roof has been holed by an SEG. The friction-less rollers can be prevented from reaching the critical velocity that produces lift by use of a "governor", either mechanical or electronic.

An SEG can be easily controlled by immersing it in an electromagnetic wave field the frequency of which is a harmonic of the SEG's primary frequency. While in resonance, the magnetic poles of the rollers reach a unification state, and they stop moving.

The inventor has built and flown a small "inverse gravity" vehicle. A flying saucer-like SEG-powered aircraft about the size of a bus is currently being built in England by a private group.

The inventor for some years independently powered his house off the power grid with a home-sized electrical generator version of the SEG. A householder could set up a 45 x 45-cm unit and generate an output of 11 kilowatts of free electrical power.

Oddly, a house powered by an SEG has been observed to have greater healing powers than conventionally electric powered houses. The healing effect is claimed to be due to the electrons zapping the occupants, taking away pain and returning blood more quickly to damaged tissue. The SEG would also help combat asthma, bronchitis, hay fever and lung complaints due to the increased supply of oxygen in the body. Conventional methods of electric power do not pump out electrons which results in tired eyes and a tired brain.

The SEG's negative charge also means that dust stays in the carpet instead of floating in the air. This is similar in action to negative ion generators sometimes sold as air fresheners.

Two Russian scientists replicated the Searl effect generator and vindicated all of these somewhat unusual claims. See their paper "Experimental Research of the Magnetic-Gravity Effects", V. V. Roschin and S. M. Godin, Institute for High Temperatures, Russian Academy of Science, Izhorskaya 13/19, Moscow 127412, Russia. (<http://rexresearch.com/roschin/roschin.htm>)

The following letter from Robert Koontz is at http://www.doctorkoontz.com/Scalar_Physics/Searl%20Effect/Open%20Letter.htm:

An Open Letter Concerning John Searl's Free Energy and Antigravity Claims

September 5, 2010

To Whom It May Concern:

I am a Ph.D. experimental nuclear physicist and have been for 30 years.

My bachelor's degree in physics was earned with honors in 1975, and I was awarded the Ph.D. degree in December of 1980 at the University of Maryland.

My experience includes being a Staff Scientist at the Lawrence Berkeley Laboratory and a faculty member in the Physics Department at the University of South Dakota. While in the United States Navy, I served as an electronics instructor at the National Security Agency.

Regarding the contents of this letter, it is my conclusion that the claims made by John Searl in relation to his Searl effect generator are true. Among other things, John Searl claims to have been able to achieve antigravitic effects and to generate energy in a self-sustaining mode that did not require the burning of any kind of fuel.

It is true that John Searl's claims are extraordinary. And, while it may seem to violate common sense to hear that John is generating energy without burning any fuel, it is nevertheless theoretically possible to do this, provided that an equal amount of negative energy is simultaneously produced.

With respect to the above, and in confirmation of John Searl's claims, I draw the reader's attention to the fact that two Russian scientists at the Russian Academy of Sciences have reported replicating the "Searl Effect" and claim generation of 7,000 watts of power in a system which was said to have lost 35 percent of its weight, or roughly 300 pounds.

Regarding antigravity, the current laws of physics do not appear to support its existence but would have to be modified to accommodate such a phenomenon. This is an area in which I am now doing research.

Sincerely,

Robert W. Koontz

(End of letter)

At one time, a German power company reportedly considered replacing a nuclear power station with eight fuel-less SEGs costing a total of about \$4.5 million and generating a total of 240 megawatts with no pollution.

John Thomas, "The Secret Technology of Professor John R. R. Searl," *Extraordinary Science*, Volume VI, Issue 2, April/May/June 1994, p. 17.

"Experimental Research of the Magnetic-Gravity Effects" and "An Experimental Investigation of the Physical Effects in a Dynamic Magnetic System" by V. V. Roschin and S. M. Godin, Institute for High Temperatures, Russian Academy of Science, Izhorskaya 13/19, Moscow 127412, Russia. US Patent No. 6,822,361 for Orbiting Multi-Rotor Homopolar System, Vladimir Vitalievich Roschin, and Sergi Mikhailovich Godin. Russian Patent No. 2,155,435 for Mechanical Energy Generating Device and Process, Vladimir Vitalievich Roschin, and Sergi Mikhailovich Godin. (<http://rexresearch.com/roschin/roschin.htm>).

<http://www.johnsearlstory.com/> (fastest/easiest way to learn about John Searl)

<http://www.searlsolution.com/> (best for technical information)

<http://www.searlmagnetics.com/> (company business)

<http://www.swallowcommand.com/> John Searl's personal website

http://pesn.com/2011/12/20/9601991_Part-I_Searl_Magnetics_Nearing_Eureka/

http://pesn.com/2011/12/21/9601992_Part-II_Searl_Magnetics_Nearing_Eureka/

<http://www.scribd.com/doc/217826903/Understanding-John-Searl-s-SEG>

Induction Coil Coating Increases Generator Electrical Output by One-Third

This invention significantly improves generator performance – copied below from inventor David Yurth's email with the proprietary details omitted:

... this means that if you have (deleted) present in any DC interaction, you can reduce e- transport by as much as 65% - 80%, depending on architecture and other variables. (deleted) is not able by itself to constitute a self-sustaining electron source capable of performing significant work until the surface area geometries are reduced below the nano-scale. Nevertheless, we have demonstrated in our lab that when the induction coil of a common automobile alternator is coated with (deleted) impregnated in an epoxy resin the amount of watts output at the generator is increased by 35%-38%.

The practical implications of this finding are profound – it means, for example, that if all generators used to produce power were (deleted) impregnated using this simple application, the amount of fuel required to generate electrical power to the grid could be reduced by 1/3.

One application is to increase the electrical power output of wind turbine generators by about a third.

Wind Turbine Conversion

This invention radically changes, for the better, wind turbine design – copied below from inventor David Yurth’s email with the proprietary details omitted:

When a single 1.5-megawatts wind turbine is converted to our design, the gearbox is deleted and so is the brake mechanism. The propeller blades are redesigned to operate at wind speeds in excess of 60 mph, which is four times faster than the average horizontal axis wind turbine is designed for. We used an adaptation of our (deleted) tied to 10 such turbines that will provide 5 megawatts of continuous output power when the wind is not blowing and during the night time. The entire system will deliver up to 15 megawatts in optimum wind conditions. So by being able to deliver on demand during peak hours, when the wind is NOT blowing, this integrated system would qualify for long-term power production contracts on a par with coal and gas fired systems. The installed cost for such a system is estimated at about \$1,100 per kilowatt of installed capacity.

The elimination of the gear box and brake, coupled with the modification in the drive line system would reduce not only installed cost by more than 60% but would also reduce maintenance costs by as much as 90%. When no offset reserve has to be created to support the five-year replacement cost of the gearbox and brake system, the numbers related to power output vs. cost input become extremely attractive. Perhaps more importantly, the real efficiency of the system is much higher than a conventional system because it becomes in effect a highly efficient heat exchange engine rather than simply a wind energy conversion unit.

We know how to do this and could do it immediately if the resources were made available. Scaled down prototyping based on the incremental R&D model we described to (deleted) in earlier emails would make this a manageable and cost effective undertaking with world-wide applications. For your consideration...

Direct Energy Conversion

Abstract — Power generation has remained largely unchanged over the past 100 years and the bulk of our electrical energy still requires a rotating armature to make electrical power. With an ever increasing demand for clean electrical power we desperately need a new method or means to keep up with this demand. Large-scale power generation systems are known to have many technical limitations such as high construction and maintenance costs. The goal of this paper is to show that a new high-performance, low- cost method of generating electrical energy is possible using existing quantum physics principles and new materials. The device is solid-state and harnesses Type II superconductor technology to perform the same work function as a rotating armature.

Introduction — In the days of Nikola Tesla and the Niagara Falls Power Company, the only way to produce large amounts of electricity was through the use of falling water. We can thank Nikola Tesla for the invention of the AC generator. Niagara Falls was selected for the first large scale generator demonstration because of the massive waterfalls. Water flowing from Lake Erie was harnessed during its drop to the Atlantic Ocean to drive large water turbines hooked up to Nikola Tesla’s AC generators. Using Tesla’s moving armature technology and water power, the first AC electricity was generated and distributed to Buffalo, New York some 26 miles away. Now the world could be powered by hydroelectric power. While today’s systems are larger and primarily fueled by coal, nuclear, and gas, the modern world still relies on Tesla’s moving armature as one of the key components in making electrical power. Over the past 100 years, technology has advanced significantly, with the advent of computers and the internet, aircraft, television, electronics, superconductors and many other wonderful technologies, all of which use electricity to function. Tesla’s moving armature allowed the conversion of potential energy into kinetic energy, and in turn the conversion of kinetic energy into electrical

energy. These large generating power plants are reaching their peak efficiency given known technology, but the basic design has not changed in over 100 years. It still takes a moving armature to generate large amounts of electrical energy.

A moving armature provides a magnetic path which is used to make and break the magnetic circuit and force a change in magnetic flux flowing through coils of wire. Using Faraday's law of induction where the flux through N loops of wire changes by an amount of $\Delta\Phi$ during a time Δt , the average induced Electro Magnetic Force (EMF) during this time is given by the expression:

$$\varepsilon = -N \frac{\Delta\Phi}{\Delta t} \quad (1)$$

where: ε = Output voltage
 $-N$ = Number of turns in the coil
 $\Delta\Phi$ = Difference in static flux
 Δt = Difference in time

Faraday's law of induction shows that when a flux difference flowing through the coil is established, electrical energy is generated. A moving armature provides this elementary work function.

What if this same work function could be done in a solid-state form without any rotating armature or moving parts? Using existing technology, is it possible to replace the massive armature with a new device? Would this new device have fewer limitations and be cheaper to produce? Could this new device perform the same basic work function, using Faraday's law of induction, to produce electrical energy without a moving armature? If so, this would be a major breakthrough in technology for the production of electricity. The process of combustion or the use of nuclear fuels to expand or heat water into steam to drive turbines would be obsolete. What new business opportunities would this generator provide?

A 'Direct Energy Conversion' (DEC) device would allow power plants to be located near large cities, since they would not pollute the environment with harmful emissions. We could reduce, or even eliminate, the need for massive distribution lines that criss-cross the nation, saving the public hundreds of millions of dollars annually in maintenance costs per year. It would also eliminate the need to burn vast amounts of hydrocarbon fuels to convert potential energy sources into electrical power.

This new method of producing electrical energy would change the face of the planet as well as reduce CO_2 emissions because DEC does not require combustion to generate electrical power.

The DEC would compete with nuclear energy in terms of its environmental benefits. Solar, wind and geothermal are also powering the grid, but they do not supply a large percentage yet. Over time this will improve. Nuclear energy is the only other type of system that does not produce CO_2 during the production of electricity. It does, however, produce substantial amounts of CO_2 during mining and processing the radioactive ore. Nuclear power also has a dark side – radioactive waste is used to make nuclear weapons.

Direct Energy Conversion – One would think this concept is very new. However, Thomas Edison, Nikola Tesla and George Westinghouse attempted to develop this technology in 1907.⁵ They used a standard Ecore magnetic structure made out of gallium. Gallium was used because waste heat forces the gallium core to change its inductance, thereby causing a change in the flux flowing through different coils. The project was abandoned

⁵ Elliott, J.F. 1959. "Thermomagnetic Generator," Journal of Applied Physics, 30, 11, November.

because the gallium core could not convert the heat energy fast enough to produce a large difference in the static flux flowing in the coils.

The DEC concept was again investigated in the mid-1950s when GE and government labs teamed up to review DEC concepts. The input energy was also heat. This project was dropped because of technical issues related to material constraints. Some of the technical papers which came out of the research effort showed the concept was sound from a theoretical standpoint mathematically, but the materials required to make the concept work at that time were unavailable.

Fast forward about 30 years to the discovery of a new superconducting material, Yttrium Barium Copper Oxide (YBCO). This new superconducting material set the stage for some major breakthroughs in physics and new magnetic applications. Yet we have not seen any of these applications in everyday products.

Considerable research was done on this new superconducting material, but the main interest was finding a material that could replace copper wire and conduct electricity without any resistance, i.e., no I^2R losses. Naturally, this new material requires a cryogenic environment to work. The cryogenic liquid in this case is liquid nitrogen (LN_2), which is very cost effective and easy to manufacture when compared to applications that use liquid helium.

After spending a significant amount of personal time studying this new material, it was hypothesized that if YBCO could be properly arranged and utilized, it might be possible to replace Tesla's moving armature with a 'solid-state' armature. The big question is: "Can YBCO superconductor material act like an inductor and effectively channel static magnetic flux?" What are its magnetic properties and how effective would it be in this magnetic application?

Using principles of Quantum Electrodynamics (QED), made famous by Dr. Richard P. Feynman,⁶ a new configuration and theory for DEC has been developed. Feynman won the Nobel Prize in physics for his contribution in QED. He outlined the physics and interaction of the photon and the electron. Feynman also described the complex nature of photon and electron interactions at the atomic scale. He showed how an electron in a low-energy state could be elevated into a new higher energy state by absorbing a photon of the correct energy level and wavelength.⁷ Feynman's QED principles are used in the DEC concept to elevate or move electrons found in the crystal lattice structure located inside the YBCO superconducting material into a higher energy state with the use of a photon. This phenomenon is known in the scientific literature as 'photon Cooper pair breaking', and is used in the DEC to toggle the YBCO in and out of the superconducting state. Note that photons, electrons and flux quanta are the only moving elements.

Another DEC device is the solar photovoltaic cell first discovered by Edmund Becquerel, a French experimental physicist who was experimenting with an electrolytic cell made up of two metal electrodes in 1873.

In this case, a photon from the sun hits a solar cell, knocking out a free electron. The free electron is used to power electrical circuits and loads. There is great interest in this kind of technology today, but it is limited to operation during daylight hours. After many years of research and development, solar power systems remain below 25% efficiency. Solar cells are also costly because they require pure silicon to manufacture the substrate. These and other issues have prevented their widespread use. Thin film solar panels have solved this problem, but remain unavailable to the public due to high cost.

⁶ Feynman, R.P. 1985. QED: The Strange Theory of Light and Matter, Princeton University Press.

⁷ Zhao, Y.G., Li, E., Wu, T., Ogale, S.B., Sharma, R.P., and Venkatesan, T. Center for Superconductivity Research, Department of Physics, University of Maryland, College Park, MD 20742; Li, J.J., Cao, W.L., and Lee, C.H. "Optical Cooper Pair Breaking Spectroscopy of Cuprate Superconductors."

Photons to Electrons – As stated previously, in a solar cell the photon helps to free an electron in a solid state way, i.e., a ‘Direct Energy Conversion’ process. International Patent application WO 2008/005158 A2, titled “Method and Apparatus for Direct Energy Conversion,”⁸ outlines a second direct energy conversion process.

Using Type II YBCO superconducting materials, the plan is to configure this material in such a way as to allow photons, not electrons, to cause a moving ‘avalanche effect’ in the superconducting material – knocking it out of the super-conducting state.

As photons are injected into the surface of the thin films of YBCO, static flux quanta emanating off the pole of a permanent magnet is channeled through two different magnetic paths. See Figure 1 for a simplified overview of the device.

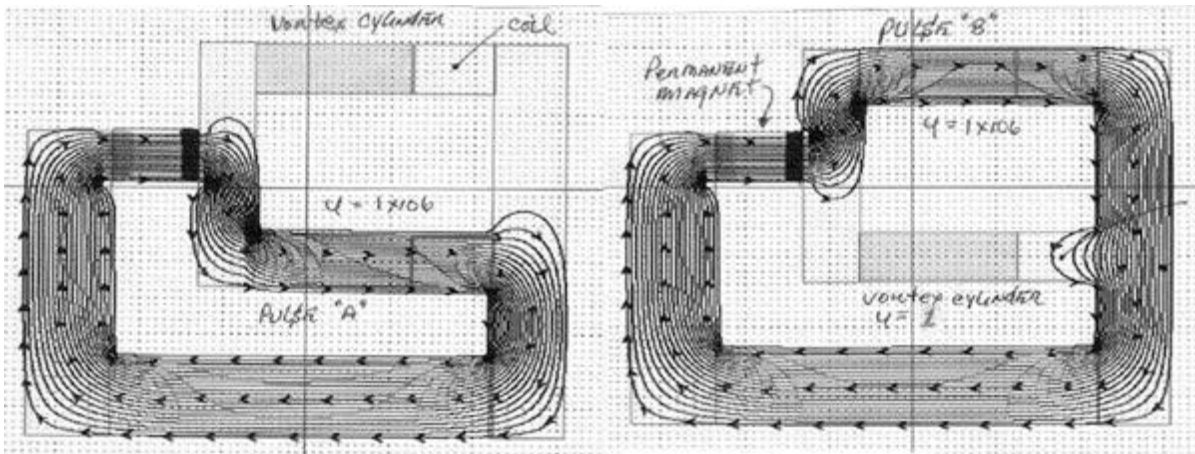

Figure 1. A simple computer simulation of the vortex cylinders in operation, as well as how the static flux could flow in a conventional magnetic circuit. Note how the modulation of the vortex cylinders causes the static flux to modulate between channel “A” and channel “B” coil. The coils are shown in series with the vortex cylinders.

Note that in a normal magnetic circuit, electrons were used to produce magnetic fields. In this case a strong permanent magnet is used to produce an equivalent field. This new design is a more energy efficient method. To control the static flux and modulate it from one coil to the other, a new device utilizing ‘vortex cylinders’ is proposed. These man-made vortex cylinders are comprised of hundreds of small quartz tubes. Each of these tubes is designed to channel static flux through a magnetic circuit. In effect, each vortex cylinder is a ‘solid-state air gap’ with an inductance that can be varied by introducing coherent photons of a given wavelength and energy level.

The vortex cylinder would exhibit an extremely high permeability on the order of 10^6 H/m.

The high-energy 930-nm photons interact at the atomic level where the electrons formed Cooper pairs. The high-energy photons are used to drive the superconductor material in and out of the superconductive state. When the Type II YBCO is in the normal state it has no magnetic properties, and the materials are similar to glass or a ceramic, which is known to have no effect on magnetic flux.

One of the most exciting parts of this new concept is that when the vortex cylinder is not exposed to the coherent photon source it will drop back into the superconducting state as long as the vortex cylinder is held at or below its T_c .

⁸ Sines, E. 2008. International Patent Application, “Method and Apparatus for Direct Energy Conversion,” January 10.

What is significant in this application is the DEC will be able to produce a difference in the static flux density in two different coils over time and in effect produce a counter EMF or electricity *without any moving parts*.

This design could replace the moving armature as well as the high-speed steam turbine of the coal fired boiler plant and all the associated support equipment – reducing the footprint of the generating plant considerably, as well as cost. The device can be cycled in a manner similar to a conventional switch mode power supply using a standard half bridge driver. The flux is flowing through one side of the magnetic circuit while the other side has a very low or zero flux density. The photon source is then turned off, and the other side of the vortex cylinder circuit is turned on, completing one full switching cycle. The technical process is known as ‘photon Cooper pair breaking’. Since the YBCO vortex cylinder remains at a relatively constant temperature, only a small amount of LN₂ is used during the ‘latent heat of vaporization’.

The waste heat from generating electricity is expected to be a small fraction of the overall energy produced, with an estimated efficiency of 99.5%. This process can be repeated billions of times with no loss in electrical performance.

The device requires LN₂ as a cryogenic ‘fuel’. This cost is small compared to the present day cost of mining hydrocarbons, like coal, or extracting crude oil. Since the DEC does not use combustion to convert potential energy into kinetic energy, the only byproduct is a small amount of waste heat and nitrogen gas which is released back into the atmosphere where it originated, closing the loop without the production of CO₂ or other harmful emissions.

The Future of DEC – This paper was intended to provide a simple overview of a complex concept, one that has a rich foundation in conventional physics, magnetism, optics, quantum mechanics, superconductivity, and many other technical areas. Should the DEC become a reality, the reduction in CO₂ emissions would greatly improve the environment. Given the volumes of technical papers available worldwide and new superconducting materials, mankind is better positioned to realize new breakthroughs in DEC technology. We have the technology, the materials and the knowledge to succeed where past efforts have failed. This vision can help save the planet from pollution, global warming, skyrocketing energy costs, and the security risk of sourcing our energy from countries that sponsor terrorism.

Conclusion – Humanity and the planet are at a crossroad in history and time. The Earth’s atmosphere, land masses and oceans are under attack from every direction. Humanity is depleting resources that can never be replaced. Humanity needs to focus on reviewing the planet’s ecosystem more than ever before. It is with great hope that the scientific community will realize the potential in the DEC concept and support the development of such a clean energy system.

Acknowledgments – The author would like to express his deep appreciation to his wife, Debbie, for her support and encouragement in this clean energy adventure. In addition, I would also like to offer my sincere thanks to all of the people who have supported my R&D efforts over the past three years, allowing me to follow my dream of clean energy.

About the Author – The author worked at the Naval Research Laboratory as an Electronic Engineering Technician for 26 years before retiring to work full time on various R&D projects under the banner of a new start up company called Potomac Energy Projects, LLC. The author holds a number of active patents in the area of passive coil winding cooling methods related to power transformers, motors and generators. Potomac Energy Projects LLC is working on a number of patent pending applications related to clean energy technology that do not use the combustion process to produce electricity.

Additional Information About the DEC Concept – *Infinite Energy* editors asked some additional questions of inventor Eddie Sines about his “Direct Energy Conversion” concept:

Q: How much energy is required to liquefy nitrogen gas into a liquid which is used to maintain the cryogenic temperature on the device so it can maintain a superconductor environment?

A: Potomac Energy Project’s goal is to show the concept can make electricity without any moving parts using coherent photons from a solid-state laser used to stimulate a magnetic circuit designed around a Type II superconductor. PEP plans to demo a small working device that will use a small amount of liquid nitrogen ~1 liter Dewar to prove the concept is real. One liter of liquid nitrogen (LN₂) cost ~\$0.06/liter at an energy cost of ~1 kilowatt-hour. (Ref: [Http://hypertextbook.com/facts/2007/KarenFan.shtml](http://hypertextbook.com/facts/2007/KarenFan.shtml))

Q: How much photon energy is needed to modulate static flux?

A: In the case study, PEP will use a 3-watt solid-state laser operating at 33% efficiency that delivers ~1 watt of laser photon energy that will be directed into the superconductor structure causing a modulation of the vortex cylinders at a given frequency. Two different magnetic paths will modulate the static flux emanating off the pole of a permanent magnet. The flow of static flux is controlled by photon modulation so electricity can be generated, i.e. coils must see a difference in flux density in order to produce electricity. The conversion efficiency or process is ~99.6%. The high efficiency is based on the photon computed temperature and the boiling point of liquid nitrogen. Only a small amount of photon energy is needed to modulate the superconductor thin films, because of the limited number of atoms involved and by taking advantage of avalanche principles.

Only 0.4% of the conversion energy is loss in heat, unlike a coal fired power plant and nuclear power plant which is ~67%. While liquid nitrogen is present the small device PEP is working on could produce as much as ~10 kilowatts of electricity and be of a size not much larger than a standard soda can.

The process is efficient because of the crystal lattice structure found inside of the superconductor thin films material and the way electrons interact with the photons. With the introduction of the 930 photons, this energy packet is ideal for electrons in a low-energy orbit to be absorbed and causes them to jump to the next higher quantum orbit whereby they break the superconductor state. This process is known as an avalanche. One photon injected into the superconductor starts this process which is similar to a runaway nuclear reaction, only without nuclear byproducts.

The most exciting part is, when the laser photon source is turned off, the superconductor material rejects the absorbed photon energy as long as there is LN₂ available and then returns to its original low energy quantum orbit which is a superconductor state. The process is supported as long as the cryogenic temperature is low enough to support the superconductor state.

Q: Is the input energy coming from the photon source or the nitrogen?

A: Figure 2 below provides an overview of how the DEC process works. The energy used to effect flux modulation is derived from the photon; this energy only starts the avalanche process. Liquid nitrogen supplies a cryogenic cold potential energy and heat generated during the process of producing electricity boils off the LN₂. The static magnetic flux source is supplied by a permanent magnet known to be a potential energy source. The permanent magnet is also responsible for the production of the vortices in the superconductor’s cylinders. Superconductor vortices convert the potential energy of the permanent magnet into kinetic energy without any additional input energy. The potential energy of the permanent magnet is converted into kinetic energy when vortices form. By controlling which vortex cylinder is working one can control the path of the static flux and the

flux coupled to coils in the magnetic circuit. Note here that only one magnetic path is in the superconducting state at any one time. The DEC concept converts known potential energy into electricity at super high efficiencies without waste products.

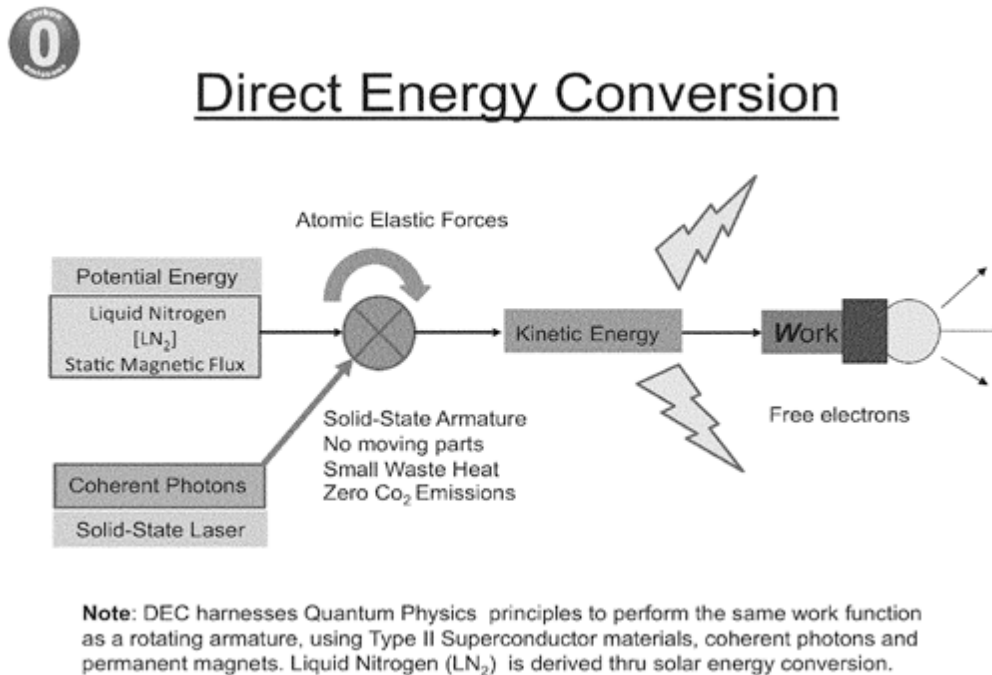

Figure 2. Direct Energy Conversion

Over the past few years or so, it's clear that the superconductor state could be affected by what is called the Casimir effect. Casimir suggested this in the very beginning of superconductivity. If this turns out to be true, then useful energy can be extracted directly from the environment. The implication could change the way humanity uses energy. Even if this is not the case, the superconductor is a self-organized criticality material, meaning that once the photon source is removed, the superconductor flips back to its original state, i.e. the superconducting state without any outside expenditure of additional energy, ready for the next pulse of photon energy. The process I am describing is going to revolutionize the way electricity is produced. No other process will be able to compete with the efficiency since it is solid-state, produces no harmful waste or nuclear byproducts, and does not require combustion or any hydrocarbon fuels.

Source: INFINITE ENERGY • ISSUE 86 • JULY/AUGUST 2009

Inventor: Eddie A. Sines

Electrino Fusion Power Reactor

Gordon L. Ziegler has discovered how to make a clean electrino fusion power reactor capable of generating up to a net of 1880 megawatts of DC electricity. The proposed energy source would produce no carbon emissions and no radioactive wastes. (By reversing the order-to-disorder arrow in the second law of thermodynamics, a \$50,000,000 electrino fusion power reactor could be built which would also reverse all aging, disease, and decay processes within a one-mile radius.) Supernovas and $\eta'(938)$ decay confirm electrino fusion theory.

Power output, however, cannot occur in this system without the simultaneous operation of two aspects of the invention. One is an accelerator-collider making a field reversing the order-to-disorder arrow in the second law of thermodynamics in a controlled area. Among other things, that field makes the other aspect of the system (the power source) efficient enough to be self-sustaining and prevents the formation of radioactive wastes.

Electrons are generally regarded to be structure-less spinning point charges. But that contradicts a reasonable postulate that occurred to Gordon L. Ziegler in 1967: "A spherically or cylindrically symmetric smooth charge distribution cannot have detectable spin." Electrons have detectable spins. Therefore they must not have smooth structure-less symmetric charge distributions. They must be lumpy and have internal structure.

An application of the Parsimony Principle shows that they must be composed of two half-charges orbiting each other at the speed of light. The reason scientists concluded that the electron was structure-less was that it could not be blasted apart in collisions up to 700 MeV each particle.

But in Ziegler's model, electron sub-particles are bound together by confinement by a speed of light barrier (they are trapped going faster than the speed of light). They cannot be blasted apart, even though they are two particles.

The two sub-particles of electrons make a whole different structure for matter than quarks and leptons. The sub-particles can also fuse with each other – making new particles. Fusing sub-particles of positrons reverses the order-to-disorder arrow in the second law of thermodynamics – making the power source efficient enough to be self-sustaining and preventing the radioactive wastes from forming. Fusing the sub-particles of electrons comprise the power source.

Key components include a polarized positron source, injector accelerators, inflection magnets, end magnets, and the beam transport.

Governments and utilities would buy electrino fusion power reactors because the process is a clean, inexpensive way to produce electricity. It is 1000 times as efficient as nuclear reactors. It does not require uranium or plutonium for fuel. It can run on anything for fuel such as dirt, sand, sewage, ground garbage, toxic chemicals, radioactive wastes, sea water, etc. without carbon nor radioactive pollutants.

Assume that the collision energy were 940 MeV to avoid unwanted heat (operate at room temperature), and the current in each beam was 1.0 ampere of electrons. The energy investment into the electrino fusion would be 1880 megawatts. The energy released in annihilation photons would be 3760 megawatts. Recoverable net power would be 1880 megawatts or less.

The collision energy of the linear accelerator would be 940 MeV (each particle – 1880 MeV in the center of mass frame). The current in each beam would be 1.0 amperes of electrons. There would be two beams 180 degrees from each other.

The energy released in annihilation photons would be 3760 megawatts. "Annihilation photons" are the 940 MeV X-Rays produced when a negatron annihilates a proton. These X-rays are converted to electricity by order-to-disorder arrow reversed photo-voltaic cells with nearly 100% efficiency.

In summary the 3760 megawatts output of annihilation photons would be converted to electricity. However, in order to keep the electrino fusion reaction going, 1880 megawatts would be taken from the 3760 megawatts to power the linear accelerator. The net energy output would thus be 1880 megawatts-electric.

The size of an electrino fusion reactor would be about 80' x 10' x 10'. The fuel is whatever brass or copper James M. Potter uses in constructing the walls of his linear accelerators. James M. Potter, Ph.D., is President, JP Accelerator Works, Inc., 2245 47th Street, Los Alamos, NM 87544, 505-690-8701 or 888-301-2833 or 505-661-8155, jpotter@jpaw.com, <http://www.jpaw.com>. 155 lbs of brass would be consumed over 100 years before shutdown for refueling. The linear accelerator would be a standard commercially available model. It would not need to be customized for an electrino fusion reactor.

The smallest electrino fusion reactor that would be possible to build is now about 80' x 10' x 10'. It may eventually be the size of a filing cabinet.

The projected cost of the first 1880-megawatt electrino fusion reactor is approximately \$100 million. This clean source of electricity could be built in two years, and the necessary Refresher built in one year. Electricity could be generated for only about 1.5 percent of current rates (a little over 0.1 cent per kwh). Subsequent clean energy sources can be built for \$37.5 million each.

The 1880 megawatts (net) of electricity generated by an electrino fusion power reactor would be Direct Current (DC). A utility would need thick wires and the biggest busbars and transformers on the planet. Conversion from DC to Alternating Current (AC) would require the world's largest inverters.

The electrino fusion reactor requires the Refresher to be self-sustaining. But the Refresher has several positive medical side effects due to reversing the order-to-disorder arrow that cannot be eliminated – in a controlled area reverse adult aging and wipe out diseases.

Refresher 1 Design Specifications

Size of accelerator	20 meters long by 3 meters wide
Diameter of channels	4 cm (maybe a little more to allow for water cooling channels)
Type of accelerator	Folded linear accelerator with pulsed klystron RF power supplies and S-band cavities (2856 MHz)
RF power supplies	Eight 35 to 50-megawatt pulsed klystrons
duty factor	0.1% (peak current 1000 times average current)
Average power	400 kW (20 kW per meter of accelerator)
klystron efficiency	~50%
total system power	800 kW
cooling water requirement for each 5 m section	5 to 10 gpm
cooling water required by each klystron	~ 5 gpm

cooling towers capacity	800 kW
Cost:	
Linear accelerator	\$12 million
Klystrons	\$ 8 million
Klystron power supplies and cooling towers	\$ 2 million
Magnets and their power supplies	\$ 2 million
System with controls	\$ 8 million
10% contingency	\$ 3.2 million
Builder's cost	\$35.2 million
Other budgeted items	\$14.8 million
Total budgeted	\$50 million
Creation time total	3 years
Design time (beam dynamics, RF power systems, cooling, and computer control)	1 year
Fabrication and subassembly testing	18 months
Installation and commissioning	6 months

(The following chapter is taken from *Formulating the Universe*, Volume II, by Gordon Ziegler, Chapter 7. Copyrighted by Benevolent Enterprises 2004. Used with permission.)

Chapter 7

SECOND LAW OF THERMODYNAMICS

A. Introduction

Everything goes from a state of order to more disorder. Brand new automobiles wear out and rust. Objects break or are damaged. A thermos bottle falls off the counter, and the inner glass bottle is shattered. We do not expect the shattered bottle to fall back up to the counter and become whole again. There is a one-way arrow for the events to transpire. That arrow is the Second Law of Thermodynamics.

Houses grow old and fall into decay. Barns fall down. Fruit spoils, people and animals grow old and die. Viruses mutate. People become ill and die. Crime and disorder in society increase. Homes break up. Aborted fetuses disintegrate. Dead people and things decompose. All of these negative occurrences are the outworking of the second law of thermodynamics – that part of which is an arrow making everything go from order to disorder.

Let us consider what other people have written about the second law of thermodynamics.

"Second law of thermodynamics

"An equilibrium macrostate of a system can be characterized by a quantity S (called *entropy*) which has the following properties:

(i) In any infinitesimal quasi-static process in which the system absorbs heat dQ , its entropy changes by an amount

$$dS = \frac{dQ}{T} \quad (7-1)$$

where T is a parameter characteristic of the macrostate of the system and is called its *absolute temperature*.

"(ii) In any process in which a thermally isolated system changes from one macrostate to another, its entropy tends to increase, i.e.,

$$\Delta S \geq 0. \quad (7-2)$$

"The relation (7-1) is important because it allows one to determine entropy *differences* by measurements of absorbed heat and because it serves to characterize the absolute temperature T of a system. The relation (7-2) is significant because it specifies the direction in which nonequilibrium situations tend to proceed."¹

The above expression of the second law of thermodynamics is regarding entropy and heat. Other writers include the order-to-disorder arrow in the second law of thermodynamics.

"It is a matter of common experience that disorder will tend to increase if things are left to themselves. (One has only to stop making repairs around the house to see that!) One can create order out of disorder (for example, one can paint the house), but that requires expenditure of effort or energy and so decreases the amount of ordered energy available.

"A precise statement of this idea is known as the second law of thermodynamics. It states that the entropy of an isolated system always increases, and that when two systems are joined together, the entropy of the combined system is greater than the sum of the entropies of the individual systems. For example, consider a system of gas molecules in a box. The higher the temperature of the gas, the faster the molecules move, and so the more frequently and harder they collide with the walls of the box and the greater the outward pressure they exert on the walls.

Suppose that initially the molecules are all confined to the left-hand side of the box by a partition. If the partition is then removed, the molecules will tend to spread out and occupy both halves of the box. At some later time they could, by chance, all be in the right half or back in the left half, but it is overwhelmingly more probable that there will be roughly equal numbers in the two halves. Such a state is less ordered, or more disordered, than the original state in which all the molecules were in one half. One therefore says that the entropy of the gas has gone up.

Similarly, suppose one starts with two boxes, one containing oxygen molecules and the other containing nitrogen molecules. If one joins the boxes together and removes the intervening wall, the oxygen and nitrogen molecules will start to mix. At a later time the most probable state would be a fairly uniform mixture of oxygen and nitrogen molecules throughout the two boxes. This state would be less ordered, and hence have more entropy, than the initial state of two separate boxes."²

"The explanation that is usually given as to why we don't see broken cups gathering themselves together off the floor and jumping back onto the table is that it is forbidden by the second law of thermodynamics. This says that in any closed system disorder, or entropy, always increases with time. In other words, it is a form of Murphy's law: Things always tend to go wrong! An intact cup on the table is a state of high order, but a broken cup on the floor is a disordered state. One can go readily from the cup on the table in the past to the broken cup on the floor in the future, but not the other way round.

"The increase of disorder or entropy with time is one example of what is called an arrow of time, something that distinguishes the past from the future, giving a direction to time."³

B. Electrino Model and 2nd Law

The natural tendency of leptons in beta decay is that the parent lepton combines with one or more gravitons to produce more particles. In all natural reactions, the order energy of the resultant particles is less than or equal to the order energy of the original particles.

1. Negative Energies. Let us consider antimatter more carefully. "In the Dirac theory also, *the permissible energy values for a free particle range from $+mc^2$ to $+4$ and from $-mc^2$ to -4* . The first of these results is of course just what we expect for a free particle – that its total energy can have any value greater than its rest energy. But the second result is quite puzzling, since it implies the existence of states of *negative total energy*."⁴ Anderson in 1932 discovered positrons in cosmic radiation. These were regarded as Dirac's negative energy particles. "The first two solutions of the Dirac equation . . . clearly describe a free electron of energy E and momentum \mathbf{p} . The two negative energy electron solutions . . . are to be associated with the antiparticle, the positron."⁵

However, in the annihilation it is not $(+mc^2) + (-mc^2) = 0$, but $2mc^2$ is the result of annihilation.⁶ There is something strange going on with the minus signs in these equations. The calculations are inconsistent.

Maybe there are two kinds of energy considered. One we can call entropy energy E_S . In the annihilation reaction, $|+mc^2| + |-mc^2| = 2mc^2$. Entropy energy is the higher value. The other energy is order energy E_O . In order energy the same reaction is $(+mc^2) + (-mc^2) = 0$.

Let us consider entropy energy and order energy for particle decay schemes. There are a few decay schemes where no negative order energy (anti-matter) is introduced in the right hand side of the decay schemes. In those few instances, the final order energy is equal to the initial order energy (when kinetic energy is taken into account). But in most cases, a trace of negative order energy (anti-matter) is introduced into the right side of the decay schemes. There is nothing on the left hand sides of the decay schemes to correspond to this addition of a trace of negative order energy on the right sides of the decay schemes. Therefore, total order energy is less on the right hand sides of the decay schemes than on the left hand sides (if only by a trace). A few decay schemes introduce a lot of antimatter (as K^-) on the right side of the decay scheme. The loss of order energy in the systems is greater in those cases. But in every case, for all natural processes, the order energy final is less than the order energy initial, or

$$\Delta E_0 \leq 0. \quad (7-3)$$

Let us check the order energy for electron electrino fusion reactions. Electrons made energetic by acceleration (as heavy as protons) fuse and form anti-protons. Matter is converted to anti-matter. Entropy energy is conserved, but not so order energy. Order energy is reduced in the extreme from +938 MeV to -938 MeV or more for each electron fused (two electrons are fused in each reaction). The order-to-disorder arrow for electron electrino fusion points in the usual direction. The system does obey the second law of thermodynamics.

2. Reversing the Order-to-Disorder Arrow. What would happen if we fused the electrino constituents of positrons instead of the electrino constituents of electrons? Entropy energy E_S would again be conserved. Entropy would be increased. However, order energy E_O would go from -2×938 MeV to $+2 \times 938$ MeV – from disorder to order. The order-to-disorder arrow would be reversed. This would be a reaction that would be prohibited by the second law of thermodynamics – unless the strong gravitational force that fuses the anti-semions would be stronger than the second law of thermodynamics (which otherwise governs weak interactions). The stronger of the strong gravitational force and the second law of thermodynamics should be determined by experiment.

More rides on that one experiment than perhaps on any one other experiment in this generation. If it is found that strong gravity is stronger than the second law of thermodynamics, then order can be restored at first in a small area, and then for the whole earth.

Here we see that the entropy arrow of time and the order-to-disorder arrow of time are separate and distinct, and are not one and the same thing. While all the reactions the author has studied increase entropy, the fusion of positron anti-semions reverses the order-to-disorder arrow, making more order out of the disorder.

Positron constituent electrino fusion might not only take the electrinos from disorder to order. It could make other physical processes in a local area go from disorder to order. The positron fusion not only violates the second law of thermodynamics, it reverses the order-to-disorder arrow of that law in a local area, making other processes in that area reverse. Let us consider that process more to see how it might be regulated.

We guess the desired relationships for reversing the order-to-disorder arrow in the second law of thermodynamics through dimensional analysis. We want to solve for r, the maximum radius in which the reversed law would be effective. There is a way we can obtain a length from combinations of our variables and constants. That way is in the right hand side of Eq. (7-4). The whole expression is the thermodynamic relation we are seeking. The thermodynamic relation is:

$$(\Delta E_o)_t > 0 \text{ where } r < \frac{(\Delta E_o)_1 c}{ik}, \quad (7-4)$$

where E_o is the order energy – the positive or negative energy in the pair production of particles; ΔE_o is the change in the order energy, where $(\Delta E_o)_t$ is the change in the total order energy of the system, and where $(\Delta E_o)_1$ is the change in the order energy for a single source reaction – for a positron fusion reaction it is approximately $2 \times 10^9 \text{ eV/collision} \times 1.6 \times 10^{-19} \text{ joules/eV} = 3.2 \times 10^{-10} \text{ joules/collision}$; c is the speed of light – approximately $3.0 \times 10^8 \text{ m/s}$; we shall solve for the effected radius r; i is the beam current in each beam in Coulombs per second (we will solve for 10^{-11}); k is the ratio of particle energy to particle charge. This energy per charge is the accelerated energy of the particle (roughly $1 \times 10^9 \text{ ev}$ times $1.6 \times 10^{-19} \text{ joules/ev} = 1.6 \times 10^{-10} \text{ joules}$) divided by the charge of each positron ($q = 1.6 \times 10^{-19} \text{ coulombs}$), which equals $10^9 \text{ joules per coulomb}$. The collision efficiency eff is not needed in this equation, because the result is not in particles, but is already in collisions.

Incredibly, the lower the current, the bigger is the radius of the affected area. The greater the current, the smaller is the radius of the effected area. With 10^{-11} A beam currents, the effected radius r solves for 9.6 meters – roughly 10 meters, which describes a small area – less than a tenth of an acre.

To get an idea of the positron beam currents needed to reverse the order-to-disorder arrow of the second law of thermodynamics in what size of affected radius, see Table 7-1 below.

For an area the size of	r	beam current
House	10 m	10 pA
four football fields	100 m	1 pA
community	1 km	100 fA
city	10 km	10 fA
Israel	160 km	0.6 fA
U.S.	2,400 km	0.04 fA
World	13,000 km	0.008 fA
Sun	1.7E11 m	6E-22 A

Table 7-1. Beam currents versus affected radius for reversal of the order-to-disorder arrow of the second law of thermodynamics.

We must make sure that reversing the second law will do only good and not evil before we flip the switch. Inspired evidences will be studied in the next chapter on a wide range of phenomena affected by reversing the order-to-disorder arrow in the second law of thermodynamics.

¹F. Reif, *Statistical Physics*, Berkeley Physics Course--Volume 5 (New York: McGraw-Hill Book Company, 1967), p. 283.

²Stephen Hawking, *A Brief History of Time--From the Big Bang to Black Holes* (New York: Bantam Books, 1988), pp. 102, 103.

³*Ibid.*, pp. 144, 145.

⁴Robert B. Leighton, *Principles of Modern Physics* (New York: McGraw-Hill Book Company, Inc, 1959), p. 665.

⁵Francis Halzen, Alan D. Martin, *Quarks and Leptons* (New York: John Wiley & Sons, 1984), p. 107.

⁶David S. Saxon, *Elementary Quantum Mechanics* (San Francisco: Holden-Day, 1968), p. 386.

(End of Chapter 7)

EXECUTIVE SUMMARY OF BUSINESS PLAN

electrino energy is a new company formed to develop the inventions envisioned by the new model of physics—the electrino fusion model of elementary particles. Our company provides theoretical work and guidance to licensees. Our focus is the reverser of aging, disease, and decay processes (Refresher 1) and whatever else we must do to fund the Refresher 1.

electrino energy was formed October 12, 2005 as an invention development and theorist service specializing in four high-technology inventions – inertia-less craft; artificial gravities; reverser of aging, disease, and decay processes; and electrino fusion reactors generating electricity. All four inventions have potentially extremely high value. But all four inventions currently have three principle difficulties: 1) they are unbelievable by almost all persons – including agency heads, venture capitalists, congressmen and senators; 2) almost all of them cost scores of millions of dollars to develop; and 3) **electrino energy** has no money to develop them. With no capital and no revenue stream or other assets to fall back on, **electrino energy** cannot even get a guaranteed loan.

But **electrino energy** is not resource-less and in a hopeless condition. It has three principal approaches that it can take to resolve this dilemma:

1) Though the aging reverser is the most urgently needed, a miniature inertia-less craft can be constructed for a whole lot less money. It should be possible to construct one for a few hundred dollars borrowed from friends. But that technology could be licensed for hundreds of millions of dollars – enough to finance all the four high-tech inventions.

2) As a back-up to that approach, venture capital angels could be approached to advance the money to finance the reverser of aging, disease, and decay processes. This invention is not only high tech, but medical. The other inventions could be developed at a later time.

3) As a back-up to that approach, the owner could pursue his particle theory, predicting the masses of particles. That may be difficult, but not impossible. This would do what no other physical theory can do. Such a feat would be publishable, arousing interest among scientists for creating a facility to test the model – opening the way for government funding of the high-tech inventions.

A master decision tree flow chart linking and employing these three alternatives for funding the development of the inventions is in Section 7.0 Financial Plan.

According to alternative 1), projected sales and profits for the first four years of operation are summarized below:

Year	Sales(\$)	Profits(\$)	Profit/Sales(%)
1	200,000,000	0	0
2	0	0	0
3	0	0	0
4	10,000,000,000	9,000,000,000	90.0

According to alternative 2), there are no actual projected sales and profits for the first three years of operation. Year four is the same as above. According to alternative 3), there are no projected sales or profits for the first five years.

Currently, there are no competitors for any of these inventions. Once public incredulity is overcome by demonstration, the devices should have huge market potential.

The size of the electricity generating market is essentially enormous. It would be up to 50 percent of electric generation world-wide eventually. That's probably over a trillion dollars.

A self-powered high-speed locomotive powered by an electrino fusion power reactor would need to be at least 85 feet long.

Inventor: Gordon L. Ziegler, Lacey, Washington, USA
 benevolententerprises.org <https://app.box.com/k0g5nkkjfb6okhmyr6um>
 padrak.com/vesperman "Locomotive Power Sources"

Plasma Biomass Gasification

Examples of plasma biomass gasification systems can be found in the processes developed by Dr. David Wallman [US 5,417,817], Dr. Ruggero Santilli, Dr. Randall Mills [US 6,024,935], and others. What these technologies have in common is that they operate by producing a variety of combustible gases from a wide variety of municipal waste, biomass waste, sewage and other materials containing high concentrations of hydrocarbons. Each of these systems produces substantially more energy content in the collected gases than is required to drive the carbon-arc filaments which operationalize them. The amount of carbon dioxide generated by the combustion of the gases derived from these processes is precisely the same as they absorbed while the materials were originally being formed.

Contrast this with burning fossil fuels (diesel, gasoline, oil, natural gas) which resurrect old buried carbon and add it to the atmosphere. The combustion of gases produced by biomass processing is usually characterized as follows: It requires 3300 BTU to produce 250 liters per hour of COH₂ (8.5 cubic feet/hour). With a heating value of over 500 BTU per cubic feet, the COH₂ output energy exceeds 4,000 BTU, often approaching 5,000

BTU in high efficiency designs. Accordingly, the biomass gasification process operates at an over-unity efficiency of between 125%-150%. This process is a largely untapped resource. Millions of gallons of farm-produced liquid biomass is going to waste, as is the energy potential represented by the CO₂ which could be produced from municipal sewage and waste water systems.

When looking at solutions for generating energy from waste, organizations must ensure that they are utilizing technology that delivers the most efficient use of the waste feedstock. Advanced Plasma Power is a leading technology provider for advanced waste to energy/fuel plants employing its globally patented Gasplasma® technology. After the removal of valuable recyclables, the Gasplasma® process treats a wide range of feed stocks including residual municipal solid waste and commercial/industrial waste – converting it all into two high-value outputs: a clean, high quality, energy-rich synthesis gas, and a solid, vitrified product – each with multiple applications.

Advanced Plasma Power's advanced Gasplasma® technology today delivers 50% electrical conversion efficiency – twice that of conventional steam cycle technologies. Looking ahead a few years, the efficiency may be further improved by half as much again with the establishment of commercial scale fuel cell technology. How does Gasplasma® achieve this? The key distinguishing factor is the ability for Gasplasma® to produce an energy-rich synthetic gas capable of use directly in a gas engine and/or gas turbines or in fuel cells.

The synthetic gas can be used to generate electricity directly in gas engines, gas turbines and/or fuel cells. Or, it can be converted to synthetic natural gas, hydrogen or liquid fuels. The solid product, Plasmarok®, is strong, inert and non-leaching and has a variety of valuable end uses such as a building material. The process is clean, modular and scalable, delivering high efficiencies and maximizing landfill diversion whilst minimizing visual and environmental impact. See <http://www.advancedplasmapower.com/offering-gasplasma.aspx>.

Plasma biomass gasification is not a trivial energy source. The Republic of South Africa does not import a single drop of petroleum to support its transportation requirements. Instead, 100% of its diesel fuel and gasoline is produced by two plants which operate on these principles.

Nano-Membrane Pyro-Gasification Process

Coal is used across our planet as a source of energy, and has been for a very long time. Among the biggest consumers of coal are traditional power plants that burn it in huge quantities to produce electricity for the power grid.

A product of burning coal is the production of ash. The portion of the ash that travels upwards with the flue gases is called fly ash. In the past, power plants allowed the fly ash to escape into the environment. This was not an environmentally friendly practice due to the fact that fly ash can contain toxic substances such as arsenic, mercury, vanadium, and dioxins.

In modern times, environmental regulations have required power plants to capture the fly ash before it is released into the environment. The regulations have been successful in that the global average of fly ash captured is around 99%. However, the capture of fly ash has created another problem, which is what to do with the massive amount of it that is produced. A portion of the fly ash is used in various applications. For example, it can be used instead of Portland cement in the process of making concrete. But the majority of the fly ash produced by power plants is either stored on site in ash ponds, or is sent to landfills.

MP BioMass (www.mpbiomass.com) has developed patented technological systems that can make use of the fly ash. First, their process can recover carbon from the fly ash, which still has a calorific value. They state fly ash may contain 8% to 14% of carbon residue, which can be utilized to produce energy. Secondly, their process removes heavy metals and toxins from the waste which makes it a more environmentally friendly substance. Finally, they are able to extract valuable ferrous and non-ferrous metal deposits from the fly ash, which have value.

Basically, the results of this processing of fly ash are that energy is produced, toxins are removed, and valuable metals are extracted. Instead of simply being put into a landfill, the fly ash serves a practical and economic purpose.

One estimate of a fly ash dumpsite in the USA had an outside valuation of 2.2 billion dollars on its 4.1 million tons of fly ash. Think of the containment of fly ash that has over 100 million tons of coal ash uselessly stored in mine shafts, open pit dumpsites, and many unregulated sites, or left abandoned in areas throughout the world. This system has the ability to strip the carbon atom from the coal ash without melting down the metals or all of the minerals. The most notable of these metals and minerals is iron. These sites may contain more than 15% of iron, and some sites contain more than 5% of aluminum. Calcium, copper, and some otherwise rare elements such as germanium are also frequently present that can be economically recovered and sold.

The technology can also be applied to garbage, tires, sewage sludge, agriculture waste, and animal waste.

By burning coal as fuel, steel mills and power plants emit carbon dioxide into the atmosphere. Managing carbon dioxide as well as fly ash can be a challenging task, especially as environmental regulations have become more severe. Many coal power plants facing shut-down because they can't afford the modifications required to be compliant with new emissions standards, could not only stay open, but actually make a profit from those emissions, while cleaning up the environment.

MP Biomass offers a method of capturing the carbon dioxide from flue gases to totally eliminate carbon dioxide emissions. This is accomplished via a world-wide patented system that mimics a form of artificial photosynthesis.

Their "nano-membrane pyro-gasification process" not only extracts carbon dioxide from flue gases, but prevents other pollutants from escaping into the atmosphere. The process also captures oxygen (grade 5), and isolates hydrogen from the flue gases. This allows for the production of high-grade methanol and electricity, of which a small portion are used to keep the process going. 551 gallons of methanol is produced from each ton of carbon dioxide captured.

This patented technology can take garbage, sludge, animal waste, tires, sewage, CO₂, coal ash and fly ash, petroleum waste, various gases, vegetation or lawn and garden debris, and then thermal chemically processes it. It will produce more electricity to be funneled into the power grid, produce oxygen (grade 5) for industrial use, and millions of gallons of methanol in a year. This makes for a tremendous return on investment (ROI) for energy companies, manufacturers, private enterprise, as well as local municipalities, plus state and federal governments. In fact, the ROI usually will help pay for the system in 5 years or less.

Their system operates very much like a scrubber, only using configured nano-membrane technology. Plus different fluctuations of temperature, reformed into the holding tank with steam by lowering the temperatures of the reformation of the synthetic gas, as opposed to the continual raising of the temperature. This allows for the production of methanol rather than methane, and provides a high cetane rating of the methanol (60+), which is excellent for biodiesel fuel or internal combustion engines. The methanol does not need to be reformed into dimethyl ether (DME) or mixed with gasoline. DME is sometimes substituted for propane.

Using a biomass feedstock of almost any waste or pollutants, or gases such as carbon dioxide, this biosource system takes the pollutants, and begins to filter the particulate materials in its 4-cell process. The fine particulate materials are collected and thermal chemically processed. Heavy metals are dropped to a basin, and the processed particulate materials are turned into a synthetic gas. Nitrogen oxide, sulfur dioxide and sulfur trioxide are processed through thermal degradation.

The gases are then funneled to cells two and three, where temperatures reach approximately 950 C or 1,742 F. Synthetic gas produced here is funneled and moved to a holding tank or cell four. This synthetic gas produced from the thermal chemical process has a lighter density value than natural gas. The holding tank is where the process of the synthetic gas goes through reformation to methanol, which is chemically reformed through the fluctuation of steam and the lowering of temperature in cell four. The methanol has a cetane rating of more than 60. This makes the methanol by-product available for diesel or internal combustion vehicles as well as for cooking or heating. DME can be integrated with this methanol.

The real secret here is in the nano-membrane patented configuration that has been constructed within the cells as tubes, to filter particulate materials and various gases. This process of filtration is kind of like taking a kaleidoscope, intersecting the filtration tubes in a highly technical configuration. Engineers adjust them correctly for the various biomass feedstock or gases it needs to collect and filter appropriately.

This process mimics photosynthesis, taking a source or product, then strips and breaks it down. It is then replenished with an abundance of renewable energy sources from the thermal chemical processing of the original material or feedstock.

Finally, the capture of the synthetic gas in the holding tank, and the fluctuation of temperatures and of steam into the final stages, helps create the methanol as opposed to the creation of the highly hydrocarbon gas methane. Methane is more than 20 times as strong a greenhouse gas as carbon dioxide.

The technology of MP BioMass is proven and currently in use. It is beyond the prototype stage. Millions and millions of dollars have already been spent developing the technology, and the first plant has been operating in Serbia since 2003. The company also has three smaller plants in Italy, which utilize their technology. A ten-megawatt plant is planned for upstate New York, and a huge two-gigawatt plant has been purchased, which will be built in Saudi Arabia. It is expected to be completed in 2015.

The plants also require no shutdown time for maintenance. When asked about the lifespan of a plant, it was stated the parts (manufactured by Siemens) have a 45-50 year lifespan, and a warranty will be provided with the purchase of a system.

The cost of building a 20 MW system (producing twenty megawatts of electrical power) is approximately 210 million dollars, but is said to pay for itself in 5-7 years. This breaks down to 10.5 million dollars per megawatt. Of course this is only the cost of building the system, and does not include whatever payments are required to be made to MP BioMass by the customer. In all, there are around ten plants presently in operation. And they hope to be able to build them at a rate of 7-8 systems a month.

http://pesn.com/2012/01/21/9602018_Top_5_Free_Energy_Technologies_Unfolding_Now/

http://pesn.com/2012/01/11/9602008_MP_BioMass_Offers_Carbon_and_Fly_Ash_Solutions_for_Coal_Plants/

Super Steam Technology

The 'super steam' machine combines compressed air, untreated or even polluted water, and almost any combustible fuel to produce steam at any pressure or temperature. The response is instant compared with a

conventional boiler taking hours to reach operating pressure and temperature. The efficiency is over 90%, which compares favorably with a conventional boiler's efficiency of 40%. Maintenance costs, fuel consumption, and air pollution all go way down. 3500 applications have been found for super steam technology. Electricity can be generated for 1 cent per kilowatt-hour. Super steam technology can be scaled from the size of a one-pound coffee can to a house.

With the rising cost of fuel in today's economy, and the ever-increasing pollution in our atmosphere, the time has come for drastic measures to be taken. For over 140 years man has utilized steam as a working force for many applications, such as locomotion, heating, food processing, cleaning, excavation, generation of electricity, sterilization, and so forth.

Now, in the 1990's, a new and bold energy system is ready for the ever-growing demands of the world. The 'Super-Steam Technology' (SST) is the answer to many of today's ever-increasing energy needs.

What is SST? Simply put, SST is a system that produces steam at any pressure or temperature, instantly.

What is steam used for in today's world? Ironically, almost every aspect of everyday life is affected. In addition to the uses listed above, are operation of large factories, cooling, water distillation, and much, much more.

With the SST system, steam can be produced instantly at any temperature or pressure without the need for water purification or huge conventional boiler systems.

This technology has been tested and certified by the American Society of Mechanical Engineers (ASME), and has its own code and stamp. This differentiates SST technology as completely different from conventional boiler technology.

Here are a few of the many applications and benefits of the SST System.

SST SYSTEM BENEFITS

A single forty-horsepower (40 H.P.) conventional boiler is approximately the size of a railroad tank car. The SST unit can be designed to operate from the size of a beverage can to the size of a large building.

The SST unit can deliver the same BTU output as a 40 H.P. conventional boiler, at the size of a small shipping crate, versus a railroad tank car.

In the SST system, pressure and temperature are independent of each other, whereas the temperature achieved by conventional boilers is dependent on the pressure.

The SST system can produce steam instantly. It does not require hours of fuel consumption to reach operating temperature, as do conventional boilers.

The SST system is over 90% efficient, whereas a 40 H.P. conventional boiler is approximately 40% efficient.

The SST system does not require purified or treated water. It can take polluted water, salt water, or any other contaminated, liquified material without doing any damage to the unit. Conventional boilers must have purified and treated water to operate.

The SST system can produce steam at virtually any temperature, from hot water at 180 degrees Fahrenheit, to super-heated steam at over 3000 degrees Fahrenheit.

The SST system has no moving parts to wear out.

The SST system can operate at pressures from 1 pound per square inch (PSI) to 3000 PSI, or greater, with airflow volumes of 1 cubic foot per minute (CFM) to well over 2000 CFM.

The SST system will operate on propane, methane, gasoline, kerosene, methanol, diesel, hydrogen, or any other combustible fuel.

USES OF THE SST SYSTEM

Purification of polluted water or sewage.

Conversion of salt water to drinking water.

Fire-fighting applications.

Heating and cooling of homes and businesses.

Instant-on, which means no wasted fuel or warm-up time.

Snow and ice removal from roads, airport runways, resorts and businesses.

Sterilization and nurturing of soil for agriculture.

The SST system can be utilized with the upcoming sonic chemistry industry, which has far-reaching applications for previously unknown and undiscovered chemicals and metals.

The energy savings alone have far-reaching economic implications.

Virtually 100% of the fuel consumed is turned into useable energy, which means no pollution or exhaust into the atmosphere.

The SST system can dramatically increase electricity production by eliminating costly conventional boilers and water purification.

Small, portable units can be developed for home use, such as steam-cleaning, and insect and fire-ant removal, without the dangers of insecticides.

Super-steam technology could be combined with solar hydrogen producers and hydrogen storage tanks for on-site renewable energy uses. Inventor is Leonard Dorsett, Super Steam Technology, P.O. Box 365, Grapevine, Texas 76099-0365 817-421-0170.

Gas-Phase Catalytic Fusion

Activated carbon catalysts are loaded with various precious metals (by weight, in the range of 0.1% to 0.5%). Palladium works best so far. When these catalysts are heated, considerable excess heat is produced reliably when such catalysts are exposed to several atmospheres of heavy hydrogen gas (deuterium gas). Pairs of deuterium atoms are fused to produce waste helium-4 atoms plus abundant clean heat. No lethal radiation is released. One cubic kilometer of ocean water contains enough deuterium that when catalytically fused, the energy released equals the chemical combustion energy in all of the earth's known oil reserves.

With suitable insulation, the process, once started, is self-heating. Temperatures can rise well above the boiling temperature of water. Engineered with efficient heat exchangers, thermal/electrical energy generators can be built in sizes for applications ranging from mobile homes to large centralized generating stations. No electrolysis is involved nor are finicky electrodes required as with some other types of low-energy nuclear transmutation devices.

However, the device's requirement for rare precious metals such as palladium could hinder widespread use. One possible answer may be to transmute more common elements into palladium using the Hawkings' generator of cold electricity.

SMALLER GENERATORS

Casimir-Layered Electrodynamic Generator

A Casimir array consisting of stacked CD-ROM type disks coated with alpha-emitter isotopic thin film, which have been super-compressed to provide room temperature super-conductivity, is proposed. Controlled oscillation of the stack will produce ion flow which can be rectified and used.

The electrical function is the same as the aforementioned thin-film power generating disks with the added concept that when plates comprised of materials with highly divergent dielectric coefficients are finely polished and placed in immediate juxtaposition to each other, after having been coated on one side with the appropriate alpha-emitter materials, the stack of such panels can then be oscillated in the X axis at a rate and magnitude that will alter the Lagrangian address transitional electrons are positioned in.

With the alteration of the address the electron is forced to find a path to match up with other quantum ensembles possessing spin, charge, and polarity vectors that will give the electron a zero sum balance. As soon as the electron's transitional trajectory is altered in a way that allows it to come into contact with the Meissner Field of an adjoining superconductive layer, the electron will be captured, rectified and converted to a set of attributes that enable it to be harnessed to perform work functions.

The physics is based on the model of fine scale interactions described in the Y-bias and angularity model. See David G. Yurth's summary "Y-Bias and Angularity: The Dynamics of Self-Organizing Criticality from the Zero Point to Infinity" in www.padrak.com/vesperman. Inventor is David Yurth.

Thin-Film Power Generating Disks

An alpha-emitter isotope is combined with a proprietary thin film applied to a disk [same form factor and size as a conventional CD-ROM disk] which has been treated to produce a substrate with room-temperature super-conductive properties. This technology would make it possible for the system to pick up 10^{17} electrons per square cm that are emitted by the alpha emitter materials. The super-conductive surface features of the substrate materials would amplify rather than attenuate the amperage, providing the ability on a scalable basis to drive 2.25 volts DC at amperage that is totally dependent on the amount of surface area provided by the plates.

This is tantamount to a self-recharging capacitor device with a half-life of more than 1 billion years that emits no waste materials and consumes no fuel.

The physics is based on the model of fine scale interactions described in the Y-bias and angularity model. See David G. Yurth's summary "Y-Bias and Angularity: The Dynamics of Self-Organizing Criticality from the Zero Point to Infinity" in www.padrak.com/vesperman. Inventor is David Yurth.

Magnetic Drive Generator

The following is Larry B. Woods' June 5, 2014 email (edited) to Gary Vesperman describing his 'magnetic drive generator'. Larry has a Ph.D. in Electrical Engineering from University of Missouri-Columbia.

Our 'magnetic drive generator' is currently designed to produce 5 kilowatts. It is a small unit, about 3 feet cubed. The power source is magnetic with no other power source. It produces power through magnetic induction only. The coil used in this generator is a special toroidal coil generating 10 amperes per volt. These coils have only negligible voltage drop with applied load. As load increases the voltage remains the same and amperage rises. As amperage rises the magnetic field increases thereby decreasing the resistance of the conductor.

These coils and magnetic drive generators will be available commercially by 2015. For intellectual property rights protection we are applying for patents and to the International Copyright Trust.

Dr. Woods is also developing a 'magnetic vortex drive engine' for space travel. A description is available in Gary Vesperman's "Space Travel Innovations" which is linked at Gary Vesperman's www.padrak.com/vesperman, Ken Rasmussen's www.commutefaster.com/vesperman.html, and Kathleen Smith's <http://the-door.net/the-colorado-center/radioactivity-neutralization-methods-and-more/>.

The power supply for the magnetic vortex drive engine is planned to be the magnetic drive generator.

Hybrid Cold-Fusion Hydrogen Reactor

The hybrid cold-fusion hydrogen reactor is intended to be an economical super-efficient heater for homes and as a hot water heater. The device is so new that its potential ultimate electrical input-to-thermal output conversion gain is yet to be experimentally determined. Applications could include heating homes and other buildings, greenhouses, and fish tanks. The electrodes are made of nickel. Inventor is Hans Becker.

Energy Catalyzer

The [E-Cat](#) or "Energy Catalyzer" could be described as utilizing "cold fusion" or "low energy nuclear reactions". It allows for massive amounts of heat to be released from novel nuclear processes, between ordinary nickel powder and hydrogen gas.

Eng. Andrea A. Rossi and Professor Sergio Focardi of the University of Bologna (one of the oldest universities in the world), have announced to the world that they have a cold fusion device capable of producing more than 10 kilowatts of heat power, while only consuming a fraction of that.

On January 14, 2011, they gave the world's first public demonstration of a nickel-hydrogen fusion reactor capable of producing a few kilowatts of thermal energy. At its peak, it was capable of generating 15,000 watts with just 400 watts input required. In a following test the same output was achieved but with only 80 watts of continual input.

The company doesn't always use the term "cold fusion" to describe the process, but often refer to it as an amplifier or catalyzer process.

Focardi states: "Experimentally, we obtained copper; and we believe that its appearance is due to the fusion of atomic nuclei of nickel and hydrogen, the ingredients that feed our reactor. Since hydrogen and nickel 'weigh' less, copper must have released a lot of energy, since 'nothing is created or destroyed.' Indeed, the 'missing mass' has been transformed into energy, which we have measured. It is in the order of a few kilowatts, two hundred times the energy that was the beginning of the reaction."

They also claim to be going into production, with the first units expected to ship by the second half of October 2011, with mass production commencing by the end of 2011. The first units will be used to build a one-megawatt plant in Greece. This one-megawatt plant will power a factory that will produce 300,000 ten-kilowatt units a year.

This would become the world's first commercially ready "cold fusion" device. Licensees are mentioned, with contracts in the USA and in Europe. Mass production should escalate in 2-3 years. Presently, Rossi says they are manufacturing a 1-megawatt plant composed of 125 modules. These modules should begin shipping by the end of October. On January 31st, 2011, Rossi wrote: "The cost to produce the catalyzer is 1 cent per MWh generated; the life expectancy is 20 years; the cost impact is between 1 and 1.5 cents per MWh."

In describing the operation of the device, he said: "To start up the reactor you have just to turn on a switch. The reactor works with enormous margins of safety, so there is no need of a particular skill. Just follow the instructions. The refueling is every 6 months and will be made by our dealers."

According to Rossi, the demonstrated device shown on January 14, 2011 is their industrial product that is claimed to be reliable and safe. In normal operation it would produce 8 units of output for every unit of input. Higher levels of output are possible but can be dangerous. They will soon start serial production of their modules. Combining the modules in series and parallel arrays it is possible to reach every limit of power. The modules are designed to be connected in series and parallels.

Rossi also says that they have had one reactor that has run continually for two years, providing heat for a factory. It reduced the electric bill by 90%. Also, the reactors can self sustain by turning off the input, but they prefer to have an input. The device will be scheduled for maintenance every six months. You control it "just as you turn on and off your television set."

More than two thousand prototypes were built and destroyed in refining the design and learning how to control and scale up the reaction.

Convinced they have already adequately proven this to the necessary parties, they are not in a hurry to give demonstrations to curious scientists. On January 21, 2011, Rossi wrote: "Yes there will be a scientist talking about us, no demo anyway: no more demos before the start up of the 1 MW plant."

An E-Cat system is small, but produces a robust amount of energy. Typically, a system is composed of a small metal tube (although other shapes have been used) that serves as the reactor core. Specially processed nickel powder, hydrogen gas, and a proprietary catalyst is placed inside of this sealed tube. When subjected to a combination of heat and pressure, excess thermal energy is produced. A volume of water or other liquid coolant flows around this reactor core and extracts the heat while cooling the core in the process.

From a very small system that can fit on a table top, many kilowatts of thermal energy can be generated. In controlled laboratory tests, it is asserted a reactor core the size of a D-cell battery can produce a maximum safe output of 10 kilowatts of heat. This thermal energy is produced while using no radioactive materials, producing no nuclear waste, emitting no radiation into the environment, and releasing zero pollution into the environment.

Basically, this technology represents a safe and clean form of nuclear energy, without any of the drawbacks of conventional fission based nuclear power. Even in a worst case scenario such as a natural disaster, an E-Cat cannot "melt down" and produce a dangerous situation. If an E-Cat starts to overheat due to physical damage or coolant leak, the nickel powder will simply melt into a solid lump, and the nuclear processes will cease.

On Oct. 28, 2011 the inventor Andrea Rossi allowed his first customer to test a one megawatt plant in Bologna, Italy. The test was a success. In fact, for a period of five and a half hours the E-Cat system produced a constant output of just under half a megawatt of heat, with near zero input power. The customer signed off on the system, and purchased it. Currently, Rossi is working with the first customer – along with the well known company National Instruments – to develop more sophisticated control electronics for his systems. Although the plant still resides in Bologna, it is expected to be in the hands of the customer within a couple months.

Recently, Andrea Rossi announced that he is working towards producing a quantity of one million, ten-kilowatt E-Cat units for domestic use. These units will both provide heating for the home, and be capable of producing hot water. To efficiently produce the one million units at the lowest price possible, he is engineering an automated plant that utilizes robotics technology. He hopes to start offering the units by the end of 2012 or perhaps early 2013, at a retail cost of around \$500 dollars each. Eventually, he hopes to offer kits that will allow these systems to be retrofitted to produce electricity, in addition to heat.

When widely proliferated, the E-Cat technology holds the potential to tremendously reduce, and eventually eliminate the need for fossil fuels. Its huge potential along with its emergence into the market with the one-megawatt size has earned it the number one spot on Sterling Allan's list of the top five technologies. See http://pesn.com/2012/01/21/9602018_Top_5_Free_Energy_Technologies_Unfolding_Now/.

Self-Recharging Energy Generating Gel Cells

Nano-particulated alpha-emitter isotope materials are intercalated with conventional electrolytic materials in the presence of advanced anodic materials in a gel cell environment to produce self-recharging energy generating cells. The true measure of potential versus actual performance is measured in watt-hours/kilogram.

In tests conducted with the I.N. Frantsevich Institute for Problems of Materials Science (IPMS), Kiev, Ukraine, we measured energy densities in excess of 1140 watt-hours/kilogram using conventional materials and the proprietary IPMS mono-molecular carbon crystalline lattice. These measurements were corroborated by the Idaho National Engineering and Environmental Laboratory and the Advanced Materials and Technologies Laboratory of the Department of Defense in 1993.

When an alpha-emitter such as thorium-232 is used to replace cobalt-lithium in a polymer base, the addition of 10^{17} electrons per square centimeter increases energy densities to more than 1500 watt-hours/kilogram, which is more than double the energy density of gasoline.

The physics is based on the model of fine scale interactions described in the Y-bias and angularity model. See David G. Yurth's summary "Y-Bias and Angularity: The Dynamics of Self-Organizing Criticality from the Zero Point to Infinity" in www.padrak.com/vesperman. Inventor is David Yurth.

Electronically Shaded Photo-Voltaic Glass

By laminating a specially designed layer of liquid crystal material between panes of either clear glass or clear polycarbonate materials, which have been coated with either an indium-tin oxide or transparent metallic conductive film, a window transparency control system has been created which enables the viewer to darken the window pane [or other application] electronically, without the aid of shutters, blinds or curtains.

Indium-tin oxide is a transparent electrically conductive thin film that is used to carry voltage to the light-emitting diodes of every display panel in the world. The indium-tin oxide thin film is deposited on the surfaces of two panes of glass. A second film, a gel comprised of liquid crystal material, is inserted between the two panels. Electrical current is passed through the gel, with the indium-tin oxide serving as the electrodes.

The panel also rotates polarity up to 90 degrees from the vertical and substantially reduces infrared transmissivity. Buildings with windows made of electronically shaded photo-voltaic glass should have significantly lower air conditioning loads because they offer full blockage of infrared radiation. Buildings should additionally have lower net electrical power consumption because windows facing the sun will be able to generate usable photo-voltaic electricity.

CRL Opto has built and is testing the initial proof-of-concept prototypes equipped with gradient controls for transmissivity using photo-spectrographic protocols. This application is ready for production and is patent protected (US Patent No. 7,356,969 B1, April 15, 2008). Inventor is David Yurth.

MulTask Dome Multiple-Output Omni-Directional Solar Power Generator

The MulTask Dome multiple output omni-directional solar power generator concentrates the sun's rays from any direction without the need of tracking systems, creating temperatures as high as 1600 F. It can be used singly or arranged in a battery, to heat air and liquids and to concentrate sunlight on solar cells. It uses a simple kind of hemispherical lens to concentrate sunlight at the center of the area covered by the lens. Cool air flows from the outside toward the center, where it flows up within the solar collector and is heated, then exhausted at the perimeter. Similarly, a cool liquid flows to the center, is heated, and drawn out. A photovoltaic cell at the center is activated by concentrated sunlight to produce electricity, which is transmitted out along a wire running through the cool air inlet.

The MulTask Dome delivers practical and efficient energy in all locations. Self-focusing with no moving parts, its transparent, high-impact glass hemispheres collect sun rays from any direction (new protected technology). It has no need for expensive sun trackers and high maintenance assembly. It offers very low heat and energy loss (captures most energy collected in enclosed bubble and piped away). It can be mounted on any roof or wall without special towers or expensive super structure. As a scalable solar collector for any residential, commercial and industrial application, the MulTask Dome is cheaper than traditional flat solar collectors and parabolic (Heliostat) array solar plants. The proprietary special glass bubble is resistant to impacts, scratches, hail, and high winds.

The MulTask Dome's multiple outputs include electricity (from photovoltaic cells, thermo-ionic "Power Chip" modules, magneto-hydro-dynamic devices, and the Stirling heat engine) plus heated liquid/air. A circular prism around the central photovoltaic cell converts low-angle light rays to useable angles over the center. Its efficiency is 36-45% – more efficient than traditional photovoltaic or other concentrators. Its proprietary, non-electrical Solar Safe Umbrella reflects sun's rays if its temperature reaches an unsafe level.

Some of the focused heat in traditional concentrators is lost by either convection or radiation. The Multask-Dome's enclosed bubble captures most of the heat and pipes them to hybrids of generators below to be utilized. A high-efficiency photovoltaic cell in the center collects incoming light and converts the light to electricity.

Heat generated in this area is captured in two different ways: First, chilled or cold air is piped around the jacket of photovoltaic cell wires and directly blown over the surface of the photovoltaic cell. This cold air will increase efficiency of the solar cell. Second, heated air will be carried away in the exhaust pipe for heating, cooking or storage.

Solar energy concentrated by the Multask-Dome can be utilized and converted by hybrids of several technologies: Radiated heat can be utilized for domestic uses including heating, air conditioning, cooking and drying.

The “High Expansion Magnetohydrodynamic Liquid Metal Generator of Electricity” (U.S. Patent No. 5,637,934 Gracio Fabris) has a thermal-to-electricity conversion efficiency that exceeds 70%. See patent at <http://www.google.com/patents?id=tOUhAAAEBAJ&printsec=abstract&zoom=4#v=onepage&q&f=false>.

Power Chips™ are thermo-ionic generators that offer an efficiency of up to 70-80% of Carnot for the conversion of heat to electricity. The Borealis Power Technology™ uses advanced physics, engineering, and manufacturing techniques to produce conversion from heat to electricity on a scale and at a cost that challenges conventional power generation. See www.powerchips.gi.

A Stirling engine is a heat engine operating by cyclic compression and expansion of air or other gas, the working fluid, at different temperature levels such that there is a net conversion of heat energy to mechanical work. Paired with a MulTask-Dome, a Stirling engine utilizes super-heated liquid to efficiently power an electric generator.

The inventor of the MulTask-Dome is Abby Charden Mobasher.

High Expansion Magnetohydrodynamic Liquid Metal Generator

The “High Expansion Magnetohydrodynamic Liquid Metal Generator of Electricity” (U.S. Patent No. 5,637,934 Gracio Fabris) has a thermal-to-electricity conversion efficiency that exceeds 70%. See patent at <http://www.google.com/patents?id=tOUhAAAEBAJ&printsec=abstract&zoom=4#v=onepage&q&f=false>. The patent’s Abstract is copied as follows:

Two-phase LMMHD energy conversion systems have potentially significant advantages over conventional systems such as higher thermal efficiency and substantial simplicity with lower capital and maintenance costs. Maintenance of low velocity slip is of importance for achieving high generator efficiency. A bubbly flow pattern ensures very low velocity slip. The full governing equations have been written out, and a computer prediction code has been developed to analyze performance of a two-phase flow LMMHD generator and nozzle under conditions of no slip. Three different shapes of an LMMHD generator have been investigated. Electrical power outputs are in the 20 kW range. Generator efficiency exceeds 71 percent at an average void fraction of about 70 percent. This is an appreciable performance for a short generator without insulating vanes for minimizing electrical losses in the end regions.

Power Chip Thermo-Ionic Generator

The Power Chip™ thermo-ionic generator is a new technology that uses the physical mechanism of thermionics and quantum thermotunnelling to generate electrical power directly from heat, with no moving parts, and with a higher projected efficiency than any current technology.

Power Chips should revolutionize electrical power generation across virtually all applications. In present large generating stations, adding Power Chips to capture heat that is now wasted will enable power plants to produce at least 20% more power with no increase in fuel consumption or emissions. Eventually, more efficient power plants, using only Power Chips to produce power, will become common.

In automobiles and other vehicles, Power Chips initially are likely to replace the alternator, using waste heat from the radiator and exhaust and greatly increasing the efficiency of the internal combustion engine. Within a few years, electrically-driven vehicles will become possible, with power generated by Power Chips – burning gasoline, natural gas, or hydrogen as fuel to produce heat – and driving a super-efficient Chorus® Motor. Such an automobile would achieve dramatic improvements in fuel efficiency, and produce a fraction of the emissions.

Power Chips will make possible safe, efficient distributed power, enabling buildings or factories to generate their own electricity. They will make it possible to bring plentiful electric power to regions of the world whose peoples and economies now suffer from inadequate electric power, at a fraction of the cost to do so using current generating technologies. The inventor is Jonathan Edelson. For details, see <http://www.powerchips.gi/>.

Advanced Solar Photo-Voltaic Crystal Lattice Cells

In 1989, during another flight of the Space Shuttle Atlantis, the U.S. military photographed a newly launched Soviet communications satellite in geo-synchronous orbit above Moscow. There were several things about the new Soviet satellite which were unusual. First, spectroscopic investigation of the signature of the satellite revealed the familiar tell-tale presence of nuclear material located in the aft section of the satellite. It was presumed (incorrectly, it later turned out) that this signature confirmed that the satellite was, indeed, powered by a small on-board thermo-nuclear reactor.

What did not make sense, though, was the fact that the power requirements, which American military analysts believed were needed to support the variety of functions being performed by the Soviet satellite, were believed to consume considerably more power than could possibly be produced by a nuclear reactor of the kind and size believed to be installed and operating on the satellite.

Further, the photographs revealed the presence of a peculiar kind of parabolic dish suspended from the nose of the satellite. It was shaped like the much larger satellite receiving dishes commonly used by television viewers in the West. The peculiar thing about this dish was that it was very small, less than three feet in diameter, and had a very flat parabolic surface. This meant that it did not focus the signals they presumed it received onto any boom-mounted collector or decoder device. No such device was mounted on or attached to the dish.

Finally, it appeared to be constructed of a material or combination of materials which was unknown at the time, but which appeared to be highly reflective, almost like a mirror. Interestingly enough, the dish was also apparently transparent to interstellar signals which originated behind it. For years it was believed that the strange parabolic device was a special kind of high-gain directional antenna. That assumption later proved to be totally false.

In fact, information recently supplied by the I.N. Frantsevich Institute for Problems of Materials Science (IPMS), Kiev, Ukraine, to support several of its patent applications confirms that the dish was constructed of the same crystalline lattice material which is used to construct the interior of exceptional energy storage devices, but built with some very special features. The purpose of the device was to convert sunlight and other ambient wavelengths of energy into ion flow or electrical current, in sufficient amounts to maintain the electronic and other operational functions of the satellite. In the West we refer to devices which act this way as photo-voltaic devices or solar cells. The device which looked like a high-gain antenna dish was certainly a solar cell, but it was much more than that.

The quantum physics and the new technologies which made it possible to produce the crystalline lattice structure of the energy storage devices also made it possible to produce a similar crystalline structure which was capable of simultaneously converting wavelengths of widely varying characteristics into ionic flow or electrical current. The strategy employed by this revolutionary new material worked across almost the entire spectrum of known wave lengths, from far out in the realm of extra-low frequency long wave lengths propagated by the original Big Bang all the way up through the visible light spectrum and beyond, into X-rays and ultra-high frequency, ultra-short wavelength wave forms associated with pulsars, quasars and quantum singularities.

The quantum mechanics which describe the characteristics of the crystalline lattice structure recognize two distinct features of wave/particle propagation which are nowhere integrated in the linear quantum mechanics or solar cell technologies of the West. First, the characteristic of crystals which differentiates them from all other known material substances is that they resonate (or oscillate, to be more precise) at both primary and harmonic frequencies.

A crystal-based tuning fork which resonates at “A” natural will also resonate in sympathy with any harmonic of “A” natural propagated across the entire wave spectrum if the wave form is detectable and of sufficient intensity to activate the crystalline structure of the tuning fork.

The crystalline lattice of the Soviet solar cell was deliberately designed and constructed to resonate at all the harmonic frequencies of the entire wave length spectrum, as defined by six discrete bands which embrace all known wavelengths. These bands are each a harmonic of the next, and all of them cause excitation (oscillation) of the crystalline lattice structure at the same time.

This phenomenon reflects a new feature of quantum mechanics, instantaneous simultaneity of crystalline oscillation regardless of the distance of separation. The potential of this phenomenon in future applications is truly awesome. Properly harnessed, for example, this property of crystal structures as defined by the IPMS version of quantum mechanics could make it possible to communicate over vast distances with no time lag. The oscillation characteristics demonstrated by these structures operate outside the normal context of space-time.

The Author happens to be the inventor of a major advance in torsion field communications, made possible by these special crystalline lattice structures. The maximum theoretical capacity of torsion field communications apparently is 40 billion channels of three-dimensional holographic television through the entire earth without attenuation at one billion times the speed of light. See www.padrak.com/vesperman – “Torsion Field Physics and Torsion Field Communications”.

It has long been recognized in the West that oscillating crystal structures can be engineered to create a usable flow of ions in the form of low-voltage direct electrical current. However, instead of relying exclusively on light in the visible spectrum alone to create ion flow, the Soviet system operates on all known ambient wave lengths simultaneously, in six harmonic resonant bands. It creates ion flow wherever and whenever such wave forms are present. It means that these devices operate on ambient heat remaining in a room or in the dead of night when there is no visible light present at all.

One more feature distinguishes the Soviet material from the Western photo-voltaic or solar cell. The Western cell operates by trapping photons of light in a cleverly designed network of glass, mirrors and other inter-connected reflective materials which are deposited on a substrate of a dielectric material. When the volume of “photon” traffic striking the dielectric material reaches a minimal threshold, electrical current is created.

That is, when enough photons have been captured to excite the surface of the substrate by either directly impacting molecules on the substrate surface or by creating heat energy sufficient to cause those molecules to oscillate, ion flow is induced. It is not a particularly efficient method, but it is the best that has been devised in the West.

In the Soviet material, because photons are known to behave in precisely the same manner as electrons, the photons (which are present in all wave forms, including visible light) are simply introduced to the energy wells between the tips of the molecular pyramids on the sheets of crystal lattice which overlay each other. The material is so efficiently designed that it actually absorbs (here is another place where imprecise common language gets us into technical difficulty) the individual photons in the same way it accommodates electrons.

During the discharge cycle, when a circuit is open and available, the photons simply follow the path of least resistance, which is out through the crystalline lattice and into an electrical circuit, energy storage device, or some other similar application.

The Soviet solar panel operates at a nominal efficiency of no less than 51% in the least consistent pieces which have been tested in the United States. The best pieces have produced test results demonstrating operating efficiencies in excess of 80%. These devices/materials produce electrical current at a higher rate per unit of exposed surface area in the dark of night than the best solar panel ever produced in the West will generate in the most ideal sunlight conditions.

The simple circular device attached to the Soviet satellite was a single solar cell which was used to power the entire ship and all its functions. The nuclear fuel signature detected by the Atlantis crew was nothing more than the emissions produced by a piece of spent nuclear fuel placed on board the satellite, intended to mislead the American surveillance team. It worked.

Advanced solar photo-voltaic cells produced by Em-Tech Technologies of Toronto, Canada, have demonstrated actual hands-on efficiencies in laboratory applications of more than 50%. These cells are based on designs developed by the IPMS. Theoretical models have yielded energy production efficiencies of more than 80%.

These cells operate on such wide band-widths and at such high efficiency rates that their performance characteristics in the dark of night exceed those demonstrated in broad daylight by the best current, state-of-the-art solar cells produced anywhere else in the world.

When applied to current global electric energy requirements for domestic, commercial, industrial and military use, the cost of electricity could be reduced to less than \$.002 per kilowatt hour, with the added capability of operating not only in daylight but at reduced loads throughout the night, regardless of weather, on virtually any scale.

For comparison, the very best solar cells ever produced in the West have been produced by the Japanese. These cells operate at a maximum of 19% efficiency. That is, they convert as much as 19% of the ambient visible sunlight shining on a clear, cloudless day into ion flow, which then becomes low-voltage direct electrical current flowing through a circuit. The Japanese panels require months per section to manufacture and literally cost more than their weight in gold to manufacture. They are very heavy and are so sensitive to vibration and calibration that once installed, they cannot be moved at all.

(Source: David G. Yurth, *The Anthropos Files: Tales of Quantum Physics from Another World – 2nd Edition*, 2007)

Closed-Loop Phase-Change Gas System

The proof-of-concept prototype was designed to produce 25 KW continuous output based on Langmuir reactor core thermal source, rotary compression engine, (proprietary) input apparatus without extrinsic fuel consumption. Inventor is David Yurth.

Self-Recharging Capacitive Discharge Thermal Generator

Optimized ceramet devices are integrated with other highly capacitive elements in the presence of D₂O to produce self-recharging high-density charge cluster emissions as a means to thermally charge high-density anodic targets. The heat is used to support several types of thermal exchange-based apparatus.

The physics is based on the model of fine scale interactions described in the Y-bias and angularity model. See David G. Yurth's summary "Y-Bias and Angularity: The Dynamics of Self-Organizing Criticality from the Zero Point to Infinity" in www.padrak.com/vesperman. Inventor is David Yurth.

Ceramic Electrodynamic Wafer

An alpha-emitter isotope is combined with a proprietary thin film to produce a homogeneous crystalline material on an inert substrate. When subjected to a continuous magnetic field flux, the ions emitted by the isotopic material can be collected and rectified to perform work functions. Its output is 2.25 volts DC @ 10 - 20 micro-amperes/cm². This concept has already been in testing and demonstration for five years. Optimization of this technique is the objective of this project.

The physics of this device is based on the model of fine scale interactions described in the Y-bias and angularity model. See David G. Yurth's summary "Y-Bias and Angularity: The Dynamics of Self-Organizing Criticality from the Zero Point to Infinity" in www.padrak.com/vesperman. Inventor is David Yurth.

Organic Quinone-Based Redox Flow Battery

Researchers Develop a Cheap Battery to Power Your House – and It's Organic

By Kristine Wong, www.takepart.com June 27, 2014

Here's a dirty little secret about the batteries we increasingly rely on to power our emissions-free cars and store clean, green energy from the sun and wind: They contain metals that must be mined and can contaminate groundwater if they end up in landfills.

But an eco-friendly alternative could be coming soon. Researchers at the University of Southern California have developed a first-of-its-kind battery that replaces metal catalysts with quinine – an organic molecule that stores and transfers energy and can be found in fungi, bacteria, and even our bodies. The scientists predict such a battery will be 10 times cheaper to make and will last five times longer than a lithium-ion battery.

A race is under way to develop battery technology to store electricity from wind farms and solar power plants, the growth of which has been exponential in recent years. Since renewable energy production (see <http://www.takepart.com/article/2014/05/18/solar-roadways>) is intermittent – electricity is generated only when

the wind blows and the sun shines – batteries are needed to store that energy and dispatch it to keep the power grid balanced.

The problem: Existing battery technology is expensive.

“Using organic materials can let you build a very durable system to be scaled up at cost,” said Sri Narayan, a chemistry professor at USC who developed the battery with colleague G.K. Surya Prakash. They recently published their research in the Journal of the Electrochemical Society – <http://jes.ecsdl.org/content/161/9/A1371.full>.

Here’s how their technology – a variant of the vanadium redox flow battery (see <http://www.theatlantic.com/technology/archive/2014/04/the-forever-battery/361167/>) – works. First, two types of quinone molecules are modified to make them water soluble; then they’re dissolved in separate tanks of water. The solutions are pumped through a power cell containing a membrane. That triggers a chemical reaction that generates electricity. Reverse the process, and the battery can store electricity. Their organic battery can be recharged 5,000 times, the researchers say, while a standard lithium ion battery can only be recharged 1,000 times. That gives their battery an estimated lifetime of 15 years.

Just don’t expect an organic battery to power your car or iPhone. Flow batteries’ bulk makes them suitable for use only at power plants, though smaller versions could store electricity from your home rooftop solar array. One of the big challenges of developing an organic battery was getting a high concentration of quinone molecules to stay soluble in water. “Mixing the two can be like an oil-water mixture,” Prakash said. “There was a lot of thinking and redesigning of molecules.”

The researchers are working on building a commercial prototype of their laboratory-scale model that could generate electricity at half the cost of current systems.

“It’s important to have clean energy storage coupled with clean generation,” Narayan said. That way, “you’re not making clean energy and then putting it into a dirty battery.”

Source: <http://news.yahoo.com/researchers-develop-cheap-battery-power-house-organic-195737917.html>

Solid Oxide Fuel Cell

Fuel cells were invented over a century ago and have been used in practically every NASA mission since the 1960's, but until now, they have not gained widespread adoption because of their inherently high costs.

Legacy fuel cell technologies like proton exchange membranes, phosphoric acid fuel cells, and molten carbonate fuel cells, have all required expensive precious metals, corrosive acids, or hard-to-contain molten materials. Combined with performance that has been only marginally better than alternatives, they have not been able to deliver a strong enough economic value proposition to overcome the status quo.

Some makers of legacy fuel cell technologies have tried to overcome these limitations by offering combined heat and power (CHP) schemes to take advantage of their wasted heat. While CHP does improve the economic value proposition, it only really does so in environments with exactly the right ratios of heat and power requirements on a 24/7/365 basis. Everywhere else the cost, complexity, and customization of CHP tends to outweigh the benefits.

For decades, experts have agreed that solid oxide fuel cells (SOFCs) hold the greatest potential of any fuel cell technology. With low-cost ceramic materials, and extremely high electrical efficiencies, SOFCs can deliver attractive economics without relying on CHP. But until now, there were significant technical challenges inhibiting the commercialization of this promising new technology. SOFCs operate at extremely high temperature (typically above 800°C). This high temperature gives extremely high electrical efficiencies and fuel flexibility – both of which contribute to better economics. But it also creates engineering challenges.

Bloom Energy (www.bloomenergy.com) has solved these engineering challenges. With breakthroughs in materials science, and revolutionary new design, Bloom's SOFC technology is a cost effective, all-electric solution. Derived from a common sand-like powder, and leveraging breakthrough advances in materials science, their technology is able to produce clean, reliable, affordable electricity on-site, where it is consumed, from a wide range of renewable or traditional fuels.

Built with patented solid oxide fuel cell technology, Bloom's Energy Server™ is a fuel cell that converts fuel into electricity through a clean electro-chemical process rather than dirty combustion. It is like a battery except that it is always run. Their particular type of fuel cell technology is different than legacy "hydrogen" fuel cells in three main ways:

- Low-cost materials – their cells use a common sand-like powder instead of precious metals like platinum or corrosive materials like acids.
- High electrical efficiency – fuel can be converted into electricity at nearly twice the rate of some legacy technologies.
- Fuel flexibility – their systems are capable of using either renewable or fossil fuels

Each Bloom Energy Server™ provides 200 kilowatts of power, enough to meet the base load needs of 160 average homes or an office building – day and night, in roughly the footprint of a standard parking space. For more power simply add more energy servers.

Each Energy Server™ comprises of thousands of Bloom's fuel cells. Each cell is a flat solid ceramic square made from a common sand-like "powder." Each fuel cell is capable of producing about 25 watts – enough to power a small light bulb. For more power, the cells are sandwiched along with metal interconnect plates into a fuel cell "stack". A few stacks, together about the size of a loaf of bread, is enough to power an average home.

In an Energy Server™, multiple stacks are aggregated together into a "power module", and then multiple power modules, along with a common fuel input and electrical output are assembled as a complete system. For more power, multiple Energy Server™ systems can be deployed side by side. This modular architecture offers easy and fast deployment, inherent redundancy for fault tolerance, and high availability, i.e., one power module can be serviced while all others continue to operate.

A solid oxide fuel cell is like a battery that always runs. It consists of three parts: an electrolyte, an anode, and a cathode. For a solid oxide fuel cell, the electrolyte is a solid ceramic material. The anode and cathode are made from special inks that coat the electrolyte. Unlike other types of fuel cells, no precious metals, corrosive acids, or molten materials are required.

Next, an electrochemical reaction converts fuel and air into electricity without combustion. A solid oxide fuel cell is a high-temperature fuel cell. At high temperature, warmed air enters the cathode side of the fuel cell and steam mixes with fuel to produce reformed fuel – which enters on the anode side.

Next, the chemical reaction begins in the fuel cell. As the reformed fuel crosses the anode, it attracts oxygen ions from the cathode. The oxygen ions combine with the reformed fuel to produce electricity, water, and small amounts of carbon dioxide. The water gets recycled to produce the steam needed to reform the fuel. The process also generates the heat required by the fuel cell. As long as there's fuel, air, and heat, the process continues to produce clean, reliable, affordable energy.

Method and Apparatus for Splitting Water Molecules

Andrija Puharich (see <http://www.andrijapuharich.org/>) was granted U.S. Patent No. 4,394,230 for a "Method and Apparatus for Splitting Water Molecules". This method would reportedly split water molecules into hydrogen and oxygen with a net energy gain, and is essentially a perpetual energy device that many believe violates the first law of thermodynamics. Other methods of splitting water into hydrogen and oxygen with net energy gain have been invented by Professor Kanarev, Ken Rasmussen and his associates, Bob Boyce, Stanley A. Meyer, and Frank Roberts.

Motionless Electromagnetic Generator

In March 2002, Stephen L. Patrick, Thomas E. Bearden, James C. Hayes, Kenneth D. Moore, and James L. Kenny received U.S. Patent No. 6,362,718 for Motionless Electromagnetic Generator (MEG), a scalar energy device that they claim produces over-unity (AKA "Free Energy"). In conventional terms, the device has a Coefficient of Performance (COP) of 5.0.

Tom Bearden offers this brief description of how the Motionless Electromagnetic Generator works:

First the MEG uses a proven technique (the Aharonov-Bohm effect) which the nanocrystalline core furnishes freely. Recall again that memory characteristics of materials is one thing (from Prigogine) that allows direct and intentional violation of the second law of thermodynamics.

This free initiation of the Aharonov-Bohm effect in turn engineers the surrounding vacuum outside the core, by adding extra energy density to it in the form of a curl-free A-potential. Sharp perturbation (the rise time and decay time) of the input pulses that perturb the core-confined B-field, also perturb that section of the A-potential still in the core, so that a disturbance of dA/dt passes outside the core and on outward into the external altered vacuum with its extra energy.

There the equation $dA/dt = -E$ applies, and so in the external activated space real E-field energy pulses are formed which radiate back into the MEG core area due to the minus sign. This means they travel in opposite direction to the outward-traveling perturbation dA/dt .

Hence this shows the receipt by the MEG of excess electromagnetic energy freely transmitted back into it from the external altered space, which means that the MEG gets considerable excess E-field energy input from the surrounding vacuum. By adjusting perturbation rise times, etc., one can adjust the magnitude of the E-field energy pulses returned to the MEG from the external vacuum environment. Thus the MEG is an asymmetric Maxwellian system of the kind arbitrarily discarded by Lorentz in 1892, and still arbitrarily discarded by present EE departments, professors, and textbooks.

Comprised of strong magnets, coils, nanocrystalline cores, and a controller unit with the electronics, the MEG would be able to power an electric vehicle without battery recharging by the power grid.

For a detailed explanation (including clear drawings) of how the MEG works, see Dr. Bearden's paper "Engineering the Active Vacuum: On the Asymmetrical Aharonov-Bohm Effect and Magnetic Vector Potential A vs. Magnetic Field B,". This paper is available at the link <http://www.cheniere.org/techpapers/On%20the%20Aharonov-Bohm%20Effect1.doc>.

In that paper, Dr. Bearden points out that electrical engineers – and even the usual physicist – are unaware of how an electrical circuit is actually "powered". For an explanation and a diagram showing (1) where the energy pouring from the generator terminals actually comes from and how, and (2) why the normal electromagnetic systems self-enforce $COP < 1.0$ by killing their own source of this free energy flow faster than they power their loads, see Figure 2, Operation of a Symmetrical Electrical Power System, in the foregoing paper.

Note that there are more than 20,000 papers in the hard literature on the Aharonov-Bohm effect used by the MEG, and that Aharonov-Bohm effect is quite well proven in physics, both theoretically and experimentally. But the effect does not even exist in the electrical engineering model! Since the MEG is deliberately designed to use that effect, the operation of the MEG can only be understood by one who understands the Aharonov-Bohm effect, its generalization to the Berry phase, and the further generalization to the geometric phase. Specifically, any electrical engineer – using only mainstream electrical engineering theory – can not and will not be able to understand the MEG's operation.

There are several sources of the special nanocrystalline cores which contain the "B" field needed to effectively operate the MEG. Dr. Bearden reports in <http://www.cheniere.org/correspondence/020504.htm> that the nanocrystalline cores originally were purchased as Metglas amorphous alloys from the former Division of Honeywell that made them. He believes that Honeywell actually got them from India. That Division of Honeywell was just about demolished by General Electric (GE) in its sudden attempted buyout of Honeywell (vetoed by the European community). GE suddenly moved it across country, wiping out half its staff and scientists, etc. Then GE withdrew. With the Division in shambles, Honeywell then sold it off to Hitachi. He doesn't know what's happened since then

In a March 1, 2012 email to Gary Vesperman, David Yurth wrote:

The definitive test for the MEG is posted on the site hosted by Jean-Louis Naudin in France (<http://jnaudin.free.fr/meg/megv21.htm>). The data, test protocols, and technical information are clearly presented. The MEG operated for short periods of time then went dormant under load.

I have proposed some fundamental improvements for the system such as the use of Vitroperm in the electromagnetic core, Litz wire for the electromagnetic induction windings, and application of sub-nanosecond laser switching. This would eliminate hysteresis, eliminate inductive losses, and enable the circuit to perform work across the charge barrier without requiring the actual displacement of electrons from one address to another.

With these modifications the MEG might actually be able to perform work without relying on its capacitive discharge cycle which is too lossy to be self-sustaining

(End of email)

(Sources: http://peswiki.com/index.php/Site:LRP:Motionless_Electromagnetic_Generator, and http://peswiki.com/index.php/Site:LRP:The_Suppression_of_the_M.E.G._by_General_Electric. For additional information, order Dr. Bearden's books and videos from www.cheneire.org.)

Dynaflux Alternator

The modern world operates almost exclusively on the power of electricity in one way or another, and electricity is commercially produced by electromagnetic machinery called generators. In essence, a generator is nothing more than a series of coils arranged to rotate through a magnetic field. The cutting action provided by the magnetic flux as it passes through the conductors which comprise the windings induces a voltage within the coils. This potential provides the impetus for a current to flow when a closed path is provided. However, herein lies an interesting problem.

The student of physics will be well acquainted with a law known as 'Lenz law', which dictates that "a current carrying conductor undergoing motion within a magnetic field will experience a force which tends to oppose the motion which produced the current itself". Accordingly, every generator on earth attempts to run as a motor in a direction which provides resistance to the prime mover.

This interesting phenomenon has become the very basis which now relates electrostatics to the subject of thermodynamics, and which firmly cements the belief that power must always be conserved during an energy conversion process. However, a great deal of information exists which contradicts this cherished belief.

In October of 1988, Murray was granted patent # 4,780,632 for an "Alternator Having Improved Efficiency". The device was called a DynaFlux machine, because of the unique manner in which the magnetic flux was forced to undergo motion due to the machine's unusual armature design. Effectively, magnetic flux is forced to move along a path parallel to the axis of rotation, rather than perpendicular to it. As a result of this innovation, the Lenz reaction develops an opposing force that tends to apply an axial thrust to the rotor, rather than an opposing torque.

The Dynaflux Alternator is a non-linear, electromechanical energy conversion device which has been designed to demonstrate bi-directional power coupling between prime mover and generator. Consequently, in response to these design features, energy must oscillate between the angular mass of the machine, and the magnetic fields in the power windings. Under these conditions, only the true losses are paid for by the prime mover. The Dynaflux Alternator has consistently demonstrated conversion efficiencies far greater than 100%. The mathematics which describe this effect are extremely complex and all the differential equations have not yet been solved.

The net result is that the Dynaflux Alternator has the ability to provide conversion efficiencies unheard of in electrical engineering. However, despite its incredible potential, this discovery has met with nothing but closed mindedness, rejection and resistance; proof positive that mankind enjoys wallowing in the misery it creates for itself. It is not difficult to understand why Tesla kept so much knowledge to himself. Perhaps our planet is not yet ready to receive a cheap, inexhaustible supply of electrical power. It would be interesting to hear other points of view.

Source: <http://www.jimmurray.biz/research04.htm>

Cosmic Induction Generator

Eric Dollard is an electrical engineer who is a 'living legend' in the field of electrical research. He is considered by many to be the most knowledgeable expert alive today on the true nature of electricity. Author of the landmark mathematical papers "Symbolic Representation of Alternating Electric Waves" and "Symbolic Representation of the Generalized Electric Wave", Eric shows how all electric phenomena can be mathematically measured and engineered WITHOUT using calculus or 'Maxwell's Equations'. Author of Condensed Intro to Tesla Transformers and Theory of Wireless Power, he is also the only person since Tesla's death to successfully build a real magnifying transmitter. Eric Dollard's latest presentation is called "Four Quadrant Representation of Electricity".

Gary Vesperman's websites www.padrak.com/vesperman and www.commutefaster.com/vesperman.html link to a truncated reproduction of Eric Dollard's "Representations of Electric Induction" that was originally published in pages 2-25 through 2-82 of the "Proceedings of the 1986 International Tesla Society Symposium". Only pages 2-25 through 2-63 are included in this copy of his article. It was truncated both to reduce the size of the file and because the highly mathematical remainder of his article may be of interest only to a limited readership. Dollard explains much of the theory of electromagnetism. He also presents the physics of Nikola Tesla's wireless power transmission system.

Dollard and his partner John Polakowski have been building a 'Cosmic Induction Generator' (CIG) which was designed by Eric Dollard and is the first successful replication of this technology since the early Borderland days. The CIG is apparently a fundamentally new important technology with many potential applications. One of the first goals of experiments with the CIG once it is in operation is to demonstrate the manifestation of visible evidence of the intrinsic formative forces of the universe, which is done in the spirit of Tesla technology. With scaled up power supplies and resonator coils, it is possible to create an audio speaker made out of an electrical flame with extremely high fidelity across all frequencies.

The CIG was so named by Dollard because the CIG produces intense lines of dielectric induction that cause a plasma to form which takes on the shape and form of a galaxy in space (the cosmic aspect). The aspect that is extraordinary is the plasma doesn't take on random shapes or motions – it forms a mini-universe! Witnesses to the original experiment described the plasma as being 'alive', 'conscious', and having a 'memory'.

The goal of the CIG is to emphasize the living aspect of electricity, as part of the Formative Forces described by Goethe. Read: Cosmic SuperImposition, Wilhelm Reich. This display of the galaxy was termed the 'galaxy in a bulb', because the plasma formed in a burned out incandescent bulb. Unfortunately, the 'galaxy in a bulb' was never caught on film, but some other pictures were taken that display interesting effects.

Dollard and Polakowski have acquired two large amplitude modulated (AM) 5000-watt transmitters. They're quite a bit bigger than the bench top Navy transmitter they are currently using for their current experiments. When they have 3-phase power hooked up, that will be 10,000 watts worth of power they will be able to use to power a much larger cosmic induction generator. The new model CIG will be on a scale that Tesla himself would have built in order to demonstrate these principles. When the larger CIG is in operation, Dollard and Polakowski will be able to demonstrate both the formative forces on a very large scale and de-synthesizing energy right from and into counterspace.

The electrical flames that are emitted from the capacitor rings around the coil are expected to be capable of playing very high fidelity audio. Some people play music on their Tesla coils, but that is limited to a small frequency range. The CIG used as an electrical flame plasma speaker is something completely different and not many people have ever witnessed this very rare aspect of this technology.

The Cosmic Induction Generator can be simplified to a few distinct components:

- The transmitter/amplifier section
- The Tesla coils
- The driver to the amplifier
- Supporting power supplies

The CIG basically consists of an AM amplifier/transmitter which drives two sets of Tesla coils pointed opposite each other. The transmitter consists of vacuum tubes providing the signal amplification. Solid-state components are used very minimally. The Tesla coils are in a unique configuration – two Tesla Transformers aimed at each other creating an extremely intense dielectric field in the middle of the two units – creating a dead space. Also where a normal Tesla coil would be grounded to the earth in order to transmit, these coils will be referenced only to each other.

Between the two coils is where the magic happens. For the CIG, the objective is to put a bulb containing a gas conducive to plasma creation – in the middle of the intense dielectric field and see the ‘galaxy in a bulb’. It is reported by Eric and other witnesses that inside the bulb the plasma takes on a life of its own, the ionized gas has a memory, displays intelligence, and creates forms similar to a galaxy in space. The primary objective of this project is to recreate that display. The nice thing about the CIG though is that it is multipurpose. It can also be used to create ‘singing’ arc discharges when modulated with an audio source. Also, all the coils (primaries, secondaries, extras) are being built on independent frames and stands, so they can be used in a different configuration than just pointing at each other. If spread apart and grounded they can be used to transmit and receive to each other.

Sources:

- <https://www.indiegogo.com/projects/cosmic-induction-generator>
- <http://johnpolakowskiscience.com/blog/what-is-the-cosmic-induction-generator/>
- <http://energyscienceconference.com/category/speakers/johnpolakowski/>
- <https://plus.google.com/+EricDollard/posts/ZAzpQMB3VgF>
- <http://www.energyscienceforum.com/showthread.php?t=1773>

Radiant Energy Pump/Electricity Generator

Thomas Henry Moray, Ph.D., (August 28, 1892 - May, 1974) was an inventor from Salt Lake City, Utah. Moray graduated from The Latter Day Saint's Business College. Moray studied electrical engineering through an international correspondence school course. He received a Ph.D. in electrical engineering from the University of Uppsala.

T. Henry Moray's research dates from the time he was 9 years old (1901). Over the 73 years of Moray's research, he left behind him a wealth of notes, not only pertaining to radiant energy, but a wide range of scientific research bordering all the way from the devulcanization of rubber, the influence of mineral reactions in the presence of high energy, bio-electronic effects (electrotherapy), sound pick up, solid-state physics, and finally the detection of energy that constituted the major endeavor of his work.

Moray was a pioneer in the field of electrical energy. As a youth he greatly admired Nikola Tesla and in particular was very interested in Tesla's obsession with the earth having a limitless supply of energy available to it from the universe. Like Tesla, Moray wanted to find out how to tap this energy. Like a lot of people he became amazed at the ‘crystal radio’ where a crystal can be tapped with a fine wire to make a radio work –

without any battery or power. Moray figured that if this was possible it should be possible to find a crystal (or "magnetic rock") that could be tapped for a power source.

Moray became very interested in the properties of certain rocks and crystal structures and the powders from them. He actually developed and utilized a transistor more than 20 years before anyone ever dreamed of such things. These solid materials are what he made his so-called Moray valves out of; they were like radio valves *but were not using a heated coil* like radio valves (also known as vacuum tubes in today's terminology). They were all cold with no external power to feed them. They were a mixture of semi-conducting materials and intricate one-way conducting materials (diodes in today's terminology). The Moray valve was therefore a solid-state device – unlike a radio valve that heated a plate to produce energy.

It is well documented that Moray developed a bipolar semiconductor as early as 1927. His germanium "valve" was working in 1931. In the 1930s Moray developed advanced semiconductors and transistor-like devices. Moray provided a complete disclosure of his semi-conductor research to Dr. Harvey Fletcher of the Bell Laboratories. Dr. Fletcher later became head of the department at Bell Laboratories that developed the transistor. Moray, therefore, could be the true father of modern electronics since his work predated the Bell Laboratory bipolar transistor findings by at least 20 years.

During the 1930's T. Henry Moray was refused a patent on his cold semiconductor cathode because the patent examiner couldn't understand how it could emit electrons. The patent examiner reported that he could not allow the patent because he could not see how it would work since "the cathode had no means of being heated".

"He tried to patent his device, but the requests were denied because the item he called the 'Moray valve' was too new a thought for the patent examiner. It was actually a germanium transistor, and solid states were unknown at the time." his son John Moray said. 20 years later the development of the transistor apparently proved that his device could actually have worked.

Both Nikola Tesla and Thomas Henry Moray consider harnessing cosmic energy (vacuum or zero point energy in today's terminology) as the most practical method of producing energy yet discovered by man. Furthermore, they thought it is possible to utilize this vast source of energy from the universe without a prime mover at any point on the earth or in space – on the ground, in the air, on the water, under the water, or even underground.

Radiant energy is energy that is transported by waves. This includes energy transmission in the form of waves through space or various media. Radiant energy is also energy transferred through electromagnetic waves. Solar energy is a type of radiant energy. Radiant energy is the sum total of all the energy that comes to the earth from all the universe. The earth also reflects back radiant energy into the universe. Our sun directs electrically charged particles towards us. Radiant energy may be calculated by integrating or summing radiant power with respect to time. Radiant energy is usually expressed in joules.

During the 1920s Moray demonstrated a "radiant energy device" to many people who were unable to find a hidden power supply or batteries. Moray called his device a solid-state detector or the "Moray valve". It basically comprised of a large antenna connected to a complex series of high-voltage capacitors, transformers, and semiconductors. By supposedly stimulating the existing oscillations of radiant energy from space, his device could generate electrical power without any man-made power input. By 1936, Moray had eventually engineered his device so that a 55-kilogram version could constantly produce 50 kilowatts of power for several days.

An electrical generator may be considered as not in the true sense a generator – as electricity is not made by the generator – but is merely an electrical pump. Moray's radiant energy device may then be referred to as a cosmic ray pump: that is, a high-speed electron oscillator serving as a detector of cosmic radiations which causes a

pumping action or surging within its circuitry. Moray used the term 'radiant energy' to describe that source of energy coming from the cosmos to earth and radiating from the earth back to where it came. This is the energy the Moray device captures and could be described as those particles of energy pervading all space.

What sort of an apparatus is Moray's radiant energy device? Briefly, it would appear to be similar to a radio receiving set of power proportions.

An antenna is connected to a 29-stage solid-state collector material; a small rounded pellet mixture of triboluminescent zinc, a semiconductor material, a radioactive or fissile material, and germanium. The device contains two coils of wire, or inductances. It also contains several condensers, or capacitors, of different sizes. There is a detector tube, or electronic valve, and two oscillator tubes. Added to this is a "bar of silver and a bar of copper", a starting device, and a step-down electrical transformer, reported to be 1000-to-1, primary to secondary.

After tuning of the device the semiconductor material acts as a one-way gate (diode in modern terminology) for surges of high-frequency background atomic ion energy which can go through the material more readily in one direction than the other. For conversion of ionic to electromagnetic energy to then be transformed into useful electrical power by conventional radio circuitry and a transformer, the device must be grounded.

All of this was enclosed in a box measuring about 30 inches long by 16 inches wide by 16 inches high. It weighed about 30 kilograms. There were no moving parts. Moray said there are no dangerous radiations surrounding the box when it is in operation.

Moray's 30-kilogram radiant energy device produced 4 kilowatts of cold electricity which was able to power light bulbs. However, electric motors require special winding to increase their efficiency. While commercially available electric motors will operate on the power from a radiant energy device, they are not as efficient as motors running on ordinary commercial currents. Moray says when his motors are running in the dark they glow with a violet aura. His motors ran cold!

It has been estimated that using current dielectric technology that a 50-kilogram radiant energy device could be built to produce 300 kilowatts – sufficient to power buildings and also electric vehicles.

Some persons who have seen radiant energy power lights say the bulbs look as if they were filled entirely with white light, as if the gas itself which fill the bulbs were fully incandescent. Moray believes this to be true.

Radiant energy will heat electric flat irons and other electrical heating devices. It is claimed heating capacities are reached much more quickly with radiant energy than with commercial currents, and are considerably hotter than when powered with ordinary electric energy.

One photograph shows Moray demonstrating his generator as it powers 50 100-watt light bulbs and a 655-watt Hotpoint iron. Thus he proved that his radiant energy device was not running off batteries – as his detractors said it did.

By 1936 he had developed a generating unit that weighed about 55 pounds and was capable of producing as much as 50 kilowatts of power on a steady basis.

On several hundred occasions Dr. Moray lighted a bank of 35 light bulbs with power from his simple but ingenious radiant energy device. There were 20 150-watt bulbs on the panel. At the same time the generator powered a 600-watt glow heater and a 575-watt flat iron.

Moray, as Nikola Tesla before him, was unsuccessful in introducing his devices working on this principle. Some report that his secret was forgotten. Moray tried for several patents to no avail.

These valves are ONE reason why patents were continually refused – as he was told "there is no such thing as free energy".

"You must put energy in to get it out." As patents were applied for, there were refusals due to the fact that the patent applied for "infringed other patents". Even though Moray patiently wrote details of how this could not be, the US Patent Office refused to allow any.

On the other hand, Moray gradually had perfected his device's output from a capacity to light one small incandescent light bulb to a present capacity claimed to be 50 kilowatts. Fifty kilowatts represents about 67 horsepower and, certainly, 67 horsepower is not to be disregarded. Many small factories do not use as much as 67 horsepower.

According to Moray, one of his radiant energy devices can be built for about \$800 (year is unknown as there has been considerable inflation). Mass production methods might cut this price in half. Under these circumstances, a unit in a home would bring about a substantial saving in power bills over several years time.

As many as 100 persons have witnessed radiant energy demonstrations. Radiant energy, as it emerges from the Moray apparatus, may be considered a form of electricity. It is an alternating current, but an alternating current of very high frequency.

If a photograph of a single bulb lighted with radiant energy is taken the print shows a large, dark ring, perpendicular to the base of the bulb. This ring looks like a circle of translucent black fog. It seems the light somehow reflects itself on the air, or projects a shadow of itself there.

In 1940 Moray demonstrated before the members of the Public Utilities Commission (in Utah?) his free energy generator. It maintained a continuous output of 250,000 volts with no apparent input.

Hendershot Magnetic Motor

During the late 1920's Lester J. Hendershot, while working on a new type of aviation compass, stumbled across a method of generating energy. Hendershot, while attempting to establish a true magnetic north compass, found that by cutting the same line of magnetic force north and south, he had an indicator of the true north and that by cutting the magnetic field east and west, he could develop a rotary motion. He wove together a number of flat coils of wire and placed stainless steel rings, sticks of carbon and permanent magnets in various positions as an experiment. Based on this principle, after two years of trial and error, he built a magnetic motor that would self-rotate, to his surprise, at a constant speed of 1800 rpm while producing 45 horsepower.

Hendershot changed directions and decided to build a generator on the same principle, after deducing that a magnetically-powered motor was not as practical as a magnetically-powered generator. Hendershot had discovered that the Earth's rotating magnetic field could be used to provide power to motors and generators, much like Nikola Tesla's discovery that the Earth was a huge capacitor, capable of providing significant amounts of electrical power. Simplified, Hendershot believed that if one were to cut the lines of force of the Earth's magnetic field, one could harness this to provide direct power to generators and motors. Nikola Tesla attempted to do just that, when he built his "magnifying transformer" at Shoreham, Long Island, NY.

To read the first hand accounts of Hendershot's historical encounters, see the following research links:

<http://www.time.com/time/magazine/article/0,9171,880984,00.html>
<https://secure.netsolhost.com/nuenergy.org/alt/RadonFuel.htm>
<http://www.clubusenet.com/thread/262719.html>
<http://www.borderlands.com/freeenergy.htm>
http://www-tech.mit.edu/archives/VOL_048/TECH_V048_S0041_P004.pdf
<http://www.clarabow.net/articles/ourreaderswrite.html>
<http://www.freepatentsonline.com/20070007844.html>
<http://www.rexresearch.com/feg/feg1.htm#hendershott>

In 1961 Dr. Ed Skilling, from Columbia University, successfully replicated and tested a Hendershot free energy device, out of which he got 300 watts. Skilling had been associated with Hendershot and learned of the device through him. The generator was self-resonant at 500 kHz.

N-1 Homopolar Generator

Bruce DePalma invented the homopolar electricity generator, also called the “N-Machine”, that could provide cheap, inexhaustible, self-sustaining and non-polluting energy. The N-Machine uses principles that flout conventional physics and are still not fully understood. A 100-kilowatt N-1 homopolar generator prototype sat in his garage. It could power his whole house.

Trombly-Kahn Closed-Path Homopolar Generator

During the early 1980’s Adam Trombly and Joseph Kahn, Ph.D., co-invented the Trombly-Khan closed-path homopolar generator which has an output power exceeding its power input by a factor of 4.92. The patent application and drawings represent the result of the expenditure of \$290,000 in two phases.

In 1989 Adam Trombly proposed the retrofitting of the Four Corners coal-fired power plant with an advanced Trombly-Khan closed path homopolar motor-generator. Trombly and David Farnsworth estimated that the cost of such an advanced electrical generator to be approximately the cost of installing smoke scrubbers on one coal-fired generating unit. (Sources: <http://www.rexresearch.com/trombly/trombly.htm> and <http://www.broandrew.com/suppression.html>.)

Trombly-Farnsworth Solid-State Oscillating Electromagnetic System

Adam Trombly also co-invented with David Farnsworth the Trombly-Farnsworth solid-state oscillating electromagnetic system. In June of 1989 Adam Trombly and David Farnsworth of Zero Point Technologies, Inc., demonstrated a solid-state resonant device which physically produced over fifty times greater electrical output than input at the Church of the Holy Covenant just prior to a major address by Trombly at Dag Hammarskjöld Auditorium in the United Nations. The demonstration had originally been scheduled to coincide with Trombly's address.

(References: June-December 2006 emails by Adam Trombly and Bruce Meland to Gary Vesperman. “In Search of Quantum Motors and Generators” by Bruce Meland, *Electrifying Times*, Spring-Summer 2006, Vol. 10, No. 1, www.electrifyingtimes.com. The book “*The Coming Energy Revolution*” by Jeane Manning. Tom Bearden’s web site www.cheniery.org/correspondence/080301.htm.)

Fossil-Fueled Generator Combo of Induction Coil Coating, Moe-Joe Orgone Energy Cell, and Fuel Mule

A stationary gasoline or diesel-fueled generator's efficiency could be almost doubled by the simultaneous installation of three inventions: The generator's efficiency could be increased by one-third by coating its induction coils with a proprietary material (see above). The installation of a Moe-Joe orgone energy cell could increase the generator's output of electricity per gallon of fuel by one-third (see below).

Installation of Scott Machuta's Fuel Mule may also increase the generator's output of electricity per gallon of fuel by 20 to 25% and perhaps as much as 30%.

Carlos Aliaga Uria lives in Cochabamba, Bolivia with his wife Anna Hosbein. See their company's website www.ahabolivia.com. They contract with native Bolivians to ethically manufacture exquisitely artistic handicrafts and wholesale them in Europe and the USA. Carlos has earned from the University of Wyoming in Laramie, Wyoming a bachelors degree in hydraulic and environmental engineering and then also a masters degree in the same field. During a trip to the USA Anna bought from Scott Machuta a Fuel Mule and brought it back to Bolivia. Carlos reported April 18, 2014:

Hello Scott,

Last Wednesday finally did the Fuel Mule test. As you know, to convince my very untrusting mechanic, in coordination with you, I modified how to set up the Fuel Mule.

Concretely you recommend to change spark plugs, oil, tune up, etc, before installing the Fuel Mule. But to please my incredulous yet very experienced mechanic what we did is to install the Fuel Mule without changing spark plugs, without changing oil, nor air and oil filters and not tune up either. And after installing the Fuel Mule like that I even drove my 1999 Ford Expedition with 4.6 liters V-8 engine for over two months, loading it to maximum capacity also as we were moving from our old office to our new one. And so like out of tune, with very dirty oil and air filters, with old spark plugs, is how last Wednesday I did the test efficiency.

Results: 30% minimal efficiency. Yes, a distance of 94 kms on a semihighway without the Fuel Mule took about 17.6 liters, and with the Fuel Mule it went down to 12.5 liters! (It then used only 9.0 liters in the same 94 kilometers after installation of a Fuel Mule, all new filters, oil change, and tune-up – July 16, 2014 email.)

And besides that, the engine sound so much more smoother with the Fuel Mule. The Fuel Mule has to be like an intelligent system that makes the car run better, and without a doubt more efficiently.

Congratulations Scott, and thank you very much for inventing it. Thank you also to Gary Vesperman for putting me in touch with you.

All right. I need like about a month to organize myself to see how we can start commercializing it in Bolivia (and eventually Holland and Switzerland).

The very best for you and I will be in touch soon,

Carlos

Sources: Emails from David Yurth and Scott Machuta. Gary Vesperman's experience with a Moe-Joe orgone energy cell on a 1993 Saturn.

High-Voltage Injection of Rain Water into Cold Fog

Many prototype systems exist today which efficiently convert potential energy into useful work. An example of such a system is the "Cold Fog" discovery of Dr. Peter Graneau of Northwestern University. Dr. Graneau's system converts chemical bond energy into kinetic energy by injecting rain water with a high voltage discharge of 39.8 joules. Normal rain water subjected to this treatment becomes a cold fog which loses approximately 31.2 joules of low-grade heat and a comparable amount (29.2 joules) in the form of kinetic fog energy output. As reported in the prestigious *Journal of Plasma Physics* the output energy exceeds the input energy by about 100%, creating a 2:1 over-unity condition. The energy output produced by this system can be captured and harnessed to drive a motorized conversion system.

Remediating Nuclear Waste with Electron-Captured Protons with Significant Net Energy Gain

This technology constitutes an enormously promising source of "free" energy. Using high-density charge cluster accelerators, it is now technologically feasible to produce 10-20 times as much energy by remediating radioactivity emissions from stockpiles of nuclear waste products as they originally produced. As a result of the patented work of Kenneth Shoulders, Shang-Xian Jin, Dr. Hal Puthoff, Prof. Illyanuch, Prof. Mesyats, and others, this new low-velocity method for remediating nuclear waste with electron-captured protons has been demonstrated in laboratory tests to generate substantially more energy [in the form of photons as light and electrons as heat] than is required to power the treatment apparatus itself.

The technique produces electron clusters with energy densities equivalent to 25,000 degrees Celsius upon impact with a target material, while consuming only 20 microjoules to produce the effect. The electron clusters travel at no more than 10% light speed and have been shown to penetrate any substance with a high degree of precision. Using a deuterium-loaded palladium foil, bombardment areas demonstrate transmutation into silicon, calcium, magnesium and lithium.

Plasma physicist Shang_Xian Jin's paper describes how the high-density electron clusters achieve impact results similar to those produced by high-velocity ion accelerators, including penetration of the nucleus, with 1000 times less power. The new physics of like-charges clustering in bundles under low power conditions opens a wide range of possible applications including micro-thrusters for space craft maneuvering. The over-unity conversion efficiency of these systems is currently estimated to be at least nine to one.

LUMELOID™ Light-Polarizing Photovoltaic Film

The light-polarizing photovoltaic film known as LUMELOID™ is a stretch-oriented polymer film about 0.3 microns thick which mimics photosynthesis. Light energy is absorbed in a molecular antenna which converts it to electron energy. The electron energy is then rectified by a molecular tunnel diode comprising an electron donor, an insulating space and an electron acceptor. Voltage and current is generated in the plane of the film parallel to the stretch axis.

Conventional silicon photocells are 25% efficient in theory, but in practice attain only 4-10%. The silicon concentrator cell theoretically has a 32% efficiency, but in practice has reached only 15%, and is too expensive.

LUMELOID™ has a theoretical efficiency of 72%. Initially its efficiency is expected to be comparable to existing photocells. However, because of the film's high theoretical efficiency, with further R & D,

LUMELOID™ is expected to soon surpass conventional photocell efficiency. More importantly, the low cost per watt of LUMELOID™ represents a tremendous cost decrease over presently available sources of solar energy and would facilitate its early acceptance in the energy market.

The projected cost of the basic LUMELOID™ thin film is \$1.00 per square meter, and the assembly which comprises a LUMELOID™ film on a substrate with microelectronics circuitry, is about \$5.00 per square meter. Its capital investment cost is about 30¢ per watt. This is a fraction of all conventional electric energy producing technologies. The capital cost of fossil fuel generation from large power plants is over \$1.50 per watt, nuclear energy is more than \$6.00 per watt, and present semiconductor photovoltaic devices are more than \$4.00 per watt.

LUMELOID™ will be available in rolls at low cost, affording easy transportation, and any amount of power during sunlight hours by just rolling it out flat on any surface. Eventually with the development of QUENSOR™, which is like a very thin battery (see below), a combined LUMELOID™/QUENSOR™ sheet may be spread out on a roof or on the ground, and will provide electric power day and night, available on demand.

"Diad" is an acronym for donor-insulator-acceptor-device which acts as a diode. Molecular diads have been chemically synthesized. LUMELOID™ incorporates diads in a stretch-oriented electrically conductive polarized film. The linear polarizing molecule in the film acts as antennae to absorb a resolved component of the energy of the light photons in the plane of the film. Diads are essential in LUMELOID™ to convert the energized electrons to unidirectional (DC) electric power.

When two polarized films are positioned with their stretch axes perpendicular, light is almost completely absorbed. Using two crossed films with electrodes connected in series or parallel, ordered diads in LUMELOID™ enable the conversion of light to electric power at 72% theoretical efficiency. This principle was demonstrated at the Jet Propulsion Laboratory by converting microwave to DC electric power using rectifying antennae at 82% efficiency. Inventor is Alvin Marks.

LEPCON™ Femto Diode Photovoltaic Glass Sheet

The LEPCON™ femto diode concept is similar in principle to LUMELOID™, which provides a technology mimicking photosynthesis, absorbing light energy with a molecular antennae structure, and rectifying the electron energy by the known phenomena called electron tunneling. In contrast to LUMELOID™, however, LEPCON™ comprises the durable materials of sub-micron metal on a glass substrate sheet. (A "femto" is one quadrillionth (10^{-15}).)

A device for fabricating LEPCON™ photovoltaic sheets in commercial production is called "Supersebter", an acronym for Super Submicron Electron Beamwriter. The Supersebter utilizes 100,000 rows and 100,000 columns to position 10 billion electron emitters on a square meter sheet by a lithographic process. This process produces 10 billion electron beams simultaneously to write the nanostructure patterns of femto diodes on the sheet. A square-meter LEPCON™ photovoltaic sheet could be produced in twenty seconds at a cost of about 50¢ per watt and a lifetime expectancy of over 50 years.

LEPCON™ panels could be utilized by utility companies in solar farms. It has been calculated that LEPCON™ panels covering a 150-kilometer x 150-kilometer area in a desert region could produce over 250,000 MW of electric power, enough for most of the United States.

This successful commercial fabrication of the LEPCON™ femto diode structure should lead to many other advanced nanostructure devices. For example, computer circuitry could be miniaturized 100-fold, efficient laser lighting devices could be produced, and vast improvements could be made on high-definition 2D to 3D TV flat-panel displays. (The 1993 Alvin Marks patent on a monomolecular resist significantly increases the resolution of the nanostructures.)

Three Environmental Heat Engines

Deceased Las Vegas inventor Robert Stewart developed his ‘Stewart Cycle’ engine for transportation vehicles, electricity generators, and large-scale water lifters. His efficient and pollution-free engine uses ambient heat to expand a working fluid such as Freon or ammonia and move pistons through sealed chambers. His US patent is for “Vapor Actuated Power Generating Device”, No. 4,033,136. A detailed description of the Stewart cycle environmental heat engine is available at www.padrak.com/vesperman and www.commutefaster.com/vesperman.html.

A possibly more up-to-date version is Ralph J. Lagow's “Method of Generating Power from a Vapor”, US Patent No. 4,693,087.

George Wiseman has invented his Wise cycle environmental heat engine. George Wiseman, eagle-research.com

Rauen Cycle and Superclassical Cycle Environmental Heat Engines

Ken Rauen's Rauen cycle and Superclassical cycle engines also expand working fluids with environmental heat to provide useful net mechanical power.

The Superclassical cycle engine has U.S. Patent No. 6,698,200 for “Efficiency thermodynamic engine”. Its abstract is copied as follows:

A novel thermodynamic engines including a piston operating on a compressible fluid in a thermally insulated volume, which also includes a movable displacer which selectively divides the internal volume between a warm and a cold side, and a regenerator through which the fluid from the selectively divided volume passes and transfer its heat to or receives heat from, wherein the piston and displacer are each periodically moved in various complex motions according to the present invention to provide efficiency higher than Carnot efficiency. The resulting novel structures and methods, generally referred to as "Superclassical Cycle" engines, incorporate constant volume cooling and aspects of the "Proell Effect" (relative to cooling) to achieve improved efficiencies wherein the gas temperature on the cold side of a fluid displacer is below the lowest regenerator temperature due to "self-refrigeration." Thus according to the apparatus and methods according to the present invention, the traditional principals of the Second Law is further refined and higher operating efficiencies achieved.

(End of abstract)

The abstract of Ken Rauen’s videotaped lecture at www.scientificexploration.org/talks/29th_annual/29th_annual_rauen_proell_effect_maxwells_demon.html is as follows:

Maxwell’s Demon is a legitimate challenge to the universality of the Second Law of Thermodynamics when the “demon” is executed via the Proell effect. Thermal energy transfer according to the Kinetic Theory of Heat and Statistical Mechanics that takes place over distances greater than the mean free path of the gas circumvents the

microscopic randomness that leads to macroscopic irreversibility. No information is required to “sort” the particles, as no sorting occurs.

The Proell effect achieves quasi-spontaneous thermal separation without sorting by the perturbation of a heterogeneous constant volume system with displacement and regeneration. The classical analysis of the constant volume process, such as found in the Stirling Cycle, is incomplete and therefore incorrect. There are extra energy flows that classical thermo does not recognize. When a working fluid is displaced across a temperature gradient through a regenerative heat exchanger, complimentary pressure-volume compression and expansion work takes place that transfers energy between the regenerator and the bulk gas volumes on the hot and cold sides of the constant volume system that is not recognized by classical thermo, but which completely conforms to classical thermo. Heat capacity at constant pressure applies instead of heat capacity at constant volume. The increased energy flow represented by the heat capacity ratio, γ , represents such a large increase in the heat that can be recycled in a regenerator that it can exceed the Carnot limit in certain cycles. Heat engines and heat pumps have been designed from this concept, and a US patent has been awarded.

(End of abstract)

In an interview, <http://www.ongreen.com/deal-marketplace/environmentally-heated-engine>, Ken Rauen states that a Superclassical cycle engine apparently could be prepared for production in two years with \$1,500,000. The market seems to be larger than \$50,000,000,000.

Below is the text of Ken Rauen’s December 5, 2013 email to Gary Vesperman. Rauen's Rauen cycle and Superclassical cycle engines expand working fluids with environmental heat to provide useful net mechanical power.

Hi Gary,

I like the air well idea. When energy to make electricity is free, heat pumps can refrigerate the atmosphere and condense water from low humidity air easily, an air well.

You may want to know that my current work in environmentally heated engines are two projects being promoted by Mark Goldes' group, Aesop Institute. See www.aesopinstitute.org. The home page says something about the piston engine, and the topics on top refer to the piston engine as one project and the turbine engine as the other project. In both cases, other men invented these engine concepts. I just took the ideas to a better design, understanding how they work. One patent application has been made for Wainwright's piston engine concept, and the Kondrashov turbine idea has spawned another related invention.

Our potential investors are not delivering much yet – survival money – and we are still looking for more support. Your exposure of this work could be helpful. Unlike other free energy possibilities, I can go ‘nose to nose’ with any university physics professor about the science behind these projects. The science is solid. The technology is identified. It just needs resources to acquire facilities, tools, and materials.

Have Fun,

Ken Rauen

From: Mark Goldes <mgoldes@chavaenergy.com>

To: "garyvesperman@yahoo.com" <garyvesperman@yahoo.com>

Subject: FUEL-FREE PISTON ENGINES THAT CAN PROVIDE ONE MEGAWATT

Hi Gary,

Here is an introduction to our fuel-free engine program. There is much more on the website: www.aesopinstitute.org

Scroll down to Page 3 of opening segment: AESOP PERSPECTIVES. Note the 70 MegaWatt Diesel Power Plant photo and text.

Under NO FUEL PISTON ENGINES on the website scroll down to the bottom for an idea of how large these engines can become.

I'll be delighted to contact the fellow you mentioned.

With thanks for all your great work,

Mark

AESOP INSTITUTE

“Climate Change leaves us with, basically, two ways out. One is extraordinary technology: either a silver bullet to produce cheap, renewable energy, or a reliable geo-engineering technique to adjust the global ...weather system directly. Either might happen—the first likely will, maybe too late to prevent permanent crisis; but waiting on clean energy is a very big risk, and geo-engineering brings huge risks of its own ...ending up making the system even more unstable.” *Jedediah Purdy* Climate Change Needs the Politics of the Impossible **U.S. News** April 6, 2014

A cheap green silver bullet, the missing, singularly realistic, path to slowing climate change is immediately at hand.

An abundant untapped source of solar energy, atmospheric heat, can potentially power engines continuously without the need for fossil fuels. Two decades of physics research indicate not only that this may be possible, but that there exist exploitable exceptions to the current interpretation of the Second Law of thermodynamics. One example of such an exception is a patent pending piston engine currently being prototyped. Utilizing the abundant energy stored in the atmosphere, this design is capable of producing power continuously and can potentially scale to large sizes

Turbines that do not require fuel have also been designed and are being prototyped. They could provide hybrid cars with practically unlimited range and the ability to produce and sell excess electricity when suitably parked. Variations on this design may one day in the not-too-distant future replace coal and nuclear plants as well as power aircraft.

A few small prototype engines will be tested and validated by independent labs. A desktop piston engine capable of charging a tablet computer and cell phone will follow. Units capable of powering homes and buildings will not be far behind. See www.aesopinstitute.org

The science behind these engine designs provides a new interpretation of The Second Law of Thermodynamics. Few physicists and/or engineers accept that as possible. Second Law Surprises, under MORE on that website, will prove of interest to individuals willing to examine facts and evidence that are not widely known.

It appears to be just a matter of time before new, landmark discoveries in physics, engineering and nanomaterials, will lead to highly efficient engines and generators that use the practically unlimited energy available in the atmosphere. Such devices have the potential to significantly reduce the impact of climate change on present and future generations.

“Civilization is in a race between education and catastrophe. Let us learn the truth and spread it as far and wide as our circumstances allow. For the truth is the greatest weapon we have.” — H.G. Wells

I'm happy to provide additional information.

Mark

Mark Goldes
CEO AESOP Institute
Co-Founder CHAVA Energy
www.aesopinstitute.org
www.chavaenergy.com
707 861-9070
707 280-8210 cell

From: Gary Vesperman [garyvesperman@yahoo.com]
Sent: Tuesday, April 08, 2014 11:28 AM
To: Mark Goldes
Subject: Environmental heat engines
Hi Mark,

I haven't dug into your technologies yet.

Attached are two files with chapters on environmental heat engines.

Gary Vesperman

From: Mark Goldes <mgoldes@chavaenergy.com>
To: Gary Vesperman <garyvesperman@yahoo.com>
Subject: RE: Environmental heat engines

Hi Gary,

Very interesting. I am familiar with most, but not all of these.

Ken Rauen is the inventor of the NO FUEL PISTON ENGINE and our new versions of the turbines. We do not want to publicize that fact as he might become a target.

You were obviously aware of his earlier work.

Many thanks,

Mark

Mark Goldes
CEO AESOP Institute
Co-Founder CHAVA Energy
www.aesopinstitute.org
www.chavaenergy.com
707 861-9070
707 280-8210 cell

From: Gary Vesperman [garyvesperman@yahoo.com]
Sent: Tuesday, April 08, 2014 12:00 PM
To: Mark Goldes
Cc: Arden Weinke
Subject: Working prototype specs

Hi Mark,

I had a suspicion that Ken Rauen is the inventor. I have a lot of respect for his work.

My client here in Boulder City in our meeting with Arden Weinke was emphatic that he is not interested in funding R and D.

He is only interested in developing and scaling up actual working units. He is familiar with the non-mainstream science field.

Do you have a working unit that can be demonstrated to him? If so, what are its performance specifications?

Gary Vesperman

From: Mark Goldes <mgoldes@chavaenergy.com>
To: Gary Vesperman <garyvesperman@yahoo.com>
Cc: Arden Weinke <akay54738@yahoo.com>
Sent: Tuesday, April 8, 2014 12:24 PM
Subject: RE: Working prototype specs

Hi Gary, Arden,

As you know, Ken Rauen patented and prototyped his earlier engine. That proved the science. But, the engine was not practical.

However, the patent pending new engine reflects new insights that resulted from the unsung work of Jacob Wainwright which only came to light last year.

They opened the door to practical, self-running, engines that need nothing but atmospheric heat to produce power.

Prototypes are expected to take only another \$50k and be running in 90 days.

Others have reviewed the work and are also convinced these engines will work and prove scalable.

I have been seeking a workable Silver Bullet for 40 years and this is the most promising technology I am aware exists.

It will change the world.

In my opinion, the individual concerned might find that studying what has been done warrants the modest expense involved.

Best,

Mark

Mark Goldes
CEO AESOP Institute
Co-Founder CHAVA Energy
www.aesopinstitute.org
www.chavaenergy.com
707 861-9070
707 280-8210 cell

Environmental Heat Engines could Power Cooling Pumps for 700 Nuclear Reactors after Carrington-Class Solar Flare

Problem: Every century or two the sun aims towards the earth a huge coronal mass ejection causing an electromagnetic storm intense enough to blow out numerous inductive transformers. Power grids could go down for months. But nuclear reactor cooling pumps can only rely on diesel generators for at most a few days. Blackout-crippled refineries would not be able to supply diesel fuel for several months. Without cooling pumps, nuclear reactors and spent fuel storage pools would overheat – releasing catastrophic radiation ala Chernobyl and Fukushima.

Solution: Efficient and pollution-free environmental heat engines absorb ambient heat to expand a working fluid such as Freon or ammonia which pushes pistons through sealed chambers. An environmental heat engine can utilize a nuclear reactor's own natural low-grade heat to drive an auxiliary generator. The reactor's cooling pumps can be powered with the generator's electricity until the local power grid is eventually restored.

Here is an important additional **reason** why all nuclear power plants should be shut down as soon as possible:

http://www.naturalnews.com/033564_solar_flares_nuclear_power_plants.html

Tuesday, September 13, 2011
by Mike Adams, the Health Ranger
Editor of NaturalNews.com

Solar flare could unleash nuclear holocaust across planet Earth, forcing hundreds of nuclear power plants into total meltdowns

(NaturalNews) Forget about the 2012 Mayan calendar, comet Elenin or the Rapture. The real threat to human civilization is far more mundane, and it's right in front of our noses. If Fukushima has taught us anything, it's that just one runaway meltdown of fissionable nuclear material can have wide-ranging and potentially

devastating consequences for life on Earth. To date, Fukushima has already released **168 times** the total radiation released from the Hiroshima nuclear bomb detonated in 1945, and the Fukushima catastrophe is now undeniably the worst nuclear disaster in the history of human civilization.

But what if human civilization faced a far greater threat than a single tsunami destroying a nuclear power facility? What if a **global tidal wave** could destroy the power generating capacities of *all* the world's power plants, all at once?

Such a scenario is not merely possible, but factually *inevitable*. And the global tidal wave threatening all the nuclear power plants of the world isn't made of water but **solar emissions**.

The sun, you see, is acting up again. NASA recently warned that solar activity is surging, with a peak expected to happen in 2013 that could generate enormous radiation levels that sweep across planet Earth. The *National Oceanic and Atmospheric Administration* (NOAA) has even issued an urgent warning about solar flares due to strike in 2012 and 2013. *IBTimes* wrote, "With solar activity expected to peak around 2013, the Sun is entering a particularly active time and big flares like the recent one will likely be common during the next few years. ...A major flare in the mid-19th century blocked the nascent telegraph system, and some scientists believe that another such event is now overdue." (<http://www.ibtimes.com/articles/194...>)

The story goes on to explain:

"Several federal government studies suggest that this extreme solar activity and emissions may result in complete blackouts for years in some areas of the nation. Moreover, there may also be disruption of power supply for years, or even decades, as geomagnetic currents attracted by the storm could debilitate the transformers."

Why does all this matter? To understand that, you have to understand how nuclear power plants function. Or, put another way, how is nuclear material prevented from 'going nuclear' every single day across our planet?

Every nuclear power plant operates in a near-meltdown state

All nuclear power plants are operated in a near-meltdown status. They operate at very high heat, relying on nuclear fission to boil water that produces steam to drive the turbines that generate electricity. Critically, the nuclear fuel is prevented from melting down through the steady circulation of **coolants** which are pushed through the cooling system using very high powered **electric pumps**.

If you stop the electric pumps, the coolant stops flowing and the fuel rods go critical (and then melt down). This is what happened in Fukushima, where the melted fuel rods dropped through the concrete floor of the containment vessels, unleashing enormous quantities of ionizing radiation into the surrounding environment. The full extent of the Fukushima contamination is not even known yet, as the facility is still emitting radiation.

It's crucial to understand that nuclear coolant pumps are usually driven by **power from the electrical grid**. They are not normally driven by power generated locally from the nuclear power plant itself. Instead, they're connected to the grid. In other words, even though nuclear power plants are generating megawatts of electricity for the grid, they are also dependant on the grid to run their own coolant pumps. If the grid goes down, the coolant pumps go down, too, which is why they are quickly switched to emergency backup power – either *generators or batteries*.

As we learned with Fukushima, the on-site batteries can only drive the coolant pumps for around eight hours. After that, the nuclear facility is dependent on **diesel generators** (or sometimes propane) to run the pumps that circulate the coolant which prevents the whole site from going Chernobyl. And yet, critically, this depends on something rather obvious: The *delivery of diesel fuel* to the site. If diesel cannot be delivered, the generators can't be fired up, and the coolant can't be circulated. When you grasp the importance of this supply line dependency, you will instantly understand why a single solar flare could unleash a nuclear holocaust across the planet.

When the generators fail and the coolant pumps stop pumping, nuclear fuel rods begin to melt through their containment rods, unleashing ungodly amounts of life-destroying radiation directly into the atmosphere. This is precisely why Japanese engineers worked so hard to reconnect the local power grid to the Fukushima facility after the tidal wave – they needed to bring power back to the generators to run the pumps that circulate the coolant. This effort failed, of course, which is why Fukushima became such a nuclear disaster and released countless becquerels of radiation into the environment (with no end in sight).

And yet, despite the destruction we've already seen with Fukushima, U.S. nuclear power plants are nowhere near being prepared to handle sustained power grid failures. As *IBtimes* reports:

"Last month, the Nuclear Regulatory Commission said U.S. plants affected by a blackout should be able to cope without electricity for at least eight hours and should have procedures to keep the reactor and spent-fuel pool cool for 72 hours. Nuclear plants depend on standby batteries and backup diesel generators. Most standby power systems would continue to function after a severe solar storm, but supplying the standby power systems with adequate fuel, when the main power grids are offline for years, could become a very critical problem. If the spent fuel rod pools at the country's 104 nuclear power plants lose their connection to the power grid, the current regulations aren't sufficient to guarantee those pools won't boil over – exposing the hot, zirconium-clad rods and sparking fires that would release deadly radiation." (<http://www.ibtimes.com/articles/194...>)

Now, what does all this have to do with solar flares?

How the end of modern civilization will most likely occur

As any sufficiently informed scientist will readily admit, solar flares have the potential to **blow out the transformers** throughout the national power grid. That's because solar flares **induce geomagnetic currents** (powerful electromagnetic impulses) which overload the transformers and cause them to explode.

You've probably witnessed this yourself during a lightning storm when lightning unleashes a powerful electromagnetic pulse that causes a local transformer to explode. Solar flares do the same thing on a much larger scale. A *global* scale, in fact.

The upshot of this situation is that suddenly and without warning, the power grid infrastructure across nearly the entire planet could be destroyed. As a bonus, nearly all satellites will be fried, too, leaving GPS inoperable and causing millions of clueless drivers to become forever lost in their own neighborhoods because they never paid attention to the streets and always relied on a GPS voice to tell them, "In fifty feet, turn right."

Communications satellites will be obliterated, too. This, of course, will halt nearly all news propaganda distribution across the planet, causing tens of thousands of people to instantly die out of the sheer fear of suddenly having to think for themselves. As another bonus, nearly all mobile phone service will be disrupted, too, meaning all the teenage text junkies of the world will, for the first time in their lives, be forced to lay down their iPhones and interact with real people in the real world.

But the real kicker in all this is that **the power grid will be destroyed nearly everywhere.**

What happens when there's no electricity?

Imagine **a world without electricity.** Even for just a week. Imagine New York City with no electricity, or Los Angeles, or Sao Paulo. Within 72 hours, most cities around the world will devolve into total chaos, complete with looting, violent crime, and runaway fires.

But that's not even the bad news. Even if all the major cities of the world burned to the ground for some other reason, humanity could still recover because it has the farmlands: the soils, the seeds, and the potential to recover, right?

And yet the real crisis here stems from the realization that once there is no power grid, all the nuclear power plants of the world suddenly go into 'emergency mode' and are forced to rely on their on-site emergency power backups to circulate coolants and prevent nuclear meltdowns from occurring. And yet, as we've already established, these facilities typically have only a few hours of battery power available, followed by perhaps a few days worth of diesel fuel to run their generators (or propane, in some cases).

Did I also mention that half the people who work at nuclear power facilities have no idea what they're doing in the first place? Most of the veterans who really know the facilities inside and out have been forced into retirement due to reaching their **lifetime limits** of on-the-job radiation exposure, so most of the workers at nuclear facilities right now are *newbies* who really have no clue what they're doing.

There are **440 nuclear power plants** operating across 30 countries around the world today. There are an additional 250 so-called 'research reactors' in existence, making a total of roughly **700 nuclear reactors** to be dealt with (<http://www.world-nuclear.org/info/i...>).

Now imagine the scenario: You've got a massive solar flare that knocks out the world power grid and destroys the majority of the power grid transformers, thrusting the world into darkness. Cities collapse into chaos and rioting, martial law is quickly declared (but it hardly matters), and every nation in the world is on full emergency. But that doesn't solve the really big problem, which is that you've got **700 nuclear reactors** that can't feed power into the grid (because all the transformers are blown up) and yet simultaneously have to be fed a steady stream of emergency fuels to run the generators that keep the coolant pumps functioning.

How long does the coolant need to circulate in these facilities to cool the nuclear fuel? **Months.** This is also the lesson of Fukushima: You can't cool nuclear fuel in mere hours or days. It takes *months* to bring these nuclear facilities to a state of cold shutdown. And that means in order to avoid a multitude of Fukushima-style meltdowns from occurring around the world, you need to **truck diesel fuel**, generator parts and nuclear plant workers to every nuclear facility on the planet, ON TIME, every time, without fail, for months on end.

Now remember, this must be done in the middle of the total chaos breakdown of modern civilization, where there is no power, where law enforcement and emergency services are totally overrun, where people are starving because food deliveries have been disrupted, and when looting and violent crime runs rampant in the streets of every major city in the world. Somehow, despite all this, you have to run these diesel fuel caravans to the nuclear power plants and keep the pumps running.

Except there's a problem in all this, even if you assume you can somehow work a logistical miracle and actually deliver the diesel fuel to the backup generators on time (which you probably can't).

The problem is this: **Where do you get diesel fuel?**

Why refineries will be shut down, too

From **petroleum refineries**. Most people don't realize it, but petroleum refineries **run on electricity**. Without the power grid, the refineries don't produce a drop of diesel. With no diesel, there are no generators keeping the coolant running in the nuclear power facilities.

But wait, you say: Maybe we could just acquire diesel from all the gas stations in the world. Pump it out of the ground, load it into trucks and use that to power the generators, right? Except there are other problems here: How do you pump all that fuel without electricity? How do you acquire all the tires and spare parts needed to keep trucks running if there's no electricity to keep the supply businesses running? How do you maintain a truck delivery infrastructure when the electrical infrastructure is totally wiped out?

Some countries might be able to pull it off with some degree of success. With **military escorts** and the total government control over all fuel supplies, a few nations will be able to keep a few nuclear power facilities from melting down.

But here's the real issue: There are 700 nuclear power facilities in the world, remember? Let's suppose that in the aftermath of a massive solar flare, the nations of the world are somehow able to control half of those facilities and nurse them into cold shutdown status. That still leaves roughly 350 nuclear facilities at risk.

Now let's suppose half of those are somehow luckily offline and not even functioning when the solar flare hits, so they need no special attention. This is a very optimistic assumption, but that still leaves **175 nuclear power plants** where all attempts fail.

Let's be outrageously optimistic and suppose that a third of those somehow don't go into a total meltdown by some miracle of God, or some bizarre twist in the laws of physics. So we're still left with **115 nuclear power plants** that 'go Chernobyl'.

Fukushima was one power plant. Imagine the devastation of 100+ nuclear power plants, all going into meltdown all at once across the planet. It's not the loss of electricity that's the real problem; it's the **global tidal wave of invisible radiation** that blankets the planet, permeates the topsoil, irradiates everything that breathes and delivers the final crushing blow to human civilization as we know it today.

Because if you have **100 simultaneous global nuclear meltdowns**, the tidal wave of radiation will make farming nearly impossible *for years*. That means no food production for several years in a row. And that, in turn, means a near-total collapse of the human population on our planet.

How many people can survive an entire year with no food from the farms? Not one in a hundred people. Even beyond that, how many people can essentially **live underground** and be safe enough from the radiation that they can have viable children and repopulate the planet? It's a very, very small fraction of the total population.

Solar flares far more likely to hit nuclear power plants than tidal waves or earthquakes

What's the chance of all this actually happening? A report by the Oak Ridge National Laboratory said that "...over the standard 40-year license term of nuclear power plants, **solar flare activity enables a 33 percent chance of long-term power loss, a risk that significantly outweighs that of major earthquakes and tsunamis.**" (<http://www.ibtimes.com/articles/194...>)

The world's reliance on nuclear power, you see, has doomed us to destroy our own civilization. Of course, this is all preventable if we would only **dismantle and shut down ALL nuclear power plants on the planet**. But what are the chances of that happening? Zero, of course. There are too many commercial and political interests invested in nuclear power.

So the power plants will stay, and we will therefore be vulnerable to a solar flare which could strike us at any time and unleash a global nuclear holocaust. Planet Earth has been struck by solar flares before, of course, but all the big hits in recorded human history took place **long before the age of modern electronics**, so the impacts were minimal. Today, society cannot function without electronics. Nor can nuclear facility coolant pumps. Once you realize that, you begin to understand the true danger in which humanity has placed itself by relying on nuclear power.

By relying on nuclear power, we are risking everything. And we're doing it blindly, with no real acknowledgement of the dangers of running 700+ nuclear facilities in a constant state of 'near meltdown' while foolishly relying on the steady flow of electricity to keep the fuel rods cool. If Fukushima, all by itself, could unleash a tidal wave of deadly radiation all by itself, imagine a world where **hundreds of nuclear facilities** go into a total meltdown *simultaneously*.

A repeat of the 1859 solar storm - called the Carrington Event - would "devastate the modern world," admits a *National Geographic* article: <http://news.nationalgeographic.com/...>

What can you do about any of this? **Build yourself an underground bunker** and prepare to live in it for an extended period of time. (Just a few feet of soil protects you from most radiation.) The good news is that if you survive it all and one day return to the surface to plant your non-hybrid seeds and begin rebuilding human society, **real estate will be really, really cheap**.

Especially in the radiation zones.

Take this seriously! Read more from NASA

<http://www.space.com/12580-sun-unle...>

<http://science.nasa.gov/science-new...>

From NASA:

"Just before dawn the next day, skies all over planet Earth erupted in red, green, and purple auroras so brilliant that newspapers could be read as easily as in daylight. Indeed, stunning auroras pulsed even at near tropical latitudes over Cuba, the Bahamas, Jamaica, El Salvador, and Hawaii. Even more disconcerting, telegraph systems worldwide went haywire. Spark discharges shocked telegraph operators and set the telegraph paper on fire. Even when telegraphers disconnected the batteries powering the lines, aurora-induced electric currents in the wires still allowed messages to be transmitted..."

"...as electronic technologies have become more sophisticated and more embedded into everyday life, they have also become more vulnerable to solar activity. On Earth, power lines and long-distance telephone cables might be affected by auroral currents, as happened in 1989. Radar, cell phone communications, and GPS receivers could be disrupted by solar radio noise. Experts who have studied the question say there is little to be done to protect satellites from a Carrington-class flare. In fact, a recent paper estimates potential damage to the 900-plus satellites currently in orbit could cost between \$30 billion and \$70 billion."

Learn more: http://www.naturalnews.com/033564_solar_flares_nuclear_power_plants.html#ixzz1Z0qH9fOn

About the author: Mike Adams is an award-winning journalist and holistic nutritionist with a passion for sharing empowering information to help improve personal and planetary health. He has authored and published thousands of articles, interviews, consumer guides, and books on topics like health and the environment, impacting the lives of millions of readers around the world who are experiencing phenomenal health benefits from reading his articles. Adams is a trusted, independent journalist who receives no money or promotional fees.

whatsoever to write about other companies' products. In 2010, Adams launched NaturalNews.TV, a natural health video site featuring videos on holistic health and green living. He also founded an environmentally-friendly online retailer called BetterLifeGoods.com that uses retail profits to help support consumer advocacy programs. He's also a veteran of the software technology industry, having founded a personalized mass email software product used to deliver email newsletters to subscribers. Adams volunteers his time to serve as the executive director of the Consumer Wellness Center, a 501(c)3 non-profit organization, and regularly pursues cycling, nature photography, Capoeira and Pilates. He's also author a large number of health books offered by Truth Publishing and is the creator of numerous reference website including NaturalPedia.com and the free downloadable Honest Food Guide. His websites also include the free reference sites HerbReference.com and HealingFoodReference.com. Adams believes in free speech, free access to nutritional supplements and the innate healing ability of the human body. Known as the 'Health Ranger,' Adams' personal health statistics and mission statements are located at <http://www.healthranger.org/>

Learn more: http://www.naturalnews.com/033564_solar_flares_nuclear_power_plants.html#ixzz1Z0qL9IC8

As reported in <http://phys.org/news/2014-05-carrington-class-cme-narrowly-earth.html> our planet narrowly missed a Carrington class solar storm on July 23, 2012.

For more on solar storms see

<http://www.bloomberg.com/news/2014-06-20/why-springsteen-had-a-point-about-staring-into-the-sun.html>.

Washington, DC area magnetometer readings during the few weeks of 2012 have measured a weakening by a few percentage points of the Earth's magnetic field. Continued weakening extrapolates to a near zero magnetic field sometime during the next few years. All of our planet's power grids would no longer be protected from electromagnetic surges induced by unusually strong coronal mass ejections.

For more woefully negative information about nuclear power reactors see Gary Vesperman's 350-page compilation of "Radioactivity Neutralization Methods" in www.padrak.com/vesperman or www.commutefaster.com/vesperman.html.

Capacitive step-down Transformer

The capacitive step-down transformer is a simpler, cheaper, lighter, smaller, nearly 100% efficient alternative to inductive transformers. Capacitive step-down transformers do not have inductive, noise, heat and sound losses of inductive transformers.

Capacitive step-down transformers can be used anywhere that is stepping down high voltages, low amperes into lower voltages, higher amperes – industry, commercial, residential and appliances. Not using capacitive step-down transformers has resulted in lower efficiency of transmission and distribution with enormous waste of electricity.

Capacitive power supplies are inherently capacitive amperage limiting. So therefore short circuits do not damage them. A brownout or blackout in one area of the grid will not take down any generators that are protected with capacity power supply technology. There is no need for electronic controls or a grid infrastructure upgrade – the amperage control is automatic and instantaneous. If a solar flare blows out many inductive transformers, capacitive step-down transformers can be fast, effective replacements.

Capacitive step-down transformers can also be reconfigured quickly and easily onsite to handle more or less wattage or to change voltage and amperage ratios. All applications that use step-down transformers can be converted.

Inventor: George Wiseman, Oroville, Washington, USA
Author of “Capacitive Battery Charger” www.eagle-research.com

MISCELLANEOUS

Super-conductive Manganite Substrates

A substrate comprised of an alpha-emitter isotope intercalated with manganite crystalline materials is super-compressed to create room temperature super-conductive substrate materials. This concept has already been demonstrated in proof-of-concept prototypes by MIT and others.

The physics is based on the model of fine scale interactions described in the Y-bias and angularity model. See David G. Yurth’s summary “Y-Bias and Angularity: The Dynamics of Self-Organizing Criticality from the Zero Point to Infinity” in www.padrak.com/vesperman. Inventor is David Yurth.

Amplified Ionization Filtration Technologies

Alpha-emitter isotopic materials are deposited on the surfaces of permanently magnetized metallic foam of proprietary design to amplify ionization energies exhibited by molecules of air and fuels as they are fed to power various kinds of combustion apparatus. Each apparatus type is accommodated and tested separately using the common ionization filtration technique in varying form factors.

The physics is based on the model of fine scale interactions described in the Y-bias and angularity model. See David G. Yurth’s summary “Y-Bias and Angularity: The Dynamics of Self-Organizing Criticality from the Zero Point to Infinity” in www.padrak.com/vesperman. Inventor is David Yurth.

Sola-Q Self-Focusing Omni-Directional Solar Cooker

The Sola-Q self-focusing omni-directional solar cooker guarantees clean and hassle free cooking. In only 10 minutes, the Sola-Q boils a quart of water or cooks four hamburgers. Designed to resemble a traditional barbecue hibachi with a clear transparent bubble, the Sola-Q employs a breakthrough Multask Dome Lens™ technology to collect the sun’s energy from any angle to cook outdoors or indoors, wherever sunlight is available. The Sola-Q is especially effective in third world rural areas where precious wood and shrubbery are burnt for cooking – causing expanding deserts, loss of vital topsoil (farmland), climate change, loss of oxygen-producing plants and natural wildlife habitats.

The Sola-Q’s unique, bubble shaped lens works independently and without the need for focusing. It needs no manual adjustments or expensive mechanical trackers. Its closed spherical lens collects and retains most of the sun’s energy with minimal heat loss. Clean cooking indoors (in any room!) is possible where it is sunny. The high-impact transparent bubbles are six times tougher than standard acrylic and are ultraviolet and scratch-resistant. The Sola-Q offers extremely low maintenance and operating costs.

The Sola-Q offers some advantages over solar box ovens. Solar box ovens need to be repositioned to directly face the sun every half-hour; the Sola-Q can simply be placed in the sun and left untended until the cooking is done. The Sola-Q starts up faster and cooks faster than solar box ovens. More food moisture is retained in the Sola-Q than the solar box oven. The Sola-Q is sturdier and more resistant to wind and hail than solar box ovens. <https://www.elance.com/samples/mobasher-solar-cooker/26059207/> The Sola-Q's inventor is Abby Charden Mobasher.

Aaftaab Furnace

The Aaftaab Furnace™ is a segmented solar collector-concentrator for melting and processing materials. Parts can be made from melting local sand (mixed with other components) and assembled together to make hemispherical lens. The Aaftaab Furnace™ could be used to make more of the same parts to be utilized for energy production, manufacturing, steam generation etc. The inventor is Abby Charden Mobasher.

Domestic Lens

The Domestic Lens™ is a large, lightweight, thin and inexpensive lens for the optical industry. Immediate applications could be large-diameter lenses to be used in telescopes, photographic, viewing and other applications at a fraction of the cost of large diameter lenses. The abrasion resistant Domestic Lens™ would be as much as 50 times lighter than traditional lenses. They would be of higher resolution than Fresnel lens. An inexpensive proprietary manufacturing technique allows manufacturing in most focal lengths in a very short time for large observatory telescopes. Telescopic focal lengths can be adjustable to some extent. The inventor is Abby Charden Mobasher.

Hydrosonic Pump

Mechanical input power rotates the shaft, and plain water is converted to steam without the need for hot surfaces and consequently without the buildup of scale. The process is essentially based on collapsing microscopic bubbles to momentarily create extremely high pressures and temperatures. This controlled cavitation generates shock waves. Thus another name for the device is shockwave power generator.

The steam exits the device glows purple. The process seems to be actually a form of fusion where collapsing microscopic bubbles momentarily create extremely high pressures and temperatures. The technical term for this phenomenon is 'sono-luminescence'.

The hydrosonic pump works by taking a fluid, pure or impure, into the machine housing, where it is passed over the generator's spinning cylinder. The specific geometry of the holes in the cylinder, clearance between the cylinder, and the housing and rotational speed create pressure differences within the liquid where tiny bubbles form and collapse. These collapsing bubbles generate shock waves. The result is the conversion of mechanical energy into heat energy. The effect is immediate when the shaft rotates in contrast to boilers which often take hours to reach boiling temperatures.

In addition, there is an ultrasonic cleaning effect that occurs on the metal surfaces inside the hydrosonic pump as the shock waves are generated within narrow tolerances. This cleaning effect, in conjunction with the metal surfaces being cooler than the liquid, ensures scale-free heating.

The energy conversion efficiency is around 130%. To prevent confusion, it should be clearly understood that the hydrosonic pump on the macro scale does *not* operate at high temperatures and pressures as is the case with nuclear or fossil-fueled boilers. The physics of the device is not fully understood.

One application is to use a windmill to turn the shaft. Out of the nozzle emanates steam which drives a steam turbine to produce electricity. The steam then enters a condenser from which can be obtained potable water and hot water for space heating. For remote islands, for example, the hydrosonic pump would be very useful in its simultaneous generation of electricity and seawater desalination. One utility was reportedly already looking at increasing the efficiencies of its nuclear and fossil-fueled power plants by 3 - 5 percentage points.

As of May 1996, the inventor had 14 units actually installed and operating in Atlanta, Georgia. One application was for producing clean steam on demand for a commercial laundry. The customers included the Atlanta Police Department, a fire station, a dry cleaning plant, and a gymnasium. Interestingly, the hydrosonic pump was installed in the public buildings by the county engineer after evaluating the device. The buildings used the device mainly for heating purposes, and they had been running for more than a year. The customers have bills from their local electric utility company showing a year-on-year decrease in bills equivalent to 30 per cent.

Nevada has large underground reservoirs of useless mineralized water. The hydrosonic pump could be the centerpiece of a large-scale scheme to generate electricity, heat and potable water. The hydrosonic pump could also desalinate seawater for Mexico and California's coastal cities which would remove some of the demand for Colorado River water. The shafts of hydrosonic pumps could be rotated by electric motors powered with cheaply generated electricity in the same manner as air wells.

The hydrosonic pump is actually being commercially manufactured and sold. The inventor James Griggs definitely was using the correct approach in that since the pump is such a new technology, for some time he had been simply building one unit at a time in various sizes and configurations. He had been purposely restricting their sale to local installations so he could closely monitor their performance and incorporate improvements and changes into future units. As of May 1996, he had 14 units actually installed and operating. One application was for producing clean steam on demand for a commercial laundry.

James Griggs was an electrical engineer, entrepreneur, and owner of Hydro Dynamics, Inc. located in Rome, Georgia. Mr. Griggs had invented what is called a hydrosonic pump, which is a novel device for heating liquids. This device, rather than heating liquids via a resistive heating element or via the direct combustion of fossil fuels, heats liquids through what may be called shock waves – hence the name hydro+sonic (water + sound). In watching the video of this hydrosonic pump, one sees cold water being injected into one side of this device while saturated steam exits the other side of this device. Beneath the external casing of the device itself, unseen, is a spinning cylinder of novel design. Impressive as this device is, it is more so when it is learned that the energy of the steam exiting this device greatly exceeds all of the energy input needed to create this steam. In other words, the energy efficiency of this device is significantly greater than 100%. Equally impressive is the fact that the steam exiting the hydrosonic pump glowed violet.

The history of this product's development is as interesting as its performance and perhaps has antecedent developments in the discovery of sonoluminescence in the 1930s and the development of the Keeley motor by John Keeley in the late 1800s. Sonoluminescence is the direct conversion of sound into light using water as the medium – hence the name sonoluminescence (sound + light). Sonoluminescence is not well understood even to this day, 60 years after its discovery, but apparently it is the effect of light emission from a bubble dissolved in water as a result of a shock wave created in that water by sound waves which hammer the bubble into compression. The bubble releases energy over a broad spectrum of visible as well as invisible light, the most energetic components being in the blue and violet spectrum.

The Keeley motor was an over-unity device which ran on water and whose operation purportedly was based on ‘water hammer’ – that undesirable phenomenon in any high pressure water pipe system which describes the unwanted banging and groaning noises associated with a system due to abrupt pressure changes or shock waves.

In the mid-to-late 1980s, Jim Griggs toyed with a desire for alternative sources for energy production. Griggs was familiar with the water hammer effect and noticed that articles on this subject mentioned the accompanying heating effect, albeit a minuscule one, as a result of the creation of the water hammer shock waves. By magnifying this shock wave effect via a novel rotating cylinder design, Griggs hoped to magnify this heating effect as well. In 1988 and 1989, Griggs made his first successful rotors which could convert water directly into steam. It was in the 1989 design that Griggs noted that his energy efficiency exceeded 100%. Griggs stated, “I felt we had made a mistake, but we could not make the results go away. Now here we are, five years later, and after many of our own tests, as well as calling outside consultants to run and evaluate the system objectively, the (over unity) results still stand.” Even though the academic community has pretty much ignored the over unity aspects of the hydrosonic pump, the market place has not ignored the unique heating attributes of this pump. For instance, the pump is already being marketed for home and commercial heating systems as an inexpensive steam generator. The dairy industry is currently interested in its use to pasteurize milk, which requires that milk be heated to a temperature of 160 degrees Fahrenheit for 16 seconds. A condominium complex and boiler company in Key Biscayne, Florida is working with Griggs to generate steam directly from water using a windmill generator. In this case, the hydrosonic pump would be powered directly by the windmill. Other contacts in the Bahamas, Puerto Rico, and Canada are also interested in this development as well. Lastly, the hydrosonic pump is being used now industrially in distillation processes. For instance, it is being used in one process to separate glycerin from water.

Unfortunately, Griggs must play down the over unity aspect of his invention for, as he says, “... fear of chasing a customer away with talk of a device that defies energy conservation laws.” Of course, if this same customer were to see the violet luminescent steam exiting from his or her newly installed hydrosonic pump, one must wonder whether or not this customer would realize that he was witnessing something for which academic science does not allow.

Based on feedback from customers’ experience with them, he was evolving step-by-step in an organized manner towards eventual mass production and sale of *fully validated* units. It seems to be much easier to obtain expansion capital for actual commercial units than ‘laboratory queens’.

The hydrosonic pump seems destined to become a billion-dollar invention with many applications involving heating, evaporating, separating or mixing liquids. It is really a zero-pressure boiler, not a pump. The inventor has been calling it a pump so as to avoid entanglement with strict American Society of Mechanical Engineers boiler codes.

Source: The James Griggs Hydrosonic Pump, Academy For New Energy’s NE Newsletter, Vol. 1, Number 1, April 1996 (by Joe Maize). James Griggs was a speaker at the International Symposium on New Energy that was held in Denver April 25-28, 1996.

Gary Vesperman was recently told on the telephone by inventor Maurice Bey that Griggs posed enough of a threat to the energy status quo that he was shut down by the US Government.

Maurice Bey has been researching the Schaeffer engine which apparently shares some similarities with the hydrosonic pump. See <http://www.rexresearch.com/schaeffe/schaeffer.htm>.

Michael Waters also apparently has been researching something similar but simpler than the Schaeffer engine.

<http://rexresearch.com/griggs/griggs.htm>
http://www.youtube.com/watch?v=yh_-DUKQ4Uw

IPMS-Chernovitsky Super Ceramics

The I.N. Frantsevich Institute for Problems of Materials Science (I.P.M.S.) is one of more than 70 institutes founded by the government of the Soviet Union during the decade following World War II. Its mission was very simple: the scientists forcibly relocated from post-war Europe and enslaved at the Institute were commissioned to learn everything there is to know about the material world. They were not asked, indeed, they were not permitted, to make any decisions about how their discoveries were to be applied. In fact, from the outset and during all of the ensuing 40 years, there was not a single applications engineer among the 6,600 scientists who worked in the Institute.

The peculiar set of circumstances which provided the essential breeding ground for the extraordinary discoveries spawned by the Institute was not reserved just to I.P.M.S. The central government of U.S.S.R. jealously guarded its absolute right to make all decisions about what was done with the discoveries created in all the institutes. It is not surprising, therefore, that a system of government so paranoid about anyone stealing a pair of shoes that it manufactured left boots in Moscow and right boots in Kiev, would totally fail to recognize or effectively apply the benefits of some startlingly new sciences to clothe, house and feed its own people.

In fact, it was precisely because the Institute was forced to operate in a purely theoretical environment, with no pressure whatever to meet production or marketing deadlines, operating virtually isolated from any contact with the outside world, that the scientists and academicians were able to produce at least 7 whole new sciences, 30 technologies, and 130 materials unknown in the West. It is largely because the most brilliant theoretical physicists in the entire Soviet Union were able to work for nearly 50 years in the singular pursuit of pure research that the sciences developed at I.P.M.S. are so fundamentally unique.

It is interesting to note that only a small part of the new sciences developed at the Institute was revealed to or known by the government of the former Soviet Union prior to its collapse in August, 1991. The antipathy of the Institute's scientists to the USSR government's shabby treatment led them to successfully hide nearly all of their often revolutionary research results.

One of the Institute's four sites, IPMS-Chernovitsky, developed moldable, machine-able, ultra-high temperature, super-hard, and strategic metal-alloyed ceramic substances.

The uniformity and density of ceramic materials is what determines the quality, consistency and persistence of the resonant tone produced by an oscillating crystalline material. Research has created a whole new family of moldable, machine-able, ultra-high temperature, super-hard and strategic metal-alloyed ceramics capable of withstanding operating temperatures of 1200 degrees centigrade. This is more than 400 degrees centigrade higher than can be tolerated by other known ceramic materials commercially available anywhere else in the world, including those manufactured by Allied Signal Corporation and Kyocera.

These materials are being utilized in entirely ceramic internal combustion engines, high-speed turbines and self-lubricating bearing surfaces. The latest ceramic materials designed for use in high-speed jet turbines operate continuously at temperatures in excess of 1200 degrees centigrade. This is more than 400 degrees centigrade higher than the theoretical limit allowed by the quantum mechanics model relied on in the West.

The ceramics produced at the IPMS-Chernovitsky plant have been made harder by fully one factor of hardness than the hardest alloyed metal machine tools currently produced by any other known means of manufacture. They have been made harder by at least one full order of magnitude than either natural or synthetically produced diamonds. Practical applications include drilling and mining, grinding tools, down-hole equipment, tool inserts and the new generation of cubic boron nitride tools that are currently in use.

Proof positive of the extraordinary uniformity and density of these materials is easily verified by a simple demonstration if the measurement of softening temperatures is deemed insufficient. Ceramic pistons manufactured for use in ceramic diesel engines will, when struck by a hard object, produce a clear resonant tone which persists for more than seventeen seconds. This is at least eight seconds longer than the resonant persistence produced by the finest glass or crystal ever manufactured,

The world's biggest airplane is the Russian Antonov 225 freight carrier. It has 32 wheels and six very large jet engines. Partly thanks to IPMS-developed sciences, technologies, materials, and devices, Russian military and aerospace manufacturing could be as much as 50 years ahead of Western manufacturing capabilities.

(Source: David G. Yurth, *The Anthropos Files: Tales of Quantum Physics from Another World – 2nd Edition*, 2007)

IPMS Micro-Channels and Filters

The I.N. Frantsevich Institute for Problems of Materials Science (IPMS) was established in Kiev, Ukraine in 1951. Between 1945 and 1955, the government of the Soviet Union created at least 72 self-contained, completely isolated scientific communities like the IPMS scattered all over the most desolate parts of the Soviet empire. Stalin systematically established more than 360 such enclaves as a matter of policy. He deliberately prevented the scientists and their families from co-mingling with the rest of Soviet society or corresponding with the West. This phenomenon of cultural isolation was typical of life in the U.S.S.R. after World War II.

Many of the key scientists who were forcibly expatriated by the Red Army under Stalin's orders and relocated to work in the Institute had been captured by the Soviet armies during the occupation and annexation of Eastern Europe at the end of World War II. Only a handful of them succeeded in escaping to the West. Those who tried to escape were almost always captured and executed. In some cases, their families were sent to languish and die in the Gulags.

Many of the original team of scientists sequestered in L'vov, the entrance to the Institute, had been contemporaries, co-workers and close personal friends with many of the most prominent physicists and other scientists who emigrated to the United States before, during and after World War II.

During World War II in Europe, and afterwards in Stalin's Soviet Union, the original Directors of the Institute experienced the horrors of developing technology for destructive military use. For more than 40 years, scientists at IPMS (and, no doubt, at some of the other Soviet institutes) elected to keep secret as many of their key discoveries as possible until a time when their genius could be constructively applied to solving the global materials, energy consumption and industrial manufacturing issues which are responsible for the current deplorable state of the environment.

Among the original group of scientists relocated to work in the Institute were some who were part of the German team which worked during World War II to develop fissionable nuclear materials, synthetic fuels and foods, and other technological advances for the Third Reich. Information regarding the advanced nature of some of the work they participated in has only recently been declassified and released to the public. Some of the

formulas and technologies they developed were absolutely revolutionary and many have never been replicated in the post-war world.

Among recently declassified files is a set of documents which describes the development of infra-red, heat-seeking “smart bombs” which were so effective that a single bomb, dropped by a single Nazi bomber in a night attack in the North Atlantic in 1942, sank a British troop ship carrying more than 3,000 American troops. The bomb recognized and guided itself down the troop ship’s smoke stack in much the same way similar devices were observed to function during Operation Desert Storm, nearly 50 years later. The technology which made this device functional was so far advanced beyond anything available to the Allies at the time that the War Department kept the story classified for more than 50 years.

Many of the materials, processes, technologies and applications produced by the Institute are so unique that in some cases there are literally no words in the languages of the Western industrialized nations to describe them.

IPMS has produced a family of micro-channel and filter materials with uniformly controllable orifices as small as .5 micron from combinations of carbon-fiber, basalt, ceramic and strategic metals – including stainless steel, scandium and chromium. These materials demonstrate a consistency of orifices fully a factor of ten times smaller and more consistent than the smallest ever manufactured in the U.S.

These materials have been used in applications for heat exchangers, catalysts and separation of gases on a molecular level. A notable application involves the use of such materials to separate virtually 100% pure CO₂ from hydrogen gas at the well-head from gas wells. Then 98% of the CO₂ can be pumped back into the well for re-pressurization, with the pumps then being operated directly on virtually pure hydrogen fuel.

The scientists, academicians and others at the Institute who developed revolutionary new models of quantum mechanics, quantum physics and the manufacturing processes and techniques which resulted in these materials, refused as a matter of conscience to allow much of what they had developed to pass into the hands of the KGB and the Soviet military.

(Source: David G. Yurth, *The Anthropos Files: Tales of Quantum Physics from Another World – 2nd Edition*, 2007)

IPMS-Kiev and Arzamas-16 Super Magnets

The evolution of the Soviet view of the material world was reflected in the formulation of a new model of nonlinear quantum mechanics as an implicit function of consciousness. For instance, water is more than just H₂O. Experiments prove water can be affected in measurable ways by subtle influences such as music or whether a person's thoughts are hate-filled or life-enhancing. A more correct understanding of materials has thus enabled super magnets to be developed.

In conjunction with research jointly conducted at the highly secretive laboratories at Arzamas-16 in Khazakstan, IPMS-Kiev has developed a family of magnets with energy characteristics equal to or exceeding those of the best conventional iron-boron-neodymium types, but with the all-important feature that they operate with equal or greater efficiency at extremely high temperatures, up to 250 degrees centigrade. These magnets are so powerful that they have been successfully used to conduct extensive research in a perpetual zero gravity environment. All these experiments have been performed without the use of cryogenics.

(Source: David G. Yurth, *The Anthropos Files: Tales of Quantum Physics from Another World – 2nd Edition*, 2007)

ADVANCED SELF-POWERED ELECTRIC TRANSPORTATION VEHICLES

Electric vehicles are clean, quiet, powerful, require much less maintenance than gasoline or diesel-fueled vehicles, and are inherently much simpler and easier to manufacture. Their drawbacks have been a short range, long battery recharging time, and a heavy, bulky battery pack. Clearly, self-powered electric vehicles, if they could somehow be designed and manufactured at a reasonable cost, ought to be a commercial success.

Forbes January 25, 1999 compares today's electric golf carts (400,000 already sold) with personal computers back in the 1970's. (For a copy of the article see <http://www.forbes.com/forbes/99/0125/6302088a.htm>.)

Practical self-powered electric vehicles at minimum must satisfy four requirements: The battery ideally should not have the disadvantages of conventional lead-acid batteries such as temperature sensitivity, low charge-to-weight ratio, toxic materials, and finicky slow recharging. The motor should be durable and highly efficient. Heating and air conditioning must be provided.

The fundamentally key difference from conventional electric vehicles is having an on-board battery charger or other energy source which eliminates the necessity for carrying around a half ton or so of batteries and for charging stations spaced along roadways.

Electric bicycles with only one battery are inherently more practical than conventional electric cars or trucks carrying a half-ton or so of batteries stuffed into every available nook and cranny of the vehicle. When just one battery out of one or two dozen batteries fails, the dead battery can be time-consuming to find before replacement. Once a dead battery is replaced, it could be a short time before another battery fails again. Besides weighing much less and with the batteries taking up much less space, a self-powered electric vehicle with an on-board battery charger would typically require at most only a couple of batteries.

What follows are candidate technologies, if commercially developed along with a small generator, which could possibly be combined into a reliable, commercially successful advanced self-powered electric vehicle with additional desirable but currently commercially unavailable features.

AuroraTek's Self-Charging Electric Bike

Mainstream science defines 'dark energy' as a hypothetical form of energy. It permeates all of space and tends to accelerate the expansion of the Universe. According to the Planck mission team, and based on the standard model of cosmology, the total mass energy of the Universe contains 4.9% ordinary matter, 26.8% dark matter and 68.3% dark energy.

It is observed through an astronomical means. Dark energy has a strong negative pressure, or acting gravitational repulsion, in order to explain the observed acceleration in the expansion rate of the universe.

According to the general relativity theory, the physical quantity that causes matter to produce gravitational effects is the 'stress-energy tensor', which contains the mass-energy density of a substance and its pressure and viscosity. This tensor describes the density and flux of energy and momentum in spacetime.

A means by which to harness 'dark energy' is to reduce the 'stress-energy tensor'. This is accomplished through the use of bifilar coil configurations, which neutralizes the effect of self-induction. This, in turn, reduces the overall impedance of the coil. The bifilar coil is driven by two independent transverse pump waves as described by researcher Tom Bearden. The ferromagnetic core material used by the bifilar coil acts as a nonlinear medium or more commonly known as a Pumped Phase-Conjugate Mirror or PPCM.

Shown below in Fig. 1 is the Self-Sustaining Technology developed by AuroraTek, Inc. utilizing a PPCM. According to mainstream science ‘dark energy’ or anti-waves are a component of space and therefore, present everywhere in the universe. These anti-waves or phase-conjugated waves are time-reversed electromagnetic waves. So, along with ‘real energy’ or time forward electromagnetic waves, anti-waves, or time-reversed waves are present as well. During operation of the PPCM, when anti-waves or ‘dark energy’ comes in contact with the mirror, a transformation occurs producing time-forward electromagnetic waves. In other words, the PPCM acts as a gateway or valve transforming ‘dark energy’ to ‘real energy’. This process occurs in the low to mid-frequency range allowing ordinary power electronics to capture the real power and deliver it to a load.

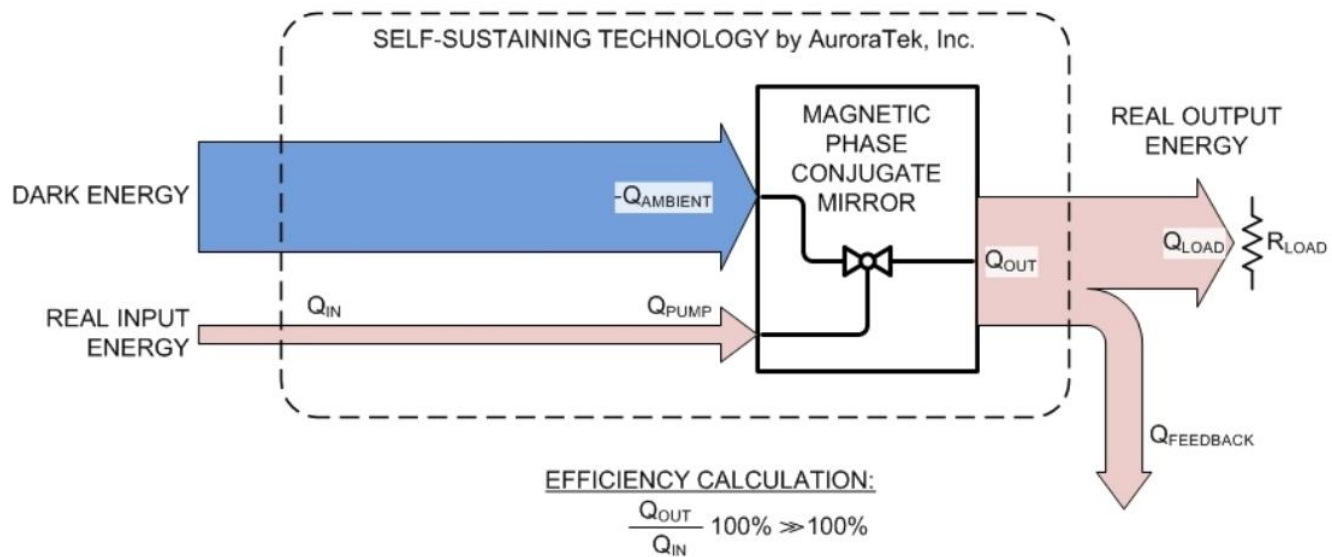

Figure 1. PPCM Developed by AuroraTek, Inc.

The PPCM is driven by two converging pump waves causing the transformation to occur and the valve to open. More energy is output than input into the system with an overall efficiency exceeding 100%. This is a clear violation of the Second Law of Thermodynamics due to the imbalance of the energy equation. However, the system is brought into balance by adding in the unseen or invisible ‘dark energy’ component – thus bringing the overall system into perfect balance. Once ‘dark energy’ is factored into equation, the Second Law of Thermodynamics is no longer being violated.

AuroraTek, Inc., a leader in Self-Sustainable Technologies, has on its bench a working prototype device that has an efficiency of 127% with a theoretical efficiency of over 3,200%. Our objective is to get this technology to the market place and change the way the world produces and utilizes energy. With this technology, “the age of burning fossil fuel” is over; “the age of dangerous fission” is over; “the age of dangerous fusion” (which never got started) is over; and “the age of alternative energy technologies” is over!

Our patent-pending intellectual property allows us to scale the technology ranging from milliwatts to megawatts of power with theoretical efficiencies exceeding 3,000%.

The market potential for our technology is enormous and worldwide in scope. In China, more than 200 million electric bikes (eBike) have been sold. There will be about 450 million electric bikes sold worldwide by 2020. Carbon dioxide emissions for a Chinese eBike are about one-tenth of what is emitted by a conventional electric car. Carbon dioxide emission using our technology – ZERO!

The market facts speak for themselves. The global wholesale level market for battery control technology was nearly \$86 billion in 2011 and should grow to more than \$124 billion (constant 2012 dollars) by 2016 under a consensus scenario, a Compound Annual Growth Rate or CAGR of 7%. Battery chargers currently represent the largest of the three (3) battery control technology market sectors, with 2011 sales of about \$48 billion. BCC expects this market to reach \$69.6 billion by 2016, a CAGR of 7.6%. They are followed by smart batteries (including both nickel metal hydride and lithium-ion), especially those used in portable products and on-road electric vehicles. Smart batteries represented a \$32 billion market in 2011, expected to grow to more than \$49 billion by 2016, a CAGR of 8.5%. Lastly, battery conditioner shipments have grown over the last 5 years. Between 2011 and 2016, global sales are predicted to grow from \$5.2 to \$5.8 billion – a CAGR of 2.2%.

AuroraTek, Inc., exhibited its self-charging electric bike for the first time at the 2014 International Consumer Electronics Show in Las Vegas, Nevada. AuroraTek's Self-Sustainable Technology called SmartPAK™ / SFT™ is attached to a self-charging electric bike (eBike) creating an integrated energy solution that NEVER, EVER requires the scooter's batteries to be charged from the 120VAC wall outlet AGAIN! The world's first FREE Energy Over-Unity (OU) device will be demonstrated at the consumer level – this has NEVER, EVER been done before.

William S. Alek is President and CEO of AuroraTek, Inc., a world leader in Self-Sustainable Technologies. He is also the Director of Research and Development and the chief architect of the SmartPAK™ / SFT™ Energy Management System. William has over 25 years work experience in electrical, computer hardware and software engineering. He has a BSEE Degree graduate of Illinois Institute of Technology, Chicago, 1979.

Sources: http://intalek.com/AuroraTekArticles/SelfSustainableTechnologyUtilizesDarkEnergy_Article.pdf
http://peswiki.com/index.php/Free_Energy_Blog:2014:01:10

Richardson Fuel-Less Electrical Generator

Two pairs of electromagnets warp a permanent bar magnet's magnetic fields back and forth across output field coils to induce a DC output voltage. Over-unity electrical energy conversion gain is achieved – the magnitude of which is unknown. This device requires additional resonant circuit components and appears to be a potentially robust generator of electricity. Dr. Thomas Bearden's motionless electromagnetic generator (see above) seems to be based on the same principle.

Combined with Richardson's bladeless steam turbine, a Volkswagen Beetle was driven around without bothering without refueling at gas stations, oil changes and tune-ups during the early 1970's.

US Patent No. 4,077,001 for Electromagnetic Converter with Stationary Variable-Reluctance Members. Inventor is Frank Richardson (deceased).

Richardson Blade-Less Tesla-Type Steam Turbine

In addition to his fuel-less electricity generator (see above), Frank Richardson also invented a blade-less Tesla-type steam turbine. The turbine has a closed-loop cycle which he claimed is far more efficient than the electric motor in terms of converting electrical energy into rotational energy for application to a vehicle's drive wheels. The water is heated with radio frequencies like a microwave oven into steam which is then forced through two disks in sequence. The two disks are perforated in such a manner as to prevent cavitation (bubbles) even at high rotational velocity.

Since steam offers a 1,000-to-1 expansion ratio compared with gasoline's expansion ratio of approximately 300 to 1, the turbine is extremely powerful. An 18-inch diameter prototype's output power was measured at approximately 1,000 horsepower. The electricity for the water heater came from the aforementioned Richardson fuel-less electrical generator.

Combining a blade-less steam turbine with his electrical generator, Richardson had built a self-powered modified beetle-shaped Volkswagen automobile which he drove around during the early 1970's without bothering with refueling at gas stations, tune-ups, oil changes, etc.

Switched Reluctance Motor

The switched reluctance motor is a motor design that has been around for many decades but has never been commercialized. Mike Windell, inventor of a Casimir effect self-charging energy cell, was also developing an efficient commercial version of the switched reluctance motor specifically designed with modern switching components. The intended end use is for powering electric vehicles. The switched reluctance motor has the key advantages of ease of manufacture, simplicity, and allowing complete vehicle motion control. No claims are being made that it is capable of over-unity power conversion.

Most self-powered electric vehicle power train concepts involve combining an over-unity motor (to extend the range between battery charges) with an on-board battery charger and a pack of batteries or super-capacitors. The Casimir effect self-charging energy cell offers some important advantages such as much simpler mounting of one to several battery-like cells in the vehicle's engine compartment and greatly increased maintainability and dependability. With the cells' self-charging capability, the efficiency of the vehicle's electric motor thus becomes less of an issue. Electric motor features such as controllability, manufacturing cost, simplicity, and reliability can thus be given much greater consideration.

This particular self-powered electric vehicle power train combination may be the best one. If plugged into the electric grid while parked in the owner's garage, the revenue from running the electric meter backwards could eventually pay for the vehicle's purchase cost.

Water-to-Energy Electrolysis Process

Ken Rasmussen and his team have been working on a water-to-energy electrolysis process that turns out to have similarities to that of Professor Kanarev. Both use a pulsed signal, and both were seeing similar performance rates. Kanarev holds multiple patents, and is widely published. Ken Rasmussen's website is www.commutefaster.com.

Nova Langmuir Engine

David Yurth's Nova Institute of Technology has developed its proprietary Nova Langmuir Engine. They have already completed much of the engineering and laboratory testing for the engine.

Clem Over-Unity Vegetable Oil Engine

Richard Clem was a heavy equipment operator who had noticed that a hot asphalt sprayer would continue to run for up to an hour even after the power was turned off! So he built a modified version as a 200-pound engine which ran on vegetable oil at 300 degrees and was started by a 12-volt battery. The heat is internally generated by the engine. During a nine-day test conducted by Bendix Corporation engineers, the engine in its self-running mode consistently generated 350 horsepower into a dynamometer. The engine is constructed from off-the-shelf components except for a hollow shaft and a custom cone with enclosed spiral channels.

If the automobile industry adopts the Clem over-unity engine, motorists could change its eight gallons of vegetable oil only every 150,000 miles and never buy any gasoline. To illustrate the engine's durability, the only working model of the Clem engine has been continually running on his son's farm for several years.

Combining the Clem over-unity engine with the hydrosonic pump could provide distilled ocean water as well as hot water for space heating, kitchens, and bathrooms at *no* energy cost.

The Clem over-unity vegetable-oil engine is not patented. It may be fairly straightforward to set up a small machine shop for manufacturing hollow shafts and cones.

Multi-chambered Rotary Compression Engine

David Yurth's Nova Institute of Technology has developed a 'Nova Neal Compression Engine'. This engine has been released as an open source project on PESWiki. It is based on the 1937 engine patented and demonstrated by Robert Neal. The proof-of-concept prototype was designed to produce 25 KW continuous output based on input from (a) air, (b) phase change gases, (c) saturated steam, and (d) other fluids demonstrating thermal values in the range of 120⁰ F – 180⁰ F.

Modified Cold Fusion Energy Cell

David Yurth's Nova Institute of Technology has developed a modified cold fusion energy cell that is based on the long-standing work of Mitchell Swartz and his colleagues. The modified cold fusion energy cell creates self-sustaining heat in a scalable configuration. When this thermionic cell is married to the aforementioned low-temperature closed cycle Freon/rotary engine, engines could be manufactured in a series of scalable configurations that never need fuel of any kind and can run till the bearings melt.

Conical Vortex Heat Exchange Engine

The proof-of-concept prototype was designed to produce 25 KW continuous output based on truncated conical vortex engine design concepts without consumption of extrinsic fuel.

David Yurth's Nova Institute of Technology has developed its 'Nova Truncated Vortex Engine'. Their engine is based on the design developed and demonstrated by Richard Clem in 1972. It converts compressed rotary motion using non-compressible oils to create usable shaft torque at 1800 – 2300 rpm.

Engine Powered by Gas with Unusual Expansion Properties

In 1995, a man named Volcheck of Grand Coulee, Washington, made a trip across the United States and back in a car powered by a special gas he developed that had unusual expansion properties. He claimed to have obtained the formula from some unpublished notes of Leonardo Da Vinci.

Volcheck says the gas expands enormously at about 395 degrees Fahrenheit to 450 pounds pressure. In other words, from approximately 390 to 395 degrees Fahrenheit, the gas expands from a volume of one unit to a volume of 10,000 units. He used this gas in a modified Franklin aircraft engine which behaved more like a steam engine. He never refueled during the trip, consuming \$10 worth of this special gas.

Liquid Electricity Engine

Richard Diggs, Custom Invention Agency, P.O. Box 11, Carthage, Missouri 64836; patent process on hold, though he has over two hundred other patents. Diggs showed at an inventors workshop (I.W. International) his "Liquid Electricity Engine" that he believed could power a large truck for 25,000 miles from a single portable unit of his electrical fuel. Liquid electricity violated a number of the well known physical laws that the inventor pointed out.

Muller Motor/Generator

Electrical generators in common use require external torque from gas, hydroelectric, and steam turbines, for example, to overcome back electromotive force. Bill Muller's magnetic motor/generator eliminates back electromotive force. The coils are removed from the rotor and instead wrapped around powerful magnets equally spaced around the stator. Magnets are also equally spaced around the rotating disk. However, the number of rotor magnets is one more than the number of stator magnets.

A typical commercial motor involves pushing and pulling magnetically where in the Muller motor/generator only the magnetic pulling effect occurs. A perfectly balanced arrangement of the magnets results in a disk-like rotor that can be turned with no effort at all. The completely reversible result is if current is applied to the stator coils, the rotor turns. If the rotor is turned, the stator coils can generate current to be supplied to a load.

The stator coils are wrapped around cores made of inexpensive Muller-patented amorphous material which eliminates heat-producing hysteresis and eddy current losses. Because of instantaneous saturation and permeability, much less wire is needed for the stator coils which greatly reduces both ohmic resistance losses and inductance losses. No brushes are needed like in conventional direct current generators and motors which wear out. Bearing friction losses are greatly reduced by both weight reduction and using Muller's cone-shaped magnetic bearings (patent applied for). Inventor is Bill Muller (deceased).

Perm-Mag Motor

An over-unity energy converter claimed to have a gain of up to several times of shaft rotational power over electrical input power, the super-efficient 'perm-mag' motor generates 1 horsepower per pound of weight. Used in a self-powered electric vehicle, a 50-pound, 50-horsepower electric motor is equivalent to a 250-horsepower gasoline-fueled engine.

The perm-mag motor's inventor, Ronald Brandt, has successfully demonstrated a 10-pound, 10-horsepower prototype. Further research is expected to lead to a substantial increase in energy conversion gain over the reported gain of 400%. A 50-pound, 50-horsepower model (equivalent to a 250-horsepower gasoline-fueled engine) is currently being mounted in a Chrysler New Yorker for testing. Its companion controller, which is required to complete the resonant circuit for achieving over-unity gain, has been designed. It is not known yet whether a separate on-board battery charger will still be needed for a completely self-powered electric vehicle. It should be noted that just because a motor can produce more mechanical power than its electrical input power does not necessarily mean that it is suitable for powering an electric vehicle. An electric vehicle motor ideally should have a number of other characteristics such as reversibility, complete variable power control, complete variable speed control, braking, and stepping. It is understood that the perm-mag motor meets all performance requirements for powering electric vehicles. It is not known how the perm-mag motor specifically compares with other types of over-unity motors.

Motive Power Generating Device

The key statement of Teruo Kawai's US Patent 5,436,518 for his 'Motive Power Generating Device' is as follows: "Electric power of 19.55 watts was applied to the electromagnets at 17 volts and 1.15 amperes. ... an output of 62.16 watt was obtained." Dividing the output power by the input power yields a coefficient of performance of 3.19.

Walden Amplified Magnetic Motor

Progress thus far on the Walden Amplified Magnetic Motor (WAMM) has been accomplished on a shoestring budget and with volunteer personnel.

The project has progressed from its basic concept, simulations and patent work to a demonstrable auto-rotating prototype which runs on input power for its control electronics, but where all torque and rotational motion is provided by the permanent magnets on the rotor and stator.

Having proved the concept, further phases of development of the WAMM will require phased project funding to continue to a fully developed and marketable product.

PHASE ONE (Completed):

In the last year and a half, the WAMM concept by the Founder, Michael K. Walden, has completed a patent application and gone through a few iterations until the most easily produced model was selected. This model uses permanent magnets of the same type and model generating force *only* from the change in distance between the rotor magnets and the stator poles. There is no difference in magnetic force between the rows of the rotor magnets to increase torque on this model. The "Permanent Magnet Motion Amplified Motor and Control System" patent application can be accessed at

www.google.com/patents/about/12_478_550_Permanent_Magnet_Motion_Ampli.html?id=v17IAAAAEBAJ.

Its abstract is copied as follows:

A permanent magnet motor operated by the magnetic interaction between two or more permanent magnets, and a control system therefore, is provided. The permanent magnet motor may be a piston motor having a magnetic piston assembly mounted on a crank shaft, and a rotatable cam shaft having a cam magnet corresponding to the piston assembly. When the cam shaft rotates about an axis, the poles of the cam magnet alternately face the adjacent magnetic pole of the corresponding piston magnet. The magnetic field interactions between the piston magnet and the cam magnet cause the piston to reciprocate within the cylinder. The permanent magnet motor may also be a rotary motor comprising a rotor having a plurality of rotor magnets, and a stator having a stator magnet. A stator motor drives the stator causing the rotor to rotate in response to alternating interactions between magnetic fields of the stator magnet and rotor magnets. A vehicle comprising a permanent magnet motor is also disclosed.

(End of abstract)

The current prototype uses two volts and eight milliamps for input to a basic stamp control board, activation light-emitting diode, and an actuator that moves the stator away from the rotor at the point at which it passes the “V-Gate”.

This prototype is a single rotor/stator demonstrator and shows a complete version of the basic concept in operation. It does not yet have sufficient torque to run an electrical load equal to the input. It is however, an electrical motor with extreme efficiency, capable of running on much lower power input, between 2% and 5%, of a comparable standard electrical motor that uses input power to activate field coils or armature windings.

The next phases of development of the WAMM will increase torque and output power while still minimizing input to the control system.

PHASE TWO (Pending funding):

Mr. Walden and his team have developed several methods of increasing the output power of the demonstrator device.

The first is to multiply the number of rotor/stators on a single common shaft with the ‘V-Gates’ offset so that only ONE gate stator actuator is activated at any time. The team has a number of rotors, but funding will be required to purchase additional control electronics and program them to work together as a common unit. Machining of mounting tabs for these additional control systems will also be required.

Another method is to increase the width of the rotors. This will increase the width of the magnetic ‘V’, increasing the difference between the rows of the rotor magnets in relationship to the stator poles. This method would involve machining new rotors and mount base plates.

Another method would be to purchase new rotor magnets that ‘STEP’ their power by a given amount per row around the rotor. For example, if the first row has two pounds of force then the second row would have three pounds of force at the same distance. The third row would have four pounds of force, etc., around the rotor. This will increase the magnetic force *between rows* and so, increase torque as both magnetic force and magnetic distance between the rotor and stator change with rotation.

The current plan is to first combine the existing auto rotating demonstrator with an additional rotor and control equipment. This would be the fastest method of developing additional output and would also demonstrate that no additional input power is required, only the frequency of activation would change.

Once this is shown, then the 'Magnetic Step' of the rotor magnets can be implemented to further increase the output torque and power of the demonstrator. This will require the selection, ordering and purchase of new rotor magnets and machining/dynamic balancing of the rotors to mount them.

PHASE THREE (Pending success and funding of phase two):

Once the maximum amount of output power and torque is developed per rotor in Phase Two, the number of rotors necessary to develop sufficient power to run the control electronics independently will be established. As shown in the concept drawing of a complete 36 rotor WAMM unit (not shown), it is estimated that such a unit can easily produce a continuous power output to run the pulsed input to the control equipment and actuators.

This unit will then be scaled per market requirement.

Funding is required to produce the needed number of rotor/stator/actuator and control modules and power system / case to complete the first few demonstrator units and do a complete testing program.

Super magnets developed by laboratories at Arzamas-16 in Khazakstan and the IPMS-Kiev (see above) have energy characteristics equal to or exceeding those of the best conventional iron-boron-neodymium types, but with the all-important feature that they operate with equal or greater efficiency at extremely high temperatures, up to 250 degrees centigrade. Super magnets ought to increase the WAMM's torque and power.

The Walden amplified magnetic motor offers all the motive power characteristics needed for electric vehicles such as reversibility, complete variable power control, complete variable speed control, braking, and stepping.

Orgone Energy Motor

In the mid 1930s Wilhelm Reich, MD, began noticing an energetic connection that is shared by all living beings and had the clarity of mind to not dismiss the observation as unimportant. Dr. Reich called this energy "orgone" and worked for decades demonstrating its laws and studying its various manifestations.

Dr. Reich in 1948 built a "synchro" type of electrical spinner motor to run from both an orgone energy accumulator and an orgone-charged high-vacuum tube. James DeMeo and Nicholas Reiter have each written an article on the orgone energy motor construction and use, with eyewitness quotes and many construction details. DeMeo has also published a third article on the subject of electrostatic motors, which are powered by sources bearing some resemblance to what Reich used in conjunction with the orgone accumulator.

James DeMeo's "Orgone Energy Accumulator Handbook" has on its cover a spectacular photograph of an astronaut on the moon with a blue halo around his spacesuit (http://www.amazon.com/Orgone-Accumulator-Handbook-Construction-Experimental/dp/0962185507/ref=sr_1_3?s=books&ie=UTF8&qid=1327935772&sr=1-3). The astronaut's blue halo is thought to be a visible manifestation of orgone energy.

(Sources: Emails from James DeMeo, <http://www.proliberty.com/observer/20030310.htm>, <http://www.orgonelab.org/cgi-bin/shop.pl/page=xpulse.htm>, <http://www.orgonelab.org/cart/xpulse.htm>, and http://pw1.netcom.com/~rogermw/Reich/orgone_motors.html.)

Torsion Field Radio

Most drivers become annoyed when a radio station's signal weakens under overpasses, etc. The theoretical maximum capacity of torsion field communications is apparently 40 billion channels of radio and television through the entire earth without attenuation at a speed of one billion times the speed of light. A radio station using the torsion field for its medium of communicating could have its signal picked up anywhere in the world without dropouts. A torsion field radio station could broadcast directly from its studio without the expense and energy cost of sending its signal up to a radio signal transmitting tower. The reduced cost of radio broadcasting would hopefully reduce the need to generate revenue with commercials.

See "Space Travel Innovations" in www.padrak.com/vesperman or www.commutefaster.com/vesperman.html. For more on the crystalline lattice structure that makes possible torsion field communications see the above chapter "Advanced Solar Photo-Voltaic Crystal Lattice Cells" and the chapter below "Torsion Field Energy Applications".

IPMS Thermal Electric Cooling Devices

The I.N. Frantsevich Institute for Problems of Materials Science (IPMS) was established in Kiev, Ukraine in 1951. It operated in absolute secrecy and was totally unknown to the American intelligence community until just prior to the implosion of the Soviet Union in August of 1991. The mission of the Institute was to use whatever tools or means were necessary to know everything there is to know about materials. They had no production deadlines to contend with, and there was not a single applications engineer in the entire organization.

The 6600 scientists and technicians who worked in the Institute developed an entirely new model of nonlinear quantum mechanics to describe the forces which make the world we live in behave as it does. This new model suggests that the material world is substantially different from the world described by the models relied on in the West. Seven new sciences, twenty-seven new technologies, and one hundred thirty previously unknown materials developed in the Institute are based on the same revolutionary new model of quantum mechanics.

Research and development in the deposition and culture of layered crystal lattices has produced an entirely new class of materials, previously unknown to Western science. These are referred to in recently submitted patent application documents as "Thermal Electric Cooling Devices". Because of the nature and function of a specially designed combination of crystal layered "hosts" and their intercalated "guest" materials, these specially designed capacitors actually absorb energy when subjected to a flow of electrical current, producing a specific cooling effect on the material surfaces. All other known materials produce heat when subjected to the same conditions. Temperatures of 60 degrees Kelvin (-259 degrees Fahrenheit) have been produced under controlled, carefully documented laboratory conditions. This is cold enough to liquefy free-standing nitrogen gas from the atmosphere.

The potential applications such as vehicle air-conditioning for this technology are manifold, but perhaps the most important is the potential it provides to totally eliminate any need for the use of compressed fluorocarbons of all types in refrigeration. Parallel applications in the telecommunications, computer and electronics industries have also been demonstrated to be highly effective and cost efficient, particularly as they relate to the use of super-conductive materials.

(Source: David G. Yurth, *The Anthropos Files: Tales of Quantum Physics from Another World – 2nd Edition*, 2007)

Cool Chips Thermo-Ionic Refrigerator

The solid-state Cool Chips™ thermo-ionic refrigerator, <http://www.coolchips.gi/>, represents a new development for cooling, refrigeration, and thermal management. One of the first industrial applications of nanotechnology, Cool Chips use thermionic technology to deliver up to a projected 55% of the maximum (Carnot) theoretical efficiency for heat pumps. Conventional refrigerators operate at up to 45% efficiency and current thermoelectric systems (Peltier effect) operate at 5-8% efficiency.

Cool Chips use electrons to carry heat from one side of a vacuum diode to the other. The system contains no moving parts or motors. It can be miniaturized for use in localized microelectronic applications, including cooling microprocessors to enable faster computers. In almost every electronics cooling application, an active cooling system powered by Cool Chips technology will be superior to the more conventional passive solutions. Cool Chips automotive applications include 6 to 8 kilowatts air conditioning systems, 1+ kilowatt cooling electronics packages, and +1 kilowatt passenger amenities. Automotive applications benefits include increased fuel efficiency and precise temperature control.

Cool Chips are highly efficient devices. 70% Carnot means a coefficient of performance of 3.8 @ 50 degrees C delta-T (the best compressors achieve 2.5). At 40 degrees C delta-T, the Cool Chip achieves a coefficient of performance of 4.8, compared to 3 for the best compressors. Cool Chips offer a lightweight, low-volume solution to a wide variety of cooling problems.

Enabling greater design flexibility, cooling devices with embedded Cool Chips can be positioned anywhere in a vehicle. Cool Chips are compatible with 42 volts DC systems. Additional automotive amenities are enabled including flexibly located on-board refrigerator/freezer and food warmers, individual drink coolers/heaters, and efficient and inexpensive seat cooling and heating.

Cool Chips is a semiconductor chip-based technology with precise but simple construction. It only requires non-exotic materials with moderate contamination tolerance. No costly materials are involved in manufacturing processes. Very small devices require small amounts of material. The marginal cost of Cool Chips in production could be as low as pennies per watt capacity. In addition to high efficiency, Cool Chips are expected to be very inexpensive to make.

A number of factors come into play when estimating the cost of a product like a turbine or a compressor. The marginal costs (the cost of making one more unit on an already-present assembly line), are heavily dependent on the following factors:

Materials quantity No device can cost less than its parts. And big, heavy machines like turbines and compressors have a lot of steel, copper and iron in them. This is an unavoidable cost. Cool Chips use very little in the way of raw materials – at least an order of magnitude less than the competition. A single chip, capable of 100 watts of cooling, will measure less than 1 cm on a side, and be only a few millimeters thick.

Material quality As machines improve, the specifications for their components become ever more demanding. If the components must be of very high materials purity, a significant cost is added. This cost, unlike, say economies of scale, is not reduced easily. The price of 99% pure iron is far less than 99.9999% pure iron. Cool Chips can use relatively impure materials.

Machining/assembly costs The more welding, bonding, sealing, etc. which is required, the higher the costs as well. Cool Chips are extremely simple to manufacture – much less complicated than an Intel 386 processor, for example.

Component costs The more pieces that have to be put together, the more it will cost. Cool Chips have a very small component count – much less than competing technologies.

Compressed Air-Driven Air Conditioner/Heater

Alvin Snaper's compressed air-driven air conditioner/heater (US Patent No. 4,407,134 for Air Conditioning System. Alvin A. Snaper, Las Vegas, Nevada) relies on the principle of a vortex tube. Air whirled in a vortex tube separates with the cold air molecules collecting in one portion of the tube, and the warm air molecules collecting in another portion of the tube. The cold air is expelled from one end of the tube, and the warm air is expelled from the other end. It can be switched between providing 90% cold air and 10% warm air, or 10% cold air and 90% warm air.

The metal tube is about a foot long and a half-inch in diameter with a two-inch long compressed air intake tube perpendicularly attached about three inches from one end. The intake compressed air requirement specifications are 7 cubic feet per minute at a pressure of 40 pounds per square inch. The volume of air expelled is twice that of a refrigerant-type automobile air conditioner while requiring only one-fourth the horsepower. Also, no warm-up period is required as with conventional air conditioners or heaters. Its laboratory-certified efficiency is nearly 30%. The Author has seen during demonstrations conducted in inventor Snaper's garage on a hot Las Vegas summer day temperature measurements of the air blowing out of the cold end at around 0 degrees Fahrenheit.

While the patent on the compressed air-driven air conditioner/heater has recently expired, it is still available for commercialization. Combined with an on-board battery charger, the advanced self-powered electric vehicle would be able to offer the exceptionally nice feature of continuous climate control, even while parked! Parked on a cold winter day, the interior of the vehicle would always be toasty warm. On a hot summer day, the parked vehicle's interior would always be refreshingly cool.

Low-Temperature Diamond or Titanium Nitride Coating of Vehicle Parts

Durability would be enhanced by nondestructively coating numerous parts such as shock absorbers with diamond or titanium nitride using Alvin Snaper's new low-temperature coating process (US Patent No. 5,254,237 for Plasma Arc Apparatus for Producing Diamond Semiconductor Devices). The diamond deposition system and process can also be used to manufacture diamond-based semiconductor devices. A multiple gun plasma arc deposition system allows controlled deposition of diamond and other diamond-like materials such as titanium nitride on a substrate. Deposition is controlled by controlling the time duration of pulses to a main gun, an acceptor gun and donor gun in a vacuum chamber that may contain a small amount of hydrogen. The deposition process is also enhanced with microwave temperature control and substrate dithering with a transducer.

Advanced Computer-Controlled Suspension Systems

Computer-controlled hydraulic shock absorbers as well as the computer-controlled air ride suspension system would be supplied by Aimrite Systems International, Inc., which owns the patents. Aimrite's Computer-Optimized Adaptive Suspension Technology (COAST) system replaces a vehicle's conventional shock absorbers with specially designed hydraulic shock absorbers. The COAST system utilizes a sophisticated computer and position sensors to monitor the vehicle's level at each corner. The computer's microprocessor checks the sensors 240 times per second and optimally regulates the damping on all four shocks based on this input. The firmware used in the microprocessor is patented and represents the most important element in the

COAST system. It controls nine dynamic and static parameters of motion (roll, pitch, sprung natural frequency, unsprung natural frequency, pumping down, stored energy, topping out, bottoming out, and height).

The COAST system is not only totally automatic, but it monitors and controls the vehicle's ride performance on a continuous basis providing soft and stable ride characteristics at all times as needed. The ride is comparable to active systems without the need for pumps nor expensive high-speed servo-valves.

Each shock absorber is actually a complementary pair of shock absorbers mounted in opposing vertical compression/rebound modes. The computer sends signals to valves to release pressure as required. Aimrite considers its shock absorbers more durable and react faster than competing computer-controlled shock absorbers which apply pressure when needed. A built-in safety factor is that if the computer fails, the result is conventional damper operation, and failure of an individual damper is equivalent to failure of a conventional shock absorber.

Aimrite's air ride suspension system replaces a vehicle's front coil springs and rear leaf springs. The air suspension comprises of a high-quality control subsystem that includes the aforementioned dual redundant air compressors, air dryers and filters, position sensors, computer-controlled solenoid valves, and a dashboard-mounted control to ensure proper operation and a long and reliable life of the air suspension in all weather and driving conditions. While stopped or driving, the control subsystem allows the operator to easily maintain the correct ride height under all loading conditions. For example, the chassis can be raised for a bumpy ride and lowered for stable highway driving. The vehicle body is automatically leveled at all four corners, even when parked on an uneven surface.

Aimrite's suspension provides a full air suspension ride, with increased comfort and control. Built-in safety capabilities are provided that virtually eliminate traditional problems associated with air ride suspension systems.

Nevada Small Corporate Offering Registration 1993 for Aimrite Systems International, Inc.

US Patent No. 5,056,811 for Actively Controlled Automotive Suspension System with Adjustable Rolling-Stability and/or Pitching-Stability. US Patent No. 5,735,372 for Variable Constant Force Hydraulic Components and Systems. US Patent No. 4,634,142 for Computer Optimized Adaptive Suspension System. US Patent No. 4,722,548 for Computer Optimized Adaptive Suspension System having Combined Shock Absorber/Air Spring Unit. US Patent No. 4,468,739 for Computer Optimized Adaptive Suspension System having Combined Shock Absorber/Air Spring Unit. US Patent No. 4,468,050 for Computer Optimized Adaptive Suspension System. US Patent No. 5,529,152 for Variable Constant Force Hydraulic Components and Systems. All invented by James M. Hamilton, Solana Beach, California and Lonnie K. Woods, Jacumba, California. US Patent No. 4,651,838 for Air Spring Control System and Method. US Patent 4,783,089 for Air Spring Control System and Method. All invented by James M. Hamilton, Solana Beach, California, Lonnie K. Woods, Jacumba, California, and Michael W. Godwin, San Diego, California.

Combining Aimrite's two computer-controlled adaptive suspension systems would offer a luxurious ride with sports-car control and additional features at a reasonable price.

The air conditioner/heater as well as the air-ride suspension both require compressed air. There has been some talk of using compressed air also for other vehicle applications such as tubular frame members, windshield wiper motors, etc.

IPMS High-Temperature Gas Plasma Detonator

Since its establishment in 1951, the I. N. Frantsevich Institute for Problems of Materials Science (IPMS), Kiev, Ukraine, has been secretly developing, testing and producing more than 130 new materials in 30 general materials categories. IPMS scientists have developed a whole new science based on their unique model of plasma physics. With their invention of a high-temperature gas plasma detonator, strategic metals and other commonly used materials can literally be sprayed onto the surface of other, previously incompatible materials. These gas plasma detonation spray technologies make it possible to create permanent molecular bonds between materials which could never be married together before.

Chromium materials of an entirely new type have been developed to provide high-purity cathodes and targets. Moldable, flexible chromium (a type of material never before available) can now literally be sprayed to conform to widely varying shapes for linings (i.e., to reduce internal pipe corrosion), provide nuclear rod protection, and highly effective space hardening. These techniques have been perfected and used in practical field applications for more than 35 years.

The unique nature of these technologies may not be readily apparent to those not intimately familiar with the commercial and industrial uses of such materials. In more ordinary applications, however, the importance of being able to provide solid targets, stand-alone ingots of ultra-pure chromium, scandium, magnesium and other exotic materials, cannot be overstated. Today, the state-of-the-art in the West only allows chromium, for example, to be transported and used while in solution with other highly toxic liquids. Western scientists do not have the ability to produce free-standing ingots of any of these materials. The manufacturing models which rely on Western science make it clear that it is not theoretically possible for such materials to be produced in a free-standing form.

Similar materials coupled with the technologies of high-temperature gas plasma detonation have been developed for coating internal combustion engine parts to extend life cycle. They have been applied to enhance the performance characteristics of memory elements for computers and to support an extraordinary variety of totally new electronic circuitry. This technology has been successfully used to produce computer circuit boards whose operating components are intrinsic to the circuitry, thereby eliminating the utility or need for soldering or pin housings. The use of scandium, a very rare and exotic element available only in the Carpathian Mountains of Ukraine, make much of this possible in ways not anticipated by Western science.

IPMS-Kiev scientists have developed a series of diamond and cubic boron nitride powders which are smaller and more uniform than any other manufactured today. Also available in this family of materials are very fine (sometimes mono-molecular) ultra-high purity powders and liquids of refractory metals including chromium, vanadium, tungsten, scandium and molybdenum. These powders can literally be sprayed as a plasma field to form continuous, seamless, flexible molecular bonds with host surfaces without electrolytic processes. These materials demonstrate clearly superior performance in tool hardening, cutting edge equipment and polishing.

IPMS-Chernovitsky scientists have developed an entire family of previously unknown technologies based on woven fibers made entirely of 100% pure basalt fibers (lava rock). This totally new technology allows for the production of flexible, weave-able threads. These fibers are fundamentally resistant to heat, demonstrating a softening point in excess of 800 degrees centigrade. Fibers of this material have been produced in diameters of less than 3 microns (millionths of a meter), more than 10 times smaller than a human hair.

Allied Signal Corporation in the United States has attempted unsuccessfully for more than twenty-five years to produce a single fiber of a similar type material. Today, the Ukraine has the capacity to produce these raw fibers at the astronomical rate of 100 tons per month.

These materials are currently being produced in applications involving brake shoes and clutch plates with extraordinary performance characteristics. These materials sustain only about 15% of the wear currently attributed to asbestos-based materials used in identical applications, with the added advantage that they are environmentally friendly (non-toxic and non-polluting). In current applications, parts fabricated of basalt fibers actually operate at higher efficiencies as surface temperatures are increased, up to operating temperatures exceeding 800 degrees Centigrade.

Basalt fiber materials have also been shown to demonstrate superior insulating capabilities over commercially available materials in applications involving both temperature and sound. They have been used in applications related to mine roofing, trays of water cooling systems and as both gas and fluid filters. A four-inch deep pile of 5-micron filaments has been shown to demonstrate heat insulating properties in excess of R-65, which is nearly four times the efficiency of glass fiber equivalents, at one-half the weight.

Further, basalt fibers have been woven together with threads of tungsten, chromium and other strategic metals to produce cloth materials with previously unheard of characteristics. Woven metallic threads and fabrics of this type have never before been produced anywhere in the world.

The Author has included in his "Advanced Self-Powered Electric Vehicle Concept" (see <http://www.padrak.com/vesperman>) a monocoque (unibody) basalt/carbon fiber foam body/frame. The IPMS-manufactured basalt/carbon fiber foam is extremely strong yet lighter than fiberglass. A test vehicle made with basalt/carbon fiber foam parts was reportedly the only vehicle ever tested that can cut through a cast-iron London taxicab in a collision.

To utilize this technology to create an automobile enclosure, three technologies are needed:

1. The basalt fiber technology can only be found at the IPMS. There may still exist some spools of the stuff in or around Kiev. The principal value of the material is that it has a softening temperature of 805 degrees centigrade.
2. The Russians use powdered metallurgy to alloy their strategic metals – the ideal mix of metal powders would be aluminum and magnesium. Since both can be found in finely particulated powders and when mixed together in the right ratios, these two metals form a material which is utterly resistive to corrosion and which has excellent tensile strength.
3. The powdered metals are mixed in a chamber like dry cake mix and then applied using a third technology – in IPMS documents, this technology is referred to as a "High-Temperature Gas Plasma Detonator". The metal powder is poured into a ceramic container, which funnels it into a specially designed high-temperature containment vessel which is also surrounded by super magnets (see IPMS-Kiev and Arzamas-16: Super Magnets elsewhere in this electrical energy innovations compilation) and arranged in a very precise order to create a compressive effect. When the powdered metal is brought into the chamber, high voltage, high pressure and extreme magnetic fields reduce the metal powder to plasma, which is then expelled through a nozzle and onto a target – in this case, the woven basalt fiber which creates the shape of the vehicle.

When the metallic plasma collides with the basalt fiber material, it has a temperature of about 1600 degrees centigrade. This causes the basalt fibers to soften and partially melt – but the cooling gradient for this material is so steep that it cools almost immediately below 800 degrees centigrade, at which point the fibers reconstitute. This creates a basalt fiber-reinforced metal-alloyed shell which is extremely strong, very light weight and can be polished to a high sheen.

This is the technology the Russians have used for 35 years to create fuel cells for their huge rocket boosters – and it is the reason their boosters are so light, have no gaskets or seams and can be reused over and over again.

It is primarily because of their extensive use of these integrated technologies that the Soviet space program has been able to consistently deliver larger payloads into orbit than any other nation since the space race began in 1957.

(Source: David G. Yurth, *The Anthropos Files: Tales of Quantum Physics from Another World – 2nd Edition*, 2007)

BATTERIES/ENERGY ACCUMULATORS

Quantum High Energy Density Storage or Retrieval Device

Essentially a very thin battery, the solid-state Quantum High Energy Density Storage or Retrieval device (QUENSOR™) has an energy density of about 1-15 kilowatt-hours/kilogram, which is comparable to gasoline, or more. A fundamentally new principle and a new method of manufacture are employed.

Electric energy is stored or retrieved from quantum dipole electric fields throughout the volume of the QUENSOR™ film. Electric energy is stored in the QUENSOR™ film by charging the dipole electric fields from an electric energy source. Electric energy is retrieved from a QUENSOR™ film by discharging the dipole electric fields and supplying the energy to a load. Electric breakdown in the film is avoided because positive and negative electric charges in the film are balanced everywhere. Busbars attached to metal layers are connected to terminals for charging or discharging the QUENSOR™ film.

A composite photovoltaic LUMELOID™ and QUENSOR™ panel may be used for the storage or retrieval of solar-electric energy day or night on demand.

Eight patents protecting the LUMELOID™, LEPCON™, and QUENSOR™ technologies have been issued, and additional patent applications have been filed. Inventor is Alvin Marks.

Casimir Effect Self-Charging Energy Cell

The force of gravity is sometimes described by physicists as the ether weakly pushing two objects such as a book and the earth into each other's shadow. Gravity can also be thought of as the long-range version of the Casimir effect. The Casimir effect predicts that two metal plates close together will attract each other.

Consider the plates set at a certain distance apart. In the space between the plates, only those ether (vacuum) field fluctuations for which a whole number of half-waves just spans the distance can exist, just like waves formed by shaking a rope tied at both ends. Outside the plates, the fluctuations can have many more values because there is space. The number of modes outside the plates, all of which carry energy and momentum, is greater than those inside. This imbalance pushes the plates together.

The proprietary Casimir effect self-charging energy cell contains many extremely thin layers of carbon, magnesium, chromium oxide, and a couple of other elements and compounds. The result is analogous to a boat that has some rather large leaks. More water pours into the boat as fast as water is bailed out. Likewise, as electromagnetic energy is drawn out of the Casimir effect self-charging energy cell when inserted in an electrical circuit, energy is drawn in from the surrounding ether. Physically and functionally, the Casimir effect energy cell is like a solid-state battery that recharges itself with some valuable features such as simplicity and compactness. Inventor is Mike Windell.

Inventor Matt Schadeck has developed a similar Casimir-effect energy cell.

Bedini Battery Charger

Audio engineer John Bedini has been experimenting with a rotary magnetic device that recharges batteries. Sometimes “dead” batteries can even be brought back to life and recharged. Specific details are proprietary. At the 2011 Renaissance Charge Free Energy Conference, a Bedini battery charger was demonstrated by electrically powering a boat on a lake with unusually high efficiency. See Jeane Manning’s report at <http://www.jeanemanning.com/> (enter Bedini in the website’s Search box in its upper right) and conference organizer Rick Friedrich’s report at http://tech.groups.yahoo.com/group/Bedini_Monopole3/message/17005.

Catalyst Induced Hydrino Transition Cell

The Catalyst Induced Hydrino Transition (CIHT) cell generates electricity directly from hydrogen. But, unlike a conventional hydrogen fuel cell, the CIHT cell’s manufacturing cost is forecast at \$25 per kilowatt compared to thousands of dollars per kilowatt for a fuel cell. This is in part due to the CIHT cell’s electrical energy released per hydrogen being over 200 times greater, and the CIHT materials being inexpensive. Moreover, fuel cells can’t use water as the source of hydrogen, since their product is water. For CIHT, no fuel infrastructure is required to provide on-site power allowing the CIHT cell to be autonomous.

Reactions occur at both the anode (negative electrode) and cathode (positive electrode) that cause ions to flow through the electrolyte (ion conductive medium between the electrodes) and electrons to flow in the external circuit such that the overall result is the formation of some hydrinos from hydrogen of the reactants. No extreme conditions nor precious or exotic materials are needed. Less than 1% of the electrical energy gain is needed to electrolyze the water for producing the hydrogen fuel.

Essentially all power sources of all sizes – thermal, electrical, marine, rail, aviation, aerospace, as well as automotive sources – become untethered from an electrical distribution or fuel infrastructure and are also independent of the sun, wind, or other external variable power sources. The projected capital cost is only \$25 per kilowatt of electricity generation capacity – very competitive to nuclear power’s capital costs of \$5,000 per kilowatt, windmill capital costs of \$4,000 per kilowatt, etc.

A CIHT electric car is expected to have a range of 1500 miles on a liter of water, or 2500 miles with a 20-liter, 100 atmospheres of pressure hydrogen tank. The weight of the power train would be about half the weight of an internal combustion engine. The projected 200-kilowatt (267 horsepower) CIHT stack cost is \$4,600, and \$9600 for the entire electric drive system. This direct application of BlackLight Power’s process to motive power has the potential of unsurpassed capability in terms of range, capital cost, power, logistics, and pollution abatement to zero, including zero carbon dioxide emission. The inventor is Randall L. Mills, M.D. For more details see www.blacklightpower.com.

Maxwell Technologies Ultra-Capacitor

Since there is no heat nor waste product buildup as with electrochemical batteries, ultra-capacitors can easily last many hundreds of thousands of extremely rapid and deep charge/discharge cycles. They can supply repeated bursts of power for fractions of a second to several minutes. They are especially useful for supercharging power for accelerations or climbing. With their quick recharge capability, ultra-capacitors can

easily capture regenerative braking energy, extending the range of the vehicle. For increased safety, they can be stored, assembled, maintained, and transported while completely discharged. Since the energy stored is directly related to the voltage, the amount of available energy can be easily monitored. This precision eliminates the need for sophisticated state-of-charge algorithms. Other advantages include temperature insensitivity and low maintenance.

Capacitors are inherently more capable than electrochemical batteries of withstanding quick discharges of electricity to the motor when the driver demands high acceleration by stepping on the throttle. It is conceivable that ultra-capacitors could be combined with batteries to take advantage of the best performance characteristics of both types.

Maxwell Technologies' commercially available PowerCache™ ultra-capacitors pack up to 100 times the energy of conventional capacitors and can deliver ten times the power of ordinary batteries. Their ultra-capacitor is a double-layer capacitor incorporating a unique metal/carbon electrode and an advanced non-aqueous electrolytic solution. As a potential is applied across the terminals, ions migrate to the high-surface-area electrodes. The combination of available surface area and proximity to the current collector provide an ultra-high capacitance for this electrostatic process.

IPMS Crystal Lattice Energy Storage/Battery Device

During the summer of 1984, airborne intelligence surveillance teams of the United States Air Force, operating out of specially configured and equipped Boeing 707 airframes (called AWAC's) electronically detected (and then shortly thereafter photographed) bursts of coherent light of enormous power originating in the vicinity of Dushambe, Turkministan. The bursts of light, a brilliant blue-green color, lasted just a few seconds and were shifted almost to the ultraviolet end of the light spectrum. The "laser" beams were directed upwards out of the atmosphere towards American military communications satellites.

At precisely the same time the AWAC's detected and photographed the laser bursts (they were referred to in that jargon by American military analysts but later proved to be something almost entirely different), several of the satellites essential to America's global military command and control communications systems became inexplicably inoperable.

The Defense Intelligence Agency, under the direction of the National Security Council and assisted by the National Security Agency, escalated its surveillance of the remote site in the Ural Mountains from which the bursts first originated. For several months, during a concerted campaign of uninterrupted observation by AWAC's and American spy satellites, no additional bursts were observed or reported. Then, without warning, in the middle of the night nearly seven months later, AWAC's crews operating just outside the territorial airspace of Afghanistan detected similar laser bursts of lower intensity during a period of intensive localized ground warfare.

The Afghanistan bursts were apparently aimed at targets under attack by Soviet infantry units. The laser bursts continued in a sustained, localized but obviously mobile attack pattern, as frequently as four or five times per hour, until nearly sunset of the next day. Photographic evidence gathered at the time by the AWAC's crew, and later corroborated by photographs taken at the actual site of the fire fight and forwarded to the U.S. for analysis, showed that the targets of the laser bursts were ammunition and fuel supply depots located in the remote desert. Several of the ammunition and fuel caches had apparently been destroyed during the attack, as demonstrated by the evidence of explosions, fire, smoke and residual infra-red heat patterns detected, photographed and electronically recorded on-board the AWAC's.

All this information was transmitted (via encrypted communications bursts, routed through the military Global Command Control satellite system) to the National Security Agency (NSA), located at Fort Meade, Maryland. Analysts there recognized that they were looking at evidence of a weapons system which had never been observed before. They did not know what had produced the laser bursts. But they did know that the technology which made such a thing possible was not available to the countries participating in the NATO Convention. They were terrified at the implications of such a development.

Within hours, the information was packaged into classified documents and conveyed to the Joint Chiefs of Staff. The Joint Chiefs examined the information while they were being briefed by the AWAC's crews which had witnessed and recorded the events. After the briefing, the crews were dismantled, and their various members stationed far away from one another, with orders never to discuss the events they had witnessed. Officially, the laser bursts never had occurred.

Secretary of Defense Frank Carlucci took delivery of the packet at his residence in Falls Church, Virginia, three days later, at a private, secret meeting held in the middle of the night. No one has yet adequately explained why the Joint Chiefs waited three full days to brief the Secretary. Early the next morning, he was driven in a specially prepared bulletproof limousine to the White House. He personally delivered the information to the new President of the United States, Ronald Reagan. The content of the Secretary's report had an immediate, measurable impact.

It was this series of events which principally precipitated the Strategic Defense Initiative (SDI), a program of military defense and reprisal based on America's state-of-the-art satellite-borne laser-optical and particle accelerator technologies. The SDI system was intended to provide the U.S. with a meaningful deterrent to further aggressive use of the technology developed by the Soviet Military.

There was only one problem with this system, aside from the fact that its astronomical costs almost bankrupted the American economy: It did not work. SDI was designed to respond to a kind of technology which was not achievable in the West, and which could not be explained by any of the models, materials, technologies or sciences known in the West.

In 1985, the top-secret military version of the space shuttle, code named Atlantis, embarked on a special orbital mission. One of its mission assignments was to retrieve, examine or photograph the military spy satellites which had been disabled by the laser bursts recorded in 1979-84. The results of this investigation have not been declassified or released in any but the most censored version to the public. What we do know for certain, as a matter of publicly available non-classified information, however, is that each of the disabled satellites appeared to have had at least one, and in some cases as many as four or five precisely measured holes, approximately the size of an American silver dollar, melted completely through them from the outside.

The photographs taken of the satellites show evidence of intense heat, charring and carbonized residue evenly distributed around the perimeter of each hole. The evidence is clear and unmistakable – the satellites were disabled by a coherent beam of some sort, characterized by such intense energy that it was possible to melt consistently measured holes through the exterior and interior components of American military satellites, after having passed through the atmosphere of the planet and into space for as many as 325 miles. Such a thing has scarcely been dreamed of by the American military, much less put into any but the most nominally effective operational form.

After more than ten years of political, economic and technological wrangling, and after the expenditure of more than one hundred twenty billion dollars in largely ineffectual research and development efforts, it is inescapably clear that no amount of money or political pressure, no amount of geo-political posturing or economic sanctions was going to compel the disclosure or replication of the technologies which produced the results photographed

over the Carpathian Mountains and the Afghanistan deserts. The Soviets had developed a weapons system which was so revolutionary that it could not be explained, replicated or defended against.

The Reagan Administration's lack of specificity about the nature of the implied threat to which the SDI was supposed to respond subjected the Administration, the Defense Department and the R & D proponents of the most prominent American aerospace corporations to an endless barrage of charges by the press and the Congress. They were characterized as being disingenuous and accused of being unreasonably secretive during successive appropriations battles in the Congress.

The truth of matter is that the Reagan Administration and the Pentagon were not being disingenuous at all. They simply could not admit to the American public that they were attempting to develop an effective response to a weapons system which they did not understand and could not replicate.

There are a number of issues intrinsic to this set of circumstances, along with several dozen others which, though less well known or economically dramatic, are no less important from a technological standpoint. It is certain that the implication of these technologies has not been lost on those multi-national corporations whose entire capital structure may be threatened by the new sciences, technologies and materials which have been developed in secret laboratories, hidden in caverns excavated beneath the Carpathian Mountains, in the former Soviet Union.

Over the past decade the West has enjoyed occasional gratuitous glimpses into the heart of Soviet science. Attempts to disclose or discuss these developments in the press have been ruthlessly suppressed by powerful special interests vested in both the public and private sectors.

The science which underlies the series of events recounted here remains at the outer limits of the most advanced technology of which the West is capable. The questions posed by the military and corporate analysts about this laser beam weapons system are far-reaching in their scope and implications. Some of them are illustrative:

1) **New Model of Quantum Mechanics:** The sciences and models of quantum mechanics which produced such stunning recent developments in the West as the laser and maser make quite clear how much energy is required to create a beam of coherent light powerful enough to penetrate the atmosphere, retain its coherence in spite of atmospheric diffraction (and other effects described in quantum mechanics as "thermal blooming"), and melt a two-inch hole clear through a satellite made of the most sophisticated alloys ever produced in the West. Except for limited short-distance demonstrations conducted with industrial grade lasers used in cutting operations, there is no known combination of materials or technologies extant in the West to make such a thing possible.

2) **New Materials:** The materials necessary to create an electrical charge large enough to power a device capable of producing such a beam certainly do exist. In quantum mechanics the term large enough does not make sense, but we can agree for the purposes of this discussion on the effect of it as represented by such commonly accepted constructs as frequency, voltage, current and ionic flow rates [as distinguished by the phenomenon of resistance].

Hydroelectric plants and large, fixed-base nuclear power plants are capable of producing enough energy to theoretically power such a device. But the energy bursts in both the Carpathians and the Afghan desert were generated by sources which moved from one location to another. In order to do that, several additional considerations must be addressed:

a. Portability: The power source would have to be transportable or be capable of storing sufficient energy to repeatedly power such a device. Western technology cannot produce either a portable power production unit or energy storage system capable of the performance requirements everyone agrees must be met to make the weapons system work, either in the laboratory or in the field. System portability was the most puzzling feature of the NSA/DIA report.

When carefully analyzed, the computer-enhanced enlargements of the photographs taken by the spy satellites and AWAC's crews failed to provide evidence of any tracks which could be attributed to wheeled or tracked vehicles operating in the precise locations and at the same time as the laser bursts which were observed. The implications of this set of circumstances was almost too much to believe – the devices were apparently either hand held or transportable and rechargeable in such a way as to allow them to be transported by one or more foot soldiers, without vehicular support.

b. Enormous Power Requirement: The materials and technologies used to construct a device capable of generating a beam of such enormous power and magnitude would have to be sufficiently advanced to enable the components to be transported without damage over significant distances in unpaved areas of very rough terrain. Such strategies, engineering techniques, construction technologies or materials do not exist in the Western inventory.

c. The continuous repetition of the laser bursts suggests that the devices can be operated repeatedly at short intervals of 12-15 minutes. This means they can be triggered with significantly higher frequency and intensity than anything which can be produced in the West, even for laboratory use. Industrial strength lasers used to cut metals require careful setup, accommodate only limited use in short bursts, require extensive cooling and must be continually recalibrated. These limitations obviously did not apply to the devices being operated in the Afghan desert. Analysts at the Advanced Materials and Technologies Laboratory agreed that the units would either have to be recharged via an external, independent device or somehow be capable of self-recharging in the field.

Such a thing is almost unthinkable by current Western military standards. Not only can we still not replicate the technology in any meaningful form, but the Soviets had refined the technology to a point which allowed it to be carried on the shoulders of ordinary foot soldiers and recharged in the field without motorized support.

Unbelievable! How was such a thing possible? According to some of the highly qualified scientists who scrutinized the photographs, it is not possible. The “Not Invented Here” syndrome is alive and well in the American engineering community. Some of them still insist that the pictures were either fabricated or demonstrate something completely different than this narrative suggests.

3) Energy Recharge-Batteries: How did such high-intensity laser beam generators get recharged in the middle of the Afghan desert, in the absence of powered support vehicles or fixed-based power plants? There are a number of possible alternatives. They could have been powered by some sort of advanced battery technology. It's possible, but if the battery technology used in the West is used as a model to support such a thesis, it would take a bank of the most sophisticated batteries ever designed by NASA, arrayed in series and parallel configurations larger than five full-sized Soviet T-60 tiger tanks to power such a device.

This theoretical battery bank, operating at 100% efficiency (which is not practically or theoretically possible; the best batteries manufactured in the West operate at less than 60% discharge efficiency), could conceivably produce enough direct current voltage (in a zero resistance super conductive circuit, which is not possible, either) to perhaps produce one burst of light equal in intensity to 20% of the power required to burn a 2-inch hole through a satellite moving at 20,000 miles per hour at a distance of 325 miles.

Soviet ground forces were generating bursts of this magnitude every 12-15 minutes for more than 10 hours with nothing but ground troops. During eight hours of this exchange, it was totally dark. Something pretty remarkable must have been going on to make such a thing possible.

4) Energy Recharge – Solar Cells: Another alternative would have been to have whatever energy storage devices were being used to power the “laser cannons” recharged by sunlight. The state-of-the-art in photo-voltaic cells produced in the West simply would not support such an undertaking. The very best solar cells ever produced in the West have been produced by the Japanese.

These cells operate at a maximum of 19% efficiency - that is, they convert as much as 19% of the ambient visible sunlight shining on a clear, cloudless day into ion flow, which then becomes low voltage direct electrical current flowing through a circuit. The Japanese panels require months per section to manufacture and literally cost more than their weight in gold to manufacture. They are very heavy and are so sensitive to vibration and calibration that once installed, they cannot be moved at all.

Photo-voltaic cells capable of providing enough electricity to recharge a theoretically infinite energy well would have to operate at efficiencies of 50-80% to recharge batteries of infinite electrical capacity with enough power to trigger such a device. Such cells would have to be very light weight and able to withstand extremes of heat, cold, vibration, dust, wind and other conditions encountered in a hostile battlefield environment. Nothing like that exists in the Western technological arsenal.

5) Dielectric Materials – Transformers and Capacitors: Another consideration must be reconciled before this issue can be theoretically put to rest. In order to produce a burst of coherent light of sufficient intensity to have the effect which was observed and recorded by the surveillance teams, the voltage and amperage required to support such a device would have to be staggeringly high. In order to operate at all, the voltage supplied to the system must be released all at once, not in a continuous stream but in a single coherent burst so intense that any materials known in the West would either evaporate or melt. Not only would the best dielectric materials known to Western Science melt because of the heat produced by such enormous energy bursts, but before a bolt of energy of this magnitude could even be released to such a device, it would have to be accumulated and stored somehow.

A similar set of requirements of a less dramatic type is present in all the electronic devices manufactured and marketed in the West. This includes the entire range of electronic devices such as VCR's, computers, televisions and sound components, telecommunications, information storage, transmission and retrieval systems of every kind. We could not live as we do without them. The components which convert, store and release ion flow into the circuitry of these devices are known as transistors, transformers and capacitors.

This discussion delves into a slightly technical area here, so non-scientific types will need to either become familiar with the fundamentals of electricity to understand what is meant or simply give it a possibility that what is developed in the next section is a true representation of the way such things actually operate. The discussion deals with such commonly used and seldom understood concepts as voltage, current, frequencies and resistance.

(a) Transformers convert voltage at one level of current (amperage) to either higher or lower voltage levels. When the voltage is increased, the amperage or current is proportionately decreased. A low voltage produced at a high current level can be transformed into a much higher voltage at a proportionately lower level of current or “power.”

(b) Capacitors: The decrease in amperage which accompanies a transformation of low voltage to higher voltage is often compensated for by a device known as a capacitor. In the most simplistic terms, capacitors “store” electrical energy until the amount of voltage and current reach a certain minimal threshold. When that point is reached, the entire store of energy is released all at once in a single burst.

The tantalum materials used in the West to manufacture such devices conform to certain standard rules which are commonly accepted by electrical engineers. These rules have only recently been stretched by new technologies and materials developed in the West. For the purposes of this discussion, though, it is safe to say that electrical engineers have long relied on these rules because they have always produced the same results when applied in the same way. Here’s an example.

It is standard engineering fare which dictates that a transformer capable of accommodating one volt at one ampere of current across a grid of one ohm of resistance will be one cubic meter in dimension. If followed to its logical conclusion, this standard rule of electrical engineering would require that a transformer capable of supporting a laser burst device of the kind operated by the Soviet ground forces in the Afghan desert would have to be approximately the size of a building built on a base 100 feet to a side, nearly 150 feet high.

Surely such a device could not have been hidden from the AWAC’s eye in the sky which can clearly photograph the letters on a license plate from 60,000 feet altitude, nor could it have been moved on the shoulders of ground troops without wheeled vehicular support. The fact that there was absolutely no trace of such a huge, massive transformer device (or any other kind of structure or vehicle which could be construed to serve that purpose) means that something else must have been used instead. Military analysts had absolutely no idea what it could have been.

Such a burst system cannot operate without a capacitor of some sort. A capacitive device capable of storing the amount of energy required to power a single burst from a laser cannon, made of the most advanced dielectric material known in the West, would have to have been equally massive and, further, would have to have been cooled by some sort of strategy which would have been instantly and unmistakably detected by the infrared cameras and spectroscopic scanners used aboard the AWAC’s and the spy satellites which investigated the scene.

The practical requirements of such a system are best demonstrated by the massive equipment required to operate and cool the Super Conductor Super Collider linear particle accelerators recently designed by the United States and Japan. No evidence of any such capacitive device was recorded in either the Carpathian Mountains or the Afghanistan desert. How can we explain it?

Without going into any detail about how the technologies were developed, suffice it for now to say that the Soviet ground forces in Afghanistan were equipped with a prototype of a hand-held plasma beam accelerator, the likes of which had only been roughly imagined by American military analysts. The device relied on some innovative strategies. Among these were:

Energy Storage Devices: The power source for the Soviet light cannons was comprised of a back-pack array of specially designed energy storage devices. The closest thing we have in our vocabulary to compare to them is described by the term “battery.” In the limited sense that these devices store electrical energy, they are batteries. Any other similarity to the batteries we are accustomed to in the West ends there. The literal translation of the Russian name for them is energy accumulators.

The batteries relied on in the West are based on the chemical properties of components which, when combined in certain configurations and proportions, interact chemically with one another. The result of this chemical interaction is that it creates both heat and a stream of liberated ions – electricity. In dry cell batteries, the process

of chemical interaction is one way – once they have been expended, they are simply disposed of. It is estimated that more than 12 billion expended dry cell and lead-acid batteries are dumped into America's landfills every year.

Other batteries are designed and constructed so that the chemical reactions which liberate electrical current are reversible in some degree. These rechargeable cells are characterized by the lead-acid batteries which are used in automobiles and in commercial and industrial applications. Various strategies have been developed to make batteries relying on chemical reactions maximally effective, but the theoretical limits of effectiveness of such devices have surely been reached.

A consortium of aerospace companies working with NASA recently announced the development of an advanced sodium-hydride-based rechargeable cell which is the most efficient battery yet invented in the West. Unfortunately, it operates at an ambient temperature of 2000 degrees centigrade and, if allowed to reach temperatures outside a very narrow safe operating zone, will explode with the force of a small thermo-nuclear device of approximately ten-kiloton yield. It is not safe, but it is the best Western science has come up with.

The energy storage device developed by the I.N. Frantsevich Institute for Problems of Materials Science (IPMS), Kiev, Ukraine, works on a completely different principle. Its construction is the result of a completely unique nonlinear quantum mechanical model which makes it possible to create crystalline lattices of absolutely pure carbon (and other materials) in sheets of infinitely variable dimension which are exactly one molecule thick. The crystal formation techniques and the whole body of new science which allows for their creation in the first place are completely unknown to Western science.

The mono-molecular sheets deposited by this technique are wrapped back and forth on top of each other, more than one million times per millimeter, and are separated from each other by a distance of less than one atomic diameter. At this level of construction, the material becomes subject to the rules of quantum mechanics which are almost entirely probabilistic. That means a whole atom of carbon (or almost anything else except an electron or photon) will not fit in the space which separates the lattice sheets.

When viewed under an electron microscope, the sheets produce a pattern which looks for all the world like an endless field of four-sided pyramids, connected base to base, on a single plane, with the tips of the pyramids protruding endlessly, uniformly upwards. When wrapped back and forth on top of each other, these sheets of pure carbon crystal, made of carbon molecules shaped like trillions of identical tiny pyramids, all arrayed endlessly in identical formation, are positioned so that the tips of the pyramids on the bottom sheet are matched with the tips of the pyramids on the top sheets. What remains between the pyramid tips are open "spaces" or energy wells.

The quantum physics which describes the characteristics of the energy wells created between the layers of crystalline lattice is largely unknown to Western physicists. The Soviet model predicts with a high degree of probability that the quanta of energy referred to in the West as electrons (and, in some cases, photons), the stuff of which electricity is made, will, when introduced to the lattice structure, search, find and fit into the energy wells with military precision.

During the recharging or loading phase, the energy storage devices made of the crystalline lattice material channel one electron at a time into each well created by four carbon pyramids on the bottom layer and four carbon pyramids on the top layer. Because the rules of quantum mechanics which operate in this tiny environment demand it, each electron or quanta of energy has a certain polarity, spin and "color" (and other mathematically defined characteristics) which must be accommodated if it is to find, fit and stay in an energy well. Interestingly enough, when a current is applied across the lattice-work structure, the electrons behave precisely as nonlinear quantum mechanics predicts they will. They flow much like a fluid into the lattice field,

then separate into individual energy quanta and spin into the last energy well in each layer, automatically adjusting their individual spin, polarity and color to match their characteristics to fit the requirements of each well, until the lattice is full.

Because no chemical reactions are involved in the process of marching electrons into or out of the energy well fields, there is no resistance in the circuit. In the absence of resistance, the electrons fill the wells at light speed, never missing a space, automatically adjusting polarity, spin and other characteristics, and creating no heat. The amount of time required to “charge” such a cell is less than 5% of the time required to recharge a conventional chemical battery of similar voltage and current.

The validity of $E = MC^2$ is called into question by the way these devices function. When the battery is fully charged, it actually demonstrates more mass than when the energy storage device is empty or discharged. The laws of quantum mechanics relied on in the West state categorically that this is not possible. It is the answer to the question, “How much does a beam of light weigh?”

According to the Soviet model, this is precisely as it should be. When this phenomenon was first demonstrated to scientists in the West who were testing the energy storage devices at the Idaho National Engineering and Environmental Laboratory, they were thunderstruck. The quanta of energy, or electrons as we refer to them, which are poured into the crystalline lattice demonstrate characteristics of mass even though they are bundles of pure energy sitting in stasis, literally at rest. The characteristic of mass is verifiable – you can measure it by weighing the energy storage devices before and after they are charged. When they are charged, they demonstrate appreciably more mass than when they are fully discharged.

If this is confusing to you, to suggest that pure energy can be shown to demonstrate verifiable mass while at rest (in stasis), perhaps you can begin to appreciate how fundamentally different the physics of all this is when viewed in the terms of Einstein’s classic equation $E = MC^2$.

The existence of this technology clearly is proof positive that not only does energy demonstrate the characteristics of mass, but it does so in a state of non-motion or stasis, sitting idly in an energy well. A state of stasis is a very far cry from the terminal theoretical velocity required by the constant in Einstein’s equation, equivalent to the square of the speed of light.

The scientific implications of this phenomenon are truly staggering. At very least, the verification of mass as a property of energy quanta at rest suggests that Einstein’s theory of relativity may be altogether incorrect as a means of describing the dynamics underlying the real nature of the material world and its relationship to energy.

The existence of this technology suggests at very least, that energy and mass are equivalent characteristics of all things which are manifest in the material world. It is this fundamental contextual difference which distinguishes the Soviet model of quantum mechanics from the Western model. “The proof of the pudding,” they say, “is in the eating.”

Theoretical physicists may argue endlessly about the validity of the assumptions relied on by the IPMS scientists to develop their unique sciences, technologies and materials. But they cannot argue about the existence of the materials which have arisen from that context. They are as real as they can be. And they are unlike anything ever seen or contemplated in the West.

In the same way energy quanta stored in the energy wells of crystalline lattice materials demonstrate complete mathematical satisfaction with staying there indefinitely, when allowed to flow out in the form of an outgoing wave of electrical discharge, these quanta (electrons or photons, as you prefer) march right back out without resistance at light speed through a closed circuit to another use.

When these energy storage devices are discharged, they demonstrate other attributes which are not known in Western science, and which, because of the very nature of the chemical reactions we are accustomed to, are not theoretically possible according to conventional wisdom. Conventional chemical batteries, when fully charged, produce electric current at a useable voltage for perhaps 30-40% of the total discharge cycle. After that, either the voltage or amperage (or both) drop to low enough levels that the devices being powered by them cannot recognize or use the electrical current which remains available. At that point, the batteries either have to be recharged or replaced.

The crystal lattice batteries have been demonstrated to produce precisely the same current and voltage levels throughout 98% of their discharge cycle. They produce no heat during discharge, regardless of the rate at which they are discharged. This is absolutely contrary to our experience with batteries, transformers or capacitors. Until the crystalline lattice materials were specifically engineered to register an electronically detectable blip at 95-96% discharge, it was impossible even for the scientists who developed them to distinguish a partially discharged battery from a fully charged one.

There is another characteristic which is intrinsic to energy storage devices which comes into play here. It is a characteristic of materials which is described as energy density. For non-scientific readers, this concept can simply be construed to mean the amount of measurable electrical current which can be produced by any device or material when its mass is converted into electrical energy. The concept is expressed in mathematical formulas as the number of watts and hours of consumable energy which can be converted from each kilogram of material. It is expressed as watt-hours per kilogram.

Here is an example we can all understand. Consider gasoline. When converted into electrical power at 100% efficiency, gasoline has been theoretically shown to have an energy density of between 550 and 600 watt-hours per kilogram of mass. In easy terms, that means that if one kilogram of gasoline were converted into pure electricity at 100% efficiency (with no loss due to heat, resistance, waste, etc.), the reservoir of energy would power a 100-watt light bulb for 5.5 to 6 hours.

Most of the high-end conventional automobile batteries of the lead-acid variety operate at an energy density rate of between 20-25 watt-hours per kilogram. The best NASA sodium-hydride batteries operate at 48-50 watt hours per kilogram. The energy accumulator devices which have been tested at the Idaho National Engineering and Environmental Laboratory have demonstrated energy densities of between 850 and 1050 watt-hours per kilogram.

What does this mean in practical terms? It means, for one thing, that for the first time in the history of science an energy storage device has been created with an energy density which is greater than gasoline or any other refined fossil fuel. It means that devices which rely on these energy storage technologies can theoretically be designed to store and deliver clean electrical power at higher rates of efficiency than any fossil fuel ever discovered.

The global implications of this technology are irresistible. It means, among other things, that the technology exists, right now, to eliminate the need to build another nuclear power plant or dam another river to produce hydroelectric power. It means we can no longer justify burning another ounce of petroleum, another piece of coal, another cubic centimeter of natural (or unnatural gas) or another tree to produce heat, electricity or power for any purpose, including transportation.

When coupled with the plasma beam devices being tested by the Soviet infantry units in Afghanistan, these energy storage devices operated at such unbelievably high rates of discharge efficiency that they made it possible to repeatedly induce huge electrical discharges in a highly mobile configuration.

The same technologies which were used to produce the energy storage devices have been adapted to create transformers and capacitors with previously unimaginable performance characteristics. Instead of adhering to the conventional western model of “One Volt at One Amp across a resistance of One Ohm equals One Cubic Meter,” the Soviets have produced a capacitor which measures more than 1200 farads at 10,000 amperes in a package the size of a tuna sandwich.

When tested by the Technology Materials Testing Laboratory of the Defense Department at the Pentagon and at the Idaho National Engineering and Environmental Laboratory, totally new testing equipment had to be designed, engineered and constructed just to test the devices. The scientists at those laboratories had never tested anything like these materials before.

Instead of having to house transformer and capacitor devices in a series of trailers towed by diesel tractors or huge fixed-base facilities, the operating apparatus which supplied transformed power and high intensity capacitive bursts to the light cannons weighed less than ten pounds and could easily be transported in a backpack by a foot soldier.

One final question remains unanswered. “How did the energy storage devices, once dissipated or discharged, become recharged in the field, especially in the dark of night?”

The back-pack plasma beam device detected by the AWAC’s during limited combat use in the Afghanistan desert was powered by energy storage devices constructed of crystalline lattice materials. After each laser burst, the energy storage devices were recharged every 12-15 minutes (nearly 45 minutes in the dark of night – the residual ambient heat of the desert is a very efficient source of infrared energy) by sunlight, collected and converted to electricity by four-foot square panels of “solar cell” material arrayed on a pole like a flag, each weighing less than ten ounces.

The electrical energy stored in the back-pack energy accumulators was transformed into enormously high voltages and released at almost unbelievably high current levels when the super-capacitors were sufficiently charged. The beam of “light” detected by the AWAC’s crews was a field of plasma, flowing at the speed of light and demonstrating characteristics of mass (and, therefore, kinetic energy). The phenomenon represented by these bolts of lightning are not comprehensible according to the model of quantum mechanics and plasma physics currently being used in the West.

Battery packs utilizing these energy accumulator materials have been designed, produced and tested which provide more than 14 hours of continuously transmitted power on a single charge to conventional hand-held cellular telephone devices. Similar improvements in conventional battery/energy storage capacity have been developed and are being tested for such devices as video camcorders, laptop and portable computers and other similar consumer, commercial, industrial and military applications.

IPMS research in the field of layered crystals has thus led to the creation of capacitors with a very high level of capacitance (measured in farads). This technology is based on a revolutionary production technique which forms polarized surfaces of one molecule thickness, separated by less than one atomic diameter of space, held together by weak Van der Waals energy forces. The special properties created by these layered crystalline structures provide previously unimaginable internal surface areas. Super capacitors are constructed of layered materials numbering more than one million dipole sheets for each millimeter of crystal thickness.

These devices provide a virtually limitless number of charge-discharge cycles at astonishingly rapid charge and discharge rates. The potential impact of such devices on all electronic equipment currently being produced is incalculable, since virtually all electronic devices rely extensively on the West’s state-of-the-art tantalum capacitance technologies.

At present, IPMS has on hand (among others) a super-capacitor roughly the size and dimension of a sandwich which develops more than 1,200 farads at 10,000 amperes. It also boasts production of a battery whose active mass energy density exceeds 850 watt-hours per kilogram. For the non-scientist (and all the rest of us as well) this means that a “battery” has been produced which, for the first time in history, produces more power per unit of mass than any fossil fuel ever devised.

Prototype testing of larger-scaled devices designed specifically for providing power to electric vehicles is currently underway. Prototypes are expected to be capable of sustained highway speeds of up to 70 miles per hour with a range of 525 miles on a single charge. The power plant for this application has been recently improved by the inclusion of a proprietary solid-state ceramic electric motor which weighs 7.2 kilograms and produces 100 horsepower on 12-volt direct current. For comparison, an electric vehicle employing a 100-horsepower electric motor performs the same as with a 500-horsepower gasoline engine.

Emtech LTD., Mississauga, Ontario. was commissioned to commercialize the IPMS crystal lattice battery and had applied for 11 patents. A set of conventional lead-acid batteries can propel a small electric car for 100 miles or so, require several hours to recharge, and weigh 1000 lb. An equivalent set of crystal lattice batteries is expected to weigh approximately 200 lb., provide a much greater range of up to possibly 200-300 miles, require 15 to 30 minutes to recharge, and maintain full voltage until 94% discharge. The battery operates well in the temperature range of -40 to +60 degrees centigrade.

The crystal lattice battery stores the charges in crystalline layers of a sheet-like material similar in appearance to mica. Due to nonlinear quantum mechanic effects, the electrical characteristic of each crystalline layer is that of a capacitor as thin as one molecule. Since capacitance is inversely proportional to thickness of the separation between layers, the practical consequence of the battery is to electrically function in a manner similar to that of a giant capacitor. A side benefit of these batteries is that they are made only of proprietary materials which are environmentally friendly, plentiful, and inexpensive.

If these performance attainments can be sustained in broad-based applications, electrically powered vehicles could be produced which would meet or exceed virtually all performance characteristics currently available in equipment relying on internal combustion, petroleum-based engines. Gasoline/diesel-powered transportation devices can be replaced by cleaner, more efficient and significantly less expensive alternatives.

Emtech LTD, which had the commercialization license, went bankrupt. Nu Omnicomm Technologies, Inc., of Salt Lake City, which has close ties to the I. N. Frantsevich Institute for Problems of Materials Science, may be able to revive the crystal lattice battery.

The world market for current energy storage applications which will be superseded by these energy storage technologies is estimated to be in excess of \$24 billion per year (1991), exclusive of electric vehicle considerations.

(Source: David G. Yurth, *The Anthropos Files: Tales of Quantum Physics from Another World – 2nd Edition*, 2007)

Nickel-Iron Battery

Las Vegas resident Alvin Snaper (600 patents and new products) through his company, Power Technology, Inc., has developed a superior new battery with none of the drawbacks of all other types of batteries such as temperature sensitivity. It is actually a modern version of inventor Thomas Edison’s nickel-iron battery.

Increasing the surface area of the electroplates by up to 1000 times greatly increases current output and allows much quicker charge/discharge rates.

Different chemistry reduces the weight of the battery by 50%, reduces cost, and is much more environmentally friendly than lead. The first of several nickel-iron battery patents is US Patent No. 6,060,198 for Electrochemical Battery Structure and Method.

NiMH Batteries; Solid-State Lithium-Ion Batteries

The best Nickel Metal Hydride (NiMH) batteries are no longer on the market. Why? Because either Cobasys has no intention of ever mass producing powerful NiMH automotive packs, or they just don't know how, even though they own the patent. The cells they displayed at the last EDTA conference were bulky at best, and certainly a million years away from the level of engineering exactitude Japanese automakers expect from their suppliers.

Essentially Matsushita took some of the information from their original, but mediocre patents and developed a functional NiMH battery that gave a range of 160 miles to the General Motors EV-1 and 110 miles to the Toyota RAV4 EV. This Panasonic M95 was also getting 1-2000 deep cycles and 100,000-150,000 miles on a battery pack. Something the oil companies and Detroit automakers don't want on the market, despite the Fortune 500's good mood for natural capitalism.

So now that the best NiMH battery technology for EV's has been removed from commercial circulation, Toyota, Honda and Ford are stuck using inferior NiMH battery technology in their hybrids. Toyota has indicated it will take up to 4 years for the next generation lithium-ion (Li-ion) battery chemistry to be as reliable and affordable. Till then, it's touch and go as Toyota can't crank out enough hybrids off the assembly line to meet demand, especially in deliveries to corporate fleets, taxicabs and limousine services.

State-of-the art lithium-ion chemistry is in limbo at some California-based company who has managed to secure the exclusive production rights to the only Li-ion technology that really counts, roll-to-roll solid-state battery production. That's right; no more liquid chemistry... no leakage, no over heating, no explosion, extreme light weight, easy mass production! Just like printing mylar off a printing press! Just like laminating plastic photovoltaic sheets!

Instead more conventional liquid Li-ion chemistry is being pushed feverishly. Toyota is buying out major Li-ion startups in Asia. Other Li-ion battery companies like Valence, Electrovaya, Kokam, LG Chem have attractive polymer Li-ion batteries, but they are still all based on the older liquid chemistry model, and therefore more expensive and more complicated to produce.

The chemical genius who came up with the Li-ion solid-state polymer roll-to-roll protocol is a professor at MIT who does not own his own technology. MIT owns the technology, and it is the MIT licensing office which gets to decide what companies do or do not get awarded these licensing rights. This revolutionary technology has been in limbo since 1995!

Is it because MIT is cashing checks from the Rockefeller Bros. and the Ford Foundation? Is it pure incompetence? Is it a repeat of the cold fusion debacle Gene Mallove wrote about in his book "Fire from Ice"? It's hard to tell as everyone involved is terrified to talk about it openly, which is why I am not mentioning any names. Frequent visitors to the Electrifying Times website know exactly who I am talking about!

My suspicion is that certain forces within the military, and now Homeland Security, do not want solid-state roll-to-roll Li-ion batteries from entering the civilian marketplace, the same way you can't buy Green, a special duct tape developed for Groton Electric Boat workers to strap metal parts, so strong it instantly bonds to the skin, requiring surgery if accidentally touched.

What a poor boy to do who wants to save the planet if the powers-that-be won't give him the affordable batteries he needs to make a 0 to 60 in under 3 seconds EV with a 200-mile range on a single charge? That's the question we should all be asking ourselves instead of lamenting about who killed the electric car!

The batteries are there, being manufactured for military applications all over Connecticut! If you want plug-in hybrids and 100% pure EVs so you don't ever use a drop of gasoline again, with equal to if not better performance than any liquid fuel engines, then ask yourself why MIT, since 1994, has done very little to get their solid-state Li-ion roll-to-roll battery patents into production. Don't follow the money; follow the trail of misappropriated and shelved patents.

Congress needs to put back into question the entire review process of patent law, and its consequences on environmental health, by imposing strict fines to whoever is caught buying patents for the sole purpose of keeping its protocol out of commercial circulation. (Excerpted from "Who Killed Better Batteries?" by Remy Chevalier, *Electrifying Times*, spring-summer 2006, Vol. 10, No. 1, www.electrifyingtimes.com.)

(Erik Masen adds more details in his "Suppression of Quantum Leap Inventors" *Electrifying Times*, 2007, Vol. 10, No. 2)

Chevron-Texaco bought into a Detroit company, Stanford Ovshinsky's Energy Conversion Devices (ECD), and changed their name to Cobasys. ECD held the original patents on nickel metal hydride battery technology, but never successfully marketed a turnkey NiMH battery for major markets. They did sell a considerable amount of NiMH batteries to GM for the EV1. Panasonic came along and refined this NiMH battery technology into an indestructible battery of higher energy density and longer life.

That enabled the Toyota RAV4 EV (electric vehicle) to get 80-120 miles out of a battery cycle, and get over 100,000 miles of battery life out of this improved NiMH battery. ECD-Cobasys filed a lawsuit of patent infringement against Panasonic and won. This action essentially shutdown the import and use of the Panasonic M95 NiMH battery that was so successful in making EV's practical for the GM EV1, Ford Ranger Electric PU, and the Toyota RAV4 EV. As a result the proven very popular M95 90-ampere-hour NiMH is not for sale in the United States. ECD-Cobasys also put heavy licensing fees and restrictions on the NiMH battery used in the Toyota's present hybrid fleet.

(Reported by Remy Chevalier)

Liquid Metal Battery

The liquid metal battery was invented at Massachusetts Institute of Technology and further developed by Liquid Metal Battery Corporation (www.lmbcorporation.com). It uses a mechanism to alloy and dealloy a battery, thus giving rise to voltage. Reversing the current reenergizes the battery. The high-temperature (1,292 °F) liquid metal battery has a negative electrode made of magnesium, a molten salt electrolyte, and a positive electrode of antimony that lay in three distinct layers because they are of different densities. The self-segregating nature of the battery components and the use of low-cost materials results in a promising technology for stationary energy storage applications.

The liquid metal battery stores electricity by de-alloying the negative (-ve) electrode material, A, from the positive (+ve) electrode material, B. As the battery is charged, a power source extracts electrons from the +ve electrode, causing A to de-alloy from B, and A dissolves into the electrolyte as an ion (A⁺). Simultaneously, A⁺ ions from the electrolyte accept electrons at the -ve electrode and A deposits as a liquid metal. The energy difference between ‘pure A’ and ‘A dissolved in B’ generates a cell voltage. To discharge the battery, electrons are driven by the cell voltage through an external circuit/load, resulting in A⁺ ions moving from the top -ve electrode through the electrolyte, and alloying with B, thus returning the stored energy.

Low cost is achieved through the use of inexpensive, earth-abundant materials that are easy to procure. Their products take advantage of the economies of scale inherent to electro-metallurgy and conventional manufacturing. The all-liquid construction avoids cycle-to-cycle capacity fade because the liquid electrodes are reconstituted with each charge – similar systems have operated in a lab environment for more than 17 months with daily cycling and no reduction in performance. The molten salt electrolyte combines high conductivity with abuse tolerance at low cost. Self-segregation due to three immiscible liquid phases of different densities (e.g. oil and water separation) allows for robust operation and ease of manufacture. Together, these attributes will enable the liquid metal battery to exceed 70% round-trip AC efficiency for over a decade without degradation.

Commercial liquid metal batteries will be modular – allowing repeatable manufacturing and ease of transport. When integrated onsite, the modules have the footprint of a shipping container, and the system will be rated at 500 kilowatts with 2 megawatt-hours of storage capacity. The management and control electronics are configured to allow remote operation and monitoring of the battery without on-site personnel. The liquid metal battery operates silently, is emissions-free and has no moving parts. These characteristics allow liquid metal batteries to be sited in the middle of the city or the middle of the desert without special regulatory or permitting requirements. Liquid metal batteries will utilize existing power electronics and follow interconnection standards to provide the reliability required by customers.

In the world of electricity storage, liquid metal battery technology performs like both a tractor and a race car. The liquid metal battery respond to regulation signals with its entire nameplate capacity in milliseconds while simultaneously storing up to twelve hours of energy and discharging it slowly over time. This ability to be both a power and energy resource to the electric grid distinguishes the liquid metal battery and opens up numerous lucrative markets for development. This value proposition makes the liquid metal battery a valuable solution for system operators, power developers, utilities and power marketers balancing the supply of and demand for energy. The liquid metal battery may be especially useful for smoothing out electricity supplies from erratic solar and wind generators.

Hutchison Self-Charged Battery

The Self-Charged Battery generates a perpetual Direct Current (DC) voltage without external recharging. By stacking enough self-charged batteries into a single DC generator, the generator’s DC voltage can be converted to regulated Alternating Current (AC) electricity and thereby silently electrify a house without fuel nor emission of pollutants. The DC voltage could also power an electric vehicle’s DC motor. An energy researcher has emailed Gary Vesperman that “I have tested some of his crystal cell batteries and they do work, very low power outputs nearly continuous,...”. Inventor is John Hutchison.

Endless Electric Field Generator

The "Endless Electric Field Generator" is being developed by a small company that does not want to be identified at this time. This company has developed a number of technologies, and has acquired a significant patent portfolio.

This technology works by producing a permanent electric field (the opposite of a permanent magnetic field in a permanent magnet) that does not break down. From this permanent electric field, a constant flow of electricity can be produced. Currently, the output of their prototypes is modest, only capable of powering small lights or other loads. However, they are working towards incorporating methods of increasing the surface area of the device, which will boost the current to a higher level (the voltage is already there).

The future potential of this technology is stunning. According to the company, once the technology is further developed, a device the size of a postage stamp could produce approximately one watt of constant electrical power – enough to power a cell phone. It would continue producing this power for a minimum of twenty years (perhaps much longer) while consuming no fuel of any kind. Additionally, these devices are produced from non-toxic materials, and would not be harmful even if swallowed.

Eventually, the technology could be scaled up to provide electricity for any application – mobile phones, computers, electric cars, homes, etc.

They are a small R&D company that has been in existence for around 20 years with several technologies already developed. The staff comprises of very qualified scientists and technicians, and they have some 22 patents and several published peer review papers.

They have developed two types of generators. The generators, once manufactured do not rely on any catalytic, chemical reaction or nuclear materials. They should continue to generate for at least 20 years; and testing of the material for the last three years has shown no change in structure or performance. At present, power outputs are low, however voltages are high. The current can be increased by increasing the surface area. It is obviously a major scientific breakthrough. No existing laws of physics are broken, but still some mysteries and questions remain. However the proof-of-concept devices cannot be argued with.

The technologies here will be in the hands of everyone and will be used to power everyday appliances and technologies. Eventually as it is scaled up, it will be available to provide power for larger applications, but there may be engineering limitations.

These are both material technologies with no electronics or moving parts; so they are solid state.

The first device consists of three materials that are layered onto each other. The first layer is already a known material that generates electricity when stimulated. The second material stimulates the first material or layer to produce the electricity. However to stimulate the second material you need another or third material. The combination of the materials and their composition determine the voltage. The surface area and how well the materials contact each other determine the current. The materials can be multi layered to increase current output.

Voltages typically vary between 1 and 40 volts DC but have been measured up to 100 volts in extremely cold conditions. A hybrid with the solid-state Cool Chips™ thermo-ionic refrigerator (see above) may result in a net power increase. IPMS-developed thermal electric cooling devices (also see above) even have been tested to produce temperatures as low as -259 degrees Fahrenheit.

There are some critical processes that have to be undertaken to make this work. Once the material is assembled and initiated it will continue to produce electricity for at least 20 years and possibly up to 100 years.

The second generator has some advantages over the first as it does not need to be layered. It is a different process where the materials are mixed and put through a simple process with the end result being a material that puts out a permanent electrical field.

After extensive testing there is no breakdown of the materials or performance. Some samples have been around for as long as three years.

What are some of the applications that this technology could be used for? Initially, products that require low power like sensors and perhaps GPS devices. The technology readily lends itself to charging capacitors and batteries. Once the basic building blocks are engineered, there is no reason why it cannot be scaled up to larger applications. There are many manufacturing techniques the technology lends itself to. It will be a matter of the application and economics. The materials used are cheap, non-toxic and in abundance.

There is actually no limit of how large these devices can be scaled. A lot of engineering needs to be done, and no doubt some hurdles will show up. Once the basic building block is engineered, it can then be reproduced many times over, increasing power output by layering the materials with first generator and just increasing the bulk of the second generator.

Once the power densities are known, when better samples can be produced, it ought to be easier to determine optimum sizes and scalability. When an optimum size is known the cells can simply be duplicated in modular fashion. For example, it may eventually be possible to commercially make a postage stamp-sized device that could endlessly power a cell phone, and smaller devices that could endlessly power heart pacemakers and more compact hearing aids that wouldn't need batteries.

The science is solid, but the engineering of how to best produce these cells, and the manufacturing techniques used, have to be further investigated. The proposed techniques are no different to existing ones being used in the semiconductor industry today.

A handmade sample that had not been used or tested for at least two years was hooked up to an LCD desk clock. The clock powered up immediately. The sample was deliberately shorted out several times, and it bounced back in a couple of seconds every time. Resistance to short circuits is of nontrivial significance.

http://pesn.com/2012/01/21/9602018_Top_5_Free_Energy_Technologies_Unfolding_Now/
http://pesn.com/2011/07/23/9501875_Number-1_Breakthrough_Solid_State_Generator/

Joe's Orgone Energy Cell

The Joe's orgone energy cell basically comprises of two metal containers, one inside the other. Both containers are filled with specially charged and cleaned water with the inner container perforated to allow water to freely move between the inside and outside of the inner container. The outside container is electrically connected to the anode of a battery, and the inner container connected to the battery's cathode. The outside container is closed except for an orifice to which a thin pipe is attached. The other end of the pipe is attached to the outside housing of the carburetor of a gasoline engine. Gas/energy is transferred to the carburetor through the pipe. The entire cell including the pipe must be electrically insulated from the engine.

Various designs and shapes of both containers have been experimentally built. The original and simplest comprised of both containers as long pipes with the inner pipe, which was perforated, inside the outer pipe.

At least fourteen vehicles in Australia have been fitted with different versions of Joe's orgone energy cells to be driven without fuel nor battery charging. The engine, radiator and exhaust pipe stays cold enough to freeze water – warranting replacing water in the block with transmission fluid. The timing does have to be advanced between 25 and 80 degrees, depending on the type of engine, to allow the engine to run smoothly. The engine's power doubles over that when petrol-fueled.

The Joe's orgone energy cell is not explainable using conventional mainstream physics. It is not even known if the process inside the cylinders is implosion, explosion, or both. No gasoline is mixed with air inside the carburetor. It appears that zero-point energy is somehow drawn from the ether and converts the air entering the cylinders into some kind of fuel. The inventor claims the process increases the frequency and energy of the air.

For converting existing gasoline-powered vehicles into self-powered vehicles which don't require fuel nor battery charging from a local electric utility, adding the Joe's orgone energy cell seems to offer by far the easiest modification. Nearly the entire engine is left alone. A separate heater would have to be provided since the engine runs cold. The vehicle will not rust, and paint will not oxidize. Guy McCarthy, guy@twelvestar.com, has provided the following insightful analysis of the Joe's energy cell from a biodynamics perspective at <http://web.archive.org/web/20060627183223/http://www.twelvestar.com/Sourceworks/Joe%20Cell.html>:

[0.1] The "Joe Cell" (described in NEXUS magazine, Aug-Sep '98, pp. 43-46) is an electrical device attached to the carburetor of an ordinary automobile engine which allegedly enables it to run for extended periods with the fuel line disconnected.

[0.2] Biodynamics is a science of natural forces and agriculture inspired by the Austrian philosopher Rudolf Steiner. It pre-dates "Organics" as the original alternative to chemical/industrial agriculture. Biodynamics has achieved limited recognition in the United States and Canada, but is widely practiced in Europe, New Zealand, and Australia.

Main Text:

[1.0] The Joe cell uses water as a storage medium, which, when charged above a certain threshold, collects additional energy as needed by the engine. The initial charge is not depleted as the engine runs, but will dissipate under certain conditions. This matches a key attribute of the biodynamic ether, which attracts more ether to itself once the local concentration reaches a certain threshold. Without adequate boundaries (or storage conditions) the etheric charge build-up will dissipate.

[2.0] The motive reaction in the engine seems to be "implosion", since the ignition timing must be advanced so far into the compression stroke. (Note that 80 degrees is nearly 2/3 of a typical compression cycle, which totals about 135 degrees in a 4-stroke engine.) Implosion may be considered equivalent to "a sudden condensation of the ether" which is also thought to be the motive reaction that creates lightning and thunder in the atmosphere. According to biodynamic researchers, condensation is a state change from a more rarefied ether into a less rarefied one, releasing energy in the process.

[2.1] Biodynamics deals with four states of ether which are equivalent to the four elements intuited by ancient philosophers:

Warmth Ether corresponds to the Fire element

Light Ether corresponds to the Air element

Tone Ether (or "Chemical Ether") corresponds to the Water element
Life Ether corresponds to the Earth element

[2.2] In the physical world, substance tends to flow from a high potential to a low potential. This is what the concept of "entropy" and the Second Law of Thermodynamics are based on. But in the etheric world of living energies, the inverse is true. Ether is naturally attracted to itself and flows from low potential to high potential. This is why living organisms continue to draw nutrients and life forces into themselves while the rest of the world is supposedly running down. Ether penetrates substance, and substance influences ether. This dynamic interplay is essential to life on the physical plane.

[2.3] Under favorable conditions, the following etheric condensations will occur:

Warmth Ether --> Light Ether, releasing energy as lightning

Light Ether --> Tone Ether, releasing energy as thunder

Tone Ether --> Life Ether, releasing energy as biological manifestation

[2.4] Recall that lightning and thunder sometimes occur independently of each other (as in "heat lightning" and "rolling thunder"), while at other times they are closely linked. Clearly any reasonable explanation for these phenomena must allow for both cases. The common notion that lightning and thunder are caused by static discharge between air masses is clearly untenable. A buildup of static charge in such magnitudes could only occur under extremely dry conditions; the typical thunderstorm is certainly not dry.

[2.5] The biodynamic researcher points to a well-defined cumulus cloud in mid-summer as the ideal collector of etheric energy. Hour by hour it grows, drawing abundant warmth ether from the atmosphere into itself as well as particles of dust and moisture. The cloud builds itself taller and taller – its boundaries sharply distinct from the rest of the sky. Eventually the cloud becomes saturated – turning darker and forming a mighty thunderhead. At this point, anyone who is familiar with weather patterns in open country is headed for shelter. They know that a violent thunderstorm could be unleashed at any moment.

[2.6] Just a few months ago the author observed such a phenomena in central Maryland. The top of the cloud was puffy and brilliant white, illuminated by the late afternoon sun. In contrast, the bottom was flat and dark, laden with moisture. Great bolts of lightning began to crackle about its upper regions. The air felt clear and energized while all around trees were bending and twisting in sudden gusts of wind. When the storm finally broke it was both fearsome and beautiful, a mighty discharge of lightning, thunder, and rain.

[2.7] We can surmise that the Joe cell becomes highly charged with etheric energy, and that this charge is transferred through the carburetor to the air entering each cylinder. As the compression stroke begins the volume of air is compressed, causing a further concentration of etheric charge. Soon the air becomes saturated with ether. At this point conditions in the cylinder are similar to those within the thunderhead. The ignition spark, far advanced into the compression stroke, serves to catalyze a condensation reaction of the compressed ether. This sudden change of state causes the air mixture to contract sharply, generating power through the remainder of the compression stroke. Therefore the air mixture in each cylinder undergoes a structural change, not a chemical one, and the flywheel is driven by *suction* rather than combustion. With the exception of small amounts of vapor from engine oil and perhaps trace elements from the engine and muffler, the exhaust should be of substantially the same quality as the air intake.

[2.8] Since warmth ether is the most rarefied ether, condensation will have the effect of reducing or consuming warmth. Therefore implosion is a cool process, which tends to absorb heat rather than release it. This matches observations of the Joe cell in which the engine runs cold. Unlike combustion, implosion is a "living" process, and as such produces no waste heat or by-products.

[3.0] All three styles of Joe cell are based on concentric, insulated cylinders. This is similar to the classic "orgone accumulator" discovered by Wilhelm Reich. Reich found that metals tended to conduct ether while organic materials tended to absorb it. By layering the two types of materials together, Reich caused a directional flow of ether to occur. The orgone accumulator was a six-sided box constructed with alternating layers of metal and non-metallic materials.

[3.1] The inclusion of a 1.5-volt battery to maintain the charged condition (and a 12-volt battery to create it) is an interesting variation on the orgone accumulator design. There is precedent for this idea in electrogravity documentation that has become available in recent years. (See the USAF report "Electrogravitic Systems" that was released in 1995 as well as patents by T. Townsend Brown.)

The basic idea is that a charged condenser exhibits a tendency to move towards its positive terminal. This is thought to result from a net movement of ether in the opposite direction (from positive to negative). Therefore a static electric charge stimulates a directional flow of ether.

[3.2] The Joe cell design implies a net movement of ether from positive to negatively charged terminals (i.e. towards the center of the cell and towards the engine).

[4.0] The transfer of energy to the carburetor is accomplished by several different conductors including plastic, copper, aluminum and rubber tubing. The common material in all of these configurations is the *air* inside the tubing. This is consistent with the biodynamic view that oxygen is an excellent carrier of etheric forces. (Fertile soils are said to contain 50% air for just this reason.) The metallic carburetor housing would conduct the etheric energy to its interior surfaces, where incoming air would absorb it and carry it into the cylinders.

[5.0] In conclusion, the Joe cell offers a compelling view of how ordinary combustion engines might be modified to run on natural etheric energy. This could be an important direction for future research. Validation of the concept could be approached in three phases:

[5.1] Collecting a high concentration of etheric charge. For some ideas on how to accomplish this, see "Geometric Energy Fields" at

<http://web.archive.org/web/20060610195423/http://www.twelvestar.com/Sourceworks/Geometric%20Energy%20Fields.html> which includes specific instructions for building resonant etheric devices.

[5.2] Stimulating a sudden condensation of ether by means of electric spark and measuring the implosion effect in a pressurized container.

[5.3] Achieving reproducible evidence of successive implosion events within a small engine mounted for laboratory testing.

For a related discussion, see the "Etheric Weather Engineering" chapter in the compilation of "Advanced Technologies for Foreign Resort Project" in www.padrak.com/vesperman. Also see "Torsion Field Physics and Torsion Field Communications", again in www.padrak.com/vesperman. More information can be found in http://peswiki.com/index.php/Directory:Joe_Cell.

Moe-Joe Orgone Energy Cell

The Moe-Joe orgone energy cell is a possibly more powerful redesign of the original Joe's orgone energy cell by Moshe Daniel Block, Montreal, Quebec, Canada, www.moe-joe-cell.com. The Moe-Joe orgone energy cell comprises of four concentric thin spherical stainless steel shells – 5, 4, 3, and 2 inches in diameter. The ball is filled with specially charged water and then sealed. Holes allow the special water to circulate between the inner shells.

When installed in a vehicle, electrodes at the cell's north and south poles are respectively wired to the battery's positive post and engine ground. One end of the flexible orgone energy transfer tube (we used dishwasher tubing) is clamped over a bolt sticking out at about 30 degrees off the north pole.

The engine's white plastic L-shaped positive crankcase ventilation (PCV) valve intake is replaced with a white plastic T-shaped PCV intake. The other end of the orgone energy transfer tube is clamped over the new end of the now T-shaped PCV intake.

Orgone energy is accumulated within the Moe-Joe orgone energy cell and guided by the tube into the engine via its PCV intake. As the engine draws orgone energy, the Moe-Joe orgone energy cell instantly replenishes its accumulated orgone energy by drawing additional energy from the universal orgone energy field.

The Moe-Joe orgone energy cell does not generate hydrogen nor Brown's gas. A cell needs to be topped off with only maybe a cup of specially charged water about once or twice a month, depending on how the car is driven. The charged water itself does NOT enter the engine. It is orgone energy that significantly adds power to the engine – possibly as much as doubling its power.

Exactly how universal orgone energy replaces some of an engine's gasoline consumption is a subject of scientific debate. One theory is implosion of orgone energy which enables the engine to run cooler. The above Joe's orgone energy cell chapter offers a detailed explanation of Moe-Joe orgone energy cell theory.

In spring 2008 a Moe-Joe orgone energy cell (sometimes simply referred as the “ball”), operating as an orgone energy accumulator, was installed in a 1993 Saturn. Orgone energy was transferred from the cell through a section of dishwasher tube into the engine via its PCV valve intake. The Saturn's mileage, carefully measured on an old largely unused and flat highway southwest of Las Vegas along I-15, using the same gas pump in a Chevron station next to a casino a few miles north of Primm, jumped from 30 MPG to 47 MPG. Smog checks before and after connection of the ball to the battery measured a 90% reduction of exhaust pollutants.

A second Moe-Joe orgone energy cell was also installed in a non-computerized 1968 Dodge Charger with similarly positive results. It was fun driving the Charger as it performed like it had a 500-horsepower engine.

The car noticeably feels lighter as well as more powerful due to a possible anti-gravity effect. When unpacked and assembled without even having been filled with specially charged water, a Moe-Joe orgone energy cell when picked up will sometimes feel light as an empty beer can. When picked up at other times it sometimes will feel noticeably heavier. The Charger has a decidedly different feel of increased speed when it rounds a curve in the road.

Shortly after the Moe-Joe orgone energy cell was installed in the Charger, Gary Vesperman was standing behind the Charger's exhaust pipe. His mechanic friend John Martens was tinkering under the hood. When John suddenly moved the throttle to a high power level, Gary's pants were immediately covered with black soot. It was quickly deduced that orgone energy was cleaning out the engine's cylinders.

The Charger's engine normally idles at about 1000 RPM. John has seen it idle as slow as around 50 RPM. No normal gasoline engine on the planet can idle that slowly.

Another weird phenomenon: Sometimes the Charger's engine was emitting a strange whitish "fog" out of the oil intake tube, exhaust, air filter, and other orifices. Putting one's hand into the "fog", it doesn't feel at all like the hot steam that boils out of a hot uncapped radiator.

The Moe-Joe orgone energy cell is not compatible with more modern cars and trucks because of the engine computer. What happens is that the fuel-air mixture becomes unusually lean. The computer is programmed to then add more fuel to the fuel injectors to bring the fuel-air mixture back up to standard. An electronic circuit has to be added to modify the oxygen sensor signal in order to fool the computer.

To establish a business selling Moe-Joe orgone energy cells in Nevada, the first step would be to hire an attorney to obtain from the Nevada Department of Motor Vehicles an official letter certifying that it is legal to install Moe-Joe orgone energy cells in Nevada-registered vehicles. The estimated cost is \$5,000.

If legal, the second step would be to purchase a pre-computer era car or truck that is in decent shape. After purchase, but before installing a Moe-Joe orgone energy cell, the vehicle's emission should be measured at a smog station. The vehicle's gasoline per mile consumption should also be measured over at least 150 miles. The recommended test route is on the old highway southwest of Las Vegas parallel to I-15.

After installation of a cell, the vehicle's emission should be measured again at the same smog station. The vehicle is driven again over the exact same route as before using the same gasoline fueling pump. The estimated cost of vehicle and test drives is \$5,000.

According to <http://www.moe-joe-working.com/Moe-Joe-Cell/Moe-Joe-Cell-Store/moe-joe-cell-store.html>, the cost of a Moe-Joe orgone energy cell with one set of spacers, one bismuth core, one aluminum hose connector, and one 1-meter transfer hose with spring totals \$348. Assume an estimated additional shipping cost of \$10. A mechanic experienced with installing Moe-Joe orgone energy cells could likely install a cell in most cars and trucks in approximately one hour.

The estimated cost of purchasing and installing one Moe-Joe orgone energy cell in a demonstration vehicle, including mechanic training, is \$600.

Gary Vesperman has an electronic contraption for specially charging and filtering the water with which to fill a Moe-Joe orgone energy cell. Electrically charging bottled spring water results in brown scum floating on top of the water which has to be filtered several times before a clear liquid similar in color to urine is obtained. It currently takes a couple of hours to charge and filter enough water to fill a one-quart bottle. He is willing to make and sell one-quart bottles of special water for \$50 each. Hopefully production efficiencies can be improved such as experimenting with charging and filtering distilled water rather than bottled spring water.

Once a demonstration vehicle's performance with and without the Moe-Joe orgone energy cell has been certified, it is suggested that the vehicle be displayed at the numerous car shows that are held in the Las Vegas area. Orders could be taken at these shows for Moe-Joe orgone energy cells to be installed *only* on pre-computer cars and trucks.

It is anticipated that the owners will be so pleased with the enhanced performance of their orgone energy-powered pre-computer cars and trucks that they will place informal requests for Moe-Joe orgone energy cells to be installed in their more modern computerized cars and trucks. Favorable market demand would encourage the expensive development of an electronic circuit for making the cells compatible with engine computers.

Development and validation of a commercial-grade circuit with appropriate packaging and instructions is conservatively estimated to cost tens of thousands of dollars.

Arrangements with an automotive repair shop to install Moe-Joe orgone energy cell could be made. Or, a mechanic could be hired and equipped to do nothing but install and service Moe-Joe orgone energy cells.

Standalone gasoline or diesel-fueled electricity generators don't seem to have computers. It seems reasonable to anticipate a large market (farms, e.g.) for orgone energy-fueled generators. Standalone non-computerized diesel and gasoline-fueled electricity generators would consume much less fuel with a Moe-Joe orgone energy cell.

Thin-Film Electrolytic Cells

A number of seasoned technology integrators have developed thin-film energy storage technologies which hold considerable promise. Dr. George Miley, Dr. Robert Hockaday and others have developed thin film technologies with energy densities exceeding 250-400 watt hours per kilogram. Dr. Miley's invention is illustrative. Using a flowing pack-bed type electrolytic cell with 1-molar LiSO_4 in light water, 1mm plastic beads with a very thin [500-1,000 angstrom] film of metal [nickel, palladium, titanium] are employed. A special sputtering technique is used to spray the metals onto the surface of the beads. With 2-3 volts of electrical power and 1.5 milliamperes of current, the single film experiments have shown the material to produce more than 10 times as much output power as input. The input power is no more than 0.01 watts while .5 watt of heat is produced.

It is likely that the physics involved in this reaction involve the release of energy as a by-product of nuclear transmutation. Dr. Miley has written, "The key finding from these studies has been the observation of a large array of "new" elements (i.e., different from the original bead coating), many with significant deviations from natural isotopic compositions, after the run. Great care has been made to ensure that these elements are distinguished from isotopic impurities by use of a "clean cell" with high purity components and electrolytes, in addition to the pre-and post-run analyses. Even low-energy radiation was detected from the bead days after each experiment. Applications to space power, providing a 1-kilowatt cell with only 500 cubic centimeters of active electrode are predicted."

Note that this particular invention, with its large over-unity energy yield, was awarded an NERI grant by the US Department of Energy. At the insistent urging of the American Physical Society and representatives from MIT and other universities whose laboratories are currently engaged in high-temperature gas-cooled nuclear reactor research, Energy Secretary Richardson eventually withdrew the grant.

Torsion Field Energy Applications

A sizable list of attributes has been experimentally identified which demonstrates that the torsion field operates holographically, without regard to time and distance. Its operations are characterized by a variety of behaviors which have been described conceptually, experimentally and mathematically as functions of spin polarity, angular momentum and weighted waveform vector velocities.

In August 1999, Dr. Myron Evans, Dr. Lawrence Crowell and a team of sixteen other physicists, engineers and mathematicians published the first reformulation of Maxwell's field equations in over a hundred yearsⁱ. Contained in their extraordinary work are reformulations of the entire family of formulas which have been developed over the past 100 years to describe the attributes, functions and dynamics which characterize electromagnetic fields. Their seminal work demonstrates that the functions and attributes of the five primary fields, including those of the torsion field, can be expressed in terms of parallel geometricized equationsⁱⁱ.

A careful analysis of the basic formulas developed by Akimovⁱⁱⁱ, Schwartz^{iv}, Anastasovski^v, Trefilov^{vi}, Reed^{vii}, Santilli^{viii} and others, is extremely revealing – the most stunning thing about them is the discovery that the characteristics of all four primary fields and the 5th field [which we have called the torsion field] appear to be completely accommodated by the set of functions which comprise spin polarity in linear, longitudinal and transverse wave functions, and angular momentum at both the quantum and macrocosmic level. While there is still much work to be done here, it seems more than coincidental that these attributes are precisely what cause the torsion field to operate as it does. The formulas referred to include Einstein's equations, the Young-Mills equations and Geisenberg's equations.^{ix}

It has been shown that information is conveyed via the torsion field at a rate which is at least 10^9 times faster than the speed of light. This revelation, which is largely due to the ground breaking work of Russian scientist V.A. Dubrovsky up to 1985, has now been confirmed by at least six other laboratories in the former Soviet states,^x by Prof. Dr. Guenter Nimtz and his colleagues at Cologne University^{xi}, and Lijun Wang, Alexander Kuzmich and Arthur Dogariu of the NEC Institute^{xii}. The group velocity of torsion waves has also independently been shown to be at least 10^9 times the speed of light.^{xiii}

The litmus test regarding this issue is found in the recent award by NASA of a contract to develop a torsion field communications system. The award was announced on August 19, 1999, under the title, NASA Glenn Announces Breakthrough Propulsion Physics Selections.^{xiv}

A practical set of experiments which reveal just how important this concept is has been conducted both here and in the former Soviet states. Here in the United States, Bill Ramsay^{xv} describes an experiment in which Greg Hodowanec was able to record the occurrence of a solar flare more than eight and a half minutes before it was confirmed by NOAA, when the photons and particles liberated by the event entered the earth's atmosphere. He was also able to measure the magnitude of the event, as it occurred^{xvi}.

Nick Anthony Fiorenza and Alistair Couper have both reported on the use of gravimetric devices to record the actual transit locations of the planet Pluto, orders of magnitude faster than was possible using measurements based on conventional light wave sensing devices.^{xvii} The devices used by Fiorenza and Couper have been employed by Russian astronomers to determine the precise real-time locations of stellar formations and planets^{xviii}. The results of their work bears heavily on the assumption that information contained in any single location in the Cosmos can be instantaneously obtained at any other remote location, regardless of the extent to which events are separated by time, space or distance. This assumes the means of observation are engineered to comport with torsion field dynamics rather than relying on the data transfer rates associated with radio frequency emissions [light].

We have reason to believe, based on the ground breaking work of V.A. Ablekov, David Bohm and Karl Pribram^{xix}, that the torsion field is holographic. The combination of the features identified by their research suggests that the phenomena associated with Bohm's Implicate Order and Pribram's holographic model of human consciousness, which are otherwise inexplicable, can now be accommodated.

Unlike electromagnetism, where analogous charges repel and opposite charges attract, in torsion fields similar charges attract and opposite charges repulse.^{xx}

As a torsion field is generated by the classical spin of a magnetic plate, we can observe and measure the precise effects of the alteration of spin state of the object or system which is encompassed by it. At the Institute for Problems of Materials Science in Kiev, scientists have for more than 25 years used torsion field generators as an essential component of the apparatus used to manufacture exceedingly exotic materials, for which we have no comparable products in the West. These include mono-molecular powdered metals, solid-state energy accumulators and certain varieties of atomically engineered carbon.^{xxi}

Torsion field emissions are non-dissipative and are not attenuated by the interposition of mass or the effects of distance. Torsion fields cannot be screened by any known materials except aluminum, nor any known combination of materials or fields.^{xxii}

The results of the 1986 Moscow M2 torsion wave communications experiments have been widely distributed. In this demonstration, a directional torsion field was modulated with a simple variation of the Morse code. The signal was instantaneously received at a point more than 22 kilometers distant, using a similar low-power gravimetric signal detection device. The signal was passed through steel reinforced concrete more than 50 meters thick, after having been propagated through a mountain more than 10 kilometers wide. Variations of this experiment have apparently been successfully performed in a number of other locations in the former Soviet states since that time^{xxiii}.

The absence of loss of signal strength, referred to as attenuation, during the spread of a torsion wave group, suggests that long-distance communication may one day be possible with the use of very low transmission power and unlimited bandwidth. The fact that torsion waves are not attenuated [weakened] by any known material substances or fields suggests that we may one day be able to devise systems which are capable of communicating through water or any density of physical material^{xxiv}. This concept also suggests that we should be able to devise communications systems capable of supporting real-time communication without regard to the vast distances of space.

Since all known substances possess a non-zero collective spin state [this means, in simple terms, that everything is always in motion at all scales], then all substances must also create and exist within their own localized torsion fields. The expanse and frequency structure of any substance is determined by its chemical composition and the expanse structure of its molecules or crystalline lattice. A clear understanding of these mechanics will enable us to commercialize energy storage devices which have energy conversion characteristics well in excess of gasoline [650 watt hours/kg].^{xxv}

At the Institute for Problems of Materials Science located in Kiev, Republic of Ukraine, a scientific team led by Academicians Trefilov, Tovschuk and Kovalyuk created a solid-state energy cell which produces 850-1040 watt-hours/kilogram, in laboratory prototypes. This is at least 35-50 times the energy density of any known conventional energy storage devices developed in the West. The reliability of their claims regarding this technology has been verified by the Idaho National Engineering and Environmental Laboratory, Defense Advanced Research Projects Agency, and the Advanced Materials and Technologies Laboratory. A key element of their crystalline lattice deposition method relies on the effects of a torsion field beam.^{xxvi} Scientists working at Sandia Laboratories in Los Alamos, New Mexico, have reported the successful development of a thin-film solid-state energy storage device which reportedly demonstrates energy density in the range of 250-400 watt-hours/kilogram.

It has been shown that torsion fields demonstrate persistence. This attribute is referred to in the literature as a "residual field effect."^{xxvii} A torsion source of a defined expanse and frequency has been consistently shown to polarize the localized region of the physical vacuum. Once the energizing space-spin source has been put in motion and a torsion field created, and then removed to another place, the space which surrounded the torsion field generator will continue to exhibit the effects of the torsion field for as long as several hours.

If we can delineate the dynamics which cause the persistence of residual field effects, we will be able to explain and harness the functional features attributed to dowsing, magnetically effected molecules of water and so on.^{xxviii} A clear and present example of the applications made possible by this information is illustrated by the work of a team of physicians from the CIS. Using the work of V. Kronin as the basis for their treatment modality, a team of Russian physicians has been working at the laboratories of the Centers For Disease Control in Atlanta, Georgia, and Baylor University Medical Research Center in Houston, Texas, for more than a year. Their project demonstrates a revolutionary new medical treatment modality which capitalizes on this attribute of torsion field mechanics, to fundamentally cure patients infected with the hepatitis-C virus.^{xxix}

Teams of scientists from more than 50 laboratories have shown that it is now feasible to deliberately perform a wide variety of carefully calibrated functions using torsion field devices.^{xxx} We can build torsion field generators of both static and radiating types.^{xxxi} We can select, adjust and fine-tune frequencies modulated into the field with a high degree of precision.^{xxxii} We can modulate into and retrieve data out of a torsion field, including via two dimensional spin matrices.^{xxxiii} We can operate efficiently in a variety of different modes of signal radiation.^{xxxiv} We can adjust and smooth the intensity of the S-waves and we can operate in both left and right S-wave chiral helicities.^{xxxv} (S waves are spinor waves.)

Torsion fields can be detected, generated and switched on and off (such as in communications applications).^{xxxvi} We have demonstrated that torsion fields can be designed to interact with laser beams^{xxxvii}, to modulate light frequencies and perform other functions. Torsion fields have been demonstrated to have a specific effect on biological processes^{xxxviii} and have been shown to be generated by certain melting and solidifying materials.^{xxxix} Torsion fields affect the oscillation of quartz crystals^{xl}, affect the functional characteristics of some electronic components^{xli}, and have been shown to have verifiable, measurable and predictable effects on gravity.^{xlii}

In practical fact, we can point to a long list of applications which could benefit from carefully planned applications engineering which recognizes the properties of torsion fields and harnesses them for practical purposes. Among these are revolutionary new propulsion systems, communications devices, long-range sensors, astrophysical monitoring and metering devices, geo-physical devices which can be calibrated to locate mineral deposits, water and subterranean structures; photographic applications which are capable of imaging the interior of virtually any substance or structure without X-rays and so on.

For more on the remarkable potential of the torsion field, see <http://www.ufodigest.com/news/0809/torsion-field-print.php>.

(Sources: David G. Yurth's unpublished book "Seeing Past The Edge"; Gary Vesperman's "Torsion Field Physics and Torsion Field Communications", www.padrak.com/vesperman.)

DISCLAIMER: Inclusion of any invention or technology described in this compilation of electrical energy innovations does not in any way imply its suitability for investment of any kind. All investors contemplating any investments in these devices and technologies should first consult with a licensed financial professional. Prospective investors should exhaustively perform their own investigation of pertinent facts and allegations of facts. Investors should also ensure thorough compliance with regulations of the federal Securities and Exchange Commission and appropriate state securities divisions. For more information, see <http://www.zpenergy.com/modules.php?name=News&file=article&sid=1655>.

ⁱ *The New Maxwell Electrodynamics Equations: New Tools for New Technologies*. A collection of 60 papers from the Alpha Foundation's Institute for Advanced Study. *Journal of New Energy*, Winter (1999) ISSN: 1086-8259

- ⁱⁱ L.B. Crowell, "Quantum Electrodynamics of NonAbelian Electrodynamics in a Cavity," *Journal of New Energy*, Volume 4 No.2, page 70-81, (Summer 1999).
- ⁱⁱⁱ Akimov, A.E., Finogenov, V. "P *Experimentainiya Proyavleniya Torsionnykh Polei i Torsionnye Tekhnologii*" ("Experimental Manifestations of Torsion Fields and Torsion-Based Techniques"), Moscow: *NTTs* "Informatekhnika," 1996, 68 pages, published by Sci-Tech Center "Informatekhnika." (in Russian).
- ^{iv} Swartz, M.R. "Generality of Optimal Operating Point Behavior in Low Energy Nuclear Systems," *Journal of New Energy*, Vol. 4, No. 2, pp. 218-229.
- ^v Anastasovski, P.K., Benson, T.M. *Quantum Mass Theory Compatible With Quantum Field Theory*, Nova Science Publishers, Inc. (1995) ISBN: 1.56072-157-X.
- ^{vi} Trefilov, A. et al I.N. Frantsevich Institute for Problems of Materials Science, Anthropos Files ref/
- ^{vii} Reed, D. "Torsion Field Research and Implications for New Physics and Energy Technologies," *Journal of New Energy*, Vol. 4, No. 2, pp 151-164 (Summer 1999).
- ^{viii} Santilli, R., *Il Grande Grido*, loc.cit.
- ^{ix} Akimov, A.E., "An Heuristic Discussion of an Issue of a Discovery of New Long Distance Interactions," *EGS-Concepts. MNTC VENT*, pre-print N7A, page 63 (in Russian); Akimov, Shipov, "Torsion Fields And Their Experimental Manifestations," *Journal of New Energy*, Vol. 2, No. 2, page 68, Summer 1997.
- ^x Dubrovsky, V. "Elastic Model of a Physical Vacuum," *DAN USSR*, vol 282, no 1, 1985 (in Russian).
- ^{xi} Nimtz, G. **Superluminal Signal Velocity**, *Annalen der Physik* 7, 618 (1998); see also G. Nimtz, W. Heitmann, **Superluminal Photonic Tunneling and Quantum Electronics**, *Progress in Quantum Electronics*, vol. 21, 81 (1997); see also, A. Enders, G. Nimtz, "Photonic Tunneling Experiments," *Physics Review*, B 47, 9605 (1993) regular paper; see also, A. Enders, G. Nimtz, **On Superluminal barrier Transversal**, *Journal of Physics (France)*, vol. 2, at pp. 1693 (1992); see also, G. Nimtz, A. Enders, H. Spieker, **Photonic Tunneling Experiments: Superluminal Tunneling**, Trani Workshop, 24-30 September 1992, Waves and Particles in Light and Matter. A.v.d. Merwe and A. Garuccio (eds.), Plenum Press, NY (1994).
- ^{xii} Associated Press, Light Can Break Its Own Speed Limit..., July 20, 2000.
- ^{xiii} Bunin, V.A. "Newest Issues of Gravitation in the Light of Classical Physics," *Proceedings 4th Astro-Geological Meeting Geographical Society of AS USSR*, L. 1962, page 88 (in Russian). See also V.A. Bunin, "Unitary Electra-Gravitation Equations of Mathematical Physics," *Auto-rephrases of speeches in the section entitled MOIP*, 1965, no 1, p 4 (in Russian).
- ^{xiv} Quantum Fields, LLC – Press Releases. Current NASA news is found at <http://www.grc.nasa.gov/Doc/news.htm>. On August 19, Quantum Fields, LLC, received word from NASA that their proposal submitted to the breakthrough propulsion physics program was selected for funding. A copy of the press release follows, along with a link to a summary of the proposal.
- (2) Jordan Maclay (Quantum Fields, LLC) Richland Center, WI) and MEMS Optical, Inc. (Huntsville, AL) proposed an experimental and theoretical study of quantum vacuum energy. The experiments will use micro-electromechanical devices to test force and energy effects by quantum electrodynamics.

FEASIBILITY OF COMMUNICATION USING QUANTUM CORRELATIONS

- For all space missions, it is imperative to have reliable communication links to transmit data, computer codes, or other information. The current electromagnetic communications technologies (including laser, RF, X band, S. band) do not scale well as the mission distance increases. With current methods, the power, weight, cost and complexity increase rapidly with distance, while the transmission reliability decreases. We propose to explore the possibility of a revolutionary approach to communications based on recent theoretical and experimental developments in quantum physics, in particular based on quantum correlations between entangled atoms or ions (EPR pairs). Recent experiments have verified the existence of quantum correlations between entangled photons, in which the polarization measurement of one photon is always correlated with the measured polarization of another, distant photon (*this is a specific reference to the work of Nicolas Gisin and his team at CERN, Geneva*). Theory indicates it is not possible to use standard quantum mechanical measurements on entangled systems, such as polarization correlations of photons, for communications. Current theory restricts but may not deny the possibility of using quantum mechanical correlations in small movements or adiabatic perturbations of entangled atoms as a communication means. Further, if non-linear modifications to quantum mechanics suggested by Nobel Laureate S. Weinberg are present, then EPR communications is clearly allowed. If experiment verified that the use of EPR pairs was viable, it should be possible to develop an almost ideal communications system, a compact, low weight, communication architecture in which no broadcast power or antenna is required, no environmental noise is present, the signal does not fall off as the inverse square of the distance, and high data rates with complete security are possible. The purpose of this effort is to investigate the possibility of using quantum correlations in the adiabatic movements of atoms as a means of communication, to perform an initial theoretical feasibility analysis, identifying the key issues with such an approach, and to propose an experiment to resolve some of the fundamental questions.
- ^{xv} Ramsay, B. "Generic Gravity Wave/ Scalar Detector," *Journal of New Energy, Proceedings of the 5th INE Symposium*, Vol.4, No. 2, Summer 1999, pp 148-150.
- ^{xvi} Hodowanec, G. *Hodowanec's Rhysmonic Cosmology*, a collection of notes, papers and articles authored by G. Hodowanec, reflecting some of the theoretical and experimental findings, as well as the 1985 monograph *Rhysmonic Cosmology*. Available c/o B. Ramsay Publisher, 563 29 ¼ Road #3, Grand Junction, Colo, 81504, (970)241-5863. See also Bill Ramsay, "Fixed Rate

- Scanning, Enigma or Research Tool?”, unpublished paper August 1997. See also, Bill Ramsay, “Exploring the Aethers: Adventures Inspired by Hodowanec’s Discoveries,” *Proceedings of the International Symposium on New Energy*, Denver, Colorado, May 12-15, 1994
- ^{xvii} Fiorenza, Nick Anthony “Gravitational Wave and Planetary Correspondence,” Argo Navis, Inc., 288 Bluff St. Suite 474, Boulder, Colorado, 80301, 1994. See also Alastair, “Measuring Gravity,” 181 Star Route, Hana, Hawaii, 96713. See also aquarius@t-link.net
- ^{xviii} Matveyenko, L.I. "Visible Superlight Speeds of Components Scattering Extra-Galactic Objects," *UPhN*, 1989, vol. 140, no. 3, p 469 (in Russian).
- ^{xix} Hameroff, S. et al, “Tubulin Dimers” ref/
- ^{xx} Akimov, Shipov et al, “Torsion Fields And Their Experimental Manifestations,” *Journal of New Energy*, vol 2, no 2, page 72, 1997.
- ^{xxi} Yurth, David. *The Anthropos Files* loc. cit.
- ^{xxii} Akimov, Shipov et al, “Torsion Fields And Their Experimental Manifestations,” *Journal of New Energy*, vol 2, no 2, page 74, 1997.
- ^{xxiii} Akimov, A.E. "Torsion Communications of the Third Millennium," Papers of the International Conference "Modern Telecommunication Technologies," Moscow, May 1995 (Russian). See also A. E. Akimov, G.I. Shipov, "Torsion Fields and Their Experimental Manifestations," *Journal of New Energy*, Vol. 2 No 2. 1997 @ page 78.
- ^{xxiv} Akimov, Shipov et al, “Torsion Fields And Their Experimental Manifestations,” *Journal of New Energy*, Vol. 2, No. 2, page 72, 1997.G.
- ^{xxv} Convegno Internazionale: “Quale Fisca per 2000?” Bologna, 1991. See also D. Yurth, *Anthropos Files*, ibid.
- ^{xxvi} David Yurth, *The Anthropos Files*, loc. cit. IPMS has also perfected the use of a specially modulated torsion field device to manufacture mono-molecular powders of strategic metals. Using this revolutionary manufacturing method, metals can be stored in conventional glass containers without involuntarily generating static electricity.
- ^{xxvii} Akimov, A.E., Binghi, V. “Homeopathy, Quantum Physics and Torsion Fields,” *Proceedings of the Congress of the International Homeopathic Association*, Kiev, Sept. 25-29, 1991, page 143 (in Russian). See also V. Binghi, “Induction of Metastable States of Water within the Framework of Torsion Field Concepts,” *CISE VENT*, 1991, preprint no 3, page 35. (in Russian).
- ^{xxviii} Harvalik, Z.V. *The American Dowser*, 1973, vol 13, no 3, page 85, 87. See also D. Chadwic, L. Jensen, Utah Water Research Lab., College of Engineering, Utah State Univ., Logan, 1971, page 120. See also S.W. Tromp, “Experiments on the Possible Relationship Between Soil Resisting and Dowsing Zones,” *Oegatgeest*, 1956.
- ^{xxix} The frequency signature of the hepatitis-C virus was mapped using infra-red spectrometry, a specially designed scalar interferometer and MRI technologies. The complex waveform which is mutually exclusive to the hepatitis-C virus was then fed into a desktop computer and converted to a waveform which was its phase conjugated opposite. The resulting waveform information was then fed to a torsion field generator which was used to irradiate a .5% molal solution of NaCl (Ringer's) for a period of 30 minutes. The ionic salt solution emitted a phase conjugated signal when fed into the patient’s system. The solution was infiltrated into the vascular system of 15 patients diagnosed with advanced cases of hepatitis-C. After 30 days of three-times-per-week treatment, 14 of the 15 patients were diagnosed as being completely free of any sign of infection. The 15th patient died during treatment from complications arising from an extremely advanced, chronic case of the disease. The technology is now being tested under double blind protocols by Dr. Robert Pennington and virologists at the Baylor University Medical Center.
- ^{xxx} Sciama, D.W. “The Physical Structure of General Relativity,” *Rev. Mod. Phys.*, 1964, no 36, page 463. See also D. Ivanenko, P. Pronin, G. Sardanashvilli, Calibrating Gravitation Theory, BGU Publ., Moscow, 1985, page 143 (in Russian). See also Ya Zeldovich, “Interpretation of Electrodynamics as Consequences of Quantum Theory,” *Pisma v. ZhETF.*, 1967, vol6 no 10, page 922 (in Russian). See also A. Sakharov, Vacuum Quantum Fluctuation in Curved Space and the Gravitation Theory, DAN, 1967, no 1, page 70 (in Russian). See also V. Bellin et al, “On Quantum Gravitation Effects in Isotrope Universe,” *ZhETF*, vol 6, 1980, page 2082 (in Russian).
- ^{xxxi} Akimov, A.E., Finogenov, V.P. "Experimentainiya Proyavleniya Torsionnykh Polei i Torsionnye Tekhnologii" (Experimental Manifestations of Torsion Fields and Torsion-Based Techniques), Moscow: *NTTs* “Informatekhnikha,” 1996, 68 pages, published by Sci-Tech Center “Informatekhnikha.”(in Russian).
- ^{xxxii} *ibid.*
- ^{xxxiii} *ibid.*
- ^{xxxiv} Ivanenko, D., Pronin, P., Sardanashvilli, G. "Calibrating Gravitation Theory," *BGU Publ.*, Moscow, 1985, page 143 (in Russian).
- ^{xxxv} *ibid.*
- ^{xxxvi} Fox, H., Ramsay, B. “The Super-Luminal Velocity of Gravity Waves,” Trenergy, Inc., Salt Lake City, Utah, 1998, 4 pages with references.
- ^{xxxvii} Obukov, Yu., Pronin, P., Yakushin, I. “On the Experimental Estimations of the Axial Torsion Mass and Coupling Constants,” in the press (in Russian). See also Ch. Imbert, "Calculation and Experimental Proof of the Transverse Shift Induced by a Total Internal Reflection of a Circularly Polarized Light Beam," *Phys. Rev. D*, 1972, vol 5, no 4, page 787 (in Russian). See also “Phantom DNA Effect” as defined by V. Poponin, loc.cit.

-
- ^{xxxviii} Zhvirblis, V.E. "Playing Bublik," *Chemistry and Life*, no 5, 1995, pages 10-15. See also V.A. Sokolova, "Investigation of the Plant's Response to the Action of Torsion Radiation," preprint no 48, Moscow: *VENT*, 1994, 32 pages. See also V.F. Panov, B.V. Testov, A.V. Klyuev, T.D. Afonina, ""Effect of Torsion Radiation on Mammals Organism," in: Reports Theses, PERM State Medical Academy, Scientific Session of 1997, PERM, (Russia), thesis no 159. See also [28]
- ^{xxxix} Kichigin, V.I., Klyuev, A.V., Kurapov, S.A., Panov, V.F., Khaldeev, G.V., Borisova, T.F. "Torsion Fields and Electrochemical Processes at Metal-Electrolyte Interface," *Journal of New Energy*, vol 1, no 2, 1996, pages 27-31. See also V.P. Mayboroda, A.E. Akimov, G.A. Maximova, V.Y. Tarasenko, V.K. Shkholniy, "Influence of the Torsion Fields in Tin Melt," *MNTP, VENT*, pre-print no 49, Moscow: 1994, 13 pages (in Russian). See also V.P. Mayboroda, A.E. Akimov, G.A. Maximova, V.Y. Tarasenko, V.K. Shkholniy, N.G. Palaguta, G.M. Moltchanovskaya, "Structure and Properties of Copper Inherited From a Melt After Applying to it a Torsion Emission," *MNTP, VENT*, pre-print no 50, Moscow: 1994, 11 pages (in Russian).
- ^{xl} Akimov, A., Kurik, M., Tatasenko, V. "Effect of Spinor (Torsion) Field on Crystallization of Micellar Structures," *Biotekhnologiya*, 1991, no 3, page 69 (in Russian). See also V. Zhitnikov, A. Kamenshchikov, V. Ponomarev, "Precision Gravity Measurements and New Types of Physical Interactions," Gravitational and Hypothetical Interactions, ed. By Ya. Teriletsky *UDN Publ.*, Moscow, 1989, page 3 (in Russian). See also C.I. Cheng, P. Li, K.I. Szeto, "Microscopic Detection of Spin-Dependent Long-Range Interaction," *Phys. Lett. A.*, 1991, n0 4-5, page 235 (in Russian).
- ^{xli} Reed et al., "Super-Luminal Velocity of Gravity Waves," loc.cit.
- ^{xlii} Obukhov, Yu., Pronin, P. "Physical Effects in Theory of Gravitation With Torsion," Moscow: *VINITI*, 1991, page 5 (in Russian).