

User Guide

Sharp FX PLUS

SHARP®



Sharp FX PLUS

Welcome!



Thank you for choosing the Sharp FX PLUS, our latest 3G Smartphone.

The Sharp FX PLUS has many features designed to enhance your mobile experience. From its unique, stylish design and best-in-class QWERTY keyboard to features like its bright 3.2" HVGA touch screen, Android Operating System, and Wi-Fi connectivity, we know you will enjoy the entire Sharp FX PLUS experience.

This User Guide contains important and useful information that will familiarize you with all the Sharp FX PLUS has to offer.

Conventions used in this guide

In this user guide, we use the following symbols to indicate useful and important information:

- NOTE** **NOTE** Notes, usage tips, or additional information
-  **Warning** Situations that could cause injury to yourself or others
-  **Caution** Situations that could cause damage to your device or other equipment

AT&T Legal

Devices purchased for use on AT&T's system are designed for use exclusively on AT&T's system. You agree that you won't make any modifications to the equipment or programming to enable the equipment to operate on any other system. A voice plan is required on all voice-capable devices, unless specifically noted otherwise in the terms governing your agreement. Some devices or plans may require you to subscribe to a data plan.

Your phone is designed to make it easy for you to access a wide variety of content. For your protection, AT&T wants you to be aware that some applications you enable may involve the location of your phone being shared. For applications available through AT&T, AT&T offers privacy controls that let you decide how an application may use the location of your phone and other phones on your account. However, AT&T's privacy tools do not apply to applications available outside of AT&T. Please review the terms and conditions and the associated privacy policy for each location-based service to learn how location information will be used and protected.

Your phone may be used to access the Internet and to download, and/or purchase goods, applications, and services from AT&T or elsewhere from third parties. AT&T provides tools for you to control access to the Internet and certain Internet content. These controls may not be available for certain devices which bypass AT&T controls.

AT&T may collect certain types of information from your device when you use AT&T services to provide customer support and to improve its services. For more information on AT&T's Privacy Policy, visit att.com/privacy.

earSmart



Sharp FX PLUS features earSmart™, an intelligent voice processor that delivers a clear voice experience, allowing you to hear and be heard™ in nearly all the environment. earSmart technology uses the science of human hearing to distinguish sounds, identify your voice and suppress surrounding noise, for clear conversations just about anywhere.

How Does it Work?

- The earSmart voice processor in your Sharp FX PLUS captures your voice and all the sounds around you.
- Working like the human ear, it processes and distinguishes these sounds, isolates your voice conversation, and removes background noise – from both ends of a call.
- It also automatically equalizes and adjusts voice volume so you can hear and talk naturally, even in the noisiest places.
- With earSmart technology, you can talk where you want, and have clear conversations for mobile calls, video chats, even speakerphone calls, without worrying about surrounding noise.

Contents

| | |
|---|-----------|
| Specifications | 7 |
| Basics | 8 |
| In Box | 8 |
| Phone Overview | 8 |
| Proper Holding Position..... | 9 |
| Battery..... | 10 |
| SIM Card | 11 |
| MicroSD Card | 12 |
| Turning Phone On or Off..... | 13 |
| Phone Options..... | 13 |
| Entering Your PIN..... | 13 |
| Finger Gestures..... | 14 |
| Keyboard..... | 15 |
| Using the QWERTY Keyboard | 15 |
| Using the Onscreen Keyboard | 16 |
| Using the Android Keyboard | 16 |
| Using Swype Text Entry Method | 18 |
| Editing Text..... | 21 |
| Getting Started..... | 22 |
| Google Account | 22 |
| Getting to Know the Home Screen..... | 24 |
| Customizing the Home Screen | 25 |
| Essential Display Icons..... | 26 |
| Notifications Panel | 28 |
| Opening and Switching Between Applications..... | 29 |
| Sleep Mode..... | 30 |
| Adjusting Volume | 31 |
| Searching Your Phone and the Web | 32 |
| Connecting Your Phone to a Computer..... | 33 |
| Phone Calls..... | 34 |
| Making Calls | 34 |
| Answering or Rejecting Calls..... | 36 |
| Using In-Call Options..... | 37 |
| Managing Multiple Calls | 38 |
| Using Call Log | 39 |
| Listening to Your Voicemail | 41 |
| Dialing by Voice | 41 |
| Contacts | 42 |
| About Contacts | 42 |
| Opening Your Contacts | 42 |
| Getting Started..... | 42 |
| Editing/ Deleting Contacts | 46 |

| | |
|---|------------|
| Communicating..... | 48 |
| Account Setting..... | 49 |
| Groups..... | 50 |
| Messaging..... | 52 |
| About Messaging..... | 52 |
| Sending Messages..... | 52 |
| Reading Messages..... | 54 |
| Changing Messaging Settings..... | 55 |
| Google..... | 56 |
| Gmail..... | 56 |
| Google Talk..... | 59 |
| Maps..... | 62 |
| Places..... | 65 |
| Navigation..... | 66 |
| Latitude..... | 68 |
| Calendar..... | 70 |
| News & Weather..... | 73 |
| Market..... | 74 |
| Web..... | 76 |
| Email..... | 76 |
| Browser..... | 79 |
| YouTube..... | 83 |
| Facebook..... | 86 |
| Twitter..... | 86 |
| Wi-Fi..... | 87 |
| Bluetooth..... | 88 |
| Using Bluetooth..... | 88 |
| Disconnecting or Unpairing from a Bluetooth Device..... | 89 |
| Connecting to a Bluetooth Headset..... | 89 |
| Sending and Receiving Information Using Bluetooth..... | 90 |
| Entertainment..... | 91 |
| Camera/Camcorder..... | 91 |
| Gallery..... | 93 |
| Videos..... | 95 |
| Sound Recorder..... | 95 |
| Music Player..... | 96 |
| Tools..... | 99 |
| Clock..... | 99 |
| Calculator..... | 100 |
| Memo..... | 101 |
| My Files..... | 101 |
| Polaris Office..... | 102 |
| AT&T Applications..... | 104 |
| AT&T Navigator..... | 104 |
| AT&T FamilyMap..... | 105 |

| | |
|--|------------|
| Ypmobile | 106 |
| Live TV | 106 |
| myAT&T | 107 |
| AT&T Code Scanner..... | 107 |
| Settings..... | 108 |
| Settings on Your Phone | 108 |
| Tethering/Dial-up Networking..... | 112 |
| USB Tethering for Windows Computer | 112 |
| USB Networking for Mac® | 113 |
| Safety Information | 117 |
| Safety Information for Wireless Handheld Phones..... | 117 |
| Hearing AID Compatibility with Mobile Phones..... | 119 |
| Safety Information for FCC RF Exposure | 119 |
| SAR Information | 120 |
| FDA Consumer Update..... | 121 |
| Emergency Calls | 125 |
| Compliance with Other FCC Regulations | 126 |
| General Safety | 126 |
| Battery..... | 127 |
| Adapter/Charger..... | 128 |
| Games | 128 |
| Recycle Your Cell Phone!..... | 129 |
| FCC Compliance Information | 130 |
| Copyright & Patent | 131 |
| Software Copyright Notice | 131 |
| Warranty | 132 |
| Manufacturer's Warranty..... | 132 |

Specifications

Display

- 3.2" HVGA (480x320 Pixels)

Camera

- 3.0 Mega Pixel Auto Focus

Size and Weight

- Size: 4.72 x 2.36 x 0.55 inch
- Weight: 5.29 oz

Memory

- 512MB (NAND Flash)/512MB (DDR SDRAM)
- External 2GB microSD Card

Operating Frequencies

- Networks: GSM/GPRS/EDGE (850/900/1800/1900 MHz)
UMTS/HSDPA(850/1900/2100 MHz)
Wi-Fi(802.11 b/g/n) (802.11n 2.4GHz only)
- Data speed: Up To HSDPA 7.2Mbps

Operating System

- Android 2.2 Operating System

Connectivity

- Micro SD card slot, Micro USB, 3.5mm headset jack, Bluetooth 2.1, Wi-Fi (802.11b/g/n)

Sensors

- A-GPS, Accelerometer, Light Sensor, E-compass, Proximity Sensor

Power Management (Performance)

| Battery Type | Capacity | Standby Time | Talk Time |
|---------------------|----------|-----------------|---------------|
| Lithium-Ion(Li-ion) | 1240mA | Up to 250 hours | Up to 3 hours |

Basics

In Box

The Sharp FX PLUS comes with the following items included in the box:

- FX PLUS Mobile Phone
- Micro USB cable
- Quick start guide
- 2GB microSD card (mounted in the device)
- Battery
- USB Power adapter
- Safety & Warranty Guide
- WiFi insert

Phone Overview

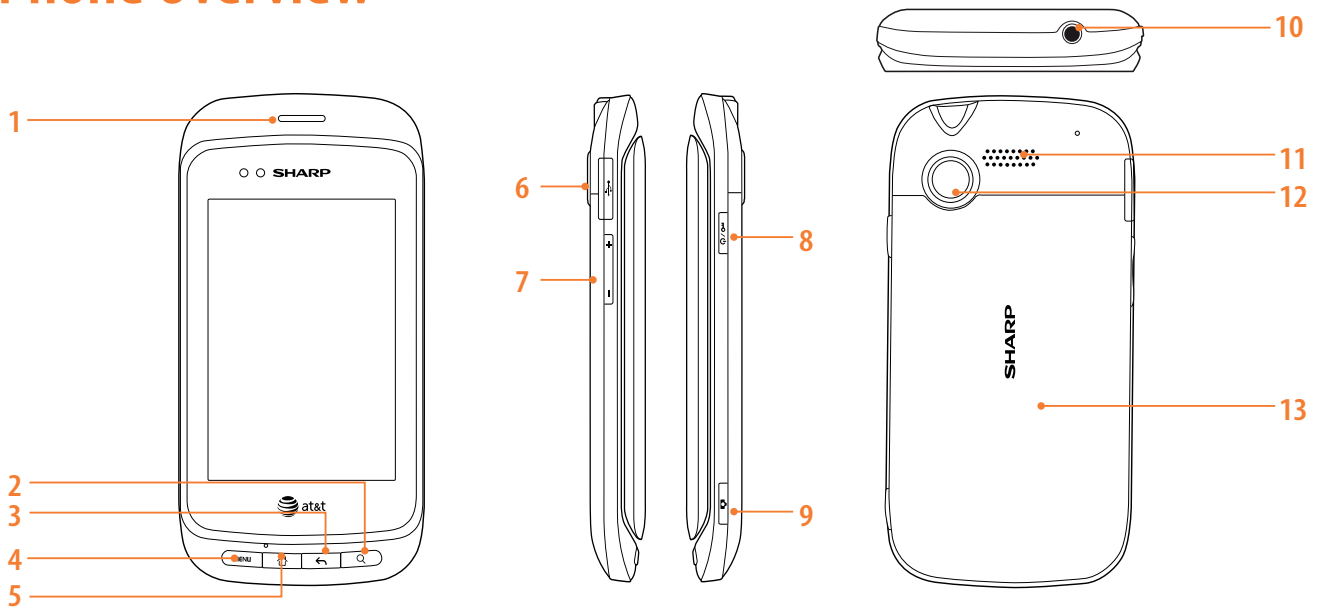

1. Earpiece

2. Search key

Quick search

3. Back key

Move to the previous screen

4. Menu key

Options

5. Home key

Move to Home screen

Press and hold : Show eight most recently used apps.

6. USB Port

Charging / PC connectivity

7. Volume key

Volume Up / Down

8. Power/Lock key

Short press: Screen lock mode

Press and hold: Power ON/ Phone Options

9. Camera key

Idle: Start Camera

Camera preview: Take a picture

Camcorder preview: Start video recording Camcorder

Recording: Stop video recording

10. Headset jack

3.5mm headset jack

11. External Speaker

12. Camera

13. Battery cover

QWERTY Keyboard Overview

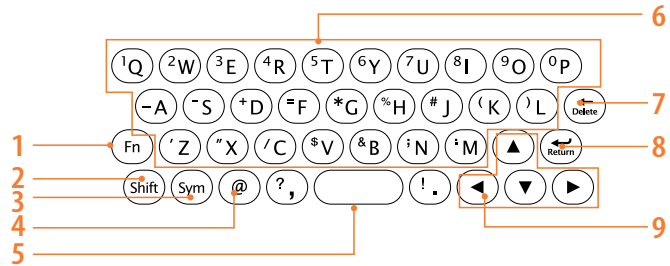

Your phone has a QWERTY keyboard which provides a superior typing experience for easy and comfortable texting. You can use all the phone functions from the QWERTY keyboard.

1. **Function key**
2. **Shift key**
3. **Symbol key**
4. **@**
5. **Space bar**
6. **A-Z**
7. **Delete key**
8. **Return key**
9. **Navigation keys**

Proper Holding Position

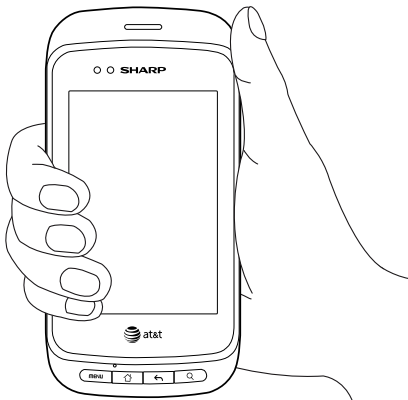

NOTE • The Sharp FX PLUS is equipped with an antenna located in the base of the unit. For optimum call quality, hold the phone along the sides and avoid touching the top and bottom of the phone while in a call.

Battery

Note that browsing the web frequently, extended data usage, being in a poor signal area, or subjecting the device to extreme temperatures will cause the battery to discharge quickly. To increase battery life, limit your data usage, or turn off Wi-Fi, GPS, and Bluetooth when not required.

Installing the battery



Please use only the original batteries and accessories you received with your phone or Sharp recommended replacements.

1. Remove the battery cover by sliding it down.
2. Align the battery's exposed gold contacts with the battery connectors inside the battery compartment.
3. Insert the contact side of the battery first and then gently push the battery into place.
4. Replace the battery cover by setting it to the back of the phone and sliding it into its place.

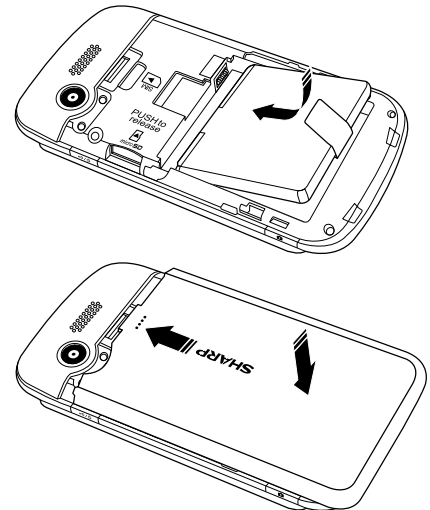

Removing the battery

1. Make sure that your device is turned off, and then remove the battery cover.
2. Lift up on the plastic battery tab to remove the battery.

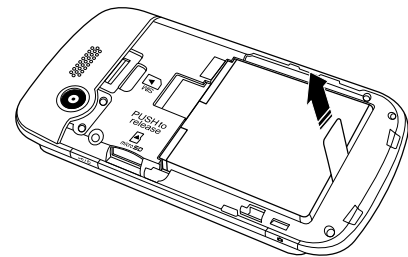

Charging your battery

Before you turn on your device and start using it, it is recommended that you charge the battery.

1. Plug the USB cable into the USB power adapter.
2. Plug the power adapter into a standard outlet.
3. To access the USB port located on the left side of your device, gently open the USB flap.
4. Plug the other end of the USB cable into the phone's micro USB port.
5. The USB icon on the cable should always face up when connecting the cable to your device as shown.

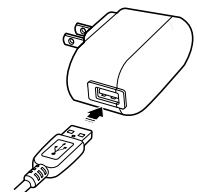

- NOTE**
- It is more efficient to charge the battery with your device powered off.
 - Battery operating time gradually decreases over time.
 - If the battery fails to perform normally, you may need to replace the battery.
 - The battery must be installed for the phone to work properly.

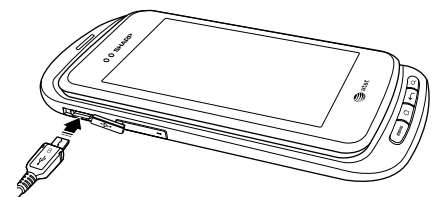

SIM Card

The SIM card contains your phone number and service details.

Inserting the SIM card

1. Make sure that your device is turned off, and then remove the battery cover.
2. Lift the battery out of the device.
3. Locate the SIM card slot, then insert the SIM card with its gold contacts facing down and its corner notch facing the battery cavity.
4. Slide the SIM card completely into the slot.
5. Replace the battery and battery cover.

NOTE - Only AT&T SIM cards can work with the Sharp FX PLUS.

Removing the SIM card

1. Make sure that your device is turned off, then remove the battery cover.
2. Lift the battery out of the device.
3. Slide the SIM card out of the slot with your finger.

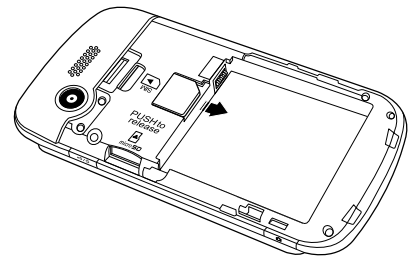
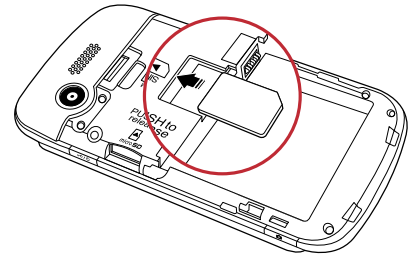

MicroSD Card

Use the microSD card to store your photos, videos, music and some memory card enabled Android applications. You can also move and copy files to your computer from your device.

Inserting the microSD card

1. Remove the battery cover.
2. Locate the microSD card slot.
3. Insert the microSD card into the slot with its gold contacts facing down until it clicks into the place.
4. Replace the battery cover.

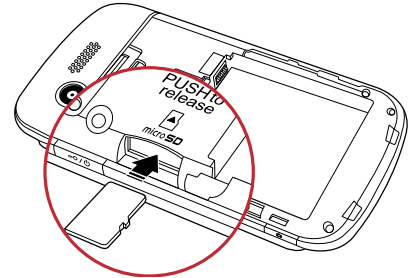



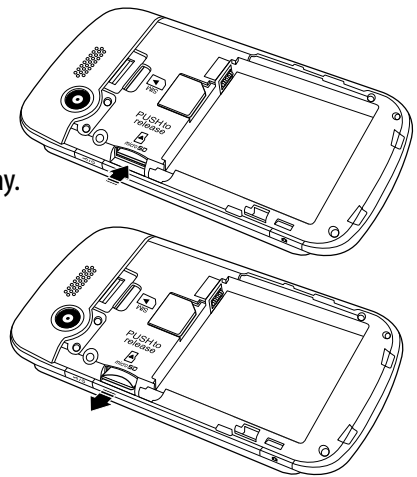

Removing the microSD card

1. Make sure that your device is turned off, and then remove the battery cover.
2. Press the microSD card to eject it from the slot, then slide it out the rest of the way.



Removing the microSD card while the phone is on

If you need to remove the microSD card while the phone is on, unmount the microSD card first to prevent corrupting or damaging the files in the microSD card.

1. From the Home screen, tap  **Apps** >  **Settings**. Or press  **Menu** >  **Settings**.
2. Tap  **SD card & phone storage** > **Unmount SD card** > **OK**.
3. Remove the microSD card by following the steps in “**Removing the microSD card**”.



Turning Phone On or Off

Turning your phone on

1. Press and hold  **Power/Lock**.

NOTE The first time you use your phone you'll need to set it up. See the Getting Started chapter for details.

Turning your phone off

1. If the display is off, press any of the 4 buttons on the front of the phone or  **Power/Lock** to turn it back on.
2. Press and hold  **Power/Lock** for a few seconds.
3. When Phone options menu appears, tap  **Power off** > **OK**.

Phone Options

Silent mode

1. Press and hold  **Power/Lock**.

2. Tap  **Silent mode**.

- When you select Silent mode,  is displayed in the Status bar. Ringtones, alerts, and all audible sounds EXCEPT media and alarms are silenced.

NOTE To turn silent mode off, press and hold  **Power/Lock** and then tap  **Silent mode** again. You can also press the down volume key until the vibrate phone icon appears  and then you can resume audio by pressing up on the volume keys.

Airplane mode

1. Press and hold  **Power/Lock**.

2. Tap  **Airplane mode**.

- When you set Airplane mode,  is displayed in the Status bar. WiFi, Bluetooth, and mobile network functions are all disabled.

NOTE To turn airplane mode off, press and hold  **Power/Lock** and then tap  **Airplane mode** again.

Entering Your PIN

Some SIM cards come with a PIN (Personal Identification Number) set by your mobile operator. If you're asked for a PIN, enter it, and then tap **OK**.

NOTE If you don't know your PIN, you can contact your mobile operator's customer service center.

Finger Gestures

| | |
|----------------|---|
| Tap | To select onscreen items such as application and settings icons or press onscreen buttons, simply touch them with your finger. |
| Tap and hold | To open available options for the item, simply touch and hold your finger on the screen over the item. |
| Swipe or slide | Quickly drag your finger vertically or horizontally across the screen. |
| Drag | Tap and hold your finger before you start to drag. While dragging, do not release your finger until the item reaches your desired location. |
| Flick | Flicking the screen is similar to swiping, but you only need to swipe your finger in lighter and quicker strokes. This finger gesture is always in a vertical direction, such as flicking through the contacts or the message lists. |
| Rotate | For most screens, you can automatically change the screen orientation from portrait to landscape by turning the phone sideways. When entering text, you can turn the phone sideways to bring up a bigger on-screen keyboard. When you slide up the screen to use QWERTY keyboard, the screen automatically rotates to landscape mode and closes the on-screen keyboard. |

Keyboard

Using the QWERTY Keyboard

Your device has a specially designed QWERTY keyboard that provides a superior, easy, and comfortable typing experience on the Sharp FX PLUS.

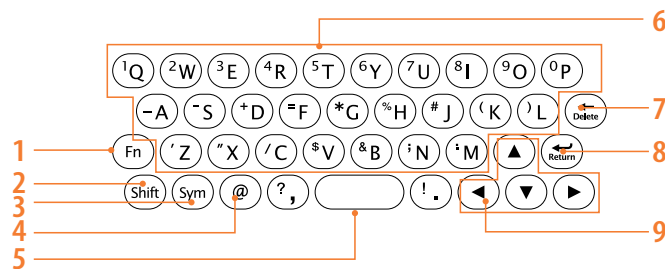

| | |
|-------------------------------|--|
| 1. Fn (Function key) | To type the number or symbol printed on the keys in blue, hold down the Fn key and press one or more letter keys. To return to typing letters, release the Fn key. To continuously type numbers and symbols, press Fn key twice to lock it. Press Fn again to unlock. |
| 2. Shift (Shift key) | To type upper-case letters, hold down the Shift key and press one or more letter keys. To return to typing lower-case letters, release the Shift key. |
| 3. Sym (Symbol key) | Pressing the Sym key opens a pop up menu of additional symbols. |
| 4. @ | To type "@" |
| 5. Space bar | To type a blank space. Pressing the Space bar two times enters a period and moves the cursor over one space. |
| 6. A-Z (alphanumeric keys) | To enter numbers, letters or special characters. Go to the Google Search screen if pressed on the Home screen. |
| 7. Delete (Delete key) | To delete a character. Press and hold to rapidly delete the entire entry. |
| 8. Return (Return key) | To begin a new line or to select an item. |
| 9. Navigation keys | To move left, right, up, down. |

NOTE For better performance in low-light environments, your handset includes a backlight feature which illuminates the QWERTY keyboard so you can type with ease.

Using the Onscreen Keyboard

In addition to the QWERTY keyboard you can also enter text using the onscreen keyboard. Some applications open the keyboard automatically. In others, tap anywhere in a text field to open the keyboard. You can choose between two included on-screen keyboards to select the one that best fits your typing preferences.

| | |
|------------------|--|
| Swype | Swype lets you enter a word in one continuous motion. To enter a word, just drag your finger over each letter in the word without lifting your finger. |
| Android keyboard | This keyboard is similar to a desktop computer's keyboard. This is the standard Android keyboard layout. Android keyboard is selected as the default entry method. |

- If you want to change the on-screen keyboard type: Tap and hold the text input field > tap **Input method** > select **Swype** or **Android keyboard**.
- Remember, the Sharp FX PLUS has a built-in QWERTY keyboard, which you can use for all phone functions.

NOTE You can change all keyboard settings including User dictionary through the settings menu. From the Home screen, tap  **Apps** >  **Settings** >  **Language & keyboard**. Or press  **Menu** >  **Settings** >  **Language & keyboard**.

Using the Android Keyboard

Displaying the keyboard and entering text



If you want to switch from Swype to Android keyboard, tap and hold the text input field > tap **Input method** > select **Android keyboard**.

Use the following keys while entering:





| | |
|---|---|
| 1 | Tap the suggestion to enter it. |
| 2 | Shift key. Tap once to capitalize the next letter you type. Tap and hold it for all caps. |
| 3 | Symbol key. Tap to switch to the numeric and symbol keyboard. |
| 4 | Microphone key. Tap to enter text by speaking. |
| 5 | Backspace key. Tap to delete the previous character. |
| 6 | Enter key. Tap to create a new line. |

1. Tap the text field to open the onscreen keyboard.
2. Tap the on screen keys to type.
 - The characters you've typed appear in a strip above the keyboard with word predictions to the right. Tap a suggested word to enter it.

- Use  to erase characters to the left of the cursor.
- When you've finished typing, press  **Back** to close the keyboard.



To enter numbers, symbols, and other characters

| | |
|---|--|
| Tap  | To switch to the numeric keyboard. |
| Tap  on the numeric keyboard | To view additional symbols, tap it again to switch back. |
| Tap and hold a vowel or the C, N, or S key | To open a pop up menu to select an accented vowel or other alternate letter. |
| Tap and hold  | To open a pop up menu with a set of common symbols. |
| Tap and hold a number or symbol key | To open a pop up menu of additional symbols. Not all keys have additional symbols. |

- Slide your finger smoothly up from the main keyboard to open an extension keyboard, with numbers and symbols. To enter a number or symbol from that keyboard, slide your finger onto it and then lift your finger. When you lift your finger, the extended keyboard will no longer be visible.
- When you tap a key, a larger version displays briefly over the keyboard. Keys with alternate characters display an ellipsis (...) below the character.



Changing the keyboard language

Selecting the Android keyboard languages

- Tap a text field to open the onscreen keyboard.
- Tap and hold  > **Android keyboard settings**.
- Tap **Input languages** > Select one or more languages.
- Press  **Back** to save.

Changing the keyboard language

If you've selected more than one keyboard language, the active keyboard language is displayed on the Space bar. You can switch languages easily as follows:



- Tap and hold .
- Without lifting your finger, move it to the left or right until the language you want appears in the center of the small window above .
- Lift your finger.







If you have many languages available, you may have to repeat the above steps to reach your desired language.

Entering the text by speaking

You can use voice input to enter text. Voice input is an experimental feature using Google's speech-recognition service. You must have a data connection on a mobile or Wi-Fi network to use voice input.

Turning on voice input

If the onscreen keyboard does not display , voice input is not turned on or you have configured it to display  only on the symbol keyboard.



- From the Home screen, tap  **Apps** >  **Settings**. Or press  **Menu** >  **Settings**.
- Tap  **Language & keyboard** > **Android keyboard**.
 - You can also tap and hold  on the onscreen keyboard. In the dialog that opens, tap **Android keyboard settings**.

3. Tap **Voice input**.

4. Tap the option for where you want to use  (**On main keyboard** or **On symbols keyboard**). Or tap **Off** to turn off voice input.

Entering text by speaking

You can enter text by speaking, in most places that you can enter text with the Android keyboard.

1. Tap a text field.
2. Tap the  on the keyboard.
3. When prompted to "Speak now," speak what you want to enter.
 - Say "comma," "period," "question mark," or "exclamation point" to enter punctuation.
 - When you pause, what you spoke is transcribed by the speech-recognition service, entered in the text field and underlined. You can tap  to erase the underlined text. If you start typing or entering more text by speaking, the underline disappears.
 - You can edit the on screen text by typing or speaking.

Using Swype Text Entry Method

Entering text using the Swype keyboard

Swype lets you enter a word with one continuous motion: just drag your finger over the letters in the word.





1. Place your finger on the key with the first letter of the word and drag your finger to each subsequent letter without lifting your finger off the screen.
2. Continue until you have finished the word. Lift your finger after the last letter.
3. If Swype cannot clearly determine your word, the word choice window opens. Select an alternative word from the list.
 - For example, to enter 'Love': Trace from **l** to **o** to **v** to **e**. To capitalize a letter, drag your finger above the keyboard after each letter you want to capitalize.







Adding, Editing or Deleting Words in the User Dictionary

Sometimes you may need to add a word to the predictive text dictionary, for example a name or a specialized technical word. If you want to add a word to your User dictionary while entering text, double tap the word to highlight it, then tap and hold the word and select **Add ** to dictionary**.

Adding a word manually

1. From the Home screen, tap  **Apps** >  **Settings**. Or press  **Menu** >  **Settings**.
2. Tap  **Language & keyboard** > **User dictionary**.
3. Press  **Menu** >  **Add**.
4. Type the word > Tap **OK**.

Editing or deleting a word

1. From the Home screen, tap  **Apps** >  **Settings**. Or press  **Menu** >  **Settings**.
2. Tap  **Language & keyboard** > **User dictionary**.
 - To edit words from the dictionary, tap the word you want to edit > **Edit** > Edit the word > Tap **OK**.
 - To delete words from the dictionary, tap the word you want to delete > **Delete**.

Editing Text

You can select, copy or cut the text you've entered, then paste it in another text field within the user interface.

NOTE Some applications may offer different text editing methods.

Selecting text

1. Tap the text field.
2. Move the cursor to the beginning or end of the desired text by tapping in the location you want the cursor.
3. Tap and hold the text field.
4. Tap **Select text** in the pop up menu.
 - Or tap **Select all** to select all the text in the text field.
5. Drag your finger to move the text cursor to a letter within the text that you want to select. The selected text is highlighted in orange.

Selecting text using the navigation keys

1. Tap the text field.
2. Use the navigation keys on the QWERTY keyboard to move the cursor to the beginning or end of the desired text.
3. Press **Shift** and the navigation ◀ , ▶ button on the QWERTY keyboard to highlight text.

Cutting and copying the text

1. Select the text to cut or copy it.
2. Tap and hold the selected text.
3. Tap **Cut** or **Copy** in the menu that opens.
 - If you tap **Cut**, the selected text is removed from the text field. In this case, the text is saved to the clipboard, so that you can paste it into another text field.

NOTE Be sure to only cut one section of text at a time, as the clipboard only saves a single text string.

Pasting the text

1. Cut or copy the text to paste.
2. Tap the text field where you want to paste the text and move the cursor to your desired location.
 - You can paste text that you copied from one application into the text field in any other application.
3. Tap and hold then select **Paste** in the pop up menu.
 - The text is inserted after the cursor. The text also remains in the clipboard, so you can paste that same text into another location.

Getting Started

Google Account

You must sign in to a Google account to use Gmail, Google Calendar, and other Google applications; to download applications from Android Market; to back up your settings to Google servers; and to take advantage of other Google services on your phone.

Set Up Wizard



To complete the startup wizard and add a Google account, a network connection is required.

1. Tap the android to begin.
2. Tap **Begin** to learn more about Google account. If you want to bypass this information, tap **Skip**.
3. Tap **Sign in** to sign in to your Google account.
 - If you don't have a Google account, tap **Create**. Go to 'Creating a new Google account' on the next page.
4. Enter your Google account **Username** and **Password** > Tap **Sign in**.
5. Select your preferences for Google's location services and tap **Next**. Then confirm the back-up data service selection and tap **Next**.
6. The Home screen appears. You are now ready to use your phone.
 - Once a Google account is added, your existing contacts and Gmail messages are downloaded to your phone. Contacts, Gmail and Calendar data will be synchronized between your phone and your online Google account.

NOTE For more details on signing in or creating a Google account, please see the following sections.

Registering a Google Account



Gmail, Android Marketplace, and some other applications require a valid Google account for use. If you did not login or create an account during the initial phone setup, you will be prompted to login in to Google the first time you use these applications.

1. Tap **Sign in** to register your Google account.
 - If you don't have a Google account, tap **Create** instead. See the next section for more details.
2. Enter your Google account **Username** and **Password** > Tap **Sign in**.



Creating a new Google account

1. Tap **Create** > Enter **First name**, **Last name** and **Username** > Tap **Next**.
2. Enter a password in to the **Type a password**, **Confirm password** fields, then tap **Next**.
 - Password tip: Your password must be a minimum of 8 characters in length.
3. Select **Security question** and enter the **Answer**, which will be needed if you forget your password and then enter a **Secondary Email** > **Create**.
4. Read through Google Terms of Service > Tap **I agree**, **Next**.
5. Enter the letters shown on the screen > Tap **Next** > Tap **Finish**.

Adding a Google account

1. From the Home screen, tap  **Apps** >  **Settings**.
2. Tap  **Accounts & sync** > **Add account**.
3. Tap **Google** > Tap **Next**.
4. Tap **Sign in** to register your Google account.
5. Enter your Google account **Username** and **Password** > Tap **Sign in** > **Finish**.
 - The Sharp FX PLUS supports multiple Google accounts.
 - If you have the same contact across multiple Google accounts, you can merge duplicates into a single item in the contact list.

Removing a Google account

1. From the Home screen, tap  **Apps** >  **Settings**.
2. Tap  **Accounts & sync**.
3. Select the account to be deleted > Tap **Remove account** > **Remove account**.
 - All information associated with that account will be deleted. This includes contacts, emails, messages, calendar events, etc. At least one Google account is required for normal phone operation.

NOTE The phone must be reset to remove a solitary Google account.

Getting to Know the Home Screen

The Home screen is displayed when the device is in idle mode. You can add your favorite apps, shortcuts, folders and widgets to the Home screen so they're only a tap away.

The Home screen is actually seven separate screens. Slide your finger the left or right and you'll discover more space to add icons, widgets, and more. Press  **Home** to return to the center Home screen.



Previewing the Home screens









1. From any Home screen, tap and hold  **Apps**.
2. When you choose a desired Home screen, the display shifts to the selected Home screen.

Customizing the Home Screen

The Home screens and display wallpaper are extensively customizable.

Home screen customization options

1. Open the Home screen you want to customize.
2. Press  **Menu** >  **Add**. Or just tap and hold an empty area on the Home screen.
3. On the menu that appears, select from the following choices.



| | |
|--|---|
|  Shortcuts | Shortcuts can cover such functions as Applications, Bookmark, Contact, Direct dial, Direct message, Directions & Navigation, Gmail label, Latitude, Music playlist and Settings. |
|  Widgets | Widgets are mini-applications for functions as Analog clock, Bookmarks, Calendar, Digital Clock, Dual Clock, Facebook, Google Search, Home screen tips, Latitude, Mail, Market, Message, Music Player, News & Weather, Picture frame, Power Control, Rate Places, Sharp cal., Sharp clock, Twitter(large), Twitter(small), Weather and YouTube. |
|  Folders | If you create a new folder, you can drag icons into the folder to organize them. |
|  Wallpapers | You can choose from your Gallery photos , Live wallpapers or static Wallpapers to change the display background. |

Moving an item on the Home screen



1. From the Home screen, tap and hold the item you want to move until it vibrates. Don't lift your finger.
2. Drag the item to a new location on the Home screen.
3. Lift your finger at the location where you want the item.



To add a shortcut to any application from the Launcher, tap  **Apps**, tap and hold the item, then drag it off the Launcher and onto a Home screen.

Removing an item from the Home screen

1. From the Home screen, tap and hold an item until it vibrates. Don't lift your finger. The Dock menu changes into the .
2. Drag the item to the .
3. When the item turns red, lift your finger.

Changing the Wallpaper of the Home screen

1. From the Home screen, press  **Menu** >  **Wallpaper**. Or just tap and hold any empty area on a Home screen >  **Wallpapers**.
2. Tap one of the following:

| | |
|---|--|
|  Gallery | Choose a photo from your camera gallery or memory card storage. You can crop the image before setting it as the wallpaper. |
|  Live wallpapers | Choose from pre-loaded animated wallpapers. Additional live wallpapers can be downloaded from the Google Marketplace. |
|  Wallpapers | Choose from the pre-loaded animated or static wallpapers. Additional wallpapers can be downloaded from the Google Marketplace. |

3. Tap **Save** or **Set wallpaper**.

Renaming a folder



































1. Tap the folder to open it.
2. Tap and hold the title bar of the folder window.
3. Enter a new name in the dialog box that appears, and then tap **OK**.

Essential Display Icons





























Status icons

You can tell a lot about your phone when you understand the icons in the Status bar. Here's what each one means:

| | | | |
|---|---|---|-----------------------------------|
|  | Signal strength |  | Synchronization error |
|  | No signal |  | Wi-Fi is on but not connected |
|  | Airplane mode |  | Connected to a Wi-Fi network |
|  | GPRS connected |  | TTY connected |
|  | GPRS data downlink active |  | Battery is full |
|  | GPRS data uplink & downlink active |  | Battery is charging |
|  | EDGE connected |  | Remaining battery life |
|  | EDGE data downlink active |  | No battery |
|  | EDGE data uplink & downlink active |  | Unknown battery |
|  | 3G connected |  | Silent mode-no audio or vibration |
|  | 3G data downlink active |  | Vibrate only mode |
|  | 3G data uplink & downlink active |  | Speakerphone is on |
|  | 3G voice connection only (WiFi data in use) |  | Wired headset connected |
|  | 3G (HSDPA) connected |  | Bluetooth is on |
|  | 3G (HSDPA) data uplink & downlink active |  | GPS is on and active |
|  | 3G (HSDPA) voice connection only (WiFi data in use) |  | Bluetooth device connected |
|  | Data synchronizing |  | Tethering or USB connected |

Notification icons

Notification icons in the Status bar alert you to items that may require your attention such as new messages, calendar event reminders, missed call notifications, etc. Here's what each one means:

| | | | |
|---|---------------------------------------|---|---|
|  | Call in progress |  | Downloading data |
|  | Call using a Bluetooth headset |  | Uploading data (animated) |
|  | Call on hold |  | General Alert Icon |
|  | Call forwarding is active |  | USB debugging connected |
|  | Missed call |  | No microSD card installed |
|  | Connected to a computer via USB cable |  | MicroSD card is being prepared |
|  | Storage card memory is low. |  | Microphone is muted |
|  | More (not displayed) notifications |  | Alarm is set |
|  | Network sharing is on |  | Wi-Fi is on and wireless networks are available |
|  | New Google Talk instant message |  | Bluetooth Sharing is on |
|  | New voicemail |  | AT&T Hotspot connected |
|  | New message |  | Updates available (Market) |
|  | New Gmail |  | Twitter sync |
|  | New Email | | |

Notifications Panel

When you receive a new notification, an icon will be displayed in your status bar at the top of your screen.

Viewing and responding to Notifications

1. Tap and hold Status bar, and then slide your finger downward to open the Notifications panel.



2. If you have multiple notifications, you may need to scroll to see them all.
3. Tap a notification to respond to it.

Closing the Notifications panel

Drag the bottom bar of the panel up. Or just press  **Back**.

Opening and Switching Between Applications

The Launcher, which you open from the Home screen, shows the icons of all installed applications on your phone.

Opening and closing the Launcher

1. To open, from the Home screen, tap  **Apps**.
2. To close, press  **Home** or  **Back**.

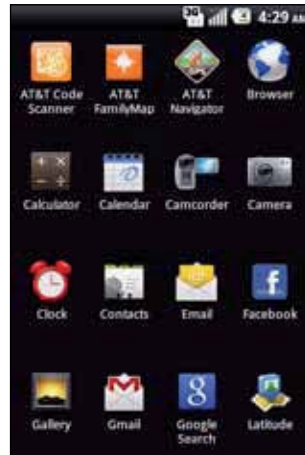

Switching to a recently used application

1. From any screen, press and hold  **Home**.



2. Tap an icon to open the application or press  **Back** to return to your previous screen.

Sleep Mode

Sleep mode saves battery power by turning off your display. You will still receive messages and calls when the display is turned off.





Switching to Sleep mode

Press  **Power/Lock** to switch your phone to Sleep mode.

Your phone automatically turns off the display after a period of inactivity. To customize the screen timeout settings, from the Home screen, tap  **Apps** >  **Settings** >  **Display** > **Screen timeout**.

Waking up from Sleep mode

Your phone automatically wakes up when you have an incoming call.

To wake it up manually, slide open the QWERTY keyboard or press  **Power/Lock**,  **Back**,  **Menu**,  **Home** or  **Search**. You'll need to unlock the screen as described below.





Unlocking the screen

On the lock screen, tap the unlock icon and slide your finger in the direction of the arrows to unlock the screen.

The screen unlocks automatically when you answer an incoming call.

NOTE If you have set up a screen unlock pattern, pin, or password, you will be asked to draw the pattern on the screen or enter the PIN or password to access the phone software.

Activating Secure Screen Lock





1. From the Home screen, tap  **Apps** >  **Settings**. Or press  **Menu** >  **Settings**.
2. Tap  **Location & security** > **Set up screen lock**.
 - If you have already configured the screen lock, tap **Change screen lock** to change how to lock or unlock your screen.
3. Tap **Pattern**, **PIN**, or **Password**. And then, enter a custom pattern, PIN or password as prompted.
 - If you select 'None', screen unlock security is cancelled.

Adjusting Volume



Ringtone and Media volume are independent of each other and adjusted separately.

Adjusting the ringer volume

From the Home screen, press  **Volume up** or  **Volume down** on the left side of the phone to adjust the ringer volume to your desired level.

- While in the lowest ringer volume level, press  **Volume down** once to set your phone to Vibrate mode. Press  **Volume down** again to set your phone to Silent mode.
- While in the Silent mode, press  **Volume up** once to switch to Vibrate mode. Press  **Volume up** again to switch to ringtone mode.



Adjusting the media volume

While playing music, watching a video or using preloaded or downloaded games or applications, press  **Volume up** or  **Volume down** on the left panel of the phone to adjust the media volume.

Adjusting the earpiece volume for phone calls

During a phone call, press  **Volume up** or  **Volume down**.

Adjusting the volume via Settings menu



1. From the Home screen, tap  **Apps** >  **Settings**. Or press  **Menu** >  **Settings**.
2. Tap  **Sound** > **Volume**.
3. Drag the volume sliders left or right to adjust your phone's Ringtone, Media, and Alarm. Your phone plays a sample tone at the selected volume level while you drag the slider.

NOTE If you uncheck the option to use call volume for notifications, you can set the notification ringtone volume independently.

4. When you're done, tap **OK**.

Searching Your Phone and the Web



The search key is a powerful part of the Sharp FX PLUS's software and enables you to quickly locate files, contacts, and applications. You can also search the web using your favorite web search service.

1. Press  **Search**. Or tap  **Apps** >  **Google Search**.
2. Begin entering text, or tap a previously used search term.
 - As you enter the text, matching items on your phone and suggestions from Google web search will appear on the screen.
3. Tap a suggestion to go directly to that result.





| | |
|---|---|
| 1 | Tap to change the target of your search location(All, Web, Apps or Contacts). |
| 2 | Type in your search criteria. |
| 3 | Tap to search by voice. |
| 4 | Suggested similar or previous searches. |

Setting search options

1. Press  **Search**.
2. Press  **Menu** >  **Search settings**.
3. Tap any of the following:

| | | |
|-------|------------------|---|
| Web | Google search | Show web suggestions, Use My Location, Search history, Manage search history. |
| Phone | Searchable items | Opens list of searchable locations on your phone. |
| | Clear shortcuts | Erases the list of previously chosen search suggestions. |

Using Voice search

1. Press and hold  **Search**.
Or tap the  in the Google search box or in the Browser's URL box.
2. Speak what you want to search for.
3. Searched words with similar pronunciations are listed. If you select a desired search result, the Google result appears with the corresponding keyword.
 - If you speak inaccurately, the desired keyword may not appear.

Connecting Your Phone to a Computer

Copying files to/from the microSD card

You can copy your music, photos, and other files to the microSD card of your phone.

NOTE • This option is available only when a microSD card is inserted into the slot of your phone. While your phone is connected to a computer, USB Mass storage mode prevents you from using applications that access the memory card.









1. Connect your phone to your computer using the supplied USB cable.
2. Open the Notifications panel > Tap **USB connected**.
3. Tap **Turn on USB storage**.
On your computer, the connected phone is recognized as a removable hard drive.
4. Navigate to the removable drive and open it.
5. Do one of the following:
 - Copy the files from the computer to the microSD card's root folder.
 - Copy the files from the phone's microSD card to a folder in your computer.
6. After copying the files, unmount the removable drive (that is, the connected phone) as required by your computer's operating system to safely remove your phone.
7. After you have unmounted the removable drive, you can disconnect the phone from the computer.

Phone Calls

Making Calls







The simplest way to make a call is to dial the number directly. You can also call numbers listed in your call log or Contacts list.

Making a call from the dialer screen



1. From the Home screen, tap  **Phone**.
2. Tap the number you want to dial.
 - If you make a mistake, tap  to erase a single character. Tap and hold  to erase the entire string.
3. Tap .
 - The Calling screen is shown and the  icon appears in the Status bar while the call is active.
 - To change the volume during a call, press  **Volume up** /  **Volume down**.
4. To end the call, tap .

Entering a Pause/Wait

Pause and wait options can help you dial additional numbers such as a voicemail password, or phone banking system menus.







1. From the Home screen, tap  **Phone**.
2. Tap the number you wish to dial > Press  **Menu** >  **Add 3-sec pause** or  **Add wait**.
 -  **Add 3-sec pause**: Your phone will wait for 3 seconds then continue to dial the remaining numbers automatically.
 -  **Add wait**: Your phone will wait with the message, 'Send the following tone?' until **Send** is tapped, then continue dialing the remaining numbers.

Making an international call









1. From the Home screen, tap  **Phone**.
2. Tap and hold **0** until the international prefix '+' appears.
3. Tap the country code, area code, and phone number.
4. Tap .

Calling a number from the Call log

Your phone logs all incoming and outgoing calls.

1. From the Home screen, tap  **Phone** >  **Call log**. Or tap  **Apps** >  **Contacts** >  **Call log**.
2. Tap  at the right of any entry to dial.
 - Calls are listed with the most recent at the top.
 - Calls to the same phone number are grouped together.
 - Scroll up or down to view additional entries in the log.
 - If you want to edit a number before calling, tap and hold the desired number, and then tap **Edit number before call**.



Making a call from the Contact list

1. From the Home screen, tap  **Phone** >  **Contacts**. Or tap  **Apps** >  **Contacts**.
2. Scroll through the contact list.
 - To find a specific contact, you can search by pressing  **Search** or press  **Menu** >  **Search**. Enter the name of the contact you're searching for. As you type, contacts with matching names appear below the search box. Or you can use the tab on the right hand side of the screen to scroll through the alphabetical contacts.
3. Tap the contact you want to call.
4. Tap .



Making an emergency call

In addition to 911, your phone supports international emergency numbers such as 112. Emergency calling is supported anywhere the phone has a network signal.

Making an emergency call

1. From the Home screen, tap  **Phone**.
2. Tap the emergency number for your location. This is usually 911.
3. Tap .
4. To end the emergency call, tap .

Making an emergency call while the phone is locked

1. Tap **Emergency call**.
2. Tap the emergency number for your location. This is usually 911.
3. Tap .
4. To end the emergency call, tap .



Answering or Rejecting Calls

When you receive a phone call, the screen displays the caller's name, phone number, and caller ID icon (if stored in Contacts).

When you receive a phone call from a phone number not stored in your Contacts, only the default caller ID icon and phone number are shown.

All incoming calls are recorded in the Call log. If you miss a call, you receive a reminder notification.

Answering or rejecting an incoming call

1. Drag the  icon in the direction of the arrows to answer the call.
Or drag the  icon in the direction of the arrows to reject the call.
 - If you were already in a call, the first call is placed on hold during answering the new call.
 - To silence the ringer before answering the call, press either of the volume keys.

NOTE The caller you reject is sent directly to your voicemail box to leave a message.

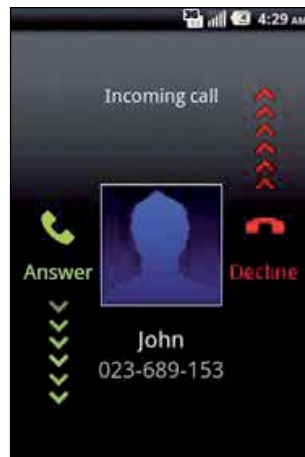







Checking missed calls

- If you miss a call,  is displayed in the Status bar.
- If you open the Notifications panel, you will see the number of missed calls. Tap the notification to be taken to the call log and view detailed information.

Using In-Call Options

When a call is in progress, the following options are available:

| | |
|--|--|
| Bluetooth | When a Bluetooth device is paired and connected to your phone, you can conduct all calls using Bluetooth for hands-free conversation. When using Bluetooth headset during a call, the current call screen has a blue border and the Ongoing Call icon turns blue in the Status bar. Tap Bluetooth to toggle in-call audio to and from the Bluetooth accessory. |
| Mute | You can unmute the microphone by tapping Mute again. |
| Speaker | You can turn the speakerphone off by tapping the Speaker again. The speaker is turned off automatically when your current call ends. |
| Add call | Tap to dial another call if your network supports this service. The current call will be put on hold. |
| Dialpad | Tap to enter additional numbers during your call. |
|  Menu > Contacts | You can search for contacts during a call. |
|  Menu > Hold | You can place the current call on hold at any point during a conversation. When you put a call on hold, the Status bar displays the  . Tap  Menu > Unhold to resume the call. |
|  Menu > Noise suppression | Noise suppression helps to eliminate noise during a call. Tap  Menu > Noise suppression off to turn off Noise suppression . |





NOTE To avoid damaging your hearing, do not hold the phone up to your ear when the speakerphone is on.

Managing Multiple Calls

Your Sharp FX PLUS supports conference or multi-party calling. You can switch back and forth between 2 or more active calls, or join multiple calls together.

Switching between calls

If you have an active call and a call on hold, you may switch between the two calls.



1. From the Home screen, tap  **Phone**.
2. Dial the number to the first participant and tap .
3. During the call, tap **Add call**.
4. Dial the number to the second participant and tap .
5. When the second participant has answered and the previous call is on hold, tap  **Menu** > **Swap calls**.
 - The current call is placed on hold and the previous call is reactivated. The currently active call appears in the foreground of the call screen.



| | |
|---|--|
| 1 | Tap to merge the calls into a conference call. |
| 2 | The call on hold. |

Conference call

Starting a conference call

1. From the Home screen, tap  **Phone**.
2. Dial the number to the first participant and tap .
3. During the call, tap **Add call**.
4. Dial the number to the second participant and tap .
5. When the second participant has answered, tap **Merge calls**.

Having a private conversation with a participant

1. During the conference call, tap **Manage** > tap  at the right of desired participant.
2. To return to the conference call, tap **Merge calls**.

Releasing a participant

1. During the conference call, tap **Manage**.
2. Tap  at the left of desired participant. Or, tap  at the right of desired participant > Tap .





Ending the entire conference call

1. During the conference call, tap .

Using Call Log

The phone stores the numbers of all incoming and outgoing calls in the Call log. The Call log displays the details of the call including time, date, and duration.

Opening the Call log



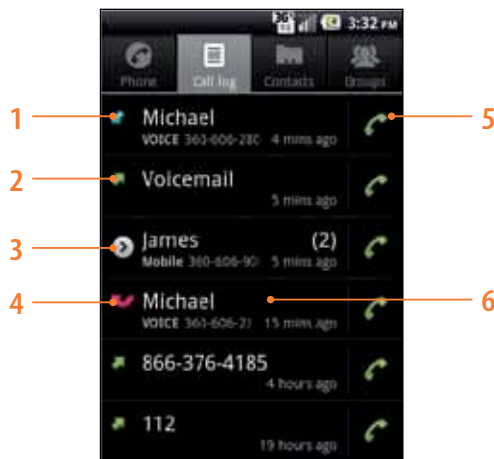

1. From the Home screen, tap  **Phone** >  **Call log**. Or tap  **Apps** >  **Contacts** >  **Call log**.
- Calls are listed with the most recent at the top. Calls of the same phone number are grouped together. Scroll to view earlier entries in the log.

NOTE You can tap and hold the desired number in the call log list to select options such as **Call**, **View contact**, **Edit number before call**, **Send text message**, **Add to contacts**, **Remove from call log**.





| | |
|---|---|
| 1 | Incoming call. |
| 2 | Outgoing call. |
| 3 | Tap to open a group of calls to the same phone number. |
| 4 | Missed call. |
| 5 | Tap to dial this contact. |
| 6 | Tap the number for more call details, or tap and hold the contact for more options. |

Calling a number from the Call log

1. From the Home screen, tap  **Phone** >  **Call log**.
 2. If you want to call a number directly, tap  at the right of the entry.
Or, select a contact > tap .
- If you want to edit a number before calling, tap and hold the desired entry, and then tap **Edit number before call**.

Adding a phone number from your Call log to your the Contacts lists

1. From the Home screen, tap  **Phone** >  **Call log**.
2. Tap and hold the desired entry > **Add to contacts**.
3. In the list of contacts that opens, tap **Create new contact** or add to an existing contact.
4. Tap **Done**.







Sending a text message from the Call log

1. From the Home screen, tap  **Phone** >  **Call log**.
2. Tap and hold the contact > **Send text message**.
3. Enter your message and tap **Send**.

Clearing the Call log

1. From the Home screen, tap  **Phone** >  **Call log**.
2. Press  **Menu** >  **Clear call log**.
 - To remove just one entry from the Call log, tap and hold the entry. In the pop up menu, tap **Remove from call log**.





Checking the Call duration

1. From the Home screen, tap  **Phone** >  **Call log**.
2. Press  **Menu** >  **Call duration**.
 - You can check **Last call**(duration of your last call), **Dialed calls**(total duration of all dialed calls), **Received calls**(total duration of all received calls) and **All calls**(total duration of both received and dialed calls).
 - To clear all of the counters to zero, Press  **Menu** >  **Reset**.



Listening to Your Voicemail

When you have a new voicemail message,  appears in the Status bar. If you have not set up your voicemail number, or if you need to change it, you will need to set it up using the Call settings menu.

Entering your voicemail number

1. From the Home screen, tap  **Apps** >  **Settings**. Or press  **Menu** >  **Settings**.
2. Tap  **Call settings** > **Voicemail settings** > **Voicemail number**.
3. Enter your voicemail number > **OK**.

Calling your voicemail from the Dialer



1. From the Home screen, tap  **Phone**.
2. Tap and hold **1** or tap .

Calling your voicemail from the Notification panel

1. Open the Notifications panel and tap **New voicemail**.

Dialing by Voice

You can use the Voice Search application to place a phone call by speaking the name of a contact or a phone number.

1. From the Home screen, tap  **Apps** >  **Voice Search**.
 - If you have a Bluetooth headset that supports “voice-recognition” or “voice-dialing,” you may be able to open Voice Search by pressing your headset’s main button and dial by voice using your headset. For details, see your headset manual.
2. The Voice Search opens, listens for your spoken instructions, and displays some hints for how to use it.
3. Say “Call” followed by the name of the contact to call.
 - Or, follow one of the suggestions for dialing a number or controlling your phone in other ways.

Contacts



About Contacts

Contacts give you quick and easy access to the people you want to reach. When you first turn on your phone and sign into your AT&T Address Book Account, any existing AT&T Address Book contacts are downloaded to your phone. Contacts from Google accounts are also downloaded and synced with the Contact list.

You can manage your communications with your contacts via phone, messaging, and email without the need to jump from one app to another. After you've linked to social network accounts like Facebook and Twitter, you'll see updates and events from these accounts all in one place.

Opening Your Contacts

Open Contacts to add, view, and communicate with your friends and acquaintances.

1. From the Home screen, tap  **Apps** >  **Contacts**.
 - All of your contacts are displayed alphabetically in a scrolling list.
 - You can use the tab on the right hand side of the screen, or flick your finger up or down to scroll quickly.

Getting Started





First use

AT&T Address Book

AT&T Address Book is an optional service to automatically sync your contacts are automatically synchronized between your phone and an online address book. You can easily restore your contact information if you ever upgrade, damage, or lose your phone.





Activating AT&T Address Book

The prompts will appear the first time you use your phone or open AT&T Address Book. You can also manually activate AT&T Address Book as follows:



1. From the Home screen, tap  **Apps** >  **Contacts**.
2. Press  **Menu** >  **AT&T Addr Book**.
 - If you are a new user, view the description of AT&T Address Book, tap **Start Sync**.
 - If you are an existing AT&T Address Book user, tap **Yes** to start sync.
 - If you have any contacts on your phone, you are able to delete the old contacts and start fresh, or keep the existing contacts and continue to sync.
 - If you have contacts on your SIM card, you will be prompted to copy them during the AT&T Address Book activation process. Tap **Yes** > select the contacts to import, and **copy**.
3. After syncing contacts, tap **OK**.

In just a few moments your AT&T Address Book will be ready for use.



Adding a new contact

1. From the Home screen, tap  **Apps** >  **Contacts**.
2. Press  **Menu** >  **New contact**.
3. If you have more than one account, select an account, then enter the information for the contact.
 - Tap  > Select **Take photo** or **Select photo from Gallery** to add a picture.
 - Enter your contact's information.
4. Tap **Done**.

Saving a phone number from the Dial Pad

1. From the Home screen, tap  **Phone**.
2. Enter the number > press  **Menu** >  **Add to contacts**.
3. Tap **Create new contact** or an Existing contact.
4. Enter the information for the contact > Tap **Done**.





Storing a contact using Call log

1. From the Home screen, tap  **Apps** >  **Contacts**.
2. Tap **Call log** > tap the number you want to save > **Add to contacts**.
3. Tap **Create new contact** or select an Existing contact.
4. If you have more than one account, tap the account where you want to save the contact > Enter the information for the contact > tap **Done**.





Importing/Exporting /Sharing contacts

Importing contacts from your microSD card

If you have contacts stored in vCard format on the microSD card, you can import them into Contacts on your phone.

1. From the Home screen, tap  **Apps** >  **Contacts**.
2. Press  **Menu** >  **Import/Export**.
3. Tap **Import from SD card**.
4. If you have more than one account on your phone, select the desired account.
5. Tap the option to **Import one vCard file**, **Import multiple vCard files** or **Import all vCard files** on the SD card. The contacts are imported.





Exporting contacts to your microSD card

1. From the Home screen, tap  **Apps** >  **Contacts**.
2. Press  **Menu** >  **Import/Export**.
3. Tap **Export to SD card**.
4. Tap **OK** to confirm.
 - This process creates a file containing all your contacts with a .vcf extension on your SD card.





Sharing visible contacts

1. From the Home screen, tap  **Apps** >  **Contacts**.
2. Press  **Menu** >  **Import/Export**.
3. Tap **Share visible contacts** > Select  **Bluetooth**,  **Gmail** or  **Messaging**.





Copying contacts to the SIM card

1. From the Home screen, tap  **Apps** >  **Contacts**.
2. Press  **Menu** >  **More**.
3. Tap **SIM management** > **Copy Contacts to SIM**.
4. Check the boxes for the desired contacts > **Copy**.



Copying contacts from the SIM card

1. From the Home screen, tap  **Apps** >  **Contacts**.
2. Press  **Menu** >  **More**.
3. Tap **SIM management** > **Copy Contacts from SIM**.
4. Check the boxes for the desired contacts > **Copy**.





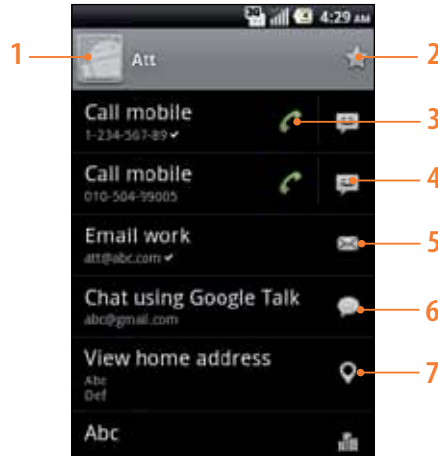

Deleting contacts from the SIM card

1. From the Home screen, tap  **Apps** >  **Contacts**.
2. Press  **Menu** >  **More**.
3. Tap **SIM management** > **Delete Contacts from SIM**.
4. Check the boxes for the desired contacts > **Delete**.





Viewing details about a contact

1. From the Home screen, tap  **Apps** >  **Contacts**.
2. Tap the contact whose details you want to view.
3. Tap the communication icon to start dialing, texting, or emailing the contact.







| | |
|---|---|
| 1  | Tap to open Quick Contact. |
| 2  | Add to favorites : Tap the star to add a contact to the favorites list, indicated by a gold star. To remove a contact from your favorites list, tap the gold star again. The star turns gray and the contact is removed from your favorites list. |
| 3  | Tap to call. |
| 4  | Tap to compose a text message. |
| 5  | Tap to send an email. |
| 6  | Tap to chat. |
| 7  | Tap to view the address on Maps or AT&T Navigator. |









Search for a contact

1. From the Home screen, tap  **Apps** >  **Contacts**.
2. Press  **Search** or press  **Menu** >  **Search**.
3. Start entering the contact's name.
As you type, contacts with matching names appear below the search box.
4. Tap the matching contact in the list to open.

YP search



1. From the Home screen, tap  **Apps** >  **Contacts**.
2. Press  **Menu** >  **YP search**.
3. Enter a search term and tap  or scroll through the list to select a search category.

Adding ICE (In Case of Emergency) contacts

1. From the Home screen, tap  **Apps** >  **Contacts**.
2. Tap  **Groups** > **ICE**.
3. Press  **Menu** >  **New contact** or  **Select contacts**.
 -  **New contact** : Enter a new contact for the ICE menu.
 -  **Select contacts** : Select ICE contacts from your contact list.
4. Tap **Done**.
 - On the ICE screen, you will see any added contacts.

Editing/ Deleting Contacts



Editing contact details

1. From the Home screen, tap  **Apps** >  **Contacts**.
2. Tap and hold the contact you want to edit > Tap **Edit contact**.
3. Edit the contact information.
4. Tap **Done**.

Setting a contact's default phone number/email



Setting a contact's default phone number

The default phone number is used when you initiate a call or text message by tapping and holding a contact.





1. From the Home screen, tap  **Apps** >  **Contacts**.
2. Find the desired contact > Tap and hold the phone number to designate it as the default phone number.
3. Tap **Make default number**.
 - The default phone number is indicated with a checkmark.

Setting a contact's default email



The default email is used when you send an email from the list by tapping and holding a contact.

1. From the Home screen, tap  **Apps** >  **Contacts**.
2. Find the desired contact > Tap and hold the email address to designate it as the default email address.
3. Tap **Make default email**.
 - The default email is indicated with a checkmark.







Setting a ringtone for a contact

1. From the Home screen, tap  **Apps** >  **Contacts**.
2. Tap the desired contact.
3. Press  **Menu** >  **Options** > **Ringtone**.
 - Tap a ringtone from the list to play when the contact calls. A sample of the ringtone is played.
4. Tap **OK**.

Adding a contact to your favorites

1. From the Home screen, tap  **Apps** >  **Contacts**.
2. Tap and hold the desired contact > **Add to favorites**.
 - To remove a contact from your favorites list, tap and hold the contact > **Remove from favorites**.





Joining contacts

1. From the Home screen, tap  **Apps** >  **Contacts**.
2. Tap the contact you want to save. The others will merge into this file. This is the contact you will see in contacts after joining.
3. Press  **Menu** >  **Edit contact** > press  **Menu** >  **Join**.
4. Tap the contact you want to join with the first contact. The information from the second contact is added to the first contact, and the second contact is hidden.

Separating contacts



1. From the Home screen, tap  **Apps** >  **Contacts**.
2. Tap the contact you want to separate.
3. Press  **Menu** >  **Edit contact** > press  **Menu** >  **More** >  **Separate** > **OK**.
4. The contact information is split into separate contacts.

Deleting a contact



1. From the Home screen, tap  **Apps** >  **Contacts**.
2. Tap and hold contact you want to delete > **Delete contact**.
Or tap the contact you want to delete > press  **Menu** >  **Delete contact**.
3. Tap **OK**.

Communicating





Sending text message

1. From the Home screen, tap  **Apps** >  **Contacts**.
2. Tap and hold the contact you want to send > **Text contact**.
 - The Primary Phone Number is used, or you are prompted to choose a phone number.



Making calls

1. From the Home screen, tap  **Apps** >  **Contacts**.
2. Tap and hold the contact to call > **Call contact**.
 - The Primary Phone Number is used, or you are prompted to choose a phone number.

Map of contacts

1. From the Home screen, tap  **Apps** >  **Contacts**.
2. Tap the desired contact > Tap the place icon  of the address.
3. Select  **AT&T Navigator** or  **Maps**. The mapping application will open.





Connecting by using Quick Contact

1. From the Home screen, tap  **Apps** >  **Contacts**.
2. Tap the icon or photo next to your desired contact > Tap the desired communication method.
 - Only the Icons relevant to your contact's data are displayed.
 - If there are too many icons to fit on the screen, drag to the left or right to select an icon.







Account Setting





Working with Google and AT&T Address Book accounts

1. From the Home screen, tap  **Apps** >  **Contacts**.
2. Press  **Menu** >  **More** > **Accounts**.
 - After registering your Google account, your online Google contacts are synchronized to your phone. Changes made online or on the phone are automatically synchronized and updated in both locations. This address book will be used throughout the user interface.
The AT&T Address Book behaves the same way. AT&T contacts are downloaded to the phone and synced.
 - If you register two or more accounts, you can merge address books from the multiple accounts into one address book.

Contact List Display Options

1. From the Home screen, tap  **Apps** >  **Contacts**.
2. Press  **Menu** >  **More** > **Display options**.
 - Only contacts with phones: Only contacts with phone numbers are shown in the contacts list.
 - Sort list by: Select **First name** or **Last name**.
 - View contact names as: Select **First name first** or **Last name first**.
 - Choose contacts to display: Touch an account to open its list of groups. Check or uncheck the groups you want to display in the contact list.
3. Tap **Done**.



Changing sync settings of AT&T Address Book

1. From the Home screen, tap  **Apps** >  **Contacts**.
2. Press  **Menu** >  **AT&T Addr Book**.
3. Select **Auto Sync**, **Sync Now**, **Sync Log** or **About**.
 - Auto Sync: Mark the checkbox for automatic sync.
 - Sync Now: Synchronize the phone with AT&T Address Book.
 - Sync Log: View the records of sync.
 - About: Check the version and introduction of AT&T Address Book.

Groups

Assign contacts to groups to easily send a message or email to a whole group. You can also sync groups on your phone with your Google groups, which are accessible via the web browser of your computer.





Viewing contact groups

1. From the Home screen, tap  **Apps** >  **Contacts**.
2. Tap  **Groups** > Tap the group you want to view.
 - 'Favorites' is always shown at the top of groups list.



Predefined groups

| | |
|-----------------|---|
| Favorites | Favorite contacts designated with a star |
| Yellow Pages | Saved Yellow Pages contacts, tap and hold the Yellow Pages to launch 'Local Search' |
| ICE | Emergency contacts |
| Account Service | AT&T account services contacts |
| Business | Business contacts group |
| Personal | Personal contacts group |





Creating a new group

1. From the Home screen, tap  **Apps** >  **Contacts**.
2. Press  **Menu** >  **More** > **New group**.
3. Select the account you want.
4. Enter a name for the group > Tap **Done**.
5. Select the contacts you want to add to the group > Tap **Done**.

Adding a contact to an existing group







1. From the Home screen, tap  **Apps** >  **Contacts**.
2. Tap and hold a contact you want to edit > **Groups**.
3. Tap **Add/Remove group**.
 - Select or deselect groups using the checkboxes.
 - Select **New group** to add a new group.
4. Tap **Done**.

Adding contacts to the group on the group list





1. From the Home screen, tap  **Apps** >  **Contacts**.
2. Tap  **Groups** > Tap the group you want to select.
3. Press  **Menu** >  **Select contacts**.
 - Add or remove group contacts by checking or un-checking the boxes.
4. Tap **Done**.

Sending a group message





NOTE Group messages are billed according to the number of messages sent to each individual group member. Meaning a single message sent to a group of 5 people will be billed as 5 messages.

1. From the Home screen, tap  **Apps** >  **Contacts**.
2. Tap  **Groups**.
3. Tap the desired group > Press  **Menu** >  **Send message**.
Or, tap and hold the group you want > **Send message**.
4. Select **Message** or **Email**.
5. Select recipients.
 - The list is shown with all contacts unselected by default. Select members to whom you want to send a message.
 - The top checkbox is used for selecting or deselecting all group members at once.
 - If more than 10 recipients are selected, the outgoing messages will be batched in groups of 10.
6. Press  **Menu** > Tap  **Create message**. Compose the message and tap **Send**.

Renaming a group

1. From the Home screen, tap  **Apps** >  **Contacts**.
2. Tap  **Groups**.
3. Tap the group you want to rename > Press  **Menu** >  **Rename group**.
Or tap and hold the group you want to rename > **Rename group**.
4. Enter a name for the group > Tap **Done**.
 - The renamed group list is shown as part of the group list.

Deleting a group

1. From the Home screen, tap  **Apps** >  **Contacts**.
2. Tap  **Groups**.
3. Tap the group you want to delete > Press  **Menu** >  **Delete group** > **OK**.
Or tap and hold the group you want to delete > **Delete group** > **OK**.
 - Deleting a group does not delete the contacts contained within the group.

NOTE You can only delete groups you have created.

Messaging

About Messaging

Use Messaging to send text messages (SMS) and multimedia messages (MMS) to other mobile phones.

1. From the Home screen, tap  **Messaging**. Or tap  **Apps** >  **Messaging**.

On the Messaging screen, your sent and received messages are neatly grouped into conversations, by contact names or phone number. You can:





- Scroll up or down the list of conversations by flicking your finger on the screen.
- Tap a contact name or number to view the conversation history.
- Tap and hold the photo or  to open additional menu options.





You can also view your messages on the Home screen with the Messages widget.

Sending Messages

Sending a Text Message

NOTE Depending on your billing plan, if you exceed the single text message character limit, you will be billed for multiple messages.

1. From the Home screen, tap  **Messaging**.
2. Tap **New message**. Or press  **Menu** >  **Compose**.
3. Enter the phone number in the **To** field. Fill in one or more recipients. You can:
 - Enter the first few letters of a contact name or phone number. Matching contacts are displayed. Continue typing or tap a name or phone number from the search results.
 - Tap  > select message recipients from your contact list > **Add**.
4. Tap **Type to compose** > Enter your message.
 - Press  **Menu** to see more options.

| | |
|--|--|
|  Add Cc/Bcc | Add additional recipients using Cc/Bcc. |
|  Attach | Attach Media Files, vCard, vCalendar or a Slideshow with-in the message. |
|  Insert smiley | Insert a smiley in the message. |
|  Discard | Delete the message in progress. |
|  All threads | Go back to text messaging inbox. |

5. Tap **Send**.





- Press  **Back** to save the message as a draft.









NOTE Your text message automatically becomes a multimedia message on below condition:

- Compose a message over 6 segments (918 characters)
- Send to an email address over 6 segments (918 characters)
- Add cc or bcc
- Attach an item

Sending a multimedia message (MMS)

To compose a multimedia message, start by creating a new text message. Then simply add an attachment.

1. From the Home screen, tap  **Messaging**.
2. Tap **New message**. Or press  **Menu** >  **Compose**.
3. Enter the phone number in the **To** field. Or select recipients from the contact list.
4. Tap **Type to compose** > Enter your message.
5. Press  **Menu** >  **Attach** > Choose the type of attachment.

| | |
|---|--|
|  Pictures | Select a photo. |
|  Capture picture | Capture a new photo. |
|  Videos | Select a video. |
|  Capture video | Record a new video. |
|  Audio | Select an audio file. |
|  Record audio | Record a new audio file. |
|  vCard | Select a contact card. |
|  vCalendar | Select a calendar event. |
|  Slideshow | Create a slideshow from up to 10 of your photos. |

6. From the message body, tap:
 - **View**: To view the attached item.
 - **Edit**: To edit an attached Slideshow file.
 - **Replace**: To change attached files.
 - **Remove**: To remove attached files.
7. Tap **Send MMS**.
 - Press  **Back** to save it as a draft.

Resuming a draft message

1. From the Home screen, tap  **Messaging**.
2. Tap the message indicated by **"Draft"** to resume editing.
3. When you finish editing, tap **Send**.

Reading Messages





1. From the Home screen, tap  **Messaging**.
2. Tap a message thread.
3. Tap and hold an individual message to see more options.

| | |
|----------------------|--|
| Lock/Unlock message | To lock/unlock a message. |
| Call *** | To call the message sender. (Only on incoming messages) |
| Send message to *** | To reply back to the sender. (Only on incoming messages) |
| Add *** to contacts | To save the phone number or email address to Contacts. (Only on incoming messages) |
| Forward | To forward a message. Enter a recipient, edit the content of the message as needed > Tap Send . |
| Copy message text | To copy text from a message. |
| View message details | To view details about a message. |
| Delete message | To delete a message. |

Deleting a message thread

1. From the Home screen, tap  **Messaging**.
2. Tap and hold the message thread > **Delete thread**.
 - If you want delete all message threads, press  **Menu** >  **Delete threads**.
3. Tap **Delete**.



Searching messages

1. From the Home screen, tap  **Messaging**.
2. Press  **Menu** >  **Search** or press  **Search**.
3. Enter the search term > Tap .

Replying to a message

1. From the Home screen, tap  **Messaging**.
2. Tap the received message > Tap **Type to compose** > Enter your message.
3. Tap **Send**.

Changing Messaging Settings

1. From the Home screen, tap  **Messaging**.
2. Press  **Menu** >  **Settings**.

Storage settings

| | |
|--------------------------|---|
| Delete old messages | Check to delete older messages in a thread when messaging memory or thread limits are reached. Uncheck to keep all messages. You may need to manually delete messages if the messaging memory limit is reached. |
| Text message limit | Tap to set the number of messages to save per message thread. When the limit is reached, older messages are deleted if 'Delete old messages' is checked. |
| Multimedia message limit | Tap to set the number of messages to save per message thread. When the limit is reached, older messages are deleted if 'Delete old messages' is checked. |

Text message (SMS) settings

| | |
|--------------------------|---|
| Manage SIM card messages | Tap to open a window where you can read and delete text messages stored on your SIM card. (Note: you will only have SIM messages if you sent text messages while using your SIM card in another phone.) |
|--------------------------|---|

Multimedia message (MMS) settings

| | |
|---------------|---|
| Auto-retrieve | Uncheck to download only the heading of multimedia messages. You will need to tap the MMS message heading and manually download each MMS message. You may want to use this feature when roaming or when connected to a slow data network. |
| Creation mode | Tap to set MMS creation mode for compose message. You can select Restricted or Free. |

Notification settings













| | |
|-----------------|--|
| Notifications | Check to be notified whenever you receive a new message. |
| Select ringtone | Select or de-select a ringtone to sound when you receive new message notifications. |
| Vibrate | Set the phone to vibrate every time you receive a new message notification, only in Silent mode, or never. |
| Turn on LCD | Select to turn on the display backlight for 3 seconds after a new notification. |

Google







Gmail

Opening your Inbox and Reading your Gmail



The inbox is your default Gmail view. All your received emails are delivered to your inbox.

1. From the Home screen, tap  **Apps** >  **Gmail**.
2. Tap the email you want to read.
 - Tap  to star the email.
 - If the sender is a friend in Google Talk, you can see your friend's online status.
 - Tap **Archive** to archive the message.
 - Tap **Delete** to delete the message from your inbox.
 - Tap  or  to see the previous or next message in the list.
 - Press  **Menu** to see more options ( **Change labels**,  **Mark read/Mark unread**,  **Go to inbox**,  **Mute**,  **Add star/Remove star**,  **More** (**Report spam**, **Settings**, **Help**, **Select text**)).

Replying to or forwarding an email message









1. From the Home screen, tap  **Apps** >  **Gmail**.
2. When reading a message,
 - To reply to the sender, tap .
 - To reply to all message recipients, tap  > .
 - To forward the message, tap  > .

Sending a new email

1. From the Home screen, tap  **Apps** >  **Gmail**.
2. From any message list, press  **Menu** >  **Compose**.
3. Enter a name or address in the **To** field. To send the email to several recipients, separate each email address with a comma.
4. Enter a subject in the **Subject** field.
5. Type the message text in the **Compose Mail** field.
 - To attach an image file, press  **Menu** >  **Attach** > Select the picture you want to attach.
6. Tap  or press  **Menu** >  **Send**.
 - To save the message as a draft, Tap  or press  **Menu** >  **Save draft**.

Working with Multiple Email Messages





You can archive, delete or label groups of email messages at the same time.

1. From the Home screen, tap  **Apps** >  **Gmail**.
2. From any message list,  check the box next to the email messages you want to work with.
 - Tap **Archive** to move messages out of your inbox without deleting. Archived emails are assigned the All Mail label.
 - Tap **Delete** to delete selected messages.
 - Tap **Labels** > Select the labels that you want to assign > Tap **OK**.
 - Or press  **Menu** > To  **Add star/Remove star**,  **Mark read/Mark unread**,  **Report spam**,  **Mute**,  **Deselect all**.

Switching between Google accounts

If you have set up two or more Google Accounts on your phone, you can switch between them in Gmail.

Gmail displays only one Google Account at a time. The current account is shown at the top right of any message list.

1. From the Home screen, tap  **Apps** >  **Gmail**.
2. From any message list, press  **Menu** >  **Accounts**.
3. Tap the account that you want to view. You can also tap the account name at the top of the screen to see a list of your accounts.

Searching for email messages

All fields of your email messages are searchable.

Search will include all your Gmail Messages, not just those that synchronized to your phone.

1. From the Home screen, tap  **Apps** >  **Gmail**.
2. From any message list, press  **Menu** >  **Search** or press **Search** .
3. Enter a search term.
 - Tap .
 - Your previous searches are shown below the search box.

Labeling email messages

You can organize your emails by label. Gmail has preset labels. Or you can create your own labels in Gmail when viewed on a computer. (Note: Custom label colors created on the web are not supported on your phone).

Labeling an email





1. From the Home screen, tap  **Apps** >  **Gmail**.
2. When reading a message, press  **Menu** >  **Change labels**.
3. Select a label > Tap **OK**.

Viewing emails by label

1. From any message list, press  **Menu** >  **Go to labels**.
2. Tap a label to view matching email messages.

Starring/un-starring an email message

You can star an important email to make it easy to find again. Starred emails are assigned the Starred labels.

1. From the Home screen, tap  **Apps** >  **Gmail**.
2. From any message list,
 - Tap  to star a message.
 - Tap  to un-star a message.

Gmail settings

Settings are unique to each Gmail account. Changes will only affect the active account.

1. From the Home screen, tap  **Apps** >  **Gmail**.
2. From any message list, press  **Menu** >  **More** > **Settings**.



| | | |
|-----------------------|----------------------|---|
| General settings | Priority inbox | Display only items marked as important in your default Inbox. To view and use this feature, it must first be enabled through web based Gmail. |
| | Signature | Enter a signature to append to every outgoing message. |
| | Confirm actions | Configure send, delete, or archive actions to require a manual confirmation. |
| | Reply all | Replace the Reply button with the Reply all button. |
| | Auto-advance | Select what is displayed after you delete or archive an email. |
| | Message text size | Select the text size used when reading messages on the phone. |
| | Batch operations | Add or remove the message check box in list view. Without the check box, you cannot group messages for deletion, emailing, etc. |
| | Clear search history | Delete all previous search terms used when searching your Gmail messages. |
| | Labels | Select messaging labels and timeframes to sync to the phone. |
| Notification settings | Email notifications | Show a status bar notification icon when you receive a new email. |
| | Select ringtone | Select a ringtone to sound when you receive a new email. |
| | Vibrate | Configure the phone to vibrate when new email arrives. |
| | Notify once | Notify once for new email, not for every new message. |

Google Talk

Use Google Talk to send instant messages to other Google Talk users anywhere they are logged in.

Signing in or out of Talk

Opening Talk and Signing in

1. From the Home screen, tap  **Apps** >  **Talk**.

When you first open Talk, your Friends list is displayed.



NOTE: When you first turn on your phone and sign in to your Google Account, you are automatically signed in to Google Talk. You will remain signed in, even while you're using other applications, until you deliberately sign out.

Talk syncs data only from the first Google Account you added to your phone.

Signing out of Talk

1. From the Talk friends list, press  **Menu** >  **Sign out**.





Updating Your Online Status, Profile Picture, and Status Message

1. From the Home screen, tap  **Apps** >  **Talk**.
2. Tap your name at the top of the Talk friends list.
 - Tap your picture > **Remove** to delete the image or **Change** to select another picture from your SD card.
 - Tap the online status bar > select your online status: Available, Busy, or Invisible.
 - Enter a new status message.
3. Tap **Done**.

Your picture, online status, and message will be updated anywhere your TALK status is displayed.

Adding and managing Friends list

Online Status Indicators





| | | | |
|---|-----------|---|---------|
|  | Available |  | Busy |
|  | Away |  | Offline |

Monitoring online status

The Talk friends list is sorted by online status: active chats, online, away, busy, and offline. Within each status group, friends are listed alphabetically.

Icons in Talk, Gmail, Maps, and other applications indicate Talk status.

Adding a friend to your Friends list



1. From the Home screen, tap  **Apps** >  **Talk**.
2. Press  **Menu** >  **Add friend**.
3. Enter a Google Talk ID or a Gmail address > **Send invitation**.

When your friend accepts the invitation, the friend is added to your Talk contacts list.







To view a list of pending invitations to friends, press  **Menu** >  **More** > **Invites**.

Accepting chat invitations



When you are added to a friend's Talk contact list, you will receive a notification and an invitation appears in your Friends list.

1. From the Home screen, tap  **Apps** >  **Talk**.
2. From the Talk Friends list, tap **Chat invitation**.
 - Tap **Accept** to accept the invitation. The friend is added to your Friend list.
 - Tap **Cancel** if you don't want to chat or share your Talk status with the sender.
 - Tap **Block** to block and add the sender to your blocked users list.

Viewing all friends or most popular friends

1. From the Home screen, tap  **Apps** >  **Talk**.
 - Press  **Menu** >  **All friends** to view all your friends.
 - When viewing All friends, press  **Menu** >  **Most popular** to view only friends that you often chat with.



Managing a friend

1. From the Home screen, tap  **Apps** >  **Talk**.
2. Tap and hold a friend's name to see more options (**Start chat/Go to chat/End chat, Friend info, Block friend, Remove friend, View contact, Always show friend/Auto show friend, Hide friend**).

NOTE Block friend: This option will block a user from sending you messages and add the user to your blocked friends list.
Always show friend: This setting will add the friend to your Most popular list. To remove a friend from the Most popular list, tap and hold the friend's name then tap > **Auto show friend**

Chatting with friends

Chatting with a friend



1. From the Home screen, tap  **Apps** >  **Talk**.
2. Tap an online friend.
3. Enter your message in the text box > **Send**.

Accepting an invitation to chat

When a friend sends you a Talk message, you receive a notification. There are 2 ways to respond:

- On your friends list, tap the friend who sent you the chat invitation or
- Open the notifications panel and tap the chat notification.



Adding another friend to your chat

1. When you're chatting with a friend, press  **Menu** >  **Add to chat**.
2. Tap a friend to invite.

This will start a new group chat for all parties. Only those who accept the new chat invitation will be joined to the group chat.

Switching between active chats





You can switch between multiple active chats.

1. When you're chatting with a friend,
 - Press  **Menu** >  **Switch chats** > tap the desired active chat.
 - Or swipe left or right across the screen to switch between chats.

Ending your current chat

1. From the Home screen, tap  **Apps** >  **Talk**.
2. From any chat window, press  **Menu** >  **End chat**.



Talk settings

1. From the Home screen, tap  **Apps** >  **Talk**.
2. Press  **Menu** >  **Settings**.

| | | |
|-----------------------|-----------------------|---|
| General settings | Automatically sign in | Automatically sign in to Talk when you turn your phone on. |
| | Mobile indicator | When selected, your status will indicate you are using Talk on your mobile phone. |
| | Automatic away-status | Set your status to away when your phone's display is off. |
| | Clear search history | Clear previous Talk chat searches from showing up in the Search box. |
| Notification settings | IM notifications | Show a notification icon on the status bar when you have new message. |
| | Select ringtone | Select the Talk Notification ringtone. |
| | Vibrate | Vibrate the phone when a new Talk message arrives. |
| About | Terms & privacy | Read detailed Google Talk legal Terms and privacy statements. |



Maps

Use Maps to find your current location and get directions. You can search for addresses, landmarks and businesses directly on a street map or satellite image.

NOTE You need an active mobile data or Wi-Fi connection to use Maps.
To see your location and get directions, you must turn on location services. From the Home screen, tap  **Apps** >  **Settings** >  **Location & security**. Select one or both from **Use wireless networks** or **Use GPS satellites**.
Maps may not be available for all locations.

Opening and viewing Maps

Viewing your location





1. From the Home screen, tap  **Apps** >  **Maps**.
2. While viewing a map, tap .

 shows your location on the map and points north for your reference.







Using Maps

1. From the Home screen, tap  **Apps** >  **Maps**.
2. While viewing a map, swipe to any direction on the screen.

Zooming in and out of a map



1. From the Home screen, tap  **Apps** >  **Maps**.
2. To Zoom In/Out of a map,
 - Tap  or double-tap on the map to zoom in.
 - Tap  to zoom out.

Viewing a map in Compass mode

1. From the Home screen, tap  **Apps** >  **Maps**.
2. To view a map in compass mode, tap 
 - The  icon will turn into  icon.
3. Tap 
 - The map will orient itself in the direction you're facing and shift from an overhead view to a more angled view.
 - To exit Compass mode, tap .



Viewing location details

Viewing information for a location

1. From the Home screen, tap  **Apps** >  **Maps**.
2. While viewing a map, tap and hold a location, starred place, or a search result on the map.
 - A balloon opens over the location, with summary information.
3. Tap the balloon to see the address or more information.



Starring or un-starring a location

Add a Star to bookmark and easily return to a map location.

1. While viewing detail information for a location,
 - Tap  to star the location.
 - Tap  to un-star the location.





Viewing starred places

Once you star a place, you can easily find it again on the phone or the web.

1. From the Home screen, tap  **Apps** >  **Maps**.
Starred places will be visible on the map in default settings.
2. Or from any map, press  **Menu** >  **Starred Places**.
3. Tap a star to see more information.





Viewing a location in Street view

Street view mode provides a street-level view of the location. Street view may not be available for all areas.

1. From the Home screen, tap  **Apps** >  **Maps**.
2. While viewing detailed information for a location, tap .
 - To view surrounding areas, swipe the screen in any direction.
 - To zoom in or out, tap  or .



Searching for a location

You can search Google Maps for specific locations, company names, or business types.

1. From the Home screen, tap  **Apps** >  **Maps**.
2. Tap the Search Maps field at the top of the screen.
3. Enter the search criteria. As you type suggested matches from your contacts, the web, and previously searched items are displayed.
 - Tap  to search or
 - Tap a suggested search term.
4. The search results are displayed as  markers with letter labels on the map.
 - Tap markers and titles to view more information.
 - Tap  to show the search results as a list > Tap each item to see more information.











Viewing map layers

Initially, Google Maps opens with a street map. You can view additional map layers, such as satellite images and traffic information. You can also view custom Web created Google Maps.

1. From the Home screen, tap  **Apps** >  **Maps**.
2. Tap . A dialog opens with a list of layers.
3. Turn layers on or off by tapping the layer name. A check mark indicates the layer is selected.
 - Tap **More Layers** to access **My Maps**, **Bicycling**, **Wikipedia**, **Transit Lines** or **Favorite Places**.
 - Tap **Clear Map** to deselect all layers.

Layers may change the map entirely or overlay additional information. Tap icons or interactive items to explore different layer types.

Getting directions





1. From the Home screen, tap  **Apps** >  **Maps**.
2. Press  **Menu** >  **Directions**.
3. Use your current location as the starting point, or enter a location in the Start point field.
Or tap  to select an address from your contacts, a point that you tap on a map, or a starred place.
4. Enter your destination in the End point field. Or tap  to select an address from your contacts or a point that you tap on the map.
5. Tap  or  or  or  to select your transportation method > Tap **Go**.

Places

Use Google Places to explore your current location.

NOTE You need an active mobile data or Wi-Fi connection to use Places. To see your location and get directions, you must turn on location services. From the Home screen, tap  **Apps** >  **Settings** >  **Location & security**. Select one or both from **Use wireless networks** or **Use GPS satellites**. Maps may not be available for all locations.

Searching

1. From the Home screen, tap  **Apps** >  **Places** or, while viewing a map, tap .
2. From the Places categories,
 - Tap the Find places field on top of the screen > Enter the place you want to search > Tap . To narrow your results, select a category before searching.
3. The search results display in a list, with their approximate distance and direction.
 - Tap  to see your results on a map.
 - Tap a place to view more information.

Navigation

Navigation is an internet-connected GPS navigation system with voice guidance.









Navigation provides both spoken and on-screen turn-by-turn driving directions.

NOTE You need an active mobile data or Wi-Fi connection to use Navigation. To see your location and get directions, you must turn on location services. From the Home screen, tap  **Apps** >  **Settings** >  **Location & security**. Select one or both from **Use wireless networks** or **Use GPS satellites**. Maps may not be available for all locations.

Opening & Using Navigation

There are many ways to view the map and travel progress while in Navigation mode. See the Changing Views section below for more information.

Navigating with Turn by Turn Directions

1. From the Home screen, tap  **Apps** >  **Navigation** or tap  when viewing driving directions in Google Maps.
2. Customize your navigation settings for highways or tolls by tapping  .
 - Tap  **Map** to begin tracking your journey, even if you haven't chosen a destination.
3. From the list of destination options,
 - Tap  **Speak Destination** to search the destination with voice.
 - Tap  **Type Destination** to enter the destination.
 - Tap  **Contacts** to use a contact's address information.
 - Tap  **Starred Places** to select the destination from starred places.
 - Tap a recent destination to select the previous destination.



A map opens with your route drawn in blue. Specific instructions are listed at the top of the screen.

As you navigate your route, each direction is spoken in turn, and the next turn is displayed. Your current location is shown as a blue arrow on the map, which is updated as you navigate your route.

Google Navigation downloads and temporarily stores a copy of the directions and other information about your route on the phone, so if you lose your connection to a data network, you can still navigate to your destination.

You can control the volume of the spoken instructions with  **Volume up** /  **Volume down**. To turn off the spoken directions, press  **Menu** >  **Mute**.

Previewing your route

1. From an active navigation, tap the directional instruction banner at the top of the screen.
2. Tap  or  to preview the next or previous segment of your route.



When you preview a route, tap  to switch to the street-level view of your route.

3. Tap  to return to your current location and next turn direction.

Changing views of your route

You can view your progress on your route as a map with different informational layers. Zoom in and out or drag to view adjacent areas. You can also view your progress in Satellite or Street View.

1. While viewing an active navigation,

- Press  **Menu** > **Layers** to switch to views traffic or a Satellite View, or to show the locations of parking, restaurants, and other landmarks along your route.
- Press  **Menu** > **Route Info** for a high-level summary of your route, with options to pick a new route, see traffic information, and more.
Tap  while on the Route Info screen to view each turn as a scrolling list of written directions.
- Drag the map to view adjacent areas, or tap the map to see controls for zooming in and out.

Finding an alternate route

If traffic is slow on your current route, or if you just want to try a different route, you can request an alternate route from the Google Maps Navigation service.

1. From an active navigation,

2. Press  **Menu** > **Route Info** > .

3. Select the alternate route you'd like to use to resume turn-by-turn guidance.

Exiting Navigation

You can exit Navigation mode when you reach your destination, or at any time by pressing Menu > **Exit Navigation**.

Latitude

Latitude allows you to share your location with friends and view their locations on a map.





Your location is not shared automatically. You must join Latitude, and then invite your friends to view your location or accept their invitations. Only friends that you have explicitly invited or accepted can see your location.

NOTE You need an active mobile data or Wi-Fi connection to use Latitude.

To see your location and get directions, you must turn on location services. From the Home screen, tap  **Apps** >  **Settings** >  **Location & security**. Select one or both from **Use wireless networks** or **Use GPS satellites**.

Maps may not be available for all locations.







Joining and opening Latitude

1. From the Home screen, tap  **Apps** >  **Latitude**.
2. Press  **Menu** >  **Join Latitude**. The first time you join Latitude, you're prompted to accept or reject the Google privacy policy.

Adding friends

Add friends to Latitude to share your location with them and request to see their location. Only friends you have explicitly invited or accepted can see your location within Latitude.



Inviting friends

1. From the Home screen, tap  **Apps** >  **Latitude**.
2. Tap  or press  **Menu** >  **Add friends**.
 - Tap **Select from Contacts** > Select contacts to invite > **Add friends** > When asked to confirm, **Yes**.
 - Or tap **Add via email address** > Enter one or more email addresses, separated by " , " > **Add friends** > When asked to confirm, **Yes**.
 - Or tap  to add a friend from suggested friends' list > **Yes**.

If your friends are current Latitude users, they will appear at the top of your Google Contacts lists with a Latitude icon. Current users will receive email request and a request within Latitude.

If your friends aren't using Latitude, they'll receive a location request email, but they must sign into Latitude with a supported Google account before they can accept your request. If you invite a friend who is not using a Google ID, you or your friends will need to re-send any location requests once they have signed into Latitude with a supported Google account.

Responding to an invitation

1. From the Home screen, tap  **Apps** >  **Latitude**.
2. Tap **New sharing request**.
 - Tap **Accept and share back** to share locations between you and your friend.
 - Tap **Accept, but hide my location** to see the friend's location, and hide your location.
 - Tap **Don't accept** to reject the request.
3. Tap **Done**.

Viewing friends' locations and managing friends





You can view your friends' locations on a map or in a list.

- When you open Latitude, you are shown list of your Latitude friends with location summaries.
- When you open Maps, your friends' locations are shown. Each friend is represented by a photo and arrow indicating their approximate location. If a friend has chosen to share only city-level location details the friend's photo is shown in the friend's city center location.

Viewing friends' profile

- While using Map mode, tap the friend's photo. Your friend's name appears in a balloon. Tap the balloon.
- From the Latitude friend's list, tap a friend.

Managing friends' communication and privacy options

1. From the Home screen, tap  **Apps** >  **Latitude**.
2. From a friend's profile,
 - Tap  to view the friend's location on the map.
 - Tap  to get directions to the friend's location.
 - Tap  to view the friend's location in street view.
 - Tap the friend's photo to open Quick contact where you can view contact details, send an email, and more.
 - Tap **Sharing options** to change sharing options for the friend.

| | |
|---------------------------------------|---|
| Share best available location | Share your precise location information. |
| Share only city level location | Share only your city location, not a street-level location. Your friend will see your picture in the middle of your current city. |
| Hide from this friend | Stop sharing your location with this friend. |

- Tap **Remove this friend** to remove the friend from your list and stop sharing locations.

Privacy settings

Only the last location sent to Latitude is stored by Google. If you turn off Latitude or are hiding, no location is stored. To change your privacy settings:

1. From the Home screen, tap  **Apps** >  **Latitude**.
2. Press  **Menu** >  **Settings**.

| | | |
|---------------------------|-----------------------------|--|
| Location reporting | Detect your location | Let Latitude detect and update your location as you move. The update frequency is determined by several factors, including your phone's battery level and how recently your location has been updated. |
| | Set your location | Choose from several methods and set your location manually. |
| | Do not detect your location | Hide your location from all your friends. |
| Location History settings | Enable location history | Store your past locations and visualize them on the Latitude website. |
| Account settings | Sign out of Latitude | Disable Latitude and stop sharing your location and status. You can always join Latitude again. |

Calendar

The Calendar application data on your phone syncs with the web-based Google Calendar service. It is also compatible with Microsoft Exchange ActiveSync Calendar.

Opening Calendar

1. From the Home screen, tap  **Apps** >  **Calendar**.



Events are color coded to enable you to distinguish between multiple calendars. The Calendar application indicates the current time with a red marker. Events times are shown using your local time zone, which is provided by your active mobile network. When traveling, you may want to set a home time zone in Calendar.

Creating an event



Events created on your phone will be synced to Google Calendar or Microsoft Exchange automatically.

1. From the Home screen, tap  **Apps** >  **Calendar**.

2. There are two ways to create an event:

- Press  **Menu** >  **More** > **New event**. Or press  **Menu** + **n** at the same time.
- In Day, Week, or Month view, tap and hold the screen at the date and/or time you want > **New event**.

3. Enter the name, time, location, description, and optional additional details for your event.

- If you have more than one calendar, choose the calendar to which to add the event.
- In the Guests field, enter email addresses of anyone you want to invite. Separate multiple addresses with commas (,). If your invitees use Google Calendar, they'll receive an invitation in Calendar and by email.
- If the event occurs on a regular basis, tap the Repetition box and choose the reoccurrence information.
- Tap  to add reminders. You can set multiple for an event.
- Press  **Menu** >  **Show extra options** to add additional details about the event.







4. Tap **Done**.

Viewing calendar and events

Changing calendar view

When you open Calendar, Month view is shown by default. You can also view the Calendar by Agenda, Day, or Week.





1. From the Home screen, tap  **Apps** >  **Calendar**.
2. Press  **Menu** > Choose the type of view that you want.

| | |
|--|---|
|  Day | Displays a chart of the events of one day, in a table of one-hour rows. A red line indicates the current time. All-day and multiday events are displayed at the top. Each event is displayed at the corresponding time. Swipe left or right to change dates, and swipe up or down to view earlier or later times. |
|  Week | Displays one week calendar. All-day and multiday events are displayed at the top. Swipe left or right to change weeks, and swipe up or down to view earlier or later times. |
|  Month | Displays a chart of the events of the month. Events are shown as blue bars on each calendar date. Swipe up or down to switch months. |
|  Agenda | A list of your events in chronological order. All-day and multiday events are listed at the start of each day. Days without events are not shown. Flick up or down to view earlier or later events. |
|  Today | Displays a chart of the events of today. |
|  More | You can select New event, Calendars or Settings. |

Viewing event details

- In Day, Week, or Agenda view, tap an event.
- In Month view, tap a day to switch to Day view > tap an event.

Editing or deleting an event

1. In event details view, press  **Menu** >  **Edit event** to edit the event.
2. Make your changes to the event > Tap **Done**.
 - To delete the event, press  **Menu** >  **Delete event** > Tap **OK**.



Synchronizing and displaying calendars

You can select which calendars to show or hide on your phone's Calendar, and which ones to synchronize.

1. From the Home screen, tap  **Apps** >  **Calendar**.
2. Press  **Menu** >  **More** > **Calendars**.





All the calendars you've added or subscribed to are displayed. (Calendars for accounts you've configured not to synchronize are not included in the list.)

3. Tap the icon next to a calendar to change storage and visibility settings.

| | |
|---|---|
|  | Calendar events stored on phone and visible in Calendar |
|  | Calendar events stored on phone but not visible in Calendar |
|  | Calendar events not synchronized to phone |

4. Tap **OK**.

Changing Calendar settings





1. From the Home screen, tap  **Apps** >  **Calendar**.
2. Press  **Menu** >  **More** > **Settings**. Or press  **Menu** + **p** at the same time.

| | | |
|-----------------------|----------------------------|---|
| Calendar view setting | Hide declined events | Check if you don't want to see events to which you've declined invitations. |
| Reminder settings | Set alerts & notifications | Configure event reminders. |
| | Select ringtone | Select which ringtone will sound when you receive an event reminder. |
| | Vibrate | Configure the phone to vibrate whenever you receive an event reminder. |
| | Default reminder time | Select the default reminder time used when creating new calendar events. |
| About | Build version | The version of Calendar in use. |





News & Weather

The News & Weather application offers updates on current events and local weather forecasts.

Viewing the weather information

1. From the Home screen, tap  **Apps** >  **News & Weather**.
2. Tap **Weather** at the top of the screen. Or flick left across the screen to switch to Weather view.
3. Tap the weather summary for a more detailed forecast.
 - Tap a time on the weather graph for a detailed, hour-by-hour forecast.
 - Tap the weather detail screen to return the weather summary.
 - Press  **Menu** >  **Refresh** to get the latest information.

Reading news articles

1. From the Home screen, tap  **Apps** >  **News & Weather**.
2. Tap a news category at the top of the screen. Or swipe left or right across the screen to switch news categories.
 - Press  **Menu** >  **Refresh** to get the latest information.
3. Tap a headline to view a detailed news article in your browser.

News & Weather settings

1. From the Home screen, tap  **Apps** >  **News & Weather**.
2. Press  **Menu** >  **Settings**.

| | | |
|---------------------|---|--|
| Weather settings | Use my location | Use the phone's location service to determine your location when displaying weather information. |
| | Set location | When Use my location is unchecked, tap to specify the location for weather information by entering a city or postal code. |
| | Use metric | Toggle metric/imperial units. |
| News settings | Select news topics | Select the categories of news to include in the scrolling list of News & Weather tabs. You can also tap Custom topic to enter specific topics. |
| | Prefetch articles | Download news articles so that they open more quickly and are available when you don't have a data connection. |
| | Prefetch images | Prefetch news images in addition to news text, when the headlines are downloaded. This setting is only available when Prefetch articles is checked. |
| | News terms of service | Details about the terms of service for Google News. |
| | Mobile privacy policy | Display the Google Mobile Privacy Policy. |
| Refresh settings | Auto-refresh | Update information automatically, at the frequency you set with Refresh interval. For automatic refresh to work, you must also have Background Data turned on in the Settings application. |
| | Refresh interval | Set how often to update the News & Weather automatically, if Auto-refresh is checked. |
| | Refresh status | Displays the date and time of the last refresh. |
| Application version | Displays the application version installed on your phone. | |

Market

Android Market provides direct access to applications and games to download and install on your phone.

To access Market, you must first sign into your Google account using a WiFi or data connection.

Paid apps are currently only available in certain countries.

When you open Android Market for the first time, you must read and accept the terms of service to continue.





Finding applications

Browsing applications

You can browse and sort applications by category.

1. From the Home screen, tap  **Apps** >  **Market**.
2. Tap **Apps** or **Games** at the top of the marketplace screen.
3. Scroll to view subcategories and tap one to explore.
4. Tap **Top paid**, **Top free**, or **Just in** to further sort the subcategory.

Searching for applications

1. From the Home screen, tap  **Apps** >  **Market**.
2. Tap  at the top right of the screen, or press  **Search**.
3. Enter the name or type of app you're looking for > Tap .



Viewing details about an application

1. While browsing the Market, or in a list of search results, tap an application to view more details.

Application details screens include a description, ratings, and specific information about the application. The Comments tab includes comments from people who have used the application. You can download and install an application from this screen.

Installing applications

Installing an application

1. From the Home screen, tap  **Apps** >  **Market**.
2. Find the application you want to purchase and view the application details. In application details view,
 - Press  **Menu** > **Security** to preview the functions and data accessed by the application when installed.
3. Tap **Free** to download and install the application.
For paid applications, the install button is labeled with the application's price. Tap the price to buy the application.

The subsequent screen notifies you whether the app will require access to your personal information or access to certain functions or settings of your phone.

4. Tap **OK** to begin downloading and installing the app. If you selected a paid app, you will be redirected to the Google Checkout screen to pay for the app before it's downloaded to your phone.

NOTE Be cautious when downloading apps that have access to phone functionality or a significant amount of personal data. You're responsible for the results of using downloaded apps on your phone.

Creating a Google Checkout account



You must have a Google Checkout account to purchase items from Android Market. You can set up a Checkout account with your first purchase from the Android Market.

- In a web browser, go to <http://checkout.google.com> to establish a Google Checkout account.
- From the phone, you will be prompted to enter your billing and credit card information when you buy your first application from the Google Market.

NOTE Once you've made a Market purchase, the phone remembers your password, so you don't need to enter it the next time. Be sure to secure your phone with a password to prevent unauthorized purchases.

Managing your downloads



Viewing downloaded applications

1. From the Home screen, tap  **Apps** >  **Market**.
2. Press  **Menu** > **My apps**.

In the list of the free and paid applications that opens, you can tap an application to rate it, uninstall it, request a refund, and more.

Uninstalling an application

You can uninstall applications from Market application. You can also uninstall downloaded applications from the Settings.

1. From the Home screen, tap  **Apps** >  **Market**.
2. Press  **Menu** > **My apps** > tap the application to uninstall.
3. Tap **Uninstall** > **OK**.
4. Tap the explanation that best matches why you're uninstalling > Tap **OK**.

The application is uninstalled. You can install the application again at any time. If you paid to buy the application, you will not be charged again.



Web

Email

The Email application is used to read and send email from services other than Gmail. The Email application includes a wizard enabling easy setup for several popular email service providers.





Email Account Setup

Initial Setup



1. From the Home screen, tap  **Email**. Or tap  **Apps** >  **Email**.
2. Enter the **Email address** and **Password** for your email account > **Next**.
3. If prompted, select **POP3**, **IMAP** or **Exchange**.
 - POP3, IMAP, and Exchange account settings are determined by your email account provider. For more details please visit your provider's support website.
 - If the account type you want to set up is not in the phone database, you'll be asked to enter more details.
4. Enter a name for this account and a name to include on outgoing messages > **Done**.

Adding an additional email account







You can add one or more email accounts to your phone.

1. From the Home screen, tap  **Email**.
2. Press  **Menu** >  **Accounts**.
3. Press  **Menu** >  **Add account**.
4. Repeat the steps to add an account as described in Initial Setup above.

Deleting an email account

1. From the Home screen, tap  **Email**.
2. Press  **Menu** >  **Accounts**.
3. Tap and hold the account > **Remove account**.

Refreshing an email account

1. From the Home screen, tap  **Email**.
2. Press  **Menu** >  **Refresh**.
 - If you have several email accounts, you can refresh them all at the same time.
From any message inbox, press  **Menu** >  **Accounts** >  **Combined Inbox** > **Refresh**.

Reading an email



You can read messages in your Combined Inbox or individual account folders.

1. From the Home screen, tap  **Email**.
 - Press  **Menu** to see more options.
2. Tap an email you want to read.
 - Press  **Menu** to see more options.

Replying to a message

1. While reading an email, select **Reply** or **Reply all**.
 - A Compose Message window opens with recipient addresses, and subject line pre-populated. A copy of the original message is quoted below the message body text box.
2. Compose your response and tap **send**.









Forwarding a message

1. While reading an email, Press  **Menu** >  **Forward**.
2. Address the email, enter a subject, and type your message in the appropriate text fields.
3. Tap **Send**.

Deleting a message



1. While reading an email, tap **Delete**.

Sending a new email

1. From the Home screen, tap  **Email**.
2. Press  **Menu** >  **Compose**.
3. Enter a name or email address in the **To** field. If you are sending the mail to several recipients, separate the email addresses with a comma “ , ”.
 - As you enter text, matching addresses are suggested from your Contacts list.
 - You can also tap  to open your contact list and select recipients from the entire list. Tap **Add** when finished.
 - Press  **Menu** >  **Add Cc/Bcc** to add additional recipient field types.
4. Enter a **Subject** and type your message.
 - To attach an image file, press  **Menu** >  **Add attachment** > Select the picture you want to attach.
NOTE The attachable file size is limited to 10 MB.
5. Tap **Send**.
 - To save an unsent email message on your phone, tap **Save as draft**.
 - To cancel an email message, tap **Discard**.





Starring/un-starring an Email

You can star an important message find it easily later. Once you star a message, a Starred folder is added to the Accounts screen.





1. From any email list or while reading a message,
 - Tap  to star the message.
 - Tap  to un-star.

Working with Email Messages





Viewing starred messages

1. From the Home screen, tap  **Email**.
2. Press  **Menu** >  **Accounts** >  **Starred**.



Resuming a draft email message

1. From the Home screen, tap  **Email**.
2. Press  **Menu** >  **Folders** or  **Accounts** >  **Drafts**.
3. Tap an email you want to resume > Finish editing the message.
4. Tap **Send**.

Viewing Individual Account Folders

1. From the Home screen, tap  **Email**.
2. Press  **Menu** >  **Accounts** > Select  to view individual account folders. Select any folder to open, view, or edit contents.

Email account settings

1. From the Home screen, tap  **Email**.
2. Press  **Menu** >  **Account settings**.



| | |
|-----------------------|---|
| Account name | The name of the account as it appears in the Accounts and Folders screens. |
| Your name | Your name shown in outgoing messages. |
| Signature | Enter a signature to append to messages sent from this account. |
| Email check frequency | Set how often the phone will for new email sent to this account. |
| Always Download Image | Check this option will always show embedded pictures in email. |
| Default account | Select this account as the 'default' account for outgoing messages. |
| Email notifications | Select to receive notifications when new messages are received in this account. |
| Select ringtone | Select a notification ringtone. |
| Vibrate | Select to configure vibration notifications when new emails arrive in this account. |
| Incoming settings | Configure Incoming server settings for this account. |
| Outgoing settings | Configure outgoing server settings for this account. |

3. Press  **Back** to save changes.



Browser

Search for information or browse web pages using the browser. To access the internet, you must have an active data or Wi-Fi connection.

Opening Browser

1. From the Home screen, tap  **Browser**. Or tap  **Apps** >  **Browser**.
 - When you open the Browser, the default homepage is displayed. If you have used the Browser recently, your most recently viewed web page is displayed.
 - The browser also opens when you select a web link in other applications like email or text messaging.

Accessing a webpage or searching the web



1. From the Home screen, tap  **Browser**.
2. Tap the URL field on top of the screen.
3. Enter the URL of a webpage or search term and tap .
 - As you type, suggestions of webpages and key words will appear on the screen. Tap a suggestion to go directly to that webpage or view search results.

Navigating on a webpage

Some websites are displayed as special mobile versions, designed to be easily viewed from a mobile phone.

Webpages that aren't designed specifically for mobile devices typically open in overview mode. You can view these webpages by zooming and scrolling.

Zooming in or out on a webpage

- Double-tap the screen to zoom in. To return to the default zoom level, double-tap again.
- Tap your finger on the screen to reveal the Zoom controls. Tap  or  to zoom out or in.
- You can also use 2 fingers on the screen, pinching them open and closed to zoom in and out.

Scrolling a webpage

1. Slide your finger on the screen to navigate and view other areas of the webpage.

Using Browser options

Stopping page loading

1. While a webpage is loading, press  **Menu** > **Stop**. Or tap  on the right of the URL field.



Refreshing the current page

1. Press  **Menu** >  **Refresh**.



Getting information about the current page

1. On the Browser screen,
2. Press  **Menu** >  **More** > **Page info**. Or press  **Menu** + **g** at the same time.

Finding the text on the current page

1. While viewing any webpage, press  **Menu** >  **More** > **Find on page**. Or press  **Menu** + **f** at the same time.
2. Enter the search term.
 - As you type, matching characters will be highlighted. Tap  or  to scroll to the previous or next matching term.

Selecting and copying text from a webpage

1. While viewing any webpage, press  **Menu** >  **More** > **Select text**. Or press  **Menu** + **e** at the same time.
2. Drag across the text you want to copy.
 - The text you select is copied to the clipboard. You can paste the copied text into any text field by tapping and holding on a text box and selecting paste.

Sharing a webpage





1. While viewing any webpage, press  **Menu** >  **More** > **Share page**. Or press  **Menu** + **s** at the same time.
2. Tap an application to send the URL. The application opens with the URL you've entered.

Downloading files

You can download images, files, and applications from webpages. All downloaded files are saved to the SD card.



1. Tap and hold an image, a link or a file you want to download.
2. Tap the desired action (**Save image**, **View image**, or **Set as wallpaper**).

Viewing downloaded files

1. From the Home screen, tap  **Browser**.
2. Press  **Menu** >  **More** > **Downloads**. Or press  **Menu** + **d** at the same time.
 - The files you've downloaded are arranged by date. Tap a file to open.
 - If you want to delete a downloaded file, tap and hold the file > **Delete** > **OK**.

Navigating webpages

Opening a new Browser window

1. From the Home screen, tap  **Browser**.
2. Press  **Menu** >  **New window**.
A new window opens with the default homepage.

Opening a link

1. Tap any link to open it.
If you prefer to open the link in a new window, tap and hold the link > **Open in new window**.

Navigating between webpages

- Press  **Back** to return to the previous webpage.
Or press  **Menu** >  **More** > **Forward** if you pressed  **Back** by accident.

Switching between Browser windows

1. From any webpage, press  **Menu** >  **Windows**.
2. Tap the window to view it full screen.
You can also tap  to close a window.

NOTE You can have up to 8 browser windows open at one time.



Using bookmarks

Browser bookmarks are stored shortcuts which allow you to quickly access a webpage without having to type in its full address.

Bookmarking a webpage

1. While viewing a webpage, press  **Menu** >  **More** > **Add bookmark**. Or press  **Menu** + **a** simultaneously.
2. Edit the name or location if needed > Tap **OK**.

Opening a bookmark

1. When viewing any webpage, tap  at the right of the URL field. Or press  **Menu** >  **Bookmarks**.
2. Tap a bookmark to open it.
 - If you prefer to open the webpage in a new window, tap and hold the bookmark and tap **Open in new window**.

Editing a bookmark





1. From any webpage, press  **Menu** >  **Bookmarks**.
2. Tap and hold the bookmark to edit > **Edit bookmark**.
3. Edit the name and/or location > Tap **OK**.

Deleting a bookmark

1. From any webpage, press  **Menu** >  **Bookmarks**.
2. Tap and hold the bookmark to delete > **Delete bookmark** > **OK**.

Browser settings

Customize your browser settings to optimize your browsing experience.

1. From the Home screen, tap  **Browser**.
2. Press  **Menu** >  **More** > **Settings**.
Or press  **Menu** + **p** at the same time.

| | | |
|-----------------------|------------------------|--|
| Page content settings | Text size | Select the size of the text. |
| | Default zoom | Select the zoom level that Browser uses when first opening a webpage. |
| | Open pages in overview | Open webpages zoomed out. |
| | Text encoding | Change the character-encoding standard. |
| | Block pop-up windows | Prevent pop-up windows unless you request it. |
| | Load images | Display images on web pages. |
| | Auto-fit pages | Optimize the presentation of text and other elements of webpages to fit your phone's screen. |
| | Landscape-only display | Display webpages in landscape orientation on your screen. |
| | Enable JavaScript | Allow JavaScript to run on webpages. |
| | Enable plug-ins | Allow plug-ins to run on webpages. |
| | Open in background | Open new windows in the background. |
| | Set home page | Set the default homepage. |
| | Invert color | Display pages in inverted color. |

| | | |
|-------------------|------------------------|--|
| Privacy settings | Clear cache | Delete temporary files. |
| | Clear history | Delete the history of webpages you visited. |
| | Accept cookies | Allow sites to save and read cookie data. |
| | Clear all cookie data | Delete all cookie data. |
| | Remember form data | Remember what you enter in form fields. |
| | Clear form data | Delete all the information the browser remembered. |
| | Enable location | Allow sites to request access to your location. |
| | Clear location access | Delete location access for all websites. |
| Security settings | Remember passwords | Save your passwords for some webpages that require you to sign in. |
| | Clear passwords | Delete all saved passwords. |
| | Show security warnings | Show warning of security alerts. |
| Advanced settings | Set search engine | Select the web search engine you want to use. |
| | Website settings | Set for individual websites. |
| | Reset to default | Restore default settings. |

YouTube

YouTube is Google's online video streaming service for viewing, discovering, and sharing videos.

Opening and signing into YouTube

Signing into YouTube

You can discover and watch YouTube videos without a YouTube account, but if you want to take advantage of many YouTube features, you must sign into your YouTube account.



1. From the Home screen, tap  **Apps** >  **YouTube**.
2. Press  **Menu** > **My Channel**.

The first time you use a YouTube feature that requires an account, you're prompted to sign in. Create a new account or enter your YouTube sign in information if you already have an account.





For more information about YouTube accounts, visit YouTube on the web.

Finding videos



Browsing videos by category













1. From the Home screen, tap  **Apps** >  **YouTube**.
2. Press  **Menu** > **Browse**.
3. Tap a category in the scrolling list.
 - Tap the current time filter setting at the top of the category screen to change the time period and reduce the number of videos listed.
 - Tap **Most viewed**, **Top rated**, **Most discussed** or **Top favorited**.

Searching for videos

1. From the Home screen, tap  **Apps** >  **YouTube**.
2. Tap  or press  **Search**.
3. Enter the search criteria > Tap .
4. Scroll through the search results and tap a video to watch it.







Watching videos

1. From the Home screen, tap  **Apps** >  **YouTube**.
2. Tap a video begin playback.
 - Tap the video to pause or resume playback.
 - Tap **Info**, **Related videos** or **Comments** to learn more about the video.
 - Rotate your phone to watch the video in full-screen view. You can also double-tap the video to toggle full-screen view on and off.



| | | |
|---|---|--|
|  | Give the video the thumbs up or down. | |
|  More |  Flag | Flag the video as inappropriate. |
| |  Save to | Add the video to your channel. |
| |  Favorite | Add the video to your Favorites. |
| |  Share | Send video through  Bluetooth ,  Facebook ,  Gmail ,  Messaging or  Twitter . |
| |  Copy URL | Copy the video's web address. You can paste into a message or other applications. |

Uploading videos



To shoot and upload a new video

1. From the Home screen, tap  **Apps** >  **YouTube**.
2. Tap . The Camera will open in video mode.
3. Tap  or press  **Camera** to start recording > Tap  or press  **Camera** to stop recording.
4. Enter a title for the video and more details > tap **Upload**.

To upload an existing video

1. From the Home screen, tap  **Apps** >  **YouTube**.
2. Press  **Menu** > **Upload**. The gallery will open.
3. Tap the video you want to upload.
4. Enter the title for the video and more details > tap **Upload**.

Sharing videos

1. From the Home screen, tap  **Apps** >  **YouTube**.
2. Tap a video to play.
3. Tap **More** > **Share**.
4. Tap the application you want to use to share the video.

YouTube settings

You can change the following settings for YouTube on your phone.

1. From the Home screen, tap  **Apps** >  **YouTube**.
2. Press  **Menu** >  **Settings**.

| | | |
|------------------|--------------------------------|---|
| General settings | High quality on mobile | Check if you prefer to watch videos in high resolution by default when connected to mobile networks. Watch videos in standard mode to reduce startup time and data use. This setting has no effect if you are connected to a Wi-Fi network, where videos are always shown in higher resolution. |
| | Caption font size | Set the preferred text size when viewing video captions. |
| Search settings | Clear search history | Remove previous YouTube video search results. |
| | SafeSearch filtering | Select if you want Google SafeSearch filtering to block some results when you search for videos. Settings are: Block no search results (Don't filter), only explicit or offensive videos (Moderate), or both explicit and offensive text and videos (Strict). |
| About | Help | Open the YouTube Help Center in your phone's Browser. |
| | Feedback | Open a YouTube feedback form in your phone's Browser. |
| | Google Mobile Terms of Service | Display the Google Mobile Terms of Service. |
| | YouTube Terms of Service | Display the YouTube Terms of Service. |
| | Google Mobile Privacy Policy | Display the Google Mobile Privacy Policy. |
| | YouTube Privacy Policy | Display the YouTube Privacy Policy. |
| | Application version | The YouTube application version number installed on your phone. |

Facebook

The first time you launch the Facebook application, you must agree to the End User License Agreement.

1. From the Home screen, tap  **Apps** >  **Facebook**.
2. If you already have a Facebook account, enter your Email and Password > **Login**.
 - If you do not have a Facebook account, tap **Sign up** to create one.







NOTE You can view the recent activities of contacts in the Facebook application.

Twitter

Adding a Twitter account



1. From the Home screen, tap  **Apps** >  **Twitter**.
2. Enter your twitter Username and Password > **Sign in**.
 - You can post and read tweets, send and receive direct messages and search for new Twitter users to follow.

Creating a tweet

1. From the Home screen, tap  **Apps** >  **Twitter**.
2. Tap  > .
3. Type your tweet > **Tweet**.
 - Tap  or  to post a picture from Gallery or Camera to your default photo hosting site and add the link to the picture in your tweet.



Wi-Fi

Turning Wi-Fi on and connecting to a wireless network

1. From the Home screen, tap  **Apps** >  **Settings**.
2. Tap  **Wireless & networks** > **Wi-Fi settings**.
3. Select the **Wi-Fi** check box to turn Wi-Fi on.
4. The network names and security settings of detected Wi-Fi networks are displayed.
5. Tap a Wi-Fi network to connect.
 - If you selected a network that is secured, enter the security key and then tap Connect. Depending on the network type and security settings, you may also need to enter more information or choose a security certificate.

Connecting to a Wi-Fi network with EAP-TLS security

You may need to install a network certificate to your phone before you can connect to a Wi-Fi network with EAP-TLS authentication protocol.





1. Save the certificate file to the root folder of the microSD card.
2. From the Home screen, tap  **Apps** >  **Settings**.
3. Tap  **Location & security** > **Install from SD card**.
4. Select the network certificate needed to connect to the EAP-TLS network.
5. After the certificate is installed, follow the steps in the previous section to connect to the Wi-Fi network.

Checking wireless network status

1. From the Home screen, tap  **Apps** >  **Settings**.
2. Tap  **Wireless & networks** > **Wi-Fi settings**.
3. Tap the wireless network that the phone is currently connected to.

A message box is then displayed showing the Wi-Fi network name, status, speed, signal strength, and more.

Connecting to another Wi-Fi network

1. From the Home screen, tap  **Apps** >  **Settings**.
2. Tap  **Wireless & networks** > **Wi-Fi settings**.
3. Detected Wi-Fi networks are displayed in the Wi-Fi networks section. To manually scan for available Wi-Fi networks, on the Wi-Fi settings screen, press  **Menu** > **Scan**.
4. Tap another Wi-Fi network to connect to it.

Bluetooth

Using Bluetooth



Bluetooth is a short-range wireless communications technology that devices can use to exchange information over a distance of about 30 feet. The most common Bluetooth devices are headphones, hands-free car kits, and portable devices, including laptops and cell phones.

Turning Bluetooth on or off



1. From the Home screen, tap  **Apps** >  **Settings**.
2. Tap  **Wireless & networks**.
3. Check or uncheck Bluetooth to turn it on or off.

Changing the phone's Bluetooth name

The phone name identifies your phone to other devices.

1. From the Home screen, tap  **Apps** >  **Settings**.
2. Tap  **Wireless & networks**.
3. If Bluetooth isn't turned on, check Bluetooth to turn it on.
4. Tap **Bluetooth settings** > **Device name**.
5. Enter the name for your phone in the dialog box > **OK**.

Pairing your phone with a Bluetooth device

1. From the Home screen, tap  **Apps** >  **Settings**.
2. Tap  **Wireless & networks**.
3. If Bluetooth isn't turned on, check Bluetooth to turn it on.
4. Tap **Bluetooth settings** > **Scan for devices**. A list of nearby Bluetooth devices is displayed.
5. Tap the ID of the other device to pair them.



Connecting to a Bluetooth device

Once paired, your phone will automatically connect whenever it detects a paired Bluetooth device. You can also manually connect Bluetooth devices as follows:

1. From the Home screen, tap  **Apps** >  **Settings**.
2. Tap  **Wireless & networks**.
3. If Bluetooth isn't turned on, check Bluetooth to turn it on.
4. Tap **Bluetooth settings** > **Scan for devices**.
5. When the phone and the device are connected, the device is displayed as connected in the list.



Disconnecting or Unpairing from a Bluetooth Device

Disconnecting a Bluetooth device



1. From the Home screen, tap  **Apps** >  **Settings**.
2. Tap  **Wireless & networks** > **Bluetooth settings**.
3. In the Bluetooth devices section, tap and hold the device name to disconnect.
4. Tap **Disconnect**.

Unpairing from a Bluetooth device



You can make your phone forget its pairing connection with another Bluetooth device.

1. From the Home screen, tap  **Apps** >  **Settings**.
2. Tap  **Wireless & networks** > **Bluetooth settings**.
3. In the Bluetooth devices section, tap and hold the device name to unpair.
4. Tap **Unpair**.

Connecting to a Bluetooth Headset

1. From the Home screen, tap  **Apps** >  **Settings**.
2. Tap  **Wireless & networks** > **Bluetooth settings**.
3. If Bluetooth isn't turned on, check Bluetooth to turn it on.
4. Tap **Scan for devices**. Your phone will start to scan for Bluetooth devices within range.
5. When you see the name of your headset displayed in the Bluetooth devices section, tap the name. Your phone then automatically tries to pair with the Bluetooth device.
6. If automatic pairing fails, enter the passcode supplied with your headset.

Reconnecting a headset

1. Put the Bluetooth device in pairing mode.
2. From the Home screen, tap  **Apps** >  **Settings**.
3. Tap  **Wireless & networks** > **Bluetooth settings**.
4. If Bluetooth isn't turned on, check Bluetooth to turn it on.
5. Tap the device's name in the Bluetooth devices section.
6. If prompted to enter a passcode, try 0000 or 1234, or consult the headset documentation to find the passcode.

Sending and Receiving Information Using Bluetooth

You can use Bluetooth to transfer information between your phone and another Bluetooth-enabled device such as a phone or laptop computer. You can send the following types of information, depending on the device you are sending to:

- Images and videos
- Contacts
- Audio files

To send files, your phone must have an SD Card installed.



NOTE The first time you transfer information between your phone and another device, you need to enter or confirm a security passcode. Your phone and the other device are then paired, and you will not need to exchange passcodes to transfer information in the future.

1. On your phone, open the application that contains the item you want to send.
2. Follow the steps for the type of the application, select **Send File** or **Send** in the menu. Then select **Bluetooth**.
3. If you are prompted to turn on Bluetooth, tap **Yes**.
4. Tap the name of the receiving device.
5. If prompted, accept the connection on the receiving device, and enter the same passcode on both your phone and the other device, or confirm the auto-generated passcode.
6. On the receiving device, accept the file.

Receiving information from another device

Your device is capable of receiving a wide variety of file types with Bluetooth, including photos, music tracks, and documents such as PDFs.

To receive files from another device, your phone must have an SD card installed.

1. From the Home screen, tap  **Apps** >  **Settings**.
2. Tap  **Wireless & networks** > **Bluetooth settings**.
3. If Bluetooth isn't turned on, check Bluetooth to turn it on.
4. Tap the **Discoverable** check box.
5. On the sending device, send one or more files to your phone.
6. If a Bluetooth authorization request is displayed on your phone, enter the same passcode on both your phone and the other device, or confirm the auto-generated passcode.
7. When your phone receives a file transfer request notification, slide down the notifications panel, and then tap **Accept**.
8. When the transfer is complete, a notification is displayed. To open the file immediately, slide down the notifications panel, and tap the notification.

Adding the Bluetooth received folder to the Home screen

You can add a folder to the Home screen that shows all files you have received with Bluetooth.

1. Tap and hold an empty area on the Home screen, tap **Folders** > **Bluetooth received**.
2. Tap and hold the Bluetooth received folder icon, and drag it to your desired Home screen location.

To view the folder contents, tap the folder icon. To open a file, tap the file name.





Entertainment

Camera/Camcorder

You can take pictures and shoot videos with Camera/Camcorder.

Photos and videos captured with the camera will be stored on the phone's microSD card. A microSD card must be installed to use the Camera/Camcorder.



Opening Camera









- From the Home screen, tap  **Apps** >  **Camera**. Or press  **Camera**.
- When in Camcorder mode, drag the  to the Camera position. Or, press  **Menu** > **Switch to camera**.

When you're in Camera mode and you turn your phone left or right, the onscreen camera controls automatically rotate the display.

Camera settings







When in Camera mode, Camera settings are displayed on screen. Before taking the photo, you can adjust your camera settings or leave the controls in automatic mode.

1. From the Home screen, tap  **Apps** >  **Camera**.
2. Tap a setting icon. The settings open over the screen.
3. Tap the setting you want to change.

| | | |
|---|--|--|
|  General settings | Focus mode | Auto, Normal, Macro. |
| | Picture size | 3M Pixels, 2M Pixels, 1M Pixels, VGA. |
| | Picture quality | Super fine, Fine, Normal. |
| | Color effect | None, Mono, Sepia, Negative, Solarize, Aqua. |
| | Select ISO | Auto, ISO100, ISO200, ISO400. |
| | Shutter Sound | Off /On. |
| | Self Timer | Off, 5 seconds, 10 seconds. |
| | Camera settings | Restore to defaults. |
| Store location | Off / On | Activate to use your phone's location-based services. Take pictures wherever you are and tag them with the location. |
| White balance |  Auto,  Incandescent,  Daylight,  Fluorescent,  Cloudy. | |
| Zoom |  1x ~  4x | Tap the amount of zoom you want. Or, double-tap the screen to zoom all the way in or out. |

4. Press  **Back** or tap the screen to close the Settings menus.

Taking a picture

1. From the Home screen, tap  **Apps** >  **Camera**.
2. Frame your subject on screen.
 - Press **Camera**  or tap . The camera brings the image into focus. When the image is in focus, the camera takes a picture.
 - Press and hold **Camera**  or tap and hold  to focus first, before taking a picture. Then lift your finger to take a focused picture more quickly.

The picture you just took is briefly previewed full-screen, and then is displayed as a thumbnail at the top right. Tap the thumbnail to view, share, or work with your pictures in Gallery.



Opening Camcorder







- From the Home screen, tap  **Apps** >  **Camcorder**.
- Or, when you're in Camera mode, drag the  to the Camcorder position. Or, press  **Menu** > **Switch to camcorder**.

The camcorder interface does show in landscape mode. Just sideways.

Camcorder settings

When in Camcorder mode, Camcorder settings are displayed on screen. Before recording, you can adjust your camcorder settings or leave them in automatic mode.







1. From the Home screen, tap  **Apps** >  **Camcorder**.
2. Tap a setting icon. The settings open over the screen.
3. Tap the setting you want to change.

| | | |
|--|--|--|
|  General settings | Continuous AF | Off, On. |
| | Color effect | None, Mono, Sepia, Negative, Solarize, Aqua. |
| | Video quality | VGA, CIF, QVGA, QCIF. |
| | Video Encoder | MPEG4, H263. |
| | Camera settings | Restore to defaults. |
| White balance |  Auto,  Incandescent,  Daylight,  Fluorescent,  Cloudy. | |
| Video quality | High, Low, MMS, YouTube, Custom. | |

4. Press  **Back** or tap the screen to close the Settings menus.

NOTE Depending on the selected video quality, not all video quality and video encoder options may be available.

Recording videos

1. From the Home screen, tap  **Apps** >  **Camcorder**.
2. Frame the scene where you want to start recording.
3. Press **Camera**  or tap  to start recording.
4. Press **Camera**  or tap  to stop recording.

An image from your most recent video is displayed as a thumbnail at the top right. Tap the thumbnail to view, share, or work with your videos in Gallery.

Gallery

Use Gallery to view your pictures and videos. You can edit and add effects to your photos. You can also easily add a photo as your contact icon, location icon, or wallpaper.







Opening Gallery and viewing album lists

Opening Gallery

- From the Home screen, tap  **Apps** >  **Gallery**.
- Or when you're in Camera/Camcorder mode, tap the thumbnail image at the top right.

Your album list is displayed. Albums are groups of images and videos in folders.





Managing Albums

1. From the Home screen, tap  **Apps** >  **Gallery**.
2. Press  **Menu** twice.
3. Check the albums you want.
 - Tap  **Share** > Tap the application to use to share the selected albums. You can share the entire contents of one or more albums.
 - Tap  **Delete** > Tap **Confirm Delete** to delete selected albums and all contents from your microSD card.
 - Tap  **More** > Tap  **Details** to get details about selected albums.

Opening an album and viewing its contents







Viewing contents of an album

After you've selected an album, you can browse through your pictures and videos. Albums open displaying the pictures and videos they contain in a chronologically ordered grid. The name of the album is shown at the top of the screen.

1. From the Home screen, tap  **Apps** >  **Gallery**.
2. Swipe left or right across the screen to view additional albums, then tap an album to open and view its contents.
3. When you open an album,
 - Swipe left or right across the screen to view more contents. Tap a thumbnail image to view it.
 - Drag  to the left or right to scroll adjust scrolling speed. The image creation dates is displayed enabling you to easily locate an image.
 - Tap  to change the album view mode. You can view the pictures and videos in a grid or in stacks, sorted by date and location.

Working with pictures or videos in batches





You can select one or more pictures or videos in an album to work on them in batches.

1. From the Home screen, tap  **Apps** >  **Gallery**.
2. Tap the album you want to open, and then press  **Menu** twice.
3. Check the pictures or videos you want.
 - Tap  **Share** > Tap the application to use to share the selected items.
 - Tap  **Delete** > Tap **Confirm Delete** to delete selected items from your microSD card.
 - Tap  **More** > Tap  **Details** to get details about selected items.







The controls available depend on the mix of selected items.





Viewing pictures

Viewing a picture







1. From the Home screen, tap  **Apps** >  **Gallery**.
2. Tap the album you want to open, and then tap a thumbnail image of picture to view it.
 - Swipe left or right across the screen to view the previous or next picture in the album.
 - Turn your phone left or right to view the picture in upright (portrait) or sideways (landscape) orientation.
3. Tap the screen to see the controls.
 - Tap  or double-tap the screen to zoom in or out.
 - Tap  **Slideshow** to watch a slideshow of your pictures and videos in the album. Tap the screen to stop the slideshow.
 - Tap  **Menu** to view more options.

Working with pictures

1. From the Home screen, tap  **Apps** >  **Gallery**.
2. Tap the album you want to open, and then tap a thumbnail image of the picture.
3. Press  **Menu**. Or tap the screen >  **Menu**.
 - Tap  **Share** > Tap the application to share the picture. You can share a picture by sending it to friends or posting it in a Picasa web album.
 - Tap  **Delete** > Tap **Confirm Delete** to delete the picture from your microSD card.
 - Tap  **More** > Tap one of the icons shown below:

| | | |
|---|--------------------------------|---|
|  Details | Get details about the picture. | |
|  Set as | Contact icon | Use a picture as a contact icon. |
| | Wallpaper | Use a picture as Home screen wallpaper. |
|  Crop | Crop a picture. | |
|  Rotate Left /  Rotate Right | Rotate a picture. | |

Playing videos

1. From the Home screen, tap  **Apps** >  **Gallery**.
2. Tap the album you want to open, and then tap a thumbnail image of the video to view it.
The video is always displayed in landscape mode when you play it.
3. Tap the video to view the controls.
 - Tap  to skip backwards.
 - Tap  to pause the video.
 - Tap  to resume playback.
 - Tap  to skip forward.
 - Tap  for toggling between full screen and best-fit display modes.







Videos

Opening Videos and viewing video lists

Use the Videos application to play videos that you've recorded with the Camcorder, downloaded from the web, or copied onto your microSD card.

- From the Home screen, tap  **Apps** >  **Videos**.
Your video list is displayed. If you tap and hold the file, you can select to play or delete it.





Playing videos

1. From the Home screen, tap  **Apps** >  **Videos**.
2. Tap a video to view it.
Video is always displayed in landscape mode.
3. Tap the video to view the controls.
 - Tap  to skip backwards.
 - Tap  to pause the video.
 - Tap  to resume playback.
 - Tap  to skip forward.
 - Tap  for toggling between full screen and best-fit display modes.

Sound Recorder

Opening Sound Recorder

You must have a microSD card installed to use Sound Recorder.

1. From the Home screen, tap  **Apps** >  **Sound Recorder**.
2. Tap  to start recording a voice clip.
3. Tap  to stop recording.
 - Tap  to listen to the recording.

Music Player

Play music and audio files with Music Player.

NOTE You need to copy music files to your microSD card to use the Music Player.

Viewing your music library

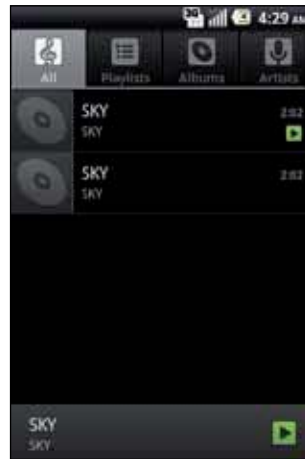

1. From the Home screen, tap **Apps** > **Music Player**.
2. Drag the tabs at the top of the screen to the left or right and select library to open.
 - You can view the lists of music in the microSD card.
 - The lists are automatically organized according information contained in the music files. To view each list of music, you can tap the corresponding category; **All**, **Playlists**, **Albums**, **Artists**, **Genres**, **Composers** or **Years**.

Searching for music in the library

1. From the Home screen, tap **Apps** > **Music Player**.
2. Press **Search**.
 - Start typing the name of an artist, album, or track. Matches are displayed in the list below the search box.
 - Tap a matching song to play it. Or tap a matching album or artist to view a list of associated songs.

Using a song as a ringtone



You can use a song as your phone ringtone.

1. From the Home screen, tap **Apps** > **Music Player**.
2. Tap and hold a song in a library list. In the menu that opens, tap **Use as phone ringtone**.
Or on the Playback screen, press **Menu** > **Use as ringtone**.

Deleting a song from the microSD card

1. From the Home screen, tap **Apps** > **Music Player**.
2. Tap and hold a song. In the menu that opens, tap **Delete** > **OK**.
Or on the Playback screen, press **Menu** > **Delete**.



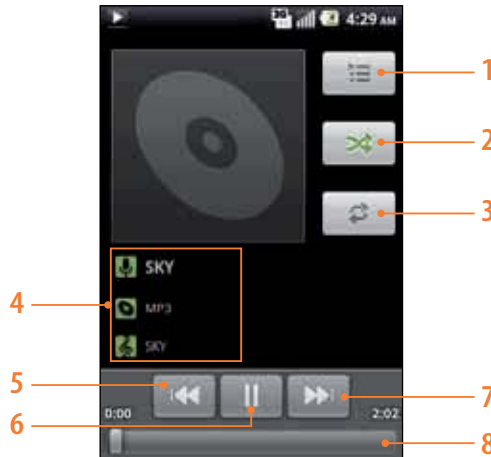

Playing music

1. From the Home screen, tap  **Apps** >  **Music Player**.
 2. Drag the tabs at the top of the screen, and then tap the library you want to open.
 3. Tap a song or press  **Menu** > Tap **Play all** mode or **Shuffle all** mode. Available playback modes vary according to each library setting.
- Tap the on screen icons to control music playback, select a song to play, repeat songs, and more.



| | |
|---|--|
| 1 | Open the current playlist. |
| 2 | Turn shuffle on or off. (Shuffle is off when button is gray.) |
| 3 | Repeat the current playlist: Repeat, Repeat current song, Repeat off. |
| 4 | Tap and hold, then search for the corresponding information in Browser/Music Player/YouTube. |
| 5 | Go to the previous song in the current playlist. |
| 6 | Play/Pause. |
| 7 | Go to the next song in the current playlist. |
| 8 | Drag the slider to go directly to a specific section of a track. |

Music playing features

1. From the Home screen, tap  **Apps** >  **Music Player**.
2. Open the library you want, and then tap the music file.
 - To adjust the volume, press  **Volume up** and  **Volume down**.
 - To listen to music via Bluetooth headset, press  **Menu** > **Via bluetooth**.
 - While music is playing, it is possible to exit to the Home screen or open another application.
 - You can also return to the Music player by opening the Notification panel.

Working with playlists

You can organize the music files by creating playlists.

Creating a playlist

1. From the Home screen, tap  **Apps** >  **Music Player**.
2. Tap the **Playlists** > Press  **Menu** > **New playlist**.
3. Enter the Playlist name > **Save**.

Adding a song to a playlist



1. While in the Music Player, tap and hold the desired track > **Add to playlist** > **Current playlist**, **New** or tap the playlist you want.

| | |
|------------------|---|
| Current playlist | The selected music is added to the current playlist. |
| New | When you enter the name of a playlist and tap Save , the music is added to the new playlist. |

Removing a song from a playlist

1. While in the music player, tap **Playlists** > tap the desired playlist.
2. Tap and hold the track to be deleted > **Remove from playlist**.
 - The song is not deleted from the SD card or other playlists; The song is only removed from the current playlist.



Deleting a playlist

1. From the Home screen, tap  **Apps** >  **Music Player**.
2. Tap the **Playlists** > Tap and hold a playlist to be deleted > **Delete**.
 - Although you delete a playlist, music files will remain on your phone's memory card.

Tools

Clock

Opening the Clock

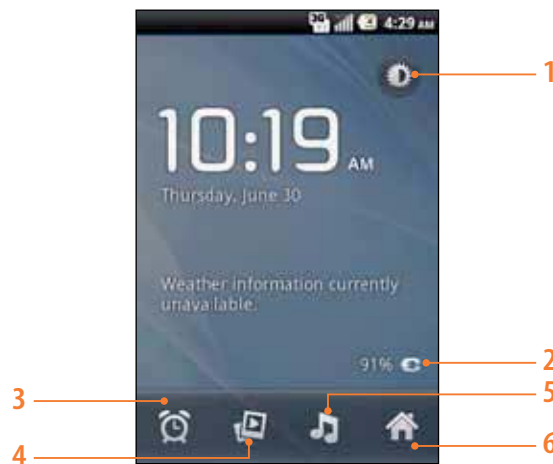

1. From the Home screen, tap  **Apps** >  **Clock**.
 - The Clock application opens and displays the date time, local weather and other useful information.





| | | | |
|---|-----------------------------------|---|---|
| 1 | Tap to dim the screen | 2 | The battery charge level, displayed only while the phone is charging. |
| 3 | Set an alarm and check old alarms | 4 | View a slideshow |
| 5 | Music Player | 6 | Home screen |

Managing Alarms

Adding a new alarm

1. From the Home screen, tap  **Apps** >  **Clock**.
2. Tap  > **Add alarm**.
3. To change the alarm time, tap +/- or type the number using the keyboard. Then toggle AM/PM > **Set**.
4. Check the checkbox, **'Turn alarm on'**.
5. Edit **Turn alarm on**, **Time**, **Repeat**, **Ringtone**, **Vibrate** and **Label** > **Done**.

Editing an alarm

1. From the Home screen, tap  **Apps** >  **Clock**.
2. Tap  > tap an existing alarm.
3. Turn the alarm on or off by checking or un-checking the checkbox, **'Turn alarm on'**. In the alarm list, set alarms are underlined in green.
4. Edit **Time**, **Repeat**, **Ringtone**, **Vibrate** and **Label** > **Done**.
Or tap **Delete** to remove the alarm.

Changing alarm settings

1. From the Home screen, tap  **Apps** >  **Clock**.
2. Tap  > Press  **Menu** >  **Settings**.







| | |
|----------------------|---|
| Alarm in silent mode | Check to play alarms even when the phone is in silent mode. |
| Alarm volume | Set the volume of alarms. |
| Snooze duration | Set how long Clock waits before playing an alarm again. |
| Volume and Camera | Set the button behavior for alarms. |

Stopping an alarm

1. When the alarm sounds, tap **Dismiss** to stop the alarm.
 - Tap **Snooze** to repeat the alarm after a specified length of time.



Calculator

Using Calculator



1. From the Home screen, tap  **Apps** >  **Calculator**.
2. Enter numbers and arithmetic operators.
 - Drag the screen to the left to open the Advanced panel. Or press  **Menu** > **Advanced panel**.
 - Tap and hold the Calculator's display to open a text editing menu. You can cut, copy, and select text for use in Calculator or other Applications.
 - Tap **CLEAR** to delete the last number or operator you entered. Tap and hold **CLEAR** to delete everything in the display.
 - Press the navigation  ,  button on the QWERTY keyboard, to view the numbers you've calculated. If you want to erase this history, press  **Menu** > **Clear history**.

Memo

Adding a new memo

1. From the Home screen, tap  **Apps** >  **Memo**.
2. Tap the **Add New Memo**.
3. Enter the text > **Save**.

Managing Memos



1. From the Home screen, tap  **Apps** >  **Memo**.
2. Tap the memo you want to manage:
 - Tap the Memo screen to edit it and then edit the text > **Save**.
 - Press  **Menu** > **Send to** send it > tap an application to use to send the selected memo.
 - Press  **Menu** > **Delete** > **All** or check on memos you want to delete > **Done**.
Or tap the memo you want to delete > Press  **Menu** > **Delete**.

My Files

You can use the My Files application to manage the contents of your microSD card. If the card memory is full, delete content files to free memory for other items.



NOTE Your applications store settings and configuration information on the microSD card. Be very careful when moving or deleting files as missing or damaged files can cause applications to crash or fail to function.

Opening My Files



1. From the Home screen, tap  **Apps** >  **My Files**.
2. Tap the folder you want to view.

Music and image files will be opened by their corresponding applications. Some file types may not be supported and will be unable to be opened.

Creating a new folder

1. From the Home screen, tap  **Apps** >  **My Files**.
2. Select to the location where you want to create a new folder > Press  **Menu** > Tap **New Folder**.
3. Enter the folder name > **OK**.







Managing File or folder

1. From the Home screen, tap  **Apps** >  **My Files**.
2. Find the file or the folder you want to manage,
 - Tap and hold the item you want to move to another location > **Move** > Select the desired folder or location > **Move here**.
 - Tap and hold the item you want to rename > **Rename** > Enter the file or folder name > **OK**.
 - Tap and hold the item you want to delete > **Delete** > "Do you really want to delete (item name)?" will appear on the screen > **OK**.
 - Tap and hold the file you want to send > **Send** > Tap the application you want to use to send the selected file.
 - Tap and hold the file you want to copy > **Copy** > Tap **Copy here**.

Polaris Office

Polaris Office is divided into a word processor, spreadsheet editor, presentation editor, and a file viewer. It is capable of reading and exporting in Microsoft Office file formats, viewing PDF and image files, and decompressing ZIP files.

Opening Polaris Office

1. From the Home screen, tap  **Apps** >  **Polaris Office**.
2. Enter your name and e-mail address > **Register**.
 - The first time you use the Polaris Office, you are prompted to register. You are not requested to register again after the registration process is completed. If you don't want to register, tap **Later**.
3.  **My folders**,  **Recent documents**,  **Favorites** and  **Box.net** are displayed.
 - On the My folders screen, you can view the documents stored on the microSD card.
 - On the Recent documents screen, you can view the documents recently used.
 - On the Favorites screen, you can view the documents listed in Favorites.
 - Tap and hold the document you want to add it to Favorites > tap **Add to favorites**.
 - If you register your  **Box.net** account, you can view Box.net documents on your phone and download them to the microSD card.

Using Box.net

Registering a Box.net Account

1. From the Home screen, tap  **Apps** >  **Polaris Office**.
2. Tap  **Box.net**. Or press  **Menu** > **New** > **Accounts** > tap  **Box.net**.
3. Enter an **e-mail address** and **Password** > **Add**.

Using the Box.net

1. From the Home screen, tap  **Apps** >  **Polaris Office**.
2. Tap  **Box.net**.
3.  **Box.net** document lists are displayed.
 - To download a document, tap the file you want > **OK** > find to the desired folder location and tap **Select**.
 - To upload a file from the microSD card to  **Box.net**, press  **Menu** > **Upload** > Tap the desired folder location > Tap the file you want to upload.

Viewing a document

1. From the Home screen, tap  **Apps** >  **Polaris Office**.
2. Tap  **My folders**,  **Recent documents**,  **Favorites** > Navigate to the desired file.
 - Supported formats-Microsoft Word 97-2007 (.doc & .docx), Microsoft Excel 97-2007 (.xls & .xlsx), Microsoft PowerPoint 97-2007 (.ppt & .pptx), Adobe PDF, Text (.txt), Web pages (.html), Hansoft Hangul 97-3.0, 2002-2007 (.hwp), Image files (Bitmap, GIF, JPEG, PNG, WBMP, and WMF), Zip archives.
 - Double tap to Zoom in or out when viewing a file. The pages panel appears at the left top. (Depending on file formats, the menu may vary.) Drag across the screen to view specific areas of the document.

3. To use the additional options, press **Menu** while you are viewing the document.



| | |
|--------------------|---|
| Zoom | Select one out of Fit to page, Fit to width, Custom zoom, 25%, 50%, 75%, 100%, 125%, 200%, 300% and 400% to see the screen in the selected view. |
| Edit mode | File formats available for Edit mode: Microsoft Word, Microsoft Excel, Microsoft PowerPoint. |
| Find | Enter desired letters, they can be searched for. |
| Bookclip | Create a new bookclip or view the stored lists of the bookclips. |
| Reflow text | Show a text in full view. |
| More | <ul style="list-style-type: none"> • Send file : Send files through Bluetooth, Facebook, Gmail, Messaging or Twitter. • Settings : When you tap on this part, you can check on or set check boxes including Create back-up file, Display file extensions, Pivot lock, Custom zoom, Accounts, Update and About. |

NOTE Depending on file formats, the menu may vary.

Creating a new file

Creating a document/sheet/slide format file

1. From the Home screen, tap Apps > Polaris Office.
2. Press **Menu** > **New**.
3. Tap **Document**, **Sheet** or **Slide**.
4. After you finish preparing the document > Press **Menu** > Select **save** or **save as**.
5. Enter the **File name** and select the desired folder location > **Save**.

AT&T Applications

AT&T Navigator



The AT&T Navigator™ application on your device uses GPS positioning technology and your carrier's data network to provide you with driving directions and a host of other services, including:

- GPS navigation that gives you turn-by-turn directions to any address in the continental United States. If you miss a turn or get off track, AT&T Navigator will calculate a new route for you.
- You can enter an address using AT&T Navigator's automatic voice recognition system or by entering it on the device's keypad.
- Audio and visual traffic alerts while driving or viewing maps, as well as traffic rerouting capabilities to minimize delays on your trip.
- A search feature that allows you to find businesses or points of interest near your current location, an airport, a waypoint, or any address entered. You can read ratings and reviews of businesses and easily call the business you found to check on the availability of an item or make a reservation. You can navigate to the business location now or save the address for later use.
- Maps of the area around your current location, around a marked waypoint, or around an address that you previously entered. You can pan the map (adjust left, right, up, or down) and zoom in or out. You can also mark a point under the cursor as a waypoint.
- A compass-like indicator specifying your direction of travel, location, and speed.
- Personalization of your application preferences by selecting U.S. customary or metric distance units, the audible guidance language, and so on.

Navigator login

1. From the Home screen, tap  **Apps** >  **AT&T Navigator**.
2. Read the Terms of Service, then tap **Accept** to agree to the terms and continue.
3. To exit AT&T Navigator, tap the **Menu** from the AT&T Navigator Home page, and then tap **Exit**.

Getting directions

1. From the Home screen, tap  **Apps** >  **AT&T Navigator**.
2. Tap **Drive To**, then select the desired option.
3. Tap desired option.
4. To exit at any time, tap the **Back** key until the Home screen is displayed. Press **Back** again or press **Menu** and then tap **Exit**.



Search using text entry

1. From the Home screen, tap  **Apps** >  **AT&T Navigator**.
2. Tap the search box, enter the text you're looking for.
3. Select from the results.
4. Select the desired option.
5. To end the session, tap the **Back** key.
6. To exit AT&T Navigator, tap the **Menu** from the AT&T Navigator Home page, and then tap **Exit**.



Searching by voice

1. From the Home screen, tap  **Apps** >  **AT&T Navigator**.
2. Tap  and then speak the desired name or business category to search.
3. Select from the results.
4. Select the desired option.
5. To end the session, tap the **Back** key.
6. To exit AT&T Navigator, tap the **Menu** from the AT&T Navigator Home page, and then tap **Exit**.

Maps & traffic



1. From the Home screen, tap  **Apps** >  **AT&T Navigator**.
2. Tap **Maps & Traffic**.
3. To return to the AT&T Navigator Home screen, tap the **Menu**, then tap **Home**.
4. To exit AT&T Navigator, tap the **Menu** from the AT&T Navigator Home page, and then tap **Exit**.

Commuting alerts

1. From the Home screen, tap  **Apps** >  **AT&T Navigator**.
2. Tap **Local Apps** > Tap **Commute Alerts**.
3. Tap the **Menu**, then tap **Save**.
4. Tap the **Back** until you reach the AT&T Navigator Home screen.
5. To exit AT&T Navigator, tap the **Menu** from the AT&T Navigator Home page, and then tap **Exit**.

AT&T FamilyMap



Locate your family members with AT&T FamilyMap! Get peace of mind by being able to conveniently locate a family member's wireless phone on a map from your mobile phone or PC. Want to verify that your child arrives home from school each day? Set up a Schedule Check to automatically get location information sent to you via text message or email. Locate any phone indoors or outdoors on the AT&T Network!

1. From the Home screen, tap  **Apps** >  **AT&T FamilyMap**.
2. At the AT&T FamilyMap Sign In page, enter your **Phone Number** and **Password** in the appropriate fields > Tap **Sign In**.
3. Follow the on-screen instructions.

YPmobile



You can use YPmobile to find, get information about, and get directions to businesses in your area.

Find a business

1. From the Home screen, tap  **Apps** >  **YPmobile**.
2. The End User License Agreement displays.
3. Read the agreement and tap **Accept** to continue.
4. Do one of the following:
 - Enter a search term and tap **FIND**.
 - Open the application menu and tap **Browse**. In **Popular Businesses**, scroll left or right through a list of businesses. Tap a company name to find the branch nearest to your current location. Alternatively, browse through service categories in **Popular Categories**.
5. The first result displayed is the business or branch closest to your current location. Tap or to scroll forward or back through the search results. Tap to see the search results in a list. Tap to return to map view.
6. Tap a business name and address to see more details.
7. (Optional) Do any of the following:
 - To phone the business: Tap the phone number.
 - To see the business location on a map: Tap **Map**.
 - To visit the company's website: Tap **company's website**.
 - To get directions in AT&T Navigator: Tap **Navigator**.



Add a local business to your contacts

You can add a local business as a contact in the Contacts app.

1. From the Home screen, tap  **Apps** >  **YPmobile**.
2. Find a local business.
3. Tap the business name and address to see more details.
4. On the business details page, tap the **Add to menu**.
5. Tap **Done**.

Live TV

Transform your phone into a wireless TV. Live TV requires a subscription and data plan, and is not available in all areas. Programs are subject to change.



1. From the Home screen, tap  **Apps** >  **Live TV**.
2. The End User License Agreement displays.
3. Read the agreement and tap **Accept** to continue.
4. Tap the screen of the channel you want to watch on the Home screen of the Live TV, and then you can watch TV.

myAT&T

myAT&T enables you to view usage for minutes, data, and messaging from your phone. With this application you can also access support through FAQs (frequently asked questions).

NOTE In order to access myAT&T, you first need to register your phone with My ATT. Visit <http://www.att.com> for more information.



To access myAT&T

1. From the Home screen, tap  **Apps** >  **myAT&T**.
2. The End User License Agreement displays.
3. Read the agreement and tap **Accept** to continue.
4. Enter your **Wireless #** and **Password**.
5. Select the **Save Password** check box.
6. Tap **Login**. A summary of your account information displays on the menu list (Bill & Pay, Usage, Features and More).

AT&T Code Scanner

AT&T Code Scanner allows you to read popular ID barcode formats. Simply place the barcode in the center of your camera's viewfinder and the code is automatically captured.

To access AT&T Code Scanner

1. From the Home screen, tap  **Apps** >  **AT&T Code Scanner**.
2. Read the agreement and tap **Accept** to continue.
3. Set up your profile to get personalized results > **OK**.
4. Enter your **Zip Code**, and tap **Year of birth** and **Gender**.
5. Select the **Activate profile**.
6. Tap **Done**.

Settings

Settings on Your Phone

Control and customize phone settings on the Settings screen.

1. From the Home screen, tap  **Apps** >  **Settings**.



Wireless & networks

| | |
|-------------------------------|--|
| Airplane mode | Airplane mode On / Off. Check to turn off all the phone's radios that transmit voice or data. |
| Wi-Fi/ Wi-Fi settings | Wi-Fi On / Off. Set up and manage Wi-Fi networks. For details about working with these settings, see "WiFi". |
| Bluetooth/ Bluetooth settings | Bluetooth On / Off. For details about working with these settings, see "Bluetooth". |
| Tethering | Share your phone's mobile data connection via USB. You may need to prepare your computer to establish a network connection via USB. You are required to download USB driver to access this function. To download this USB driver, please visit the Sharp website at http://sharp-world.com/products/smartphone/fxplus/download.html . For details about downloading this USB driver, see "Tethering/Dial-up Networking". |
| Mobile networks | Set options for roaming, networks and APNs. |

Call settings

| | |
|---------------------------------------|---|
| Fixed Dialing Numbers | Configure your phone so it can place outgoing calls only to the fixed dialing numbers (FDN) that you save on the phone's SIM card. |
| Voicemail service/ Voicemail settings | Enter the phone number to use for listening to and managing your voicemail. For details about working with these settings, see "Listening to your voicemail". |
| Noise suppression | To reduce noise during a call. |
| TTY mode | The teletypewriter (TTY) is a telecommunications device that allows people, who are deaf or hard of hearing, or who have speech or language disabilities, to communicate via a telephone. |
| Call forwarding | Configure how your calls are forwarded when you're on the phone, when you don't answer, and so on. |
| Additional settings | Caller ID - You can set whether your phone number is displayed to the people you call. Call waiting - Check to see and respond to new calls when you're already on a call. |

Sound

| | |
|-----------------------|---|
| Normal mode | While in the lowest ringer volume level, your phone operates in silent mode. To change back from silent to vibrate mode, simply press  Volume up . To change back from vibrate to normal mode, press  Volume up button. |
| Silent mode | When set to silent, your phone doesn't play any ring, alert, and effects sounds. You must silence media and alarms in their own applications. |
| Phone vibrate | Configure when you want the phone to vibrate when you receive a phone call or notification. |
| Volume | Set the volume of ringtones that sound when you receive a phone call or notification, media (music, videos, and so on), and alarms. |
| Phone ringtone | Select the ringtone to sound when you receive a phone call. |
| Notification ringtone | Select the ringtone to sound when you receive a notification. |
| Audible touch tones | Play tones when using dial pad. |
| Audible selection | Play sound when making screen selection. |
| Screen lock sounds | Play sounds when locking and unlocking the screen. |
| Haptic feedback | Vibrate when pressing soft keys and on certain UI interactions. |

Display

| | |
|--------------------|--|
| Brightness | Adjusting the brightness of the screen. |
| Auto-rotate screen | Automatically switch the orientation of the screen as you turn the phone sideways or even upside down. |
| Animation | Configures the level of user interface animation. |
| Screen timeout | Adjust the delay before the screen automatically turns off. |

Location & security

| | |
|------------------------------|---|
| Use wireless networks | Location determined by Wi-Fi and/or mobile networks. |
| Use GPS satellites | When locating, accurate to street level(uncheck to conserve battery). |
| Use GPS XTRA Data | Does not use Predicted Orbits Data for GPS. |
| Set up screen lock | Configure your phone to require a pattern, PIN, or password to unlock your screen. |
| Security lock timer | You can select Immediately, 5 minutes, 10 minutes, 15 minutes or 30 minutes. |
| Set up SIM card lock | Configure the phone to require entering the SIM PIN to use the phone, and where you can change the SIM PIN. |
| Visible passwords | Show password characters as you enter them. |
| Select device administrators | Add or remove device administrators. |
| Use secure credentials | Allow applications to access secure certificates and other credentials. |
| Install from SD card | Install encrypted certificates from an SD card. |
| Set password | Set or change the credential storage password. |
| Clear storage | Clear credential storage of all contents and reset its password. |

Applications

| | |
|---------------------|--|
| Unknown sources | Allow installation of non-Market applications. |
| Quick launch | Set keyboard shortcuts to launch applications. |
| Manage applications | Manage and remove installed applications. |
| Running services | View and control currently running services. |
| Development | Set options for application development. |

Accounts & sync

| | |
|-----------------|---|
| Background data | Set whether applications can sync, send and receive data at any time. |
| Auto-sync | Allow applications to sync data automatically. |
| Manage accounts | Lists the Google accounts and other accounts you've added to the phone. If you tap an account, its account screen opens. |

Privacy

| | |
|--------------------|--|
| Back up my data | Allow settings and other application data to be backed up to Google servers. |
| Automatic restore | Allow settings or other data to be restored from Google servers if an application is reinstalled. |
| Factory data reset | Erases all data on phone. This will erase all data from your phone, including: your Google account, system and application data and settings, downloaded applications. And it will not erase: current system software and bundled applications, SD card files, such as music or photos. |

SD card & phone storage

| | |
|-----------------|--|
| Total space | Check the total space of SD card. |
| Available space | Check the available space on SD card. |
| Unmount SD card | Unmount the SD card for safe removal. If you unmount the SD card, some applications you are using will stop and may be unavailable until you remount the SD card. |
| Format SD card | This will erase all data from the SD card. You must unmount an SD card before you can format it. |
| Available space | Check the available space on internal phone storage. |

Language & keyboard

| | |
|---|--|
| Select language | Select the language to use for the text on your phone. |
| Swype/ Swype settings | Set Swype as a keyboard option. For details about working with these settings, see "Swype text entry". |
| Android keyboard/ Android keyboard settings | Set Vibrate on keypress, Sound on keypress, Auto-capitalization, Voice input, Input languages, Quick fixes, Show suggestions and Auto-complete. For details about working with these settings, see "Using the onscreen keyboard". |
| Device keyboard | Settings for the slide out keyboard. |
| User dictionary | Add or delete the words suggested when entering text. |

Voice input & output

| | |
|---------------------------|--|
| Voice recognizer settings | Set Language, SafeSearch, Block offensive words and Show hints. |
| Text-to-speech settings | Select Listen to an example, Always use my settings, (Default Engine, Install voice data, Speech rate, Language), (Pico TTS setting). In order to use the text-to-speech feature, voice data must be downloaded from the Android Market to your phone's SD Card. Select the Install voice data menu item to install Text-to-speech data. |

Accessibility

| | |
|------------------------|--|
| Accessibility | Accessibility options are activated after downloading the Accessibility service from the Android Market. |
| TalkBack | TalkBack is a screen reader that provides spoken feedback when using native Android applications. Once installed it becomes part of the Android system and cannot be uninstalled. TalkBack does not run if Accessibility is disabled. You can download this plug-in from Android Market. |
| Power button ends call | During a call, pressing Power ends call instead of turning off screen. |

Date & time

| | |
|--------------------|---|
| Automatic | Use network-provided values. |
| Set date | If Automatic is unchecked, manually set the phone's date. |
| Select time zone | If Automatic is unchecked, set the phone's time zone. |
| Set time | If Automatic is unchecked, set the phone's time. |
| Use 24-hour format | Display the time using 24-hour format. |
| Select date format | Select the format for displaying dates. |

About phone

| | |
|----------------------|---|
| Status | Information about your Phone number, signal, etc. |
| Battery use | Check what has been using the battery. |
| Legal information | Open source licenses and Google legal. |
| Model number | Check the Model number. |
| Android version | Check the Android version. |
| Baseband version | Check the Baseband version. |
| Kernel version | Check the Kernel version. |
| Software version | Check the Software version. |
| Hardware version | Check the Hardware version. |
| Touch screen version | Check the Touch screen version. |

Software update

Your phone can check and then notify you if there's a new update. You can then download and install the software update using your phone's Wi-Fi or data connection.

Depending on the type of update, the update may erase all your personal data and customized settings, and also remove any applications you've installed. Make sure that you've backed up the information and files you want to keep.

- Wait for the update process to finish. When the update is finished, the phone will automatically reset.

Check for updates

1. From the Home screen, tap  **Apps** >  **Settings**.

2. Tap  **Software update**.

- Tap **Check for Update**, and you can check the updates available.
- Tap **Resume Update**, you can select 'Install Software Updates' or 'Download Software Update'.
- If Network Error, the software update could not be downloaded and an error message will be shown.

Tethering/Dial-up Networking

USB Tethering for Windows Computer

Share your phone's mobile data connection via USB. You may need to prepare your computer to establish a network connection via USB. You are required to download USB driver to access this function.

1. Download the Sharp FX PLUS USB driver installation application from the Sharp website at <http://sharp-world.com/products/smartphone/fxplus/download.html>.
2. Unzip and run the downloaded installer file. You may be required to reboot your computer to complete the installation.
3. Connect your Sharp FX PLUS to your computer with the USB cable. Do not change any settings on the phone.
4. Wait for your computer to auto-detect and configure the Sharp FX PLUS drivers.
5. Enable USB tethering mode on your Sharp FX PLUS:

- From the Home screen, tap  **Apps** >  **Settings**.
- Tap  **Wireless & networks** > **Tethering**.

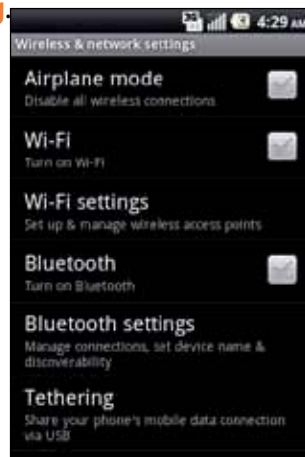

- Check the checkbox, '**USB tethering**'.

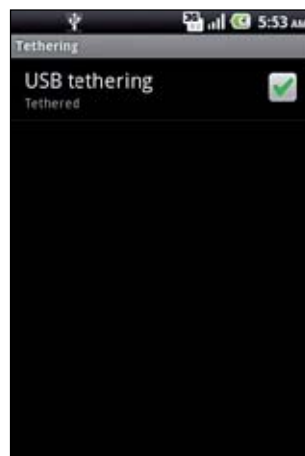

6. You will see the tethering icon in the status bar on the phone and an additional driver may auto-install on your computer.
7. Once the above steps are completed, your computer will detect the Sharp FX PLUS as an Ethernet connection automatically whenever the Sharp FX PLUS is connected and USB tethering mode is selected.
8. Your computer now can use the data connection of the phone without further configuration.

USB Networking for Mac®

Share your phone's mobile data connection via USB. You will need to install USB drivers and then configure a dial-up network connection to establish a data session using your Sharp FX PLUS.

NOTE Direct data connection via USB tethering is not available for Mac® computers.
Mac® and Mac OS® are trademarks of Apple Inc., registered in the U.S. and other countries.

Supported Software Versions

| OS | Architecture | Version |
|-------------|--------------|---------|
| Mac® | PPC 32bit | 10.4.x |
| | Intel 32bit | 10.4.x |
| | | 10.5.x |
| | | 10.6.x |
| Intel 64bit | 10.6.x | |

Installing USB Drivers on a Mac®

1. To download the USB driver install files contained in the MAC_USBDriver_V***.zip file, please visit the Sharp website at <http://sharp-world.com/products/smartphone/fxplus/download.html>.
2. Double-click MAC_USBDriver_V***.zip file to unzip the installation files.
3. Double-click SharpHSUSB_V***.pkg.zip installer file.
4. Double-click SharpHSUSB_V***.pkg file.
5. Click **Continue** > Select a destination volume and click **Install**.



6. If required, type your password and click **OK** > Installing Sharp HSUSB Device by clicking **Continue Installation**.



7. After the install is complete, click **Restart** to reboot your computer.

Setting up the Dial-up Modem (Mac OS® X 10.5 or Later)

1. Connect your Sharp FX PLUS to your Mac® with the USB cable.
2. Your computer will auto-detect the Sharp FX PLUS and prompt you to set up a new modem connection.



3. Click **Network Preferences...** If your computer does not auto-detect the Sharp FX PLUS, open the **Applications** folder > **System Preferences** > **Network**.
4. Select **Sharp USB Modem** > Type ***98#** or ***99#** in the Telephone Number field depending on your local network settings.

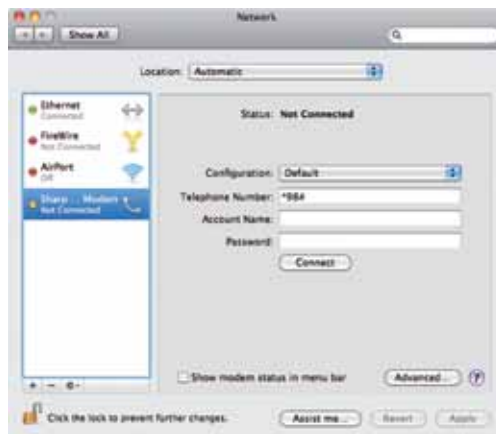

5. Click **Advanced** > Change the Model setting to **GPRS (GSM/3G)** > Enter **isp.cingular** in the APN field > Click **OK** to return to the Network setup window.



6. Click **Connect** > **Apply** > Sharp USB Modem is connected.



Setting up the Dial-up Modem (Mac OS® X 10.4)

1. Connect your Sharp FX PLUS to your Mac® with the USB cable.
2. Click **Network** and select **Sharp USB Modem** on Show list > **Apply Now**.



3. Select **Modem** > Change Modem Setting as below.



4. Select **PPP** > Type ***98#** in the Telephone Number field.



5. Click **PPP Options...** > Change PPP Options Setting as below > **OK**.



6. Click **Dial Now...** > **Connect**.



7. Sharp USB Modem is connected.



Safety Information

Safety Information for Wireless Handheld Phones

Read this information before using your handheld portable cellular telephone

Driving safety

Talking on the phone while driving is extremely dangerous and is illegal in some states. Remember, safety comes first. Check the laws and regulations on the use of phones in the areas where you drive. Always obey them. If you must use your Sharp FX PLUS while driving, please:

- Give full attention to driving. Driving safely is your first responsibility.
- Use hands-free operation and/or one-touch, speed dialing.
- Pull off the road and park before making or answering a call.

An air bag inflates with great force. DO NOT place objects, including either installed or portable wireless equipment, in the area over the air bag or in the air bag deployment area. If in-vehicle wireless equipment is improperly installed and the air bag inflates, serious injury could result.



Failure to follow these instructions could lead to serious personal injury and possible property damage.

Electronic devices

Your wireless handheld portable telephone is a low power radio transmitter and receiver. When it is ON, it receives and also sends out radio frequency (RF) signals.

Most modern electronic equipment is shielded from RF energy. However, certain electronic equipment may not be shielded against the RF signals from your wireless phone. Therefore, use of your Sharp FX PLUS must be restricted in certain situations.

Pacemakers

The Health Industry Manufacturers Association recommends that a minimum separation of six (6) inches be maintained between a handheld wireless phone and a pacemaker to avoid potential interference with the pacemaker. These recommendations are consistent with the independent research and recommendations of Wireless Technology Research.

Never come closer than six (6) inches to a person with a heart pacemaker implant when using your Sharp FX PLUS. Doing so could result in interference with the function of the pacemaker.

Persons with pacemakers:

- ALWAYS keep the phone more than six (6) inches from your pacemaker when the phone is turned on.
- Do not carry the phone in a breast pocket.
- Use the ear opposite the pacemaker to minimize the potential for interference.
- If you have any reason to suspect that interference is taking place, turn your Sharp FX PLUS OFF immediately.

Hearing AIDS

Some digital wireless phones may interfere with some hearing aids. In the event of such interference, you may want to consult your service provider (or call the customer service line to discuss alternatives).

Other medical devices

If you use any other personal medical device, consult the manufacturer of your device to determine if they are adequately shielded from external RF energy. Your physician may be able to assist you in obtaining this information.

Hospitals and health care facilities

Turn your Sharp FX PLUS OFF in health care facilities when any regulations posted in these areas instruct you to do so. Hospitals or healthcare facilities may be using equipment that could be sensitive to external RF energy.

Vehicles

RF signals may affect improperly installed or inadequately shielded electronic systems in motor vehicles. Check with the manufacturer or its representative regarding your vehicle. You should also consult the manufacturer of any equipment that has been added to your vehicle.

Posted facilities

Turn your Sharp FX PLUS OFF where posted notices so require.

Aircraft

FCC regulations prohibit using your Sharp FX PLUS while in the air. Turn your phone OFF before boarding an aircraft. Always request and obtain prior consent and approval of an authorized airline representative before using your phone aboard an aircraft. Always follow the instructions of the airline representative whenever using your phone aboard an aircraft, to prevent any possible interference with airborne electronic equipment.

Blasting areas

To avoid interfering with blasting operations, turn your Sharp FX PLUS OFF when in a "blasting area" or in areas posted "Turn off two-way radio". Obey all signs and instructions.

Potentially explosive atmospheres

Turn your Sharp FX PLUS OFF when in any area with a potentially explosive atmosphere and obey all signs and instructions. Sparks in such areas could cause an explosion or fire resulting in bodily injury or even death.

Areas with a potentially explosive atmosphere are often, but not always, clearly marked. They include fueling areas such as gas stations: below deck on boats: fuel or chemical transfer or storage facilities: vehicles using liquefied petroleum gas (such as propane or butane): areas where the air contains chemicals or particles, such as grain, dust, or metal powders: and any other area where you would normally be advised to turn off your vehicle's engine.

Hearing AID Compatibility with Mobile Phones

When some mobile phones are used near some hearing devices (hearing aids and cochlear implants), users may detect a buzzing, humming, or whining noise. Some hearing devices are more immune than others to this interference noise, and phones also vary in the amount of interference they generate.

The wireless telephone industry has developed ratings for some of their mobile phones, to assist hearing device users in finding phones that may be compatible with their hearing devices. Not all phones have been rated. Phones that are rated have the rating on their box or a label on the box.

The ratings are not guarantees. Results will vary depending on the user's hearing device and hearing loss. If your hearing device happens to be vulnerable to interference, you may not be able to use a rated phone successfully. Trying out the phone with your hearing device is the best way to evaluate it for your personal needs.

M-Ratings: Phones rated M3 or M4 meet FCC requirements and are likely to generate less interference to hearing devices than phones that are not labeled. M4 is the better/higher of the two ratings.

T-Ratings: Phones rated T3 or T4 meet FCC requirements and are likely to be more usable with a hearing device's telecoil ("T Switch" or "Telephone Switch") than unrated phones. T4 is the better/higher of the two ratings. (Note that not all hearing devices have telecoils in them.)

This phone has been tested and rated for use with hearing aids for some of the wireless technologies that it uses. However, there may be some newer wireless technologies used in this phone that have not been tested yet for use with hearing aids. It is important to try the different features of this phone thoroughly and in different locations, using your hearing aid or cochlear implant, to determine if you hear any interfering noise. Consult your service provider or the manufacturer of this phone for information on hearing aid compatibility. If you have questions about return or exchange policies, consult your service provider or phone retailer.

Hearing devices may also be measured for immunity to this type of interference. Your hearing device manufacturer or hearing health professional may help you find results for your hearing device.

The more immune your hearing aid is, the less likely you are to experience interference noise from mobile phones.

Safety Information for FCC RF Exposure



Read this information before using your Sharp FX PLUS.

In August 1996 the Federal Communications Commission (FCC) of the United States with its action in Report and Order FCC 96-326 adopted an updated safety standard for human exposure to radio frequency electromagnetic energy emitted by FCC regulated transmitters. Those guidelines are consistent with the safety standard previously set by both U.S. and international standards bodies. The design of this phone complies with the FCC guidelines and these international standards.

Body-worn operation

This device was tested for typical body-worn operations with the back of the phone kept 2.0 cm from the body. To maintain compliance with FCC RF exposure requirements, use only belt-clips, holsters or similar accessories that maintain a 2.0 cm separation distance between the user's body and the back of the phone, including the antenna. The use of belt-clips, holsters and similar accessories should not contain metallic components in its assembly. The use of accessories that do not satisfy these requirements may not comply with FCC RF exposure requirements, and should be avoided.

For more information about RF exposure, please visit the FCC website at www.fcc.gov.

SAR Information

This model phone meets the government's requirements for exposure to radio waves.

Your wireless phone is a radio transmitter and receiver. It is designed and manufactured not to exceed the emission limits for exposure to radiofrequency (RF) energy set by the Federal Communications Commission of the U.S. Government. These limits are part of comprehensive guidelines and establish permitted levels of RF energy for the general population. The guidelines are based on standards that were developed by independent scientific organizations through periodic and thorough evaluation of scientific studies. The standards include a substantial safety margin designed to assure the safety of all persons, regardless of age and health.

The exposure standard for wireless mobile phones employs a unit of measurement known as the Specific Absorption Rate, or SAR. The SAR limit set by the FCC is 1.6 W/kg. * Tests for SAR are conducted with the phone transmitting at its highest certified power level in all tested frequency bands. Although the SAR is determined at the highest certified power level, the actual SAR level of the phone while operating can be well below the maximum value. This is because the phone is designed to operate at multiple power levels so as to use only the power required to reach the network. In general, the closer you are to a wireless base station antenna, the lower the power output. Before a phone model is available for sale to the public, it must be tested and certified to the FCC that it does not exceed the limit established by the government adopted requirement for safe exposure.

The tests are performed in positions and locations (e.g., at the ear and worn on the body) as required by the FCC for each model. While there may be differences between the SAR levels of various phones and at various positions, they all meet the government requirement for safe exposure.

| | HEAD | BODY |
|-----------|------------|-----------|
| GSM850 | 0.595 W/kg | 0.943W/kg |
| GSM1900 | 0.335 W/kg | 0.530W/kg |
| WCDMA850 | 0.724 W/kg | 0.573W/kg |
| WCDMA1900 | 0.798 W/kg | 0.618W/kg |

The FCC has granted an Equipment Authorization for this model phone with all reported SAR levels evaluated as in compliance with the FCC RF exposure guidelines. SAR information on this model phone is on file with the FCC and can be found under the Display Grant section of [http:// www.fcc.gov/oet/fccid](http://www.fcc.gov/oet/fccid) after searching on APYNAR0074.

Additional information on Specific Absorption Rates (SAR) can be found on the Cellular Telecommunications & Internet Association (CTIA) website at <http://www.phonefacts.net>.

* In the United States and Canada, the SAR limit for mobile phones used by the public is 1.6 watts/kg (W/kg) averaged over one gram of tissue.

The standard incorporates a substantial margin of safety to give additional protection for the public and to account for any variations in measurements.

FDA Consumer Update



U.S. Food and Drug Administration Cell Phone Facts Consumer Information on Wireless Phones

1. What kinds of phones are the subjects of this update?

The term “wireless phone” refers here to handheld wireless phones with built-in antennas, often called “cell,” “mobile,” or “PCS” phones.

These types of wireless phones can expose the user to measurable radiofrequency energy (RF) because of the short distance between the phone and the user’s head. These RF exposures are limited by Federal Communications Commission safety guidelines that were developed with the advice of FDA and other federal health and safety agencies.

When the phone is located at greater distances from the user, the exposure to RF is drastically lower because a person’s RF exposure decreases rapidly with increasing distance from the source. The so-called “cordless phones,” which have a base unit connected to the telephone wiring in a house, typically operate at far lower power levels, and thus produce RF exposures well within the FCC’s compliance limits.

2. Do wireless phones pose a health hazard?

The available scientific evidence does not show that any health problems are associated with using wireless phones. There is no proof, however, that wireless phones are absolutely safe. Wireless phones emit low levels of radiofrequency energy (RF) in the microwave range while being used. They also emit very low levels of RF when in the standby mode. Whereas high levels of RF can produce health effects (by heating tissue), exposure to low level RF that does not produce heating effects causes no known adverse health effects.

Many studies of low level RF exposures have not found any biological effects. Some studies have suggested that some biological effects may occur, but such findings have not been confirmed by additional research.

In some cases, other researchers have had difficulty in reproducing those studies, or in determining the reasons for inconsistent results.

3 . What is FDA’s role concerning the safety of wireless phones?

Under the law, FDA does not review the safety of radiation-emitting consumer products such as wireless phones before they can be sold, as it does with new drugs or medical devices. However, the agency has authority to take action if wireless phones are shown to emit radiofrequency energy (RF) at a level that is hazardous to the user. In such a case, FDA could require the manufacturers of wireless phones to notify users of the health hazard and to repair, replace or recall the phones so that the hazard no longer exists.

Although the existing scientific data do not justify FDA regulatory actions, FDA has urged the wireless phone industry to take a number of steps, including the following:

- Support needed research into possible biological effects of RF of the type emitted by wireless phones:
- Design wireless phones in a way that minimizes any RF exposure to the user that is not necessary for device function: and
- Cooperate in providing users of wireless phones with the best possible information on possible effects of wireless phone use on human health

FDA belongs to an interagency working group of the federal agencies that have responsibility for different aspects of RF safety to ensure coordinated efforts at the federal level. The following agencies belong to this working group:

- National Institute for Occupational Safety and Health
- Environmental Protection Agency
- Federal Communications Commission

-
- Occupational Safety and Health Administration
 - National Telecommunications and Information Administration

The National Institutes of Health participates in some interagency working group activities, as well.

FDA shares regulatory responsibilities for wireless phones with the Federal Communications Commission (FCC). All phones that are sold in the United States must comply with FCC safety guidelines that limit RF exposure. FCC relies on FDA and other health agencies for safety questions about wireless phones.

FCC also regulates the base stations that the wireless phone networks rely upon. While these base stations operate at higher power than do the wireless phones themselves, the RF exposures that people get from these base stations are typically thousands of times lower than those they can get from wireless phones. Base stations are thus not the primary subject of the safety questions discussed in this document.

4. What are the results of the research done already?

The research done thus far has produced conflicting results, and many studies have suffered from flaws in their research methods. Animal experiments investigating the effects of radiofrequency energy (RF) exposures characteristic of wireless phones have yielded conflicting results that often cannot be repeated in other laboratories. A few animal studies, however, have suggested that low levels of RF could accelerate the development of cancer in laboratory animals.

However, many of the studies that showed increased tumor development used animals that had been genetically engineered or treated with cancer-causing chemicals so as to be pre-disposed to develop cancer in the absence of RF exposure. Other studies exposed the animals to RF for up to 22 hours per day. These conditions are not similar to the conditions under which people use wireless phones, so we don't know with certainty what the results of such studies mean for human health. Three large epidemiology studies have been published since December 2000. Between them, the studies investigated any possible association between the use of wireless phones and primary brain cancer, glioma, meningioma, or acoustic neuroma, tumors of the brain or salivary gland, leukemia, or other cancers. None of the studies demonstrated the existence of any harmful health effects from wireless phone RF exposures. However, none of the studies can answer questions about long-term exposures, since the average period of phone use in these studies was around three years.

5. What research is needed to decide whether RF exposure from wireless phones poses a health risk?

A combination of laboratory studies and epidemiological studies of people actually using wireless phones would provide some of the data that are needed. Lifetime animal exposure studies could be completed in a few years. However, very large numbers of animals would be needed to provide reliable proof of a cancer promoting effect if one exists.

Epidemiological studies can provide data that is directly applicable to human populations, but 10 or more years' follow-up may be needed to provide answers about some health effects, such as cancer. This is because the interval between the time of exposure to a cancer-causing agent and the time tumors develop - if they do - may be many, many years.

The interpretation of epidemiological studies is hampered by difficulties in measuring actual RF exposure during day-to-day use of wireless phones. Many factors affect this measurement, such as the angle at which the phone is held, or which model of phone is used.

6. What is FDA doing to find out more about the possible health effects of wireless phone RF?

FDA is working with the U.S. National Toxicology Program and with groups of investigators around the world to ensure that high priority animal studies are conducted to address important questions about the effects of exposure to radiofrequency energy (RF).

FDA has been a leading participant in the World Health Organization International Electromagnetic Fields (EMF) Project since its inception in 1996. An influential result of this work has been the development of a detailed agenda of research needs that has driven the establishment of new research programs around the world. The Project has also helped develop a series of public information documents on EMF issues.

FDA and the Cellular Telecommunications & Internet Association (CTIA) have a formal Cooperative Research and

Development Agreement (CRADA) to do research on wireless phone safety. FDA provides the scientific oversight, obtaining input from experts in government, industry, and academic organizations. CTIA-funded research is conducted through contracts to independent investigators. The initial research will include both laboratory studies and studies of wireless phone users. The CRADA will also include a broad assessment of additional research needs in the context of the latest research developments around the world.

7. What steps can I take to reduce my exposure to radiofrequency energy from my wireless phone?

If there is a risk from these products--and at this point we do not know that there is--it is probably very small. But if you are concerned about avoiding even potential risks, you can take a few simple steps to minimize your exposure to radiofrequency energy (RF). Since time is a key factor in how much exposure a person receives, reducing the amount of time spent using a wireless phone will reduce RF exposure.

- If you must conduct extended conversations by wireless phone every day, you could place more distance between your body and the source of the RF, since the exposure level drops off dramatically with distance. For example, you could use a headset and carry the wireless phone away from your body or use a wireless phone connected to a remote antenna.

Again, the scientific data do not demonstrate that wireless phones are harmful. But if you are concerned about the RF exposure from these products, you can use measures like those described above to reduce your RF exposure from wireless phone use.

8. What about children using wireless phones?

The scientific evidence does not show a danger to users of wireless phones, including children and teenagers. If you want to take steps to lower exposure to radiofrequency energy (RF), the measures described above would apply to children and teenagers using wireless phones.

Reducing the time of wireless phone use and increasing the distance between the user and the RF source will reduce RF exposure. Some groups sponsored by other national governments have advised that children be discouraged from using wireless phones at all.

For example, the government in the United Kingdom distributed leaflets containing such a recommendation in December 2000. They noted that no evidence exists that using a wireless phone causes brain tumors or other ill effects. Their recommendation to limit wireless phone use by children was strictly precautionary: it was not based on scientific evidence that any health hazard exists.

9. Do hands-free kits for wireless phones reduce risks from exposure to RF emissions?

Since there are no known risks from exposure to RF emissions from wireless phones, there is no reason to believe that hands-free kits reduce risks. Hands-free kits can be used with wireless phones for convenience and comfort. These systems reduce the absorption of RF energy in the head because the phone, which is the source of the RF emissions, will not be placed against the head. On the other hand, if the phone is mounted against the waist or other part of the body during use, then that part of the body will absorb more RF energy. Wireless phones marketed in the U.S. are required to meet safety requirements regardless of whether they are used against the head or against the body. Either configuration should result in compliance with the safety limit.

10. Do wireless phone accessories that claim to shield the head from RF radiation work?

Since there are no known risks from exposure to RF emissions from wireless phones, there is no reason to believe that accessories that claim to shield the head from those emissions reduce risks. Some products that claim to shield the user from RF absorption use special phone cases, while others involve nothing more than a metallic accessory attached to the phone.

Studies have shown that these products generally do not work as advertised. Unlike "hand-free" kits, these so-called "shields" may interfere with proper operation of the phone. The phone may be forced to boost its power to compensate, leading to an increase in RF absorption. In February 2002, the Federal Trade Commission (FTC) charged two companies that

sold devices that claimed to protect wireless phone users from radiation with making false and unsubstantiated claims. According to FTC, these defendants lacked a reasonable basis to substantiate their claim.

11. What about wireless phone interference with medical equipment?

Radiofrequency energy (RF) from wireless phones can interact with some electronic devices. For this reason, FDA helped develop a detailed test method to measure electromagnetic interference (EMI) of implanted cardiac pacemakers and defibrillators from wireless telephones. This test method is now part of a standard sponsored by the Association for the Advancement of Medical Instrumentation (AAMI). The final draft, a joint effort by FDA, medical device manufacturers, and many other groups, was completed in late 2000. This standard will allow manufacturers to ensure that cardiac pacemakers and defibrillators are safe from wireless phone EMI.

FDA has tested hearing aids for interference from handheld wireless phones and helped develop a voluntary standard sponsored by the Institute of Electrical and Electronic Engineers (IEEE). This standard specifies test methods and performance requirements for hearing aids and wireless phones so that that no interference occurs when a person uses a "compatible" phone and a "compatible" hearing aid at the same time. This standard was approved by the IEEE in 2000.

FDA continues to monitor the use of wireless phones for possible interactions with other medical devices. Should harmful interference be found to occur, FDA will conduct testing to assess the interference and work to resolve the problem.

Updated July 29, 2003

For more information, please visit the FDA website at <http://www.fda.gov/cellphones>.

Emergency Calls

Never rely solely upon your wireless phone for essential communications (e.g., medical emergencies), if it can be avoided, since a wireless phone requires a complex combination of radio signals, relay stations and landline networks for its operation. Consequently, emergency calls may not always be possible under all conditions on all wireless phone systems. Your wireless phone, however, may sometimes be the only available means of communication at the scene of an accident. When making an emergency call, always give the recipient all necessary information as accurately as possible. Never terminate an emergency call until you have received clearance to do so.

FCC enhanced 911 (E911) rules

Background

The Federal Communications Commission (FCC) requires wireless carriers to transmit specific latitude and longitude location (Automatic Location Identification = ALI) information as well as “911” calls to Public Safety Answering Points (PSAPs) to identify the location of the caller in case of emergency.

Generally, the rules require that carriers identify an E911 caller’s location within 50 meters of the actual location for 67 percent of calls and within 150 meters of the actual location for 95 percent of calls.

Sharp FX PLUS’s ALI Capability

The Sharp FX PLUS is an ALI-capable phone equipped with a GPS (Global Positioning System) receiver supporting a satellite-based GPS ALI-capable network to comply with the FCC’s ALI requirements.

The network compliance with the above FCC requirements is dependent on: (a) the use of digital technology by the wireless network; (b) GPS satellite signals being able to reach the handset (such transmissions do not always work indoors, for example) ; and (c) handset signals reaching wireless “base stations” (atmospheric and environmental conditions may cause variations in handset receiving signal strength).

Also the transmission of the ALI information is subject, in part, to system constraints within the wireless network to which the E911 signal is transmitted and over which Sharp FX PLUS has no control.

Finally, customers are advised that the Sharp FX PLUS’s ALI capability is to be used for E911 purposes only.

This feature allows you to place an emergency call even if your phone is in “Phone Lock” or “Restrict” mode when you dial the preprogrammed emergency number, 911, #911, or *911. It also operates in out-of-service areas. The phone maintains the emergency mode until you press the Power/Lock key after disconnecting an emergency call. In emergency call mode, the phone can receive an incoming call from any available system.

To call “911” in “Phone Lock” or “Restrict” mode.

1. Tap **Emergency call**, and tap **911** in ICE-Emergency call list.
 - “911” and “Emergency call” will appear on the screen.

Compliance with Other FCC Regulations

Operating procedures

Never violate any of the following Rules and Regulations of the FCC when using your Cellular Phone. Such violations are punishable by fine, imprisonment or both.

- Never use obscene, indecent, or profane language.
- Never use your Cellular Phone to send false distress calls.
- Never wiretap or otherwise intercept a phone call, unless you have first obtained the consent of the parties participating in the call.
- Never make any anonymous calls to annoy, harass, or molest other people.
- Never charge another account without authorization, to avoid payment for service.
- Never willfully or maliciously interfere with any other radio communications.
- Never refuse to yield the line when informed that it is needed for an Emergency Call. Also, never take over a line by stating falsely that it is needed for an emergency.

General Safety

Precautions

Your Handheld Portable Telephone is a high quality piece of equipment. Before operating, read all instructions and cautionary markings on the product, battery and adapter/charger.

Failure to follow the directions below could result in serious bodily injury and/or property damage due to battery liquid leakage, fire or rupture.

- DO NOT use or store this equipment in a place where it will be exposed to high temperatures, such as near an open flame or heat-emitting equipment.
- DO NOT drop your device or subject it to severe shock. When not using, lay down the unit to avoid possible damage due to instability.
- DO NOT use it or store it where fluids such as water can splash onto it. Raindrops, water spray, juice, coffee, steam, perspiration, etc. will also cause malfunctions.
- DO NOT use unauthorized accessories.
- DO NOT disassemble the phone or its accessories. If service or repair is required, return unit to an authorized Personal Communications Devices cellular service center. If unit is disassembled, the risk of electric shock or fire may result.
- DO NOT drop your device or subject it to severe impacts. Bending the body and pushing the display or keys with extreme force could damage the device.
- DO NOT carry your device in your back pocket as it could break when you sit down. The display is made of glass and is particularly fragile.
- Your device contains exposed magnets, which may cause damage to credit cards, magnetic ID cards, and other magnetically encoded materials. Do not place these or other items that are sensitive to magnetic fields near the exposed magnets. For example, do not place your device in the same pocket as your credit card or hotel key.
- Using this device for long periods of time (e.g., playing games) may cause the device and the battery charger to get warm. If you feel the device or the battery charger is too warm, avoid sustained contact with exposed skin otherwise this might cause discomfort, or eventually a burn.

Battery

Battery safety

Your device uses a removable and rechargeable lithium ion battery. Please contact customer service for assistance should you need a replacement battery.

Do's

- Only use the battery and charger approved by the manufacturer.
- Only use the battery for its original purpose.
- Try to keep batteries in a temperature between 41°F (5°C) and 95°F (35°C).
- If the battery is stored in temperatures above or below the recommended range, give it time to warm up or cool down before using.
- Store the discharged battery in a cool, dark, and dry place.
- Purchase a new battery when its operating time has decreased, even when fully charged.
- Properly dispose of the battery according to local regulations.

Don'ts

- Don't attempt to disassemble the battery – it is a sealed unit with no serviceable parts.
- Don't expose the battery terminals to any other metal object (e.g., by carrying it in your pocket or purse with other metallic objects such as coins, clips and pens). This can short circuit and critically damage the battery.
- Don't leave the battery in hot or cold environments. Otherwise, it could significantly reduce the capacity and lifetime of the battery.
- Don't dispose of the battery in a fire.

If you find the battery charger overheating, smelling unusual, or smoking, disconnect the battery charger from the AC outlet, turn your device off, and remove the battery from your phone immediately.

It is normal for the battery charger to become warm while charging the battery.

Lithium ion batteries are recyclable. When you replace your built-in battery, please request the repair center to recycle the battery in accordance with RBRC standards. When disposing of the battery yourself, please call RBRC at (800) 822-8837 for proper disposal tips.

Never touch any fluid that might leak from the battery. Such liquid when in contact with the eyes or skin, could cause injury. Should the liquid come into contact with the eyes, irrigate the eyes thoroughly with clean water and immediately seek medical attention. In the event the liquid comes into contact with skin or clothing, wash it away immediately with clean water.

Adapter/Charger

Charger

The charger designed by Sharp for this unit requires the use of a standard 120 V AC power source for its operation.

- Never attempt to disassemble or repair a charger.
- Never use a charger if it has a damaged or worn power cord or plug. Always contact a Personal Communications Devices authorized service center, if repair or replacement is required.
- Never alter the AC cord or plug on your charger. If the plug will not fit into the available outlet, have a proper outlet installed by a qualified electrician.
- Never allow any liquids or water to spill on the charger when it is connected to an AC power source. Always use the charger designed for this unit to avoid any risk of bodily injury or damage to your cellular phone or battery.
- Never attempt to connect or disconnect the charger with wet hands. Always unplug the charger from the power source before attempting any cleaning. Always use a soft cloth dampened with water to clean the equipment, after it has been unplugged.

Handling the cord on this product or cords associated with accessories sold with this product, may expose you to lead, a chemical known to the State of California to cause birth defects or other reproductive harm.

Wash hands after handling. Always disconnect the charger from the power source when it is not in use.

Games

Seizures/Blackouts

Warning

A very small percentage of individuals may experience epileptic seizures when exposed to certain light patterns or flashing lights. Exposure to certain patterns or backgrounds on a computer screen, or while playing video games, may induce an epileptic seizure in these individuals.

Certain conditions may induce previously undetected epileptic symptoms even in persons who have no history of prior seizures or epilepsy.

If you, or anyone in your family, have an epileptic condition, consult your physician prior to playing. If you experience any of the following symptoms while playing a video or computer game- dizziness, altered vision, eye or muscle twitches, loss of awareness, disorientation, any involuntary movement, or convulsions- IMMEDIATELY discontinue use and consult your physician before resuming play.

Repetitive Motion Injuries

When you play games on your phone, you may experience occasional discomfort in your hands, arms, shoulders, neck, or other parts of your body. Follow these instructions to avoid problems such as tendonitis, carpal tunnel syndrome, or other musculoskeletal disorders:

- Take a minimum 15-minute break every hour of game playing.
- If your hands, wrists, or arms become tired or sore while playing, stop and rest for several hours before playing again.
- If you continue to have sore hands, wrists, or arms during or after play, stop playing and see a doctor.

Recycle Your Cell Phone!

Carriers marketing this cell phone have an in-store phone take-back program. Consumers can drop off their used wireless devices to specified carrier retail outlets for recycling purposes. For a list of carrier members and collection sites, visit the cellular industry's recycling website www.recyclewirelessphones.com.

To mail in your old wireless device to Personal Communications Devices for recycling purposes, simply package your old wireless device and any accessories (including discharged batteries) in appropriate shipping materials and mail to:

For Recycling Personal Communications Devices LLC 555 Wireless Blvd. Hauppauge, NY 11788

Wireless phones also can be donated to the Wireless Foundation's DONATE A PHONE® CALL TO PROTECT® campaign. This charitable cause collects wireless phones to benefit victims of domestic violence. All donated phones are tax deductible. You may mail the phone to:

CALL TO PROTECT, 2555 Bishop Circle, West Dexter, MI 48130.

-OR-

Drop the phone off at a local collection center. For a list of collection centers, visit www.wirelessfoundation.org/CalltoProtect/dropoff.cfm Before returning any wireless device for recycling purposes, please remember to terminate your service on the device, clear the device of any stored information and remove the device's SIM card, if it has one (please contact your wireless provider to find out if your device contains a SIM card and for assistance on how to remove it).

Recycling Information

The RBRC™ Battery Recycling Seal on the Lithium ion (Li-ion) battery/battery pack indicates Personal Communications Devices, LLC is voluntarily participating in an industry program to collect and recycle these battery/battery packs at the end of their useful life, when taken out of service in the United States or Canada.

The RBRC™ program provides a convenient alternative to placing Li-ion batteries into the trash or municipal waste stream, which is illegal in some areas. Please call 1-800-822-8837 for information on Li-ion battery recycling in your area. Personal Communications Devices, LLC involvement in this program is part of our commitment to preserving our environment and conserving our natural resources. (RBRC™ is a trademark of the Rechargeable Battery Recycling Corporation.)



FCC Compliance Information

This device complies with Part 15 of FCC Rules. Operation is subject to the following two conditions:

- (1) This device may not cause harmful interference, and
- (2) This device must accept any interference received.

Including interference that may cause undesired operation.

Information to User

This equipment has been tested and found to comply with the limits for a Class B digital device, pursuant to part 15 of the FCC Rules. These limits are designed to provide reasonable protection against harmful interference in a residential installation. This equipment generates, uses and can radiate radio frequency energy and, if not installed and used in accordance with the instructions, may cause harmful interference to radio communications. However, there is no guarantee that interference will not occur in a particular installation.

If this equipment does cause harmful interference to radio or television reception, which can be determined by turning the equipment off and on, the user is encouraged to try to correct the interference by one or more of the following measures:

- Reorient or relocate the receiving antenna.
- Increase the separation between the equipment and receiver.
- Connect the equipment into an outlet on a circuit different from that to which the receiver is connected.
- Consult the dealer or an experienced radio/ TV technician for help.



The user who makes changes or modifications to the unit without the express approval by the manufacturer will void user authority to operate the equipment.

Copyright & Patent

Software Copyright Notice

All Intellectual Property, as defined below, owned by or which is otherwise the property of Sharp or its respective suppliers relating to the Sharp Phone, including but not limited to, accessories, parts, or software relating there to (the "Phone System"), is proprietary to Sharp and protected under federal laws, state laws, and international treaty provisions. Intellectual Property includes, but is not limited to, inventions (patentable or un-patentable), patents, trade secrets, copyrights, software, computer programs, and related documentation and other works of authorship. You may not infringe or otherwise violate the rights secured by the Intellectual Property. Moreover, you agree that you will not (and will not attempt to) modify, prepare derivative works of, reverse engineer, decompile, disassemble, or otherwise attempt to create source code from the software. No title to or ownership in the Intellectual Property is transferred to you. All applicable rights of the Intellectual Property shall remain with Sharp and its suppliers.

Copyright © 2010 Google Inc. All rights reserved. Google, the stylized Google logo, Android, the stylized Android logo, Android Market, the stylized Android Market logo, Gmail, Google Apps, Google Calendar, Google Checkout, Google Earth, Google Latitude, Google Maps, Google Talk, Picasa, SafeSearch, and YouTube are trademarks of Google Inc. All other company and product names may be trademarks of the companies with which they are associated. Availability of Google applications, services, and features may vary by country, carrier, phone model, and manufacturer.

Warranty

Manufacturer's Warranty

12 month limited warranty

Personal Communications Devices, LLC. (the Company) warrants to the original retail purchaser of this handheld portable cellular telephone, that should this product or any part thereof during normal consumer usage and conditions, be proven defective in material or workmanship that results in product failure within the first twelve (12) month period from the date of purchase, such defect(s) will be repaired or replaced (with new or rebuilt parts) at the Company's option, without charge for parts or labor directly related to the defect(s).

The antenna, keypad, display, rechargeable battery and battery charger, if included, are similarly warranted for twelve (12) months from date of purchase.

This Warranty extends only to consumers who purchase the product in the United States or Canada and it is not transferable or assignable.

This Warranty does not apply to:

- (a) Product subjected to abnormal use or conditions, accident, mishandling, neglect, unauthorized alteration, misuse, improper installation or repair or improper storage;
- (b) Product whose mechanical serial number or electronic serial number has been removed, altered or defaced.
- (c) Damage from exposure to moisture, humidity, excessive temperatures or extreme environmental conditions;
- (d) Damage resulting from connection to, or use of any accessory or other product not approved or authorized by the Company;
- (e) Defects in appearance, cosmetic, decorative or structural items such as framing and non-operative parts;
- (f) Product damaged from external causes such as fire, flooding, dirt, sand, weather conditions, battery leakage, blown fuse, theft or improper usage of any electrical source.

The Company disclaims liability for removal or reinstallation of the product, for geographic coverage, for inadequate signal reception by the antenna or for communications range or operation of the cellular system as a whole.

When sending your wireless device to Personal Communications Devices for repair or service, please note that any personal data or software stored on the device may be inadvertently erased or altered.

Therefore, we strongly recommend you make a back up copy of all data and software contained on your device before submitting it for repair or service. This includes all contact lists, downloads (i.e. third-party software applications, ringtones, games and graphics) and any other data added to your device. In addition, if your wireless device utilizes a SIM or Multimedia card, please remove the card before submitting the device and store for later use when your device is returned, Personal Communications Devices is not responsible for and does not guarantee restoration of any third-party software, personal information or memory data contained in, stored on, or integrated with any wireless device, whether under warranty or not, returned to Personal Communications Devices for repair or service.

To obtain repairs or replacement within the terms of this Warranty, the product should be delivered with proof of Warranty coverage (e.g. dated bill of sale), the consumer's return address, daytime phone number and/or fax number and complete description of the problem, transportation prepaid, to the Company at the address shown below or to the place of purchase for repair or replacement processing. In addition, for reference to an authorized Warranty station in your area, you may telephone in the United States (800) 229-1235, and in Canada (800) 465-9672 (in Ontario call 416-695-3060).

THE EXTENT OF THE COMPANY'S LIABILITY UNDER THIS WARRANTY IS LIMITED TO THE REPAIR OR REPLACEMENT PROVIDED ABOVE AND, IN NO EVENT, SHALL THE COMPANY'S LIABILITY EXCEED THE PURCHASE PRICE PAID BY PURCHASER FOR THE PRODUCT.

ANY IMPLIED WARRANTIES, INCLUDING ANY IMPLIED WARRANTY OF MERCHANTABILITY OR FITNESS FOR A PARTICULAR PURPOSE, SHALL BE LIMITED TO THE DURATION OF THIS WRITTEN WARRANTY. ANY ACTION FOR BREACH OF ANY WARRANTY MUST BE BROUGHT WITHIN A PERIOD OF 18 MONTHS FROM DATE OF ORIGINAL PURCHASE.

IN NO CASE SHALL THE COMPANY BE LIABLE FOR AN SPECIAL CONSEQUENTIAL OR INCIDENTAL DAMAGES FOR BREACH OF THIS OR ANY OTHER WARRANTY, EXPRESS OR IMPLIED, WHATSOEVER.

THE COMPANY SHALL NOT BE LIABLE FOR THE DELAY IN RENDERING SERVICE UNDER THIS WARRANTY OR LOSS OF USE DURING THE TIME THE PRODUCT IS BEING REPAIRED OR REPLACED.

No person or representative is authorized to assume for the Company any liability other than expressed herein in connection with the sale of this product.

Some states or provinces do not allow limitations on how long an implied warranty lasts or the exclusion or limitation of incidental or consequential damage so the above limitation or exclusions may not apply to you. This Warranty gives you specific legal rights, and you may also have other rights, which vary from state to state or province to province.

IN USA: **Personal Communications Devices, LLC.**
555 Wireless Blvd.
Hauppauge, NY 11788
(800) 229-1235

IN CANADA: **PCD Communications Canada Ltd.**
5535 Eglinton Avenue West Suite #234
Toronto, ON M9C 5K5
(800) 465-9672