

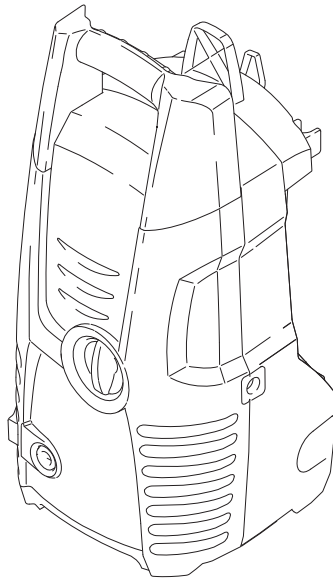

EN

# TITAN

## 1300W High Pressure Washer



Original Instructions\_TTB1300PRW\_V2\_20200825\_95813-FK

### TTB1300PRW

EAN: 5059340124117

Ref. No.: 888KH

**CAUTION:** Read the instructions before using the product.



BX220IM





# TITAN

**Congratulations on your purchase of TITAN a power tool from Kingfisher International Products B.V. We want you to continue getting the best performance from it so this handbook includes information on safety, handling and care. Please retain this handbook in case you need to refer to any of the information in the future.**

**Your TITAN power tool comes with a 2 years guarantee, so should it develop a fault within this period contact your retailer.**

## **GARANTIE**

This **TITAN** product carries a guarantee of 2 years. If your product develops a fault within this period, you should in the first instance contact the retailer where the item was purchased.

This guarantee specifically excludes losses caused due to:

- Fair wear and tear
- Misuse or abuse
- Lack of routine maintenance
- Failure of consumable items (such as batteries)
- Accidental damage
- Cosmetic damage
- Failure to follow manufacturer's guidelines
- Loss of use of the goods

This guarantee does not affect your statutory rights. This guarantee is only valid in the UK.

For any enquiries relating to the guarantee please refer to your retailer.

**1300W High Pressure Washer TTB1300PRW**



# Let's get started...

These instructions are for your safety. Please read through them thoroughly before use and retain them for future reference.



## Getting **started...** 03

<b>Safety information</b>	04
<b>Your product</b>	11
<b>Before you start</b>	14



## In more **detail...** 21

<b>Product functions</b>	22
<b>Operation</b>	25
<b>Care and maintenance</b>	30
<b>Troubleshooting</b>	35
<b>Recycling and disposal</b>	37
<b>Guarantee</b>	37
<b>EC declaration of conformity</b>	38

## Safety warnings

1. Machines shall not be used by children. Children should be supervised to ensure that they do not play with the product.
2. This machine can be used by people with reduced physical, sensory or mental capabilities or lack of experience and knowledge if they have been given supervision or instruction concerning use of the machine in a safe way and understand the hazards involved.

### Safety warnings for high pressure cleaner

1. **WARNING:** This product has been designed for use with the cleaning agent supplied or recommended by the manufacturer. The use of other cleaning agents or chemicals may adversely affect the safety of the machine.
2. **WARNING:** During use of high pressure cleaners, aerosols may be formed. Inhalation of aerosols can be hazardous to health.
3. **WARNING:** High pressure jets can be dangerous if subject to misuse. Never direct the jet at persons, live electrical equipment or the product itself.
4. **WARNING:** Do not use the machine within range of persons unless they wear protective clothing.
5. **WARNING:** Do not direct the jet against yourself or others in order to clean clothes or foot-wear.
6. **WARNING:** Risk of explosion – Do not spray flammable liquids.
7. **WARNING:** High pressure cleaners shall not be used by children or untrained personnel.
8. **WARNING:** High pressure hoses, fittings and couplings are important for the safety of the product. Use only hoses, fittings and couplings recommended by the manufacturer.



9. **WARNING:** To ensure machine safety, use only original spare parts from the manufacturer or approved by the manufacturer.
10. **WARNING:** Water that has flowed through backflow preventers is considered to be non-potable.
11. **WARNING:** Remove the plug from the socket-outlet and disconnected from the power source during cleaning or maintenance and when replacing parts or converting the machine to another function.
12. **WARNING:** Do not use the machine if a supply cord or important parts of the machine are damaged, e.g. safety devices, high pressure hoses, trigger gun.
13. **WARNING:** Inadequate extension cords can be dangerous. If an extension cord is used, it shall be suitable for outdoor use, and the connection has to be kept dry and off the ground. It is recommended that this is accomplished by means of a cord reel which keeps the socket at least 60 mm above the ground.
14. **WARNING:** Always switch off the mains disconnecting switch when leaving the machine unattended.
15. Never use the product with inflammable or toxic liquids, or liquids with characteristics incompatible with its proper operation.
16. Never use the product outdoors in the rain.
17. Never lock the gun trigger in the operating position.
18. Check that the product is fitted with its rating label; contact your dealer if it is missing. Products without rating label must not be used, since they cannot be identified and are potentially hazardous.
19. Never tamper with or adjust the setting of the safety valve or the safety devices.
20. Never change the original diameter of the adjustable nozzle.

## Safety warnings

21. Never leave the product unattended when it is running.
22. Do not allow vehicles to drive over the pressure hose.
23. Do not move the product by pulling on the pressure hose.
24. When directed towards tyres, tyre valves or other pressurised components, the high pressure jet is potentially dangerous. Do not apply a jet stream and always keep the nozzle at a distance of at least 30 cm during cleaning.
25. Protect all electrical conductors against the water jet.
26. High pressure may cause parts to rebound: wear all the protective clothing and equipment needed to ensure the operator's safety.
27. Wear appropriate Personnel Protection Equipment (PPE) while operation e.g. safety boots, safety gloves, safety helmets with visors, hearing protection etc.
28. Be aware of kick-back: grip the gun firmly when squeezing the trigger.
29. Comply with the regulations of the local water supply authority. Under EN 12729 (BA) the product can be connected directly to the mains drinking water supply only if the supply hose is fitted with a backflow preventer device with drainage facility.
30. Discharge residual pressure before disconnecting the hose from the product.
31. Check before each use, and at regular intervals, that all metal fasteners are tight and the product's components are in good condition; inspect for broken or worn parts.
32. **WARNING:** Use only detergents compatible with the high pressure hose cladding materials or other cladding materials.



33. The electric supply connection shall be made by a qualified electrician and comply with IEC 60364- 1. It is recommended that the electric supply to this machine should include a residual current device that will interrupt the supply if the leakage current to earth exceeds 30 mA for 30 ms or a device that will prove the earth circuit.
34. If the supply cord is damaged, it must be replaced by the manufacturer, its service agent or similarly qualified persons in order to avoid a hazard.

The following information applies to professional users only but is good practice for all users:

#### **Vibration and noise reduction**

**To reduce the impact of noise and vibration emission, limit the time of operation, use low-vibration and low-noise operating modes as well as wear personal protective equipment.**

Take the following points into account to minimise the vibration and noise exposure risks:

1. Only use the product as intended by its design and these instructions.
2. Ensure that the product is in good condition and well maintained.
3. Use correct accessories for the product and ensure they are in good condition.
4. Keep tight grip on the handles/grip surface.
5. Maintain this product in accordance with these instructions and keep it well lubricated (where appropriate).
6. Plan your work schedule to spread any high vibration tool use across a longer period of time.

## Safety warnings

7. Prolonged use of the product exposes the user to vibrations that can cause a range of conditions collectively known as hand-arm vibration syndrome (HAVS) e.g. fingers going white; as well as specific diseases such as carpal tunnel syndrome. To reduce this risk when using the product, always wear protective gloves and keep your hands warm.

### Emergency

**Familiarise yourself with the use of this product by means of this instruction manual. Memorise the safety directions and follow them to the letter. This will help to prevent risks and hazards.**

1. **Always be alert when using this product, so that you can recognise and handle risks early.** Fast intervention can prevent serious injury and damage to property.
2. **Switch off and disconnect from the power supply if there are malfunctions.** Have the machine checked by a qualified professional and repaired, if necessary, before you operate it again.

### Residual risks

**Even if you are operating this product in accordance with all the safety requirements, potential risks of injury and damage remain. The following dangers can arise in connection with the structure and design of this product:**

1. Health defects resulting from vibration emission if the product is being used over long periods of time or not adequately managed and properly maintained.









2. Injuries and damage to property due to broken attachments or the sudden impact of hidden objects during use.
3. Danger of injury and property damage caused by flying objects.



**WARNING!** This product produces an electromagnetic field during operation! This field may under some circumstances interfere with active or passive medical implants! To reduce the risk of serious or fatal injury, we recommend persons with medical implants to consult their doctor and the medical implant manufacturer before operating this product!

## Symbol

On the product, the rating label and within these instructions you will find among others the following symbols and abbreviations. Familiarise yourself with them to reduce hazards like personal injuries and damage to property.

V~	Volt, (alternating voltage)	kg	Kilogram
Hz	Hertz	dB(A)	Decibel (A-rated)
W	Watt	m/s <sup>2</sup>	Metres per second squared
/min or min <sup>-1</sup>	Per minute	MPa	Mega Pascal, pressure unit
mm	Millimetre	bar	Pressure unit
IPX5	The product is protected against water (out of a nozzle) from all directions.		
yyWxx	Manufacturing date code; year of manufacturing (20yy) and week of manufacturing (Wxx).		
	Lock / to tighten or secure.		
	Unlock / to loosen.		
	Note / Remark.		
	Caution / Warning.		

## Symbol



Read the instruction manual.



Wear hearing protection.



Wear eye protection.



Wear respiratory protection.



Wear protective gloves.



Wear protective, slip-resistant footwear.



Switch the product off and disconnect it from the power supply before assembly, cleaning, adjustments, maintenance, storage and transportation.



Always ensure that other people and pets remain at a safe distance from the product when it is in operation. In general, children must not come near the area where the product is.



Do not expose the product to rain or wet conditions.



This product is not suitable for connection to the potable water mains.



Do not direct the water jet onto people, animals, electrical equipment or onto the product itself.



Guaranteed sound power level value in dB.



This product is of protection class II. That means it is equipped with enhanced or double insulation.



The product complies with the applicable European directives and an evaluation method of conformity for these directives was done.



WEEE symbol. Waste electrical products should not be disposed of with household waste. Please recycle where facilities exist. Check with your Local Authority or local store for recycling advice.



## Your product

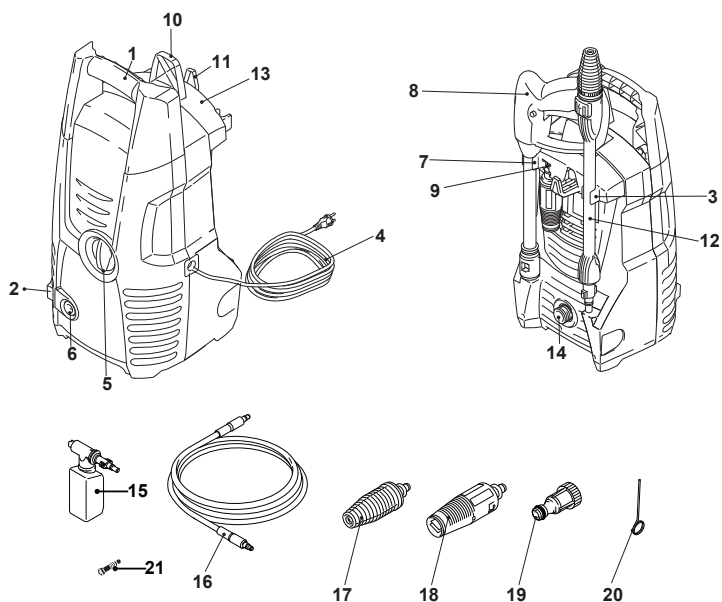

- |   |                              |
|---|------------------------------|
| 1. Transportation handle  | 12. Extension lance          |
| 2. Fast high pressure hose release button                         | 13. Accessories holder       |
| 3. Accessories storage compartment (extension lance)              | 14. Water inlet              |
| 4. Supply cord with plug  | 15. Soap tank                |
| 5. On/off switch I/O  | 16. Pressure hose            |
| 6. Water outlet   | 17. Rotary nozzle            |
| 7. Accessories storage compartment (spray gun)                    | 18. Vario nozzle             |
| 8. Spray gun  | 19. Water inlet hose adaptor |
| 9. Accessories storage compartment (Vario nozzle & Rotary nozzle) | 20. Cleaning needle          |
| 10. Hose holder / handle  | 21. Screws x 4               |
| 11. Power cord storage  |                              |

Getting started...

## Technical specifications

### General

> Rated voltage/frequency	: 220 – 240 V ~ / 50 Hz
> Rated input	: 1300 W
> Rated pressure	: 6.7 MPa
> Max. allowable pressure	: 10 MPa
> Max. inlet water pressure	: 1 MPa
> Rated flow	: 4.5 l/min
> Max. rated flow	: 6.5 l/min
> Rated temperature	: 50°C
> Gun kickback force at max. pressure	: 9.1 N
> Protection class	: II □
> Degree of protection	: IPX5
> Weight	: 5,2 kg
> Dimensions	: 220 X 240 X 460 mm

### High pressure hose

> Allowable pressure	: 12 MPa
> Maximum temperature	: 60 °C
> Length	: 6 m

### Water hose (not supplied)

> Quality	: reinforced PVC hose
> Diameter	: min. Ø 12.7 mm (½")
> Max. length	: 10 m

### Sound level

> Sound pressure level $L_{pA}$	: 69.4 dB(A)
> Uncertainty $K_{pA}$	: 2.50 dB(A)
> Measured sound power level $L_{WA}$	: 80.9 dB(A)
> Uncertainty $K_{WA}$	: 2.50 dB(A)
> Guaranteed sound power level $L_{WA}$	: 83 dB(A)

(acc. to 2000/14/EC amended by 2005/88/EC)

### Vibration level

> Declared vibration emission value $a_{hd}$	: < 2.5 m/s <sup>2</sup>
> Uncertainty K	: 1.0 m/s <sup>2</sup>



The sound values have been determined according to noise test code given in EN 60335-2-79, using the basic standards ISO 3744 and ISO 11203.

The sound intensity level for the operator may exceed 80 dB(A) and ear protection measures are necessary.

The declared vibration value has been measured in accordance with a standard test method (according to EN 60335-2-79) and may be used for comparing one product with another. The declared vibration value may also be used in a preliminary assessment of exposure.



**WARNING!** Depending on the actual use of the product the vibration values can differ from the declared total! Adopt proper measures to protect yourself against vibration exposures. Take the whole work process including times the product is running under no load or switched off into consideration. Proper measures include among others regular maintenance and care of the product and cutting attachments, keeping hands warm, periodical breaks and proper planning of work processes.

Getting started...

### Rating Label Explanation

TTB1300PRW

TT = TITAN

B = 240V AC

1300 = 1300W

PRW = Pressure washer

## Unpacking



**WARNING!** The product is heavy, ask another person for assistance if required!

1. Unpack all parts and lay them on a flat, stable surface.
2. Remove all packing materials and shipping devices if applicable.
3. Make sure the delivery contents are complete and free of any damage. If you find that parts are missing or show damage do not use the product but contact your dealer. Using an incomplete or damaged product represents a hazard to people and property.
4. Ensure that you have all the accessories and tools needed for assembly and operation. This also includes suitable personal protective equipment.



**WARNING!** The product and the packaging are not children's toys! Children must not play with plastic bags, sheets and small parts! There is a danger of choking and suffocation!

## You will need

### (items not supplied)

Suitable personal protective equipment  
Water hose

### (items supplied)

Spray gun (8)  
Pressure hose (16)  
Rotary nozzle (17)  
Vario nozzle (18)  
Water inlet hose adaptor (19)  
Extension lance (12)

## Assembly



**WARNING!** The product must be fully assembled before operation! Do not use a product that is only partly assembled or assembled with damaged parts!



Follow the assembly instructions step-by-step and use the pictures provided as a visual guide to easily assemble the product! Do not connect the product to power supply before it is completely assembled!



**NOTE:** Take care of small parts that are removed during assembly or when making adjustments. Keep them secure to avoid loss.

1. Assemble the product completely before use. Attach the accessories holder (13) to the back of the washer using two screws (21) (Fig. 1). Then attach the handle (1) using two screws (21) (Fig. 2). Tighten the screws (21) using a suitable crosshead screwdriver.

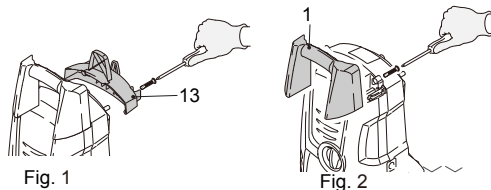

2. Screw the water inlet hose connector (19) to the water inlet (14) (Fig. 3).

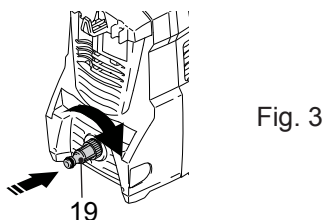

3. Attach a suitable water hose to the water supply and then attach the other end to the water hose inlet connector (19) of the product (Fig. 4).

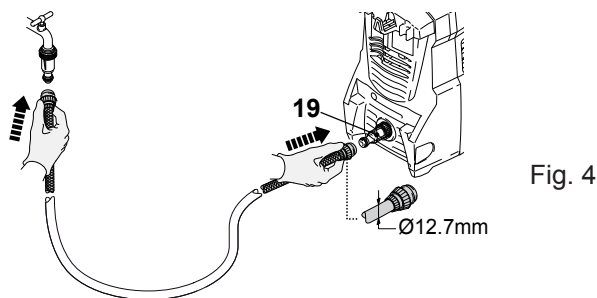

**NOTE:** There is a filter in the connector (19) that protects the product against larger particles. Please ensure that this is fixed appropriately. Do not use the connector without the filter

## Assembly

### Pressure hose and spray gun

1. Push the latch (8c) on the spray gun (8) to open the connecting port and insert the connector of the high pressure hose (16) (Fig. 5)
2. Release the latch (8c) to lock the hose (16) in place.  
Check the connection by pulling on the hose. It should not pull out.

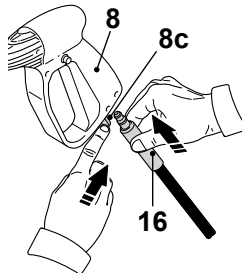

Fig. 5

### High pressure hose

1. Connect the high pressure hose (16) to the water outlet (6) (Fig. 6).
2. Check the connection by pulling on the hose. It should not pull out.

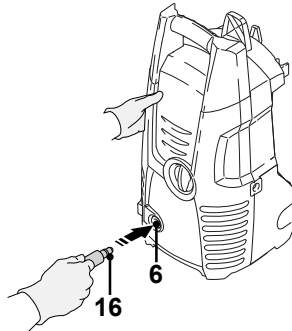

Fig. 6

## Accessories

A choice of lances and accessories are supplied with this product. Please check the technical specification of any accessories that you purchase to ensure they are compatible with this product.

### Attaching

1. Select the suitable accessory, align the tongues with the grooves of the connecting port (8a) and insert it.



**NOTE:** There is a spring in the connecting port of the spray gun (8). This has to be pressed down and may require some pressure.





2. Securely fit the accessory by turning it clockwise to lock it in place (Fig. 7).

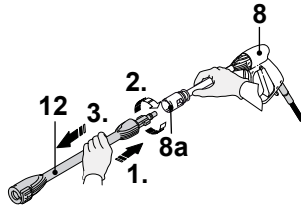

Fig. 7

Fig. 7, attachment method shown with extension lance (12)

**Removing**

Press the accessory towards the spray gun (8) and turn it anti-clockwise to remove it (Fig. 8).

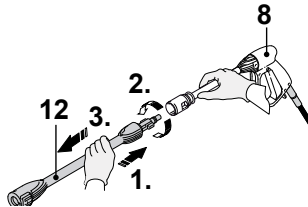
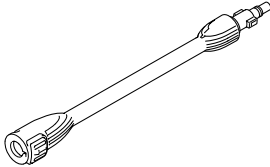
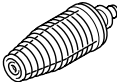
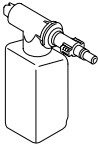
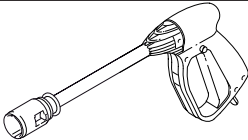

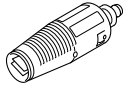

Fig. 8

Illustration	Description	Application
	Extension lance (12)	Extension to be used in conjunction with the spray gun and nozzle.
	Rotary nozzle (17)	To be used for high pressure cleaning in conjunction with the extension lance.
	Soap tank (15)	Low pressure setting to apply detergent. To be used in conjunction with the spray gun.
	Spray gun (8)	To be used in conjunction with extension lance



## Accessories

	High pressure hose (16)	To be used in conjunction with spray gun.
	Vario nozzle (18)	Fan and pin jet to be used in conjunction with the extension lance.

### Rotary nozzle

The high pressure rotary nozzle is intended for maximum cleaning effect. Keep the spray wand 15-20 cm away from the surface being cleaned at all times.

1. Always attach the extension lance (12) when using the rotary nozzle (17) (Fig. 9).



**WARNING!** Never use the rotary nozzle without extension lance - danger of injury!

2. Press the unlock button (12a) and attach the rotary nozzle (17) to the extension lance (12). Release the button (12a) to secure the nozzle in place (Fig. 10).
3. Check if the rotary nozzle (17) is attached properly by pulling on it. It should not pull out.

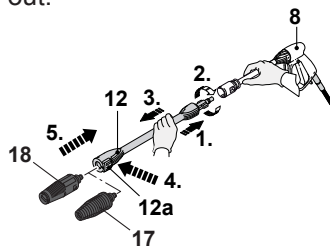

Fig. 9

### Vario nozzle

The vario nozzle is intended for a large choice of applications and cleaning effects.

1. Always use the vario nozzle (18) with the extension lance (12) attached (Fig. 9).
2. Turn the vario nozzle to adjust the water jet according to the surface to be cleaned (Fig. 10).
3. Use the fan spray to clean wood decks, siding, vehicles etc.
4. Always start using the fan spray and begin spraying from a minimum 30 cm away to avoid damaging the surface of the material being cleaned.
5. Use the pin spray for maximum cleaning effect.

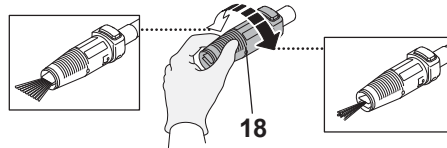

Fig. 10

### Soap tank

Use the soap tank (15) to apply detergent. Some cleaning tasks can be completed with water alone, but for most tasks the removal of dirt becomes more effective if a detergent is used.

1. Remove the detergent sprayer (15a) from tank (15b) by turning it counterclockwise.
2. Add detergent to the tank (15b).
3. Assemble the tank (15b) with detergent sprayer (15a).
4. Securely fit the soap tank into the port connection (8a) of spray gun (8) by turning it clockwise to lock it in place (Fig. 11).

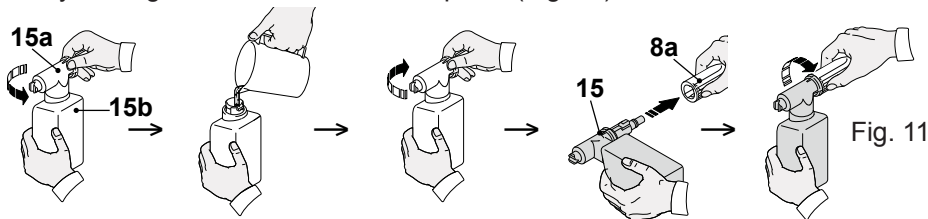

Fig. 11



**NOTE:** Only use mild, environmentally friendly detergents. Never use aggressive chemicals, abrasive detergents or similar to avoid damage to your health, the product and the environment.



**WARNING!** Avoid skin contact with detergents, in particular contact with eyes! If detergent gets in your eyes, flush your eyes with clean water and seek immediate medical attention!

## Connection to the water supply



**WARNING!** Although this product is suitable for attachment to the drinking water supply local regulations may prohibit the connection to drinking water connections!



Observe the regulations of your local utility company when connecting the product to a water supply line! If it is prohibited to connect to the drinking water facility, you must use a backflow preventor which corresponds to EN 12729 type BA. Make sure that the hose is at least a diameter of 12.7 mm (1/2") and is reinforced!



## Connection to the water supply



If your water supply is potable water, ensure that the pressure washer is connected to a non-return valve system (type BA). A Type BA system prevents the contamination of drinking water and must be connected to the water tap output. The check valve is sold separately in stores.

Attach a suitable water hose to the water supply and then attach the other end to the water hose inlet connector (19) of the product (Fig. 12).

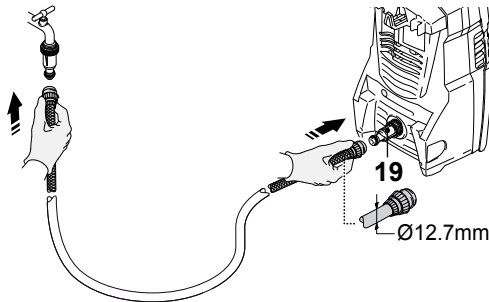

Fig. 12

## Connection to the power supply

1. Make sure the on/off switch (5) is in its off position.
2. Connect the plug (4) with a suitable socket.



**WARNING!** Check the voltage! The voltage must comply with the information on the rating label!

If using an extension cord it must be suitable for outdoor use with sockets protected against water splashing. Ensure the extension cord is of the proper size and type for your product ( $\geq 1.5 \text{ mm}^2$ )! Always use a residual current device (RCD) protected supply.

Your product is now ready to be used.



# In more detail...



In more detail...

<b>Product functions</b>	22
<b>Operation</b>	25
<b>Care and maintenance</b>	30
<b>Troubleshooting</b>	35
<b>Recycling and disposal</b>	37
<b>Guarantee</b>	37
<b>EC declaration of conformity</b>	38

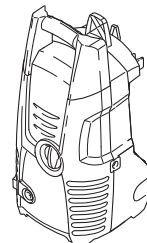

## Intended use

This high pressure washer TTB1300PRW is designated with a rated input of 1300 Watts.

The intended use of this product covers cleaning the surfaces of domestic vehicles, buildings and patios using clean water and biodegradable chemical detergents.

1. This product must not be used to clean clothing, shoes and other textiles. The water jet should not be directed or held against anyone, any animals or electrical equipment including the product itself. Do not flush any objects or pipe work which contains materials or liquids hazardous to health e.g. chemicals or asbestos. The product must not be run with inflammable, explosive or toxic liquids.
2. The use of non-original accessories or any other accessories not specially intended for the model in question is prohibited.
3. This product is intended for private domestic use only, not for any commercial trade use. It must not be used for any purposes other than those described.

## Safety devices

This product is equipped with several safety devices to avoid damage and injuries.

### Overload cut-out

In case of overload, the motor stops. In this case, switch the product off, remove the mains plug and let it cool down for 10 minutes, then repeat the startup.

1. Turn on the water tap fully.
2. Turn the On/Off switch (5) to "I" (on).
3. Hold the spray gun (8) with both hands.
4. Direct the nozzle of the chosen attachment away from yourself towards the surface.
5. Press the trigger (8d) and direct the water jet to the object to be washed.
6. Release the trigger (8d) to stop the water jet.

If the problem recurs more than once, contact your authorised service centre.



Fig. 13

### Trigger lock

The spray gun (8) is equipped with a trigger lock in order to prevent accidental activation of the trigger (8d).

1. Activate the trigger lock by pressing the activate button (8b) when the product is not in use, when it is left unattended or when setting the product down (Fig. 14).
2. Deactivate the trigger lock by pressing the deactivate button (8b) to start operation (Fig. 15).

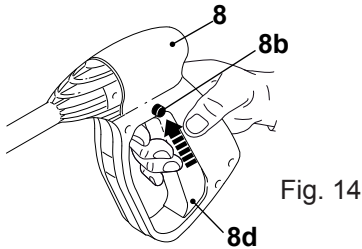

Fig.14, trigger lock activated, the trigger is locked in the off position

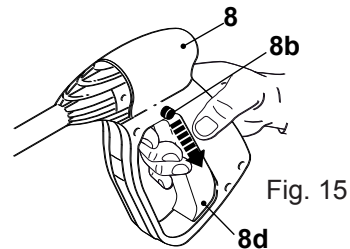

Fig.15, trigger lock deactivated, the trigger can be operated

### Safety valve

The safety valve is a pressure limiting valve. When the trigger (8d) is released, the valve opens and discharges the pressure inside the pump.

### Automatic motor start-stop device

Automatic motor start-stop device is operated by the trigger (8d) of the spray gun (8). When the trigger (8d) is released the dynamic pressure automatically cuts out the motor. When the trigger (8d) is depressed the automatic drop in pressure starts the motor and the pressure is restored after a very slight delay.



If the automatic motor start-stop device is to function correctly all trigger releasing and depressing operations must be performed with an interval of at least 5 seconds between each operation

In more detail...

## On/off switch

1. Make sure the on/off switch (5) is on "O"(off) (Fig. 16).
2. insert the plug (4) into a properly installed socket.
3. Turn the on/off switch (5) to "I" (on) (Fig. 17).

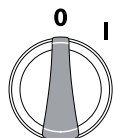

Fig. 16

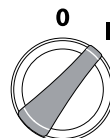

Fig. 17



**Note:** The spray gun (8) is equipped with a trigger lock in order to prevent accidental activation of the trigger (8d). Activate the trigger lock when the product is not in use, when it is left unattended or when setting the product down (Fig. 14).

4. Deactivate the trigger lock by pressing the deactivate button (8b) (Fig. 18).
5. Press the trigger (8d), a water jet sprays out of the nozzle.
6. Release the trigger (8d) to stop the water outlet.

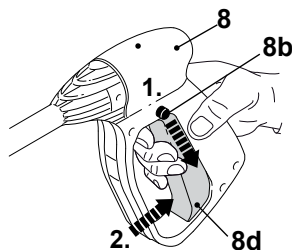

Fig. 18

7. Activate the trigger lock pressing the activate button (8b) to lock the trigger in its off-position.
8. Turn the on/off switch (5) to "O".





## General operation

1. Check the product, its power cord and plug as well as accessories for damage before each use. Do not use the product if it is damaged or shows wear.
2. Double check that accessories are properly fixed.
3. Always hold the product by the spray gun and lance. Keep the surfaces dry to ensure safe support.
4. Ensure that the air vents are always unobstructed and clear. Clean them if necessary.
5. Switch the product off immediately if you are disturbed while working by other people entering the working area. Always let the product come to complete stop before putting it down.
6. Do not overwork yourself. Take regular breaks to ensure you can concentrate on the work and have full control over the product.

## operation



**WARNING!** Do not operate the product when the ambient temperature is below 0°C. Water will freeze inside the product and damage it.



**WARNING!** Do not operate the product with a closed water tap! This leads to dry running and damage to the product! Rebound forces result from pressing the trigger! Therefore, always hold the spray gun with both hands! Pay attention to safe posture! Improper handling can lead to injuries!

1. Assemble the product as described.
2. Turn on the water tap fully.
3. Turn the On/Off switch (5) to "I".
4. Hold the spray gun (8) with both hands.
5. Direct the nozzle of the chosen attachment away from yourself towards the surface to be cleaned (Fig. 19).
6. Press the trigger (8d) and direct the water jet to the object to be washed.

In more detail...

## operation



Fig. 19



**NOTE:** Always keep a reasonable distance between the nozzle and the object to be washed in order to avoid damage.

7. Release the trigger (8d) to stop the water jet.

## Tips



**WARNING!** Prevent water from penetrating the air vents of the product to minimize the risk of damage to the product and to reduce the risk of electric shock to the operator!

1. Dissolve dirt by first applying a detergent mixed with water to the surface while still dry. Allow the detergent to soak into the surface for a few minutes, but do not let the detergent dry.
2. When dealing with vertical surfaces work from the bottom upwards. Leave the detergent to act for 1-2 minute(s) but do not allow the surface to dry. Starting from the bottom, use the high pressure jet at a minimum distance of 30 cm. Do not allow the rinse water to run onto unwashed surfaces.
3. In some cases, scrubbing the surface with a suitable brush is needed to remove dirt. High pressure cleaning is not always the best solution for good washing results, since it may damage some surfaces. The dirtblaster nozzle adjustable nozzle jet setting should not be used on delicate or painted parts, or on pressurised components (e.g. tyres, inflation valves, etc.).
4. Effective washing depends on both the pressure and volume of the water used, to the same degree.
5. Begin by spraying in a test area free and clear of people and objects.



### Wood and vinyl decks

1. Reduce your work area to smaller sections and clean each section one at a time for optimal results.
2. Rinse at high pressure using the fan spray keeping the tip of the spray nozzle at least 15 - 25 cm from the cleaning surface.
3. Maintain a further distance from the cleaning area when using a direct spray.
4. **Caution!** Increase the distance from the cleaning area for softer woods.

### Cement patios, stone, and brick

1. Rinse at high pressure using the fan spray in a sweeping motion keeping the tip of the spray nozzle at least 7-15 cm from the cleaning surface.
2. Maintain a further distance from the cleaning area when using a direct spray.

### Cars, boats, and motorcycles

1. Clean one side at a time to achieve the best results.
2. Rinse at high pressure using the fan spray in a sweeping motion keeping the tip of the spray nozzle at least 20 cm from the cleaning surface. Maintain a further distance from the cleaning area when using a direct spray.
3. Wipe surface dry for a polished finish.
4. **WARNING!** Never clean the engine with this product!

## After use

1. Release the trigger (8d) (Fig. 20).

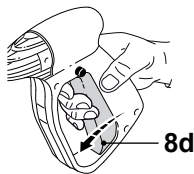

Fig. 20

2. Turn the on/off switch (5) to "O" (off).
3. Turn off the water tap.
4. Press the trigger (8d) to release the pressure still present in the product (Fig. 21).
5. Lock the trigger (8d) by pressing the activate button (8b) (Fig. 22).



## After use

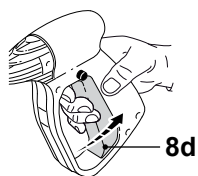

Fig. 21

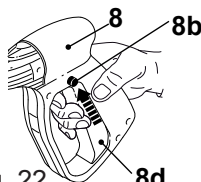

Fig. 22



**WARNING!** Only separate the high-pressure hose from the spray gun and the water hose from the product when no more pressure exists in the system! Also ensure that the product is turned off and separated from electrical supply!

6. Disconnect from the power supply.
7. Separate the water hose from the water supply. (Fig. 23)

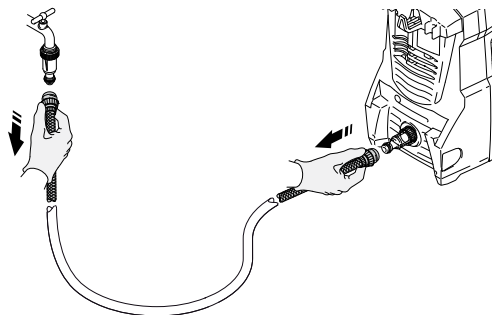

Fig. 23

8. Press the unlock button (12a) and disconnect the rotary nozzle (17) or vario nozzle (18) from the extension lance (12) (Fig. 24).

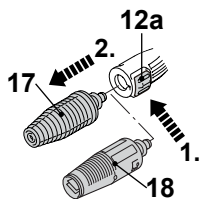
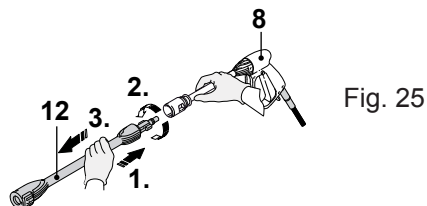

Fig. 24



9. Press the extension lance (12) towards the spray gun (8) and turn it anti-clockwise to remove it (Fig. 25).



10. Push the high pressure hose release button (2) and disconnect the high pressure hose (16) from the water outlet (6) by pulling it out (Fig. 26).

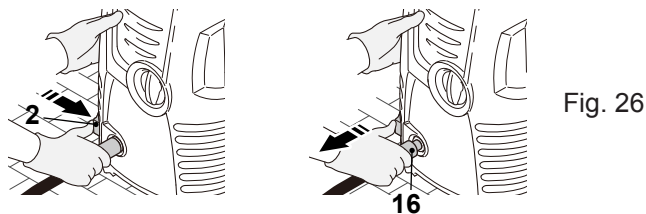

11. Push the latch (8c) on the spray gun (8) to open the connecting port and disconnect the high pressure hose (16) by pulling it out (Fig. 27).

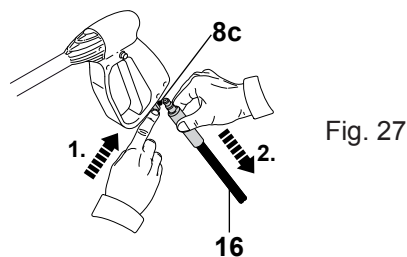

12. Check, clean and store the product as described below.



## The golden rules for care



**WARNING!** Always switch the product off, disconnect it from power supply and let the product cool down before performing inspection, maintenance and cleaning work!



1. Keep the product clean. Remove debris from it after each use and before storage.
2. Regular and proper cleaning will help ensure safe use and prolong the life of the product.
3. Inspect the product before each use for worn and damaged parts. Do not operate it if you find broken and worn parts.



**WARNING!** Only perform repairs and maintenance work according to these instructions! All further works must be performed by a qualified specialist!

## General cleaning

1. Clean the product with a dry cloth. Use a brush for areas that are hard to reach.
2. In particular clean the air vents after every use with a cloth and brush.
3. Remove stubborn dirt with high pressure air (max. 3 bar).



**NOTE:** Always keep a reasonable distance between the nozzle and the object to be washed in order to avoid damage.

4. Check for worn or damaged parts. Replace worn parts as necessary or contact an authorised service centre for repair before using the product again.

## General operation

A cleaning needle (20) is supplied with this product and stored on the back page of instruction manual.

## Nozzle

Remove any dirt deposits from the nozzle (17/18) hole using the cleaning needle (20) (Fig. 28).

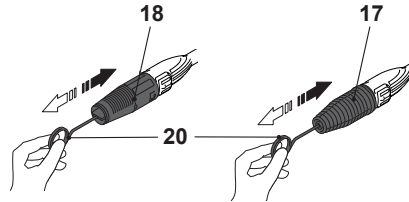

Fig. 28 (Rotary nozzle and Vario nozzle)

## Filter

1. Remove the water inlet hose connector (19) from the water inlet (14).
2. Use a damp tool to disassemble the water inlet hose connector (19) (Fig. 29).
3. Rinse the parts with clear water (Fig. 30).

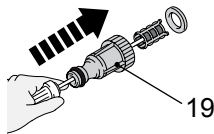

Fig. 29

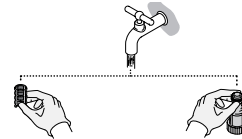

Fig. 30

## Decalcification

From time to time, according to the hardness of your tap water, calcium deposits in the product and accessories. The strength of the deposits (and thus the frequency of decalcification) depends upon the degree of hardness of the water and how often the product is used. Check with your local water company in order to establish the hardness of the water in your area.



**NOTE:** Use a mixture of water and citric acid or vinegar for decalcification. These substances are readily biodegradable and environmentally friendly!

1. Make a mixture of one part vinegar and two parts hot water ( $\leq 50\text{ }^{\circ}\text{C}$ ) in a suitable container e.g. in a bowl.
2. Lay the container e.g. accessory parts in the mixture.
3. Leave the parts in the mixture for approximately 12 hours.
4. Then rinse the parts with clear water.

In more detail...



## Power cord

If the power cord is damaged, it must be replaced by the manufacturer, its service agent or similarly qualified persons in order to avoid a safety hazard.

## UK plug

If you need to replace the fitted plug, then follow the instructions below.

**IMPORTANT:** The wires in the mains lead are coloured in accordance with the following code:

Blue – Neutral Brown – Live

As the colours of the wire in the mains lead of this product may not correspond with the coloured marking identifying the terminals in your plug, proceed as follows. The wire, which is coloured blue, must be connected to the terminal, which is marked with N or coloured black. The wire, which is coloured brown, must be connected to the terminal, which is marked **L** or coloured red.

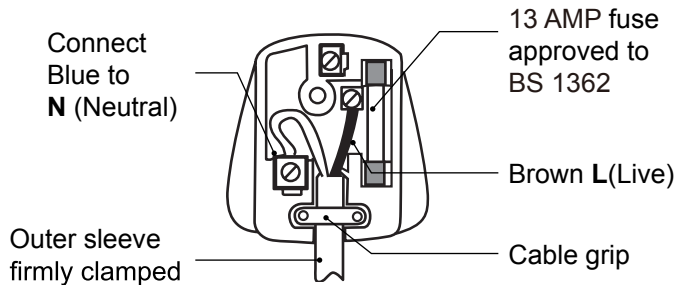

**WARNING!** Never connect live or neutral wires to the earth terminal of the plug.

Only fit an approved 13 Amp BS 1363 or 1363/A plug and the correctly rated fuse. If in doubt, consult a qualified electrician.



**NOTE:** If a moulded plug is fitted and has to be removed take great care in disposing of the plug and severed cable, it must be destroyed to prevent engaging into a socket.





## Repair

This product does not contain any parts that can be repaired by the consumer. Contact a qualified specialist to have it checked and repaired.

## Storage

1. Clean the product as described above.
2. Store the product and its accessories in a dry, frost-free place.
3. Always store the product in a place that is inaccessible to children. The ideal storage temperature is between 10 and 30 °C.
4. We recommend using the original package for storage or covering the product with a suitable cloth or enclosure to protect it against dust.
5. Drain remaining water and wash out the detergent tank at the end of the working session. To wash out the tank, use clean water instead of the detergent.
6. Store the accessories on the back and in the storage compartment of the product (Fig. 31).

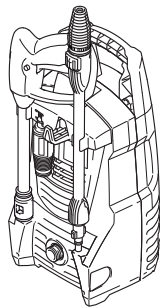

Fig. 31

In more detail...

## Transportation

1. Switch the product off and disconnect it from water and power supply before transporting it anywhere.
2. Attach transportation guards, if applicable.
3. Always transport the product by its handle (1) (Fig. 32).

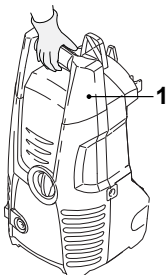

Fig. 32

4. Protect the product from any heavy impact or strong vibrations which may occur during transportation in vehicles.
5. Secure the product to prevent it from slipping or falling over.

## Troubleshooting

Suspected malfunctions are often due to causes that the users can fix themselves. Therefore check the product using this section. In most cases the problem can be solved quickly.



**WARNING!** Only perform the steps described within these instructions! All further inspection, maintenance and repair work must be performed by an authorised service centre or a similarly qualified specialist if you cannot solve the problem yourself!

Problem	Possible cause	Solution
1. Product does not start	1.1. Not connected to power supply 1.2. Power cord or plug is defective 1.3. Other electrical defect to the product 1.4. Trigger lock has not been deactivated 1.5. Nozzle clogged	1.1. Connect to power supply 1.2. Contact your nearest authorised service centre 1.3. Contact your nearest authorised service centre 1.4. Unlock the trigger 1.5. Clean the nozzle
2. Product does not reach full power	2.1. Extension cord not suitable for operation with this product 2.2. Power source (e.g. generator) has too low voltage 2.3. Air vents are blocked 2.4. Water inlet volume is too low 2.5. High-pressure hose is leaking 2.6. Seals worn 2.7. Intake filter dirty 2.8. Air being sucked into the system	2.1. Use a proper extension cord 2.2. Connect to another power source 2.3. Clean the air vents 2.4. Increase water inlet quantity 2.5. Replace high-pressure hose 2.6. Contact your nearest authorised service centre 2.7. Clean the filter 2.8. Check tightness of hose fittings
3. Oil leak	3.1. Seals worn	3.1. Contact your nearest authorised service centre

In more detail...

## Troubleshooting

Problem	Possible cause	Solution
4. Strong pressure fluctuations	4.1. Nozzle clogged 4.2. Water inlet volume is too low 4.3. High-pressure hose is leaking 4.4. Seals worn  4.5. Intake filter dirty 4.6. Air being sucked into the system	4.1. Clean the nozzle 4.2. Increase water inlet quantity 4.3. Replace high-pressure hose 4.4. Contact our nearest authorised service centre 4.5. Clean the filter 4.6. Check thickness of hose fittings
5. Water leakage from product	5.1. Seals worn	5.1. Contact your nearest authorised service centre
6. Excessive vibration/noise	6.1. Screws and nuts loosened  6.2. Motor problems  6.3. Water inlet volume is too low	6.1. Check screws and nuts for tightness and retighten as necessary 6.2. Contact your nearest authorised service centre 6.3. Increase water inlet quantity
7. No detergent taken in	7.1. Soap tank not attached 7.2. Detergent too dense 7.3. Deposits or restriction in detergent circuit	7.1. Attach the soap tank 7.2. Dilute with water 7.3. Flush with clean water and eliminate any restrictions. If the problem persists, contact an authorised service centre
8. No water jet	8.1. Trigger is not squeezed 8.2. Trigger lock is activated  8.3. No water supply 8.4. Filter is dirty 8.5. Hose blocked 8.6. Nozzle blocked	8.1. Squeeze the trigger 8.2. Deactivate the trigger lock 8.3. Check water supply 8.4. Clean filter 8.5. Check hose 8.6. Check nozzle



## Recycling and disposal



Waste electrical products should not be disposed of with household waste. Please recycle where facilities exist.

Check with your Local Authority or local store for recycling advice.



The product comes in a package that protects it against damage during shipping. Keep the package until you are sure that all parts have been delivered and the product is working properly. Recycle the package afterwards.

## Guarantee

This product carries a guarantee of 24 months starting from the day of purchase. Please retain your receipt as a proof.

This guarantee specifically excludes losses due to:

- Normal wear and tear, including accessory wear
- Overload, misuse or neglect
- Failure of consumable items (such as batteries)
- Repairs attempted by anyone other than an authorized agent
- Accidental damage caused by foreign objects or substances
- Lack of routine maintenance
- Failure to follow manufacturer's guidelines
- Loss of use of the goods

Due to continuous product improvement, we reserve the right to change the product specification without prior notice.

This guarantee does not affect your statutory rights.

For any inquiries relating to the guarantee please contact your retailer: If you purchased this product in B&Q store or website then call 0333 0143101. If you bought this product in SFX outlet or website then call 03330 112 112.

In more detail...



(EN) EU DECLARATION OF CONFORMITY  
 (FR) DÉCLARATION UE DE CONFORMITÉ  
 (PL) DEKLARACJA ZGODNOŚCI UE  
 (RO) DECLARAȚIA DE CONFORMITATE UE  
 (DE) EU-KONFORMITÄTSEKTLÄRUNG  
 (ES) DECLARACIÓN UE DE CONFORMIDAD  
 (PT) DECLARAÇÃO DE CONFORMIDADE UE

Product/ Produit/ Produkt/Produsul/Produkt/Producto/Produto

- Product name – High Pressure Washer/ Nettoyeur haute pression/ Myjka ciśnieniowa/ Aparat de spălat cu înaltă presiune/ Hochdruckreiniger/ Hidrolimpiadora de alta presión/ Lavadora a alta pressão
- Product model – TTB1300PRW
- Type / batch or serial number range 000001 to 999999

Name and address of the manufacturer or his authorised representative:

Nom et adresse du fabricant ou de son mandataire:  
 Nazwa i adres producenta lub jego upoważnionego przedstawiciela:  
 Denumirea și adresa producătorului sau a reprezentantului său autorizat:  
 Name und Anschrift des Herstellers oder seines Bevollmächtigten:  
 Nombre y dirección del fabricante o de su representante autorizado:  
 Nome e endereço do fabricante ou do respetivo mandatário:

Kingfisher International Products B.V.,  
 Rapenburgerstraat 175E,  
 1011 VM Amsterdam,  
 The Netherlands

This declaration of conformity is issued under the sole responsibility of the manufacturer.  
 La présente déclaration de conformité est établie sous la seule responsabilité du fabricant.  
 Niniejsza deklaracja zgodności wydana zostaje na wyłączną odpowiedzialność producenta.  
 Prezenta declarație de conformitate este emisă pe răspunderea exclusivă a producătorului.  
 Die alleinige Verantwortung für die Ausstellung dieser Konformitätserklärung trägt der Hersteller.  
 La presente declaración de conformidad se expide bajo la exclusiva responsabilidad del fabricante.  
 A presente declaração de conformidade é emitida sob a exclusiva responsabilidade do fabricante.

Object of the declaration/Objet de la declaration/Przedmiot deklaracji/Obiectul declarației/Gegenstand der Erklärung/Objeto de la declaración/Objeto da declaração

Product/Produit/Produkt/Produsul/Produkt/Producto/ Produto	Model/Modèle/Model/Modelul/Model/Modelo/ Modelo	EAN
High Pressure Washer/ Nettoyeur haute pression/ Myjka ciśnieniowa/ Aparat de spălat cu înaltă presiune/ Hochdruckreiniger/ Hidrolimpiadora de alta presión/ Lavadora a alta pressão	TTB1300PRW	5059340124117

The object of the declaration described above is in conformity with the relevant Union harmonisation legislation:  
 L'objet de la déclaration décrit ci-dessus est conforme à la législation d'harmonisation de l'Union applicable:  
 Wymieniony powyżej przedmiot niniejszej deklaracji jest zgodny z odpowiednimi wymaganiami unijnego prawodawstwa harmonizacyjnego:  
 Obiectul declarației descris mai sus este în conformitate cu legislația relevantă de armonizare a Uniunii:  
 Der oben beschriebene Gegenstand der Erklärung erfüllt die einschlägigen Harmonisierungsrechtsvorschriften der Union:  
 El objeto de la declaración descrita anteriormente es conforme con la legislación de armonización pertinente de la Unión:  
 O objeto da declaração acima descrito está em conformidade com a legislação de harmonização da União aplicável:

2006/42/EC	Machinery Directive
2014/30/EU	Directive Electromagnetic compatibility
2000/14/EC	Outdoor Noise Directive
2011/65/EU,(EU) 2015/863	Directive Restriction of the use of certain hazardous substances in electrical and electronic equipment
2006/42/CE en tant que directive modifiée sur les machines	
2014/30 / UE telle que modifiée Directive Compatibilit�� �lectromagn��tique	
2000/14/CE en tant que directive modifi��e sur le bruit ext��rieur	
Directive 2011/65 / UE,(UE) 2015/863 telle que modifi��e Limitation de l'utilisation de certaines substances dangereuses dans les �quipements �lectriques et �lectroniques	
006/42/WE w zmiennej dyrektywie maszynowej	
2014/30 / UE ze zmianami Dyrektywa Kompatybilno�� elektromagnetyczna	
2000/14/WE w zmiennej dyrektywie w sprawie ha�asu na zewn��trz	
2011/65 / UE,(UE) 2015/863 ze zmianami Dyrektywa Ograniczenie stosowania niekt��rych niebezpiecznych substancji w sprz�cie elektrycznym i elektronicznym	
2006/42/CE, astfel a fost modificat� Directiva privind echipamentele	
2014/30/UE, astfel a fost modificat� Directiva privind compatibilitatea electromagnetic�	





2000/14/CE, astfel a fost modificată Directiva privind zgomotul în aer liber  
 2011/65/UE, (UE) 2015/863 astfel a fost modificată Directiva privind limitarea utilizării anumitor substanțe periculoase în echipamentele electrice și electronice  
 2006/42/EG als geänderte Maschinenrichtlinie  
 2014/30/EU in der geänderten Richtlinie Elektromagnetische Verträglichkeit  
 2000/14/EG in der geänderten Richtlinie über Lärmimflug im Freien  
 2011/65/EU, (EU) 2015/863 als geänderte Richtlinie Beschränkung der Verwendung bestimmter gefährlicher Stoffe in Elektro- und Elektronikgeräten  
 Directiva sobre maquinaria modificada 2006/42/CE  
 2014/30/UE modificada Directiva Compatibilidad electromagnética  
 2000/14/CE modificada Directiva sobre ruido al aire libre  
 2011/65/UE, (UE) 2015/863 modificada Directiva Restricción del uso de determinadas sustancias peligrosas en equipos eléctricos y electrónicos

Measured Sound Power Level	Guaranteed Sound Power Level
Le niveau de puissance acoustique mesuré	Le niveau de puissance acoustique garant
Zmierzony poziom mocy akustycznej	Gwarantowany poziom mocy akustycznej
Nivel de putere acustică măsurat	Nivel de putere acustică garantat
Gemessener Schallleistungspegel	Garantierter Schallleistungspegel
Nivel de potencia sonora medido	Nivel de potencia sonora garantizado
Nível de potência sonora medido	Nível de potência sonora garantido
: 80.9 dB(A)	: 83 dB(A)

References to the relevant harmonised standards used or references to the other technical specifications in relation to which conformity is declared:

Références des normes harmonisées pertinentes appliquées, y compris la date de celles-ci, ou des autres spécifications techniques, y compris la date de celles-ci, par rapport auxquelles la conformité est déclarée:  
 Odwołania do odnośnych norm zharmonizowanych, które zastosowano, wraz z datą normy, lub do innych specyfikacji technicznych, wraz z datą specyfikacji, w odniesieniu do których deklarowana jest zgodność:  
 Trimiteri la standardele armonizate relevante folosite, inclusiv data standardului, sau trimiteri la celelalte specificații tehnice, inclusiv data specificațiilor, în legătură cu care se declară conformitatea:  
 Angabe der einschlägigen harmonisierten Normen, die zugrunde gelegt wurden, oder Angabe der anderen technischen Spezifikationen, in Bezug auf die die Konformität erklärt wird:  
 Referencias a las normas armonizadas pertinentes utilizadas, incluidas las fechas de las normas, o referencias a las otras especificaciones técnicas, incluidas las fechas de las especificaciones, respecto a las cuales se declara la conformidad:  
 Referências às normas harmonizadas aplicáveis utilizadas, incluindo a data da norma, ou às outras especificações técnicas, incluindo a data da especificação, em relação às quais é declarada a conformidade:

EN 60335-1:2012/A14:2019	EN 55014-1:2017
EN 60335-2-79:2012	EN 55014-2:2015
EN 62233:2008	EN 61000-3-2:2014
EN 60704-1:2012	EN 61000-3-3:2013
EN ISO 3744:2010	

Where applicable, the notified body TUV SUD Product Service GmbH;Munich Germany performed MD/EMC and issued the certificate: M8A 018081 0741/ E8A 018081 0753  
 Le cas échéant, l'organisme notifié TUV SUD Product Service GmbH;Munich Germany a effectué MD/EMC et a établi le certificate: M8A 018081 0741/ E8A 018081 0753  
 W stosownych przypadkach jednostka notyfikowana TUV SUD Product Service GmbH;Munich Germany przeprowadziła MD/EMC i wydała certyfikat: M8A 018081 0741/ E8A 018081 0753  
 După caz, organismul notificat TUV SUD Product Service GmbH;Munich Germany a efectuat MD/EMC și a emis certificatul: M8A 018081 0741/ E8A 018081 0753  
 Falls zutreffend — Die notifizierte Stelle TUV SUD Product Service GmbH;Munich Germany hat MD/EMC ... und folgende EU-Baumusterprüfbescheinigung ausgestellt: M8A 018081 0741/ E8A 018081 0753  
 Si procede, el organismo notificado TUV SUD Product Service GmbH;Munich Germany ha efectuado MD/EMC y expide el certificado: M8A 018081 0741/ E8A 018081 0753  
 Se for esse o caso, o organismo notificado: TUV SUD Product Service GmbH;Munich Germany efetuou MD/EMC e emitiu o certificado: M8A 018081 0741/ E8A 018081 0753

Signed for and on behalf of/Signé par et au nom de/ Podpisano w imieniu/Semnăt pentru și în numele/Unterzeichnet für und im Namen von/ Firmado en nombre de/Assinado por e em nome de:

Kingfisher International Products B.V.,  
 Rapenburgerstraat 175E,  
 1011 VM Amsterdam,  
 The Netherlands

David Awe  
 Group Quality & Sustainability Director

: 28-06-2020





Manufacturer, Fabricant, Producent,  
Producător, Fabricante:

UK Manufacturer:  
Kingfisher International Products Limited  
3 Sheldon Square  
London  
W2 6PX  
United Kingdom

EU Manufacturer:  
Kingfisher International Products B.V.  
Rapenburgerstraat 175E  
1011 VM Amsterdam  
The Netherlands

---

**EN** [www.diy.com](http://www.diy.com)  
[www.screwfix.com](http://www.screwfix.com)  
[www.screwfix.ie](http://www.screwfix.ie)

To view instruction manuals online,  
visit [www.kingfisher.com/products](http://www.kingfisher.com/products)

---

