



pysen
optics

counting chambers

counting chambers



counting chambers

As well as an extensive selection of specialist chambers for Haemocytometry, Parasitology and Cytology. The range includes:- Pyser Optics Counting Chambers.

The Pyser Optics grid-marked Sedgewick Rafter counting chamber. Available in both plastic and durable glass versions, excellent for determining counts in known volumes of sample even using zoom stereo microscopes.

The Pyser Optics Howard Cell for spore counting in tomato and fruit juice.
The MAKLER Semen Counting Chamber.

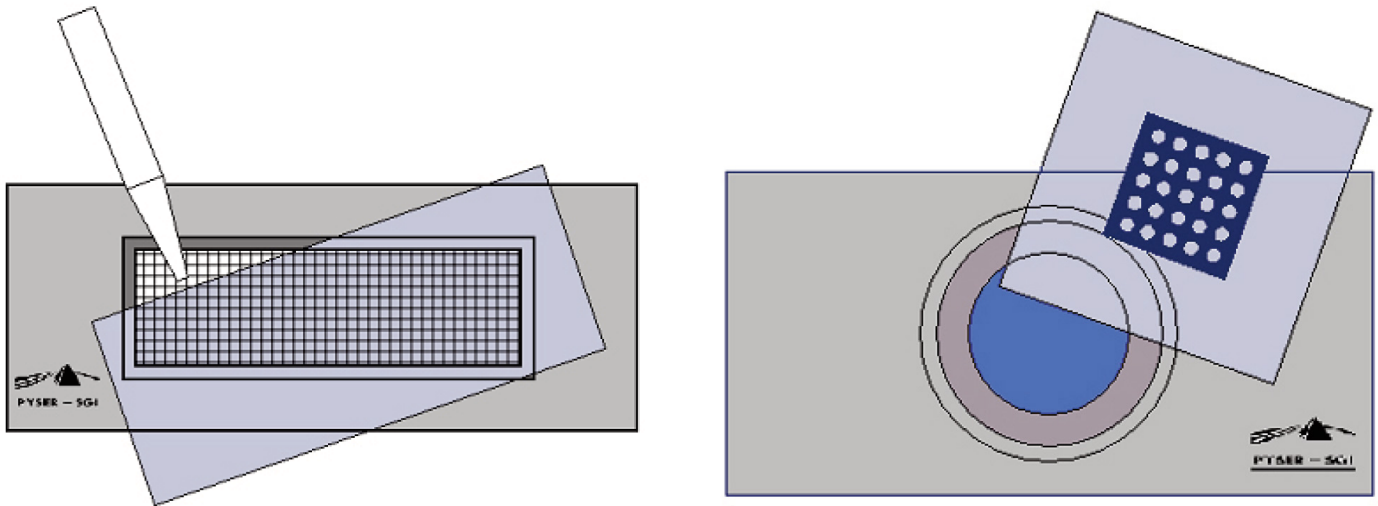

sedgewick rafter cell

The Pyser Optics S50 & S52 Sedgewick Rafter counting cells are used widely in water analysis, culture inspection and for other applications where particles per unit volume in fluid must be determined.

Pyser Optics's Sedgewick-Rafters are available in glass and plastic versions. The glass cell is designed for repeated cleaning and re-use, whereas the plastic version is designed for either a single or finite use only. Each chamber is supplied with one type S51 cover glass.

The Sedgewick-Rafter Chambers consists of a 2mm thick clear base slide (76 x 40 mm), onto which has been built a rectangular chamber. On to the top of this chamber is placed a cover slip.

This chamber is 50mm long x 20mm wide and 1mm deep and its base is marked with a grid of one thousand 1mm squares. When filled with liquid and with a cover glass placed over the chamber, a 1ml volume of liquid is trapped.

When used under a low magnification light microscope, each of the grid squares equates to 1 microlitre (μl) of liquid.

sedgewick rafter cell

S50 - plastic sedgewick rafter counting chamber

| pattern | description | order code |
|---------|---|------------|
| S50 | Sedgewick Rafter Counting Chamber [plastic] Includes 1 cover glass | 02C00415 |

key features

Plastic - economically priced cell

description

An economically priced cell, for one time (or possibly several time) use and for educational/training exercises.

Generally we do not recommend the S50 plastic version for the professional user. The softness of the plastic means it is easily scratched and otherwise damaged. However most laboratories who do use the plastic version see it more as a "throw away" or consumable, which may best suit certain applications.



S52 - glass sedgewick rafter counting chamber

| pattern | description | order code |
|---------|---|------------|
| S52 | Sedgewick Rafter Counting Chamber [Glass] Includes 1 cover glass | 02B00417 |

key features

Glass - Professional Cell

description

A serious reusable tool for the professional user. The cell is made of high quality optical glass with a chromium surface image. It is intended for continued professional use and whenever using phase contrast.



S51 - spare coverglass for pyser optics sedgewick rafter counting chamber

| pattern | description | order code |
|---------|--|------------|
| S51 | Cover glass for use with both Glass & Plastic Cells | 02C00416 |

key features

For use with both Glass & Plastic Cells

description

Both Pyser Optics Plastic and Glass Sedgewick Rafter Cells are supplied with a cover glass. Additional spare cover glasses are available to order from stock, as this S51.

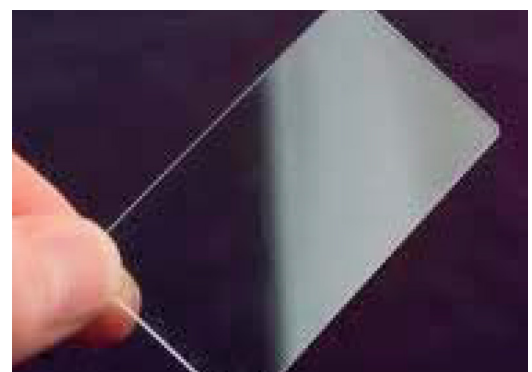

sedgewick-rafter filling method & usage

The cell can be used with either living or preserved material. To fill the cell, place the cover glass across the chamber top (Fig A). This allows the air bubbles to escape during the filling procedure. The sample is then taken into a 1ml wide mouthed pipette and then carefully transferred to the chamber.

Do not overfill the chamber, because the volume of the sample in the chamber must be known exactly and the cover glass must not float free, but held onto the cell walls by surface tension. During counting, water may evaporate from the chamber. To prevent gas bubble formation, a small drop of distilled water may be placed on the slide outside the cell, just touching the cell wall and cover glass. Before the cell count is made the Sedgewick-Rafter chamber should be allowed to stand for at least 15 minutes to allow algae, or other particles, to settle to the bottom.

The Grid Pattern in the base of the chamber assists the counting and calculation process, by clearly defining a known sample volume in 1 μ l blocks Counting in strips is easier, no need to use reticle grids or know the precise area of your field of view.

This makes Pyser Optics's S50 & S52 Gridded Sedgewick-Rafter Cell perfect for use with a Stereo Zoom Microscope without the need to carefully set the precise zoom/magnification before counting the sample.

For precise sample preparation and calculation methods, you should follow your own internal or published procedures.

Filling a Sedgewick-Rafter Chamber

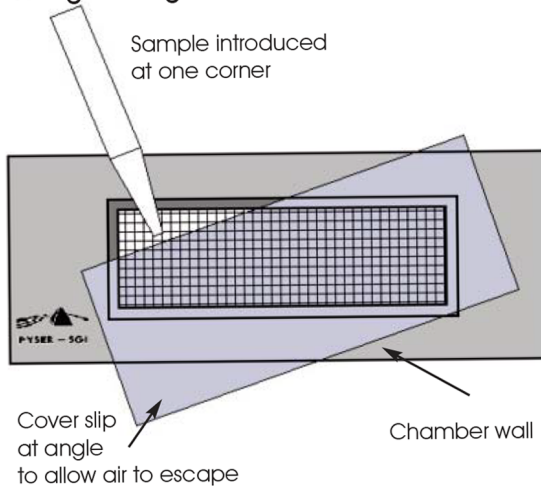

Fig A

cleaning method

To clean the counting chamber: After completing the count, remove the cover glass and clean the counting chamber with water or a mild cleaning solution (10% solution of bleach). Dry the counting chamber with a soft cloth or wipe, or rinse with acetone.

howard mould counting cell

The Pyser Optics S60 Howard Cell and associated K20 Cover Glass, is used world wide for mould counting in food quality control applications, such as tomato products and other fruit based preparations.

Pyser Optics's improved Howard Cell is based on the method originally developed by B.J. Howard in 1911, primarily for the purpose of monitoring tomato products, using a microscope.

The special S60 Howard Cell chamber slide in conjunction with the K20 Cover Glass is designed to count mould mycelia.

The S60 Howard Cell is a glass slide 76mm x 35mm with a central circular island and is used for counting mould fibres and spores in fruit juices especially from tomatoes. With the K20 cover glass in place a 0.1mm thickness of liquid is contained over the central island.

The cover glass has 25 calibrated fields of 1.382mm diameter through which to view the particles.

This cover glass removes the necessity of precise adjustment of the microscope magnification and calibration of a special eyepiece reticle in the original Howard Method, making it suitable for use with a modern zoom stereo microscope as well as a conventional compound microscope.

Note: The complete system requires both the cell itself and cover glass. The cell does not come with a cover glass and one must be ordered separately. We recommend ordering one or two extra cover glasses, this way there is always going to be one in reserve.

S60 - howard cell for fruit juices

| pattern | description | order code |
|---------|------------------------------|------------|
| S60 | Howard Cell for Fruit Juices | 02C00419 |

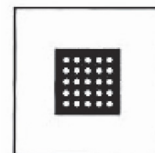
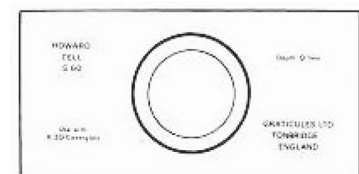

key features

Special Chamber for use with K20 windowed cover slip to count mould fibres and spores

description

The S60 Howard Cell is a glass slide 76mm x 35mm with a central circular island and is used for counting mould fibres and spores in fruit juices especially from tomatoes. With the K20 cover glass in place a 0.1mm thickness of liquid is contained over the central island.

K20 - cover glass for Pyser Optics howard cell

| pattern | description | order code |
|---------|----------------------------|------------|
| K20 | Coverglass for Howard Cell | 02C00420 |

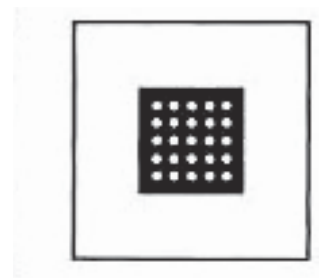

key features

For use with S60 Cell to hold a 0.1mm thickness of liquid for analysis and present known sample volumes for counting

description

When used with the S60 Howard Cell, the K20 cover glass holds in place a 0.1mm thickness of liquid is over the central island for analysis.

The cover glass has 25 calibrated fields of 1.382mm diameter through which to view the particles.

This cover glass removes the necessity of precise adjustment of the microscope magnification and calibration of a special eyepiece reticle in the original Howard Method, making it suitable for use with a modern zoom stereo microscope as well as a conventional compound microscope.

how to use a howard cell - general procedure

The material to be examined should be a pulp. Mix a small quantity with water until the solids of the diluted pulp are between 8.37% and 9.37%. This corresponds to an Abbe refractometer reading at 20°C of 1.3460.

Spread a small drop of the well-mixed sample with the end of a glass rod over the counting chamber.

Place the cover glass on to the counting chamber and carefully press down the shoulder of the chamber until Newton's rings are visible.

Prepared samples containing air bubbles beneath the cover glass or an over-full moat should be discarded.

If using a compound microscope, examine using the X10 eyepiece and the X10 objective.

Howard Mould Counting Cell & Cover Glass

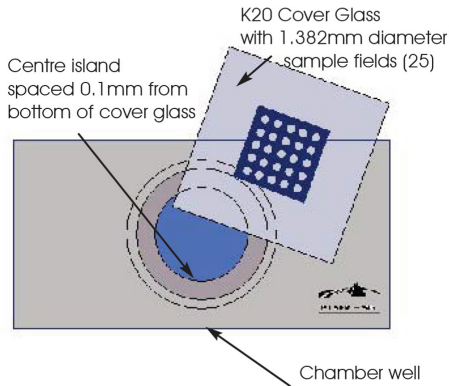

If using a compound microscope, examine using the X10 eyepiece and the X10 objective.

Systematically examine all 25 fields and note those with a presence or absence of mould filaments (hyphae).

A field is regarded as positive if the aggregate length of not more than three filaments present exceed one sixth of the diameter of the field.

This is a general description of how a Howard Cell is used. The results are interpreted as a percentage of positive fields observed in all the fields examined.

Precise interpretation of the results is made by a statistical analysis of the sample and should be carried out in accordance with your own internal or published procedures.

howard mould counting cell

The Makler counting chamber is only 10µm deep, which is one tenth the depth of other Haemocytometers, making it the shallowest of known chambers.

This quality chamber is constructed from two pieces of optically flat glass: the first is the chamber, the second the cover glass which has a fine grid pattern of 1mm squares and a centre area further subdivided into 0.1mm squares.

Four quartz pins of precise height hold the cover glass to give an exact trapped specimen depth of 10 µm

makler chamber

| pattern | description | order code |
|---------|------------------------------------|------------|
| Makler | 0.01mm deep Semen Counting Chamber | 02C00645 |

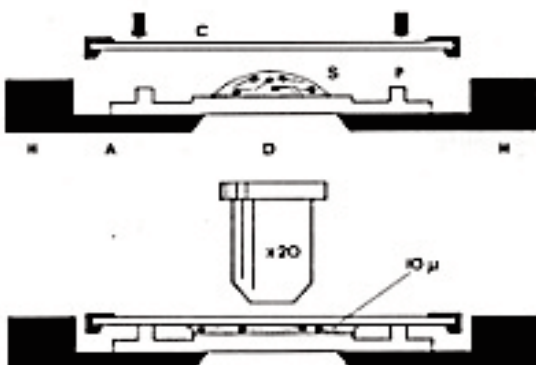
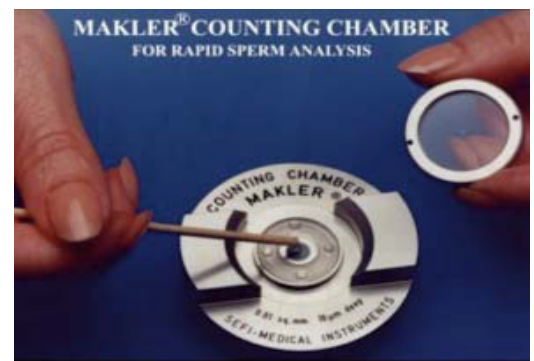

specialist chambers

This range of quality counting chambers are available in a wide range of types for Haemocytometry, Parasitology, Cytology and other applications.

Chambers with inside markings have rulings applied using engraving techniques to give a permanent image, clearly visible through the glass without sacrificing light transmission.

Chambers with ruled cover glass have robust image applied using chrome deposition.

| haemocytometry | | page |
|--|-------------|-------------|
| Agasse-Lefont | Single Cell | 12 |
| Burker | Double Cell | 12 |
| Malassez | Double Cell | 10 |
| Malassez | Single Cell | 10 |
| Neubauer | Double Cell | 11 |
| Neubauer | Single Cell | 11 |
| Neubauer, Improved | Double Cell | 12 |
| Thoma | Double Cell | 10 |
| Thoma | Single Cell | 11 |
| Turk | Double Cell | 13 |
| parasitology, cytology & others | | page |
| Agasse-Lefont B | Single Cell | 16 |
| Evaluation | Single Cell | 15 |
| Fertility | Single Cell | 16 |
| Helber | Single Cell | 15 |
| Lemaur | Single Cell | 14 |
| McMaster, Improved | Double Cell | 15 |
| Nageotte | Double Cell | 14 |
| Nageotte | Single Cell | 14 |
| chamber cover glasses | | page |
| McMaster, Old | Cover Glass | 17 |
| 22x22mm x0.45mm | Cover Glass | 17 |
| 30x28mm x 0.45mm | Cover Glass | 17 |

haemocytometry counting chambers

malassez double cell

| pattern | description | order code |
|----------|-------------------|------------|
| Malassez | Double Cell 0.2mm | 02C00600 |

key features

For Haemoglobin and Lucocyte counts

description

Standard French Ruling

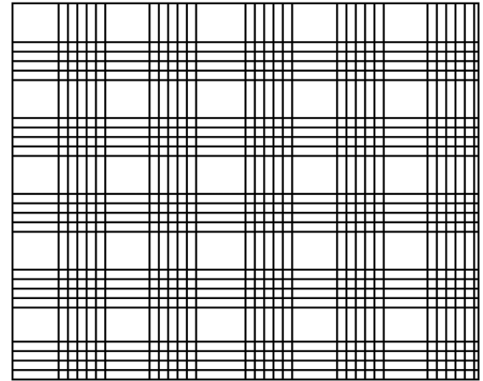

malassez single cell

| pattern | description | order code |
|----------|-------------------|------------|
| Malassez | Single Cell 0.2mm | 02C00601 |

key features

For Haemoglobin and Lucocyte counts

description

Standard French Ruling

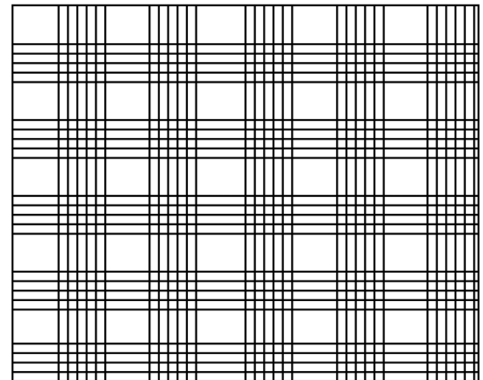

thoma double cell

| pattern | description | order code |
|---------|-------------------|------------|
| Thoma | Double Cell 0.1mm | 02C00605 |

key features

For Haemoglobin and Lucocyte counts

description

Standard German Ruling

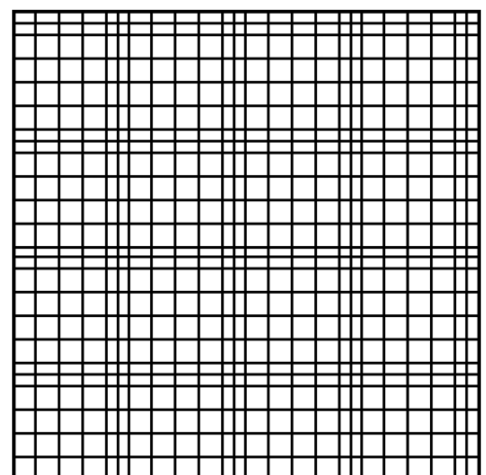

haemocytometry counting chambers

thoma single cell

| pattern | description | order code |
|---------|-------------------|------------|
| Thoma | Single Cell 0.1mm | 02C00606 |



key features

For Haemoglobin and Lucocyte counts

description

Standard German Ruling

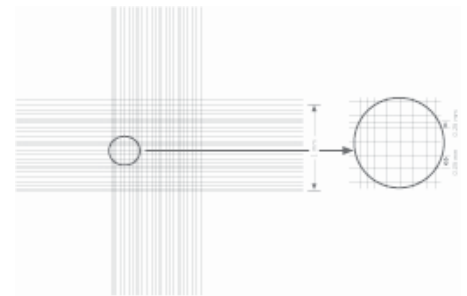

neubauer double cell

| pattern | description | order code |
|----------|-------------------|------------|
| Neubauer | Double Cell 0.1mm | 02C00610 |



key features

For Haemoglobin and Lucocyte counts

description

Modified Thoma Ruling

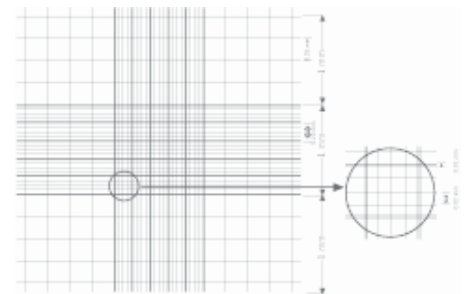

neubauer single cell

| pattern | description | order code |
|----------|-------------------|------------|
| Neubauer | Single Cell 0.1mm | 02C00611 |



key features

For Haemoglobin and Lucocyte counts

description

Modified Thoma Ruling

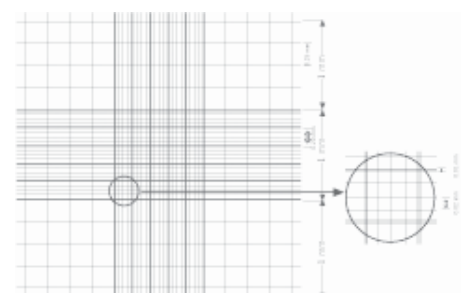

haemocytometry counting chambers

improved Neubauer double cell

| pattern | description | order code |
|-------------------|-------------------|------------|
| Improved Neubauer | Double Cell 0.1mm | 02C00616 |

key features

For Haemoglobin and Lucocyte counts

description

Ruling allows full use of central squares

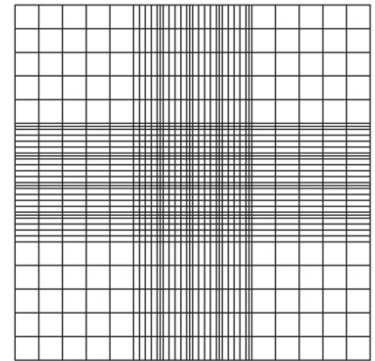

Burker

| pattern | description | order code |
|---------|-------------------|------------|
| Burker | Double Cell 0.1mm | 02C00626 |

key features

For Haemoglobin and Lucocyte counts

description

For counts in bands

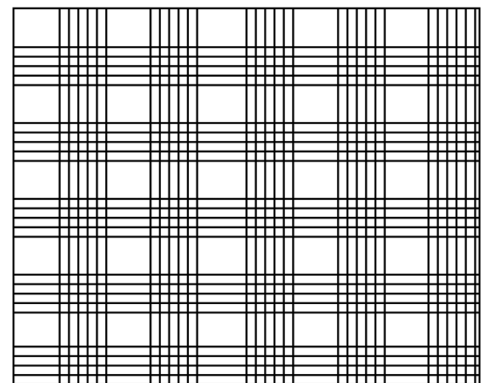

Thoma double cell

| pattern | description | order code |
|---------|-------------------|------------|
| Thoma | Double Cell 0.1mm | 02C00605 |

key features

For Haemoglobin and Lucocyte counts

description

Completely Decimal

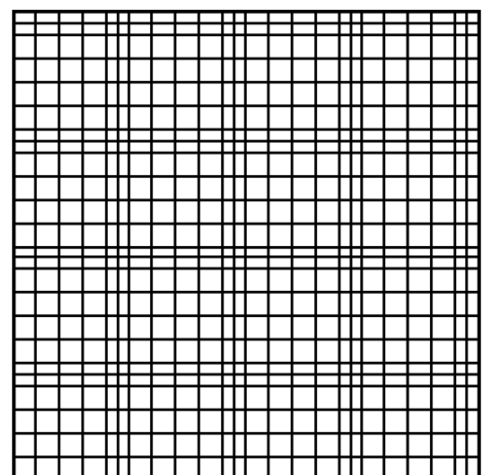

turk double cell

| pattern | description | order code |
|---------|-------------------|------------|
| Turk | Double Cell 0.1mm | 02C00621 |

key features

For Haemoglobin and Lucocyte counts

description

Combination of Burker and Thoma Rulings

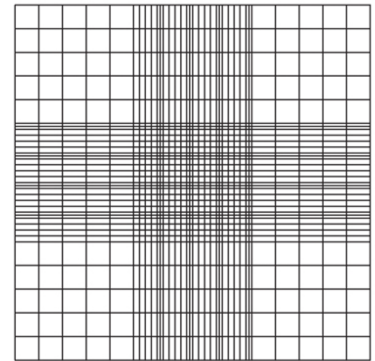

Typical Counting Chamber

parasitology, cytology & other chambers

nageotte double cell

| pattern | description | order code |
|----------|-------------------|------------|
| Nageotte | Double Cell 0.5mm | 02C00630 |

key features

For Urinary cytology, cephalo-rachidien fluid analysis

description

For liquids in poor content (French)

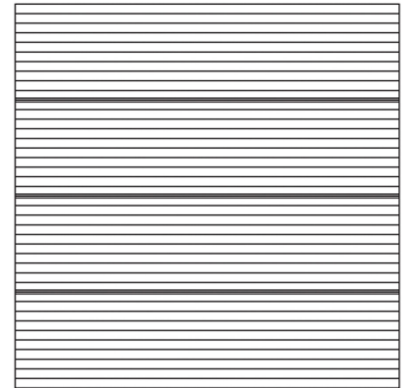

nageotte single cell

| pattern | description | order code |
|----------|-------------------|------------|
| Nageotte | Single Cell 0.5mm | 02C00631 |

key features

For Urinary cytology, cephalo-rachidien fluid analysis

description

For liquids in poor content (French)

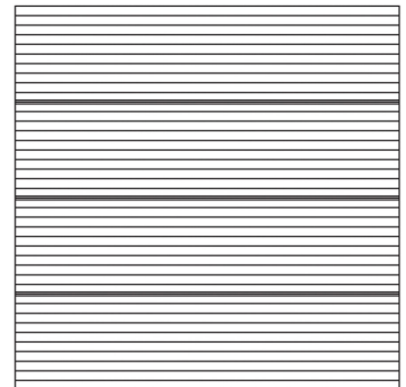

Lemaur Single Cell

| pattern | description | order code |
|---------|-------------------|------------|
| Lemaur | Single Cell 0.4mm | 02C00635 |

key features

For Urinary cytology, cephalo-rachidien fluid analysis

description

Improved Nageotte with smaller volume



improved mc master double cell

| pattern | description | order code |
|----------|-------------------|------------|
| McMaster | Double Cell 1.5mm | 02C00650 |

key features

Parasitology

description

Worm egg counting

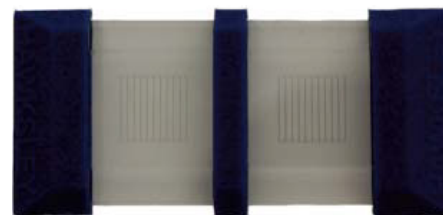

Chamber is ruled with 2 x 1 cm squares, each with 10 equal distance vertical lines forming 10 mm squares with 10 equal vertical columns.

helber single round cell

| pattern | description | order code |
|---------|--------------------------|------------|
| Helber | Single Round Cell 0.02mm | 02C00655 |

key features

Bacteria

description

Slide 1mm thick with Thoma Ruling

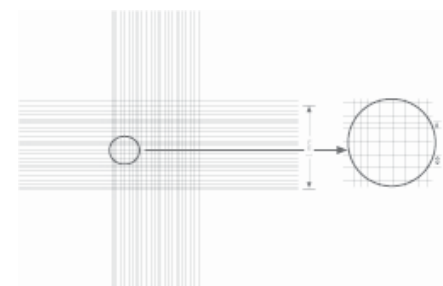

evaluation single round cell

| pattern | description | order code |
|------------|--------------------------|------------|
| Evaluation | Single Round Cell 0.02mm | 02C00660 |

key features

Bacteria

description

Slide 1mm thick - no ruling



parasitology, cytology & other chambers

semen single round cell

| pattern | description | order code |
|-----------|-------------------|------------|
| Fertility | Double Cell 0.5mm | 02C00630 |

key features

For Urinary cytology, cephalo-rachidien fluid analysis

description

For counting untreated semen. Ruling of 10 x 10 of 0.1mm squares

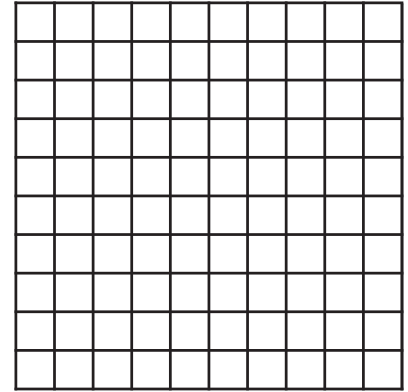

agasse lafont B single cell

| pattern | description | order code |
|-----------------|---------------------|------------|
| Agasse-Lefont B | Single Cell 0.003mm | 02C00675 |

key features

Other

description

Completely decimal

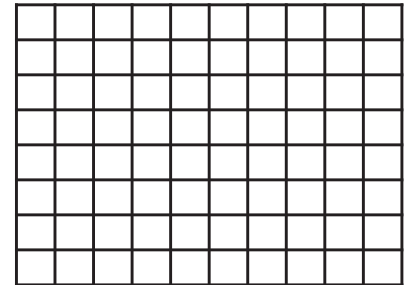

chamber cover glasses

cover glass for old type mc master

| pattern | description | order code |
|-------------------|-------------|------------|
| Old type McMaster | Cover Glass | 02C00651 |

key features

Parasitology

description

This cover slip is for the old McMaster chamber type see Improved McMaster for current product

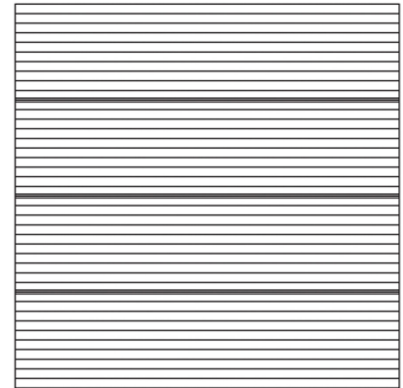

22mm x 22mm thickness 0.45mm

| pattern | description | order code |
|-----------------------|-------------|------------|
| Pack of cover glasses | 22mm x 22mm | 02C00700 |

key features

Suitable for counting chambers size 22mm x 22mm or 22mm x 25mm

description

Pack contains 5 pairs (10) cover glasses

30mm x 28mm thickness 0.45mm

| pattern | description | order code |
|-----------------------|-------------|------------|
| Pack of cover glasses | 30mm x 28mm | 02C00701 |

key features

Suitable for larger counting chambers

description

Pack contains 5 pairs (10) cover glasses

other products

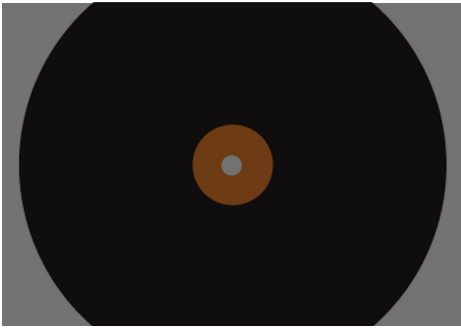

precision apertures

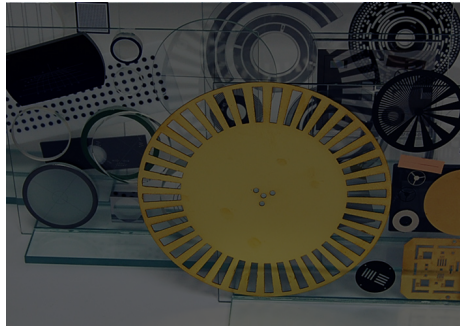

custom reticle solutions

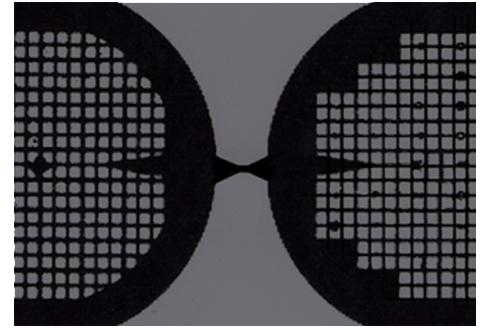

em grids

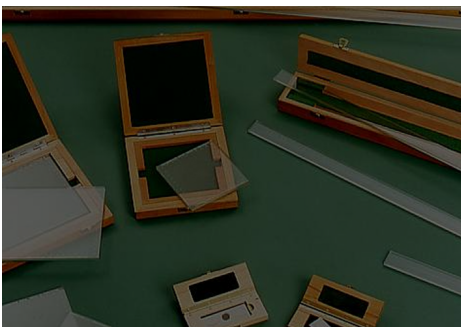

stage micrometers calibration standards



resolution charts and gratings

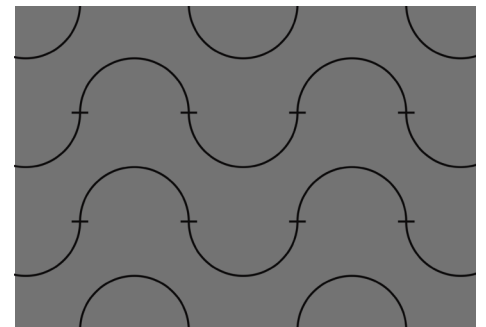

eyepiece reticles

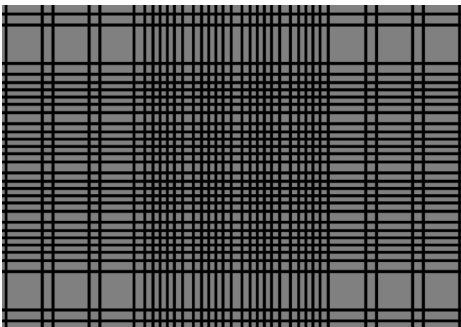

counting chambers



portable microscopes

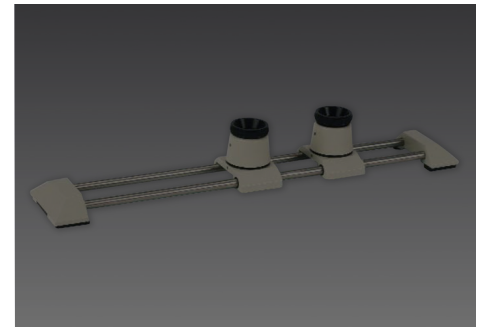

magnified measuring scales



mag 6 & mag 7 magnifiers