

## 150 Series "APCO-CHEM" Regenerative Turbine Process Pumps for Low Flow High Pressure Applications

- Capacities To 115 GPM
- Heads To 1200 Feet
- Temperatures To 500° F
- Meets ANSI B73.1 Std.

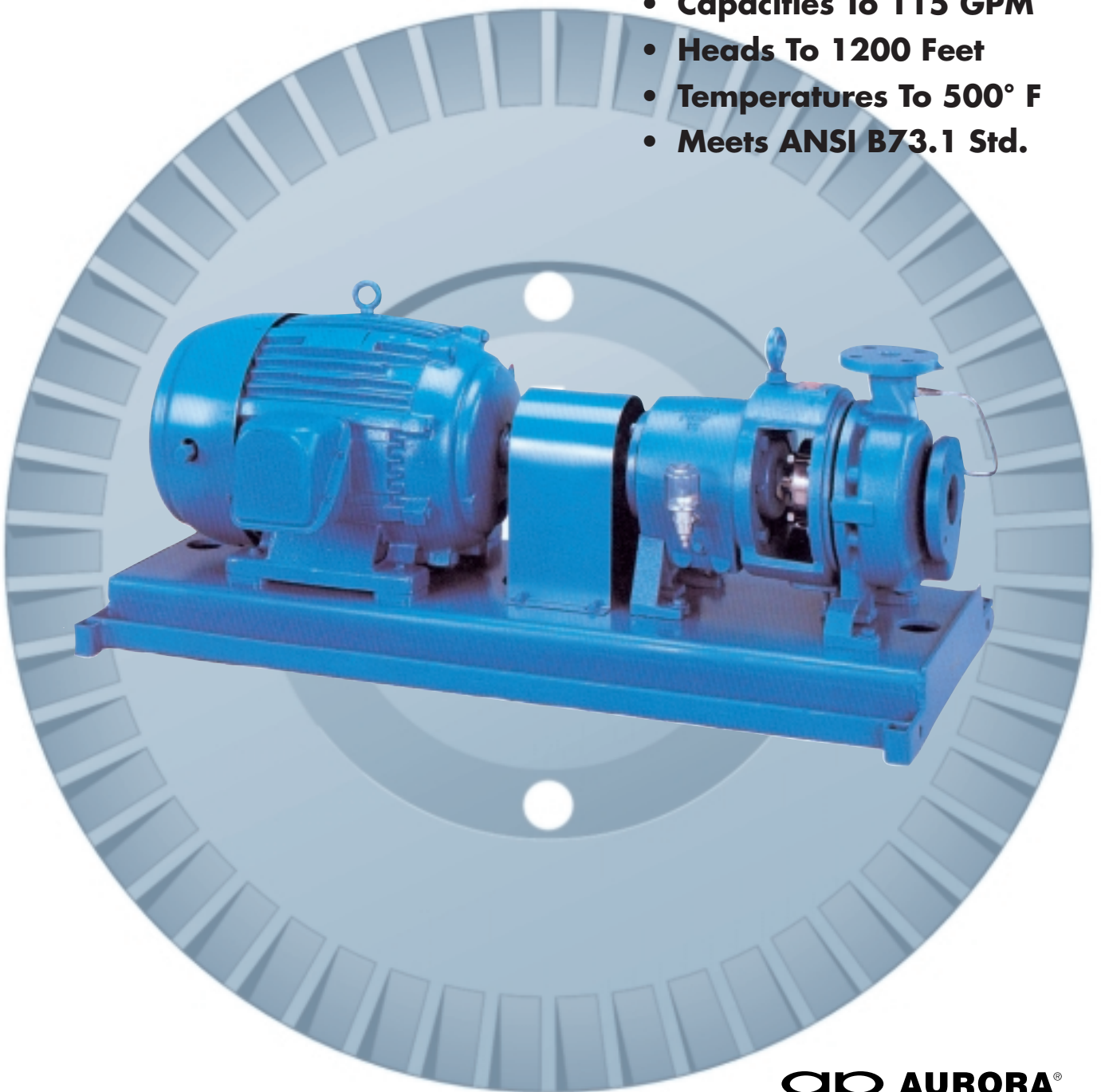

**ap AURORA®**

**PENTAIR PUMP GROUP**

# 150 Series "APCO-CHEM" Process Turbine Pump

## Low Flow, High Pressure Regenerative Turbine Process Pump

### Process Industry Field Proven For:

- Chemicals
- Petrochemicals
- Refinery
- Pulp and Paper
- General Industry

### Services:

- Boiler Feed
- Condensate
- Chemical Transfer
- Injection

### Design Features:

- Steep head capacity curves for applications that require minimal flow change.
- Ability to handle vapors up to 20% by volume.
- Steady flow—eliminates pulsation problems associated with other pump designs.
- Back pull-out design for low cost, one craft maintenance.
- Top vertical centerline discharge.
- Pump has known shut-off pressure as opposed to positive displacement designs.
- Reduced down-time for bearing and seal maintenance.
- Pump built to ANSI B73.1 dimensional standards for maximum interchangeability.
- Lower operating costs than standard centrifugal pumps at low flow conditions.
- Balanced double suction impeller design reduces axial thrust.

## Sealing Flexibility

**Shaft Arrangement** – With shaft sleeve.

**Seal Types** – Single or double, inside, balanced or unbalanced.

**Glands** – Plain, flush, quench, vent and drain.

**Seat Mounting** – Flexibly mounted "O"-ring or clamped stationary seat.

**Flush Plans** – ANSI and API configurations available.

**Type 1100**  
Single inside seal – cartridge seal

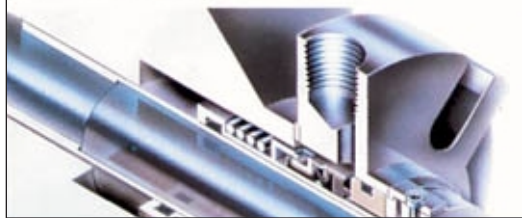

**Type 1B**  
Single inside



**Type 88**  
Double seal or tandem cartridge

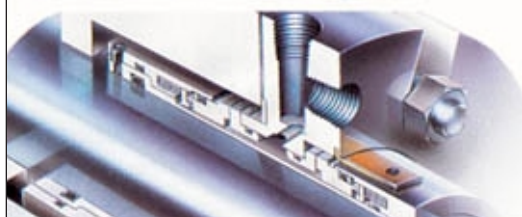

## “APCO-CHEM” Design Features of the One and Two Stage Turbine Type

### Model 151 and 152 (Single Stage Design)

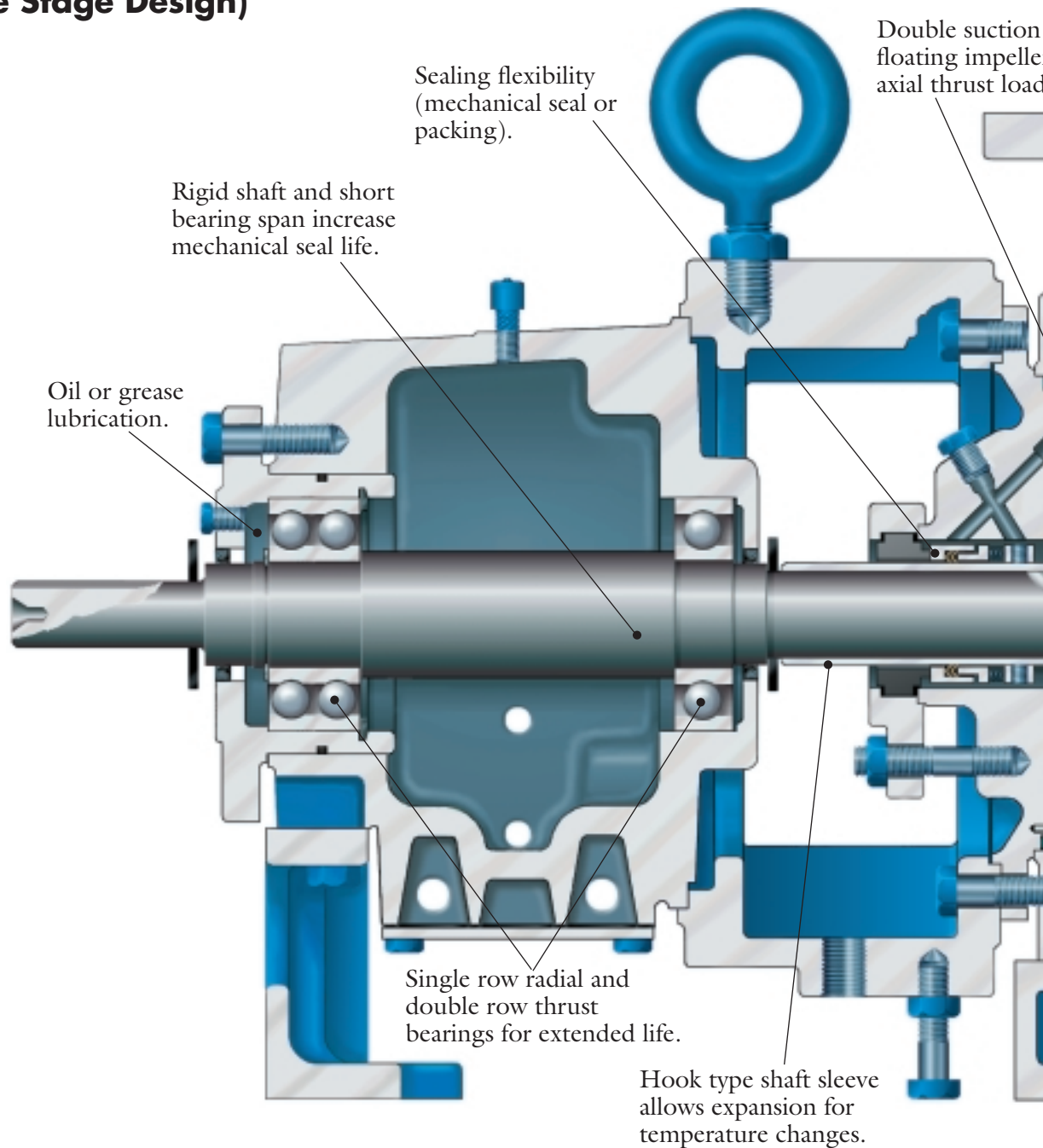

### Optional Design Features

- Jacketed stuffing box for cooling or heating mechanical seal cavity.
- Jacketed bearing frame provides bearing cooling for high temperature services.
- Case centerline mounting for high temperature services (not available on Model 151).

## Model 153 and 154 Liquid End

nd  
balances

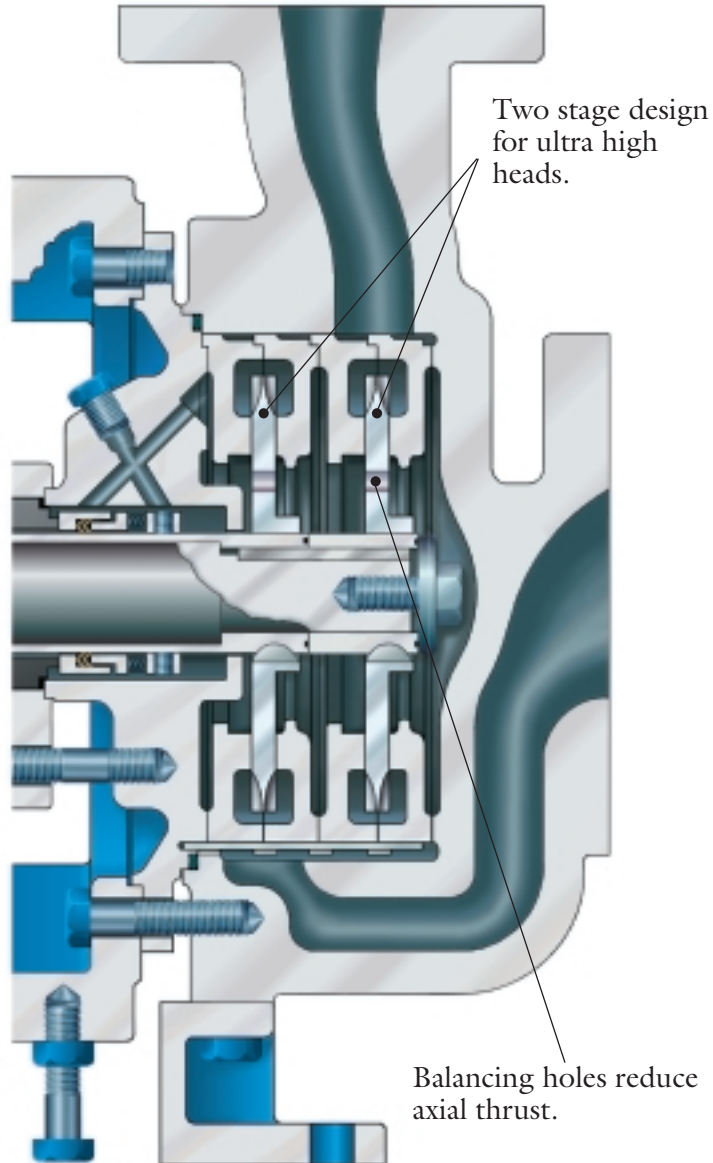
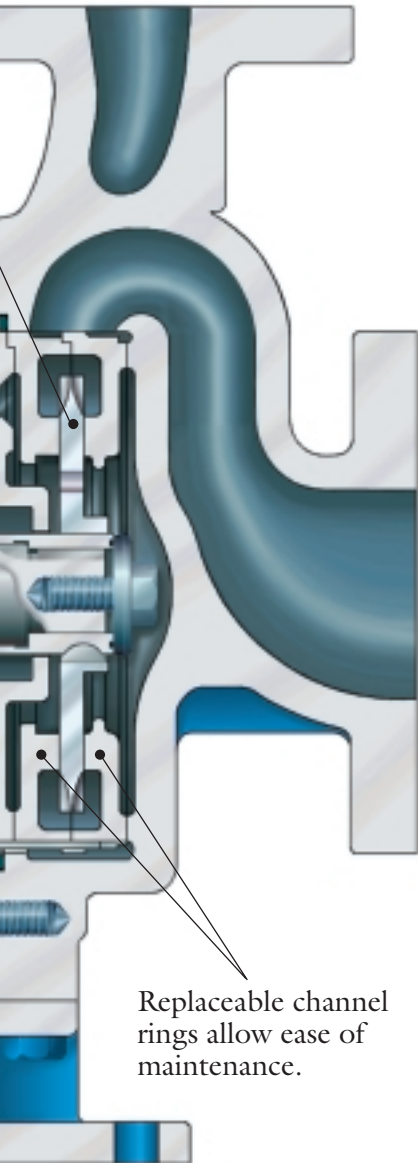

# Optimal Hydraulic Coverage

## “APCO-CHEM” Turbine Pumps

Specific speed ( $N_s$ )<sup>1</sup> can be thought of as a hydraulic index number indicating a specific type of pump best suited for a particular application. The Hydraulic Institute lists a range of  $N_s$  from 500 through 20,000 for centrifugal pumps starting at a straight radial impeller and progressing through an axial-flow design.<sup>2</sup>

But, what about  $N_s$ 's below 500? This is where the unique Apco-Chem regenerative turbine can best serve those special pumping applications. Consider the following pumping requirements at 3500 RPM.

Head (FT)	600	600	600	600
Flow (GPM)	10	30	60	90
$N_s$	91	158	224	274

Now try to find a good centrifugal pump that would meet those pumping requirements at a reasonable efficiency, NPSH requirement, and operating life. Rather difficult!

However, look at the quality performance a regenerative turbine can give to those requirements. Specific speed, then, is an index that indicates the type of pump best suited for the myriad pumping applications in the marketplace.  $N_s$  below 500 can best be handled by regenerative

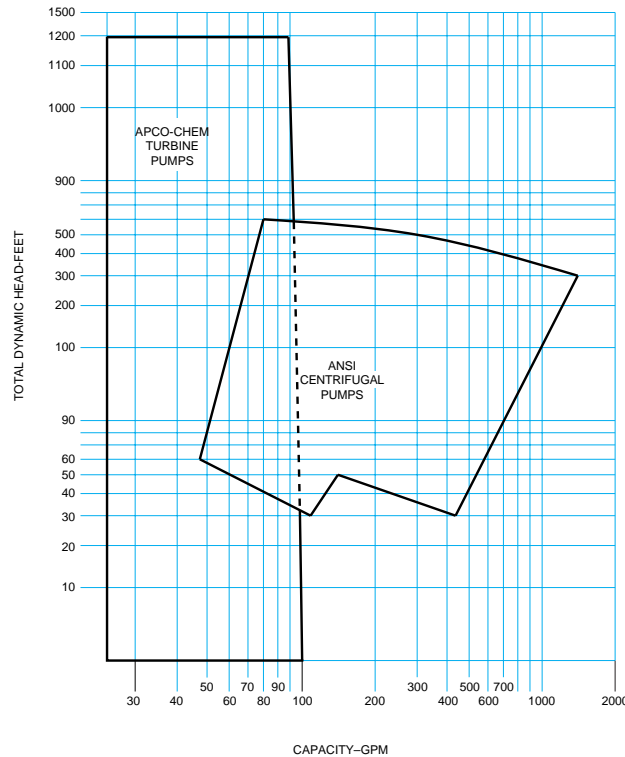

turbines that have the inherent hydraulic capabilities of pumping low flows and high head requirements.

$$^1 \text{Specific Speeds } N_s = \frac{(\text{RPM}) (\text{GPM})^{1/2}}{(\text{FT. of Head})^{3/4}}$$

<sup>2</sup>See ANSI/HI 1.1-1.5-1994 standards page 3.

EXAMPLE: Select a pump for 20 G.P.M., 320 feet Total Dynamic Head, with 3 foot N.P.S.H. available. Enter curve at 320 ft. and move to right to 3' N.P.S.H. line. Read down to 20.5 G.P.M. To determine the B.H.P., go back to 320 foot line and continue to right to solid Head-Capacity curve, then down to B.H.P. curve, then to right and read 4.7 B.H.P. For application where N.P.S.H. available exceeds that as shown by dotted lines, select pump capacity and B.H.P. on solid lines.

### 150 SERIES TURBINE TYPE PUMPS

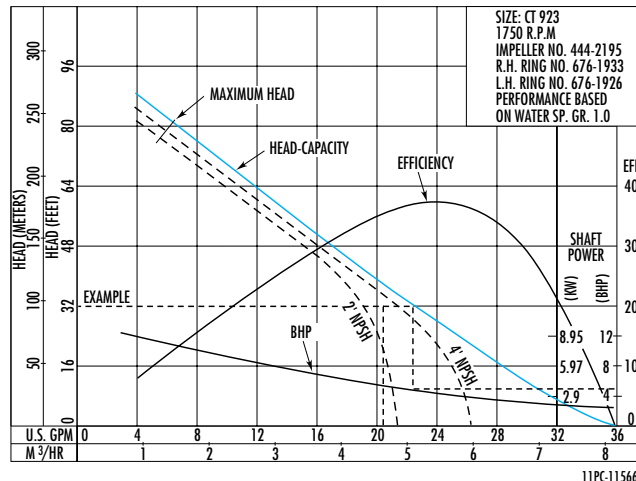

## Process Turbine Pump Principles of Operation

Turbine pumps derive their name from the many buckets machined into the periphery of the rotating impeller. They have long since been recognized for their effectiveness in the areas of low flow, high head application. The turbine pump offers higher heads than centrifugal pumps.

Because the head capacity curve is steep in a turbine pump, a greater degree of flexibility is available to the process engineer. Turbine pumps having top center line discharge are self-venting and have the ability to handle vapors without vapor lock.

This characteristic allows handling of boiling liquids and liquefied gases at suction heads slightly over the vapor pressure.

The turbine pump also has higher efficiencies at low

flows than a centrifugal pump.

Turbine pumps utilize close running clearances and are normally utilized on clean liquid applications. Viscous materials up to 500 S.S.U. can be pumped.

Turbine pumps are unique in operation. The pumped liquid is directed by the liquid passage so that the liquid circulates in and out of the impeller buckets many times on its way from the pump inlet to the pump outlet. Both centrifugal and shearing action combine to impart additional energy to the liquid each time it passes through the buckets.

Heads over 900 feet are successfully developed in a single stage. The impeller runs at very close axial clearances with the pump channel rings to minimize recirculation losses. The

channel rings provide a circular channel around the blade area of the impeller, from the inlet to the outlet. Liquid entering the channel from the inlet is picked up immediately by the buckets on both sides of the impeller and pumped through the channel (Figure 1) by a shearing action.

The flow of the liquid within the impeller buckets is illustrated in Figure 2. This process is repeated over and over, each cycle imparting more energy until the liquid is discharged. This flow is smooth and continuous.

In two stage pumps, the liquid is directed to a second stage impeller where the process is repeated, doubling the discharge head. By offsetting the discharges by 180°, the radial loads on the bearing are nearly balanced and shaft deflection is minimized.

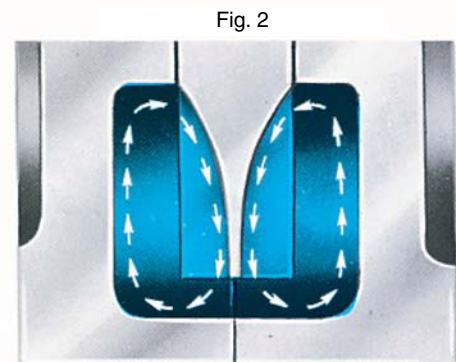
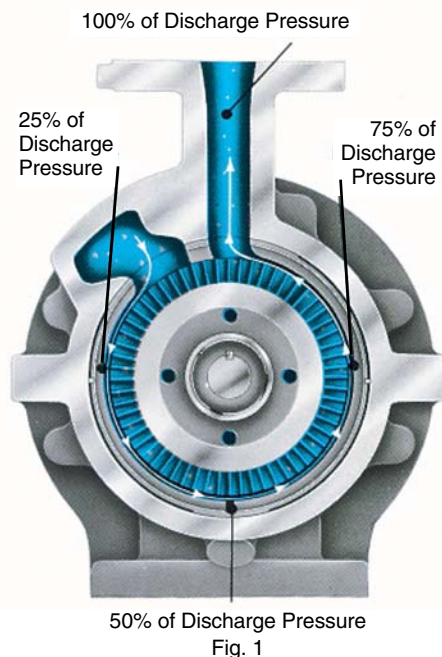

# Hydraulic Performance Range Charts

## 3500 RPM

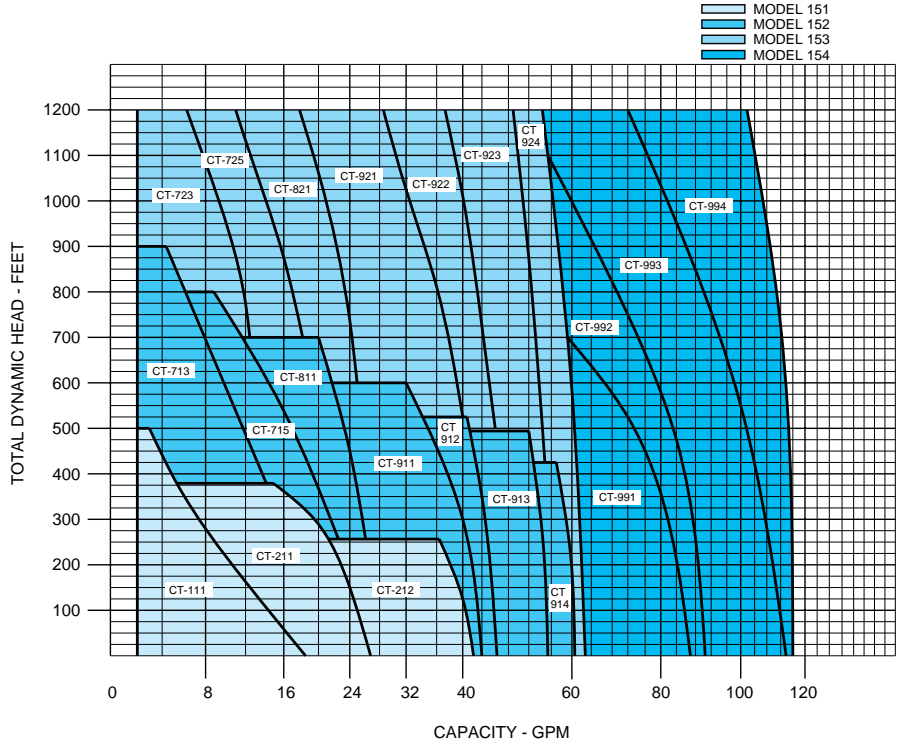

## 1750 RPM

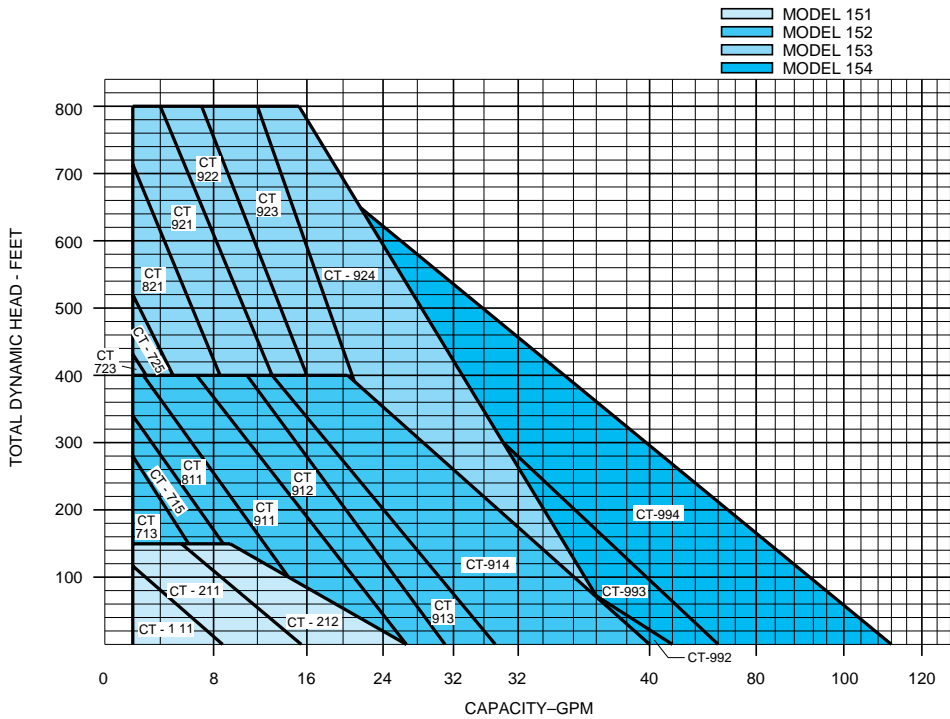

# Modular Design

APCO-CHEM offers for standard construction, 2 power frames, 3 shafts, 2 stuffing box covers, 10 impeller and channel ring sets and 4 casings for maximum interchangeability.

## Model 151 Single Stage

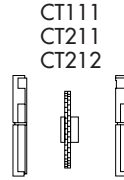
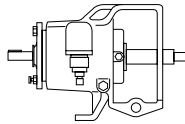

- 1 Frame
- 1 Stuffing Box
- 3 L.H. Rings
- 3 Impellers
- 3 R.H. Rings
- 1 Casing
- 1 Shaft

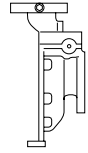

## Model 152 Single Stage

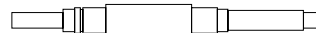
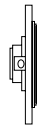
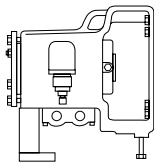

- CT713
- CT715
- CT811
- CT911
- CT912
- CT913
- CT914
- CT723
- CT725
- CT821
- CT921
- CT922
- CT923
- CT924

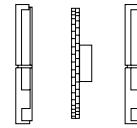

- 1 Frame
- 1 Stuffing Box
- 7 L.H. Rings
- 7 Impellers
- 7 R.H. Rings
- 3 Casings

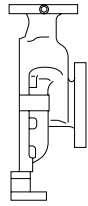

## Model 153 Two Stage

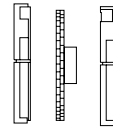

- CT991
- CT992

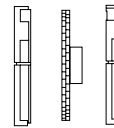

- CT993
- CT994

## Model 153

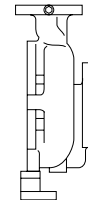

## Model 154



## Model 154 Duplex

Two stage utilizes single stage parts with exception of shaft and casing.  
Duplex utilizes two stage parts with exception of the casing.

# Materials of Construction

PUMP PART	MATERIAL CODE*		
	14	19	22
CASING	316 STAIN. STL. ASTM A743	DUCTILE IRON ASTM A395	ALLOY 20 ASTM A743 CN7M
IMPELLER	316 STAIN. STL. ASTM A743	DUCTILE IRON ASTM A395	ALLOY 20 ASTM A743 CN7M
SHAFT	316 STAIN. STL. AISI 316	STEEL AISI C1045	CARPENTER 20
CHANNEL RINGS	316 STAIN.** STL. ASTM A743	CAST IRON ASTM A48	ALLOY 20** ASTM A743 CN7M
SLEEVE	316 STAIN. STL. AISI 316	HDN. STAIN. STL. ASTM A276	CARPENTER 20
GLAND	316 STAIN. STL. AISI 316	DUCTILE IRON ASTM A395	ALLOY 20 ASTM A743 CN7M
STUFFING BOX	316 STAIN. STL. ASTM A743	DUCTILE IRON ASTM A395	ALLOY 20 ASTM A743 CN7M

Pumps come standard with packing.  
- Braided acrylic with graphite/TFE  
(Teflon lantern ring furnished upon request.)

\*Other material combinations available.

\*\*Chromium oxide ceramic coated sealing surfaces.



# Pressure & Temperature Capability

## Maximum Temperature Limitations for Pumped Liquid

DESCRIPTION	PUMP MODELS	
	151	152-3-4
Mechanical Seal – without stuffing box cooling (See Note 1).	300° F	300° F
Mechanical Seal – with water cooled stuffing box and water jacketed frame.	N/A	500° F
Packing – without stuffing box cooling (See Note 2).	300° F	300° F
Packing – with water cooled stuffing box and jacketed frame.	N/A	500° F

### NOTES:

1. Pumps with standard mechanical seals on continuous duty water applications MUST NOT exceed 180° F without providing cooling at the stuffing box. Special seal face materials will increase this limit – refer to factory.
2. Pumps with packing on water applications MUST NOT exceed 250° F without providing cooling at the stuffing box.
3. For temperatures above 300° F in models 152, 153 and 154, the centerline casing support is recommended.

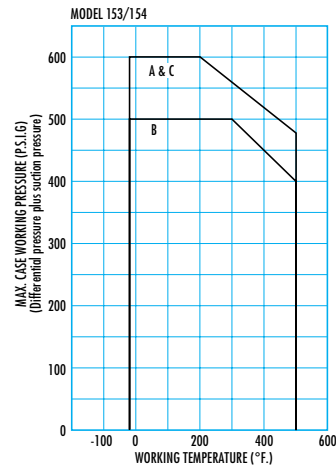
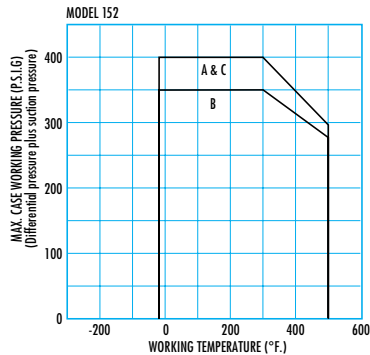
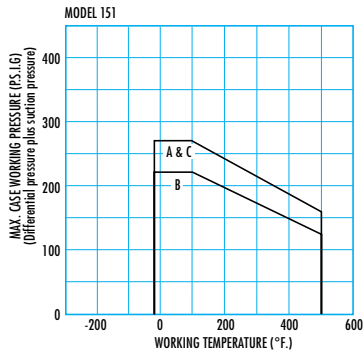

### Code For Pressure – Temperature Chart

A	B	C
316 SS	Ductile Iron	Alloy 20

## Construction Details

SERIES 150		PUMP MODEL			
		151	152	153	154
General	Discharge Flanges (300)	1	1½	1½	2
	Suction Flange	1½	3	3	3
	Number of Stages	1	1	2	2
	Casing Wall Thickness	½	⅝	¾	¾
	Nominal Impeller Dia.	4½	–	6	–
	Corrosion Allowance	⅛			
	Impeller Clearance	0.005' to 0.007'			
Stuffing Box	Rotation From CPLG	CW			
	Bore	1¾"	2½"		
	Depth	2"	2½"		
	O.D. Sleeve	1⅝"	1¾"		
	Packing Size	¾ Sq.	⅝ Sq.		
	Distance To First Obstruction	1⅝	2⅝		
Total Rings	5	5			

SERIES 150		PUMP MODEL			
		151	152	153	154
Shaft	Dia. at Impeller	1⅜"	1⅝"		
	Dia. at Sleeve	⅞"	1½"		
	Dia. Between Bearings	1⅝"	2⅝"		
	Dia. at Coupling End	⅞"	1⅝"		
	Keyway	¾ Sq.	¼ Sq.		
	Maximum Deflection	0.002"			
Bearings	Radial Bearing	306	309		
	Thrust Bearing	5306	5309		
	Bearing Centers	5.37"	6.87"		
	Radial Brg. and 1st Stg. Center	5.37"	6.56"		
	Radial Brg. and 2nd Stg. Center	5.75"	6.87"		
	Min. B10 Bearing Life	2 years			

TAPPED OPENINGS			
PURPOSE	NO. OF TAPS	TAP SIZE	
		151	152-3-4
Lantern Ring Connection	1	¼ NPSF	¼ NPSF
Frame Adapter Drain	1*	½ NPSF	½ NPSF
Discharge Gauge Connection**	1	¼ NPT	¼ NPT
Suction Gauge Connection**	1	¼ NPT	¼ NPT

\*Model 151 has 2 taps.

\*\*Optional

# General Dimensions and Engineering Specifications

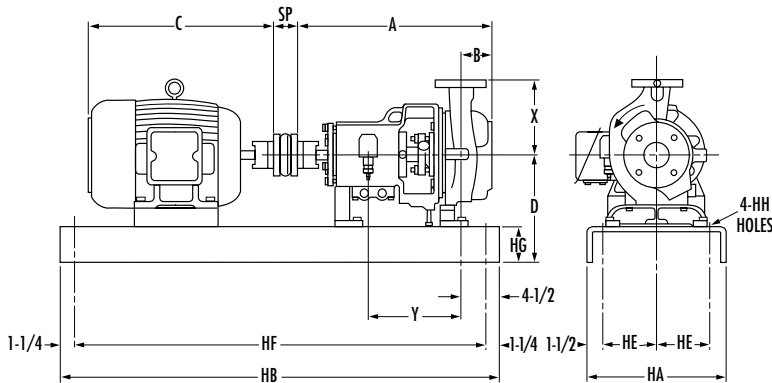

MODEL	PUMP SIZE	DISCHARGE SIZE	SUCTION SIZE	A	D	X	Y	B	SP
151	1x1 1/2x6	1	1 1/2	17 1/2	5 1/4	6 1/2	7 1/4	4	3 1/2
152	1 1/2x3x6	1 1/2	3	23 1/2	8 1/4	8 1/2	12 1/2	4	3 1/2
153	1 1/2x3x6	1 1/2	3	*23 1/2	8 1/4	8 1/2	12 1/2	4*	3 1/2
154	2x3x6	2	3	*23 1/2	8 1/4	9 1/2	12 1/2	4*	3 1/2

When optional 300# flange is used, add 3/16" to Model 153 and 15/16" to Model 154.

DIMENSIONS DETERMINED BY MOTOR									
MODEL	MOTOR			BEDPLATE					
	MOTOR FRAME SIZE	C MAX		HA	HB	HG	HF	HH	HE
151	1T	56 - 145T		10	35	3	32 1/2	3/4	4
151	2T	182 - 215T		12	39	3 1/4	36 1/2	3/4	4 1/2
152	1	143T - 215T		12	45	3 3/4	42 1/2	3/4	4 1/2
153	2	245T - 286TS		15	52	4 1/8	49 1/2	3/4	6
154	3	324T - 365TS		18	58	4 3/4	55 1/2	1	7

The contractor shall furnish (and install as shown on plans) Aurora Model (151 - 17-1/2" A.N.S.I. horizontal flexible coupled) (152 - 23-1/2" A.N.S.I. horizontal flexible coupled) (153 - 23-1/2", 154-23-1/2" A.N.S.I. horizontal flexible coupled) back pull out regenerative turbine pump(s) size..... x ..... x..... The pump shall be constructed with (ductile iron) (316 stainless steel) pressure containing parts having a minimum tensile strength of (60,000 PSI ductile iron) (80,000 PSI 316 stainless steel) and shall be of sufficient thickness to withstand stresses and strains at full operating pressures. Casings shall be subject to a hydrostatic pressure test at 150% of the specified duty point. The pump shall be capable of delivering at design conditions a capacity of..... G.P.M. when operating against a Total Dynamic Head of.....

feet, with a temperature of.....;°F, ..... Liquid specific gravity ..... Pump shall operate at a maximum synchronous speed of . . . R.P.M. A unit operating at a lesser rotative speed will be considered, but in no event will a pump operating at more than the maximum speed specified be acceptable. Each pump is to be furnished with a (standard) (water cooled) stuffing box with (.....mechanical seal) (packing). The unit must be equipped with (316 stainless steel) (440C hardened stainless steel, pack pumps) pin locked shaft sleeve that extends the length of the stuffing box. The pump shaft extension shall be "O" ring sealed from the pumped liquid. The discharge shall be in a vertical position and the pump shall be self-venting. The impeller shall be hydraulically self-centering and no external adjustment shall be necessary. Pump and motor are to be mounted on a

common (A.N.S.I. cast iron) (steel) baseplate. The pump shaft shall be made of high grade..... steel or equal. The minimum diameter acceptable will be.....". The shaft shall be installed in a cast iron power frame. Pumps shall have a shaft designed for .002" deflection at the face of the stuffing box with the pump running under maximum load condition. (Oil) (Grease) lubricated ball bearings, having a 2-year minimum life (AFBMA B-10) under the maximum condition of load protected by separate oil seals and slingers, shall be used. The pump shall be flexible coupled to standard horizontal NEMA .....HP.....phase..... Hertz.....volts..... RPM (drip-proof) (totally enclosed) (explosion-proof) motor. Alignment shall be checked in accordance with the standards of the Hydraulic Institute after installation and there shall be no strain transmitted to the pumps.

**NOTE:** Aurora Pump reserves the right to make revisions to its products and their specifications, and to this bulletin and related information without notice.

— Your Authorized Local Distributor —



**MARKETING & SALES:**  
800 AIRPORT ROAD • NORTH AURORA, ILLINOIS U.S.A. • 60542  
PHONE: (630) 859-7000 U.S.A./CANADA FAX: (630) 859-7060  
WORLDWIDE FAX: (630) 859-1226

**AURORA MFG. PLANT:**  
800 AIRPORT ROAD • NORTH AURORA, ILLINOIS U.S.A. • 60542

**SALES OFFICES IN ALL MAJOR CITIES AND COUNTRIES**  
Refer to "Pumps" in yellow pages of your phone directory for your local Distributor

