

Summary

Module 7

Module 7 – Summary

- 7A – ASME Section IX Weld Procedure Qualification
- 7B – ASME Section IX Welder Qualification

Module 7 Learning Objectives

- Understand how to qualify welding procedures in accordance to ASME Section IX
- Understand how to qualify welders accordance to Section IX

Weld Procedure Qualification

Module 7A

Weld Procedure Qualification

- Primary purpose for procedure qualification
 - To verify compatibility of materials and techniques to result in a sound weld with acceptable mechanical properties
 - ◆ WPS qualified by mechanical testing
 - ◆ PQR is documentation to prove that a weld can be made using the procedure and have acceptable mechanical properties

- How do you qualify a welding procedure?
 - Five step process
 1. Understand the intended application for which the WPS will be used
 2. Develop a draft procedure
 2. Make a qualification weld
 3. Test the qualification weld
 4. Write up the WPS

Weld Procedure Qualification

- Understand the intended application for which the WPS will be used
 - Things to know prior to qualifying a welding procedure
 - ◆ Know the application for the welding procedure
 - What welding process(es) are going to be used during construction
 - What materials are going to be used during construction
 - The types and grades
 - The thicknesses of each material
 - Are there dissimilar welds including welds between different P-No.
 - ◆ Know the design requirements for the application
 - Does the design require specific material toughness requirements

Example Procedure Qualification

- GTAW/GMAW qualification weld
 - 0.75" A 36 plate material
 - Flat position
 - ER70S-6 electrode was used for GMAW
 - ER80S-D2 electrode was used for GTAW
 - No preheat or PWHT

- Procedure Qualification Record (PQR) needs to address the welding variables of each welding process

GTAW Weld Procedure Variables

QW-256
WELDING VARIABLES PROCEDURE SPECIFICATIONS (WPS)
Gas Tungsten-Arc Welding (GTAW)

Paragraph	Brief of Variables	Essential	Supplementary Essential	Nonessential
QW-402 Joints	.1 ϕ Groove design			X
	.5 + Backing			X
	.10 ϕ Root spacing			X
	.11 \pm Retainers			X
QW-403 Base Metals	.5 ϕ Group Number		X	
	.6 Γ Limits		X	
	.8 Γ Qualified	X		
	.11 ϕ P-No, qualified	X		
QW-404 Filler Metals	.13 ϕ P-No. 5/9/10	X		
	.3 ϕ Size			X
QW-405 Positions	.4 ϕ F-Number	X		
	.5 ϕ A-Number	X		
	.12 ϕ Classification		X	
	.14 \pm Filler	X		
	.22 \pm Consum. insert			X
	.23 ϕ Filler metal product form	X		
	.30 ϕ z	X		
	.33 ϕ Classification			X
	.50 \pm Flux			X
	QW-406 Preheat	.1 ϕ Position		
.2 ϕ Position			X	
.3 ϕ $\uparrow\downarrow$ Vertical wetting				X
QW-407 PWHT	.1 Decrease > 100°F (55°C)	X		
	.5 Increase > 100°F (55°C) (IP)		X	
QW-408 Gas	.1 ϕ PWHT	X		
	.2 ϕ PWHT (T & T range)		X	
	.4 Γ Limits	X		
QW-409 Electrical Characteristics	.1 \pm Trail or ϕ comp.			X
	.2 ϕ Single, mixture, or %	X		
	.3 ϕ Flow rate			X
	.5 \pm or ϕ Backing flow			X
	.9 - Backing or ϕ comp.	X		
	.10 ϕ Shielding or trailing	X		

QW-256
WELDING VARIABLES PROCEDURE SPECIFICATIONS (WPS) (CONT'D)
Gas Tungsten-Arc Welding (GTAW)

Paragraph	Brief of Variables	Essential	Supplementary Essential	Nonessential
QW-410 Technique	.1 > Heat input		X	
	.3 \pm Pulsing I			X
	.4 ϕ Current or polarity		X	X
	.8 ϕ I & E range			X
QW-411 Technique	.12 ϕ Tungsten electrode			X
	.1 ϕ String/weave			X
	.3 ϕ Orifice, cup, or nozzle size			X
	.5 ϕ Method cleaning			X
	.6 ϕ Method back gouge			X
	.7 ϕ Oscillation			X
	.9 ϕ Multi to single pass/side		X	X
	.10 ϕ Single to multi electrodes		X	X
	.11 ϕ Closed to out chamber	X		
	.15 ϕ Electrode spacing			X
	.25 ϕ Manual or automatic			X
	.26 \pm Peening			X
	.64 Use of thermal processes	X		

Legend:
 + Addition > Increase/greater than \uparrow Uphill \leftarrow Forehand ϕ Change
 - Deletion < Decrease/less than \downarrow Downhill \rightarrow Backhand

GMAW Weld Procedure Variables

QW-255
WELDING VARIABLES PROCEDURE SPECIFICATIONS (WPS)
Gas Metal-Arc Welding (GMAW and FCAW)

Paragraph	Brief of Variables	Essential	Supplementary Essential	Nonessential
QW-402 Joints	.1 ϕ Groove design			X
	.4 – Backing			X
	.10 ϕ Root spacing			X
	.11 ± Retainers			X
QW-403 Base Metals	.5 ϕ Group Number		X	
	.6 ϕ Limits		X	
	.8 ϕ T Qualified	X		
	.9 r Pass > 1/2 in. (13 mm)	X		
	.10 ϕ Limits (S. cir. arc)	X		
	.11 ϕ P-No. qualified	X		
.13 ϕ P-No. 5/9/10	X			
QW-404 Filler Metals	.4 ϕ F-Number	X		
	.5 ϕ A-Number	X		
	.6 ϕ Diameter			X
	.12 ϕ Classification		X	
	.23 ϕ Filler metal product form	X		
	.24 ± Supplemental ϕ	X		
	.27 ϕ Alloy elements	X		
	.30 ϕ r	X		
	.32 r Limits (S. cir. arc)	X		
	.33 ϕ Classification			X
QW-405 Positions	.1 + Position			X
	.2 ϕ Position		X	
	.3 ϕ T ↓ Vertical welding			X
QW-406 Preheat	.1 Decrease > 100°F (55°C)	X		
	.2 ϕ Preheat maint.			X
	.3 Increase > 100°F (55°C) (IP)		X	
QW-407 PWHT	.1 ϕ PWHT	X		
	.2 ϕ PWHT (T & T range)		X	
	.4 ϕ Limits	X		

QW-255
WELDING VARIABLES PROCEDURE SPECIFICATIONS (WPS) (CONT'D)
Gas Metal-Arc Welding (GMAW and FCAW)

Paragraph	Brief of Variables	Essential	Supplementary Essential	Nonessential
QW-408 Gas	.1 ± Trail or ϕ comp.			X
	.2 ϕ Single, mixture, or %	X		
	.3 ϕ Flow rate			X
	.5 ± or ϕ Backing flow			X
	.9 – Backing or ϕ comp.	X		
	.10 ϕ Shielding or trailing	X		
QW-409 Electrical Characteristics	.1 > Heat input		X	
	.2 ϕ Transfer mode	X		
	.4 ϕ Current or polarity		X	X
	.8 ϕ I & E range			X
QW-410 Technique	.1 ϕ String/weave			X
	.3 ϕ Orifice, cup, or nozzle size			X
	.5 ϕ Method cleaning			X
	.6 ϕ Method back gouge			X
	.7 ϕ Oscillation			X
	.8 ϕ Tube-work distance			X
	.9 ϕ Multiple to single pass/side		X	X
	.10 ϕ Single to multiple electrodes		X	X
	.15 ϕ Electrode spacing			X
	.25 ϕ Manual or automatic			X
.26 ± Peening			X	
.64 Use of thermal processes		X		

Legend:
 + Addition > Increase/greater than ↑ Uphill ← Forehand ϕ Change
 - Deletion < Decrease/less than ↓ Downhill → Backhand

Procedure Qualification Record (PQR)

QW-483 SUGGESTED FORMAT FOR PROCEDURE QUALIFICATION RECORDS (PQR)
 (See QW-200.2, Section IX, ASME Boiler and Pressure Vessel Code)
 Record Actual Conditions Used to Weld Test Coupon

Company Name _____ Date _____
 Procedure Qualification Record No. _____
 WPS No. _____
 Welding Process(es) _____
 Types (Manual, Automatic, Semi-Automatic) _____

JOINTS (QW-482)

Groove Design of Test Coupon
 (For combination qualifications, the deposited weld metal thickness shall be recorded for each filler metal or process used.)

BASE METALS (QW-403) Material Spec. _____ Type or Grade _____ P-No. _____ to P-No. _____ Thickness of Test Coupon _____ Diameter of Test Coupon _____ Other _____	POSTWELD HEAT TREATMENT (QW-407) Temperature _____ Time _____ Other _____
FILLER METALS (QW-404) SFA Specification _____ AWS Classification _____ Filler Metal F.No. _____ Weld Metal Analysis A.No. _____ Size of Filler Metal _____ Other _____ Weld Metal Thickness _____	GAS (QW-408) Percent Composition Gas(es) (Mixture) Flow Rate Shielding _____ Trailing _____ Backing _____
POSITION (QW-406) Position of Groove _____ Weld Progression (Uphill, Downhill) _____ Other _____	ELECTRICAL CHARACTERISTICS (QW-409) Current _____ Polarity _____ Amperes _____ Volts _____ Tungsten Electrode Size _____ Other _____
PREHEAT (QW-405) Preheat Temperature _____ Interpass Temperature _____ Other _____	TECHNIQUE (QW-410) Travel Speed _____ String or Weave Bead _____ Oscillation _____ Multipass or Single Pass (Por Side) _____ Single or Multiple Electrodes _____ Other _____

QW-483 (Back)

Tensile Test (QW-150)

PQR No. _____

Specimen No.	Width	Thickness	Area	Ultimate Tensile Load, lb	Ultimate Unit Stress, psi	Type of Failure and Location

Guided-Bend Tests (QW-160)

Type and Figure No.	Result

Toughness Tests (QW-170)

Specimen No.	Notch Location	Specimen Size	Test Temperature	Impact Values			Drop Weight Break (KJ)
				ft-lb	% Shear	Mils	

Comments _____

Fillet-Weld Test (QW-180)

Result — Satisfactory: Yes _____ No _____ Penetration into Parent Metal: Yes _____ No _____

Macro — Results _____

Other Tests

Type of Test _____

Deposit Analysis _____

Other _____

Welder's Name _____ Clock No. _____ Stamp No. _____

Tests Conducted by _____ Laboratory Test No. _____

We certify that the statements in this record are correct and that the test welds were prepared, welded, and tested in accordance with the requirements of Section IX of the ASME BOILER AND PRESSURE VESSEL CODE.

Manufacturer _____

Date _____ By _____

(Detail of record of tests are illustrative only and may be modified to conform to the type and number of tests required by the Code.)

Procedure Qualification – Joint Variables

- Joint variables are the same for GTAW and GMAW

Paragraph		Brief of Variables	Essential	Supplementary Essential	Nonessential
QW-402 Joints	.1	φ Groove Design			X
	.4	- Backing			X
	.10	φ Root Spacing			X
	.11	± Retainers			X

- QW-402.1 – Groove design was a V-groove with a 45° included angle
- QW-402.4 – There was a backing bar used
- QW-402.10 – The root spacing was 1/8-in.
- QW-402.11 – Nonmetallic or nonfusing retainers were not used

Procedure Qualification – Joint Variables

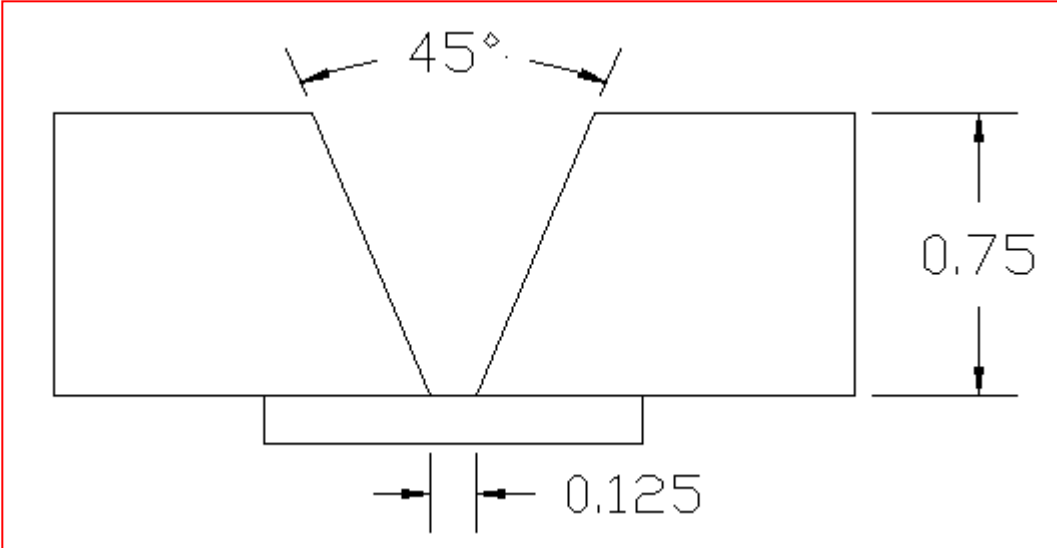
Company Name:	Nuclear Construction		
PQR No.:	NRC-PQR-1		
WPS No.:	NRC-WPS-1	Date:	June 8 and 9, 2010
Welding Process:	GTAW and GMAW		
Types (Manual, Automatic, Semi-Automatic):	Manual		
Joints (QW-402):	 <p>The diagram shows a cross-section of a V-groove joint. The two sides of the groove are at a 45-degree angle to the horizontal. The depth of the groove is 0.75 inches. The root opening at the bottom is 0.125 inches wide. The joint is shown between two rectangular plates.</p>		
<p>Note: The weld was both GTAW and GMAW with 1/4-in. deposited with GTAW and 1/2-in. deposited with GMAW</p>			

Procedure Qualification – Base Metal Variables

- Relevance of base metal variables depend on process

Paragraph		Brief of Variables	Essential	Supplementary Essential	Nonessential
QW-403 Base Materials	.5	φ Group No.		X	
	.11	φ P-No. Qualified	X		

- QW-403.5 and QW-403.11 – Material was A36 plate which is P-No. 1 and Group 1 Material
 - Table QW-422

Spec. No.	Type/Grade	UNS No.	P-No.	Group No.	Nominal Composition	Product Form
SA-36	-	K02600	1	1	C-Mn-Si	Plate, Bar & Shapes

Procedure Qualification – Base Metal Variables

Paragraph		Brief of Variables	Essential	Supplementary Essential	Nonessential
QW-403 Base Materials	.6	T Limits		X	
	.8	φ T Qualified	X		
	.9	t pass > 1/2-in.	X		
	.10	T Limits (S. Cir. Arc)	X		

- QW-403.6, QW-403.8 and QW-403.10 – Material thickness was 0.75-in.
- QW-403.9 – No single weld pass in the qualification weld was greater than 1/2-in.
 - GMAW only

Procedure Qualification – Base Metal Variables

Base Metals (QW-403)			
Material Spec.:	SA-36		
Type or Grade:	N/A		
P- No.:	P-No.1	To P-No.:	P-No. 1
Thickness of Test Coupon:	3/4-in.		
Diameter of Test Coupon:	N/A		
Other:			
<ol style="list-style-type: none">1. SA-36 does not come in different grades2. The weld was made on plate so diameter does not apply.3. All passes were less than 1/2-in. thick			

Procedure Qualification – Filler Metal Variables

- Relevance of filler metal variables depend on process

Paragraph		Brief of Variables	Essential	Supplementary Essential	Nonessential
QW-404 Filler Metals	.3	φ Size			X
	.6	φ Diameter			X
	.23	φ Filler Metal Product Form	X		

- QW-404.3 – The GTAW wire diameter was 1/8-in.
 - GTAW only
- QW-404.6 – The GMAW electrode diameter was 0.035-in.
 - GMAW only
- QW-404.23 – Solid wire was used

Procedure Qualification – Filler Metal Variables

Paragraph		Brief of Variables	Essential	Supplementary Essential	Nonessential
QW-404 Filler Metals	.4	φ F-No.	X		

- QW-404.4 – The welding wire was ER80S-D2 for GTAW and ER70S-6 for GMAW
 - ASME Section II, SFA 5.28 specifies low-alloy steel electrodes for gas shielded arc welding
 - ASME Section II, SFA 5.18 specifies carbon steel electrodes for gas shielded arc welding
 - Table QW-432

F-No.	ASME Specification	AWS Classification
6	SFA-5.28	All Classifications
6	SFA-5.18	All Classifications

Procedure Qualification – Filler Metal Variables

Paragraph		Brief of Variables	Essential	Supplementary Essential	Nonessential
QW-404 Filler Metals	.5	φ A-No.	X		

- QW-404.5 – The welding wire was ER80S-D2 for GTAW and ER70S-6 for GMAW
 - SAME ASME Section II specifications apply to determine chemistry
 - Table QW-442

A-No.	Weld Deposit	Analysis, %					
		C	Cr	Mo	Ni	Mn	Si
11	Mn – Mo	0.17	-	0.25 – 0.75	0.85	1.25 – 2.25	1.00
ER80S-D2 (SFA 5.18)		0.07 – 0.12	-	0.4-0.6	0.15	1.60 – 2.10	0.5 – 0.8
1	Mild Steel	0.20	-	-	-	1.60	1.00
ER70S-6 (SFA 5.18)		0.06 – 0.15	0.15	0.15	0.15	1.40 – 1.85	0.80 – 1.15

Procedure Qualification – Filler Metal Variables

Paragraph		Brief of Variables	Essential	Supplementary Essential	Nonessential
QW-404 Filler Metals	.12	φ Classification		X	
	.14	± Filler	X		
	.33	φ Classification			X
	.50	± Flux			X

- QW-404.12 and QW-404.33 – The wire classification was ER80S-D2 for GTAW and ER70S-6 GMAW
- QW-404.14 – Filler metal was used
 - GTAW only
- QW-404.50 – No flux was used
 - GTAW only

Procedure Qualification – Filler Metal Variables

Paragraph		Brief of Variables	Essential	Supplementary Essential	Nonessential
QW-404 Filler Metal	.22	± Consumable Insert			X
	.24	± or φ Supplemental	X		
	.27	φ Alloy Elements	X		
	.30	φ t	X		
	.32	t limits (S.C. Arc)	X		

- QW-404.22 – No consumable insert was used
 - GTAW only
- QW-404.24 and QW-404.27 – No Supplemental filler metal was used so variable does not apply
 - GMAW only
- QW-404.30 and QW-404.32 – Weld thickness was 1/4-in. for GTAW and 1/2-in. for GMAW

Procedure Qualification – Filler Metal Variables

Filler Metals (QW-404)	
SFA Specification:	SFA 5.28 for GTAW SFA 5.18 for GMAW
AWS Classification:	ER80S-D2 for GTAW ER70S-6 for GMAW
Filler Metal F-No.	6 for GTAW and GMAW
Weld Metal Analysis A-No.:	11 for GTAW 1 for GMAW
Size of Filler Metal	1/8-in. for GTAW 0.035-in. for GMAW
Weld Metal Thickness:	1/4-in. for GTAW 1/2-in. for GMAW
Other:	

Procedure Qualification – Position Variables

- Positions variables are the same for GTAW and GMAW

Paragraph		Brief of Variables	Essential	Supplementary Essential	Nonessential
QW-405 Positions	.1	+ Position			X
	.2	φ Position		X	
	.3	φ $\uparrow\downarrow$ Vertical Welding			X

- QW-405.1, QW-405.2 and QW-405.3 – The weld was made in the flat position

Procedure Qualification – Position Variables

Position (QW-405)	
Position of Groove:	Flat
Weld Progression:	N/A
Other:	

Procedure Qualification – Preheat Variables

- Relevance of preheat variables depend on the process

Paragraph		Brief of Variables	Essential	Supplementary Essential	Nonessential
QW-406 Preheat	.1	Decrease > 100°F	X		
	.2	φ Preheat Maintenance			X
	.3	Increase >100°F		X	

- QW-406.1 and QW-406.2 – No preheating was used during qualification
- QW-406.3 – Maximum interpass temperature was 450°F

Procedure Qualification – Preheat Variables

Preheat (QW-406)	
Preheat Temperature:	Ambient (70°F)
Interpass Temperature:	450°F
Other:	

Procedure Qualification – PWHT Variables

- PWHT variables are the same for GTAW and GMAW

Paragraph		Brief of Variables	Essential	Supplementary Essential	Nonessential
QW-407 PWHT	.1	φ PWHT	X		
	.2	φ PWHT (T & T range)		X	
	.4	T Limits	X		

- QW-407.1, QW-407.2 and QW-407.4 – No PWHT was used during qualification

Procedure Qualification – Preheat Variables

PWHT (QW-407)	
Temperature:	None
Time:	None
Other:	1. No PWHT was used during qualification

Procedure Qualification – Gas Variables

- Gas variables are the same for GTAW and GMAW

Paragraph		Brief of Variables	Essential	Supplementary Essential	Nonessential
QW-408 Gas	.1	± Trail or ϕ Composition			X
	.5	± or ϕ Backing Gas			X
	.9	- Backing or ϕ Composition	X		
	.10	ϕ Shielding or Trailing	X		

- QW-408.1 and QW-408.10 – No trail shield gas was used
- QW-408.5 and QW-408.9 – No backing shield gas was used

Procedure Qualification – Gas Variables

Paragraph		Brief of Variables	Essential	Supplementary Essential	Nonessential
QW-408 Gas	.2	φ Single, Mixture or %	X		
	.3	φ Flow Rate			X

- QW-408.2 – 100% Argon shielding gas was used for GTAW and 75% Argon/25% CO₂ was used for GMAW
- QW-408.3 – 15 – 25 cfh shielding gas flow rate was used for GTAW and 25 – 35 cfh shielding gas flow rate was used for GMAW

Procedure Qualification – Gas Variables

Gas (QW-408)			
	Percent Composition		
	Gas(es)	Mixture	Flow Rate
Shielding	GTAW - Argon	100%	15 – 25 cfh
	GMAW - Argon/CO ₂	75%/25%	25 – 35 cfh
Trailing	N/A	N/A	N/A
Backing	N/A	N/A	N/A

Procedure Qualification – Electrical Characteristics Variables

- Relevance of electrical characteristics variables depend on the process

Paragraph		Brief of Variables	Essential	Supplementary Essential	Nonessential
QW-409 Electrical Characteristics	.1	> Heat Input		X	
	.2	φ Transfer Mode	X		
	.3	± Pulsing I			X

- QW-409.1 – The maximum heat input was 45 kJ/in.
 - $HI (kJ/in.) = I * V / T.S. * 60 / 1000$
- QW-409.2 – The GMAW transfer mode was globular
 - GMAW only
- QW-409.3 – Pulse mode GTAW was not used
 - GTAW only

Procedure Qualification – Electrical Characteristics Variables

Paragraph		Brief of Variables	Essential	Supplementary Essential	Nonessential
QW-409 Electrical Characteristics	.4	φ Current or Polarity		X	X
	.8	φ I or E Range			X
	.12	φ Tungsten Electrode			X

- QW-409.4 – GTAW weld was made using direct current with electrode positive polarity and the GMAW weld was made using direct current and electrode negative polarity
- QW-409.8 – GTAW weld was made using a 175 -200 amps and 10 - 14 volts and the GMAW weld was made using 170-200 amps and 24-28 volts
- QW-409.12 – The tungsten was 2% ceriated with a 1/8-in. diameter
 - GTAW only

Procedure Qualification – Electrical Characteristics Variables

Electrical Characteristics (QW-409)	
Current:	Direct Current
Polarity:	EP for GTAW and EN for GMAW
Amps:	175 – 200 for GTAW and 170 – 200 for GMAW
Volts:	10 – 14 for GTAW and 24 – 28 for GMAW
Tungsten Electrode Size:	1/8-in. diameter
Other:	<ol style="list-style-type: none">1. Maximum heat input was 45 kJ/in.2. 2% Ceriated Tungsten was used

Procedure Qualification – Technique Variables

- Relevance of technique variables depend on the process

Paragraph		Brief of Variables	Essential	Supplementary Essential	Nonessential
QW-410 Technique	.1	φ Stringer/Weave			X
	.3	φ Orifice, Cup or Nozzle Size			X
	.5	φ Method of cleaning			X
	.6	φ Method of Back Gouging			X

- QW-410.1 – GTAW and GMAW weld was made using stringer beads
- QW-410.3 – GTAW weld was made with a 5/8-in. cup size and the GMAW weld was made with a 1-in. nozzle size
- QW-410.5 – Cleaning was done using a wire brush
- QW-410.6 – No back gouging was performed

Procedure Qualification – Technique Variables

Paragraph		Brief of Variables	Essential	Supplementary Essential	Nonessential
QW-410 Technique	.7	φ Oscillation			X
	.8	φ Tube-work Distance			X
	.9	φ Multiple to Single Pass/Side		X	X
	.10	φ Single to Multiple Electrodes		X	X
	.11	φ Closed to Out Chamber	X		

- QW-410.7 – The weld was a manual weld
- QW-410.8 – A CTWD of 1/2 to 3/4-in. was used
 - GMAW only
- QW-410.9 – Multiple passes per side were deposited
- QW-410.10 – A single electrode was used
- QW-410.11 – The weld was made outside a chamber
 - GTAW only

Procedure Qualification – Technique Variables

Paragraph		Brief of Variables	Essential	Supplementary Essential	Nonessential
QW-410 Technique	.15	φ Electrode Spacing			X
	.25	φ Manual or Automatic			X
	.26	± Peening			X
	.64	Use of Thermal Processes	X		

- QW-410.15 – Only a single electrode was used
- QW-410.25 – The weld was a manual weld
- QW-410.26 – No peening was used
- QW-410.11 – No thermal processing was used

Procedure Qualification – Electrical Characteristics Variables

Technique (QW-410)	
Travel Speed:	1 to 5 ipm
Stringer or Weave Bead:	Manual Stringer Bead
Oscillation:	No Oscillation
Multi/Single Pass per Side:	Multiply Passes per Side
Multi/Single Electrode:	Single Electrode
Other:	<ol style="list-style-type: none">1. No peening was used2. CTWD was 1/2 – 3/4-in.3. Cleaning with a wire brush4. GTAW gas cup was 5/8-in.5. GMAW nozzle size was 1-in.

Procedure Qualification – Testing

- The qualification weld was a groove weld in 0.75-in. thick plate
 - Table QW-451.1 and QW-451.2 outline the destructive test requirements for procedure qualification

Thickness of Test Coupon, T	Type and Number of Test Required			
	Tension, QW-150	Side Bend, QW-160	Face Bend, QW-160	Root Bend, QW-160
1/16-in. to 3/8-in.	2	(5)	2	2
> 3/8-in. but < 3/4-in.	2	(5)	2	2
3/4-in. to < 1 1/2-in.	2 (4)	4	-	-
1 1/2-in. to 6-in.	2 (4)	4	-	-

- (4) See details on multiple specimens when coupon thickness is over 1-in.
- (5) Four side bends can replace the face and root bends when coupon thickness is 3/8-in. or greater

Procedure Qualification – Testing

QW-463.1(b) PLATES – $\frac{3}{4}$ in. (19 mm) AND OVER THICKNESS AND ALTERNATE FROM $\frac{3}{8}$ in. (10 mm) BUT LESS THAN $\frac{3}{4}$ in. (19 mm) THICKNESS PROCEDURE QUALIFICATION

Discard		this piece
Side bend		specimen
Reduced section		tensile specimen
Side bend		specimen
Side bend		specimen
Reduced section		tensile specimen
Side bend		specimen
Discard		this piece



Procedure Qualification – Testing

- QW-150 describes the different types of tensile test samples, machine tolerances and acceptance criteria
 - The tensile strength must exceed 58 ksi
 - ◆ Minimum required strength for A36
 - QW-422

QW-462.1(d) TENSION – REDUCED SECTION – TURNED SPECIMENS

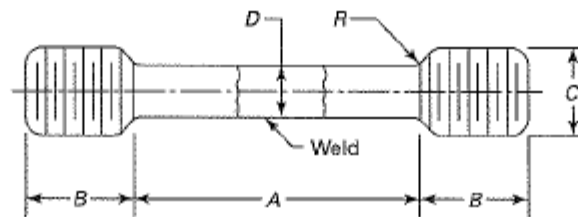

Standard Dimensions, in. (mm)

	(a) 0.505 Specimen	(b) 0.353 Specimen	(c) 0.252 Specimen	(d) 0.188 Specimen
A— Length of reduced section	Note (1)	Note (1)	Note (1)	Note (1)
D— Diameter	0.500 ± 0.010 (12.7 ± 0.25)	0.350 ± 0.007 (8.89 ± 0.18)	0.250 ± 0.005 (6.35 ± 0.13)	0.188 ± 0.003 (4.78 ± 0.08)
R— Radius of fillet	3/8 (10) min.	1/4 (6) min.	3/16 (5) min.	1/8 (3) min.
B— Length of end section	1 3/8 (35) approx.	1 1/2 (29) approx.	7/8 (22) approx.	1/2 (13) approx.
C— Diameter of end section	3/4 (19)	1/2 (13)	3/8 (10)	1/4 (6)

Procedure Qualification – Testing

- QW-160 describes the different types of bend test samples, machine tolerances and acceptance criteria
 - No open discontinuities in the weld or HAZ greater than 1/8-in.
 - Provides some leeway

QW-462.2 SIDE BEND

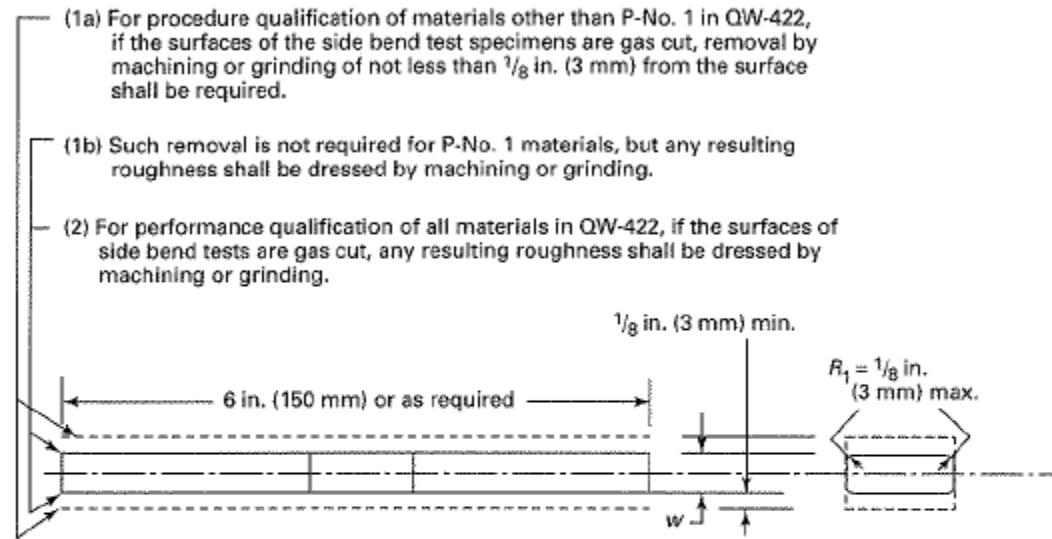

T, in. (mm)	y, in. (mm)	w, in. (mm)	
		P-No. 23, F-No. 23, or P-No. 35	All other metals
3/8 to < 1 1/2 (10 to < 38)	T [Note (1)]	1/8 (3)	3/8 (10)
≥ 1 1/2 (≥ 38)	Notes (1) and (2)	1/8 (3)	3/8 (10)

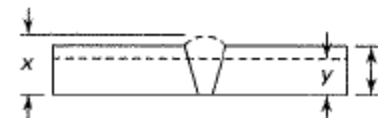

Procedure Qualification – Testing

- QW-162 describes the bend test jig that should be used for qualification

QW-466.3 GUIDED-BEND WRAP AROUND JIG

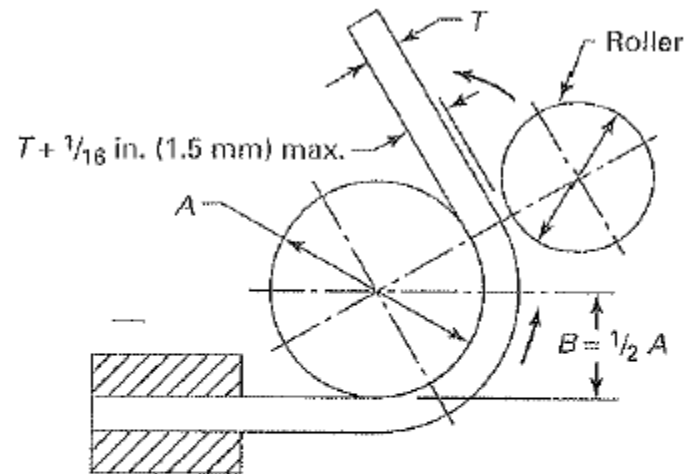

GENERAL NOTES:

- See QW-466.1 for jig dimensions and other general notes.
- Dimensions not shown are the option of the designer. The essential consideration is to have adequate rigidity so that the jig parts will not spring.
- The specimen shall be firmly clamped on one end so that there is no sliding of the specimen during the bending operation.
- Test specimens shall be removed from the jig when the outer roll has been removed 180 deg from the starting point.

Procedure Qualification – Testing

- The diameter of the mandrel is based on the material being tested

Material	Thickness of Specimen, in.	Customary Units			
		A, in.	B, in.	C, in.	D, in.
P-No. 23 to P-No. 21 through P-No 25; P-No. 21 through P-No. 25 with F-No. 23; P-No. 35; any P-No. metal with F-No. 33, 36, or 37	$\frac{1}{8}$ $t = \frac{1}{8}$ or less	$2\frac{1}{16}$ $16\frac{1}{2}t$	$1\frac{1}{32}$ $8\frac{1}{4}t$	$2\frac{3}{8}$ $18\frac{1}{2}t + \frac{3}{16}$	$1\frac{3}{16}$ $9\frac{3}{4}t + \frac{1}{32}$
P-No. 11; P-No. 25 to P-No. 21 or P-No. 22 or P-No. 25	$\frac{3}{8}$ $t = \frac{3}{8}$ or less	$2\frac{1}{2}$ $6\frac{2}{3}t$	$1\frac{3}{4}$ $3\frac{2}{3}t$	$3\frac{3}{8}$ $8\frac{2}{3}t + \frac{1}{8}$	$1\frac{13}{16}$ $4\frac{1}{3}t + \frac{1}{16}$
P-No. 51; P-No. 49	$\frac{3}{8}$ $t = \frac{3}{8}$ or less	3 $8t$	$1\frac{1}{2}$ $4t$	$3\frac{7}{8}$ $10t + \frac{1}{8}$	$1\frac{15}{16}$ $5t + \frac{1}{16}$
P-No. 52; P-No. 53; P-No. 61; P-No. 62	$\frac{3}{8}$ $t = \frac{3}{8}$ or less	$3\frac{3}{4}$ $10t$	$1\frac{7}{8}$ $5t$	$4\frac{5}{8}$ $12t + \frac{1}{8}$	$2\frac{5}{16}$ $6t + \frac{1}{16}$
All others with greater than or equal to 20% elongation	$\frac{3}{8}$ $t = \frac{3}{8}$ or less	$1\frac{1}{2}$ $4t$	$\frac{3}{4}$ $2t$	$2\frac{3}{8}$ $6t + \frac{1}{8}$	$1\frac{3}{16}$ $3t + \frac{1}{16}$
All others with less than 20% elongation	$t =$ (see Note b)	$32\frac{7}{8}t$ max.	$16\frac{7}{16}t$ max.	$34\frac{7}{8}t + \frac{1}{16}$ max.	$17\frac{7}{16}t + \frac{1}{32}$ max.

Procedure Qualification – Testing

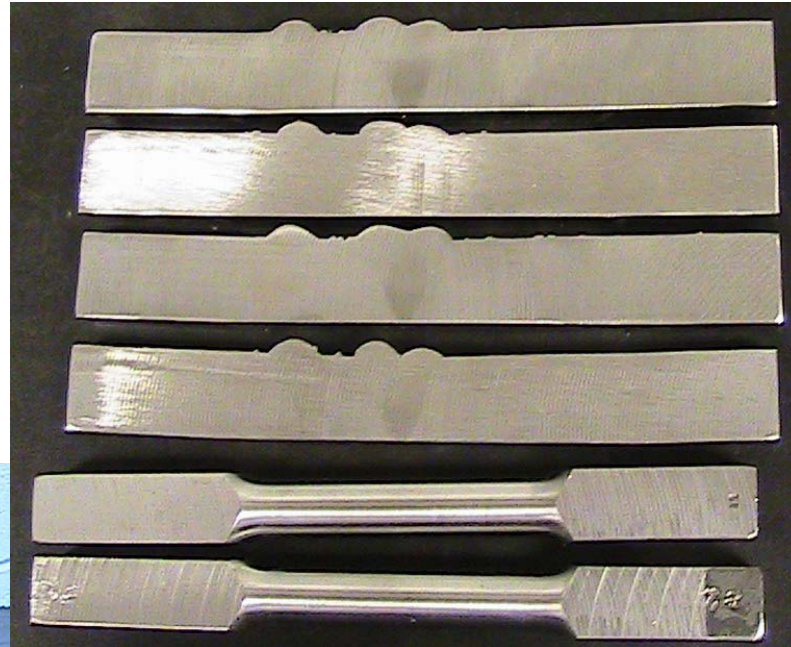
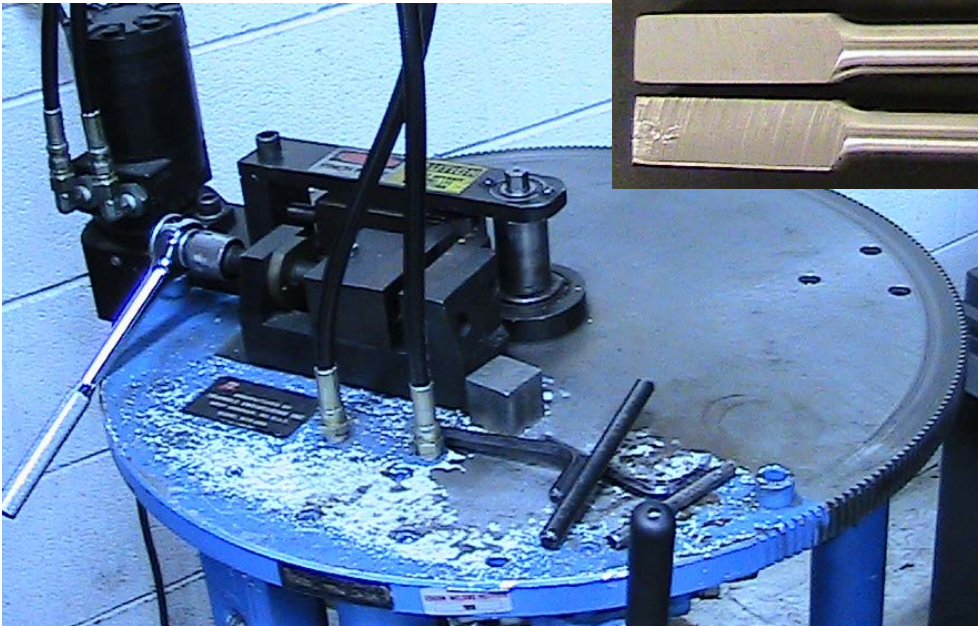

Procedure Qualification – Testing

Tensile Test (QW-150)						
Specimen No.	Width	Thickness	Area	Ultimate Load, lb	Ultimate Stress, psi	Type of Failure and Location
Tensile 1						
Tensile 2						

- The tensile strength must exceed 58 ksi

Guided-Bend Test (QW-160)	
Type	Results
Side Bend 1	
Side Bend 2	
Side Bend 3	
Side Bend 4	

- No open weld or HAZ discontinuity greater than 1/8-in.

Welding Procedure Specification (WPS)

QW-482 SUGGESTED FORMAT FOR WELDING PROCEDURE SPECIFICATIONS (WPS)
(See QW-200.1, Section IX, ASME Boiler and Pressure Vessel Code)

Company Name _____ By _____
 Welding Procedure Specification No. _____ Date _____ Supporting PQR No.(s) _____
 Revision No. _____ Date _____

Welding Process(es) _____ Type(s) _____
(Automatic, Manual, Machine, or Semi-Automatic)

JOINTS (QW-402) Details

Joint Design _____
 Backing: Yes _____ No _____
 Backing Material (Type) _____
(Refer to both backing and restream)

Metal Nonfusing Metal
 Nonmetallic Other

Sketches, Production Drawings, Weld Symbols, or Written Description should show the general arrangement of the parts to be welded. Where applicable, the root spacing and the details of weld groove may be specified.

[At the option of the Manufacturer, sketches may be attached to illustrate joint design, weld layers, and bead sequence (e.g., for notch toughness procedures, for multiple process procedures, etc.)]

***BASE METALS (QW-403)**

P-No. _____ Group No. _____ to P-No. _____ Group No. _____
 OR
 Specification Type and Grade _____
 to Specification Type and Grade _____
 OR
 Chem. Analysis and Mech. Prop. _____
 to Chem. Analysis and Mech. Prop. _____
 Thickness Range: _____
 Base Metal: Groove _____ Fillet _____
 Other _____

***FILLER METALS (QW-404)**

Spec. No. (SFA) _____			
AWS No. (Class) _____			
F-No. _____			
A-No. _____			
Size of Filler Metals _____			
Weld Metal			
Thickness Range:			
Groove _____			
Fillet _____			
Electrode-Flux (Class) _____			
Flux Trade Name _____			
Consumable Insert _____			
Other _____			

*Each base metal-filler metal combination should be recorded individually.

QW-482 (Back)

WPS No. _____ Rev. _____

<p>POSITIONS (QW-405) Position(s) of Groove _____ Welding Progression: Up _____ Down _____ Position(s) of Fillet _____</p> <p>PREHEAT (QW-406) Preheat Temperature, Minimum _____ Interpass Temperature, Maximum _____ Preheat Maintenance _____ (Continuous or special heating, where applicable, should be recorded)</p> <p>ELECTRICAL CHARACTERISTICS (QW-408) Current, AC or DC _____ Polarity _____ Amps (Range) _____ Volts (Range) _____ (Amps and volts range should be recorded for each electrode size, position, and thickness, etc. This information may be listed in a tabular form similar to that shown below.)</p> <p>Tungsten Electrode Size and Type _____ <small>(Rus Tungsten, 2% Thoriated, etc.)</small></p> <p>Mode of Metal Transfer for GMAW _____ <small>(Shielded Arc, Short Circuiting Arc, etc.)</small></p> <p>Electrode Wire Feed Spool Range _____</p> <p>TECHNIQUE (QW-410) String Or Weave Bead _____ Orifice or Gas Cup Size _____ Initial and Interpass Cleaning (Brushing, Grinding, etc.) _____</p> <p>Method of Back Gouging _____ Oscillation _____ Contact Tube to Work Distance _____ Multiple or Single Pass (Per Side) _____ Multiple or Single Electrodes _____ Travel Speed (Range) _____ Peening _____ Other _____</p>	<p>POSTWELD HEAT TREATMENT (QW-407) Temperature Range _____ Time Range _____</p> <p>GAS (QW-409)</p> <table style="width: 100%; border-collapse: collapse;"> <thead> <tr> <th rowspan="2"></th> <th colspan="3">Percent Composition</th> </tr> <tr> <th>Gas(es)</th> <th>(Mixture)</th> <th>Flow Rate</th> </tr> </thead> <tbody> <tr> <td>Shielding</td> <td>_____</td> <td>_____</td> <td>_____</td> </tr> <tr> <td>Trailing</td> <td>_____</td> <td>_____</td> <td>_____</td> </tr> <tr> <td>Backing</td> <td>_____</td> <td>_____</td> <td>_____</td> </tr> </tbody> </table>		Percent Composition			Gas(es)	(Mixture)	Flow Rate	Shielding	_____	_____	_____	Trailing	_____	_____	_____	Backing	_____	_____	_____			
	Percent Composition																						
	Gas(es)	(Mixture)	Flow Rate																				
Shielding	_____	_____	_____																				
Trailing	_____	_____	_____																				
Backing	_____	_____	_____																				
<table border="1" style="width: 100%; border-collapse: collapse;"> <thead> <tr> <th rowspan="2">Weld Layer(s)</th> <th rowspan="2">Process</th> <th colspan="2">Filler Metal</th> <th colspan="2">Current</th> <th rowspan="2">Volt Range</th> <th rowspan="2">Travel Speed Range</th> <th rowspan="2">Other (e.g., Remarks, Comments, Hot Wire Addition, Technique, Torch Angle, etc.)</th> </tr> <tr> <th>Class</th> <th>Diameter</th> <th>Type/ Polarity</th> <th>Amp Range</th> </tr> </thead> <tbody> <tr> <td> </td> <td> </td> <td> </td> <td> </td> <td> </td> <td> </td> <td> </td> <td> </td> <td> </td> </tr> </tbody> </table>		Weld Layer(s)	Process	Filler Metal		Current		Volt Range	Travel Speed Range	Other (e.g., Remarks, Comments, Hot Wire Addition, Technique, Torch Angle, etc.)	Class	Diameter	Type/ Polarity	Amp Range									
Weld Layer(s)	Process			Filler Metal		Current					Volt Range	Travel Speed Range	Other (e.g., Remarks, Comments, Hot Wire Addition, Technique, Torch Angle, etc.)										
		Class	Diameter	Type/ Polarity	Amp Range																		

(1108)

Welding Procedure Specification

- Qualified welding procedures are based on the PQR
 - The number of welding procedures
 - The range of variables

Company Name:	Nuclear Construction		
By:	Joe Welder		
WPS No.:	NRC-WPS-1	Date:	June 8 and 9, 2010
Supporting PQR No.(s)	NRC-PQR-1		

Welding Procedure – Welding Process Variable

Paragraph		Brief of Variables	Essential	Sup. Essential	Nonessential
QW-410 Technique	.25	φ Manual or Automatic			X

Procedure Qualification Record	
Welding Process:	GTAW and GMAW
Types (Manual, Automatic, Semi-Automatic):	Manual

Welding Procedure Specification	
Welding Process:	
Types (Manual, Automatic, Semi-Automatic):	

Welding Procedure – Joint Variables

Paragraph		Brief of Variables	Essential	Sup. Essential	Nonessential
QW-402 Joints	.1	φ Groove Design			X
	.4	- Backing			X
	.10	φ Root Spacing			X
	.11	± Retainers			X

Procedure Qualification Record

Joints (QW-402):

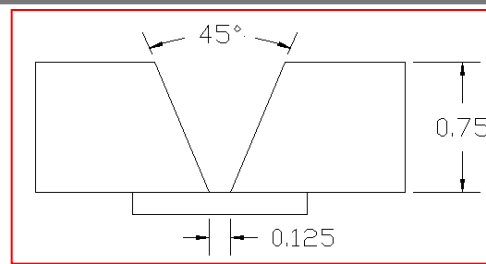

Welding Procedure Specification

Joint Design:	
Backing:	
Backing Material:	
Root Spacing:	
Retainers:	

Welding Procedure – Base Material Variables

Paragraph		Brief of Variables	Essential	Sup. Essential	Nonessential
QW-403 Base Materials	.5	φ Group No.		X	
	.11	φ P-No. Qualified	X		

Procedure Qualification Record

Material Spec.:	SA-36
Type or Grade:	N/A
P-No. and Group No.:	P-No. 1 Group No. 1 to P-No.1 Group No. 1
UNS No.:	K02600

Welding Procedure Specification

P-No. and Group No.:	
<u>OR</u>	
Specification/Type/Grade or UNS No.:	
<u>OR</u>	
Chemical and Mechanical Properties:	

Welding Procedure – Base Material Variables

Paragraph		Brief of Variables	Essential	Sup. Essential	Nonessential
QW-403 Base Materials	.8	φ T Qualified	X		

- QW-403.8 describes how to determine the qualified base material thickness range
 - Table QW-451

Thickness of Test Coupon (T)	Range of Thickness (T) Qualified	
	Min.	Max.
1/16-in. to 3/8-in.	1/16-in.	2T
> 3/8-in. but < 3/4-in.	3/16-in.	2T
3/4-in. to < 1 1/2-in.	3/16-in.	2T
1 1/2-in. to 6-in.	3/16-in.	8-in.

- Note (3) of Table QW-451 calls out QW-202.2 which defines thickness ranges for fillet welds when qualifying with a groove weld
 - ◆ All material thicknesses when depositing fillet welds

Welding Procedure – Base Material Variables

Paragraph		Brief of Variables	Essential	Sup. Essential	Nonessential
QW-403 Base Materials	.6	T Limits		X	
	.9	t pass > ½-in.	X		
	.10	T Limits (S. Cir. Arc)	X		

- QW-403.6, QW-403.9 and QW-403.10 limit the qualified thickness range
 - QW-403.6 limits the minimum thickness to T or 5/8-in. which ever is less or when $T < 1/4$ -in. minimum thickness is $1/2T$
 - ◆ Does not apply when PWHT is above upper transformation temperature or when austenitic material is solution annealed
 - QW-403.9 limits the maximum thickness to $1.1T$ when any single weld pass greater than 1/2-in.
 - QW-403.10 limits maximum thickness to $1.1T$ when the qualification thickness is less than 1/2-in. when welding with short circuit GMAW

Welding Procedure – Base Material Variables

Procedure Qualification Record

Thickness of Test Coupon:

0.75-in.

Other:

3. All passes were less than ½-in. thick

Welding Procedure Specification

Thickness Range for Groove Welds:

Thickness Range for Fillet Welds:

Maximum Pass Thickness \leq 1/2-in.:

Welding Procedure – Filler Metal Variables

Paragraph		Brief of Variables	Essential	Sup. Essential	Nonessential
QW-404 Filler Metals	.4	φ F-No.	X		
	.12	φ Classification		X	
	.33	φ Classification			X

Procedure Qualification Record

	GTAW	GMAW
SFA Classification:	SFA 5.28	SFA 5.18
AWS Classification:	ER80S-D2	ER70S-6
F-No.:	6	6

Welding Procedure Specification

	GTAW	GMAW
SFA Classification:		
AWS Classification:		
F-No.:		

Welding Procedure – Filler Metal Variables

Paragraph		Brief of Variables	Essential	Sup. Essential	Nonessential
QW-404 Filler Metals	.3	φ Size			X
	.5	φ A-No.	X		
	.6	φ Diameter			X

Procedure Qualification Record

	GTAW	GMAW
A-No.:	11	1
Size of Filler Metal:	1/8-in.	0.035-in.

Welding Procedure Specification

	GTAW	GMAW
A-No.:		
Size of Filler Metal:		

Welding Procedure – Filler Metal Variables

Paragraph		Brief of Variables	Essential	Sup. Essential	Nonessential
QW-404 Filler Metals	.14	± Filler	X		
	.23	φ Filler Metal Product Form	X		
	.24	± or φ Supplemental	X		
	.27	φ Alloy Elements	X		

Procedure Qualification Record

	GTAW	GMAW
Filler Metal Product Form:	Solid Wire	Solid Wire
Supplemental Filler Metal:	N/A	None Used

Welding Procedure Specification

	GTAW	GMAW
Filler Metal Product Form:		
Size of Filler Metal:		

Welding Procedure – Filler Metal Variables

Paragraph		Brief of Variables	Essential	Sup. Essential	Nonessential
QW-404 Filler Metal	.30	ϕt	X		
	.32	t limits (S.C. Arc)	X		

- QW-404.30 describes how to determine the qualified weld thickness range
 - Table QW-451
- QW-404.32 limits the maximum weld thickness to $1.1t$ when qualifying short circuit GMAW on 1/2-in. thick material

Thickness of Test Coupon (T)	Maximum Weld Thickness (t) Qualified
1/16-in. to 3/8-in.	$2t$
> 3/8-in. but < 3/4-in.	$2t$
3/4-in. to < 1 1/2-in.	$2t$
$t \geq 1\frac{1}{2}$ -in. to 6-in.	$2t$ when $t < 3/4$ -in. or 8-in. when $t \geq 3/4$ -in.

- Note (3) of Table QW-451 calls out QW-202.2 which defines fillet weld sizes when qualifying with a groove weld
 - ◆ All fillet weld sizes

Welding Procedure – Filler Metal Variables

Procedure Qualification Record		
	GTAW	GMAW
Weld Thickness:	1/4-in.	1/2-in.

Welding Procedure Specification		
	GTAW	GMAW
Maximum Weld Thickness for Groove Welds:		
Maximum Weld Thickness for Fillet Welds:		

Welding Procedure – Filler Metal Variables

Paragraph		Brief of Variables	Essential	Sup. Essential	Nonessential
QW-404 Filler Metal	.22	± Consumable Insert			X
	.50	± Flux			X

Procedure Qualification Record

	GTAW	GMAW
Electrode/Flux:	N/A	N/A
Flux Type:	N/A	N/A
Flux Trade Name;	N/A	N/A
Consumable Insert:	None Used	N/A

Welding Procedure Specification

	GTAW	GMAW
Electrode/Flux:		
Flux Type:		
Flux Trade Name:		
Consumable Insert:		

Welding Procedure – Position Variables

Paragraph		Brief of Variables	Essential	Sup. Essential	Nonessential
QW-405 Positions	.1	+ Position			X
	.2	φ Position		X	
	.3	φ ↑↓ Vertical Welding			X

- QW-405.2 limits the welding position by not including vertical-uphill progression
 - ◆ Does not apply when PWHT is above upper transformation temperature or when austenitic material is solution annealed

Procedure Qualification Record

Position of Groove:	Flat
Weld Progression:	N/A

Welding Procedure Specification

Position(s) of Groove:	
Weld Progression:	
Position(s) of Fillet:	

Welding Procedure – Preheat Variables

Paragraph		Brief of Variables	Essential	Supplementary Essential	Nonessential
QW-406 Preheat	.1	Decrease > 100°F	X		
	.2	φ Preheat Maintenance			X
	.3	Increase >100°F (IP)		X	

Procedure Qualification Record

Preheat Temperature:	Ambient (70°F)
Interpass Temperature:	450°F

Welding Procedure Specification

Minimum Preheat Temperature:	
Maximum Interpass Temperature:	
Preheat Maintenance:	

Welding Procedure – PWHT Variables

Paragraph		Brief of Variables	Essential	Sup. Essential	Nonessential
QW-407 PWHT	.1	φ PWHT	X		
	.2	φ PWHT (T & T range)		X	
	.4	T Limits	X		

Procedure Qualification Record

Temperature:

None

Time:

None

Welding Procedure Specification

Temperature Range:

Time Range:

Welding Procedure – Gas Variables

Paragraph		Brief of Variables	Essential	Sup. Essential	Nonessential
QW-408 Gas	.2	φ Single, Mixture or %	X		
	.3	φ Flow Rate			X

Procedure Qualification Record			
	Percent Composition		
	Gas(es)	Mixture	Flow Rate
Shielding:	GTAW – Argon	100%	15 – 25 cfh
	GMAW – Argon/CO ₂	75%/25%	25 – 35 cfh

Welding Procedure Specification			
	Percent Composition		
	Gas(es)	Mixture	Flow Rate
Shielding:			

Welding Procedure – Gas Variables

Paragraph		Brief of Variables	Essential	Sup. Essential	Nonessential
QW-408 Gas	.1	± Trail or φ Composition			X
	.5	± or φ Backing Gas			X
	.9	- Backing or φ Composition	X		
	.10	φ Shielding or Trailing	X		

Procedure Qualification Record			
	Percent Composition		
	Gas(es)	Mixture	Flow Rate
Trailing:	None Used	None Used	None Used
Backing:	None Used	None Used	None Used

Welding Procedure Specification			
	Percent Composition		
	Gas(es)	Mixture	Flow Rate
Trailing:			
Backing:			

Welding Procedure – Electrical Characteristics Variables

Paragraph		Brief of Variables	Essential	Sup. Essential	Nonessential
QW-409 Electrical Characteristics	.1	> Heat Input		X	
	.2	φ Transfer Mode	X		
	.3	± Pulsing I			X

Procedure Qualification Record		
	GTAW	GMAW
Heat Input:	45 kJ/in.	45 kJ/in.
Transfer Mode:	N/A	Globular
Pulsing Current:	None Used	N/A

Welding Procedure Specification		
	GTAW	GMAW
Maximum Heat Input:		
Transfer Mode:		
Pulsing Current:		

Welding Procedure – Electrical Characteristics Variables

Paragraph		Brief of Variables	Essential	Sup. Essential	Nonessential
QW-409 Electrical Characteristics	.4	φ Current or Polarity		X	X
	.8	φ I or E Range			X
	.12	φ Tungsten Electrode			X

Procedure Qualification Record

Weld Pass	Process	Filler Metal		Current		Volts	Travel Speed
		Class.	Dia.	Type/Polarity	Amps		
1-3	GTAW	ER80S-D2	1/8-in.	DCEP	175 – 200	10 – 14	Not Recorded
4-10	GMAW	ER70S-6	0.035-in.	DCEN	170 – 200	24 – 28	Not Recorded
Other:		2% Ceriated Tungsten was used					

Welding Procedure – Electrical Characteristics Variables

Procedure Qualification Record							
Weld Pass	Process	Filler Metal		Current		Volts	Travel Speed
		Class.	Dia.	Type/Polarity	Amps		
1-3	GTAW	ER80S-D2	1/8-in.	DCEP	175 – 200	10 – 14	1-5
4-10	GMAW	ER70S-6	0.035-in.	DCEN	170 – 200	24 – 28	1-5
Other:		2% Ceriated Tungsten was used					

Procedure Qualification Record							
Weld Pass	Process	Filler Metal		Current		Volts	Travel Speed
		Class.	Dia.	Type/Polarity	Amps		
Other:							

Welding Procedure – Technique Variables

Paragraph		Brief of Variables	Essential	Sup. Essential	Nonessential
QW-410 Technique	.1	φ Stringer/Weave			X
	.3	φ Orifice, Cup or Nozzle Size			X
	.5	φ Method of Cleaning			X

Procedure Qualification Record		
	GTAW	GMAW
Stringer or Weave:	Stringer	Stringer
Orifice, Nozzle, or Gas Cup:	5/8-in.	1-in.
Method of Cleaning:	Wire Brush	Wire Brush

Welding Procedure Specification		
	GTAW	GMAW
Stringer or Weave:		
Orifice, Nozzle, or Gas Cup:		
Method of Cleaning:		

Welding Procedure – Technique Variables

Paragraph		Brief of Variables	Essential	Sup. Essential	Nonessential
QW-410 Technique	.7	φ Oscillation			X
	.8	φ Tube-work Distance			X
	.9	φ Multiple to Single Pass/Side		X	X

Procedure Qualification Record		
	GTAW	GMAW
Oscillation:	None Used	None Used
Tube-work Distance:	N/A	1/2 – 3/4-in.
Multiply or Single Pass per Side:	Multiply Pass	Multiply Pass

Welding Procedure Specification		
	GTAW	GMAW
Oscillation:		
Tube-work Distance:		
Multiply or Single Pass per Side:		

Welding Procedure – Technique Variables

Paragraph		Brief of Variables	Essential	Sup. Essential	Nonessential
QW-410 Technique	.6	φ Method of Back Gouging			X
	.10	φ Single to Multiple Electrodes		X	X
	.11	φ Closed to Out Chamber	X		
	.15	φ Electrode Spacing			X

Procedure Qualification Record

	GTAW	GMAW
Multiple or Single Electrodes:	Single	Single
Method of Back Gouging:	None Used	None Used
Closed to Out Chamber:	Out of Chamber	N/A

Welding Procedure Specification

	GTAW	GMAW
Multiple or Single Electrodes:		
Method of Back Gouging:		
Closed to Out Chamber:		

Welding Procedure – Technique Variables

Paragraph		Brief of Variables	Essential	Sup. Essential	Nonessential
QW-410 Technique	.26	± Peening			X
	.64	Use of Thermal Processes	X		

Procedure Qualification Record		
	GTAW	GMAW
Peening:	None Used	None Used
Thermal Processing:	None Used	None Used

Welding Procedure Specification		
	GTAW	GMAW
Peening:		
Thermal Processing:		

Welder Qualification

Module 7B

Welder Qualification

- Primary purpose for performance qualification
 - To verify the ability of an individual to execute a qualified welding procedure specification to produce a sound weld

- Welders can be qualified by visual inspection and destructive testing or radiographic inspection

- Welders qualify to specific welding process NOT welding procedures
 - All variables are essential
 - Machine welding is considered a different welding process

Welder Qualification – Test Requirements

QW-452.1(a) TEST SPECIMENS

Thickness of Weld Metal, in. (mm)	Type and Number of Examinations and Test Specimens Required			
	Visual Examination per QW-302.4	Side Bend QW-462.2 [Note (1)]	Face Bend QW-462.3(a) or QW-462.3(b) [Notes (1), (2)]	Root Bend QW-462.3(a) or QW-462.3(b) [Notes (1), (2)]
Less than $\frac{3}{8}$ (10)	X	...	1	1
$\frac{3}{8}$ (10) to less than $\frac{3}{4}$ (19)	X	2 [Note (3)]	Note (3)	Note (3)
$\frac{3}{4}$ (19) and over	X	2

- Visual examination acceptance criteria
 - Weld should show complete penetration and fusion
- Bend test acceptance criteria
 - No open discontinuities in the weld or HAZ greater than 1/8-in.

Welder Qualification – Test Requirements

- Radiographic acceptance criteria
 - Linear Indications
 - ◆ Any type of crack, incomplete fusion, or incomplete penetration
 - ◆ Elongated slag with a length greater than
 - 1/8-in. for t equal to 3/8-in. or less
 - 1/3t for t over 3/8-in. up to 2 1/4-in.
 - 3/4-in. for t over 2 1/4-in.
 - ◆ Group slag should have an aggregate length no greater than t in a 12t length
 - Exception is when the distance between successive imperfections is 6L where L is the length on the longest imperfection
 - Rounded Indications
 - ◆ Maximum dimension shall be 20% of t or 1/8-in. whichever is smaller
 - ◆ For material less than 1/8-in only 12 rounded indications can be present per 6-in. of weld
 - ◆ For material greater 1/8-in. and greater the acceptance criteria is provided in Appendix I
 - Characterization charts

Welder Qualification – Test Requirements

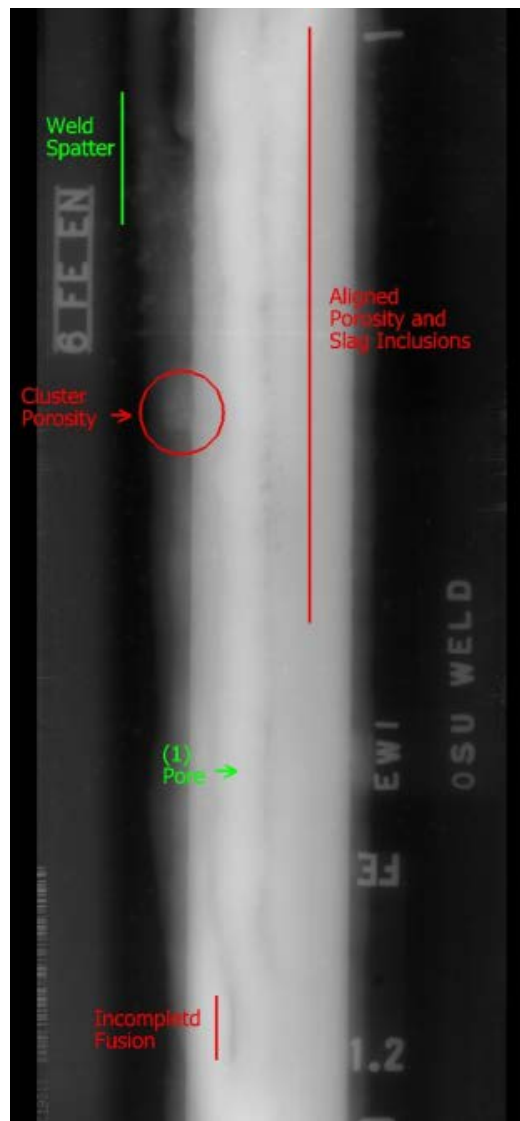

Welder Qualification – Essential Variables

QW-355
SEMI-AUTOMATIC GAS METAL-ARC
WELDING (GMAW)
[This Includes Flux-Cored Arc Welding (FCAW)]
Essential Variables

Paragraph		Brief of Variables
QW-402 Joints	.4	– Backing
QW-403 Base Metals	.16	ϕ Pipe diameter
	.18	ϕ P-Number
QW-404 Filler Metals	.15	ϕ F-Number
	.30	ϕ t Weld deposit
	.32	t Limit (S. Cir. Arc.)
QW-405 Positions	.1	+ Position
	.3	ϕ $\uparrow\downarrow$ Vertical welding
QW-408 Gas	.8	– Inert backing
QW-409 Electrical	.2	ϕ Transfer mode

QW-356
MANUAL AND SEMIAUTOMATIC GAS
TUNGSTEN-ARC WELDING (GTAW)
Essential Variables

Paragraph		Brief of Variables
QW-402 Joints	.4	– Backing
QW-403 Base Metals	.16	ϕ Pipe diameter
	.18	ϕ P-Number
QW-404 Filler Metals	.14	\pm Filler
	.15	ϕ F-Number
	.22	\pm Inserts
	.23	ϕ Solid or metal-cored to flux-cored
	.30	ϕ t Weld deposit
QW-405 Positions	.1	+ Position
	.3	ϕ $\uparrow\downarrow$ Vertical welding
QW-408 Gas	.8	– Inert backing
QW-409 Electrical	.4	ϕ Current or polarity

GTAW and GMAW Welder Qualification – Variables

- QW-402.4 states the deletion of backing is essential
 - Welders were qualified with backing so they are only allowed to weld on backing
- QW-403.16 states a change in the pipe diameter qualified is essential
 - Welders were qualified on plate so they can only weld on plate
- QW-403.18 states a change in the P-No. material qualified is essential
 - Welders were qualified on P-No. 1 material so they are qualified to weld P-No. 1 through P-No. 15F, P-No. 34, and P-No. 41 through P-No. 49
 - ◆ All types of carbon and low-alloy steel, Cr-Mo steels, nickel steel, duplex stainless steels, and Nickel and nickel-based alloys

GTAW and GMAW Welder Qualification – Variables

- QW-404.14 is for GTA welders only and states a change between using filler metal or not using filler metal is essential
 - Welders were qualified with filler metal so they are only allowed to weld with filler metal
- QW-404.15 states a change in F-No. is essential
 - Welders were qualified with F-No. 6 so they are only allowed to weld with F-No. 6
- QW-404.22 is for GTA welders only and states a change between using a consumable insert or not using consumable insert is essential
 - Welders were qualified without a consumable insert so they are only allowed to weld without a consumable insert

GTAW and GMAW Welder Qualification – Variables

- QW-404.23 is for GTA welders only and states a change in the type of filler metal is essential
 - Welders were qualified using a solid wire so they can only weld with a solid wire
- QW-404.30 states a change in the weld metal thickness qualified is essential
 - Welders deposited 1/4-in. GTA weld and 1/2-in. of GMA weld so they are qualified to deposit an 1/2-in. GTA weld and unlimited GMA weld

QW-452.1(b)

THICKNESS OF WELD METAL QUALIFIED

Thickness, t , of Weld Metal in the Coupon, in. (mm) [Notes (1) and (2)]	Thickness of Weld Metal Qualified [Note (3)]
All $\frac{1}{2}$ (13) and over with a minimum of three layers	$2t$ Maximum to be welded

GTAW and GMAW Welder Qualification – Variables

- QW-404.32 is for GMA welders only and limits the weld thickness range for short circuit GMA welders
 - Welders were qualified using globular transfer so the variable does not apply
- QW-405.1 states a change in the position qualified is essential
 - Welders were qualified in the flat (1F) position so they can only weld in the 1F position
- QW-405.3 states a change in the weld direction for vertical weld is essential
 - Welders were qualified in the flat (1F) position so they can weld in the vertical direction

GTAW and GMAW Welder Qualification – Positions

Qualification Test		Position and Type Weld Qualified [Note (1)]		
		Groove		
		Plate and Pipe Over 24 in. (610 mm) O.D.	Pipe ≤ 24 in. (610 mm) O.D.	Fillet Plate and Pipe
Weld	Position			
Plate — Groove	1G	F	F [Note (2)]	F
	2G	F,H	F,H [Note (2)]	F,H
	3G	F,V	F [Note (2)]	F,H,V
	4G	F,O	F [Note (2)]	F,H,O
	3G and 4G	F,V,O	F [Note (2)]	All
	2G, 3G, and 4G	All	F,H [Note (2)]	All
	Special Positions (SP)	SP,F	SP,F	SP,F
Plate — Fillet	1F	F [Note (2)]
	2F	F,H [Note (2)]
	3F	F,H,V [Note (2)]
	4F	F,H,O [Note (2)]
	3F and 4F	All [Note (2)]
	Special Positions (SP)	SP,F [Note (2)]
	Pipe — Groove [Note (3)]	1G	F	F
2G		F,H	F,H	F,H
5G		F,V,O	F,V,O	All
6G		All	All	All
2G and 5G		All	All	All
Special Positions (SP)		SP,F	SP,F	SP,F

GTAW and GMAW Welder Qualification – Variables

- QW-408.8 states the omission of inert gas backing is essential
 - Welders were qualified with backing so the variable does not apply
- QW-409.2 is for GMA welders only and states a change in the transfer mode is essential
 - Welders were qualified using globular transfer so they can only weld with globular, spray or pulsed transfer modes
- QW-409.4 is for GTA welders only and states a change in the current and polarity is essential
 - Welders were qualified using DCEP so they can only weld using DCEP

Welder Qualification Requirements

- QW-320 covers the requirements for retesting and renewing welder qualification

- QW-322 Expiration and Renewal of Qualification
 - When the welder has not welded with the process within 6 months
 - When there is a specific reason to question his ability to make welds that met the specifications