

15205
KREEP-rich Breccia
337.3 grams

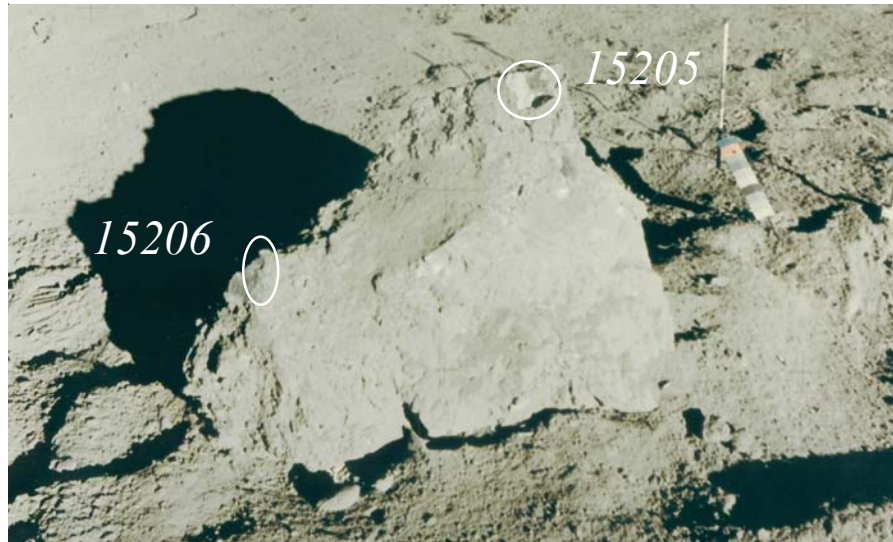

Figure 1: Boulder at station 2, from which both 15205 and 15206 were taken. AS15-86-11560. Meter-sized gnomon for scale.



Figure 2: Interior view of 15205,0. Sample is 6 cm. across. S87-50592.



Figure 3: Two views of the glass-coated surfaces of 15205 (5 out of 6 sides were glass coated). Sample is about 6 cm on a side. S71-42985 and S71-42982.

Introduction

Breccia sample 15205 was collected from the top of a small boulder on the edge of the Hadley Rille near St. George Crater (figure 1). The boulder is probably derived from a fresh, small crater part way down the side of the Rille (Swann et al. 1971, Spudis and Taylor 2009). 15205 is noteworthy in that it contains a high percentage of KREEP basalt fragments as clasts, but also contains fragments of the mafic green glass, and mare basalt found in the Apollo 15 regolith.

15205 has not been dated, but it has an exposure age of 169 m.y. It has a thin coating of vesicular glass on most surfaces, such that it must have broke free from the boulder along an interior glass vein. Micrometeorite craters on an exposed surface have been carefully studied.

Mineralogical Mode for 15205

(Simon et al. 1986)		
Matrix	50.4 %	
	20-90 micron	90-100 micron
Mare Basalt	0.2	2.6
KREEP Basalt	0.5	9
Feld. Basalt	0.2	0.3
Plutonic	0.2	3.6
Granulitic	0.1	
Breccia	0.4	0.3
Olivine	0.4	0.1
Pyroxene	15.4	2.4
Plagioclase	7.2	1.6
Opakes	1.6	
Glass	0.8	2
Agglutinate	0.1	0.2

Petrography

15205 is said to be a regolith breccia (Fruland 1983, McKay and Wentworth 1983), but it has very low I_s /FeO (McKay et al. 1989) and very low C content (Moore et al. 1973). It is clast rich and matrix poor with little evidence of clast-matrix interaction (figure 2). There is a pronounced fabric, but this has not been documented. Dymek et al. (1974) give the mode as about 75% clasts (~40% lithic, ~15% glass and ~20% mineral fragments). A more detailed mode is given in the table.

The thin glass coating on five out of six sides of 15205 is unusual. The glass on one side has delicate spikes that suggest that the boulder was seperated from a rock mass while still molten (Wilshire and Moore 1974). The glass on other sides is frothy (figure 3).

Aluminous KREEP basalt fragments are an important component of 15205 (see section of 15382). They have a wide range of texture (figure 4), but the pyroxenes follow a common trend (figures 5 and 6). Clasts of pyroxene-phyric mare basalt are also present (figure 7).

Mineralogy

Pyroxene: Takeda et al. (1980) and Dymek et al. (1974) determined the pyroxene composition of various basalt clasts (figures 5, 6, 8 and 9).

Glass: Dymek et al. (1974) determined the chemical composition of numerous glass fragments in 15205

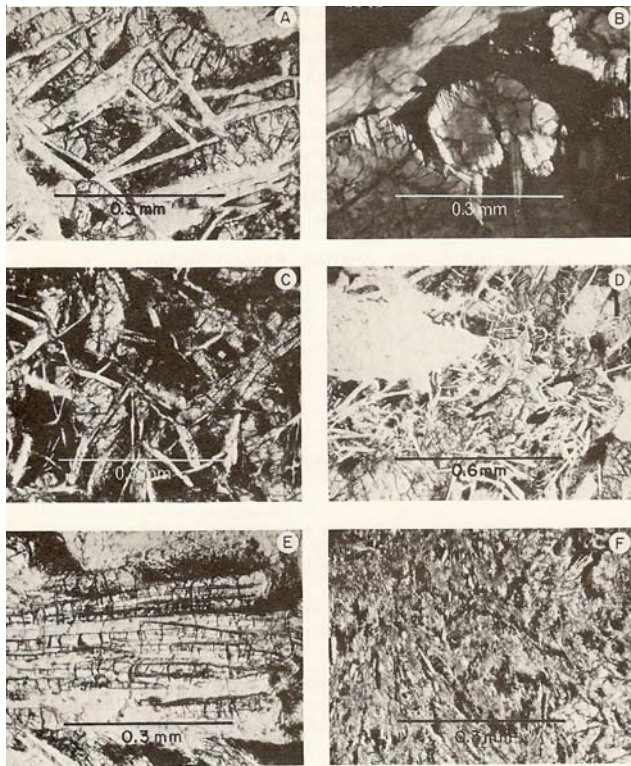

Figure 4: Textures of KREEP basalt clasts in 15205 (Dymek et al. 1974).

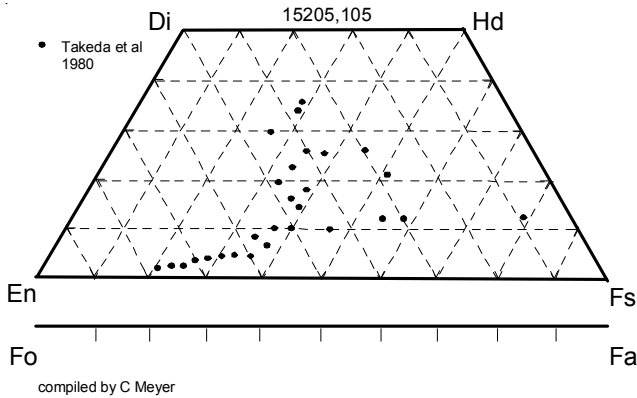

Figure 5: Pyroxene composition of a KREEP basalt clast in 15205 (Takeda et al. 1980).

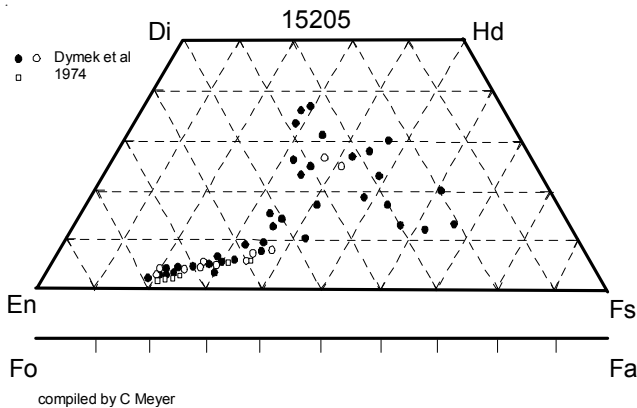

Figure 6: Pyroxene composition of a variety of KREEP basalt clasts in 15205 (Dymek et al. 1974).

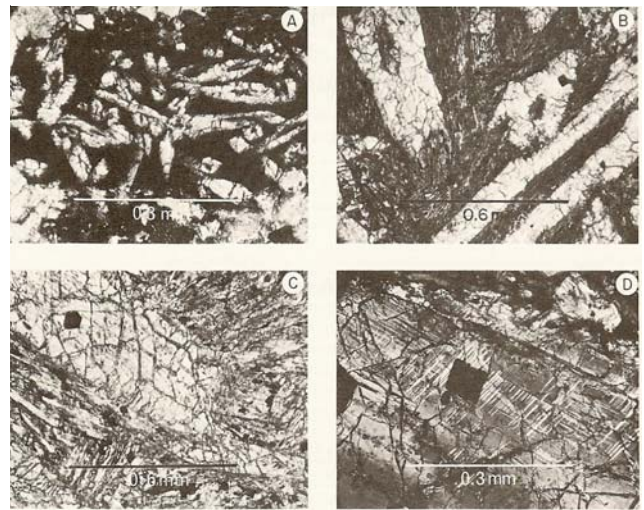

Figure 7: Textures of pyroxene-phyric basalt clasts in 15205 (Dymek et al. 1974).

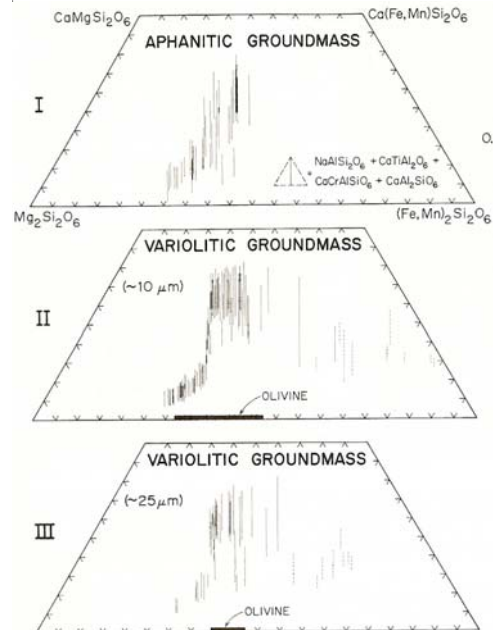

Figure 8: Pyroxene and olivine in pyroxene-phyric basalts in 15205 (Dymek et al. 1974).

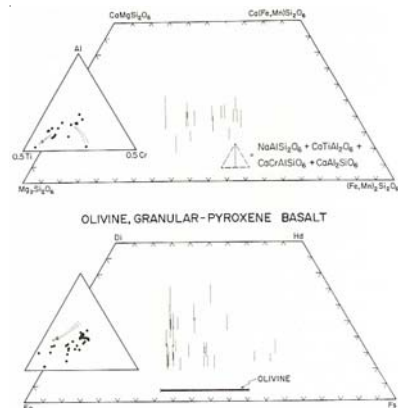

Figure 9: Pyroxene and olivine in mare basalt clasts in 15205 (Dymek et al. 1974).

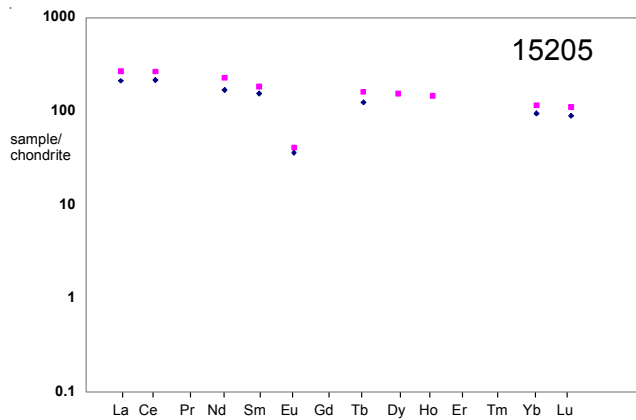

Figure 10: Normalized rare-earth-element diagram of 15205 (data from Simon et al, 1986 and McKay et al. 1989).

(figure 11). The mafic green glass is characteristic of the Apollo 15 soil (see section on 15425). However, the most abundant glass is an aluminous glass with high trace element content (termed KREEP glass).

Zircon: Andersen and Hinthorne (1973) used the ion probe to date a zircon in 15205 and determine its REE pattern.

Chemistry

Radiation counting showed that the bulk sample is very high in Th (Keith et al. (1972) and Rancitelli et al. 1972). The high Th is accompanied by high trace element content (figure 10).

Reed and Jovanovic (1972) determined the halogen content of 15205 and 15206. 15205 only has 22 ppm C (Moore et al. 1973).

Radiogenic age dating

Andersen and Hinthorne (1973) used the $^{207}\text{Pb}/^{206}\text{Pb}$ ion probe method to date a zircon in 15205 at 4.01 ± 0.11 b.y.

Cosmogenic isotopes and exposure ages

Keith et al. (1972), Rancitelli et al. (1972) and Fruchter et al. (1978) determined the cosmic-ray-induced activity of ^{26}Al , ^{22}Na , ^{46}Sc , ^{48}V , ^{54}Mn , ^{56}Co and ^{60}Co . Drozd et al. (1976) reported a ^{81}Kr exposure age of 169 m.y., but the sample has had a rather complicated exposure history (see discussion in Ryder 1985). Bhandari (1977) determined the number of solar flare tracks.

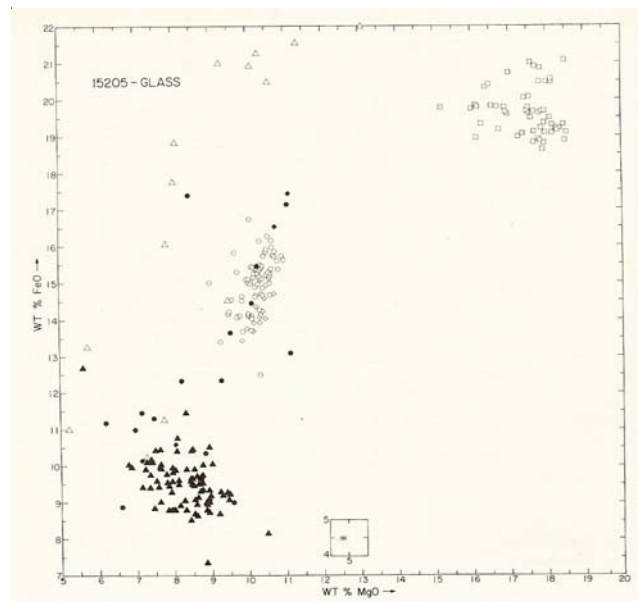

Figure 11: Chemical composition of glass in 15205 (Dymek et al. 1976). Filled triangles are KREEP glass, open squares are "green glass" and intermediate compositions are glass coatings and mare glasses.

Other Studies

The rare gas content and isotopic ratio of 15205 is reported in McKay et al. (1989). It has the lowest gas content of any of the Apollo 15 breccias studied, consistent with its low maturity index. Schaeffer et al. (1976) used a laser probe to determine He, ne and ar on exposed surfaces. Oxygen isotopes were reported by Epstein and Taylor (1972).

A detailed study of solar flare tracks in pyroxenes directly under micrometeorite craters in the glass on 15205 was conducted by Hartung and Storzer (1974) and Zook et al. (1976).

Adams and McCord (1972) and Charette and Adams (1977) determined reflectance spectra.

Processing

Lunar sample 15205 was the subject of a consortium study led by Wasserburg (but no age was determined except by ion probe!). Ryder (1985) gives an excellent summary.

Two external surfaces, at right angles to each other, were removed and slabbed (figures 14, 15 and 16). There are 52 thin sections.

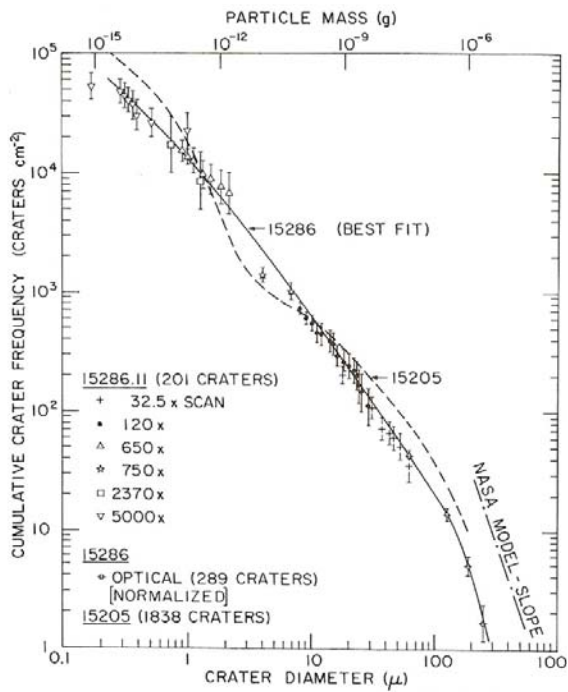

Figure 12: Size distribution of micrometeorite craters on surface of 15205 (Brownlee et al. 1973; Schneider et al. 1973).

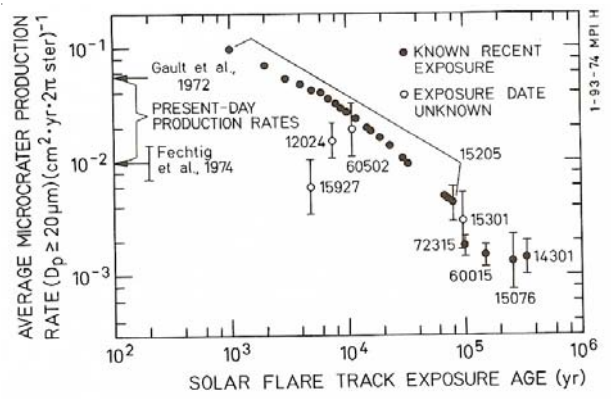

Figure 13: Summary of solar flare track data under micrometeorite craters (Hartung and Storzer 1974).

Table 1. Chemical composition of 15205.

reference weight	Keith72	Rancitelli72 334 g	Willis72	McKay89	Baedecker73	Simon86	Reed72
SiO ₂ %			51.03 (c)				
TiO ₂			1.99 (c)			1.9 (d)	
Al ₂ O ₃			14.92 (c)	13.2 (d)		14.9 (d)	
FeO			11.28 (c)	13.3 (d)		10.9 (d)	
MnO			0.16 (c)			0.156 (d)	
MgO			8.23 (c)	9.2 (d)		9.6 (d)	
CaO			9.94 (c)	8.9 (d)		9.8 (d)	
Na ₂ O			0.73 (c)	0.66 (d)		0.775 (d)	
K ₂ O	0.53	0.65 (a)	0.53 (c)			0.52 (d)	
P ₂ O ₅			0.56 (c)				
S %			0.08 (c)				
sum							
Sc ppm				28.5 (d)		22.5 (d)	
V						65 (d)	
Cr			2330 (c)	2770 (d)			
Co			(c)	30.2 (d)		23.1 (d)	
Ni				59 (d)	28 (b)	30 (d)	
Cu							
Zn					4.5 (b)		
Ga					5 (b)		
Ge ppb					84 (b)		
As							
Se							
Rb			14.4 (c)				
Sr			171 (c)	150 (d)		140 (d)	
Y			201 (c)				
Zr			979 (c)	710 (d)		820 (d)	
Nb			59.4 (c)				
Mo							
Ru							
Rh							
Pd ppb							
Ag ppb							
Cd ppb					16 (b)		
In ppb					2.6 (b)		
Sn ppb							
Sb ppb							
Te ppb							
Cs ppm				0.48 (d)			
Ba			673 (c)	500 (d)		640 (d)	
La				49.6 (d)		63 (d)	
Ce				131 (d)		160 (d)	
Pr							
Nd				76 (d)		103 (d)	
Sm				22.8 (d)		27 (d)	
Eu				2.02 (d)		2.3 (d)	
Gd							
Tb				4.54 (d)		5.9 (d)	
Dy						37.3 (d)	
Ho						8.1 (d)	
Er							
Tm						3.1 (d)	
Yb				15.5 (d)		19 (d)	
Lu				2.16 (d)		2.7 (d)	
Hf				18.5 (d)		20 (d)	
Ta				2.15 (d)		2.5 (d)	
W ppb							
Re ppb							
Os ppb							
Ir ppb				<3 (d)	0.14 (b)		
Pt ppb							
Au ppb				<4 (d)	0.41 (b)		
Th ppm	12	12.6 (a)		8 (d)		10.4 (d)	
U ppm	2.9	3.28 (a)		2.2 (d)		2.8 (d)	3.2

technique: (a) radiation counting, (b) RNAA, (c) XRF, (d) INAA



Figure 14: Group processing photo of piece (8) off of 15205. Metal tags are about 2 cm long. S72-15585.

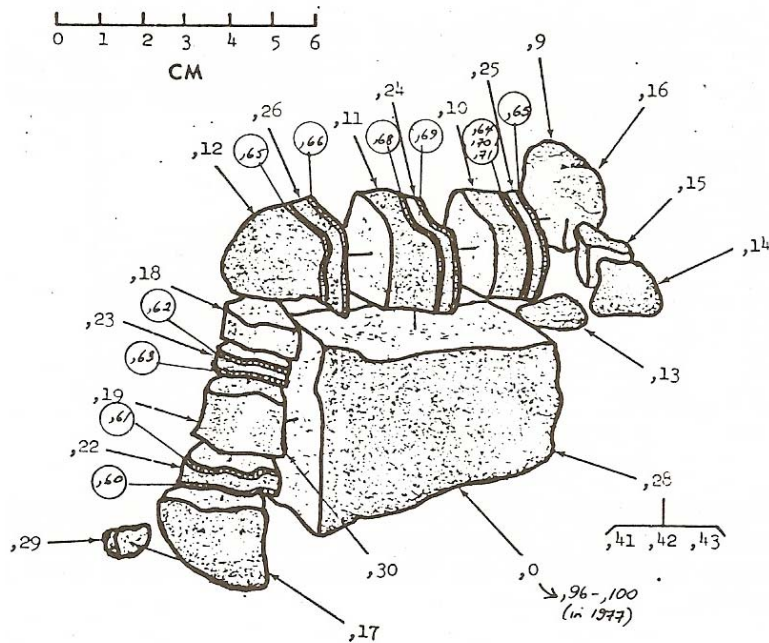
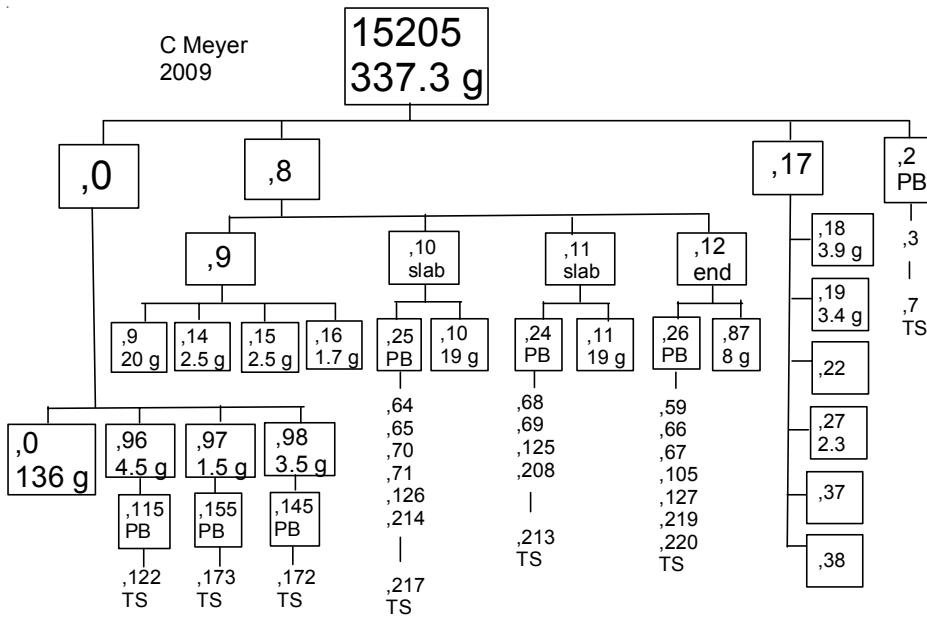



Figure 15: Interior surface of 15205. S87-50590. Scale in mm.

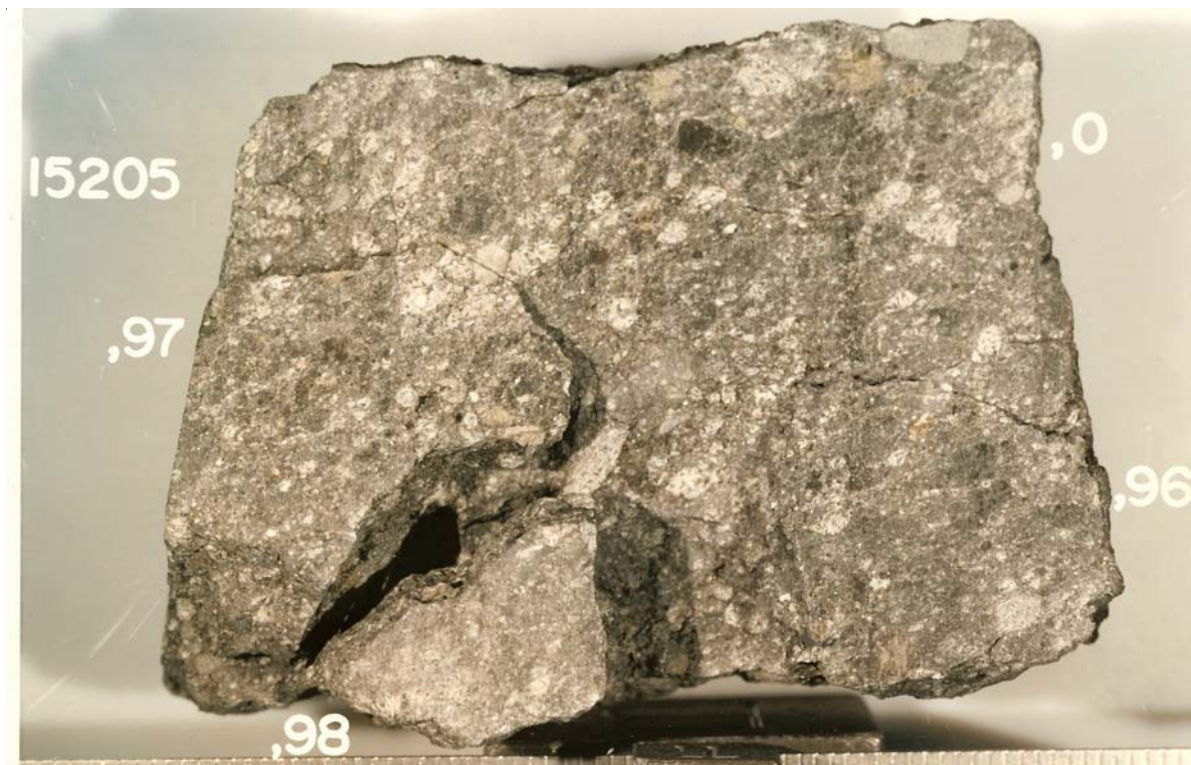

Figure 16: Interior surface of 15205. Scale in mm. S87-50591

References for 15205

- Adams J.B. and McCord T.B. (1972) Optical evidence for average pyroxene composition of Apollo 15 samples. In *The Apollo 15 Lunar Samples*, 10-13. Lunar Planetary Institute, Houston.
- Allen R.O., Jovanovic S. and Reed G.W. (1973) Geochemistry of primordial Pb, Bi and Zn in Apollo 15 samples. *Proc. 4th Lunar Sci. Conf.* 1169-1175.
- Andersen C.A. and Hinthorne J.R. (1973) 207Pb/206Pb ages and REE abundances in returned lunar materials by ion microprobe mass analysis (abs). *Lunar Sci. IV*, 37-42. Lunar Planetary Institute, Houston.
- Baedecker P.A., Chou C.-L., Grudewicz E.B. and Wasson J.T. (1974) Volatile and siderophile trace elements in Apollo 15 samples: Geochemical implications and characterization of the long-lived and short-lived extralunar materials. *Proc. 4th Lunar Sci. Conf.* 1177-1195.
- Bhandari N. (1977) Solar flare exposure ages of lunar rocks and boulders based on ²⁶Al. *Proc. 8th Lunar Sci. Conf.* 3607-3615.
- Brownlee D.E., Horz F., Vedder J.F., Gault D.E. and Hartung J.B. (1973) Some physical parameters of micrometeoroids. *Proc. 4th Lunar Sci. Conf.* 3197-3212.
- Butler P. (1971) Lunar Sample Catalog, Apollo 15. Curators' Office, MSC 03209
- Charette M.P. and Adams J.B. (1977) Spectral reflectance of lunar highland rocks (abs). *Lunar Sci. VIII*, 172-174. Lunar Planetary Institute, Houston.
- Drozd R.J., Kennedy B.M., Morgan C.J., Podosek F.A. and Taylor G.J. (1976) The excess fission xenon problem in lunar samples. *Proc. 7th Lunar Sci. Conf.* 599-623.
- Dymek R.F., Albee A.L. and Chodos A.A. (1974) Glass-coated soil breccia 15205: Selenologic history and petrologic constraints on the nature of its source region. *Proc. 5th Lunar Sci. Conf.* 235-260.
- Epstein S. and Taylor H.P. (1972) O¹⁸/O¹⁶, Si³⁰/Si²⁸, C¹³/C¹² and D/H studies of Apollo 14 and 15 samples. *Proc. 3rd Lunar Sci. Conf.* 1429-1454.
- Fruchter J.S., Rancitelli L.A., Evans J.C. and Perkins R.W. (1978) Lunar surface processes and cosmic ray histories over the past several million years. *Proc. 9th Lunar Planet. Sci. Conf.* 2019-2032.
- Fruiland R.M. (1983) Regolith Breccia Workbook. Curatorial Branch Publication # 66. JSC 19045.
- Hartung J.B. and Storzer D. (1974) Lunar microcraters and their solar flare track record. *Proc. 5th Lunar Sci. Conf.* 2527-2541.
- Keith J.E., Clark R.S. and Richardson K.A. (1972) Gamma-ray measurements of Apollo 12, 14 and 15 lunar samples. *Proc. 3rd Lunar Sci. Conf.* 1671-1680.
- McKay D.S. and Wentworth S.J. (1983) A petrographic survey of regolith breccias from the Apollo 15 and 16 collection (abs). *Lunar Planet. Sci. XIV*, 481-482. Lunar Planetary Institute, Houston.
- McKay D.S., Bogard D.D., Morris R.V., Korotev R.L., Wentworth S.J. and Johnson P. (1989) Apollo 15 regolith breccias: Window to a KREEP regolith. *Proc. 19th Lunar Sci. Conf.* 19-41. Lunar Planetary Institute, Houston.
- Moore C.B., Lewis C.F. and Gibson E.K. (1973) Total carbon contents of Apollo 15 and 16 lunar samples. *Proc. 4th Lunar Sci. Conf.* 1613-1923.
- Nagle J.S. (1982) Evidence of subcrater lithification and hot ejecta deposition in lunar polymict regolith breccias and achondrites (abs). *Lunar Planet. Sci. XIII*, 568-569.
- Nagle J.S. (1982) Subcrater lithification of polymict regolith breccias. *Proc. 13th Lunar Planet. Sci.* in *J. Geophys. Res.* 87, A131-A146.
- Rancitelli L.A., Perkins R.W., Felix W.D. and Wogman N.A. (1972) Lunar surface processes and cosmic ray characterization from Apollo 12-15 lunar samples analyses. *Proc. 3rd Lunar Sci. Conf.* 1681-1691.
- Ryder G. (1985) Catalog of Apollo 15 Rocks (three volumes). Curatorial Branch Pub. # 72, JSC#20787
- Schaeffer O.A., Plienger T. and Hartung J.B. (1976) Spatial distribution of rare gases in lunar breccia 15426 and the exposed surface of rock 15205 (abs). *Lunar Sci. VII*, 770-772.
- Schneider E., Storzer D., Hartung J.B., Fechtig H. and Genter W. (1973) Microcraters on Apollo 15 and 16 samples and corresponding cosmic dust fluxes. *Proc. 4th Lunar Sci. Conf.* 3277-3290.
- Simon S.B., Papike J.J., Grosselin D.C. and Laul J.C. (1986) Petrology of the Apollo 15 regolith breccias. *Geochim. Cosmochim. Acta* 50, 2675-2691.
- Sutton R.L., Hait M.H., Larson K.B., Swann G.A., Reed V.S. and Schaber G.G. (1972) Documentation of Apollo 15 samples. Interagency report: *Astrogeology* 47. U.S.G.S.

Spudis P. and Taylor G.J. (2009) A major KREEP-basalt – Mare basalt unconformity on the Moon (abs#1039). *Lunar Planet. Sci.* **XL**, Lunar Planetary Institute, The Woodlands.

Swann G.A., Hait M.H., Schaber G.C., Freeman V.L., Ulrich G.E., Wolfe E.W., Reed V.S. and Sutton R.L. (1971) Preliminary description of Apollo 15 sample environments. U.S.G.S. Interagency report: 36. pp219 with maps

Swann G.A., Bailey N.G., Batson R.M., Freeman V.L., Hait M.H., Head J.W., Holt H.E., Howard K.A., Irwin J.B., Larson K.B., Muehlberger W.R., Reed V.S., Rennilson J.J., Schaber G.G., Scott D.R., Silver L.T., Sutton R.L., Ulrich G.E., Wilshire H.G. and Wolfe E.W. (1972) 5. Preliminary Geologic Investigation of the Apollo 15 landing site. In Apollo 15 Preliminary Science Rpt. NASA SP-289. pages 5-1-112.

Takeda H., Miyamoto M. and Ishii T. (1980) Composition of basaltic clasts in lunar and eucrite polymict breccias. *Proc. 11th Lunar Planet. Sci. Conf.* 135-147.

Willis J.P., Erlank A.J., Gurney J.J. and Ahrens L.H. (1972) Geochemical features of Apollo 15 materials. In The Apollo 15 Lunar Samples (Chamberlain J.W. and Watkins C., eds.), 268-271. The Lunar Science Institute, Houston.

Wilshire H.G. and Moore H.J. (1974) Glass-coated lunar rock fragments. *J. Geol.* **82**, 403-417.

Zook H.A., Hartung J.B. and Storzer D. (1976) Solar flare activity record as derived from lunar microcrater data (abs). *Lunar Sci.* VII, 968-970. The Lunar Science Institute, Houston.