

The Equiangular Spiral Antenna*

JOHN D. DYSON†

Summary—A circularly polarized antenna is described which makes possible bandwidths that a few years ago were considered to be impossible.

The design of the antenna is based upon the simple fundamental principle that if the shape of the antenna were such that it could be specified entirely by angles, its performance would be independent of wavelength. Since all such shapes extend to infinity it is necessary to specify at least one length for an antenna of finite size. The one length in this antenna, the arm length, need only be of the order of one wavelength at the lowest frequency of operation to obtain operation essentially independent of frequency, and the geometry of the antenna allows this arm length to be spiraled into a maximum diameter of one half wavelength or less. Antennas have been constructed that have an essentially constant radiation pattern and input impedance over bandwidths greater than 20 to 1.

INTRODUCTION

ONE of the serious drawbacks to any simplified solution toward providing coverage of large portions of the frequency spectrum has been the extremely limited bandwidths obtainable with both the receiving and transmitting equipment and the antennas required to successfully launch and receive electromagnetic radiation. As a result, a great deal of effort has been expended in the development of broad-band equipment. This paper is concerned with the latter portion of the problem, the development of a broad-band antenna.

The term "broad-band" has been loosely applied in the past, but has usually described antennas whose radiation and input impedance characteristics were acceptable over, at most, a frequency range of 2 or 3 to 1. The bandwidth of the radiation pattern has been the limiting factor since antennas have been developed with an input impedance that stays relatively constant with a change in frequency.

Several really broad-band antennas have been proposed in recent years—the disccone by Kandoian,¹ the conical helix by Springer² and later by Chatterjee,³ the Archimedes spiral by Turner⁴ and the logarithmically periodic antenna by DuHamel and Isbell.⁵

* Manuscript received by the PGAP, June 16, 1958; revised manuscript received, December 11, 1958. This material was taken from a thesis submitted in partial fulfillment of the requirements for the Ph.D. degree in electrical engineering at the University of Illinois, 1957. A treatment in more detail is given in Tech. Rep. No. 21, Contract AF 33(616)-3220, Antenna Lab., University of Illinois, September 15, 1957. ASTIA No. AD-145019. This work was supported by the Wright Air Dev. Center under Contract No. AF 33(616)-3220.

† Antenna Lab., University of Illinois, Urbana, Ill.

¹ A. G. Kandoian, "Three new antenna types and their applications," Proc. IRE, vol. 34, pp. 70w-75w; February, 1946.

² P. S. Springer, "End-Loaded and Expanding Helices as Broad Band Circularly Polarized Radiators," Electronic Subdivision, USAF, Air Material Command, Wright-Patterson AFB, Tech. Rep. No. 6104; January, 1950.

³ J. S. Chatterjee, "Radiation field of a conical helix," *J. Appl. Phys.*, vol. 24, p. 550; May, 1953.

⁴ E. M. Turner, "Spiral Slot Antenna," Wright Air Dev. Center, Dayton, Ohio, Tech. Note WCLR-55-8; June, 1955.

⁵ R. H. DuHamel and D. E. Isbell, "Broadband logarithmically periodic antenna structures," 1957 IRE NATIONAL CONVENTION RECORD, pt. 1, pp. 119-128.

In the fall of 1954, Rumsey of the University of Illinois advanced the theory that an antenna constructed in the form of an equiangular spiral of infinite length would have an infinite pattern and impedance bandwidth, and proposed that the characteristics of the finite size structure be investigated. Subsequent investigation disclosed that the equiangular spiral antenna was the first antenna to exhibit, in a practical size, the characteristics associated with an infinite structure.^{6,7} Thus, it became the first of a class of antennas which may be called "frequency independent antennas."⁸ More recent work by DuHamel and Isbell has indicated that the logarithmically periodic structures which they have considered have as wide a practical bandwidth as the equiangular spiral. These structures however are linearly polarized while the spiral is a circularly polarized antenna.

This paper is concerned with some of the characteristics of, and design information for, the balanced planar equiangular spiral antenna.

DEFINITION OF THE ANTENNA

The design of the equiangular spiral antenna is based upon a simple fundamental principle. If all dimensions of a perfectly conducting antenna (immersed in lossless free space) are changed in linear proportion to a change in wavelength, the performance of the antenna is unchanged except for a change of scale in all measurements of length. Thus, as Rumsey has pointed out, it follows that if the shape of the antenna were such that it could be specified entirely by angles, its performance would be independent of frequency.

Since all such shapes extend to infinity it is necessary to specify at least one length in order to specify an antenna of finite size. This principle can be used as a basis for practical antenna design, because in some cases the antenna performance is practically independent of wavelength, provided this one length is very long compared with the wavelength of operation. An investigation of the equiangular spiral antenna has shown that for this antenna the one specified length, the arm length, need not be large compared to a wavelength, and in fact need only be comparable to one wavelength at the lowest frequency of operation to obtain performance essentially independent of frequency.

The equiangular or logarithmic spiral is a plane curve which may be defined by the equation, $\rho = ke^{a\phi}$ as in

⁶ J. D. Dyson, "The Equiangular Spiral Antenna," Fifth Symp. on the USAF Antenna Res. and Dev. Program, Robert Allerton Park, Univ. of Illinois, Monticello, Ill., October 22, 1955. (Classified)

⁷ J. D. Dyson, "The Equiangular Spiral Antenna," Univ. of Illinois, Urbana, Ill., Tech. Rep. No. 21, Contract AF 33(616)3220; September 15, 1957.

⁸ V. H. Rumsey, "Frequency independent antennas," 1957 IRE NATIONAL CONVENTION RECORD, pt. 1, pp. 114-118.

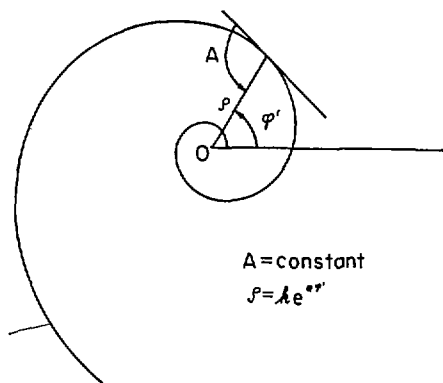

Fig. 1—The equiangular spiral.

Fig. 1; ρ and ϕ are the conventional polar coordinates and a and k are positive constants.

If the angle ϕ is increased by one full turn, the radius vector is increased by the factor $e^{2\pi a}$, hence each turn of the spiral is identical with every other turn except for a constant multiplier.

The length of the spiral may be calculated from

$$L = \int_{\rho_0}^{\rho} \left[\rho^2 \left(\frac{d\phi}{d\rho} \right)^2 + 1 \right]^{1/2} d\rho, \quad (1)$$

which reduces to

$$L = [a^{-2} + 1]^{1/2} (\rho - \rho_0). \quad (2)$$

To create an antenna from the equiangular spiral, we consider a conductor with edges defined by the two curves,

$$\rho_1 = ke^{a\phi} \quad (3)$$

and

$$\rho_2 = ke^{a(\phi-\delta)} = K\rho_1, \quad (4)$$

where

$$K = e^{-a\delta} = \frac{\rho_2}{\rho_1} < 1. \quad (5)$$

The edges of this conductor are identical curves, with one rotated through the fixed angle δ , with respect to the other. This rotation gives the arm a finite width.

A second conductor may be defined by

$$\rho_3 = ke^{a(\phi-\pi)} \quad (6)$$

and

$$\rho_4 = ke^{a(\phi-\pi-\delta)} = K\rho_3. \quad (7)$$

These two conductors constitute a balanced antenna of infinite length. To specify a finite size structure, one fixed length, the arm length, must be specified. The arm length as used here refers to the spiral length along the center line of the arm. Fig. 2 is an outline drawing of a practical antenna.

It should be noted at this point that the antenna could be completely specified by the angle, δ , which de-

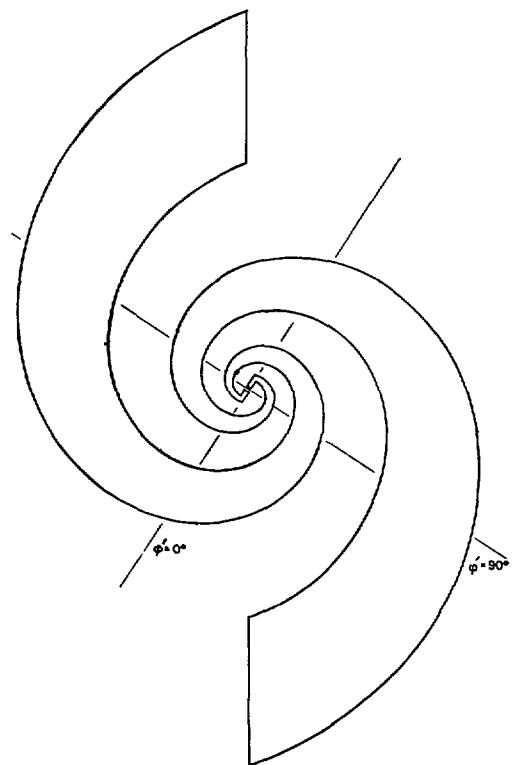

Fig. 2—Outline drawing of an antenna. ($a=0.35$, $K=0.597$, $k=0.2$ inch, maximum diameter = $9 \frac{3}{16}$ inch.)

termines the arm width, the arm length, and the constants a and k , the former controlling the rate of spiral and the latter the size of the terminal region.

However, the investigation has disclosed that most of the characteristics of the antenna can be adequately specified in terms of only three variables, the arm length, the constant k and a constant K , defined in (5), which is a convenient measure of the angular width of the antenna arm, the width along the radius vector. A practical balanced antenna imposes a lower bound on K (i.e., $e^{-a\pi} < K < 1$) if the space between the arms is to remain open.

The investigation with which this paper is concerned has been confined to the balanced, planar, equiangular spiral antenna with a balanced feed. Two forms of this antenna have been used, the plane conductor antenna, i.e., metallic arms suspended in free space, and the slot antenna, which consists of spiral slots cut in a large conducting sheet. Fig. 3 shows three of the slot antennas investigated. The slot antennas are shown cut into a 14-inch square of 1/32-inch copper which was bolted into a larger ground plane.

The slot antenna is a most useful form because it makes it possible to feed the balanced structure in a completely balanced manner simply by embedding the coaxial feed cable in the ground plane, or soldering it to the ground plane, as shown in Figs. 3 and 4. This method of feed, which might be referred to as an "infinite balun," is made possible by the rapid attenuation of the near fields on the arms. It is the only form of balun presently in use which will permit the fullest use

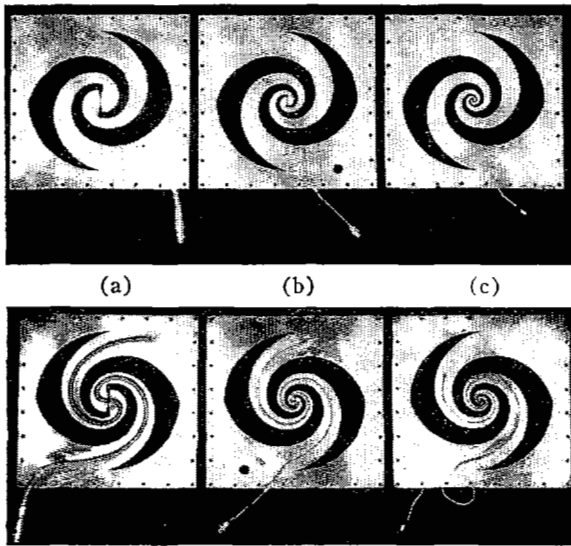

Fig. 3—One slot antenna showing modifications in terminal region to accommodate three sizes of feed cable.

of the infinite impedance and pattern bandwidths of this antenna. The only disadvantage of this type of feed is that it requires leaving sufficient ground screen between the slot arms to carry the feed cable. This imposes a requirement that the spiral be terminated at the center in a fairly large feed section, as can be seen in Fig. 3, if a large coaxial feed cable is required. As indicated later, this feed section will determine the upper frequency limit of the antenna.

If the width of the metal on which the cable is mounted approaches the diameter of the feed cable, it becomes necessary to mount a dummy cable on the opposite arm, as has been done in Figs. 3 and 4 to maintain symmetry of construction and to prevent a tilt in the radiation pattern.

THE RADIATION PATTERN

Using (3), we note that if the unit of length is chosen as a wavelength, λ , and if ρ' equals the radial coordinate measured in wavelengths,

$$\rho' = \frac{\rho}{\lambda} = \frac{e^{a\phi}}{\lambda} = e^{a(\phi - 1/a \ln \lambda)}$$

or

$$\rho' = e^{a(\phi - \phi_0)} \quad \text{where} \quad \phi_0 = \frac{1}{a} \ln \lambda. \quad (8)$$

This would indicate that the effect of changing the wavelength is equivalent to changing the angle ϕ_0 . Thus except for a rotation, the pattern of the infinite structure would be independent of frequency. Within the necessary limitation imposed by the one fixed length, *i.e.*, the arm length, this has been found to be true for the finite size structure.

The radiation patterns of more than 40 spiral slot antennas have been investigated with the parameters a and K varying,

$$0.2 \leq a \leq 1.2 \quad \text{and} \quad 0.375 \leq K \leq 0.97.$$

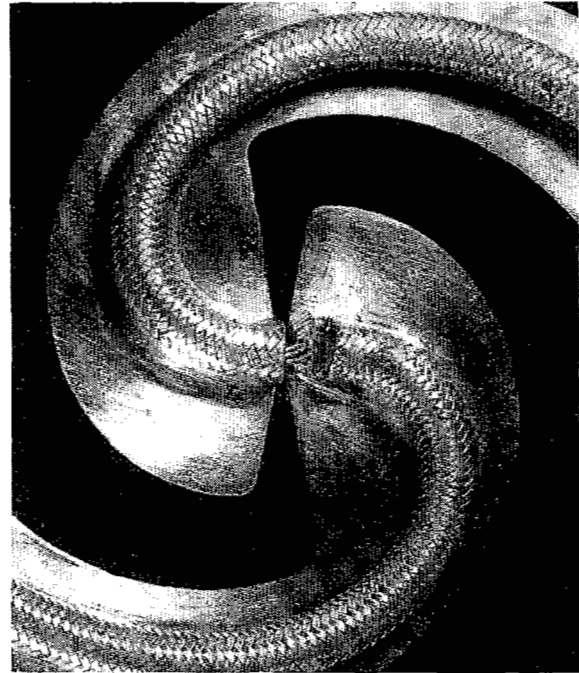

Fig. 4—Terminal region of antenna shown in Fig. 3(b).

Spirals of one-half turn up to three turns have been constructed. The antenna patterns appear to be remarkably insensitive to these variations, although there are optimum ranges of the parameters. Consistently good patterns can be obtained with spirals of only $1\frac{1}{4}$ or $1\frac{1}{2}$ turns.

The antenna radiates a broad lobe perpendicular to the plane of the antenna over a practical range of parameters. This radiation is bidirectional with equal beams radiated from the front and the back of the structure. The beam is circularly polarized on its axis, over the usable bandwidth. There is no tilt to the lobe of the symmetrical antenna.

For frequencies such that the antenna arms are very short in terms of wavelength, the radiated field is linearly polarized. As the arm length is increased (or frequency increased) the field, on the axis perpendicular to the plane of the antenna, becomes elliptically and then circularly polarized. Since there are no distinctive changes in pattern shape, this change in field polarization becomes a convenient criterion for specifying the cutoff of the pattern bandwidth.

The bandwidth, as used here, refers to that band of frequencies over which the antenna radiates a field such that the axial ratio of the polarization ellipse, recorded on the axis of the antenna, is less than 2 to 1. The radiated field will be considered circularly polarized over this bandwidth. Fig. 5 is a plot of the polarization of the radiated field of a typical antenna as a function of frequency.

In general, the relationship of the lower cutoff frequency to antenna size would be a function of the three variables, a , δ , and the length. However, it is notable that all of the measured values can be represented in terms of two parameters, the length and the angular

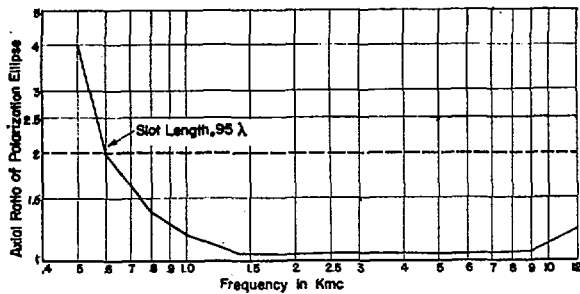

Fig. 5—Polarization, on axis, of the radiated E field of antenna shown in Fig. 3(a).

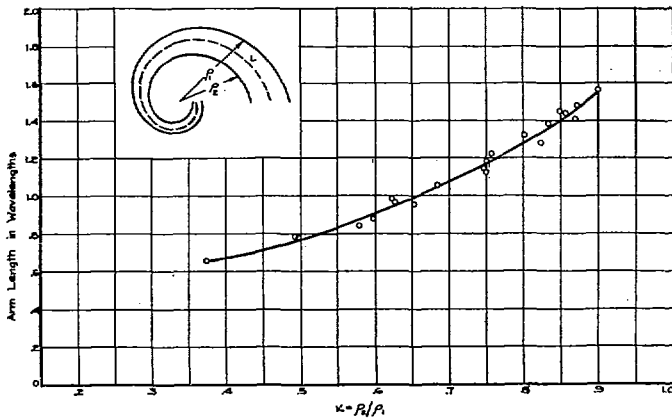

Fig. 6—Minimum slot length in wavelengths necessary to produce circularly polarized radiated field ($r \leq 2:1$ on axis; $0.2 \leq a \leq 0.45$).

width factor K as indicated in Fig. 6. Over the practical ranges of a and K tested, the bandwidth appears to be a function of antenna diameter only insofar as the diameter is a function of how tightly the required length is spiraled. This immediately suggests that the antenna be spiraled tightly (*i.e.*, a made small) if the maximum bandwidth is to be obtained for a given diameter antenna.

An examination of Fig. 2 and the fact that K is restricted to the range $e^{-a\pi} < K < 1$ indicate that a decrease in a raises the lower bound on K , in turn requiring a longer arm length. In addition, a further restriction is imposed on K if sufficient ground screen is left between the slots to carry a feed cable. Thus, depending upon the size of the feed cable, there is an optimum a and K to construct an antenna with the lowest cutoff frequency in a given diameter.

The shape of the termination of the arms has little effect upon the pattern. The arms were terminated along the radius vector, along the orthogonal curve, and along an arc of a circle whose center is at the origin of the spiral. This latter termination has the advantage that it gives the greatest effective arm length, and hence the widest bandwidth, for a given antenna diameter.

The upper cutoff of the bandwidth is a function of the fineness of construction of the spiral at the feed point. Since the spiral converges to a point, it is necessary in a practical structure to terminate the center in a small

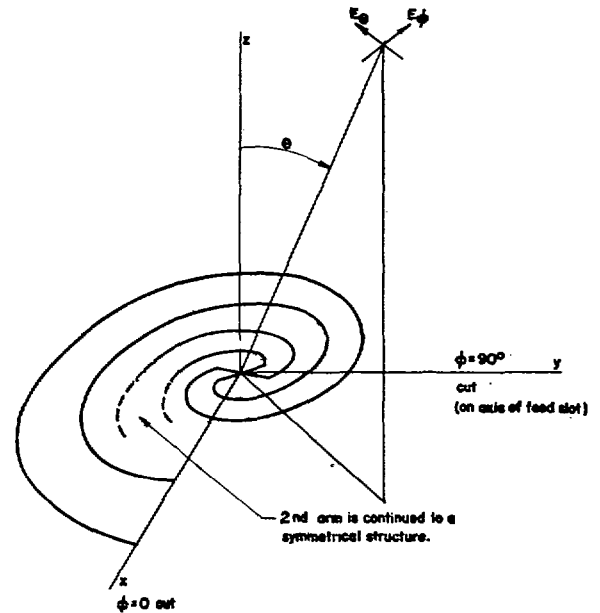

Fig. 7—Polar coordinate system for pattern measurements.

straight or tapered section. This may be noted in Figs. 2-4. At a frequency such that this straight or tapered portion becomes effectively a half-wave slot the axial ratio of the field has increased to approximately 2 to 1. The field becomes elliptically polarized for higher frequencies, so that this specifies the upper cutoff of the pattern bandwidth.

Pattern bandwidths in excess of 20 to 1 have been recorded. This was the usable limit of the pattern range at this laboratory. There is no indication that this bandwidth could not be extended indefinitely.

Since the upper and lower cutoffs are independent, the only limitation is the required diameter in which to spiral the necessary length, and the chosen size of the feed structure.

All of the radiation patterns of the slot antennas were measured on a 12-foot square ground screen pattern range. The patterns are voltage plots and the coordinate system used is indicated in Fig. 7. The spiral slot antennas were bolted into the ground screen and fed as the transmitting antenna. Four patterns were recorded at each frequency; the crossed polarization patterns were recorded at the two principal plane cuts. Polarization patterns were obtained by positioning the receiving antenna on the axis of the spiral antenna and rotating the latter structure in the ground screen.

Radiation patterns of a typical antenna over a 20 to 1 bandwidth are shown in Figs. 8 and 9. This particular antenna is shown in Fig. 3(a).

It was shown earlier that a change in wavelength of operation is equivalent merely to reorienting the antenna or shifting it through some angle around the $\theta = 0$ axis. If the radiated field were independent of ϕ this reorientation would leave the pattern unchanged. However, when viewed from different points on the $\theta = 90^\circ$ plane, the field of the practical structure may

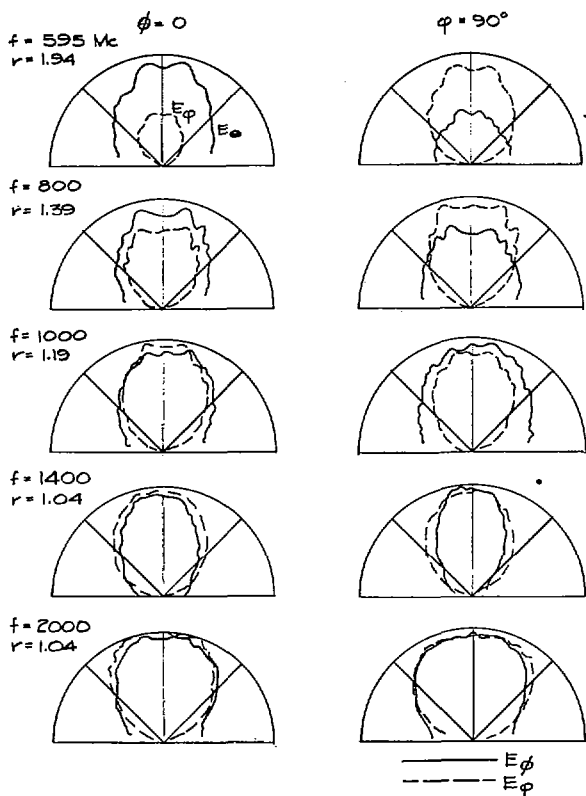

Fig. 8—Radiation patterns of antenna shown in Fig. 3(a). ($a=0.30$, $K=0.62$, $k=0.2$ inch, maximum diameter = 28.4 cm, arm length = 38.7 cm, r = axial ratio.)

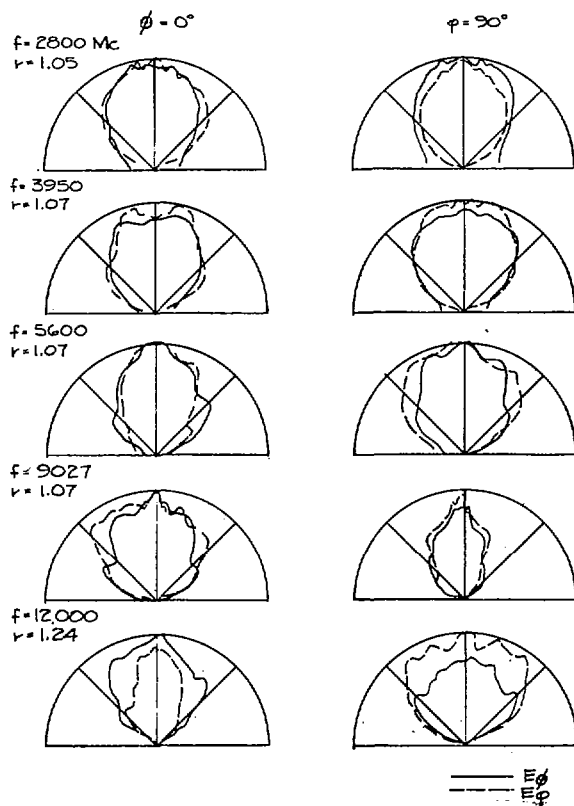

Fig. 9—Radiation patterns of antenna in Fig. 3(a).

have a beamwidth which varies 40° or more. Thus if operation is confined to a fixed frequency, an observer moving around the antenna will note a variation in the beamwidth at the half power points such as that of curve A, Fig. 10. Since the antenna is symmetrical, the variation is periodic every 180°. If the observer remains fixed with respect to the orientation of the antenna, and the frequency of operation is increased, he will observe this same variation of beamwidth. Consequently, if the frequency of operation is changed, the observer must also move around the antenna a fixed angular distance to make the pattern he sees remain unchanged. An examination of (8) indicates that this angle may be expressed as

$$\phi_0 = \frac{1}{a} \ln \frac{f_2}{f_1}$$

or

$$\Delta\phi = \phi_1 - \phi_2 = \frac{1}{a} \ln \frac{f_1 + \Delta f}{f_1} \tag{9}$$

Since there are few distinctive pattern changes with frequency, a check of this pattern rotation may be made by a repetition of pattern beamwidth at a new frequency. Figs. 10 and 11 indicate two experimental checks on this rotation. In Fig. 10 we see that the variation in beamwidth, observed through a variation in ϕ from 0°–210° for fixed frequency operation, is repeated

quite closely by observing at a fixed angle ϕ , and increasing the frequency from 2472 to 7505 mc. The deviation at the low end is traceable to end effect.

In Fig. 11 observe that the variation in beamwidth is held within four degrees by an antenna reorientation, when the frequency was varied from 2 to 5.18 kmc. This is to be compared with the variation of approximately 50° indicated in Fig. 10 over the same band of frequencies without reorientation.

Since the pattern of the equiangular spiral antenna rotates with frequency, a detailed study of pattern change with frequency requires a corresponding antenna rotation for every shift in frequency. In most normal operations, the antenna will be in a fixed mount, and the pattern response with respect to that fixed mount is desired. Hence the patterns in Figs. 8 and 9 are displayed as a function of frequency, without regard to any pattern rotation. This accounts for most of the apparent variation in the patterns over these frequency ranges.

A detailed study made of the near fields along the antenna arms indicated that these fields decay very rapidly (as much as 20 db in the first wavelength) and that this decay is approximately a constant function of the arm length expressed in wavelengths. This has the effect of constantly shortening the active arm length as the frequency is increased, resulting in an effective adjustment of antenna aperture size even though the physical aperture remains constant. There appears to be no tendency for the beamwidth to become narrower

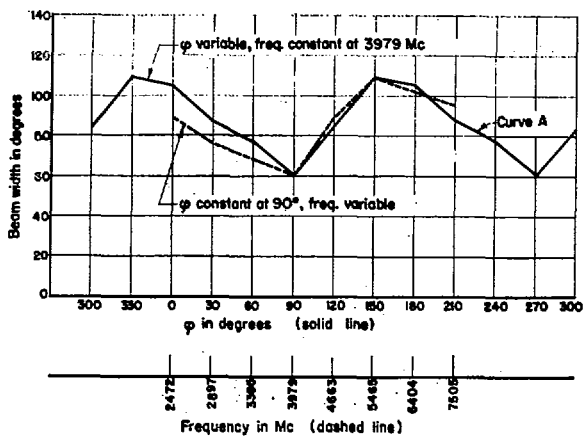

Fig. 10—Rotation of radiated field with a change in frequency. ($a=0.303$, $K=0.75$, $k=0.2$ inch, $L=33$ cm.)

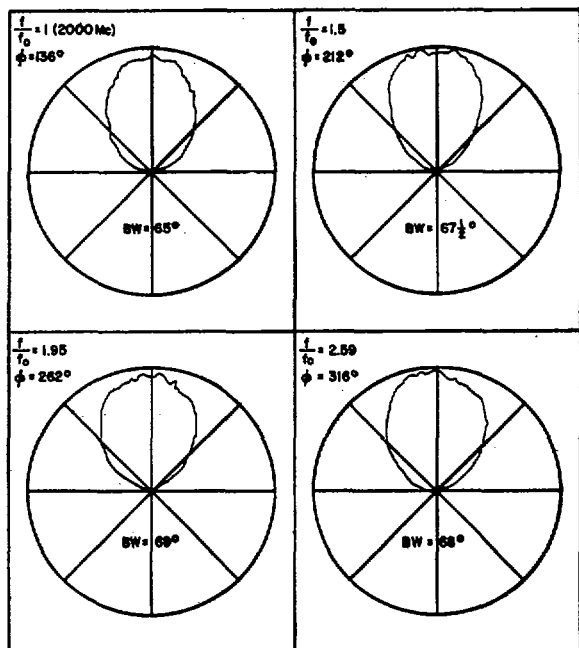

Fig. 11—Patterns obtained by simultaneous rotation of antenna and increase in frequency. ($a=0.303$, $K=0.75$, $k=0.2$ inch, $L=33$ cm) ϕ polarization.

with increased frequency and the antenna aperture expressed in wavelengths appears constant.

The average beamwidth is relatively insensitive to variations of the antenna parameters, but the tighter spiraled antennas and/or antennas with wider arms tend to have smoother and more uniform patterns which exhibit smaller variations in beamwidth.

The polarization of the radiated field, off axis, of a typical antenna is shown in Fig. 12. This particular antenna became circularly polarized on axis at 1000 mc and the bandwidth extends somewhere beyond 12,000 mc. Over more than 80 per cent of the band it is circularly polarized as much as 40° off axis.

THE INPUT IMPEDANCE

The input impedance of the planar balanced equiangular slot antenna converges rapidly as the frequency is increased. For frequencies such that the arm lengths

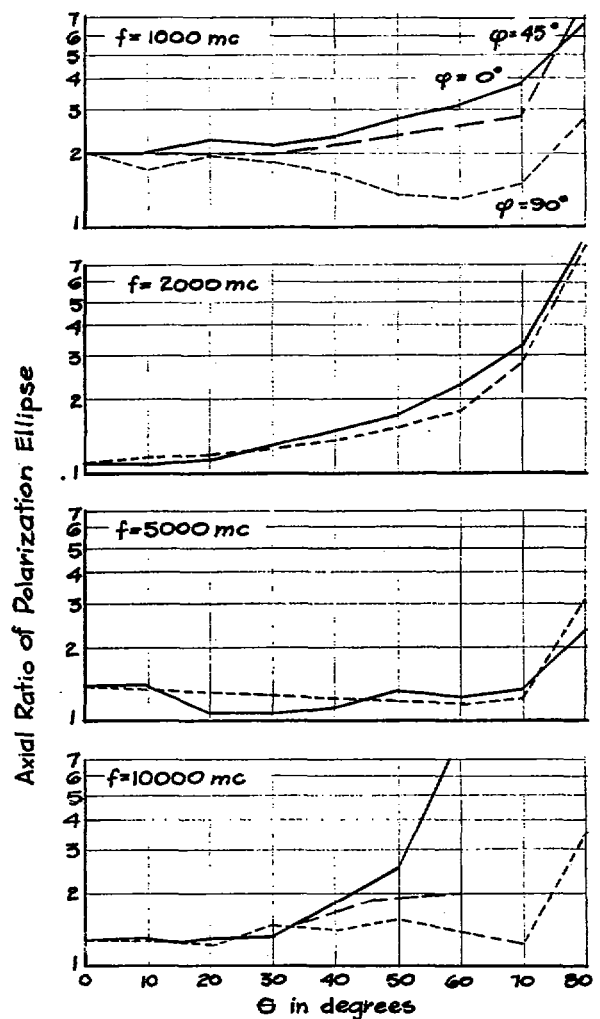

Fig. 12—Polarization of the radiated E field of a balanced planar slot antenna. ($a=0.30$, $K=0.75$, $k=0.2$ inch, $L=42.3$ cm.)

are greater than one wavelength, the impedance remains reasonably constant. The measured impedance of a typical antenna is shown in Fig. 13. This antenna was constructed of $\frac{1}{8}$ -inch copper with a 0.150-inch diameter coaxial cable (RG141/U) bonded to the ground screen between the slot arms.

The input impedance of an antenna of zero thickness would be expected to converge to its characteristic impedance with an increase in frequency. The antenna of finite thickness does not have a uniform characteristic impedance since it is a nonuniform transmission line, but the input impedance rapidly settles down to a reasonably constant value for relatively thin antennas. The measured impedance of the antennas tested is below the theoretical impedance of an infinitely thin antenna, due in part to the thickness of the metal and the presence of the feed cable. There is a relationship between the arm width and the input impedance as indicated in Fig. 14. This curve is based on the measured impedance of antennas constructed of $\frac{1}{8}$ copper, with $k=0.2$ inch, with RG141/U feed cable and without a dummy cable on the opposite arm of the ground screen. The use of a dummy cable of this size will lower the measured impedance approximately 10 per cent. The

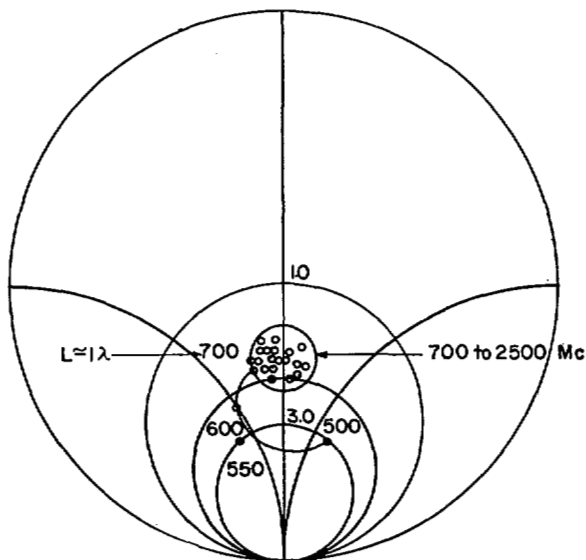

Fig. 13—Input impedance of a typical balanced slot antenna fed with RG141/U cable. ($k = .2$ inch, $a = .303$, $K = .75$, $L = 42.3$ cm.)

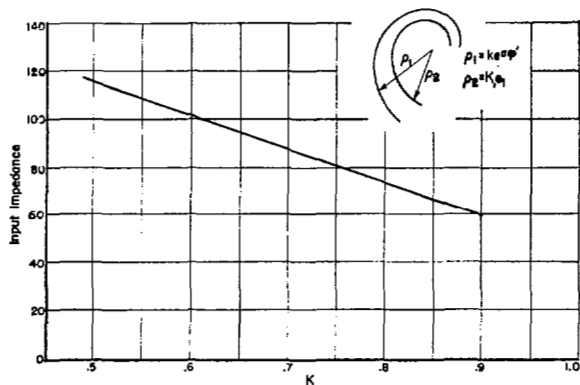

Fig. 14—Input impedance of balanced planar slot antennas (constructed of $\frac{1}{32}$ -inch copper with 0.150-inch coaxial cable bonded to screen between the slot arms). ($0.2 \leq a \leq 0.45$, $k = 0.2$.)

input impedance of the antenna can be lowered still further by increasing the thickness of the metal; however, this will be at the expense of some pattern bandwidth since it will lower the upper cutoff frequency.

The measured standing wave ratio which a typical balanced slot antenna presents to a 50-ohm coaxial line is shown in Fig. 15.

The use of a miniature cable, such as "Microdot," lowers the capacitance between the arms and raises the measured impedance by approximately 20 per cent. However, an antenna fed with this cable may present considerably greater variations in the input standing wave ratio as a function of frequency due to irregularities in the miniature line after soldering it to the ground screen.

EFFICIENCY

The efficiency of the basic antenna, *i.e.*, the metal structure consisting of slots in a metal plane or metal arms in free space without dielectric material or any type of cavity backing, was measured and found to be approximately 98 per cent for antennas with an arm

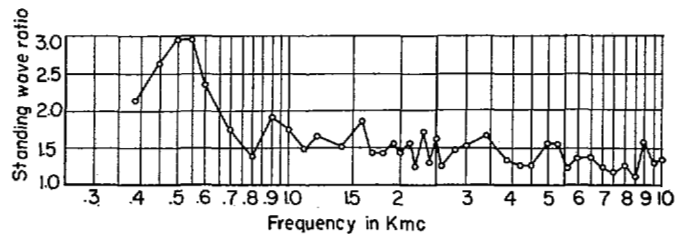

Fig. 15—Standing wave ratio which a typical balanced slot antenna presents to a 50-ohm coaxial line, ($k = 0.2$ inch, $a = 0.303$, $K = 0.75$, arm length = 42.3 cm.)

length of one wavelength or more. For arm lengths shorter than one wavelength the efficiency decreases rapidly.

CONCLUSIONS

The planar balanced equiangular spiral antenna, in a practical size, exhibits the characteristics associated with an infinite structure. The bandwidth has been shown to be limited only by the chosen arm length and the precision of construction at the feed point. An extension of the bandwidth is a practical matter since the arm need only be of the order of one wavelength at the lowest frequency of operation.

The antenna will provide circularly polarized, single-lobe, bidirectional radiation, perpendicular to the plane of the antenna. The beamwidth varies with rotation in the plane of the antenna, and since the pattern rotates with frequency, the apparent beamwidth will vary with frequency for a fixed cut. The variation is typically approximately 40° or 50° . The more tightly wound spirals and the antennas with broader arms have somewhat more uniform patterns. The input impedance converges with increasing frequency, and for the antennas of most interest, the slot antenna is rarely mismatched more than three to one to a 50-ohm line, and is usually two to one or better over the radiation pattern bandwidth.

The structures described in this report are not miniature when compared to many present narrow-band antennas. However, the maximum diameter need only be one half wavelength. The primary advantage of the antenna is its capability of radiating circular or elliptically polarized energy with good efficiency over unlimited bandwidths that are at the discretion of the designer.

ACKNOWLEDGMENT

The author is pleased to acknowledge the advice and suggestions of V. H. Rumsey, to whom must go full credit for original concepts leading to this antenna. Appreciation is extended to R. H. DuHamel, P. E. Mayes, and R. L. Carrel for many fruitful discussions, and to W. E. Kennedy, V. P. Rash, and other members of the laboratory who assisted in the measurements.

Mention should also be made of E. M. Turner, Wright Air Development Center, whose original work on the Archimedes Spiral Antenna in 1953 and 1954 undoubtedly gave impetus to further thought in terms of spirals.