

# The 1999 GMC C-Series Owner's Manual

---

## **1-1 Seats and Restraint Systems**

This section tells you how to use your seats and safety belts properly.

## **2-1 Features and Controls**

This section explains how to start and operate your vehicle.

## **3-1 Comfort Controls and Audio Systems**

This section tells you how to adjust the ventilation and comfort controls and how to operate your audio system.

## **4-1 Your Driving and the Road**

Here you'll find helpful information and tips about the road and how to drive under different conditions.

## **5-1 Problems on the Road**

This section tells you what to do if you have a problem while driving, such as a flat tire or overheated engine, etc.

## **6-1 Service and Appearance Care**

Here the manual tells you how to keep your vehicle running properly and looking good.

## **7-1 Maintenance Schedule**

This section tells you when to perform vehicle maintenance and what fluids and lubricants to use.

## **8-1 Customer Assistance Information**

This section tells you how to contact GMC for assistance and how to get service and owner publications. It also gives you information on "Reporting Safety Defects" on page 8-6.

## **9-1 Index**

Here's an alphabetical listing of almost every subject in this manual. You can use it to quickly find something you want to read.



GENERAL MOTORS, GM, the GM Emblem, GMC and the GMC Emblem are registered trademarks of General Motors Corporation.

This manual includes the latest information at the time it was printed. We reserve the right to make changes in the product after that time without further notice. For vehicles first sold in Canada, substitute the name “General Motors of Canada Limited” for GM Medium Duty Truck Division whenever it appears in this manual.

Please keep this manual in your vehicle, so it will be there if you ever need it when you’re on the road. If you sell the vehicle, please leave this manual in it so the new owner can use it.

Litho in U.S.A.  
X9902 A First Edition



We support voluntary technician certification.

## For Canadian Owners Who Prefer a French Language Manual:

**Aux propriétaires canadiens:** Vous pouvez vous procurer un exemplaire de ce guide en français chez votre concessionnaire ou au:

DGN Marketing Services Ltd.  
1577 Meyerside Dr.  
Mississauga, Ontario L5T 1B9

© Copyright General Motors Corporation 1998  
All Rights Reserved

## How to Use this Manual

Many people read their owner's manual from beginning to end when they first receive their new vehicle. If you do this, it will help you learn about the features and controls for your vehicle. In this manual, you'll find that pictures and words work together to explain things quickly.

## Index

A good place to look for what you need is the Index in back of the manual. It's an alphabetical list of what's in the manual, and the page number where you'll find it.

## Safety Warnings and Symbols

You will find a number of safety cautions in this book. We use a box and the word CAUTION to tell you about things that could hurt you if you were to ignore the warning.

### CAUTION:

**These mean there is something that could hurt you or other people.**

In the caution area, we tell you what the hazard is. Then we tell you what to do to help avoid or reduce the hazard. Please read these cautions. If you don't, you or others could be hurt.

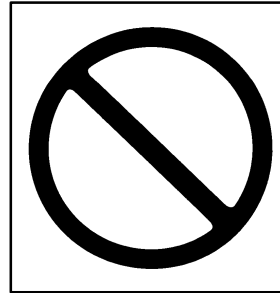

You will also find a circle with a slash through it in this book. This safety symbol means "Don't," "Don't do this" or "Don't let this happen."

## Vehicle Damage Warnings

Also, in this book you will find these notices:

### **NOTICE:**

**These mean there is something that could damage your vehicle.**

In the notice area, we tell you about something that can damage your vehicle. Many times, this damage would not be covered by your warranty, and it could be costly. But the notice will tell you what to do to help avoid the damage.

When you read other manuals, you might see CAUTION and NOTICE warnings in different colors or in different words.

You'll also see warning labels on your vehicle. They use the same words, CAUTION or NOTICE.

## Vehicle Symbols

These are some of the symbols you may find on your vehicle.

For example, these symbols are used on an original battery:

CAUTION  
POSSIBLE  
INJURY



PROTECT  
EYES BY  
SHIELDING



CAUSTIC  
BATTERY  
ACID COULD  
CAUSE  
BURNS



AVOID  
SPARKS OR  
FLAMES



SPARK OR  
FLAME  
COULD  
EXPLODE  
BATTERY



These symbols are important for you and your passengers whenever your vehicle is driven:

DOOR LOCK  
UNLOCK



FASTEN  
SEAT  
BELTS



POWER  
WINDOW



AIR BAG



These symbols have to do with your lamps:

MASTER  
LIGHTING  
SWITCH



TURN  
SIGNALS



PARKING  
LAMPS



HAZARD  
WARNING  
FLASHER



DAYTIME  
RUNNING  
LAMPS



FOG LAMPS



These symbols are on some of your controls:

WINDSHIELD  
WIPER



WINDSHIELD  
WASHER



WINDSHIELD  
DEFROSTER



REAR  
WINDOW  
DEFOGGER



VENTILATING  
FAN



These symbols are used on warning and indicator lights:

ENGINE  
COOLANT  
TEMP



BATTERY  
CHARGING  
SYSTEM



BRAKE



COOLANT



ENGINE OIL  
PRESSURE



ANTI-LOCK  
BRAKES



Here are some other symbols you may see:

FUSE



LIGHTER



HORN



SPEAKER



FUEL



## Model Reference

This manual contains information which covers conventional cab models as shown. Most models are unfinished from the factory.

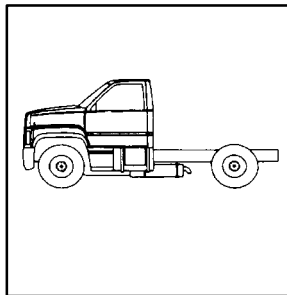

C6H042

C7H042

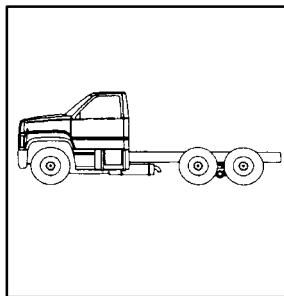

C7H064

Since C-Series models delivered from the factory are finished in a variety of ways by a number of companies, you'll probably find other manuals in your finished vehicle. These manuals are put there by the companies that have added components or equipment to the C-Series model. Read all these materials -- as well as this manual -- carefully, to get all of the information on your vehicle.

# Section 1 Seats and Restraint Systems

---

Here you'll find information about the seats in your vehicle and how to use your safety belts properly. You can also learn about some things you should *not* do with safety belts.

1-2	Seats and Seat Controls	1-22	Center Passenger Position
1-6	Safety Belts: They're for Everyone	1-23	Children
1-10	Here are Questions Many People Ask About Safety Belts -- and the Answers	1-26	Child Restraints
1-11	How to Wear Safety Belts Properly	1-33	Larger Children
1-11	Driver Position	1-36	Safety Belt Extender
1-21	Safety Belt Use During Pregnancy	1-36	Checking Your Restraint Systems
1-21	Right Passenger Position	1-36	Replacing Restraint System Parts After a Crash

## Seats and Seat Controls

This section tells you about the seats in your vehicle and how to adjust them.

### CAUTION:

**You can lose control of the vehicle if you try to adjust the seat while the vehicle is moving. The sudden movement could startle and confuse you, or make you push a pedal when you don't want to. Adjust the driver's seat only when the vehicle is not moving.**

## Bucket and Bench Seats



If your vehicle has a bucket or bench seat, you can adjust it with this lever at the front of the seat.

Slide the lever toward the outer seat support to unlock it. Slide the seat to where you want it. Then, release the lever and try to move the seat with your body to make sure the seat is locked into place.



## Head Restraints

Some seats have adjustable head restraints. Slide an adjustable head restraint up or down so that the top of the restraint is closest to the top of your ears. This position reduces the chance of a neck injury in a crash.

## Seatback Latches

The front of the full-width bench seat seatback folds forward to let you reach the rear of the cab. Bucket seats have outboard-mounted levers to tilt the seatbacks forward or rearward.

Your seatback will move back and forth freely unless you come to a sudden stop -- then it will lock into place. If your vehicle is parked going down a fairly steep hill, the seatback may not fold without some help from you.



To fold the seatback forward, push the seatback toward the rear of the vehicle as you lift this latch. The latch must be down for the seat to work properly.

### Bench Seat Shown

#### CAUTION:

**If the seatback isn't locked, it could move forward in a sudden stop or crash. That could cause injury to the person sitting there. Always press rearward on the seatback to be sure it is locked.**

## National Seats (If Equipped)



If your vehicle has the low-back National seat, there are six ways you can adjust the seat.

If your vehicle has the high-back National seat, there are five ways you can adjust the seat.

## Height Adjustment



To adjust the height of a self-contained seat (hand-pumped air seat), push the seat height adjustment pump lever, located on the lower outboard side, down and continue pumping to raise the seat. Press the lever and hold it to lower the seat.

To adjust the height of air-sourced seats, use the knob on the front left-hand side on the seat. Push the knob to inflate. Pull the knob to deflate.



To adjust the height of the cushion, lift the cushion height adjustment handle up and forward. You can choose between two settings. The handle is located underneath the seat, in the front.

### Lumbar Adjustments

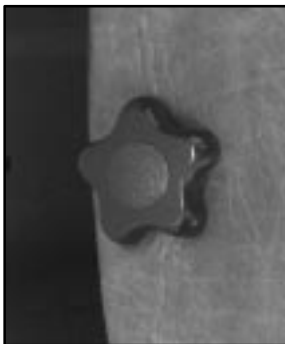

To get more support in the lumbar area of your back, turn the lumbar adjustment knob. The knob is located on the upper cushion, on the inboard side of the driver's seat and the outboard side of the passenger's seat.

### Seatback Adjustment



To tilt the seatback, turn the backrest tilt knob. The knob is located on the lower cushion, on the outboard side of the driver's seat and the inboard side of the passenger's seat.

### Fore-and-Aft Adjustment



To slide the seat forward or backward, move the lever toward the passenger's side. The seat will lock in at 1/2 inch (1.5 cm) increments. The lever is located underneath the seat, in the front.

## Chugger-Snubber Lock-Out Feature (If Equipped)



This handle is located on the lower outboard side of the driver's seat and the inboard side of the passenger's seat. Move the handle down to isolate any backslap experienced while in tractor/trailer operation or while operating a dump truck application. This is only available on low-back seats.

## Safety Belts: They're for Everyone

This part of the manual tells you how to use safety belts properly. It also tells you some things you should not do with safety belts.



### CAUTION:

**Don't let anyone ride where he or she can't wear a safety belt properly. If you are in a crash and you're not wearing a safety belt, your injuries can be much worse. You can hit things inside the vehicle or be ejected from it. You can be seriously injured or killed. In the same crash, you might not be if you are buckled up. Always fasten your safety belt, and check that your passengers' belts are fastened properly too.**

 **CAUTION:**

**It is extremely dangerous to ride in a cargo area, inside or outside of a vehicle. In a collision, people riding in these areas are more likely to be seriously injured or killed. Do not allow people to ride in any area of your vehicle that is not equipped with seats and safety belts. Be sure everyone in your vehicle is in a seat and using a safety belt properly.**



If your vehicle has a safety belt reminder light, a light comes on as a reminder to buckle up. (See “Safety Belt Reminder Light” in the Index.)

If your vehicle has a safety belt reminder tone, a tone comes on as a reminder to buckle up. See “Safety Belt Reminder Tone” in the Index.

In most states and Canadian provinces, the law says to wear safety belts. Here’s why: *They work.*

You never know if you’ll be in a crash. If you do have a crash, you don’t know if it will be a bad one.

A few crashes are mild, and some crashes can be so serious that even buckled up a person wouldn’t survive. But most crashes are in between. In many of them, people who buckle up can survive and sometimes walk away. Without belts they could have been badly hurt or killed.

After more than 30 years of safety belts in vehicles, the facts are clear. In most crashes buckling up does matter ... a lot!

## Why Safety Belts Work

**Q:** Aren't safety belts for kids?

**A:** Yes. And they're for adult truckers, and anyone else who rides in your vehicle.



Here's why: when your vehicle goes, say, 30 mph (50 km/h), so do you and your passengers.

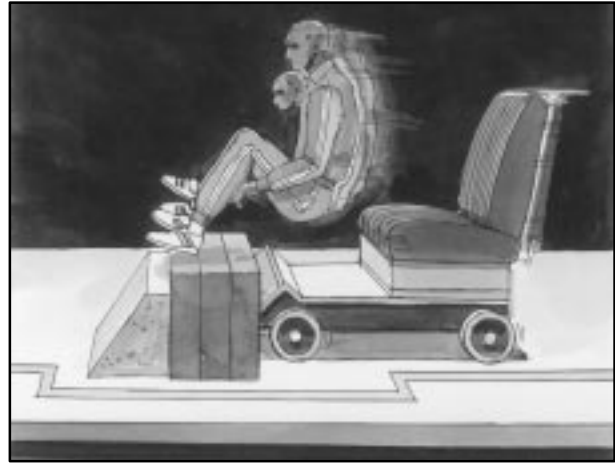

If the vehicle hits something, it stops -- right then. But nothing stops the people. They keep moving.



Then something will stop them. It could be the windshield.



Or it could be the instrument panel.

Now, what if you and your passengers were to give that big vehicle a chance to deal with the force of the impact, instead of you?



With belts, you slow down as the vehicle does. You get more time to stop.

You stop over more distance, and your strongest bones take the forces. Safety belts are for everyone.

## Here Are Questions Many People Ask About Safety Belts -- and the Answers

**Q:** Won't I be trapped in the vehicle after an accident if I'm wearing a safety belt?

**A:** You *could* be -- whether you're wearing a safety belt or not. But you can unbuckle a safety belt, even if you're upside down. And your chance of being conscious during and after an accident, so you *can* unbuckle and get out, is *much* greater if you are belted.

**Q:** If my vehicle has air bags, why should I have to wear safety belts?

**A:** Air bags are in many vehicles today and will be in most of them in the future. But they are supplemental systems only; so they work *with* safety belts -- not instead of them. Every air bag system ever offered for sale has required the use of safety belts. Even if you're in a vehicle that has air bags, you still have to buckle up to get the most protection. That's true not only in frontal collisions, but especially in side and other collisions.



**Q:** If I'm a good driver, and I never drive far from home, why should I wear safety belts?

**A:** You may be an excellent driver, but if you're in an accident -- even one that isn't your fault -- you and your passengers can be hurt. Being a good driver doesn't protect you from things beyond your control, such as bad drivers.

Most accidents occur within 25 miles (40 km) of home. And the greatest number of serious injuries and deaths occur at speeds of less than 40 mph (65 km/h).

Safety belts are for everyone.

## How to Wear Safety Belts Properly

### Adults

This part is only for people of adult size.

Be aware that there are special things to know about safety belts and children. And there are different rules for smaller children and babies. If a child will be riding in your vehicle, see the part of this manual called "Children." Follow those rules for everyone's protection.

First, you'll want to know which restraint systems your vehicle has.

We'll start with the driver position.

### Driver Position

This part describes the driver's restraint system.

## Lap-Shoulder Belt

The driver has a lap-shoulder belt. Here's how to wear it properly.

1. Close and lock the door.
2. Adjust the seat (to see how, see "Seats" in the Index) so you can sit up straight.



**Bench (A)**



**Suspension (B)**

3. Pick up the latch plate and pull the belt across you. Don't let it get twisted.
4. Push the latch plate into the buckle until it clicks.

For suspension-type seats (B), if the belt stops before it reaches the buckle, tilt the latch plate and keep pulling until you can buckle the belt. Pull up on the latch plate to make sure it is secure. If the belt is pulled out all the way so that it locks, press down on the button on the retractor cover to make it retract.

If the belt isn't long enough, see "Safety Belt Extender" at the end of this section.

Make sure the release button on the buckle is positioned so you would be able to unbuckle the safety belt quickly if you ever had to.



### **Suspension (B)**

5. To make the lap part tight on suspension-type seats (B), pull down on the buckle end of the belt as you pull up on the shoulder belt.

If the shoulder belt is too tight:



- Pull out the belt at least 5 inches (130 mm).



- Let it go back all the way.



- You can add a small amount of slack. The system works like a window shade. To add a little slack, pull down on the shoulder belt just a little -- no more than 1 inch (25 mm).
- If it's now too loose, pull it out like you did before and start again.
- If you move around in the vehicle and your shoulder belt becomes loose, be sure to make it tight again.

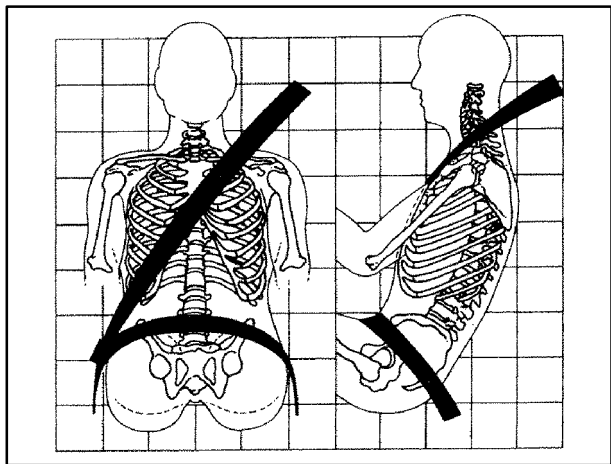

The lap part of the belt should be worn low and snug on the hips, just touching the thighs. In a crash, this applies force to the strong pelvic bones. And you'd be less likely to slide under the lap belt. If you slid under it, the belt would apply force at your abdomen. This could cause serious or even fatal injuries. The shoulder belt should go over the shoulder and across the chest. These parts of the body are best able to take belt restraining forces.

The safety belt locks if there's a sudden stop or a crash.

**Q:** What's wrong with this?

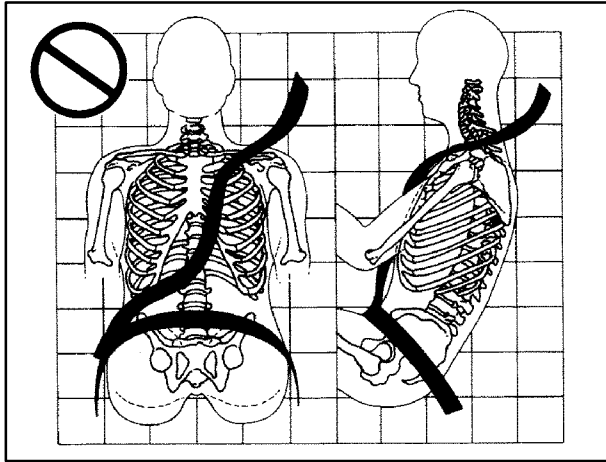

**A:** The shoulder belt is too loose. It won't give nearly as much protection this way.

**⚠ CAUTION:**

You can be seriously hurt if your shoulder belt is too loose. In a crash, you would move forward too much, which could increase injury. The shoulder belt should fit against your body. Don't allow more than 1 inch (25 mm) of slack.

**Q:** What's wrong with this?

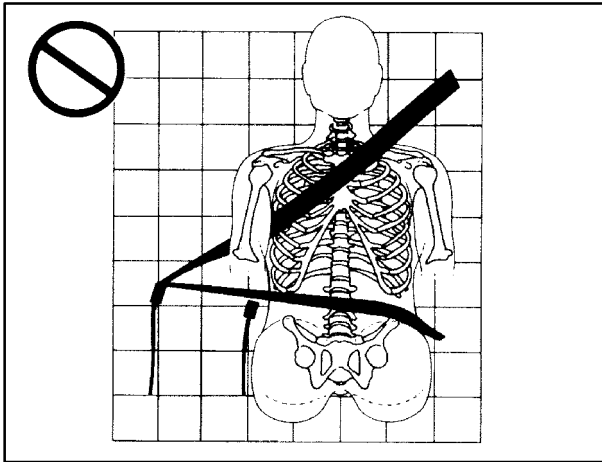

**A:** The belt is buckled in the wrong place.

**⚠ CAUTION:**

You can be seriously injured if your belt is buckled in the wrong place like this. In a crash, the belt would go up over your abdomen. The belt forces would be there, not at the pelvic bones. This could cause serious internal injuries. Always buckle your belt into the buckle nearest you.

**Q:** What's wrong with this?

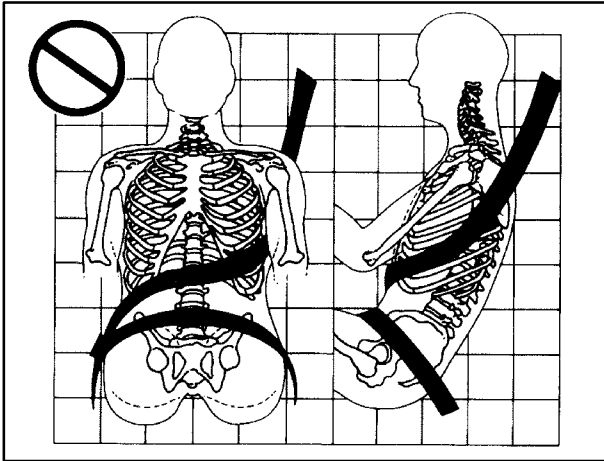

**A:** The shoulder belt is worn under the arm. It should be worn over the shoulder at all times.

**⚠ CAUTION:**

You can be seriously injured if you wear the shoulder belt under your arm. In a crash, your body would move too far forward, which would increase the chance of head and neck injury. Also, the belt would apply too much force to the ribs, which aren't as strong as shoulder bones. You could also severely injure internal organs like your liver or spleen.



**Q:** What's wrong with this?

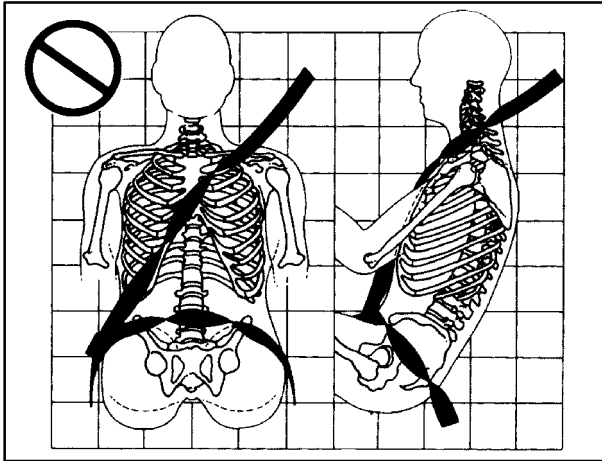

**A:** The belt is twisted across the body.

**⚠ CAUTION:**

You can be seriously injured by a twisted belt. In a crash, you wouldn't have the full width of the belt to spread impact forces. If a belt is twisted, make it straight so it can work properly, or ask your dealer to fix it.



**Bench (A)**



**Suspension (B)**

To unlatch the belt, just push the button on the buckle. The belt should go back out of the way. For a suspension-type seat, if the belt is pulled out all the way so that it locks, press down on the button on the retractor cover to make it retract.

Before you close the door, be sure the belt is out of the way. If you slam the door on it, you can damage both the belt and your vehicle.

## Safety Belt Use During Pregnancy

Safety belts work for everyone, including pregnant women. Like all occupants, they are more likely to be seriously injured if they don't wear safety belts.

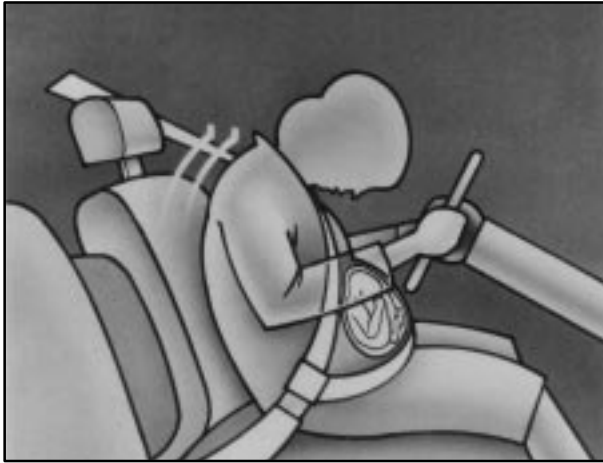

A pregnant woman should wear a lap-shoulder belt, and the lap portion should be worn as low as possible, below the rounding, throughout the pregnancy.

The best way to protect the fetus is to protect the mother. When a safety belt is worn properly, it's more likely that the fetus won't be hurt in a crash. For pregnant women, as for anyone, the key to making safety belts effective is wearing them properly.

## Right Passenger Position

The right passenger's safety belt works the same way as the driver's safety belt. See "Driver Position" earlier in this section.

## Center Passenger Position

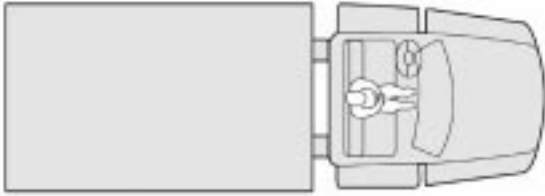

## Lap Belt

If your vehicle has a full bench seat or a two-passenger bench seat, someone can sit in the center position.



When you sit in a center seating position, you have a lap safety belt, which has no retractor. To make the belt longer, tilt the latch plate and pull it along the belt.



To make the belt shorter, pull its free end as shown until the belt is snug.

Buckle, position and release it the same way as the lap part of a lap-shoulder belt. If the belt isn't long enough, see "Safety Belt Extender" at the end of this section.

Make sure the release button on the buckle is positioned so you would be able to unbuckle the safety belt quickly if you ever had to.

## Children

Everyone in a vehicle needs protection! That includes infants and all children smaller than adult size. Neither the distance traveled nor the age and size of the traveler changes the need, for everyone, to use safety restraints. In fact, the law in every state in the United States and in every Canadian province says children up to some age must be restrained while in a vehicle.

## Smaller Children and Babies

### CAUTION:

**Smaller children and babies should always be restrained in a child or infant restraint. The instructions for the restraint will say whether it is the right type and size for your child. A very young child's hip bones are so small that a regular belt might not stay low on the hips, as it should. Instead, the belt will likely be over the child's abdomen. In a crash, the belt would apply force right on the child's abdomen, which could cause serious or fatal injuries. So, be sure that any child small enough for one is always properly restrained in a child or infant restraint.**

Infants need complete support, including support for the head and neck. This is necessary because an infant's neck is weak and its head weighs so much compared with the rest of its body. In a frontal crash, an infant in a rear-facing restraint settles into the restraint, so the crash forces can be distributed across the strongest part of the infant's body, the back and shoulders. A baby should be secured in an appropriate infant restraint. This is so important that many hospitals today won't release a newborn infant to its parents unless there is an infant restraint available for the baby's first trip in a motor vehicle.

We know securing a child can present real problems in a medium-duty vehicle like yours. The only place where you can properly secure a child restraint is the center seating position, the place that has the lap belt only. But your vehicle may not have a center seating position. Or, even if you have one, you may find that the child restraint keeps you from operating the shift lever or other controls. The only answer may be to have the smaller children make the trip in another vehicle, where they can get the protection they need.



**⚠ CAUTION:**

Never hold a baby in your arms while riding in a vehicle. A baby doesn't weigh much -- until a crash. During a crash a baby will become so heavy you can't hold it. For example, in a crash

**CAUTION: (Continued)**

**CAUTION: (Continued)**

at only 25 mph (40 km/h), a 12-lb. (5.5 kg) baby will suddenly become a 240-lb. (110 kg) force on your arms. The baby would be almost impossible to hold.

Secure the baby in an infant restraint.



## Child Restraints

Every time infants and young children ride in vehicles, they should have protection provided by appropriate restraints.

**Q:** What are the different types of add-on child restraints?

**A:** Add-on child restraints are available in four basic types. When selecting a child restraint, take into consideration not only the child's weight and size, but also whether or not the restraint will be compatible with the motor vehicle in which it will be used.

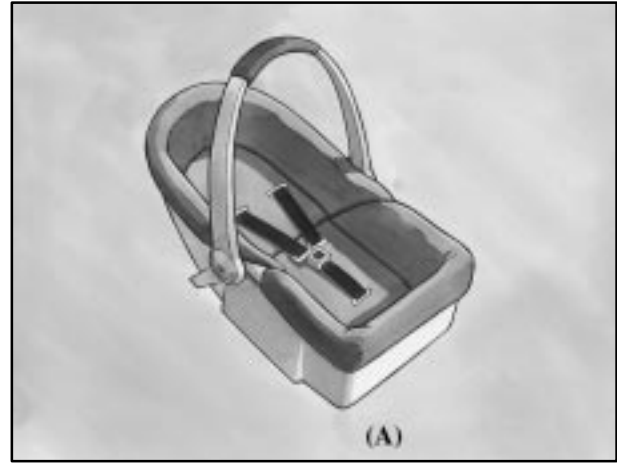

An infant car bed (A) is a special bed made for use in a motor vehicle. It's an infant restraint system designed to restrain or position a child on a continuous flat surface. With an infant car bed, make sure that the infant's head rests toward the center of the vehicle.



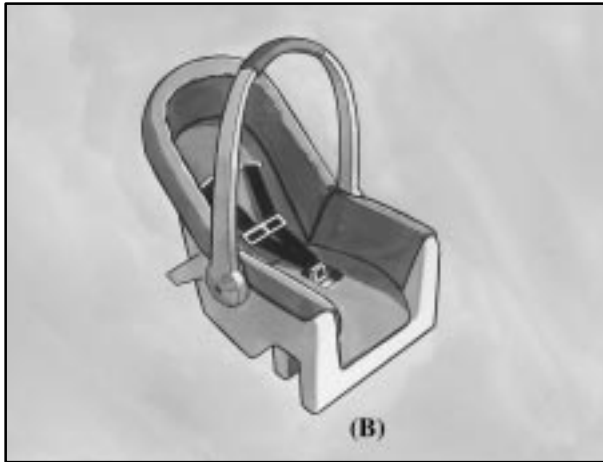

A rear-facing infant restraint (B) positions an infant to face the rear of the vehicle. Rear-facing infant restraints are designed for infants of up to about 20 lbs. (9 kg) and about one year of age. This type of restraint faces the rear so that the infant's head, neck and body can have the support they need in a frontal crash. Some infant seats come in two parts -- the base stays secured in the vehicle and the seat part is removable.



A forward-facing child restraint (C-E) positions a child upright to face forward in the vehicle. These forward-facing restraints are designed to help protect children who are from 20 to 40 lbs. (9 to 18 kg) and about 26 to 40 inches (66 to 102 cm) in height, or up to around four years of age. One type, a convertible restraint, is designed to be used either as a rear-facing infant seat or a forward-facing child seat.

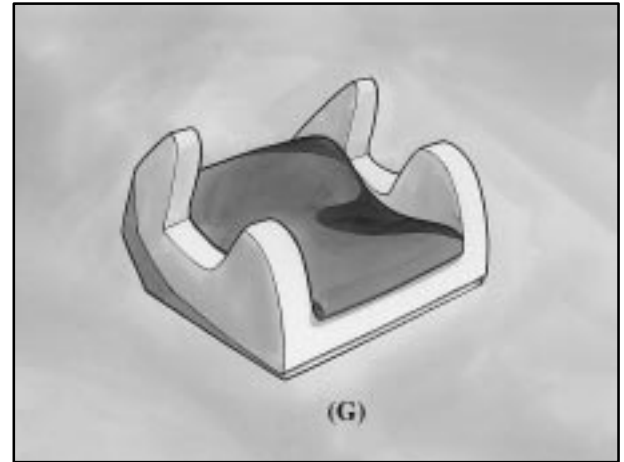
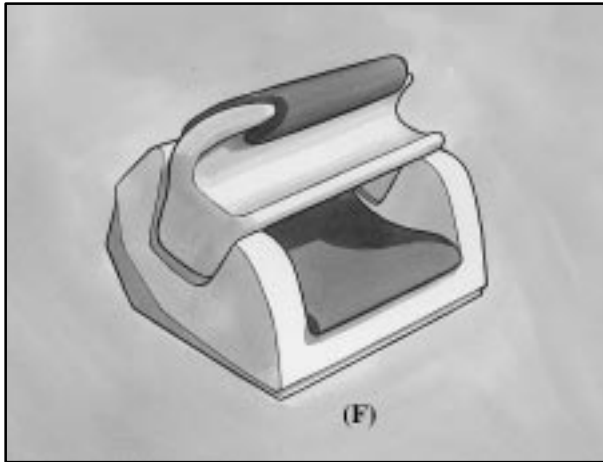

A booster seat (F, G) is designed for children who are about 40 to 60 lbs., or even up to 80 lbs. (18 to 27 kg, or even up to 36 kg), and about four to eight years of age. A booster seat is designed to improve the fit of the vehicle's safety belt system. Booster seats with shields use lap-only belts; however, booster seats without shields use lap-shoulder belts. Booster seats can also help a child to see out the window.

When choosing a child restraint, be sure the child restraint is designed to be used in a vehicle. If it is, it will have a label saying that it meets federal motor vehicle safety standards.

Then follow the instructions for the restraint. You may find these instructions on the restraint itself or in a booklet, or both. These restraints use the belt system in your vehicle, but the child also has to be secured within the restraint to help reduce the chance of personal injury. The instructions that come with the infant or child restraint will show you how to do that. Both the owner's manual and the child restraint instructions are important, so if either one of these is not available, obtain a replacement copy from the manufacturer.

The child restraint must be secured properly in the center of a full bench seat or the center of a two-passenger bench seat, if it doesn't interfere with shifting gears.

Keep in mind that an unsecured child restraint can move around in a collision or sudden stop and injure people in the vehicle. Be sure to properly secure any child restraint in your vehicle -- even when no child is in it.

## Top Strap

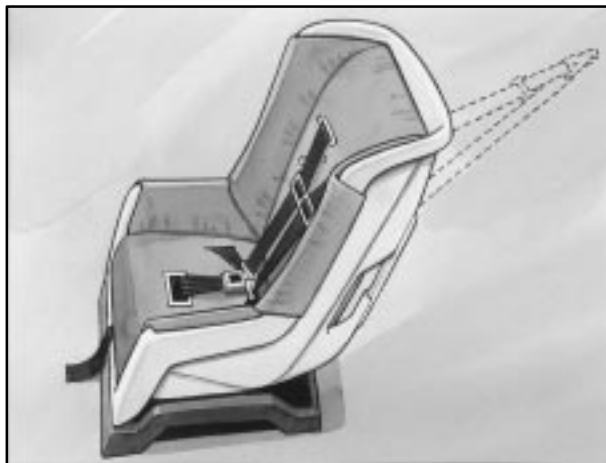

If your child restraint has a top strap, it should be anchored. If you need to have an anchor installed, your dealer can obtain a kit with anchor hardware and installation instructions specifically designed for this vehicle. The dealer can then install the anchor for you. This work will be done free of charge. Or you may install the anchor yourself using the instructions provided in the kit.

## Securing a Child Restraint in the Center Seat Position (Full Bench Seat and Two-Passenger Bench Seat)

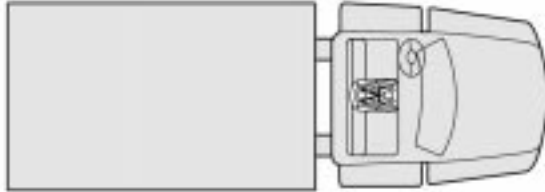

You'll be using the lap belt. Be sure to follow the instructions that came with the child restraint. Secure the child in the child restraint when and as the instructions say. But don't use this position if the child restraint interferes with shifting gears.

See the earlier part about the top strap if the child restraint has one.



1. Make the belt as long as possible by tilting the latch plate and pulling it along the belt.
2. Put the restraint on the seat.
3. Run the vehicle's safety belt through or around the restraint. The child restraint instructions will show you how.



4. Buckle the belt. Make sure the release button is positioned so you would be able to unbuckle the safety belt quickly if you ever had to.
5. To tighten the belt, pull its free end while you push down on the child restraint. If you're using a forward-facing child restraint, you may find it helpful to use your knee to push down on the child restraint as you tighten the belt.
6. Push and pull the child restraint in different directions to be sure it is secure.

To remove the child restraint, just unbuckle the vehicle's safety belt. It will be ready to work for an adult or larger child passenger.

## Larger Children



Children who have outgrown child restraints should wear the vehicle's safety belts.

If you have the choice, a child should sit next to a window so the child can wear a lap-shoulder belt and get the additional restraint a shoulder belt can provide.

- Children who aren't buckled up can be thrown out in a crash.
- Children who aren't buckled up can strike other people who are.

**⚠ CAUTION:**

**Never do this.**

**Here two children are wearing the same belt. The belt can't properly spread the impact forces. In a crash, the two children can be crushed together and seriously injured. A belt must be used by only one person at a time.**

- Q:** What if a child is wearing a lap-shoulder belt, but the child is so small that the shoulder belt is very close to the child's face or neck?
- A:** Move the child toward the center of the vehicle, but be sure that the shoulder belt still is on the child's shoulder, so that in a crash the child's upper body would have the restraint that belts provide. If the child is so small that the shoulder belt is still very close to the child's face or neck, you might want to place the child in a seat that has a lap belt, if your vehicle has one.



**⚠ CAUTION:**

Never do this.

**Here a child is sitting in a seat that has a lap-shoulder belt, but the shoulder part is behind the child. If the child wears the belt in this way, in a crash the child might slide under the belt. The belt's force would then be applied right on the child's abdomen. That could cause serious or fatal injuries.**

Wherever the child sits, the lap portion of the belt should be worn low and snug on the hips, just touching the child's thighs. This applies belt force to the child's pelvic bones in a crash.

## Safety Belt Extender

If the vehicle's safety belt will fasten around you, you should use it.

But if a safety belt isn't long enough to fasten, your dealer will order you an extender. It's free. When you go in to order it, take the heaviest coat you will wear, so the extender will be long enough for you. The extender will be just for you, and just for the seat in your vehicle that you choose. Don't let someone else use it, and use it only for the seat it is made to fit. To wear it, just attach it to the regular safety belt.

## Checking Your Restraint Systems

Now and then, make sure the safety belt reminder light (if your vehicle has one) and all your belts, buckles, latch plates, retractors and anchorages are working properly. Look for any other loose or damaged safety belt system parts. If you see anything that might keep a safety belt system from doing its job, have it repaired.

Torn or frayed safety belts may not protect you in a crash. They can rip apart under impact forces. If a belt is torn or frayed, get a new one right away.

## Replacing Restraint System Parts After a Crash

If you've had a crash, do you need new belts?

After a very minor collision, nothing may be necessary. But if the belts were stretched, as they would be if worn during a more severe crash, then you need new belts.

If belts are cut or damaged, replace them. Collision damage also may mean you will need to have safety belt or seat parts repaired or replaced. New parts and repairs may be necessary even if the belt wasn't being used at the time of the collision.

## Section 2 Features and Controls

---

Here you can learn about the many standard and optional features on your vehicle, and information on starting, shifting and braking. Also explained are the instrument panel and the warning systems that tell you if everything is working properly -- and what to do if you have a problem.

2-2	Keys	2-30	Running Your Engine While You're Parked (Automatic Transmission)
2-4	Door Locks	2-30	Windows
2-5	Theft	2-31	Tilt Wheel (If Equipped)
2-5	New Vehicle "Break-In"	2-32	Turn Signal/Multifunction Lever
2-6	Ignition Positions	2-39	Trailer Brake Hand Control Valve (Option)
2-7	Starting Your Gasoline Engine	2-40	Inter-Axle Differential Lock Control (If Equipped)
2-10	Starting Your Diesel Engine	2-41	Rear Axle Differential Lock Control (If Equipped)
2-13	Engine Checks Before Operating	2-42	Engine Air Control (If Equipped)
2-15	Engine Coolant Heater (If Equipped)	2-43	Exterior Lamps
2-16	Diesel Engine Exhaust Brake	2-46	Interior Lamps
2-17	Two-Speed Rear Axle Electric Shift Control (If Equipped)	2-46	Mirrors
2-20	Automatic Transmission Operation	2-50	Instrument Panel
2-22	Manual Transmission Operation	2-52	Instrument Panel Cluster
2-23	Parking	2-55	Warning Lights, Gages and Indicators
2-29	Parking Over Things That Burn		
2-29	Engine Exhaust		

## Keys

### CAUTION:

Leaving children in a vehicle with the ignition key is dangerous for many reasons. A child or others could be badly injured or even killed. They could operate the controls or even make the vehicle move. Don't leave the keys in a vehicle with children.





The square-head key is for the ignition switch only.



The oval-head key is for the doors.

If you have the optional one-key system, the oval key will operate all locks, including the ignition switch.

When a new vehicle is delivered, the dealer removes the plugs from the keys and gives them to the first owner. Each plug has a code on it that tells your dealer or a qualified locksmith how to make extra keys. Keep the plugs in a safe place. If you lose your keys, you'll be able to have new ones made easily using this code.

### **NOTICE:**

**Your vehicle has a number of new features that can help prevent theft. But you can have a lot of trouble getting into your vehicle if you ever lock your keys inside. You may even have to damage your vehicle to get in. So be sure you have extra keys.**

## Door Locks

### CAUTION:

**Unlocked doors can be dangerous.**

**Passengers -- especially children -- can easily open the doors and fall out. When a door is locked, the inside handle won't open it.**

**Outsiders can easily enter through an unlocked door when you slow down or stop your vehicle.**

**This may not be so obvious: You increase the chance of being thrown out of the vehicle in a crash if the doors aren't locked. Wear safety belts properly, lock your doors, and you will be far better off whenever you drive your vehicle.**



To lock your door from the inside, slide the lock control down.

To unlock the door, slide the lock control up.

### Power Door Locks (If Equipped)



Push the switch marked LOCK to lock both doors at once.

Push the switch marked UNLOCK to unlock both doors.

## Leaving Your Vehicle

If you are leaving the vehicle, take your keys, open your door and set the locks from inside. Then get out and close the door.

## Theft

Vehicle theft is big business, especially in some cities, and even commercial vehicles are no exception. Although your vehicle has a number of theft-deterrent features, we know that nothing we put on it can make it impossible to steal. However, there are ways you can help.

## Key in the Ignition

If you leave your vehicle with the keys inside, it's an easy target for joy riders or professional thieves -- so don't do it.

Remember to remove your key and take it with you. Always do this. When you take your key with you, your ignition will be locked. Also remember to lock the doors.

## New Vehicle “Break-In”

### NOTICE:

**Your vehicle doesn't need an elaborate “break-in.” But it will perform better in the long run if you follow these guidelines:**

- **Let your engine warm up before you operate your vehicle under load.**
- **Keep your speed at 55 mph (88 km/h) or less for the first 500 miles (805 km).**
- **Don't drive at any one speed -- fast or slow -- for the first 500 miles (805 km). Don't make full-throttle starts.**
- **Avoid making hard stops for the first 200 miles (322 km) or so. During this time your new brake linings aren't yet broken in. Hard stops with new linings can mean premature wear and earlier replacement. Follow this breaking-in guideline every time you get new brake linings.**

**NOTICE: (Continued)**

**NOTICE: (Continued)**

- Use the lowest gear you can when you start a loaded vehicle in motion and when going up hills to avoid overloading the engine.
- Check and adjust engine and transmission fluid levels often and be sure tires are properly inflated for the load you're carrying.
- If you have a Caterpillar<sup>®</sup> diesel engine, see the Caterpillar Operation & Maintenance Manual.

**Ignition Positions** **CAUTION:**

Leaving children in a vehicle with the ignition key is dangerous for many reasons. A child or others could be injured or even killed. They could operate power windows or other controls or even make the vehicle move. Don't leave the keys in the vehicle with children.

Use your square-head key to start your vehicle (unless it has the single-key option, where one oval-head key works everything, including the ignition). You can turn the ignition switch to five different positions.



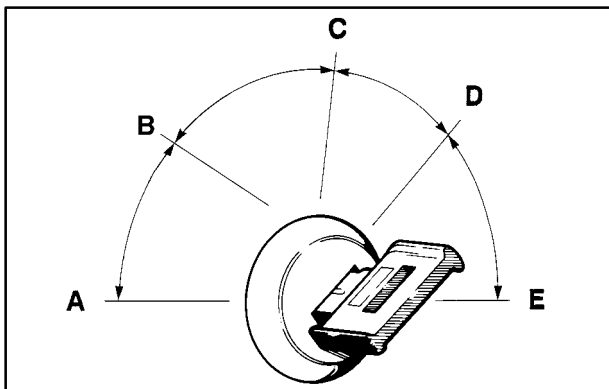

**ACCESSORY (A):** This position lets you use accessories when the engine is off. To use ACCESSORY, push in the key and turn it toward you.

**LOCK (B):** This position locks your ignition. You will be able to remove your key only when the switch is in this position.

**OFF (C):** This position lets you turn off the engine, but the key can't be removed.

**RUN (D):** This is the position for driving and activating the CAT diesel air inlet heater (if equipped).

**START (E):** This position starts your engine.

## Engine Starter Over-Crank Protection (If Equipped)

Some vehicles have an engine starter over-crank protection system. This system includes a built-in temperature limiting switch to prevent internal damage to the starter. If the starter motor overheats and shuts off due to over-cranking, the motor must cool down before the switch will reset and allow you to operate the starter. It can take up to six minutes before the starter will work again.

## Starting Your Gasoline Engine

Engines start differently. The 8th digit of your Vehicle Identification Number (VIN) shows the code letter for your engine. (See "Vehicle Identification Number" in the Index.) Follow the proper steps to start the engine.

To start a diesel engine, see "Starting Your Diesel Engine" in the Index.

## Automatic Transmission

Set the parking brake and move your shift lever to NEUTRAL (N) or PARK (P) if so equipped. Your engine won't start in any other position -- that's a safety feature.

## Manual Transmission

Set the parking brake, shift your gear selector to NEUTRAL and hold the clutch pedal to the floor while starting the engine.

## Starter Motor Operation

1. The starter motor will disengage if you release the key or the engine reaches a predetermined engine speed.
2. To prevent overheating, the starter motor will disengage after continuously operating for 15 seconds. You must release the key from the start position to re-engage the starter.
3. The starter motor will not engage if the engine is already running.
4. The starter motor will disengage if, after two seconds, the starter pinion gear does not engage the flywheel or there is no engine rpm signal from the engine speed sensor.

## Starting Your Engine

1. Without pushing the accelerator pedal, turn your ignition key to START. When the engine starts, let go of the key. The idle speed will go down as your engine gets warm.
2. If the engine doesn't start in 10 seconds, push the accelerator pedal all the way down and crank the engine for five more seconds, unless it starts sooner.
3. If your engine still won't start (or starts but then stops), it could be flooded with too much gasoline. Wait 15 seconds to let the starter motor cool down. Do Steps 1 through 3 again.

When the engine starts, let go of the key and the accelerator pedal.

## NOTICE:

**Your engine is designed to work with the electronics in your vehicle. If you add electrical parts or accessories, you could change the way the engine operates. Before adding electrical equipment, check with your dealer. If you don't, your engine might not perform properly.**

**If you ever have to have your vehicle towed, see the part of this manual that tells how to do it without damaging your vehicle. See "Towing Your Vehicle" in the Index.**

## Gasoline Engine Warm-Up

When you've started your engine, let it run for 20 or 30 seconds to warm up before you put a load on the engine.

Drive at moderate speeds for the first few miles, especially in cold weather. Running a cold engine at high speed can damage it.

## Restarting the Gasoline Engine While Moving (Automatic Transmission)

If you have to restart the engine while the vehicle is moving, you'll first have to shift the automatic transmission to NEUTRAL (N). This safety feature prevents starting the engine when the transmission is in a drive gear.

## Stopping the Gasoline Engine

Let your engine idle for a few seconds before turning it off after you have finished driving your vehicle.

If you shift to NEUTRAL (N), set the parking brake. If you shift to PARK (P), the auto-apply feature will set the parking brake.

If your vehicle has a two-speed axle, put the range selector in LOW. To be sure the axle has shifted into LOW, engage the clutch and transmission the vehicle may move slightly when you do this.

While your engine is idling before you turn it off, you can make a list of any operational or handling concerns to give to responsible maintenance personnel so they can handle them right away.

Moisture will condense in a fuel tank that is almost empty if the vehicle is not run for a while, even just overnight under some conditions. So, it's always best to refuel your vehicle at the end of each run.

## Starting Your Diesel Engine

If you have a Caterpillar diesel engine, also refer to your Caterpillar<sup>®</sup> Operation & Maintenance Manual for starting procedure.

To make starting easier in cold weather (below 32°F or 0°C), the proper viscosity engine oil should be used. It's also best to heat the engine oil first. You can do this by using an engine coolant heater. A GM Automatic Ether Injection System aids cold weather starting.

### NOTICE:

**Your diesel engine has an electric air intake heater system which reduces white smoke and helps start the engine in cold weather. Do not spray starting fluid into the air intake where it can contact the heater elements.**

**If you don't have the GM Automatic Ether Injection System, don't use starting fluid or you could damage your engine. If you have the GM system, use only GM approved starting fluid that has been tested to establish compatibility with the air inlet heater system.**

### NOTICE:

**If you ever have to have your vehicle towed, see the part of this manual that tells how to do it without damaging your vehicle. See "Towing Your Vehicle" in the Index.**

## Restarting the Diesel Engine While Moving (Automatic Transmission)

If you have to restart the engine while the vehicle is moving, you'll first have to shift the automatic transmission to NEUTRAL (N). This safety feature prevents starting the engine when the transmission is in a drive gear.

## Stopping the Diesel Engine

If you have a Caterpillar diesel engine, see your Caterpillar<sup>®</sup> Operation & Maintenance Manual.

1. Set the parking brake and shift to NEUTRAL (N) or PARK (P).
2. Turn the ignition switch key to OFF.

If your vehicle has a two-speed axle, see "Rear Axle, Two-Speed Electric Shift Control" or "Rear Axle, Two-Speed Airshift Control" in the Index.

## Cold Weather Starting (Caterpillar® Diesel)

Because the diesel engine uses compression ignition, it is harder to start in cold weather than a gasoline engine. The air intake heater and use of the proper engine oil, optional engine coolant heaters and optional ether injection systems help cold weather starting. See the Caterpillar® Operation & Maintenance Manual for more information.

## Diesel Engine Warm-Up

Several factors affect how quickly your diesel engine warms up. These can include outside temperature, engine load, idle time and your vehicle's option content. Your vehicle may be equipped with some features that can help the engine reach operating temperature sooner. Some of these features are discussed below.

Also, remember that an automatic transmission adds heat to the cooling system through the heat exchanger in the radiator. Because of this, vehicles equipped with automatic transmissions are often able to retain engine coolant heat better than manual transmission vehicles.

See your Caterpillar® Operation & Maintenance manual for additional diesel engine warm-up information.

## Engine Automatic Shutdown (If Equipped)

Your CHECK GAGES light will come on if the system senses high engine temperature or low engine oil pressure. If high engine temperature is detected, you will also hear a tone alarm at two beats per second. The alarm and the light will remain on until the condition is fixed. If the engine temperature condition worsens, the tone alarm will go to five beats per second. When a low oil pressure condition is detected, the five beat per second alarm will come on immediately.

If the system senses low engine coolant, the five beat per second alarm and the LOW COOLANT warning light will come on.

The five beats per second tone alarm means that your engine will shut down in 25 seconds. Pull off the road and shut off the engine. Don't start it until the reason for the problem is known, and the problem is fixed. If the engine shuts down when you are still in traffic, you can restart the engine and get another 25 seconds of operation. Do this only if you have to, since there is a problem that can harm the engine if it isn't fixed.

## Fast Idle System (Electronically Controlled Caterpillar® Diesel and Gasoline Engines)

If your vehicle is equipped with an electronically controlled diesel engine, it has both automatic and manual fast idle capabilities.

### Automatic Fast Idle System (Caterpillar® Diesel Engine Only)

The automatic fast idle feature will engage whenever you start your vehicle and the engine is below the preset operating temperature. This will help decrease engine warm-up time.

Idle speed will then return to normal under any of the following conditions:

- The engine reaches the preset operating temperature.
- The brake pedal is pressed.
- The trailer brake hand lever (if equipped) is applied.
- The manual transmission clutch pedal is pressed or, the automatic transmission (if equipped) is shifted from NEUTRAL (N) or PARK (P).
- The vehicle speed exceeds approximately 10 mph (16 km/h).
- When the fast idle switch is pressed a second time.

## Manual Fast Idle System (Caterpillar® Diesel and Gasoline Engines)



The manual fast idle switch is located on the lower portion of the instrument panel just to the left of the steering wheel.

This system can be used to increase your engine idle speed whenever the following conditions are met:

- The brake pedal is not pressed.
- The trailer brake hand lever (if equipped) is not applied.
- The vehicle speed is below approximately 10 mph (16km/h).
- The manual transmission (if equipped) clutch pedal is not pressed or, the automatic transmission (if equipped) is in NEUTRAL (N).

The manual fast idle feature is activated by pressing the switch on the instrument panel. When the switch is pressed again, or any of the previous conditions are not met, manual fast idle will be deactivated.

Manual fast idle can be used to set any desired idle speed. To set a new temporary engine idle speed:

1. Make sure all of the previously described conditions are met.
2. Press the accelerator pedal to the desired engine speed.
3. Momentarily press the manual FAST IDLE switch.

The temporary idle speed will be set. This new rpm level will be remembered by the system until either the ignition is turned to OFF or a new idle speed is set.

## **Radiator Shutters -- Caterpillar® (If Equipped)**

Radiator shutters aid engine warm-up by blocking the airflow through the radiator and charge the air cooler to conserve heat in cold conditions.

The radiator shutters on your vehicle (if equipped) operate automatically. When the ignition switch is in RUN or START and the engine temperature is below 195°F (90°C), the shutters will close, blocking the flow of air through the radiator and charge the air cooler.

When the engine temperature reaches 195°F (90°C), the shutters will open to the normal operating position.

## **Engine Checks Before Operating**

When you've started your engine, let it run for 20 to 30 seconds before you put a load on the engine. But *don't* leave the vehicle while the engine is running.

During this warm-up period, check your warning lights and gages:

- If oil pressure doesn't begin to rise within 15 seconds of starting, stop the engine and find the cause.
- If the engine coolant temperature gage needle goes into the hot area on the gage, stop the engine and find the cause of the overheating.
- If you have air brakes, the dual-needle air pressure gage should read at least 105 psi (720 kPa) for both service systems before you try to move the vehicle. When air pressure is below 60 psi (420 kPa), the LOW AIR light will come on and you will hear a tone alarm. If the pressure doesn't build up or drops during warm-up, stop the engine and find the cause before you try to move the vehicle. Recommended air pressure before actually driving away is 120 psi (830 kPa).

- The charging system light should come on when the ignition switch key is turned to RUN or START and should go out when the engine is running above idle. If the light doesn't go out or comes back on during normal engine operation, have the charging system checked right away. (This light tells you if the generator is not charging; it doesn't reflect the condition of the battery.)
- The voltmeter charge indicator gage tells you the condition of your battery's charge. The gage should be in the center area during engine operation. The red area on the left indicates an undercharge condition; the red area on the right indicates an overcharge. If the gage is in either red area, have the battery and charging system checked right away.

## NOTICE:

**Don't allow the engine to operate at low idle for more than five minutes. This can cause low engine operating temperatures which can affect engine operation and reduce engine life. Engine idle speed should be increased to 1200 rpm whenever extended idle is required. Once started, the engine should be placed under load to allow the engine coolant temperature to reach 150°F (66°C) before shutting off the engine.**



## Engine Coolant Heater (If Equipped)



If your vehicle has this feature, the plug-in receptacle is located behind the front bumper as shown, or in the component box on the driver's side of the vehicle.

In very cold weather, 0°F (-18°C) or colder, the engine coolant heater can help. You'll get easier starting and better fuel economy during engine warm-up. Usually, the coolant heater should be plugged in a minimum of four hours prior to starting your vehicle.

## To Use the Engine Coolant Heater

1. Turn off the engine.
2. Find the plug-in receptacle (either behind the front bumper or in the component box).
3. Plug a heavy-duty, three-prong extension cord (rated for at least 15 amps) into the vehicle's plug-in receptacle first. Then plug the extension cord into a normal, grounded 110-volt AC outlet.

### CAUTION:

**Plugging the cord into an ungrounded outlet could cause an electrical shock. Also, the wrong kind of extension cord could overheat and cause a fire. You could be seriously injured. Plug the cord into a properly grounded three-prong 110-volt AC outlet. Use a heavy-duty three-prong extension cord rated for at least 15 amps.**

4. Before starting the engine, be sure to unplug the cord.

How long should you keep the coolant heater plugged in? The answer depends on the outside temperature. Above 32°F (0°C), the coolant heater is not required. From 32°F to -10°F (0°C to -23°C), keep the coolant heater plugged in at least two hours. Below -10°F (-23°C), keep the coolant heater plugged in for a minimum of eight hours or overnight. It will not harm either the coolant heater or the vehicle to leave the coolant heater plugged in longer than the times stated. Be sure to remove and store the cord before starting the engine. See “Diesel Fuel Requirements and Fuel System” in the Index for information on what fuel to use in cold weather.

## Diesel Engine Exhaust Brake

The exhaust brake is available on vehicles equipped with a diesel engine and air brakes (or an air compressor). It is located in the exhaust system.



The switch is on the upper right side of the instrument panel and turns the exhaust brake on and off.

The exhaust brake indicator light is on when the exhaust brake is in use.

The exhaust brake is used to help slow the vehicle and may assist the vehicle's foundation brakes. The use of the exhaust brake will assist the braking of the vehicle and prolong the life of the foundation brake lining material.

When using the exhaust brake, the proper gear range selection is important. The exhaust brake will be most effective if the gear range selected is the lowest possible range that does not allow the engine rpm to go more than 200 rpm above rated (full load) rpm as shown on the Engine Information Plate. (Do not exceed 2900 rpm.)

The accelerator and clutch pedals must be released in order for the exhaust brake to engage. Whenever the exhaust brake is active, the light in the switch will be on.

Do not use the exhaust brake when running the engine at idle during warm-up or other extended periods. Prolonged use of the exhaust brake during idling will cause the engine to overheat.

### CAUTION:

**Be careful when using the exhaust brake or you could lock the wheels and lose control of the vehicle. Operators not familiar with an exhaust brake should not use this brake on slippery surfaces before learning to use it on dry surfaces. If the vehicle's wheels begin to lock when using the exhaust brake on slippery surfaces, switch the exhaust brake off immediately. The exhaust brake will turn off if the anti-lock brake system is activated.**

## Two-Speed Rear Axle Electric Shift Control (If Equipped)

If your vehicle has this feature, you'll find a label (or labels) on the ceiling above the windshield or in another place near the driver that show how to use it. Be sure to follow the directions carefully. Use the following directions based on the type of shift control you have.

### Automatic Transmission



The switch for the rear axle shift control is on the shift tower to the right of the shift lever.

When the switch is up, the rear axle is in the high range. Push it down to get the low range.

The two-speed axle should be in low range when you park the vehicle. Apply the parking brake, shift to PARK (P) or NEUTRAL (N) and shut off the engine.

To operate off-road or under a heavy load, shift into low range when the vehicle is standing still and then operate the transmission normally.

On the highway, with the axle in low range and transmission in top gear, you may shift the axle to high range by raising the switch and releasing the accelerator momentarily. Re-apply the accelerator after your shift.

Under light load conditions, first shift the axle into the high range with the vehicle at a standstill and then operate the transmission normally.

## Manual Transmission



The switch for the rear axle shift control is on the shift lever. When the switch is up, the rear axle is in the high range. Push it down to get the low range.

The two-speed axle should be in low when you park the vehicle. You'll need to engage the transmission, even move the vehicle a little, to be sure the axle is in the low range. Then apply the parking brake, shift into NEUTRAL and shut off the engine.

Also, always start the vehicle in motion with the two-speed axle in the low range. When you upshift the rear axle from low to high, move the switch up for the high range, disengage the clutch, pause, engage the clutch and then press down on the accelerator. When you shift the axle down from high to low, you don't have to clutch. Just move the switch down to low, release the accelerator and then quickly apply it again.

## Air Shift Control (Manual Transmissions Only)



The lever for the rear axle shift control is either at the lower right corner of the instrument panel or on the shift lever.

When the lever is moved to HI, the rear axle will be in the high range. Switch it to LOW to get the low range.

The two-speed axle should be in LOW when you park the vehicle.

You'll need to engage the transmission, even moving the vehicle a little, to be sure the axle is in the low range. Then apply the parking brake, shift into NEUTRAL and shut off the engine.

Also, always start the vehicle in motion with the two-speed axle in the LOW position. When you upshift the rear axle from LOW to HI, move the lever to the HI position, disengage the clutch, pause, engage the clutch and then press down on the accelerator. When you shift the axle down from HI to LOW, you don't have to clutch. Just move the lever to LOW, release the accelerator and then quickly press it down again.

## Air Suspension (If Equipped)

Your vehicle may be equipped with the Hendrickson HAS Series single-axle air suspension which is designed for single-axle on-highway use. This feature is available in the 19,000 lb. capacity and as a low profile option for operations which require extra cubic capacity and a reduced deck height.

With this air suspension system, the ride height is set during vehicle assembly so that the vehicle has a constant frame height. The system will then increase or decrease air pressure in the air springs to maintain this height.

## Air Suspension Dump Control (If Equipped)

If your vehicle is equipped with the Hendrickson HAS Series single-axle air suspension, you may have this control. The air suspension dump control allows the operator to lower the deck height approximately 4.5 inches (11.5 cm) from the normal frame height.



The switch to deflate and inflate the air suspension is located on the upper left side of the instrument panel above the driver's side vent.

The light in the switch will be illuminated whenever the switch is in the "dumped" position.

## Automatic Transmission Operation

We build vehicles with four, five and six-speed automatic transmissions. This part of the manual covers the basics of these. With some of the transmissions, you will find another manual in your vehicle that goes into more detail. On the ceiling, in front of and above the driver, or in some other place near the driver, you will see a label that describes important operating facts about the automatic transmission in your vehicle. Make sure you follow the instructions on this label.

You may have a PARK (P) position for your shift lever. This position locks your rear wheels. It is the best position to use when you start your engine because your vehicle can't move easily.

All vehicles equipped with automatic transmissions can be started in PARK (P), if equipped, or in NEUTRAL (N). When you shift out of NEUTRAL (N), you may have to hold in a push button on the shift lever or lift up on a release handle as you shift. See the Allison Automatic Transmission Operator's Manual in your vehicle for more information about this.

 **CAUTION:**

**It is dangerous to get out of your vehicle if the shift lever is not fully in PARK (P) with the parking brake firmly set. Your vehicle can roll. Don't leave your vehicle when the engine is running unless you have to. If you have left the engine running, the vehicle can move suddenly. You or others could be injured. To be sure your vehicle won't move, even when you're on fairly level ground, always set your parking brake and move the shift lever to PARK (P). See "Shifting Into PARK (P)" in the Index.**

 **CAUTION:**

**Shifting out of PARK (P) or NEUTRAL (N) while your engine is "racing" (running at high speed) is dangerous. Unless your foot is firmly on the brake pedal, your vehicle could move very rapidly. You could lose control and hit people or objects. Don't shift out of PARK (P) or NEUTRAL (N) while your engine is racing.**

### **Automatic Transmission Third Gear Hold (If Equipped)**

If you have this feature, your range selector has a "2-3" position. You can't shift up to the next higher gear when the transmission is in this position unless your engine-governed speed is exceeded, such as when going downhill.

This feature is useful for certain load and traffic conditions or when plowing snow. See the Allison Automatic Transmission Operator's Manual in your vehicle for further information.

## Manual Transmission Operation

This part of the manual covers the basics of the manual transmission. With some of the transmissions, you will find another manual in your vehicle that goes into more detail.

### Using the Clutch

When you're starting to move the vehicle, it's important to begin with the engine speed at idle. Then start to engage the clutch and listen for an engine speed drop of about 100 rpm. At this point, the clutch is engaging, so you should increase the engine speed and fully engage the clutch. It's important not to increase the engine speed sooner or before the clutch begins its engagement. If you do, you can cause damage to your vehicle.

### Double-Clutching

You must use the "double-clutching" method when you shift an unsynchronized gear set. Simply disengage the clutch, shift to NEUTRAL (N) and engage the clutch. When you're shifting down to a lower gear, accelerate the engine speed while in NEUTRAL (N) to get ready for the lower gear.

## Eaton Fuller 5 and 6-Speed Transmissions and Dana Spicer 7-Speed Transmissions

These transmissions have gears that automatically synchronize when you shift up or down (except FIRST (1) gear on the five-speed transmission which is unsynchronized). Choose the gear which will maintain the road speed you want while keeping the engine above two-thirds of the governed speed. When the engine speed drops below two-thirds of the governed speed, shift into the next lower gear before your engine begins to lug. When you shift down, be sure to double-clutch if required.

## Eaton Fuller 9 and 10-Speed Manual Transmissions

If your vehicle has one of these unsynchronized transmissions, it's naturally somewhat complicated. The label above the windshield will tell you the operating basics you need to know.

Before operating the vehicle with one of these transmissions, be sure to read the Eaton Fuller Transmission Driver Instructions Manual in your vehicle.



## Eaton Fuller Transmission with Clutch Brake (Option)

Some vehicles have an optional clutch brake. It engages when you push your clutch pedal all the way to the floor. Use it when you shift into first or reverse gear. Press the clutch pedal as far as it will go and then make your shift. If the engagement isn't smooth when you engage the clutch, press the clutch pedal in and then immediately re-engage it. Use the clutch brake only with the engine idling and the vehicle standing still.

If you have this feature, see the Eaton Fuller Transmission Driver Instructions Manual before operating your vehicle.

## Eaton Fuller Transmission with Countershaft Brake (If Equipped)

The countershaft brake is used when you shift from a standing start into FIRST (1) or REVERSE (R). You will find this feature on vehicles with gasoline engines and Eaton Fuller 9 or 10-speed transmissions.

See the Eaton Fuller Transmissions Driver Instructions Manual.

## Parking

### CAUTION:

**If you don't park your vehicle properly, it can roll. If you've left the engine running, it can move very quickly. You or others could be injured. To be sure your vehicle won't move, even when you're on level ground, follow the steps below.**

## Two-Speed Rear Axle

1. With the engine running, shift the two-speed rear axle into low. To be sure it's in low, you'll need to move the vehicle in gear just a little.
2. Hold the regular brake pedal down with your right foot.
3. Apply the parking brake.
4. Shift the transmission to NEUTRAL (N) or PARK (P).

## Hydraulic Brakes

If your vehicle has hydraulic brakes, it has a parking brake lever or an electric/hydraulic parking brake. The lever is below the instrument panel to the left of the steering column. The electric/hydraulic parking brake knob is to the right of the steering column.

Your vehicle may also be equipped with an automatic transmission which has a shift lever. This lever will have a PARK (P) position on the shift indicator. When the PARK (P) position is selected with the shift lever, the parking brake is automatically applied.

## Propshaft Brake Burnish Procedure

It is recommended that the propshaft-mounted parking brake be burnished as part of the new vehicle break-in. The parking brake will work best after it has been burnished following these instructions.

Make 10 stops, using the parking brake hand lever, from 20 mph (32 km/h) about 2 1/2 miles (4 km) apart. Between stops, drive the vehicle at 20 mph (32 km/h).

## Lever Operated Parking Brake



To apply the parking brake, pull the lever all the way up. The PARK BRAKE light will come on when the parking brake is applied. Then shift the transmission to NEUTRAL (N) or PARK (P).

The vehicle must be stopped when applying the parking brake, except while burnishing the parking brake linings (see “Propshaft Brake Burnish Procedure” in the Index).

You can easily adjust the parking brake by turning the knob on the lever. Turning it clockwise makes the brake grip more tightly. It will also make the lever seem harder to pull up. Turning the knob counterclockwise makes the parking brake apply less firmly. Adjust the parking brake only when the lever is down (released).

If your parking brake doesn't hold the vehicle when applied, see your GM Truck dealer who can adjust your parking brake properly.



To release the parking brake, first push down the regular brake pedal. Then, push the parking brake lever all the way down and shift the automatic transmission to NEUTRAL (N).

The PARK BRAKE light will remain illuminated if the parking brake is not fully released.

## NOTICE:

**Driving with the parking brake on can overheat the parts in the system. You may have to replace them, and you could also damage other parts of your vehicle.**

## Electric/Hydraulic Parking Brake (If Equipped)

## CAUTION:

**It will take a few seconds for the parking brake to fully apply, and even longer when it is cold outside. Do not leave your vehicle until the parking brake applies fully. Without the parking brake applied, your vehicle is free to move. It could hit someone or something.**



If your vehicle has this system, you will have a knob to the right of the steering column.

To apply the parking brake, pull the knob toward you. Then shift the transmission to NEUTRAL (N) or PARK (P).

Push the knob in to release the parking brake. The ignition must be in RUN and the shift lever out of PARK (P) in order to release the parking brake.

The parking brake will automatically apply if the ignition is turned off and in PARK (P) and will also apply (will not release) if the vehicle's battery is dead or disconnected.

The PARK BRAKE light may flash while the parking brake is being applied or released. This is normal for this system.

If your vehicle needs towing or the parking brake will not release, the towing operator will need to disconnect the propshaft before towing your vehicle. See "Towing Your Vehicle" in the Index.

### Air Brake (If Equipped)

#### CAUTION:

**When the yellow SYSTEM PARK and the red TRAILER AIR SUPPLY knobs are both pushed in, your rig will be free to move. It could strike someone or something. When both of these knobs are pushed in, either hold the regular brake pedal down or, if you have it, pull out the blue TRACTOR PARKING knob, to keep your rig from moving.**



If your vehicle has air brakes, you will have this control. Pulling it out applies the parking brake. The PARK BRAKE light will come on when the air parking brake is applied.

Vehicles built for use as tractors or towing vehicles have one or two more air brake controls. They look like this:



To charge a trailer's air brake system:

1. Move your tractor into the proper position. Apply the parking brake by pulling the yellow SYSTEM PARK knob out.
2. Hook up the trailer air system properly.
3. Get into the tractor. Push and hold down the regular brake pedal.
4. Push in both the yellow SYSTEM PARK and the red TRAILER AIR SUPPLY knobs. This will charge your trailer's air system.

If you have the blue TRACTOR PARKING knob, pull it out to set the tractor brakes while the air system is charging.

After a few minutes, the trailer system should be fully charged. When it is, the air pressure gage will show about 125 to 135 psi (862 to 931 kPa) and you may hear the "pop off" valve operate.

For driving with a trailer, the yellow, red and blue (if equipped) knobs all must be pushed in. It's the same when you're not pulling a trailer except that the red TRAILER AIR SUPPLY knob must be out.

 **CAUTION:**

**If you apply any one of the air brake parking controls while the vehicle is moving, your rig will stop suddenly. If you are not ready for this, you or others could be injured. Don't apply any one of these controls while you're driving, unless you have to make an emergency stop.**

 **CAUTION:**

**If your vehicle is left in gear, the engine can start if the vehicle starts to roll. This can easily happen if you have the diesel engine. Shift the transmission into NEUTRAL (N) before you leave the vehicle.**

If the air pressure drops below 60 to 70 psi (413 to 482 kPa), the PRIMARY BRAKE light will come on. If the air pressure drops to 40 to 45 psi (275 to 309 kPa), the yellow knob will automatically pop out and apply the spring brakes. If you ever have a complete loss of air so that your air brakes automatically apply, there is a way that the tow operator can release the parking brakes to tow the vehicle. See "Towing Your Vehicle" in the Index.

## Parking Over Things That Burn



### CAUTION:

Things that can burn could touch hot exhaust parts under your vehicle and ignite. Don't park over papers, leaves, dry grass or other things that can burn.

## Engine Exhaust

### CAUTION:

Engine exhaust can kill. It contains the gas carbon monoxide (CO), which you can't see or smell. It can cause unconsciousness and death.

You might have exhaust coming in if:

- Your exhaust system sounds strange or different.
- Your vehicle gets rusty underneath.
- Your vehicle was damaged in a collision.
- Your vehicle was damaged when driving over high points on the road or over road debris.
- Repairs weren't done correctly.
- Your vehicle or exhaust system had been modified improperly.

If you ever suspect exhaust is coming into your vehicle:

- Drive it only with all the windows down to blow out any CO; and
- Have your vehicle fixed immediately.

## Running Your Engine While You're Parked (Automatic Transmission)

It's better not to park with the engine running. But if ever you have to, here are some things to know.

### CAUTION:

**Idling the engine with the climate control system off could allow dangerous exhaust into your vehicle (see the earlier Caution under "Engine Exhaust").**

**Also, idling in a closed-in place can let deadly carbon monoxide (CO) into your vehicle even if the fan switch is at the highest setting. One place this can happen is a garage. Exhaust -- with CO -- can come in easily. NEVER park in a garage with the engine running.**

**Another closed-in place can be a blizzard. (See "Blizzard" in the Index.)**

### CAUTION:

**It can be dangerous to get out of your vehicle without the parking brake firmly set. Your vehicle can roll. If you've left the engine running, the vehicle can move suddenly. You or others could be injured. To be sure your vehicle won't move, even when you're on fairly level ground, always set your parking brake.**

Follow the proper steps to be sure your vehicle won't move.

## Windows

### Manual Windows

Turn the hand crank on each door to raise or lower the window.



## Power Windows (If Equipped)

If you have power windows, the controls are on each door. The driver's door has a switch for the passenger's window as well. Your power windows will not move unless the ignition switch is turned to RUN.



Push the switch marked with an up arrow to raise the window. Push the switch marked with a down arrow to lower the window.

## Horn

Sound the horn by pushing the center of the steering wheel. If you have the optional air horn, it is controlled by a cord that you'll find up above and to the left of the driver. The harder you pull on the cord, the louder the air horn will sound. The air horn works only after your air system pressure gets up to about 60 psi (415 kPa).

## Tilt Wheel (If Equipped)

A tilt steering wheel allows you to adjust the steering wheel before you drive. You can also raise it to the highest level to give your legs more room when you enter or exit the vehicle.



To tilt the wheel, hold the steering wheel and pull the lever. Move the steering wheel to a comfortable level, then release the lever to lock the wheel in place.

## Turn Signal/Multifunction Lever



The lever on the left side of the steering column includes your:

- Turn Signal and Lane Change Indicator
- Headlamp High/Low Beam Changer
- Windshield Wipers
- Windshield Washer
- Cruise Control (If Equipped)

## Turn Signal and Lane Change Indicator

The turn signal has two upward (for right) and two downward (for left) positions. These positions allow you to signal a turn or a lane change.

To signal a turn, move the lever all the way up or down. When the turn is finished, the lever will return automatically.

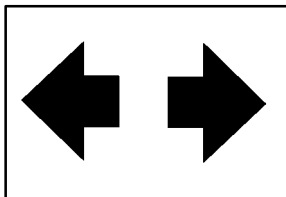

An arrow on the instrument cluster will flash in the direction of the turn or lane change.

To signal a lane change, just raise or lower the lever until the arrow starts to flash. Hold it there until you complete your lane change. The lever will return by itself when you release it.

As you signal a turn or a lane change, if the arrows don't flash but just stay on, check the turn signal flasher and circuit breaker. See "Fuses and Circuit Breakers" in the Index.

If a bulb is burned out, replace it to help avoid an accident. If the arrows don't go on at all when you signal a turn, check the circuit breaker and for burned-out bulbs. (See "Fuses and Circuit Breakers" in the Index.)

## Signal-Stat Turn Signal and Hazard Warning Flasher (If Equipped)

If you have this signal system, it is mounted beside or behind the multifunction lever on the left side of the steering column.

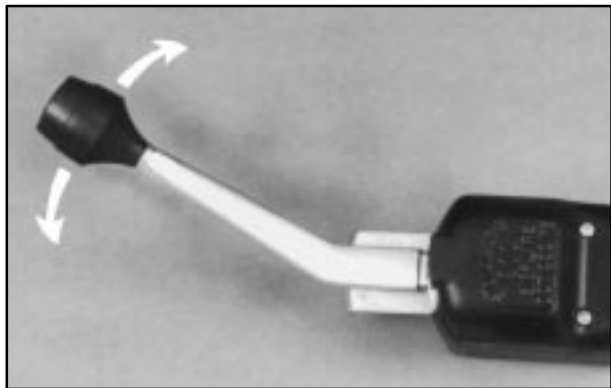

To signal a turn, move the lever all the way up or down. When the turn is completed, move the lever back to the center position.

An arrow on the instrument panel will flash in the direction of the turn when the lever is in the up or down position.

This system replaces the turn signal feature of the multifunction lever only. All other features such as headlamp high/low beam, windshield wipers and washer, etc. remain part of the multifunction system.

If you have this system, see “Signal-Stat Turn Signal and Hazard Warning Flasher” in the Index to find out how the hazard warning flasher portion works.

## Headlamp High/Low Beam Changer

To change the headlamps from low beam to high, push the multifunction lever away from you. To switch back to low beam, pull the lever toward you.

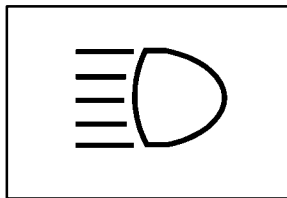

When the high beams are on, a light on the instrument cluster will also be on.

## Windshield Wipers



The windshield wipers are controlled by turning the band with the wiper symbol on it.

For a single wiping cycle, turn the band to MIST. Hold it there until the wipers start, then let go. The wipers will stop after one cycle. If you want more cycles, hold the band on MIST longer.

For steady wiping at low speed, turn the band away from you to the LO position. For fast wiping, turn the band to HI. To stop the wipers, turn the band to the off symbol.

## Low Speed Delay Wipers (If Equipped)



You can set the wiper speed for a long or short delay between wipes. This can be very useful in light rain or snow. Turn the band to choose the delay time. The closer to LO, the shorter the delay.

Heavy snow or ice can overload your wipers. Clear away snow or ice to prevent bending or breaking the wiper linkage.

## Windshield Washer

At the top of the multifunction lever, there's a paddle with the word PUSH on it. To spray washer fluid on the windshield, push the paddle.

### CAUTION:

**In freezing weather, don't use your washer until the windshield is warmed. Otherwise the washer fluid can form ice on the windshield, blocking your vision.**

If you have the standard wipers, the wipers will keep going in LO until you turn the wiper control to the off symbol.

If you have the low-speed delay option, the wipers will clear the window and then either stop or return to your preset speed.

## Cruise Control (If Equipped)



With cruise control, you can maintain a speed of about 30 mph (48 km/h) or more without keeping your foot on the accelerator. Cruise control does not work at speeds below about 30 mph (48 km/h).

If you have an automatic transmission and you apply your brakes, the cruise control will shut off.

If you have a manual transmission and you apply your brakes or push the clutch pedal, the cruise control will shut off.

### CAUTION:

- **Cruise control can be dangerous where you can't drive safely at a steady speed. So, don't use your cruise control on winding roads or in heavy traffic.**
- **Cruise control can be dangerous on slippery roads. On such roads, fast changes in tire traction can cause needless wheel spinning, and you could lose control. Don't use cruise control on slippery roads.**

## Setting Cruise Control

### CAUTION:

**If you leave your cruise control switch on when you're not using cruise, you might hit a button and go into cruise when you don't want to. You could be startled and even lose control. Keep the cruise control switch off until you want to use it.**

1. Move the cruise control switch to ON.
2. Get up to the speed you want.
3. Press in the SET button at the end of the lever and release it.
4. Take your foot off the accelerator pedal.

## Resuming a Set Speed

Once you're going about 30 mph (48 km/h) or more, you can move the cruise control switch from ON to R/A (Resume/Accelerate) for about half a second.

The vehicle will return to your chosen speed and stay there.

If you hold the switch at R/A longer than half a second, the vehicle will keep going faster until you release the switch or apply the brake, so unless you want to go faster, don't hold the switch at R/A.

If the switch is held at R/A for longer than 200 seconds, the cruise control will automatically turn off. The cruise control function will be made available again the next time the engine is restarted.

## Increasing Speed While Using Cruise Control

There are two ways to go to a higher speed:

- Use the accelerator pedal to get to the higher speed. Press the button at the end of the lever, then release the button and the accelerator pedal. You'll now cruise at the higher speed.
- Move the cruise switch from ON to R/A. Hold it there until you get up to the speed you want, and then release the switch. To increase your speed in very small amounts, move the switch to R/A for less than half a second. Each time you do this, your vehicle will go about 1 mph (1.6 km/h) faster.

If the switch is held at R/A for longer than 200 seconds, the cruise control will automatically turn off. The cruise control function will be made available again the next time the engine is restarted.

## Reducing Speed While Using Cruise Control

Press in the button at the end of the lever until you reach the lower speed you want, then release it.

To slow down in very small amounts, tap the button for less than half a second. Each time you do this, you'll go 1 mph (1.6 km/h) slower.

If the button is held for longer than 15 seconds, the cruise control will automatically turn off. To make cruise control available again, the cruise switch must be moved to OFF then back to ON.

## Passing Another Vehicle While Using Cruise Control

Use the accelerator pedal to increase your speed. When you take your foot off the pedal, your vehicle will slow down to the cruise control speed you set earlier.



## Using Cruise Control on Hills

How well your cruise control will work on hills depends upon your speed, load and the steepness of the hills. When going up steep hills, you may want to step on the accelerator pedal to maintain your speed. When going downhill, you may have to brake or shift to a lower gear to keep your speed down. Of course, applying the brake or clutch takes you out of cruise control. Many drivers find this to be too much trouble and don't use cruise control on steep hills.

## Ending Cruise Control

There are different ways to turn off the cruise control:

- Step lightly on the brake pedal.
- Push the clutch pedal, if you have a manual transmission.
- Move the cruise switch to OFF.

## Erasing Speed Memory

When you turn off the ignition, your cruise control set speed memory is erased.

## Trailer Brake Hand Control Valve (Option)

If your vehicle has this feature, it is mounted on the steering column.



This control lets you apply the trailer brakes without applying the tractor brakes. You can apply the trailer brakes a little or apply them all the way if you have to. Use this control only when you're driving. Don't use it for parking or to hold the rig on a hill.

**⚠ CAUTION:**

Using the trailer brake hand control for parking or for holding the vehicle on a hill may not keep the vehicle from rolling. This can happen if someone hits the valve by accident, or if air pressure bleeds from the system. If the vehicle rolls, you or others could be injured. To park the vehicle or hold it on a hill, use the parking brake properly.

## Inter-Axle Differential Lock Control (If Equipped)



If your vehicle has this feature, the control is located at the lower right corner of the instrument panel.

If you're approaching a slippery surface where it looks like one or even all of the wheels may start to slip, you can use this control. It locks your rear differentials so that power is transmitted equally to both rear axles.

Let up on the accelerator before you turn on your inter-axle differential lock. When you turn on this control, the DIFF LOCK indicator on the instrument panel will light.

## NOTICE:

**Activating the inter-axle differential lock when the rear wheels are actually spinning freely, as they might on ice or snow, can cause you to lose control of the vehicle. It can also damage the axles. Turn on this control only when the wheels are not spinning freely.**

## Rear Axle Differential Lock Control (If Equipped)



If your vehicle has a Controlled Traction or Locking Differential axle, the control is located at the lower right corner of the instrument panel. You'll see this control on single rear axle vehicles.

If you're approaching a slippery surface where it looks like one or even both wheels may start to slip, you can use this control. It locks your rear differential so that power is transmitted equally to both rear wheels.

Let up on the accelerator before you turn on your rear axle differential lock.

## NOTICE:

**Activating the rear-axle differential lock when the rear wheels are actually spinning freely, as they might on ice or snow, can cause you to lose control of the vehicle. It can also damage the axle. Turn on this control only when the wheels are not spinning freely.**

## Engine Air Control (If Equipped)



If your vehicle has this control, the handle is located on the instrument panel just to the right of the steering wheel. The control is activated by pulling the handle out and turning slightly in either direction to lock it.

When the handle is pulled out, the engine air intake supply is closed off from the front scoop and an under hood air supply is opened. This control is intended only for use in cold weather (32° F (0° C) or below) where snow and ice might plug the external intake.

At temperatures above 32° F (0° C), keep the control handle pushed in.

### **NOTICE:**

**Operating this vehicle with the engine air control on when outside temperatures are above 32° F (0° C), could lead to costly repairs not covered by your warranty. It will also degrade fuel economy and the engine will not run smoothly.**

## **Exterior Lamps**

### **Headlamps**

The lamp switches are on the left side of your instrument panel.



Press the top left switch to turn on your:

- Parking Lamps
- Marker Lamps (unless your vehicle has the optional marker and clearance lamps switch)
- Taillamps
- Instrument Panel Lights
- License Plate Lamps

Push the bottom left switch to turn on the headlamps, as well as all of the lamps just listed. Push the switch marked with the “O” symbol to turn off your lamps.

Move the thumbwheel to the right of the off switch down to dim your instrument panel lights. Moving this wheel up makes these lights brighter. Moving it all the way up will make the interior lamp come on.

A circuit breaker protects your headlamps. If you have an electrical overload, your headlamps will flicker on and off. Have your headlamp wiring checked right away if this ever happens.

## Headlamps On Reminder (If Equipped)

If you have this system, a tone alarm will sound when your headlamps and/or parking lamps are turned on and your ignition is in OFF, LOCK or ACCESSORY.

## Daytime Running Lamps (If Equipped)

Daytime Running Lamps (DRL) can make it easier for others to see the front of your vehicle during the day. DRL can be helpful in many different driving conditions, but they can be especially helpful in the short periods after dawn and before sunset.

The high and low-beam headlamps will come on at reduced brightness in daylight when:

- The ignition is on,
- The headlamp switch is off and
- The parking brake is released.

When the DRL are on, only your low-beam headlamps will be on. The exterior lamps won't be on. Your instrument panel won't be lit up either.

When it begins to get dark, your DRL indicator light is a reminder to turn your headlamp switch on. The other lamps that come on with your headlamps will also come on.

When you turn the headlamp switch off, the regular lamps will go off, and your low-beam headlamps will change to the reduced brightness of DRL.

To idle your vehicle with the DRL off, set the parking brake. The DRL will stay off until you release the parking brake.

As with any vehicle, you should turn on the regular headlamp system when you need it.

### **Marker and Clearance Lamps Switch (If Equipped)**



Your vehicle will have this switch only if it is designed to pull a trailer. If it has this switch, you'll find it on the upper right side of your instrument panel, just above the radio.

If your vehicle has no radio, the switch is just above the storage area. Use the switch to operate your clearance and marker lamps. The marker lamps are illuminated when the indicator light is on.



Your headlamps switch will not operate these lamps. You can use the switch to manually blink the marker and clearance lamps by simply turning it on and off.

## Interior Lamps

### Dome Lamp

The dome lamps will come on when you open the driver's door. You can also turn the dome lamps on by turning the interior lamp dimmer dial all the way up until it clicks.

### Mirrors

#### Inside Rearview Mirror (If Equipped)

Press the tab under the mirror to reduce glare at night from headlamps behind you.

#### Outside Mirrors



Adjust the outside mirror or mirrors by hand so you can just see the side of your vehicle when you're sitting in the driver's seat. These mirrors can fold in toward the vehicle for entering narrow garages and for clearance in an automatic vehicle wash.

If your mirrors have the clearance lamps, they'll be on when your parking lamps are on.

## Convex Outside Mirrors (Option)

Your vehicle may have optional convex mirrors. A convex mirror's surface is curved so you can see more from the driver's seat.

### CAUTION:

**A convex mirror can make things (like other vehicles) look farther away than they really are. If you cut too sharply into the right or left lane, you could hit a vehicle. Check your regular outside mirrors (or your inside mirror, if you have one) before changing lanes.**



## Heated Outside Mirrors (If Equipped)



If your vehicle has heated mirrors, you'll find this switch on the upper right side of your instrument panel area, just above the radio. Use it to operate your mirror heaters to defrost or defog your mirrors.

When you turn on the mirror heaters, an indicator light in the switch will be lit to tell you the heaters are on. Once the mirrors are clear for viewing, turn the switch off. The mirror heaters remain on until the heater switch or ignition switch is turned off. However, when you turn the ignition back on, the heater switch will again be on until turned off.

## Ashtray and Cigarette Lighter (If Equipped)

The ashtray is just below the gages on the right side of your instrument panel. If you have a cigarette lighter, it is inside the ashtray.

To use the lighter, press it in all the way and let go. When it's ready, it will pop back by itself.

### **NOTICE:**

**Don't hold a cigarette lighter in with your hand while it is heating. If you do, it won't be able to back away from the heating element when it's ready. That can make it overheat, damaging the lighter and heating element.**

To remove the ashtray for cleaning, pull up on the front of it.

**NOTICE:**

**Don't put papers and other things that burn into your ashtray. If you do, cigarettes or other smoking materials could set them on fire, causing damage.**

## Sun Visors

To block out glare, you can move the sun visors. You can also swing them from side to side.

## Auxiliary Power Jacks (If Equipped)



If your vehicle has these power jacks, you'll find them in the ashtray.

These jacks provide 12-volt power so you can operate things such as a citizen's band (CB) radio or a cellular phone. You'll see positive (red) and negative (black) outlets. They have a 20-amp fuse that is common with the cigarette lighter. Don't use the cigarette lighter when you're using a power jack because it may overload the circuit and blow the fuse.

**NOTICE:**

**Whether or not your vehicle has the power outlets, don't plug in FM communications gear at the ashtray area. FM equipment creates high heat, and over time the area could get so hot that wires could be damaged or a fire could even break out.**

## Trailer Connections (If Equipped)

These connections are located at the rear of the cab. There is an air connection and a trailer electrical connection.

Be sure that the couplings to the trailer are made correctly.

### Air Connections



The red line is the supply line. It provides emergency or constant air pressure. The blue line is the control line, providing service air.

## Electrical Connections (If Equipped)

If your vehicle has this system, it has a seven-wire cable that will go to the trailer to supply electrical power to the trailer's lighting system. When not in use, it is stored in the trailer air-hose storage bracket.

### NOTICE:

**Starting in 1998, the center pin (also known as the auxiliary circuit) of the 7-pin trailer electrical connector will be wired to provide continuous power for the trailer anti-lock brake systems when the ignition key is in ON or RUN. Care should be taken to insure that continuous power on this circuit will not cause damage to the trailer electrical system.**

**Consult with the trailer manufacturer for the proper operation and checking procedures for the trailer anti-lock brake systems.**

## Instrument Panel

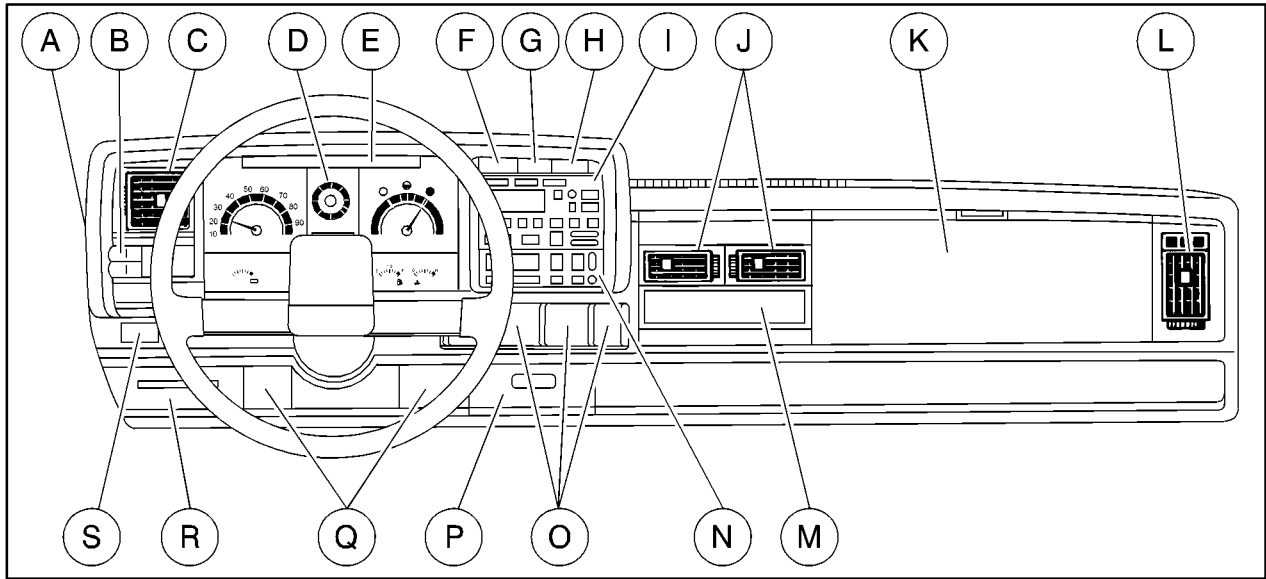

- A. Left Side Window Defogger
- B. Main Lamps Switch
- C. Vent
- D. Instrument Cluster
- E. Warning Lights
- F. Heated Mirror Switch (Option)
- G. Exhaust Brake Switch (Option)
- H. Marker/Clearance Lamps Switch (Option)
- I. Audio System or Storage Area
- J. Vents
- K. Glove Box
- L. Right Side Window Defogger
- M. Storage Tray/Cassette Player
- N. Comfort Controls
- O. Air Brake Controls (If Equipped)
- P. Ashtray
- Q. Air Vent Controls
- R. Convenience Center Fuse Panel
- S. Hourmeter (Option)

## Instrument Panel Cluster

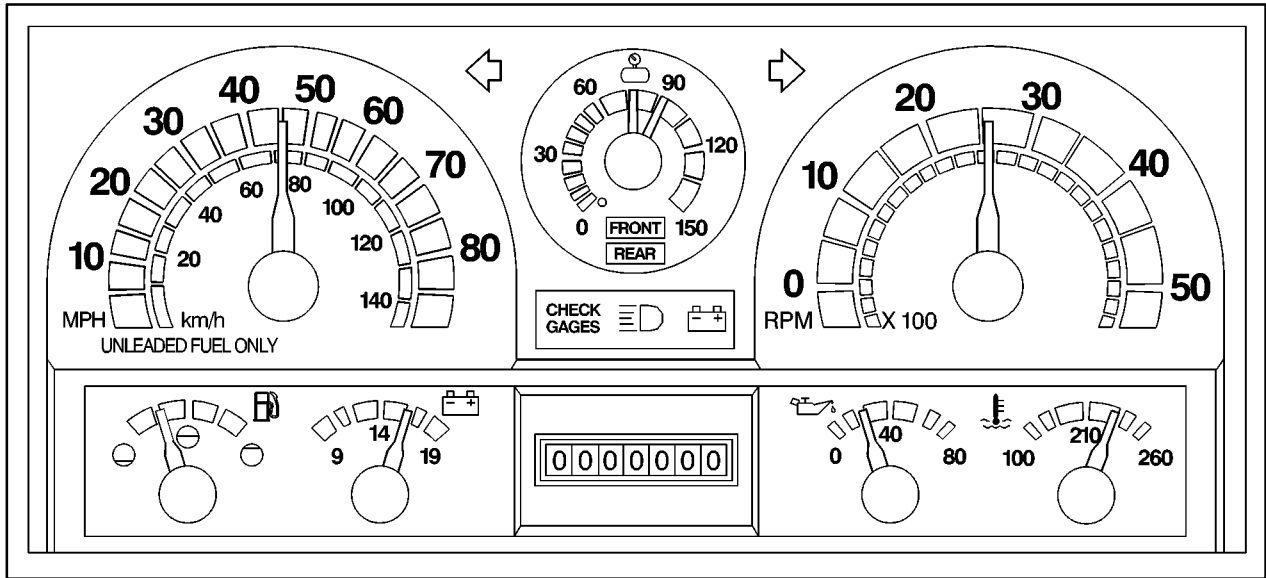

Your instrument cluster is designed to let you know at a glance how your vehicle is running. You'll know how fast you're going, about how much fuel is left and many other things you'll need to drive safely and economically.

## Speedometer

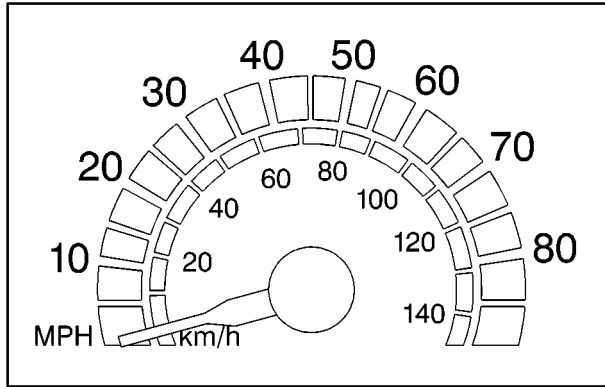

Your speedometer lets you see your speed in both miles per hour (mph) and kilometers per hour (km/h).

## Tamper Resistant Odometer

Your odometer shows how far your vehicle has been driven, in either miles (used in the United States) or kilometers (used in Canada).

Your odometer is tamper-resistant. The odometer will show silver lines between the numbers if someone tries to turn it back.

You may wonder what happens if your vehicle needs a new odometer installed. If the new one can be set to the mileage total of the old odometer, then it must be. But if it can't, then it's set at zero, and a label must be put on the driver's door to show the old mileage reading when the new odometer was installed.

## Engine Speed Governor

All gasoline engines have a electronic engine speed governor. The engine governed speeds range between 3600 and 4000 rpm depending on model, engine size and option content.

## Engine Road Speed Governor (Gasoline Engine)

This system controls maximum vehicle speed automatically and reduces engine power until vehicle speed gets down to maximum governed speed.

A 75 mph (120 km/h) road speed governor is standard, but is optionally available in 60 or 65 mph (97 or 105 km/h) speeds, depending on model.

## Tachometer (If Equipped)

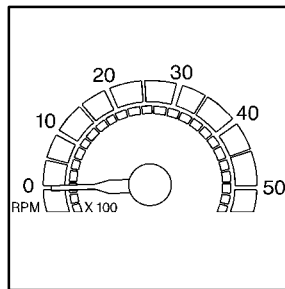

**Gasoline Engine**

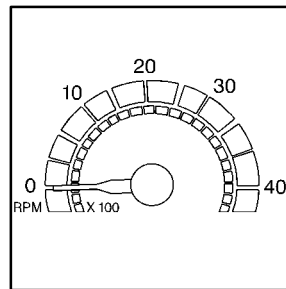

**Diesel Engine**

This gage shows the engine speed in revolutions per minute (rpm).



## Warning Lights, Gages and Indicators

This part describes the warning lights and gages that may be on your vehicle. The pictures will help you locate them.

Warning lights and gages can signal that something is wrong before it becomes serious enough to cause an expensive repair or replacement. Paying attention to your warning lights and gages could also save you or others from injury.

Warning lights come on when there may be or is a problem with one of your vehicle's functions. As you will see in the details on the next few pages, some warning lights come on briefly when you start the engine just to let you know they're working. If you are familiar with this section, you should not be alarmed when this happens.

Gages can indicate when there may be or is a problem with one of your vehicle's functions. Often gages and warning lights work together to let you know when there's a problem with your vehicle.

When one of the warning lights comes on and stays on when you are driving, or when one of the gages shows there may be a problem, check the section that tells you what to do about it. Please follow this manual's advice. Waiting to do repairs can be costly -- and even dangerous. So please get to know your warning lights and gages. They're a big help.

### Safety Belt Reminder Light (Option)



When the key is turned to RUN or START, a light will come on for about eight seconds to remind people to fasten their safety belts.

### Safety Belt Reminder Tone (Option)

When the key is turned to RUN or START, a tone will sound for about eight seconds to remind people to fasten their safety belts.

## Charging System Indicator Light

### CAUTION:

**If your vehicle has an electric/hydraulic parking brake, do not drive if the charging system light is on. If the battery drains too much, the parking brake can suddenly come on and stop the vehicle. This can cause severe injury to you and others.**

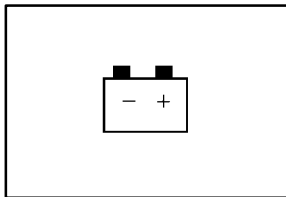

The charging system light is located in the center of the instrument cluster just above the odometer.

It should come on briefly when you turn on the ignition, before the engine is running, as a check to show that it is working.

If it stays on, or comes on while you are driving, have it checked right away. You could have a loose generator drive belt or some other problem.

Driving while this light is on could drain your battery. If you must drive a short distance with the light on, turn off your radio and other accessories.

Sustained driving with a generator failure could result in a lack of back-up braking if the engine quits or the power steering pump should fail.

## Voltmeter

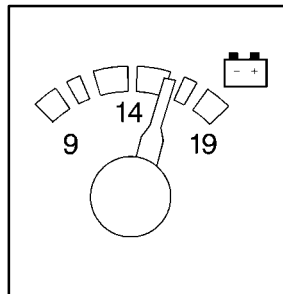

When your engine is running, the voltmeter gage, at the lower left of the instrument cluster, shows the charging system voltage.

Readings in either warning zone indicate a possible problem in the electrical system.

Readings in the low warning zone may occur when a large number of electrical accessories are operating in the vehicle and the engine is left at an idle for an extended period. This condition is normal since the charging system may not be able to provide full power at engine idle. As engine speeds are increased, this condition should correct itself because higher engine speeds allow the charging system to create maximum power.

You can only drive a short time on the battery. Be sure to shut off the radio, the fan or any unnecessary accessories and have the system serviced.

### Do Not Shift Warning Light

A rectangular box containing the text "DO NOT SHIFT" in bold, black, uppercase letters, centered.

If your vehicle has the Allison MD automatic transmission, certain transmission malfunctions will turn this light on.

If this light comes on while you are driving, do not use the transmission shift control. Using the transmission shift control will result in the loss of forward gears. The computer for the transmission senses a problem and chooses a gear to stay in so that you can drive the vehicle in that gear. You may not be able to drive as fast or back up when this light is on.

#### **NOTICE:**

**If the DO NOT SHIFT warning light comes on while you are driving, it is a warning that making a transmission “range” change could leave you stranded. The vehicle may not continue to move if you change gears with the transmission shift control. The transmission can’t operate in all gears because something is wrong. Leave the shift control alone and drive directly to a GM dealer for service. If you can’t go in for service immediately, have the vehicle towed.**

### Brake System Warning Light

Your vehicle has either hydraulic or air brakes. Each system has different warning lights.

## Hydraulic Brake System Warning Lights

Vehicles with hydraulic systems have two brake system warning lights on the instrument panel.

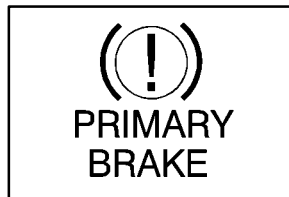

If the PRIMARY BRAKE warning light comes on, it means that the fluid level in the master cylinder reservoir is low or there is another problem with your primary hydraulic brakes.

When it comes on, you will also hear a warning tone.

The PRIMARY BRAKE warning light may come on, and the warning tone may sound, when you're turning and braking at the same time. This is normal. See "Hydraulic Brake Systems" in the Index.

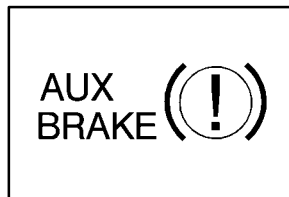

If the AUX BRAKE warning light comes on, it means that there is something wrong in the auxiliary brake system.

When this light comes on, you will also hear a warning tone.

Both of these lights should come on briefly every time you start the engine. If they don't come on then, have them fixed so they will be ready to warn you if there's a problem. If one or both of these warning lights stay on after you start the engine, there could be a brake problem. Have your brake system inspected right away.

If one or both of these lights come on and stay on while you are driving, pull off the road and stop carefully. You may notice that the pedal is harder to push. Or, the pedal may go closer to the floor. It may take longer to stop. If either light is still on, have the vehicle towed for service. (See "Towing Your Vehicle" in the Index.) See "Hydraulic Brake Systems" in the Index for more information.

### CAUTION:

**Your brake system may not be working properly if a brake system warning light is on. Driving with either of the brake system warning lights on can lead to an accident. If either light is still on after you've pulled off the road and stopped carefully, have the vehicle towed for service.**

## Air Brake System Warning Light

Vehicles with air brake systems have one brake system warning light on the instrument panel.

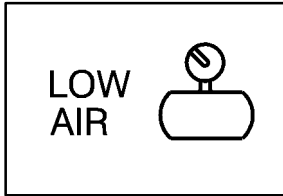

The LOW AIR warning light should come on, as a check, whenever you start the engine.

However, it is designed to come on, and stay on, when brake reservoir pressure has dropped below 60 to 70 psi (410 to 480 kPa).

When this warning light comes on, you will also hear a warning tone. If the warning light and tone come on while you are driving, you should drive only as far as the nearest point of safety and then stop the vehicle. Here's a very important thing for you to know:

### CAUTION:

**If the LOW AIR warning light comes on and the warning tone sounds, the vehicle can stop suddenly and without further warning. This is because the parking brake will come on if the pressure falls below 40 to 45 psi (275 to 310 kPa). You or others could be injured. If the LOW AIR warning light comes on and the warning tone sounds, stop as soon as you can. You won't know how quickly the system is losing pressure, so be aware that the parking brake may come on suddenly.**

## Apply Park Brake Warning Light (Option)

**APPLY  
PARK  
BRAKE**

This light warns the driver that the ignition has been turned off without applying the parking brake. The warning light should come on, as a check, when you start the engine.

When it comes on, you will also hear a warning tone. Leaving the vehicle in this condition could result in your vehicle moving and will discharge the battery.

## Parking Brake Warning Light

**SERVICE  
PARK  
BRAKE**

This light turns on as a check when the engine is first started and any time the system needs adjustment or there is a malfunction in the electric/hydraulic parking brake system.

When the SERVICE PARK BRAKE light comes on, you will also hear a warning tone. If this light comes on, have the system repaired immediately.

**⚠ CAUTION:**

**If the SERVICE PARK BRAKE warning light comes on and the warning tone sounds, your vehicle can stop suddenly and without further warning. You or others could be injured. If the SERVICE PARK BRAKE warning light and the warning tone come on, pull over to the side of the road and apply the parking brake immediately.**

## Parking Brake Indicator Light

**(P)  
PARK  
BRAKE**

Vehicles with hydraulic or air brakes have a parking brake indicator light. When the ignition is on, this light will come on when you set your parking brake.

The light will stay on if your parking brake doesn't release fully.

This light should also come on when you turn the ignition key to START. If it doesn't come on then, have it fixed so it will be ready to remind you if the parking brake is applied or hasn't released fully.

## Anti-Lock Brake System Warning Light (Option)

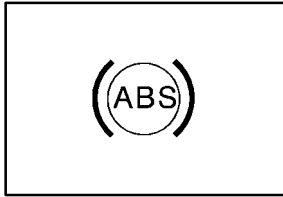

With the anti-lock brake system, this light will come on when you start your engine and it may stay on for several seconds. That's normal.

If the light stays on, or comes on when you're driving, your vehicle needs service. If the PRIMARY BRAKE or LOW AIR warning light isn't on, you still have brakes, but you don't have the anti-lock brake feature. If the PRIMARY BRAKE and/or LOW AIR warning light is on, you don't have anti-lock brakes and there's a problem with your regular brakes. See "Brake System Warning Light" earlier in this section.

The anti-lock brake system warning light should come on briefly when you turn the ignition key to RUN. If the light doesn't come on then, have it fixed so it will be ready to warn you if there is a problem.

## Engine Coolant Temperature Gage

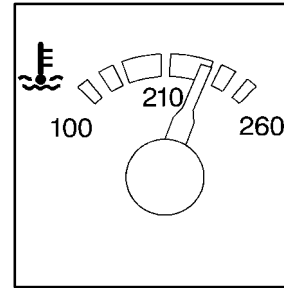

Gasoline Engine

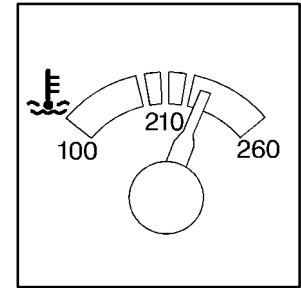

Diesel Engine

This gage shows the engine coolant temperature. If the gage pointer moves into the red area, your engine coolant might have overheated and your engine may be too hot. You should pull off the road, stop your vehicle and turn off the engine as soon as possible.

See "Engine Overheating" in the Index. If you have a Caterpillar® diesel engine, also see your Caterpillar® Operation & Maintenance Manual.

## Low Coolant Warning Light

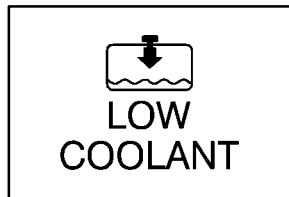

You have a **LOW COOLANT** warning light. If this light comes on, your system is low on coolant and the engine may overheat.

The warning light should come on briefly, as a check, when you turn on the ignition.

When it comes on, you will also hear a warning tone at five beats per second for 10 seconds. See “Engine Coolant” in the Index and have your vehicle serviced as soon as you can.

This light may also come on if your vehicle is equipped with the optional automatic engine shutdown system and engine shutdown has begun. See “Engine Automatic Shutdown” in the Index.

## Manual Fast Idle Indicator Light (If Equipped)

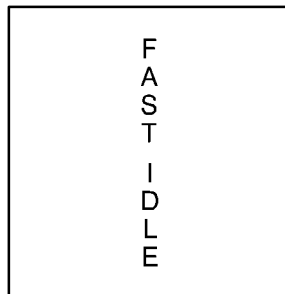

If your vehicle is equipped with an electronically controlled diesel engine or gasoline engine, you may have this indicator light. It is located next to the **FAST IDLE** switch on the lower, driver’s side of the instrument panel.

This light will illuminate whenever the manual **FAST IDLE** feature is engaged. For more details about this system, see “Fast Idle System” in the Index.



## Intake Heater Indicator Light (Diesel Engines)



This light on the instrument panel will come on when the intake heater is on and the ignition key is in ON.

Since the light is illuminated whenever the intake heater is activated, it is normal for the light to cycle on and off as the heater cycles during engine warm-up. See “Engine Starting” in your Caterpillar® Operation & Maintenance Manual for more information.

## Diff Lock Indicator Light (If Equipped)

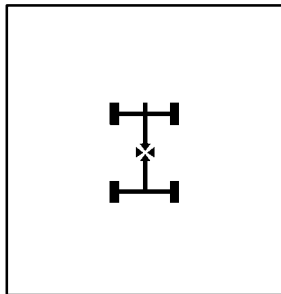

This light on the instrument panel is on when the inter-axle differential lock system is in use.

The light will come on momentarily during starting. If the light fails to come on, have it repaired as soon as possible so you will be aware when the lock system is in use.

## Service Trans Filter Indicator Light (If Equipped)



If your vehicle has this light, you'll find it below the cluster on the instrument panel.

It monitors the transmission fluid filter. If it ever goes on, it means your transmission filter is dirty and requires replacement.

## Malfunction Indicator Lamp (Check Engine Light)

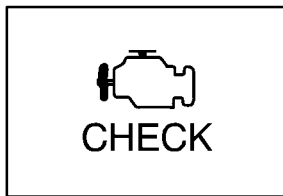

If your vehicle is equipped with either a gasoline engine or an electronically controlled diesel engine, you will have this light.

If this light comes on or flashes while you are driving, two things may happen.

First, you won't notice any difference in engine performance, but your tail pipe emissions may increase. Second, your engine may not run properly or may stall without warning. If either of these things happen, drive or tow your vehicle to your dealer for service.

This light should come on when the ignition is on, but the engine is not running, as a check to show you it is working. If it does not come on at all, have it repaired.

## NOTICE:

If you keep driving your vehicle with this light on, after a while, your emission controls may not work as well, your fuel economy may not be as good and your engine may not run as smoothly. This could lead to costly repairs that may not be covered by your warranty.

## Engine Oil Pressure Gage

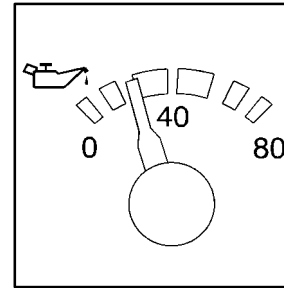

Gasoline Engine

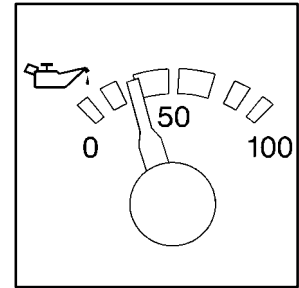

Diesel Engine

The engine oil pressure gage, on the lower right portion of your instrument cluster, shows engine oil pressure in psi (pounds per square inch) or in kPa (kilopascals). Oil pressure may vary with outside temperature and oil viscosity, but readings of 30 to 40 psi (205 to 275 kPa) on gasoline engines at operating temperature and moderate road speeds are normal. If you have a diesel engine, the normal operating range should be between 35 and 70 psi (240 to 480 kPa).

A reading in the low pressure zone may be caused by a dangerously low oil level or other problem.

If you have a Caterpillar<sup>®</sup> diesel engine, also see your Caterpillar<sup>®</sup> Operation & Maintenance Manual.

**⚠ CAUTION:**

**Don't keep driving if the oil pressure is low. If you do, your engine can become so hot that it catches fire. You or others could be burned. Check your oil as soon as possible and have your vehicle serviced.**

**NOTICE:**

**Damage to your engine from neglected oil problems can be costly and is not covered by your warranty.**

## Change Oil Light (If Equipped)

**CHANGE  
OIL**

The CHANGE OIL light should come on briefly as a bulb check when you start the engine. If the light doesn't come on, have it serviced.

If the CHANGE OIL light comes on and stays on after you start the engine, have the oil changed.

For additional information, see "Engine Oil, When to Change" in the Index. To reset the Oil Life Monitor, see "Engine Oil Life Monitor" in the Index.

## Daytime Running Lamps (DRL) Indicator Light

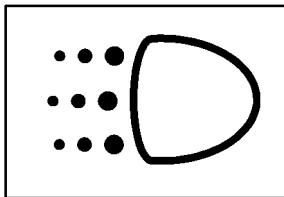

This light is located on the upper cluster portion of the instrument panel. It goes on whenever the Daytime Running Lamps are on. See “Daytime Running Lamps” in the Index.

When it begins to get dark, the DRL indicator light is a reminder to turn on your headlamps.

## Check Gages Indicator Light (If Equipped)



This light will come on as you’re starting the engine, just as a check.

If it ever comes on and stays on while you are driving, however, it means that either your engine coolant temperature gage or your engine oil pressure gage may be showing a reading in the warning zone.

When the CHECK GAGES light comes on, you will also hear a warning tone. The tone and the light will stay activated until the problem is corrected.

This light may also come on if your vehicle is equipped with the optional automatic engine shutdown system and engine shutdown has begun. See “Engine Automatic Shutdown” in the Index.

## Fuel Gage

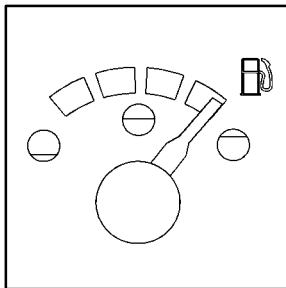

**Gasoline Engine**

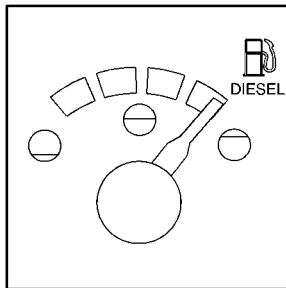

**Diesel Engine**

Your fuel gage will be on the right side of your instrument cluster if your vehicle doesn't have the optional tachometer. If you have a tachometer, your fuel gage is on the lower left portion of your instrument cluster.

When the ignition is on, your fuel gage lets you know about how much fuel you have left. When the gage first shows empty, you'll still have a little fuel left, but you should get more fuel soon.

If your vehicle has dual fuel tanks, the reading on the gage is the average of the two tanks.

Here are four concerns of some operators. None of these shows a problem with your fuel gage:

- The gage moves a little when you turn a corner or speed up.
- The gage doesn't go back to empty when you turn off the ignition.
- At the gas station, the pump shuts off before the gage reads full.
- It takes a little more or less fuel to fill up than the gage indicated.

If you have a diesel engine, also see your Caterpillar® Operation & Maintenance Manual.

## Transmission Temperature Gage (If Equipped)

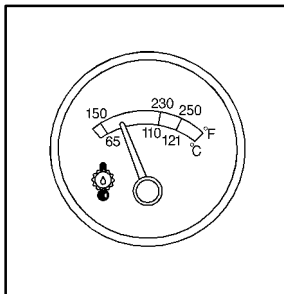

If you have an automatic transmission and this gage, it is to the right of the dash mounted shift lever, just to the right of your floor-mounted shift lever or on the lower portion of the instrument panel to the right of the steering wheel.

When your ignition is on, the gage shows the temperature of the transmission oil. A reading in the warning zone means you must stop driving and check into the cause. One possible cause is a low oil level in the transmission.

### NOTICE:

**If you drive when the transmission temperature gage is in the warning zone, you can badly damage the transmission.**

## Air Pressure Gage (If Equipped)

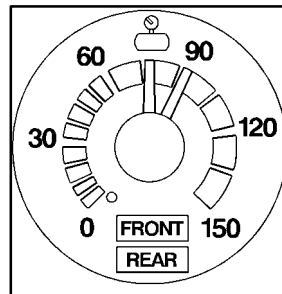

If your vehicle has air brakes, this gage at the center of your instrument cluster shows the air pressure for both your front and rear brake systems.

If the needle on the gage indicates that the air pressure is below 60 psi (415 kPa), the LOW AIR warning light will come on. An alarm will also sound if this happens.

The yellow pointer shows the pressure available for the front system, while the green pointer shows pressure for the rear. There should be no more than 4 psi (28 kPa) difference showing between the systems.

Don't drive until both pointers are showing at least 120 psi (830 kPa), so you'll have enough air if you need to apply your brakes.

## Filterminder Gage (Diesel Engine)

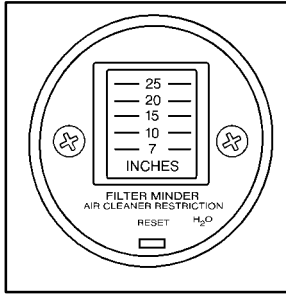

This optional gage is in the lower center of the instrument panel. It monitors the engine air filter.

As the filter gets dirty, the yellow indicator will begin to rise. When it reaches 25 inches of vacuum on the scale, the filter should be replaced.

After replacing the filter, reset the gage by pressing in the yellow reset pin at the bottom of the gage.

If you have a diesel engine, also see your Caterpillar<sup>®</sup> Operation & Maintenance Manual.

## Hourmeter Gage (If Equipped)

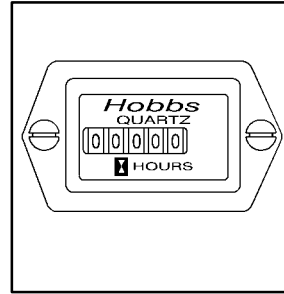

If your vehicle has this gage, it will be to the lower left of the steering column, mounted on a bracket either above or below the fuse block. It shows the total engine operating time.



## Section 3 Comfort Controls and Audio Systems

---

In this section, you'll find out how to operate the comfort control and audio systems offered with your vehicle. Be sure to read about the particular systems supplied with your vehicle.

3-2	Comfort Controls	3-8	AM/FM Stereo
3-5	Air Conditioning	3-10	Remote Cassette Tape Player (If Equipped)
3-5	Heating	3-10	Understanding Radio Reception
3-6	Defogging	3-11	Tips About Your Audio System
3-6	Ventilation System	3-12	Care of Your Cassette Tape Player
3-7	Audio Systems	3-12	Fixed Mast Antenna
3-7	Setting the Clock		

## Comfort Controls

### Standard Comfort Controls

If your vehicle does not have air conditioning, this is what your comfort controls will look like.



### Function Lever

The top lever can be moved to three different heating functions. If you place the lever between positions, it will send air out both vents.



**VENT:** The air comes out at the vents on your instrument panel and at your front side windows.



**HEATER:** Heated air comes out near the floor.

This is the best setting for cold weather.



**DEFOG:** This setting operates the defogger.

Heated air comes out near the windshield. Use this when fog or ice is on the windshield.

### Temperature Lever

The bottom lever lets you select the temperature of the air flowing into your vehicle. Move the lever to the plus symbol for warmer air. Move the lever to the minus symbol for cooler air.

If your engine is equipped with an engine coolant heater, you can use it during initial start-up in cold weather (20°F (-8°C) or lower) to help heat the passenger compartment faster. See “Engine Coolant Heater” in the Index.

### Fan Knob

The fan knob has four positions. To increase airflow, turn the knob toward the plus symbol. To decrease airflow, turn it toward the minus symbol.

## Optional Comfort Controls (If Equipped)

If your vehicle has air conditioning, your comfort controls will look like this.



Your system has a lighted display showing each system when it is operating. During normal operation, all the lights won't come on at the same time. Only the ones displaying the current settings will light.

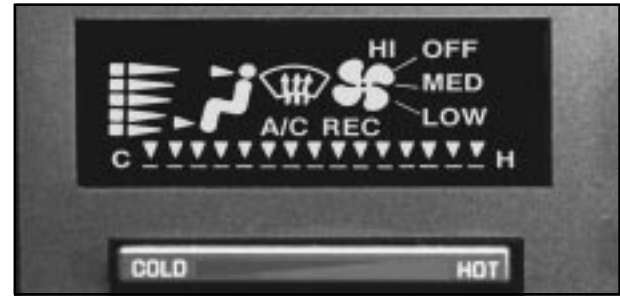

### Temperature Selector Bar

The bar under your system display lets you select the temperature of the air coming into the passenger area of your vehicle. Press COLD for cooler air and press HOT for warmer air. Release the bar when the system reaches the temperature you want. The temperature is shown on the display by an arrow moving between C and H.

If your engine is equipped with an engine coolant heater, you can use it during initial start-up in cold weather (20°F (-8°C) or lower) to help heat the passenger compartment faster. See “Engine Coolant Heater” in the Index.

## Left Blend Button

The airflow can be blended between the two positions. To blend between the positions, press the side of the button showing the area where you would like more airflow. The system will automatically begin to blend toward the position chosen. To stop the system between positions, just press the same side of the button again.



**VENT:** Press the top of the button and all of the airflow will come through the instrument panel vents.



**HEATER:** Press the bottom of this button and all of the airflow will come through the floor outlet.

## Right Blend Button

The airflow can be blended between the two positions. To blend between positions, press the side of the button showing the area where you would like more airflow. The system will automatically begin to blend toward the position chosen. To stop the system between positions, just press the same side of the button again.



**DEFOG:** This setting operates the defogger. Air comes out near the bottom of the windshield and at your front side windows.



**HEATER:** Press the bottom of this button and heated air comes out near the floor.

## A/C Button

Press the A/C button to turn your air conditioner on and off. The A/C symbol will light on your display, and air will come out of your instrument panel vents. The fan will automatically be set on LOW.

## MAX Button

If you press the MAX button, the air in your vehicle will be recirculated. With the air conditioner on, MAX will give you maximum cooling. It can also be used in all modes to help keep dust out of your vehicle. When MAX is selected, REC will light on the display.

## Fan Control Button

This button is in the upper passenger's side corner of your system control panel. The fan has four settings: low, medium low, medium high and high. Press the top of the button with the plus symbol to increase airflow. Press the bottom of the button with the minus symbol to decrease airflow. The setting you select is shown on your display as LOW, MED, HI or OFF.

## OFF

Press this button to turn the air conditioning/heating system off. Pressing OFF will erase the present mode of operation from the system's memory. Outside air will still come out of the heater outlet whenever the vehicle is moving forward.

If the OFF button is pressed, you must press A/C, MAX or one of the BLEND buttons to turn the system back on.

## Air Conditioning

When you first turn on your vehicle's air conditioning, open the windows long enough to clear the vehicle of hot air, then close them. Using the MAX button can also help. See "MAX Button" earlier in this section for more information.

For normal cooling on hot days, use A/C with the temperature selector toward C.

When you press the A/C button to turn the air conditioner off, the system will operate in the vent mode. When you turn the air conditioner back on, the system will operate in the mode you last selected unless the OFF button was pressed.

If your air conditioner develops high system pressure, it will automatically go into the MAX mode and REC will light on your display. The A/C system will remain in the MAX mode, even if you press the MAX button, until system pressure returns to a normal level.

## Heating

On cold days, use HEATER with the temperature selector all the way toward H. When the inside of the vehicle has reached a comfortable temperature, maintain it by using the temperature selector bar.

If your vehicle is equipped with a diesel engine, and the engine has been idling for a long time when it's cold outside, your heater may blow out cool air. This is normal. When you increase the engine speed under load, your heater should blow out warmer air. If it doesn't, your coolant level may be low. See "Engine Coolant" in the Index to check your coolant level.

While idling your diesel engine, you can use the MAX button to recirculate the air in the cab to help maintain interior heat. This will preserve engine coolant temperature and cab heat when idling cannot be avoided.

Using the MAX button while driving is not recommended because interior window fogging can result.

## Defogging

Use DEFOG, along with the HEATER setting, when there is fog or ice on the windshield. This will direct airflow toward the windshield and front side windows. Set the temperature selector toward H and the fan control at a comfortable level. When the windshield is clear, use the temperature selector bar and the fan control button to maintain a comfortable temperature level.

## Ventilation System

Air comes into your vehicle in one of two ways: power air or ram air. Power air means bringing outside air into the cab through the air intake, using the blower fan. Fresh air can be drawn in when the vehicle is stationary or moving at low speed. Air comes in through four vents in the instrument panel and is exhausted through the vents and pressure relief valves in the doors and door pillars. Power ventilation means an increased supply of fresh air is brought into the cab interior without having to open the windows, especially during inclement weather.

Ram air is forced into the cab through the air intake in the cowl by the vehicle's forward motion. This air is controlled by two vent air handles under the instrument panel. Air is directed through the ventilation ducts to the floor. Ram air provides good airflow into the cab at normal road speeds.

## Ventilation Tips

- Keep the hood and front air inlet free of ice, snow or any other obstruction (such as leaves). The heater and defogger will work far better, reducing the chance of fogging the inside of your windows.
- When you enter a vehicle in cold weather, turn the blower fan to high for a few moments before driving off. This helps clear the intake ducts of snow and moisture and reduces the chance of fogging the inside of your windows.
- Keep the air path under the seats clear of objects. This helps air to circulate throughout your vehicle.

The air vents are located in the center and on the sides of your instrument panel. You can move the vents to direct the flow of air or close the vents altogether. When you close a vent, it will increase the flow of air coming out of any vents that are open.

If your vehicle does not have air conditioning, there are air vent controls located below the instrument panel.

## Audio Systems

Your Delco Electronics audio system has been designed to operate easily and give years of listening pleasure. You will get the most enjoyment out of it if you acquaint yourself with it first. Find out what your Delco Electronics system can do and how to operate all its controls, to be sure you're getting the most out of the advanced engineering that went into it.

## Setting the Clock

While pressing the SET button, press the UP button until the correct hour appears on the display and the DOWN button until the correct minute appears on the display. If you press and hold the UP/DOWN button, hours or minutes will advance rapidly.

## AM-FM Stereo



### Playing the Radio

**ON-OFF:** Press the round button to turn the radio on. Press it again to turn the radio off.

**VOLUME:** Slide the VOLUME lever to the right to increase volume or to the left to decrease volume.

**CALL:** Press this button to display the clock for a few seconds when the radio is on. To change what is normally shown on the display (station or time), press this button and the SET button.

### Finding a Station

**AM/FM:** Press this button to switch between AM and FM. The display shows your selection.

**TUNE:** Press UP to increase the frequency of a radio station and DOWN to decrease the frequency of a radio station. If you press and hold the UP or DOWN button for more than half a second, the radio will tune rapidly in that direction.

**SEEK:** Press SEEK to tune the radio to the next higher station and stay there.

**SCAN:** Press SCAN to listen to the next higher radio station for a few seconds. Press SCAN again to stop scanning.

**PUSHBUTTONS:** The six numbered pushbuttons let you return to your favorite stations. You can set up to 12 stations (six AM and six FM). Just:

1. Turn the radio on.
2. Press AM/FM to select a band.
3. Tune in the desired station.
4. Press SET. (SET will appear on the display and will blink for about eight seconds.)



5. Press one of the six pushbuttons within eight seconds. In the display, SET will stop blinking indicating the preset is set. Whenever you press that numbered button, the station you set will return.
6. Repeat the steps for each pushbutton.

Also, you can use the automatic memory SET button to set the pushbuttons. You can set up to 12 stations (six AM and six FM). Just:

1. Press AM/FM to select a band.
2. Press and hold SET. (SET will appear on the display and will blink.)
3. While pressing the SET button, press the SEEK button. Release both switches. The radio will automatically search the band and select radio stations, up to six, which have good signal strength.

### Setting the Tone

**BAS:** Slide this lever left or right to decrease or increase the bass.

**TRE:** Slide this lever left or right to decrease or increase the treble. If a station is weak or noisy, you may want to decrease the treble.

**LOUD:** To increase bass and treble at low volumes, press this button. LOUD will appear in the display. Press this button again to turn LOUD off.

### Adjusting the Speakers

**BAL:** Slide this lever to the left or right to adjust the speaker balance between the left and right speakers. The middle position balances the sound between the speakers.

**FAD:** Slide this lever to the left or right to adjust the speaker balance between the front and rear speakers. The middle position balances the sound between the speakers.

## Remote Cassette Tape Player (If Equipped)



Your tape player is built to work best with tapes that are up to 30 to 45 minutes long on each side. Tapes longer than that are so thin they may not work well in this player.

To load a cassette tape, hold the cassette with the tape to the right. Then, insert the cassette tape. Tape direction is displayed by the lighted arrow. To change the tape direction, press the FF button.

Once the tape is playing, use the control knobs for VOLUME, BAL, FAD, BAS and TRE just as you do for the radio.

**REW:** Press the left arrow to rapidly reverse the tape. Press FF to stop reversing the tape.

**FF:** Press the right arrow to rapidly advance the tape. Press REW to stop forwarding the tape.

**PROGRAM:** An arrow will light on the display to show which side of the tape is playing.

**EJ:** Press this button to remove the tape.

There is a space provided with your remote cassette tape player to keep cassette tapes in.

## Understanding Radio Reception

### AM

The range for most AM stations is greater than for FM, especially at night. The longer range, however, can cause stations to interfere with each other. AM can pick up noise from things like storms and power lines. Try reducing the treble to reduce this noise if you ever get it.

### FM Stereo

FM stereo will give you the best sound, but FM signals will reach only about 10 to 40 miles (16 to 65 km). Tall buildings or hills can interfere with FM signals, causing the sound to come and go.

## Tips About Your Audio System

Hearing damage from loud noise is almost undetectable until it is too late. Your hearing can adapt to higher volumes of sound. Sound that seems normal can be loud and harmful to your hearing. Take precautions by adjusting the volume control on your radio to a safe sound level before your hearing adapts to it.

To help avoid hearing loss or damage:

- Adjust the volume control to the lowest setting.
- Increase volume slowly until you hear comfortably and clearly.

### NOTICE:

**Before you add any sound equipment to your vehicle -- like a tape player, CB radio, mobile telephone or two-way radio -- be sure you can add what you want. If you can, it's very important to do it properly. Added sound equipment may interfere with the operation of your vehicle's engine, Delco Electronics radio or other systems, and even damage them. Your vehicle's systems may interfere with the operation of sound equipment that has been added improperly.**

**So, before adding sound equipment, check with your dealer and be sure to check Federal rules covering mobile radio and telephone units.**

## Care of Your Cassette Tape Player

A tape player that is not cleaned regularly can cause reduced sound quality, ruined cassettes or a damaged mechanism. Cassette tapes should be stored in their cases away from contaminants, direct sunlight and extreme heat. If they aren't, they may not operate properly or may cause failure of the tape player.

Your tape player should be cleaned regularly after every 50 hours of use. If you notice a reduction in sound quality, try a known good cassette to see if it is the tape or the tape player at fault. If this other cassette has no improvement in sound quality, clean the tape player.

The recommended cleaning method for your cassette tape player is the use of a scrubbing action, non-abrasive cleaning cassette with pads which scrub the tape head as the hubs of the cleaner cassette turn. The recommended cleaning cassette is available through your dealership (GM Part No. 12344789).

When using a scrubbing action, non-abrasive cleaning cassette, it is normal for the cassette to eject because your unit is equipped with a cut tape detection feature and a cleaning cassette may appear as a broken tape. If the cleaning cassette ejects, insert the cassette at least three times to ensure thorough cleaning.

You may also choose a non-scrubbing action, wet-type cleaner which uses a cassette with a fabric belt to clean the tape head. This type of cleaning cassette will not eject on its own. A non-scrubbing action cleaner may not clean as thoroughly as the scrubbing type cleaner. The use of a non-scrubbing action, dry-type cleaning cassette is not recommended.

Cassettes are subject to wear and the sound quality may degrade over time. Always make sure the cassette tape is in good condition before you have your tape player serviced.

## Fixed Mast Antenna

The fixed mast antenna can withstand most vehicle washes without being damaged. If the mast should ever become slightly bent, you can straighten it out by hand. If the mast is badly bent, as it might be by vandals, you should replace it.

Check every once in a while to be sure the mast is still tightened to the cowl.

## Section 4 Your Driving and the Road

---

Here you'll find information about driving on different kinds of roads and in varying weather conditions. We've also included many other useful tips on driving.

4-2	Defensive Driving	4-16	Driving in Rain and on Wet Roads
4-3	Drunken Driving	4-19	City Driving
4-6	Control of a Vehicle	4-20	Freeway Driving
4-6	Braking	4-21	Highway Hypnosis
4-9	Steering	4-22	Hill and Mountain Roads
4-12	Off-Road Recovery	4-24	Winter Driving
4-12	Passing	4-28	Loading Your Vehicle
4-14	Loss of Control	4-31	Power Take-Off (PTO) (If Equipped)
4-15	Driving at Night		



## Defensive Driving

The best advice anyone can give about driving is:  
Drive defensively.

Please start with a very important safety device in your vehicle: Buckle up. (See “Safety Belts” in the Index.)

Defensive driving really means “be ready for anything.” On city streets, rural roads or freeways, it means “always expect the unexpected.”

Assume that pedestrians or other drivers are going to be careless and make mistakes. Anticipate what they might do. Be ready for their mistakes.

Rear-end collisions are about the most preventable of accidents. Yet they are common. Allow enough following distance. It’s the best defensive driving maneuver, in both city and rural driving. You never know when the vehicle in front of you is going to brake or turn suddenly.

Defensive driving requires that a driver concentrate on the driving task. Anything that distracts from the driving task -- such as concentrating on a cellular telephone call, reading, or reaching for something on the floor -- makes proper defensive driving more difficult and can even cause a collision, with resulting injury. Ask a passenger to help do things like this, or pull off the road in a safe place to do them yourself. These simple defensive driving techniques could save your life.

## Drunken Driving

Death and injury associated with drinking and driving is a national tragedy. It's the number one contributor to the highway death toll, claiming thousands of victims every year.

Alcohol affects four things that anyone needs to drive a vehicle:

- Judgment
- Muscular Coordination
- Vision
- Attentiveness.

Police records show that almost half of all motor vehicle-related deaths involve alcohol. In most cases, these deaths are the result of someone who was drinking and driving. In recent years, over 17,000 annual motor vehicle-related deaths have been associated with the use of alcohol, with more than 300,000 people injured.

Many adults -- by some estimates, nearly half the adult population -- choose never to drink alcohol, so they never drive after drinking. For persons under 21, it's against the law in every U.S. state to drink alcohol. There are good medical, psychological and developmental reasons for these laws.

The obvious way to solve the leading highway safety problem is for people never to drink alcohol and then drive. But what if people do? How much is "too much" if the driver plans to drive? It's a lot less than many might think. Although it depends on each person and situation, here is some general information on the problem.

The Blood Alcohol Concentration (BAC) of someone who is drinking depends upon four things:

- The amount of alcohol consumed
- The drinker's body weight
- The amount of food that is consumed before and during drinking
- The length of time it has taken the drinker to consume the alcohol.

According to the American Medical Association, a 180-lb. (82 kg) person who drinks three 12-ounce (355 ml) bottles of beer in an hour will end up with a BAC of about 0.06 percent. The person would reach the same BAC by drinking three 4-ounce (120 ml) glasses of wine or three mixed drinks if each had 1-1/2 ounces (45 ml) of a liquor like whiskey, gin or vodka.



It's the amount of alcohol that counts. For example, if the same person drank three double martinis (3 ounces or 90 ml of liquor each) within an hour, the person's BAC would be close to 0.12 percent. A person who consumes food just before or during drinking will have a somewhat lower BAC level.

There is a gender difference, too. Women generally have a lower relative percentage of body water than men.

Since alcohol is carried in body water, this means that a woman generally will reach a higher BAC level than a man of her same body weight when each has the same number of drinks.

The law in many U.S. states sets the legal limit at a BAC of 0.10 percent. In a growing number of U.S. states, and throughout Canada, the limit is 0.08 percent. In some other countries, it's even lower. The BAC limit for all commercial drivers in the United States is 0.04 percent.

The BAC will be over 0.10 percent after three to six drinks (in one hour). Of course, as we've seen, it depends on how much alcohol is in the drinks, and how quickly the person drinks them.

But the ability to drive is affected well below a BAC of 0.10 percent. Research shows that the driving skills of many people are impaired at a BAC approaching 0.05 percent, and that the effects are worse at night. All drivers are impaired at BAC levels above 0.05 percent. Statistics show that the chance of being in a collision increases sharply for drivers who have a BAC of 0.05 percent or above. A driver with a BAC level of 0.06 percent has doubled his or her chance of having a collision. At a BAC level of 0.10 percent, the chance of this driver having a collision is 12 times greater; at a level of 0.15 percent, the chance is 25 times greater!



The body takes about an hour to rid itself of the alcohol in one drink. No amount of coffee or number of cold showers will speed that up. "I'll be careful" isn't the right answer. What if there's an emergency, a need to take sudden action, as when a child darts into the street? A person with even a moderate BAC might not be able to react quickly enough to avoid the collision.

There's something else about drinking and driving that many people don't know. Medical research shows that alcohol in a person's system can make crash injuries worse, especially injuries to the brain, spinal cord or heart. This means that when anyone who has been drinking -- driver or passenger -- is in a crash, that person's chance of being killed or permanently disabled is higher than if the person had not been drinking.

 **CAUTION:**

**Drinking and then driving is very dangerous. Your reflexes, perceptions, attentiveness and judgment can be affected by even a small amount of alcohol. You can have a serious -- or even fatal -- collision if you drive after drinking. Please don't drink and drive or ride with a driver who has been drinking. Ride home in a cab; or if you're with a group, designate a driver who will not drink.**

## Control of a Vehicle

You have three systems that make your vehicle go where you want it to go. They are the brakes, the steering and the accelerator. All three systems have to do their work at the places where the tires meet the road.



Sometimes, as when you're driving on snow or ice, it's easy to ask more of those control systems than the tires and road can provide. That means you can lose control of your vehicle.

## Braking

Braking action involves *perception time* and *reaction time*.

First, you have to decide to push on the brake pedal. That's *perception time*. Then you have to bring up your foot and do it. That's *reaction time*.

Average *reaction time* is about  $\frac{3}{4}$  of a second. But that's only an average. It might be less with one driver and as long as two or three seconds or more with another. Age, physical condition, alertness, coordination and eyesight all play a part. So do alcohol, drugs and frustration. But even in  $\frac{3}{4}$  of a second, a vehicle moving at 60 mph (100 km/h) travels 66 feet (20 m). That could be a lot of distance in an emergency, so keeping enough space between your vehicle and others is important.

And, of course, actual stopping distances vary greatly with the surface of the road (whether it's pavement or gravel); the condition of the road (wet, dry, icy); tire tread; the condition of your brakes; the weight of the vehicle and the amount of brake force applied.

Avoid needless heavy braking. Some people drive in spurts -- heavy acceleration followed by heavy braking -- rather than keeping pace with traffic. This is a mistake. Your brakes may not have time to cool between hard stops. Your brakes will wear out much faster if you do a lot of heavy braking. If you keep pace with the traffic and allow realistic following distances, you will eliminate a lot of unnecessary braking. That means better braking and longer brake life.

If your engine ever stops while you're driving, brake normally but don't pump your brakes. If you do, the pedal may get harder to push down. If your engine stops, you will still have some power brake assist. But you will use it when you brake. Once the power assist is used up, it may take longer to stop and the brake pedal will be harder to push.

## Hydraulic Brake Systems

If your engine stops running, or if your primary brake system stops working, your vehicle has a reserve power assist system to help you slow down. Just slowly and steadily apply the brake pedal until you can safely get off the road. The pedal will seem harder to push down. Don't pump the pedal; the system won't work well or at all that way.

You may find that the steering wheel seems hard to turn when you're turning and braking at the same time. Also, the PRIMARY BRAKE warning light may come on and the warning tone may sound. This is normal because the main hydraulic brake system and power steering both use the power steering pump. If this ever happens, let up on the brake pedal a little. When you let up on the brake pedal in that situation, it lets the steering get a little more help from the pump.

## Anti-Lock Brakes (Option)

Your vehicle may have anti-lock brakes (ABS). ABS is an advanced electronic braking system that will help prevent a braking skid.

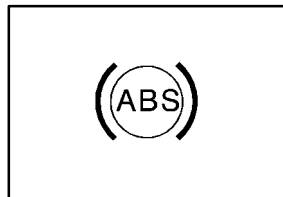

If your vehicle has anti-lock brakes, this warning light on the instrument panel will come on briefly when you start your vehicle.

When you start your engine and begin to drive away, your anti-lock brake system will check itself. You may hear a momentary motor or clicking noise while this test is going on. This is normal.

If there's a problem with the anti-lock brake system, the anti-lock brake system warning light will stay on. See "Anti-Lock Brake System Warning Light" in the Index.



Here's how anti-lock works. Let's say the road is wet. You're driving safely. Suddenly an animal jumps out in front of you.

You slam on the brakes. Here's what happens with ABS.

A computer senses that wheels are slowing down. If one of the wheels is about to stop rolling, the computer will separately work the brakes at each wheel.

The anti-lock system can change the brake pressure faster than any driver could. The computer is programmed to make the most of available tire and road conditions.



You can steer around the obstacle while braking hard.

As you brake, your computer keeps receiving updates on wheel speed and controls braking pressure accordingly.

Remember: Anti-lock doesn't change the time you need to get your foot up to the brake pedal or always decrease stopping distance. If you get too close to the vehicle in front of you, you won't have time to apply your brakes if that vehicle suddenly slows or stops. Always leave enough room up ahead to stop, even though you have anti-lock brakes.

### Using Anti-Lock

Don't pump the brakes. Just hold the brake pedal down firmly and let anti-lock work for you. You may feel the brakes pulsate, or you may hear air exhausting, but this is normal.

### Braking in Emergencies

At some time, nearly every driver gets into a situation that requires hard braking.

If you have anti-lock, you can steer and brake at the same time. However, if you don't have anti-lock, your first reaction -- to hit the brake pedal hard and hold it down -- may be the wrong thing to do. Your wheels can stop rolling. Once they do, the vehicle can't respond to your steering. Momentum will carry it in whatever direction it was headed when the wheels stopped rolling.

That could be off the road, into the very thing you were trying to avoid, or into traffic.

If you don't have anti-lock, use a "squeeze" braking technique. This will give you maximum braking while maintaining steering control. You do this by pushing on the brake pedal with steadily increasing pressure.

In an emergency, you will probably want to squeeze the brakes hard without locking the wheels. If you hear or feel the wheels sliding, ease off the brake pedal. This will help you retain steering control. (If you *do* have anti-lock, it's different: see "Anti-Lock Brakes" in the Index.)

In many emergencies, steering can help you more than even the very best braking.

## Steering

### Power Steering

If you lose power steering assist because the engine stops or the system is not functioning, you can steer but it will take much more effort.

On vehicles with hydraulic brakes, the power steering and main hydraulic brake system both use the power steering pump. See "Hydraulic Brake Systems" in the Index.

## Steering Tips

### Driving on Curves

It's important to take curves at a reasonable speed.

A lot of the "driver lost control" accidents mentioned on the news happen on curves. Here's why:

Experienced driver or beginner, each of us is subject to the same laws of physics when driving on curves. The traction of the tires against the road surface makes it possible for the vehicle to change its path when you turn the front wheels. If there's no traction, inertia will keep the vehicle going in the same direction. If you've ever tried to steer a vehicle on wet ice, you'll understand this.

The traction you can get in a curve depends on the condition of your tires and the road surface, the angle at which the curve is banked, and your speed. While you're in a curve, speed is the one factor you can control.

Suppose you're steering through a sharp curve. Then you suddenly apply the brakes. Both control systems -- steering and braking -- have to do their work where the tires meet the road. Unless you have four-wheel anti-lock brakes, adding the hard braking can demand too much of those places. You can lose control.

The same thing can happen if you're steering through a sharp curve and you suddenly accelerate. Those two control systems -- steering and acceleration -- can overwhelm those places where the tires meet the road and make you lose control.

What should you do if this ever happens? Ease up on the brake or accelerator pedal, steer the vehicle the way you want it to go, and slow down.

Speed limit signs near curves warn that you should adjust your speed. Of course, the posted speeds are based on good weather and road conditions. Under less favorable conditions you'll want to go slower.

If you need to reduce your speed as you approach a curve, do it before you enter the curve, while your front wheels are straight ahead.

This is especially important with a tractor-trailer. Try to adjust your speed so you can "drive" through the curve. Maintain a reasonable, steady speed. Wait to accelerate until you are out of the curve, and then accelerate gently into the straightaway.

## Steering in Emergencies

There are times when steering can be more effective than braking. For example, you come over a hill and find a truck stopped in your lane, or a car suddenly pulls out from nowhere, or a child darts out from between parked cars and stops right in front of you. You can avoid these problems by braking -- if you can stop in time. But sometimes you can't; there isn't room. That's the time for evasive action -- steering around the problem.

In emergencies like these, first apply your brakes -- but unless you have anti-lock, not enough to lock your wheels. (See "Braking in Emergencies" earlier in this section.) It is better to remove as much speed as you can from a possible collision. Then steer around the problem, to the left or right depending on the space available. If your vehicle has anti-lock brakes, you don't need to release the brakes to maintain steering control.

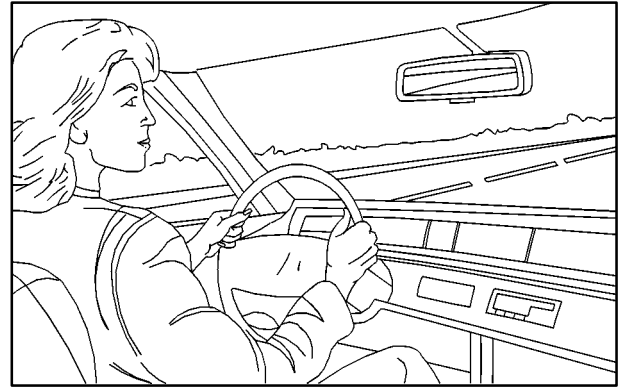

An emergency like this requires close attention and a quick decision. If you are holding the steering wheel at the recommended 9 and 3 o'clock positions, you may be able to turn it just enough to miss the object without removing either hand. But you must act fast, steering precisely. The more sharply you turn, the greater the chance of a skid, a rollover or a "jackknife" with a tractor-trailer. Just as quickly straighten the wheel once you have avoided the object.

The fact that such emergency situations are always possible is a good reason to practice defensive driving at all times and wear safety belts properly.

## Off-Road Recovery

You may find that your right wheels have dropped off the edge of a road onto the shoulder while you're driving.

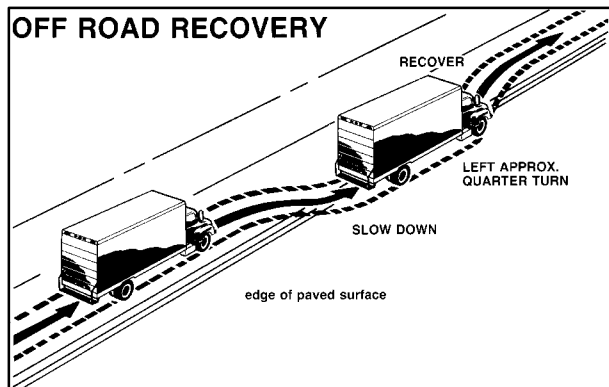

If the level of the shoulder is only slightly below the pavement, recovery should be fairly easy. Ease off the accelerator and then, if there is nothing in the way, steer so that your vehicle straddles the edge of the pavement. You can turn the steering wheel up to one-quarter turn until the right front tire contacts the pavement edge. Then turn your steering wheel to go straight down the roadway.

## Passing

The driver of a vehicle about to pass another on a two-lane highway waits for just the right moment, accelerates, moves around the vehicle ahead, then goes back into the right lane again. A simple maneuver?

Not necessarily! Passing another vehicle on a two-lane highway is a potentially dangerous move, since the passing vehicle occupies the same lane as oncoming traffic for several seconds. A miscalculation, an error in judgment, or a brief surrender to frustration or anger can suddenly put the passing driver face to face with the worst of all traffic accidents -- the head-on collision.

So here are some tips for passing:

- A vehicle like yours takes a longer time to reach passing speed, so you'll need a longer stretch of clear road ahead than you would with a passenger car.
- "Drive ahead." Look down the road, to the sides and to crossroads for situations that might affect your passing patterns. If you have any doubt whatsoever about making a successful pass, wait for a better time.



- Watch for traffic signs, pavement markings and lines. If you can see a sign up ahead that might indicate a turn or an intersection, delay your pass. A broken center line usually indicates it's all right to pass (providing the road ahead is clear). Never cross a solid line on your side of the lane or a double solid line, even if the road seems empty of approaching traffic.
- Do not get too close to the vehicle you want to pass while you're awaiting an opportunity. For one thing, following too closely reduces your area of vision, especially if you're following a larger vehicle. Also, you won't have adequate space if the vehicle ahead suddenly slows or stops. Keep back a reasonable distance.
- When it looks like a chance to pass is coming up, start to accelerate but stay in the right lane and don't get too close. Time your move so you will be increasing speed as the time comes to move into the other lane. If the way is clear to pass, you will have a "running start" that more than makes up for the distance you would lose by dropping back. And if something happens to cause you to cancel your pass, you need only slow down and drop back again and wait for another opportunity.
- If other cars are lined up to pass a slow vehicle, wait your turn. But take care that someone isn't trying to pass you as you pull out to pass the slow vehicle.
- Check your mirrors and start your left lane change signal before moving out of the right lane to pass. When you are far enough ahead of the passed vehicle to see its front in your right outside mirror, activate your right lane change signal and move back into the right lane. (Remember that if your right outside mirror is convex, the vehicle you just passed may seem to be farther away from you than it really is.)
- Try not to pass more than one vehicle at a time on two-lane roads. Reconsider before passing the next vehicle.
- Don't overtake a slowly moving vehicle too rapidly. Even though the brake lamps are not flashing, it may be slowing down or starting to turn.
- If you're being passed, make it easy for the following driver to get ahead of you. Perhaps you can ease a little to the right.

## Loss of Control

Let's review what driving experts say about what happens when the three control systems (brakes, steering and acceleration) don't have enough friction where the tires meet the road to do what the driver has asked.

In any emergency, don't give up. Keep trying to steer and constantly seek an escape route or area of less danger.

### Skidding

In a skid, a driver can lose control of the vehicle. Defensive drivers avoid most skids by taking reasonable care suited to existing conditions, and by not "overdriving" those conditions. But skids are always possible.

The three types of skids correspond to your vehicle's three control systems. In the braking skid, your wheels aren't rolling. In the steering or cornering skid, too much speed or steering in a curve causes tires to slip and lose cornering force. And in the acceleration skid, too much throttle causes the driving wheels to spin.

A cornering skid and an acceleration skid are usually best handled by easing your foot off the accelerator pedal.

Of course, traction is reduced when water, snow, ice, gravel or other material is on the road. For safety, you'll want to slow down and adjust your driving to these conditions. It is important to slow down on slippery surfaces because stopping distance will be longer and vehicle control more limited.

While driving on a surface with reduced traction, try your best to avoid sudden steering, acceleration or braking (including engine braking by shifting to a lower gear). See "Diesel Engine Exhaust Brake" in the Index for information about using the exhaust brake on slippery surfaces. Any sudden changes could cause the tires to slide. You may not realize the surface is slippery until your vehicle is skidding. Learn to recognize warning clues -- such as enough water, ice or packed snow on the road to make a "mirrored surface" -- and slow down when you have any doubt.

If you have the anti-lock braking system, remember: It helps avoid only the braking skid. If you do not have anti-lock, then in a braking skid (where the wheels are no longer rolling), release enough pressure on the brakes to get the wheels rolling again. This restores steering control. Push the brake pedal down steadily when you have to stop suddenly. As long as the wheels are rolling, you will have steering control.

## Driving at Night



Night driving is more dangerous than day driving. One reason is that some drivers are likely to be impaired -- by alcohol or drugs, with night vision problems, or by fatigue.

Here are some tips on night driving.

- Drive defensively.
- Don't drink and drive.
- Since you can't see as well, you may need to slow down and keep more space between you and other vehicles.
- Slow down, especially on higher speed roads. Your headlamps can light up only so much road ahead.
- In remote areas, watch for animals.
- If you're tired, pull off the road in a safe place and rest.

### Night Vision

No one can see as well at night as in the daytime. But as we get older these differences increase. A 50-year-old driver may require at least twice as much light to see the same thing at night as a 20-year-old.

What you do in the daytime can also affect your night vision. For example, if you spend the day in bright sunshine you are wise to wear sunglasses. Your eyes will have less trouble adjusting to night. But if you're driving, don't wear sunglasses at night. They may cut down on glare from headlamps, but they also make a lot of things invisible.

You can be temporarily blinded by approaching headlamps. It can take a second or two, or even several seconds, for your eyes to readjust to the dark. When you are faced with severe glare (as from a driver who doesn't lower the high beams, or a vehicle with misaimed headlamps), slow down a little. Avoid staring directly into the approaching headlamps.

Keep your windshield and all the glass on your vehicle clean -- inside and out. Glare at night is made much worse by dirt on the glass. Even the inside of the glass can build up a film caused by dust. Dirty glass makes lights dazzle and flash more than clean glass would, making the pupils of your eyes contract repeatedly.

Remember that your headlamps light up far less of a roadway when you are in a turn or curve. Keep your eyes moving; that way, it's easier to pick out dimly lighted objects. Just as your headlamps should be checked regularly for proper aim, so should your eyes be examined regularly. Some drivers suffer from night blindness -- the inability to see in dim light -- and aren't even aware of it.

## Driving in Rain and on Wet Roads



Rain and wet roads can mean driving trouble. On a wet road, you can't stop, accelerate or turn as well because your tire-to-road traction isn't as good as on dry roads. And, if your tires don't have much tread left, you'll get even less traction. It's always wise to go slower and be cautious if rain starts to fall while you are driving. The surface may get wet suddenly when your reflexes are tuned for driving on dry pavement.

The heavier the rain, the harder it is to see. Even if your windshield wiper blades are in good shape, a heavy rain can make it harder to see road signs and traffic signals, pavement markings, the edge of the road and even people walking.

It's wise to keep your wiping equipment in good shape and keep your windshield washer tank filled with washer fluid. Replace your windshield wiper inserts when they show signs of streaking or missing areas on the windshield, or when strips of rubber start to separate from the inserts.



Driving too fast through large water puddles or even going through some vehicle washes can cause problems, too. The water may affect your brakes. Try to avoid puddles. But if you can't, try to slow down before you hit them.

**⚠ CAUTION:**

**Wet brakes can cause accidents. They won't work as well in a quick stop and may cause pulling to one side. You could lose control of the vehicle. After driving through a large puddle of water or a vehicle wash, apply your brake pedal lightly until your brakes work normally.**

## Hydroplaning

Hydroplaning is dangerous. So much water can build up under your tires that they can actually ride on the water. This can happen if the road is wet enough and you're going fast enough. When your vehicle is hydroplaning, it has little or no contact with the road.

Hydroplaning doesn't happen often. But it can if your tires do not have much tread or if the pressure in one or more is low. It can happen if a lot of water is standing on the road. If you can see reflections from trees, telephone poles or other vehicles, and raindrops "dimple" the water's surface, there could be hydroplaning.

Hydroplaning usually happens at higher speeds. There just isn't a hard and fast rule about hydroplaning. The best advice is to slow down when it is raining.

## Driving Through Deep Standing Water

### NOTICE:

**If you drive too quickly through deep puddles or standing water, water can come in through your engine's air intake and badly damage your engine. Never drive through water that is slightly lower than the underbody of your vehicle. If you can't avoid deep puddles or standing water, drive through them very slowly.**

### Some Other Rainy Weather Tips

- Turn on your low-beam headlamps and your marker and clearance lamps, if your vehicle has them -- not just your parking lamps -- to help make you more visible to others.
- Besides slowing down, allow some extra following distance. And be especially careful when you pass another vehicle. Allow yourself more clear room ahead, and be prepared to have your view restricted by road spray.
- Have good tires with proper tread depth. (See "Tires" in the Index.)

## City Driving



One of the biggest problems with city streets is the amount of traffic on them. You'll want to watch out for what the other drivers are doing and pay attention to traffic signals.

Here are ways to increase your safety in city driving:

- Know the best way to get to where you are going. Get a city map and plan your trip into an unknown part of the city just as you would for a cross-country trip.
- Larger vehicles can't be driven everywhere smaller ones can. There are low underpasses, truck routes and other special situations. Usually these are well marked, so be sure to watch for the signs.
- Try to use the freeways that rim and crisscross most large cities. You'll save time and energy. (See the next part, "Freeway Driving.")
- Treat a green light as a warning signal. A traffic light is there because the corner is busy enough to need it. When a light turns green, and just before you start to move, check both ways for vehicles that have not cleared the intersection or may be running the red light.

## Freeway Driving



Mile for mile, freeways (also called thruways, parkways, expressways, turnpikes or superhighways) are the safest of all roads. But they have their own special rules.

The most important advice on freeway driving is: Keep up with traffic and keep to the right. Drive at the same speed most of the other drivers are driving. Too-fast or too-slow driving breaks a smooth traffic flow. Treat the left lane on a freeway as a passing lane.

At the entrance, there is usually a ramp that leads to the freeway. If you have a clear view of the freeway as you drive along the entrance ramp, you should begin to check traffic. Try to determine where you expect to blend with the flow. Try to merge into the gap at close to the prevailing speed. Switch on your turn signal, check your mirrors and try to blend smoothly with the traffic flow.

Once you are on the freeway, adjust your speed to the posted limit or to the prevailing rate if it's slower. Stay in the right lane unless you want to pass. On some freeways, larger vehicles aren't allowed to use some lanes. These places usually are well-marked.

Before changing lanes, check your mirrors. Then use your turn signal.



Once you are moving on the freeway, make certain you allow a reasonable following distance. Expect to move slightly slower at night.

When you want to leave the freeway, move to the proper lane well in advance. If you miss your exit, do not, under any circumstances, stop and back up. Drive on to the next exit.

The exit ramp can be curved, sometimes quite sharply.

The exit speed for cars -- but not larger vehicles -- is usually posted. You should go more slowly.

Reduce your speed according to your speedometer, not to your sense of motion. After driving for any distance at higher speeds, you may tend to think you are going slower than you actually are.

## Highway Hypnosis

Is there actually such a condition as “highway hypnosis”? Or is it just plain falling asleep at the wheel? Call it highway hypnosis, lack of awareness, or whatever.

When you drive the vehicle for a long distance, there is something about an easy stretch of road with the same scenery, along with the hum of the tires on the road, the drone of the engine, and the rush of the wind against the vehicle that can make you sleepy. Don't let it happen to you! If it does, your vehicle can leave the road in *less than a second*, and you could crash and be injured.

What can you do about highway hypnosis? First, be aware that it can happen.

Then here are some tips:

- Make sure your vehicle is well ventilated, with a comfortably cool interior.
- Keep your eyes moving. Scan the road ahead and to the sides. Check your mirrors and your instruments frequently.
- If you get sleepy, pull off the road into a rest, service or parking area and take a nap, get some exercise, or both. For safety, treat drowsiness on the highway as an emergency.

## Hill and Mountain Roads



Driving on steep hills or mountains is different from driving in flat or rolling terrain.

Here are some tips that can make your drive through steep country safer:

- Keep the vehicle in good shape. Check all fluid levels and also the brakes, tires, cooling system and transmission. These parts can work hard on mountain roads.
- Know how to go down hills. The most important thing to know is this: let your engine do some of the slowing down. Shift to a lower gear when you go down a steep or long hill.

### CAUTION:

**If you don't shift down, your brakes could get so hot that they wouldn't work well. You would then have poor braking or even none going down a hill. You could crash. Shift down to let your engine assist your brakes on a steep downhill slope.**

**CAUTION:**

**Coasting downhill in NEUTRAL (N) or with the ignition off is dangerous. Your brakes will have to do all the work of slowing down. They could get so hot that they wouldn't work well. You would then have poor braking or even none going down a hill. You could crash. Always have your engine running and your vehicle in gear when you go downhill.**

- Know how to go uphill. Use lower gears. They help cool your engine and transmission, and you can climb the hill better.
- Stay in your own lane when driving on two-lane roads in hills or mountains. Don't swing wide or cut across the center of the road. Drive at speeds that let you stay in your own lane.
- As you go over the top of a hill, be alert. There could be something in your lane, like a stalled car or an accident.
- You may see highway signs on mountains that warn of special problems. Examples are long grades, passing or no-passing zones, a falling rocks area, winding roads and special truck lanes. Be alert to these and take appropriate action.

## Winter Driving

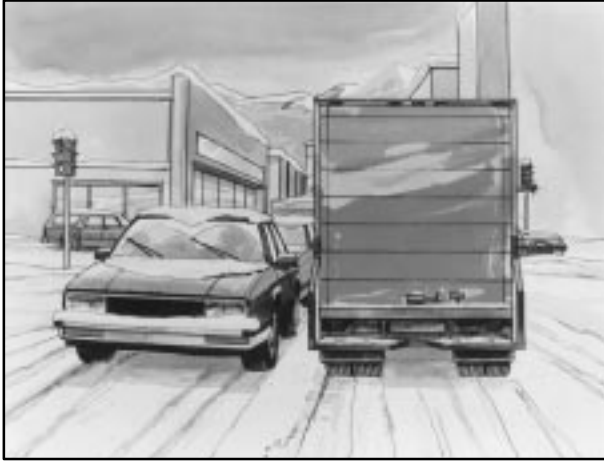

Here are some tips for winter driving:

- Be sure the vehicle is in good shape for winter.
- You may want to put winter emergency supplies in your vehicle.

Include an ice scraper, a small brush or broom, a supply of windshield washer fluid, a rag, some winter outer clothing, a small shovel, a flashlight, a red cloth and reflective warning triangles. And, if you will be driving under severe conditions, include a small bag of sand, a piece of old carpet or a couple of burlap bags to help provide traction. Be sure you properly secure these items in your vehicle.

### Driving on Snow or Ice

Most of the time, those places where your tires meet the road probably have good traction.

However, if there is snow or ice between your tires and the road, you can have a very slippery situation. You'll have a lot less traction or "grip" and will need to be very careful.



What's the worst time for this? "Wet ice." Very cold snow or ice can be slick and hard to drive on. But wet ice can be even more trouble because it may offer the least traction of all. You can get wet ice when it's about freezing (32°F; 0°C) and freezing rain begins to fall. Try to avoid driving on wet ice until salt and sand crews can get there.

Whatever the condition -- smooth ice, packed, blowing or loose snow -- drive with caution.

Accelerate gently. Try not to break the fragile traction. If you accelerate too fast, the drive wheels will spin and polish the surface under the tires even more.

Unless you have the anti-lock braking system, you'll want to brake very gently, too. (If you do have anti-lock, see "Anti-Lock" in the Index. This system improves your vehicle's stability when you make a hard stop on a slippery road.) Whether you have the anti-lock braking system or not, you'll want to begin stopping sooner than you would on dry pavement. Without anti-lock brakes, if you feel your vehicle begin to slide, let up on the brakes a little. Push the brake pedal down steadily to get the most traction you can.

Remember, unless you have anti-lock, if you brake so hard that your wheels stop rolling, you'll just slide. Brake so your wheels always keep rolling and you can still steer.

- Whatever your braking system, allow greater following distance on any slippery road.
- Watch for slippery spots. The road might be fine until you hit a spot that's covered with ice. On an otherwise clear road, ice patches may appear in shaded areas where the sun can't reach: around clumps of trees, behind buildings or under bridges. Sometimes the surface of a curve or an overpass may remain icy when the surrounding roads are clear. If you see a patch of ice ahead of you, brake before you are on it. Try not to brake while you're actually on the ice, and avoid sudden steering maneuvers.

## If You're Caught in a Blizzard



If you are stopped by heavy snow, you could be in a serious situation. You should probably stay with your vehicle unless you know for sure that you are near help and you can hike through the snow. Here are some things to do to summon help and keep yourself and your passengers safe:

- Turn on your hazard flashers.

- Tie a red cloth to your mirror arm to alert police that you've been stopped by the snow.
- Put on extra clothing or wrap a blanket around you. If you have no blankets or extra clothing, make body insulators from newspapers, burlap bags, rags, floor mats -- anything you can wrap around yourself or tuck under your clothing to keep warm.



You can run the engine to keep warm, but be careful.

## CAUTION:

**Snow can trap exhaust gases under your vehicle. This can cause deadly CO (carbon monoxide) gas to get inside. CO could overcome you and kill you. You can't see it or smell it, so you might not know it is in your vehicle. Clear away snow from around the base of your vehicle if any is blocking your exhaust pipe. And check around again from time to time to be sure snow doesn't collect there. Open a window just a little on the side of the vehicle that's away from the wind. This will help keep CO out.**

Run your engine only as long as you must. This saves fuel. When you run the engine, make it go a little faster than just idle. That is, push the accelerator slightly. This uses less fuel for the heat that you get and it keeps the battery (or batteries) charged. You will need a well-charged battery (or batteries) to restart the vehicle, and possibly for signaling later on with your headlamps. Let the heater run for a while.

If you have a diesel engine, you may have to run it at a higher speed to get enough heat. Then, shut the engine off and close the window almost all the way to preserve the heat. Start the engine again and repeat this only when you feel really uncomfortable from the cold. But do it as little as possible. Preserve the fuel as long as you can. To help keep warm, you can get out of the vehicle and do some fairly vigorous exercises every half hour or so until help comes.

## Loading Your Vehicle

The GVW/Tire Information label is found on the rear edge of the driver's door. The label shows the size of your original tires and the inflation pressures needed to obtain the gross weight capacity of your vehicle.

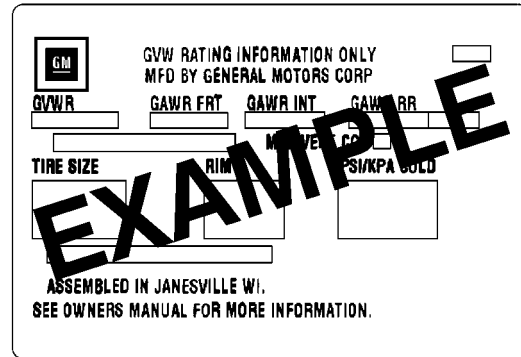

This is called the Gross Vehicle Weight Rating (GVWR). The GVWR includes the weight of the vehicle, all occupants, fuel and cargo.



The Certification/Tire label is provided by the final manufacturer and should be on the door or door jamb. It also tells you the maximum weights for the front and rear axles, called Gross Axle Weight Rating (GAWR). To find out the actual loads on your front and rear axles, you need to go to a weigh station and weigh your vehicle. Your dealer can help you with this. Be sure to spread out your load equally on both sides of the centerline.

Never exceed the GVWR for your vehicle, or the GAWR for either the front or rear axle.

And, if you do have a heavy load, you should spread it out.

 **CAUTION:**

**Do not load your vehicle any heavier than the GVWR, or either the maximum front or rear GAWR. If you do, parts on your vehicle can break, and it can change the way your vehicle handles. These could cause you to lose control and crash. Also, overloading can shorten the life of your vehicle.**

Using heavier suspension components to get added durability might not change your weight ratings. Ask your dealer to help you load your vehicle the right way.

## **NOTICE:**

**Your warranty does not cover parts or components that fail because of overloading.**

If you put things inside your vehicle -- like suitcases, tools, packages or anything else -- they will go as fast as the vehicle goes. If you have to stop or turn quickly, or if there is a crash, they'll keep going.

## **CAUTION:**

**Things you put inside your vehicle can strike and injure people in a sudden stop or turn, or in a crash.**

- **Put things in the cargo area of your vehicle. Try to spread the weight evenly.**
- **Never stack heavier things, like suitcases, inside the vehicle so that some of them are above the tops of the seats.**
- **Don't leave an unsecured child restraint in your vehicle.**
- **When you carry something inside the vehicle, secure it whenever you can.**

## Power Take-Off (PTO) (If Equipped)

Before using a PTO, refer to the body builder's or operator's instructions.

To engage a PTO:

1. Make sure the vehicle is stopped.
2. Shift the transmission into NEUTRAL (N) or PARK (P), if equipped.
3. The brake or clutch pedal must be pressed and released once before PTO can be enabled. Do not hold the brake or clutch pedal down.
4. The cruise control switch must be in ON prior to engaging the PTO switch to enable PTO operation. This sets the PTO base engine idle at 1200 rpm.
5. Use SET/COAST to change the engine speed to the lower preset value of 1400 rpm. Use RESUME/ACCEL to change the engine speed to the upper preset value of 1800 rpm. You may toggle between upper and lower by moving the switch between SET/COAST and RESUME/ACCEL.

The PTO will become inoperative when any of the conditions are changed or the CHECK GAGES light comes on.



# NOTES

---

---

---

---

---

---

---

---

---

---

---

---

---

---

---

---

---

---

---

---

---

---

---

---

---

## Section 5 Problems on the Road

---

Here you'll find what to do about some problems that can occur on the road.

5-2 Hazard Warning Flashers  
5-3 Other Warning Devices  
5-5 Jump Starting  
5-9 Towing Your Vehicle  
5-18 Engine Overheating  
5-20 Cooling System (Gasoline Engine)

5-27 Cooling System (Diesel Engine)  
5-33 Engine Fan Noise  
5-34 If a Tire Goes Flat  
5-34 Changing a Flat Tire  
5-37 If You're Stuck: In Sand, Mud, Ice or Snow

## Hazard Warning Flashers



Your hazard warning flashers let you warn others. They also let police know you have a problem. Your front and rear turn signal lamps will flash on and off.

The hazard flasher switch is located on the steering column.



Press the button in to make your front and rear turn signal lamps flash on and off.

Your hazard warning flashers work no matter what position your key is in, and even if the key isn't in.

To turn off the flashers, pull out on the collar. When the hazard warning flashers are on, your turn signals won't work.

## Hazard Warning Flasher Switch (If Equipped)



With some options, such as U86-trailer wiring or RQ3-tractor application, you will have this switch. This switch replaces the hazard switch mounted on the steering column. It is mounted in the instrument panel, usually to the left of and below the steering column.

Pull the switch out to make your front and rear turn signal lamps flash on and off. A light next to the switch will also flash. Push it back in to turn off the flashers. The turn signal lamps won't flash if you're braking.

This switch works no matter what position the key is in, and even if the key isn't in the ignition.

When the hazard warning flashers are on, your turn signals won't work.

## Signal-Stat Turn Signal and Hazard Warning Flasher (If Equipped)

If you have this system, it lets you warn others. It also lets police know you have a problem. It makes your front and rear turn signal lamps flash on and off, but they won't flash if you're braking.

The switch is on the end of the signal-stat housing.



To make it work, pull out on the hazard lever until it locks into place. It works no matter what position your key is in, and even if the key isn't in.



To turn off the flasher, move the turn signal lever either up or down. Then move the signal lever back to the center position.

When the hazard warning flashers are on, your turn signals won't work.

## Other Warning Devices

If you carry reflective triangles, you can set one up at the side of the road behind your vehicle in the recommended manner per FMCSR (Federal Motor Carrier Safety Regulation) Section 392.22, to warn others.



## Jump Starting

If your battery (or batteries) has run down, you may want to use another vehicle and some jumper cables to start your vehicle. But please follow the steps below to do it safely.

### CAUTION:

Batteries can hurt you. They can be dangerous because:

- They contain acid that can burn you.
- They contain gas that can explode or ignite.
- They contain enough electricity to burn you.

**If you don't follow these steps exactly, some or all of these things can hurt you.**

### NOTICE:

**Ignoring these steps could result in costly damage to your vehicle that wouldn't be covered by your warranty.**

**The ACDelco Freedom<sup>®</sup> battery in your vehicle has a built-in hydrometer. Do not charge, test or jump start the battery if the hydrometer looks clear or light yellow. Replace the battery when there is a clear or light yellow hydrometer and a cranking complaint.**

**Trying to start your vehicle by pushing or pulling it won't work, and it could damage your vehicle.**

1. Check the other vehicle. It must have a 12-volt battery with a negative ground system.

### NOTICE:

**If the other system isn't a 12-volt system with a negative ground, both vehicles can be damaged.**

If you have a diesel engine vehicle with two batteries (or more), you should know before you begin that, especially in cold weather, you may not be able to get enough power from a single battery in another vehicle to start your diesel engine.

If your vehicle has more than one battery, use the battery that's closest to the starter -- this will reduce electrical resistance.

### CAUTION:

**If your vehicle has air conditioning, the auxiliary electric fan under the hood can start up even when the engine is not running and can injure you. Keep hands, clothing and tools away from any underhood electric fan.**

2. Get the vehicles close enough so the jumper cables can reach, but be sure the vehicles aren't touching each other. You wouldn't be able to start your vehicle, and the bad grounding could damage the electrical systems.
3. Turn off the ignition on both vehicles. Turn off all lamps that aren't needed, as well as radios. This will

avoid sparks and help save both batteries, and it could save your radio.

4. Locate the batteries on each vehicle. Find the positive (+) and negative (-) terminals on each battery.

### CAUTION:

**Using a match near a battery can cause battery gas to explode. People have been hurt doing this, and some have been blinded. Use a flashlight if you need more light.**

**Be sure the batteries have enough water. You don't need to add water to the ACDelco Freedom<sup>®</sup> battery (or batteries) installed in every new GM vehicle. But if a battery has filler caps, be sure the right amount of fluid is there. If it is low, add water to take care of that first. If you don't, explosive gas could be present.**

**Battery fluid contains acid that can burn you. Don't get it on you. If you accidentally get it in your eyes or on your skin, flush the place with water and get medical help immediately.**

5. Check that the jumper cables don't have loose or missing insulation. If they do, you could get a shock. The vehicles could be damaged, too.

Before you connect the cables, here are some basic things you should know. Positive (+) will go to positive (+) and negative (-) will go to a metal engine part or some other well-grounded part. Don't connect positive (+) to negative (-) or you'll get a short that would damage the battery and maybe other parts, too.

**⚠ CAUTION:**

**Fans or other moving engine parts can injure you badly. Keep your hands away from moving parts once the engine is running.**



6. Connect the red positive (+) cable to the positive (+) terminal of the vehicle with the dead battery.



7. Don't let the other end touch metal. Connect it to the positive (+) terminal of the good battery.



8. Now connect the black negative (-) cable to the good battery's negative (-) terminal.

Don't let the other end touch anything until the next step. The other end of the negative (-) cable doesn't go to the dead battery. It goes to a heavy, unpainted, metal part on the engine, or some other well-grounded part of the vehicle with the dead battery.



9. Attach the cable at least 18 inches (45 cm) away from the dead battery, but not near engine parts that move. The electrical connection is just as good there, but the chance of sparks getting back to the battery is much less.

10. Now start the vehicle with the good battery and run the engine for one to two minutes. If your vehicle has the high idle option, use it.
11. Try to start the vehicle with the dead battery. If it won't start after a few tries, it probably needs service.
12. Remove the cables in reverse order to prevent electrical shorting. Take care that they don't touch each other or any other metal.

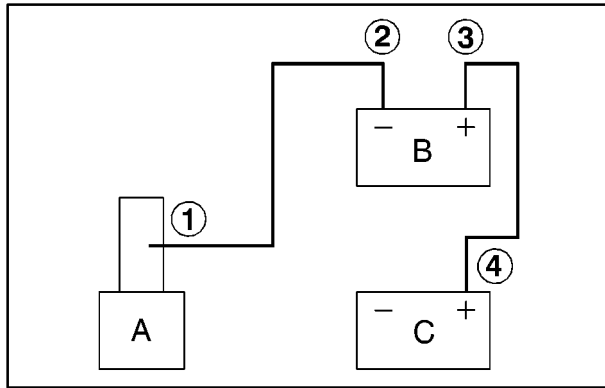

- A. Heavy Metal Engine Part
- B. Good Battery
- C. Dead Battery

## Towing Your Vehicle

Try to have a GM dealer or a professional towing service tow your vehicle. They can provide the right equipment and know-how to tow it without damage.

Before you do anything, turn on the hazard warning flashers (if they have not been damaged).

When you call, tell the towing service:

- The make, model and year of your vehicle.
- Whether you can still move the shift lever.
- If there was an accident, what was damaged.

When the towing service arrives, let the tow operator know that this manual contains detailed towing instructions. The operator may want to see them.

 **CAUTION:**

**To help avoid injury to you or others:**

- **Never let passengers ride in a vehicle that is being towed.**
- **Never tow faster than safe or posted speeds.**
- **Never tow with damaged parts not fully secured.**
- **Never get under your vehicle after it has been lifted.**
- **Always use separate safety chains on each side when towing a vehicle.**

If your vehicle uses dragfoilers, be sure to have the dragfoiler-to-cab mounting bracket bolts tightened after your vehicle has been towed.

Here are specific towing instructions:

## **Towing Your Vehicle From the Front (Front Wheels Off the Ground)**

### **Before Towing**

Block the rear wheels of the disabled vehicle. On vehicles with air brakes, release the emergency brake system by compressing the brake chamber springs as outlined in this section. (Note: This is to prevent the possibility of the emergency brake being applied during towing.)

On vehicles with hydraulic brakes without an electric/hydraulic parking brake, release the parking brake fully by moving the lever to the fully-released position.

On vehicles equipped with an electric/hydraulic parking brake option, remove the propshaft.

## Towing the Vehicle with the Front Bumper Removed

1. Remove the front bumper.
2. Connect and lock the lift chains to the front axle, outside of the spring anchor plates as shown.

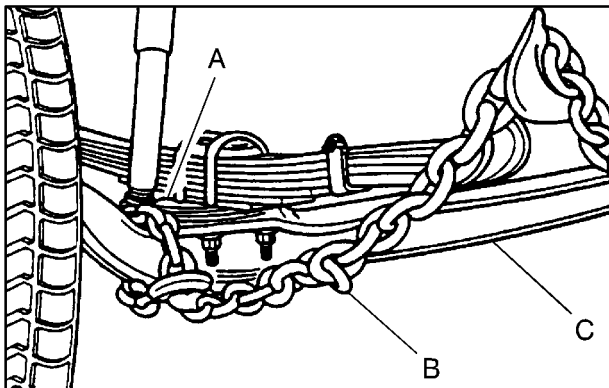

- A. Spring Anchor Plate
  - B. Lift Chain
  - C. Front Axle
3. Place a 6" x 6" x 5' hardwood beam underneath and slightly behind the front spring shackle brackets.

4. Connect lift chains to the tow bar and raise the tow bar until lift chain slack has been taken up and the hardwood beam is fully seated against the spring shackle brackets as shown.

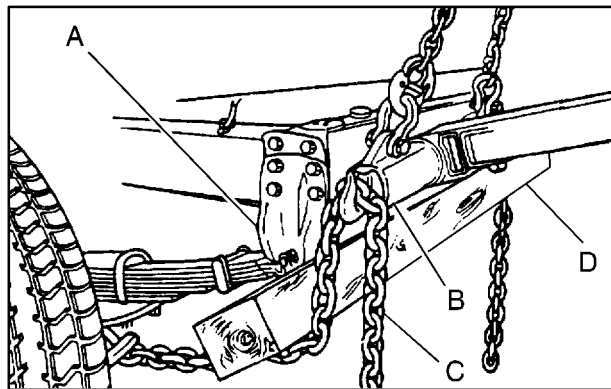

- A. Shackle Bracket
  - B. Tow Bar
  - C. Lift Chain
  - D. Hardwood Beam
5. Raise the vehicle to the required height.

## Towing the Vehicle with the Front Bumper Installed

1. Connect and lock the lift chains to the front axle, outside of the spring anchor plates as previously shown.
2. Place a 6" x 6" x 5' hardwood beam underneath and slightly behind the front spring shackle brackets as previously shown.
3. Connect the lift chains to the tow bar and take up the slack in the chains until the tow bar is within 4" of the front bumper facing. Place a 2" x 12" x 40" hardwood board with rubber pads against the front bumper and secure as shown.

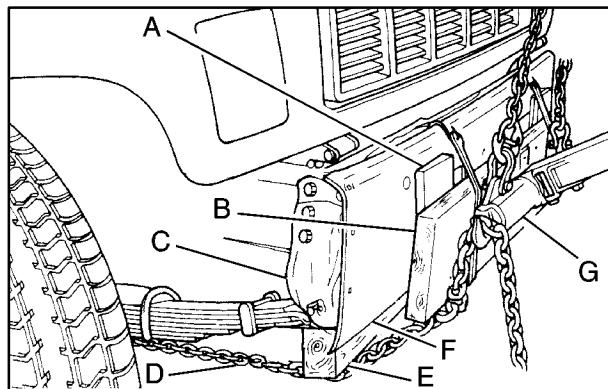

- |                    |                  |
|--------------------|------------------|
| A. Rubber Pad      | E. Hardwood Beam |
| B. Hardwood Board  | F. Bumper        |
| C. Shackle Bracket | G. Tow Bar       |
| D. Lift Chain      |                  |

4. Remove the remaining slack in the lift chains. The tow bar swing arm should rest against the 2" x 12" x 40" hardwood board as shown.



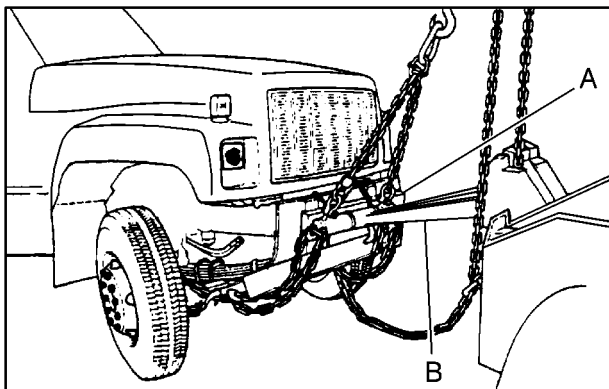

- A. Hardwood Board
- B. Swing Arm
- 5. Raise the vehicle to the required height.

### Single Drive Rear Axle

Disconnect the propshaft at the rear axle. Secure the propshaft to the frame or crossmember.

### Tandem Drive Rear Axles -- Forward Axle Off the Ground

Raise the front of the vehicle until the forward tandem axle wheels are off the ground. Remove the rearward propshaft.

### Tandem Drive Rear Axle -- Both Axles on the Ground Due to Type of Suspension or Attached Load

Disconnect the propshaft at the forward tandem axle. Secure the propshaft to the frame or crossmember.

If there is damage or suspected damage to the axle(s), remove all axle shafts. Cover the hub openings to prevent the loss of lubricant or entry of dirt or foreign objects.

## After Towing

Block the rear wheels and install axle and propeller shafts. Check for proper phasing of universal joints. Apply the emergency brake system before disconnecting from the towing vehicle. Check and fill the rear axle with oil as required.

## Towing Your Vehicle From the Front (All Wheels On the Ground)

Your vehicle may be towed on all wheels provided the steering is working. Remember that the power brakes and power steering will not have power assist. Vehicles with air brakes will not have brakes. There must be a tow bar installed between the towing vehicle and the disabled vehicle.

## Before Towing

Block the wheels of the disabled vehicle. On vehicles with air brakes, release the emergency brake system by compressing the brake chamber springs as outlined in this section. (Note: This is to prevent the possibility of the emergency brake being applied during towing.)

On vehicles with hydraulic brakes, release the parking brake fully by moving the lever to the fully-released position.

On vehicles equipped with an electric/hydraulic parking brake, remove the propshaft.

Disconnect the propshaft at the rear axle (forward axle on tandem axle models). Secure the propshaft to the frame or crossmember.

If there is damage or suspected damage to the axle(s), remove the axle shafts. Cover the hub openings to prevent the loss of lubricant or entry of dirt or foreign objects.

## After Towing

Block the rear wheels and install axle and propshafts. Check for proper phasing of universal joints. Apply the parking brake system before disconnecting from the towing vehicle. Check and fill rear axle with oil as required.

## **Towing Your Vehicle From the Rear (Rear Wheels Off the Ground)**

### **Before Towing**

Secure the steering wheel to maintain a straight-ahead position. Make certain that the front axle is not loaded above the front axle Gross Axle Weight Rating (GAWR) as indicated on the vehicle's Certification/Tire label.

### **After Towing**

Block the rear wheels and release the steering. Apply the parking brake system before disconnecting from the towing vehicle.

Refer to the transmission shift label for additional information.

## **Releasing Air-Operated Parking Brakes**

If your vehicle has air brakes, you could have a special towing problem. If your vehicle has to be towed because you had a complete loss of air pressure from both systems, the parking brakes may have applied. The tow operator can release the brakes manually by using the following steps. Then your vehicle can be towed with all wheels or just the rear wheels on the ground.

**⚠ CAUTION:**

- Working on air brakes without first using the release studs to compress the springs can lead to injury. Never work on the air brake chambers without first using the release studs to compress the brake springs.
- When the brake springs are manually compressed, you will have no brakes. Release your air-operated parking brakes manually only to tow the vehicle. Never drive the vehicle with the brakes released.

1. Block the wheels of the vehicle.



2. Remove the release stud and nut from the side of the brake chamber. Some chambers have studs which are visible at all times.



3. Remove the rubber cap from the rear of the chamber.

4. Put the release stud, nut and flat washer into the chamber.
5. Turn the stud clockwise a quarter of a turn.



6. Using a wrench, turn the stud nut clockwise several turns to release the brakes. Follow the same procedure to release the other brake.

7. At the repair facility, apply air pressure of at least 70 psi (480 kPa) to the brake chambers, either from an external air supply or the vehicle's air system.
8. Turn the stud nut counterclockwise several turns. Remove the stud from the chamber.
9. Put the stud into the side of the chamber, and replace the rubber cap.

## Engine Overheating

You will find a coolant temperature warning gage on your vehicle's instrument panel, as well as a LOW COOLANT warning light. Your vehicle also has a CHECK GAGES warning light on the instrument panel.

### If Steam Is Coming From Your Engine



#### CAUTION:

**Steam from an overheated engine can burn you badly, even if you just open the hood. Stay away from the engine if you see or hear steam coming from it. Just turn it off and get everyone away from the vehicle until it cools down. Wait until there is no sign of steam or coolant before you open the hood.**

**If you keep driving when your engine is overheated, the liquids in it can catch fire. You or others could be badly burned. Stop your engine if it overheats, and get out of the vehicle until the engine is cool.**

#### NOTICE:

**If your engine catches fire because you keep driving with no coolant, your vehicle can be badly damaged. The costly repairs would not be covered by your warranty.**

## If No Steam Is Coming From Your Engine

If you get an engine overheat warning but see or hear no steam, the problem may not be too serious. Sometimes the engine can get a little too hot when you:

- Climb a long hill on a hot day.
- Stop after high-speed driving.
- Idle for long periods in traffic.

If you get the overheat warning with no sign of steam, try this for a minute or so:

1. If you have an air conditioner and it's on, turn it off.
2. Turn on your heater to full hot at the highest fan speed and open the window as necessary.
3. If you're in a traffic jam, shift to NEUTRAL (N); otherwise, shift to the highest gear while driving -- DRIVE (D) for automatic transmissions.
4. If climbing a hill, downshift to raise engine and fan speeds.

If you no longer have the overheat warning, you can drive. Just to be safe, drive slower for about 10 minutes. If the warning doesn't come back on, you can drive normally.

If the warning continues, pull over, stop, and park your vehicle right away.

If there's still no sign of steam, push down the accelerator until the engine speed is about twice as fast as normal idle speed for at least three minutes while you're parked. If you still have the warning, *turn off the engine and get everyone out of the vehicle* until it cools down.

You may decide not to lift the hood but to get service help right away.

## Cooling System (Gasoline Engine)

When you decide it's safe to lift the hood, here's what you'll see:

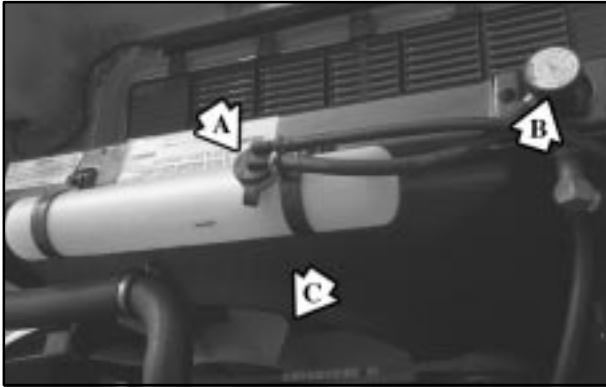

**Specialty Hood**

- A. Coolant Recovery Tank
- B. Radiator Pressure Cap
- C. Engine Fan

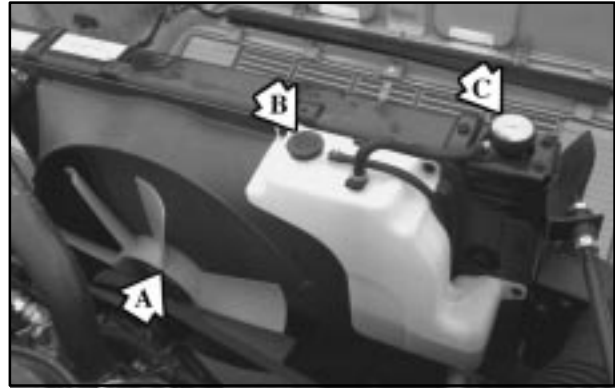

**Sloped Hood**

- A. Engine Fan
- B. Coolant Recovery Tank
- C. Radiator Pressure Cap



**⚠ CAUTION:**

**If your vehicle has air conditioning, the auxiliary electric engine cooling fan under the hood can start up even when the engine is not running and can injure you. Keep hands, clothing and tools away from any underhood electric fan.**

If the coolant inside the coolant recovery tank is boiling, don't do anything else until it cools down.

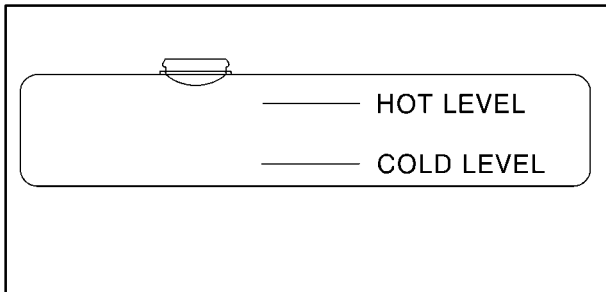

**Specialty Hood**

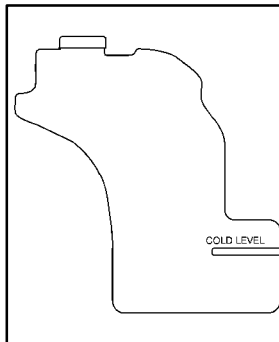

**Sloped Hood**

The coolant level should be above the **HOT LEVEL** mark on the vehicle with the specialty hood, or at or above the **COLD LEVEL** mark on the vehicle with the sloped hood.

If it isn't, you may have a leak in the radiator hoses, heater hoses, radiator, water pump or somewhere else in the cooling system.

**⚠ CAUTION:**

**Heater and radiator hoses, and other engine parts, can be very hot. Don't touch them. If you do, you can be burned.**

**CAUTION: (Continued)**

**CAUTION: (Continued)**

Don't run the engine if there is a leak. If you run the engine, it could lose all coolant. That could cause an engine fire, and you could be burned. Get any leak fixed before you drive the vehicle.

**NOTICE:**

Engine damage from running your engine without coolant isn't covered by your warranty.

**NOTICE:**

When adding coolant, it is important that you use only DEX-COOL<sup>®</sup> (silicate-free) coolant.

**NOTICE: (Continued)**

**NOTICE: (Continued)**

If coolant other than DEX-COOL is added to the system, premature engine, heater core or radiator corrosion may result. In addition, the engine coolant will require change sooner -- at 30,000 miles (50 000 km) or 24 months, whichever occurs first. Damage caused by the use of coolant other than DEX-COOL<sup>®</sup> is not covered by your new vehicle warranty.

If there seems to be no leak, start the engine again. See if the engine cooling fan speed increases when idle speed is doubled by pushing the accelerator pedal down. If it doesn't, your vehicle needs service. Turn off the engine.

### How to Add Coolant to the Coolant Recovery Tank

If you haven't found a problem yet, but the coolant level isn't at or above the HOT LEVEL mark on the vehicle with the specialty hood, or at or above the COLD LEVEL mark on the vehicle with the sloped hood, add a 50/50 mixture of *clean, drinkable water* and DEX-COOL<sup>®</sup> engine coolant at the coolant recovery tank. (See "Engine Coolant" in the Index for more information.)

**⚠ CAUTION:**

Adding only plain water to your cooling system can be dangerous. Plain water, or some other liquid like alcohol, can boil before the proper coolant mixture will. Your vehicle's coolant warning system is set for the proper coolant mixture. With plain water or the wrong mixture, your engine could get too hot but you wouldn't get the overheat warning. Your engine could catch fire and you or others could be burned. Use a 50/50 mixture of clean, drinkable water and DEX-COOL<sup>®</sup> coolant.

**NOTICE:**

In cold weather, water can freeze and crack the engine, radiator, heater core and other parts. Use the recommended coolant and the proper coolant mixture.



Specialty Hood



Sloped Hood

**⚠ CAUTION:**

You can be burned if you spill coolant on hot engine parts. Coolant contains ethylene glycol and it will burn if the engine parts are hot enough. Don't spill coolant on a hot engine.

When the coolant in the coolant recovery tank is at the **HOT LEVEL** mark on the vehicle with the specialty hood, or approximately half full on the vehicle with the sloped hood, start your vehicle.

If the overheat warning continues, there's one more thing you can try. You can add the proper coolant mixture directly to the radiator, but be sure the cooling system is cool before you do it.

**⚠ CAUTION:**

**Steam and scalding liquids from a hot cooling system can blow out and burn you badly. They are under pressure, and if you turn the radiator pressure cap -- even a little -- they can come out at high speed. Never turn the cap when the cooling system, including the radiator pressure cap, is hot. Wait for the cooling system and radiator pressure cap to cool if you ever have to turn the pressure cap.**



## How to Add Coolant to the Radiator



1. You can remove the radiator pressure cap when the cooling system, including the radiator pressure cap and upper radiator hose, is no longer hot.

Turn the pressure cap slowly counterclockwise until it first stops. (Don't press down while turning the pressure cap.)

If you hear a hiss, wait for that to stop. A hiss means there is still some pressure left.



2. Then keep turning the pressure cap, but now push down as you turn it. Remove the pressure cap.



3. Fill the radiator with the proper DEX-COOL<sup>®</sup> coolant mixture, up to the base of the filler neck. (See "Engine Coolant" in the Index for more information about the proper coolant mixture.)

4. Then fill the coolant recovery tank to the HOT LEVEL mark on the vehicle with the specialty hood, or approximately one-half full on the vehicle with the sloped hood.
5. Put the cap back on the coolant recovery tank, but leave the radiator pressure cap off.



6. Start the engine and let it run until you can feel the upper radiator hose getting hot. Watch out for the engine cooling fan(s).

7. By this time, the coolant level inside the radiator filler neck may be lower. If the level is lower, add more of the proper DEX-COOL<sup>®</sup> coolant mixture through the filler neck until the level reaches the base of the filler neck.



8. Then replace the pressure cap. At any time during this procedure if coolant begins to flow out of the filler neck, reinstall the pressure cap. Be sure the arrows on the pressure cap line up like this.

## Cooling System (Diesel Engine)

When you decide it's safe to lift the hood, here's what you'll see:



**Caterpillar® Diesel Engine**

- A. Engine Fan
- B. Coolant Surge Tank

### **CAUTION:**

**If your vehicle has air conditioning, the auxiliary electric engine cooling fan under the hood can start up even when the engine is not running and can injure you. Keep hands, clothing and tools away from any underhood electric fan.**

If the coolant inside the coolant surge tank is boiling, don't do anything else until it cools down.

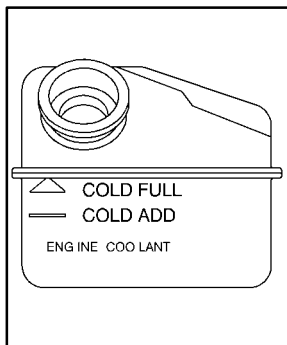

The coolant level should be at COLD ADD or higher. If it isn't, you may have a leak in the radiator hoses, heater hoses, radiator, water pump or somewhere else in the cooling system.

**Caterpillar® Diesel  
Engine**

## **⚠ CAUTION:**

**Heater and radiator hoses, and other engine parts, can be very hot. Don't touch them. If you do, you can be burned.**

**Don't run the engine if there is a leak. If you run the engine, it could lose all coolant. That could cause an engine fire, and you could be burned. Get any leak fixed before you drive the vehicle.**

## **NOTICE:**

**Engine damage from running your engine without coolant isn't covered by your warranty.**

If there seems to be no leak, start the engine again. See if the fan speed increases when idle speed is doubled by pushing the accelerator pedal down. If it doesn't, your vehicle needs service. Turn off the engine.



## How to Add Coolant to the Coolant Surge Tank

If you haven't found a problem yet, but the coolant level isn't at the COLD ADD mark or higher, add a 50/50 mixture of *clean, drinkable water* and coolant at the coolant surge tank, but be sure the cooling system, including the coolant surge tank pressure cap, is cool before you do it. (See the Caterpillar® Operation & Maintenance Manual for the proper engine coolant to use.)

### CAUTION:

**Steam and scalding liquids from a hot cooling system can blow out and burn you badly. They are under pressure, and if you turn the coolant surge tank pressure cap -- even a little -- they can come out at high speed. Never turn the cap when the cooling system, including the coolant surge tank pressure cap, is hot. Wait for the cooling system and coolant surge tank pressure cap to cool if you ever have to turn the pressure cap.**



 **CAUTION:**

Adding only plain water to your cooling system can be dangerous. Plain water, or some other liquid like alcohol, can boil before the proper coolant mixture will. Your vehicle's coolant warning system is set for the proper coolant mixture. With plain water or the wrong mixture, your engine could get too hot but you wouldn't get the overheat warning. Your engine could catch fire and you or others could be burned. Use a 50/50 mixture of clean, drinkable water and coolant.

**NOTICE:**

In cold weather, water can freeze and crack the engine, radiator, heater core and other parts. So use the recommended coolant.

 **CAUTION:**

You can be burned if you spill coolant on hot engine parts. Coolant contains ethylene glycol and it will burn if the engine parts are hot enough. Don't spill coolant on a hot engine.



1. You can remove the coolant surge tank pressure cap when the cooling system, including the coolant surge tank pressure cap and upper radiator hose, is no longer hot. Turn the pressure cap slowly counterclockwise until it first stops. (Don't press down while turning the pressure cap.)
2. Then keep turning the cap, but now push down as you turn it. Remove the pressure cap.

If you hear a hiss, wait for that to stop. A hiss means there is still some pressure left.



3. Then fill the coolant surge tank with the proper coolant mixture, up to the COLD FULL mark.



4. With the coolant surge tank pressure cap off, start the engine and let it run until you can feel the upper radiator hose getting hot. Watch out for the engine fan.

By this time, the coolant level inside the coolant surge tank may be lower. If the level is lower, add more of the proper mixture to the coolant surge tank until the level reaches the COLD FULL mark.



5. Then replace the pressure cap. Be sure the arrows on the pressure cap line up like this.

## Engine Fan Noise

Your vehicle has a clutched engine cooling fan. When the clutch is engaged, the fan spins faster to provide more air to cool the engine. In most everyday driving conditions, the clutch is not fully engaged. This improves fuel economy and reduces fan noise. Under heavy vehicle loading, trailer towing and/or high outside temperatures, the fan speed increases when the clutch engages. So you may hear an increase in fan noise. This is normal and should not be mistaken as the transmission slipping or making extra shifts. It is merely the cooling system functioning properly. The fan will slow down when additional cooling is not required and the clutch disengages.

You may also hear this fan noise when you start the engine. It will go away as the fan clutch disengages.

## If a Tire Goes Flat

It's unusual for a tire to "blow out" while you're driving, especially if you maintain your tires properly. If air goes out of a tire, it's much more likely to leak out slowly. But if you should ever have a "blowout," here are a few tips about what to expect and what to do:

If a front tire fails, the flat tire will create a drag that pulls the vehicle toward that side. Take your foot off the accelerator pedal and grip the steering wheel firmly. Steer to maintain lane position, and then gently brake to a stop well out of the traffic lane.

A rear blowout, particularly on a curve, acts much like a skid and may require the same correction you'd use in a skid. In any rear blowout, remove your foot from the accelerator pedal. Get the vehicle under control by steering the way you want the vehicle to go. It may be very bumpy and noisy, but you can still steer. Gently brake to a stop -- well off the road if possible.

If a tire goes flat, the next part tells you what to do.

## Changing a Flat Tire

A flat or damaged tire can be a major roadside problem. You're very likely to have to go for help. Few drivers of these vehicles have the necessary equipment aboard to be able to change a flat tire safely. For example, you

have to have a truck jack that can lift several thousand pounds and a torque wrench that can generate several hundred foot-pounds (newton-meters) of twisting force.

So if you're stopped somewhere by a flat or damaged tire or wheel, you should get expert help right then.

If the correct equipment is available, though, here is the procedure to follow.

- Does the tire still seem to have air under pressure in it? If so, stand to the side and look at the wheel. See if it looks like another wheel on the vehicle. If so, go on to the next step. If it doesn't, or even if you can't be sure, stop and get expert help.



### CAUTION:

**Tire-rim assemblies can explode. If you work on a pressurized tire mounted on a damaged wheel, the assembly can expand with explosive force without warning. You and others nearby can be badly injured. Don't work around a tire that has air under pressure in it when its wheel is or might be damaged.**

- If the wheel looks normal, see if the wheel has side rings and a lock ring around the wheel rim. If so, they must be seated properly. You can compare with another wheel on the vehicle as you check for this. For dual wheels, you have to look between the tires to make this check. You may not be able to tell if the side rings or lock rings are seated properly by looking. If you can't be sure, stop and get expert help.

 **CAUTION:**

**If you work on a pressurized tire mounted on a damaged wheel, the assembly can expand with explosive force without warning. You and others nearby can be badly injured. Don't work around a tire that has air under pressure in it when its lock ring or side ring might not be properly seated.**

 **CAUTION:**

**Rust or dirt on the wheel, or on the parts to which it is fastened, can make the wheel nuts become loose after a time. The wheel could come off and cause an accident. When you change a wheel, remove any rust or dirt from the places where the wheel attaches to the vehicle. In an emergency, you can use a cloth or a paper towel to do this; but be sure to use a scraper or wire brush later, if you need to, to get all the rust or dirt off.**

- If the lock ring and side rings seem to be seated properly (or if the wheel doesn't have these), let the air out of the tire. You can do this by taking out the valve core.
- If the flat or damaged tire is one of a dual set, let the air out of both tires of the dual before you take off the damaged tire and rim assembly.
- If you have the correct equipment, put on the spare wheel and tire assembly.

 **CAUTION:**

Never use oil or grease on studs or nuts. If you do, the nuts might come loose. Your wheel could fall off, causing a serious accident.

 **CAUTION:**

- There are many ways to be hurt badly, or be killed, while you are trying to change a truck tire and rim. Follow all of the safety precautions on the truck jack and other equipment.

**CAUTION: (Continued)**

**CAUTION: (Continued)**

- If you try to put air back into a tire that has run flat, or even a tire that was quite low on air, without first finding out why it was low or flat, the tire can have a sudden air-out. This could cause you to lose control of the vehicle and have a serious crash. Don't refill a flat or very low tire with air without first having the tire taken off the wheel and checked for damage.
- Use a clip-on chuck and hose extension when you add air to your tires. You'll need an accurate truck tire pressure gage. Stand to one side and add the air. Be sure you don't go over the top inflation pressure for the tire.



 **CAUTION:**

**Incorrect wheel nuts or improperly tightened wheel nuts can cause the wheel to become loose and even come off. This could lead to an accident. Be sure to use the correct wheel nuts. If you have to replace them, be sure to get new GM original equipment wheel nuts.**

**Stop somewhere as soon as you can and have the nuts tightened with a torque wrench.**

**See “Tightening the Wheel Nuts” in the Index for the proper torque for your particular wheel.**

**NOTICE:**

**Improperly tightened wheel nuts can lead to brake pulsation and rotor damage. To avoid expensive brake repairs, evenly tighten the wheel nuts in the proper sequence and to the proper torque specification.**

## **If You’re Stuck: In Sand, Mud, Ice or Snow**

In order to free your vehicle when it is stuck, you will need to spin the wheels, but you don’t want to spin your wheels too fast. The method known as “rocking” can help you get out when you’re stuck, but you must use caution.

 **CAUTION:**

**If you let your tires spin at high speed, they can explode, and you or others could be injured. And, the transmission or other parts of the vehicle can overheat. That could cause an engine compartment fire or other damage. When you’re stuck, spin the wheels as little as possible. Don’t spin the wheels above 35 mph (55 km/h) as shown on the speedometer.**

**NOTICE:**

**Spinning your wheels can destroy parts of your vehicle as well as the tires. If you spin the wheels too fast while shifting your transmission back and forth, you can destroy your transmission.**

**Rocking Your Vehicle To Get It Out**

First, turn your steering wheel left and right. That will clear the area around your front wheels. Then shift back and forth between REVERSE (R) and a forward gear (or with a manual transmission, between FIRST (1) or SECOND (2) and REVERSE (R)), spinning the wheels as little as possible. Release the accelerator pedal while you shift, and press lightly on the accelerator pedal when the transmission is in gear. By slowly spinning your wheels in the forward and reverse directions, you will cause a rocking motion that may free your vehicle. If that doesn't get you out after a few tries, you may need to be towed out. If you do need to be towed out, see "Towing Your Vehicle" in the Index.



# NOTES

---

---

---

---

---

---

---

---

---

---

---

---

---

---

---

---

---

---

---

---

---

---

---

---

---

---



# NOTES

---

---

---

---

---

---

---

---

---

---

---

---

---

---

---

---

---

---

---

---

---

---

---

---

---

---

---

---

---

---



# NOTES

---

---

---

---

---

---

---

---

---

---

---

---

---

---

---

---

---

---

---

---

---

---



# NOTES

---

---

---

---

---

---

---

---

---

---

---

---

---

---

---

---

---

---

---

---

---

---

---

---

---

---

## Section 6 Service and Appearance Care

---

Here you will find information about the care of your vehicle. This section begins with service and fuel information, and then it shows how to check important fluid and lubricant levels. There is also technical information about your vehicle, and a part devoted to its appearance care.

6-2	Service	6-23	Engine Coolant (Gasoline Engine)
6-4	Fuel (Gasoline Engine)	6-27	Engine Coolant (Caterpillar® Diesel Engine)
6-5	Diesel Fuel Requirements and Fuel System	6-28	Power Steering Fluid
6-6	Fuels in Foreign Countries (Gasoline Engines)	6-29	Windshield Washer Fluid
6-7	Filling Your Tank	6-30	Brakes
6-8	Filling a Portable Fuel Container	6-36	Electric/Hydraulic Parking Brake Fluid
6-9	Checking Things Under the Hood	6-42	Battery
6-11	Noise Control System	6-44	Other Service Items
6-13	Engine Oil (Gasoline Engine)	6-48	Tires
6-17	Engine Oil (Caterpillar® Diesel Engine)	6-59	Appearance Care
6-17	Engine Air Cleaner/Filter	6-59	Cleaning the Inside of Your Vehicle
6-18	Automatic Transmission Fluid	6-63	Cleaning the Outside Your Vehicle
6-19	Manual Transmission Fluid	6-66	GM Vehicle Care/Appearance Materials
6-20	Rear Axle	6-67	Vehicle Identification Number (VIN)
6-20	Rear Axle Shift Motor (Option)	6-67	Service Parts Identification Label
6-21	Radiator Pressure Cap (Gasoline Engines)	6-68	Electrical System
6-22	Surge Tank Pressure Cap (Diesel Engines)	6-74	Capacities and Specifications
6-22	Thermostat	6-77	Air Conditioning Refrigerants

## Service

Your dealer knows your vehicle best and wants you to be happy with it. We hope you'll go to your dealer for all your service needs. You'll get genuine GM parts and GM-trained and supported service people.

We hope you'll want to keep your GM vehicle all GM. Genuine GM parts have one of these marks:

**ACDelco**<sup>®</sup>

---

Genuine



Parts

---



**Goodwrench**

## Doing Your Own Service Work

If you want to do some of your own service work, you'll want to use the proper service manual. It tells you much more about how to service your vehicle than this manual can. To order the proper service manual, see "Service and Owner Publications" in the Index.

You should keep a record with all parts receipts and list the mileage and the date of any service work you perform. See "Maintenance Record" in the Index.

### CAUTION:

**You can be injured and your vehicle could be damaged if you try to do service work on a vehicle without knowing enough about it.**

- **Be sure you have sufficient knowledge, experience, the proper replacement parts and tools before you attempt any vehicle maintenance task.**
- **Be sure to use the proper nuts, bolts and other fasteners. "English" and "metric" fasteners can be easily confused. If you use the wrong fasteners, parts can later break or fall off. You could be hurt.**



## Two Safety Cautions about Engine Fan Breakage

### CAUTION:

#### **Changing the Fan Drive Ratio or Engine Governed Speed**

If you change the fan drive ratio or increase the governed speed of the engine, you may increase stress on the engine fan and the fan could eventually fail. If the fan breaks apart while it is rotating, the flying pieces can cause severe injury to anyone -- such as a service technician -- who is nearby. And, of course, the pieces can severely damage the vehicle. Don't change the fan drive ratio or increase the governed speed of the vehicle without getting the necessary information from your dealer.

**CAUTION: (Continued)**

### **CAUTION: (Continued)**

**Winter Fronts, Grille Covers or Obstructions**  
Winter fronts, grille covers or other add-on equipment causing obstructions in front or behind the fan should not be used on this vehicle. They may increase the stress on the fan as the blades pass over the covered areas. If this causes the fan to eventually break apart while it is rotating, the pieces can cause severe injury to anyone nearby, such as a service technician working on the engine, and of course the pieces can severely damage the vehicle.

If your vehicle is equipped with the optional radiator shutters, see "Radiator Shutters" in the Index.

## Fuel (Gasoline Engine)

If your vehicle has a diesel engine, see “Diesel Engine Fuel” in this section. For vehicles with gasoline engines, please read this.

Use regular unleaded gasoline rated at 87 octane or higher. It is recommended that the gasoline meet specifications which have been developed by the American Automobile Manufacturers Association (AAMA) and endorsed by the Canadian Motor Vehicle Manufacturers Association for better vehicle performance and engine protection. Gasolines meeting the AAMA specification could provide improved driveability and emission control system performance compared to other gasolines. For more information, write to: American Automobile Manufacturer’s Association, 7430 Second Ave, Suite 300, Detroit MI 48202.

Be sure the posted octane is at least 87. If the octane is less than 87, you may get a heavy knocking noise when you drive. If it’s bad enough, it can damage your engine.

If you’re using fuel rated at 87 octane or higher and you hear heavy knocking, your engine needs service. But don’t worry if you hear a little pinging noise when you’re accelerating or driving up a hill. That’s normal, and you don’t have to buy a higher octane fuel to get rid of pinging. It’s the heavy, constant knock that means you have a problem.

Some gasolines that are not reformulated for low emissions may contain an octane-enhancing additive called methylcyclopentadienyl manganese tricarbonyl (MMT); ask your service station operator whether or not the fuel contains MMT. General Motors does not recommend the use of such gasolines. If fuels containing MMT are used, spark plug life may be reduced and your emission control system performance may be affected. The malfunction indicator lamp on your instrument panel may turn on. If this occurs, return to your authorized GM dealer for service.

To provide cleaner air, all gasolines in the United States are now required to contain additives that will help prevent deposits from forming in your engine and fuel system, allowing your emission control system to function properly. Therefore, you should not have to add anything to the fuel. In addition, gasolines containing oxygenates, such as ethers and ethanol, and reformulated gasolines may be available in your area to contribute to clean air. General Motors recommends that you use these gasolines, particularly if they comply with the specifications described earlier.

### **NOTICE:**

**Your vehicle was not designed for fuel that contains methanol. Don't use it. It can corrode metal parts in your fuel system and also damage plastic and rubber parts. That damage wouldn't be covered under your warranty.**

## **Diesel Fuel Requirements and Fuel System**

### **Diesel Engine Fuel**

See your Caterpillar<sup>®</sup> Operator & Maintenance Manual for information concerning fuel usage.

### **Water in Fuel**

Sometimes, water can be pumped into your fuel tank along with your diesel fuel. This can happen if a service station doesn't regularly inspect and clean its fuel tanks, or if it gets contaminated fuel from its suppliers.

If this happens, water must be drained. Your dealer can show you how to do this.

### **CAUTION:**

**Diesel fuel containing water is still flammable. You could be burned. If you ever try to drain water from your fuel, keep sparks, flames and smoking materials away from the mixture.**

**NOTICE:**

**If there is water in your diesel fuel and the weather is warm or humid, fungus and bacteria can grow in the fuel. They can damage your fuel system. You'll need a diesel fuel biocide to sterilize your fuel system. Your dealer can advise you if you ever need this.**

**If your fuel tank needs to be purged to remove water, see your dealer or a qualified technician. Improper purging can damage your fuel system.**

Diesel engine vehicles that stand unused for several days or weeks can develop water in the fuel from condensation. It helps to fill the fuel tank if the diesel engine vehicle will not be used for a time.

## **Fuels in Foreign Countries (Gasoline Engines)**

If you plan on driving in another country outside the United States or Canada, the proper fuel may be hard to find. Never use leaded gasoline or any other fuel not recommended in the previous text on fuel. Costly repairs caused by use of improper fuel wouldn't be covered by your warranty.

To check on fuel availability, ask an auto club, or contact a major oil company that does business in the country where you'll be driving.

You can also write us at the following address for advice. Just tell us where you're going and give your Vehicle Identification Number (VIN).

General Motors Overseas Distribution Corporation  
1908 Colonel Sam Drive  
Oshawa, Ontario L1H 8P7

## Filling Your Tank



### CAUTION:

**Fuel vapor is highly flammable. It burns violently, and that can cause very bad injuries. Don't smoke if you're near gasoline or diesel fuel, or if you're refueling your vehicle. Keep sparks, flames and smoking materials away from gasoline or diesel fuel.**

The fuel cap can be on either or both sides of your vehicle depending on option content.

To take off the cap, turn it slowly to the left (counterclockwise).

### CAUTION:

**Gasoline Engine Vehicles: If you get gasoline on you and then something ignites it, you could be badly burned. Gasoline can spray out on you if you open the fuel filler cap too quickly. This spray can happen if your tank is nearly full, and is more likely in hot weather. Open the fuel filler cap slowly and wait for any "hiss" noise to stop. Then unscrew the cap all the way.**

When you put the cap back on, turn it to the right until it is tight.

**NOTICE:**

If you need a new cap, be sure to get the right type. Your dealer can get one for you. If you get the wrong type, it may not fit or have proper venting, and your fuel tank and emissions system might be damaged.

If you have dual tanks, fill the driver's side first. The fuel gage will give better readings this way. Your gage will show the average level of both tanks combined.

**Filling a Portable Fuel Container** **CAUTION:**

Never fill a portable fuel container while it is in your vehicle. Static electricity discharge from the container can ignite the gasoline vapor. You can be badly burned and your vehicle damaged if this occurs. To help avoid injury to you and others:

- Dispense gasoline only into approved containers.
- Do not fill a container while it is inside a vehicle, in a vehicle's trunk, pickup bed or on any surface other than the ground.
- Bring the fill nozzle in contact with the inside of the fill opening before operating the nozzle. Contact should be maintained until the filling is complete.
- Don't smoke while pumping gasoline.

## Checking Things Under the Hood



To tilt the hood forward, pull out on each of the hood latches. If the hood is equipped with hood access panels, make sure the panel latches are locked down before rotating the hood open.

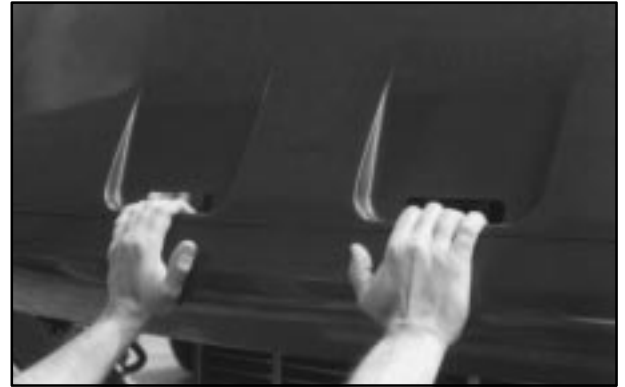

Then take the hand holds and pull the hood forward.

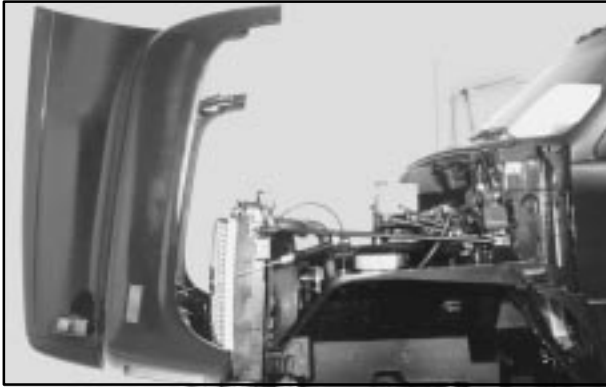

When you rotate the hood far enough, the cables will support it.



If your vehicle has the optional hood access panels, you can easily get to one side of the engine or the other as you need to.

Pull out on the top of each hood latch. Then push the latch down and swing the bottom out.





Then place the prop rod, located on the panel, where the arrow is pointing.

Before closing the hood or access panels, be sure all the filler caps are on properly.

## Noise Control System

The following information relates to compliance with Federal noise emission standards for vehicles with a Gross Vehicle Weight Rating (GVWR) of more than 10,000 lbs. (4 536 kg). The Maintenance Schedule provides information on maintaining the noise control system to minimize degradation of the noise emission control system during the life of your vehicle. The noise control system warranty is given in your Warranty booklet.

These standards apply only to vehicles sold in the United States.

### CAUTION:

**Things that burn can get on hot engine parts and start a fire. These include liquids like gasoline or diesel fuel, oil, coolant, brake fluid, windshield washer and other fluids, and plastic or rubber. You or others could be burned. Be careful not to drop or spill things that will burn onto a hot engine.**

## Tampering With Noise Control System Prohibited

Federal law prohibits the following acts or the causing thereof:

1. The removal or rendering inoperative by any person, other than for purposes of maintenance, repair or replacement, of any device or element of design incorporated into any new vehicle for the purpose of noise control, prior to its sale or delivery to the ultimate purchaser or while it is in use; or
2. The use of the vehicle after such device or element of design has been removed or rendered inoperative by any person.

Among those acts presumed to constitute tampering are the acts listed below.

### Insulation:

- Removal of the noise shields or any underhood insulation.

### Engine:

- Removal or rendering engine speed governor (if equipped) inoperative so as to allow engine speed to exceed manufacturer specifications.

### Fan and Drive:

- Removal of fan clutch (if equipped) or rendering clutch inoperative.
- Removal of the fan shroud (if equipped).

### Air Intake:

- Removal of the air cleaner silencer.
- Reversing the air cleaner cover.

### Exhaust:

- Removal of the muffler and/or resonator.
- Removal of the exhaust pipes and exhaust pipe clamps.

## Engine Oil (Gasoline Engine)

It's a good idea to check your engine oil every time you get fuel. In order to get an accurate reading, the oil must be warm and the vehicle must be on level ground.



The engine oil dipstick is located on the passenger's side of the engine compartment.

Turn off the engine and give the oil several minutes to drain back into the oil pan. If you don't, the oil dipstick might not show the actual level.

## Checking Engine Oil

Pull out the dipstick and clean it with a paper towel or cloth, then push it back in all the way. Remove it again, keeping the tip down, and check the level.



## When to Add Engine Oil

If the oil is at or below the cross-hatched area, then you'll need to add at least one quart of oil. But you must use the right kind. This part explains what kind of oil to use. For crankcase capacity, see "Capacities and Specifications" in the Index.

### NOTICE:

**Don't add too much oil. If your engine has so much oil that the oil level gets above the cross-hatched area that shows the proper operating range, your engine could be damaged.**

Be sure to fill it enough to put the level somewhere in the proper operating range. Push the dipstick all the way back in when you're through.

## What Kind of Engine Oil to Use

Oils recommended for your vehicle can be identified by looking for the "Starburst" symbol. This symbol indicates that the oil has been certified by the American Petroleum Institute (API). Do not use any oil which does not carry this Starburst symbol.



If you change your own oil, be sure you use oil that has the Starburst symbol on the front of the oil container. If you have your oil changed for you, be sure the oil put into your engine is American Petroleum Institute certified for gasoline engines.

You should also use the proper viscosity oil for your vehicle, as shown in the following chart:

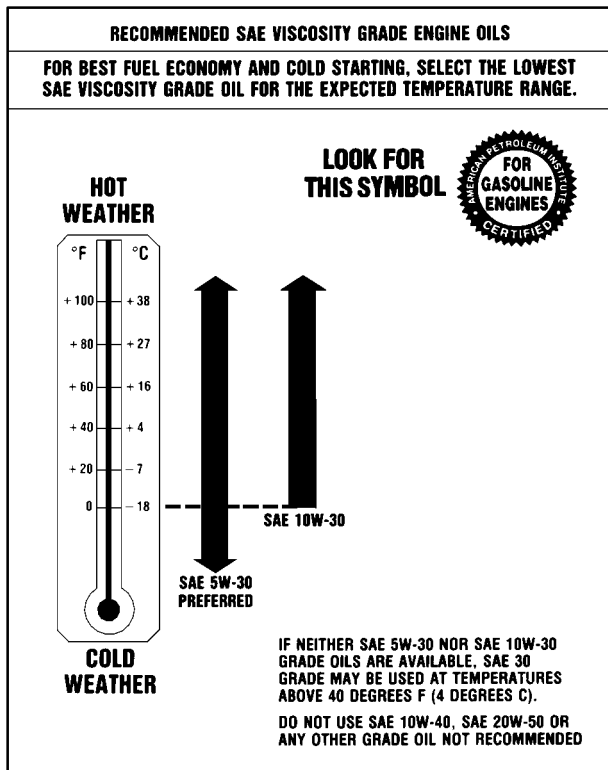

As shown in the chart, SAE 5W-30 is best for your vehicle. However, you can use SAE 10W-30 if it's going to be 0°F (-18°C) or above. These numbers on an oil container show its viscosity, or thickness. Do not use other viscosity oils, such as SAE 20W-50.

## NOTICE:

**Use only engine oil with the American Petroleum Institute Certified For Gasoline Engines “Starburst” symbol. Failure to use the recommended oil can result in engine damage not covered by your warranty.**

GM Goodwrench<sup>®</sup> oil meets all the requirements for your vehicle.

If you are in an area where the temperature falls below -20°F (-29°C), consider using either an SAE 5W-30 synthetic oil or an SAE 0W-30 oil. Both will provide easier cold starting and better protection for your engine at extremely low temperatures.

## Engine Oil Additives

Don't add anything to your oil. Your dealer is ready to advise if you think something should be added.

## When to Change Engine Oil

Your vehicle has a computer that lets you know when to change your engine oil. This is not based on mileage, but on engine revolutions and engine operating temperature. When the computer has calculated that the oil needs changing, the Oil Life Monitor will indicate that a change is necessary. The mileage between oil changes will vary depending on how you drive your vehicle -- usually between 3,000 miles (5 000 km) and 7,500 miles (12 500 km) since your last oil change. Under severe conditions, the indicator may come on before 3,000 miles (5 000 km). Never drive your vehicle more than 7,500 miles (12 500 km) or 12 months (whichever occurs first) without an oil change.

The system won't detect dust in the oil. So, if you drive in a dusty area, be sure to change your oil every 3,000 miles (5 000 km) or sooner. Remember to reset the CHANGE OIL light whenever the oil is changed.

## How to Reset the Oil Life Monitor

To reset the CHANGE OIL message, turn the ignition key to RUN with the engine off. Fully press and release the accelerator pedal three times within 10 seconds. If the CHANGE OIL message flashes for five seconds, the system is reset. If the message does not display for five seconds, you will need to reset the system again.

## What to Do with Used Oil

Did you know that used engine oil contains certain elements that may be unhealthy for your skin and could even cause cancer? Don't let used oil stay on your skin for very long. Clean your skin and nails with soap and water, or a good hand cleaner. Wash or properly throw away clothing or rags containing used engine oil. (See the manufacturer's warnings about the use and disposal of oil products.)

Used oil can be a real threat to the environment. If you change your own oil, be sure to drain all free-flowing oil from the filter before disposal. Don't ever dispose of oil by putting it in the trash, pouring it on the ground, into sewers, or into streams or bodies of water. Instead, recycle it by taking it to a place that collects used oil. If you have a problem properly disposing of your used oil, ask your dealer, a service station or a local recycling center for help.

## Engine Oil (Caterpillar® Diesel Engines)

See your Caterpillar® Operation & Maintenance Manual for information on oil quality and viscosities as well as the temperature range chart.

## Air Filter Restriction Indicator

Your engine has an indicator that lets you know when the air filter is dirty and needs to be serviced. It is in the air intake tube below the air cleaner on the passenger's side of the engine.



When the yellow indicator reaches the red ring in the sight glass, it's time to service the air filter.

After the air filter is properly serviced, the indicator can be reset by pushing the button on top of the indicator.

## Engine Air Cleaner/Filter

Your GM Maintenance Schedule says when to replace the air filter.



Gasoline Engine



Caterpillar® Diesel  
Engine

 **CAUTION:**

**Gasoline Engines Only:** Operating the engine with the air cleaner/filter off can cause you or others to be burned. The air cleaner not only cleans the air, it stops flame if the engine backfires. If it isn't there, and the engine backfires, you could be burned. Don't drive with it off, and be careful working on the engine with the air cleaner/filter off.

**NOTICE:**

**Gasoline Engines Only:** If the air cleaner/filter is off, a backfire can cause a damaging engine fire. And, dirt can easily get into your engine, which will damage it. Always have the air cleaner/filter in place when you're driving.

Your vehicle may also be equipped with an optional Filterminder gage. See "Warning Lights, Gages and Indicators" in the Index.

## Automatic Transmission Fluid

### When to Check

A good time to have it checked is when the engine oil is checked. See your Allison Automatic Transmission Operator's Manual to find out when to change your transmission fluid and filters.

### How to Check and What to Use

The Allison Automatic Transmission Operator's Manual that came with the vehicle shows how to check the automatic transmission fluid and what fluid to use.

**NOTICE:**

**Too much or too little fluid can damage your transmission. Too much can mean that some of the fluid could come out and fall on hot engine parts or exhaust system parts, starting a fire. Be sure to get an accurate reading if you check your transmission fluid.**



## Automatic Transmission External Filter

Your automatic transmission spin-on type filter requires periodic replacement. It is mounted just behind the radiator on the outside of the passenger's side frame rail.

Consult the Allison Automatic Transmission Operator's Manual that came with the vehicle for proper change intervals.

## Automatic Transmission External Filter With Service Trans Filter Indicator Light (Option)

This automatic transmission spin-on type filter is mounted to the left of the transmission. It requires replacement when the SERVICE TRANS FILTER indicator light on the instrument panel comes on or every three years, whichever occurs first.

## Manual Transmission Fluid

### When to Check

A good time to have it checked is when the engine oil is checked. See your Maintenance Schedule to find out when to change your transmission fluid and filters.

### How to Check and What to Use

The Eaton Fuller Transmission Operator's Manual that came with the vehicle shows how to check the manual transmission fluid and what fluid to use.

### **NOTICE:**

**Too much or too little fluid can damage your transmission. Too much can mean that some of the fluid could come out and fall on hot engine parts or exhaust system parts, starting a fire. Be sure to get an accurate reading if you check your transmission fluid.**

## Rear Axle

### When to Check and Change Lubricant

Refer to the Maintenance Schedule to determine how often to check the lubricant and when to change it. See “Scheduled Maintenance Services” in the Maintenance Schedule.

### How to Check Lubricant



If the level is below the bottom of the filler plug hole, you'll need to add some lubricant. Add enough lubricant to raise the level to the bottom of the filler plug hole.

### What to Use

Refer to the Maintenance Schedule to determine what kind of lubricant to use. See “Recommended Fluids and Lubricants” in the Maintenance Schedule.

### Rear Axle Shift Motor (Option)

#### When to Check and Change Fluid

If you have an optional air-shift two-speed, controlled traction, or locking differential type rear axle, a good time to check the fluid level in the axle shift motor is when the rear axle lubricant is checked. Use refrigerant oil (shift motor only).

#### How to Check Fluid

Remove the plug on the front plate of the axle shift motor, add enough fluid to raise the level to the bottom of the filler plug hole, then replace the plug.

#### What to Use

Refer to your Maintenance Schedule to determine what kind of lubricant to use.

## Radiator Pressure Cap (Gasoline Engines)



The radiator pressure cap must be tightly installed with the arrows on the cap lined up with the top of the overflow tube. This will prevent coolant loss and possible engine damage from overheating.

### NOTICE:

**Your radiator pressure cap is a 9 psi (62kPa) pressure-type cap for use with medium duty cooling systems only. It must be tightly installed to prevent coolant loss and possible engine damage from overheating. Be sure the arrows on the cap line up with the top of the overflow tube.**

When you replace your radiator pressure cap, an ACDelco<sup>®</sup> cap is recommended.

## Surge Tank Pressure Cap (Diesel Engines)



The surge tank pressure cap must be tightly installed with the arrows on the cap lined up with the top tube of the coolant surge tank.

When you replace your surge tank pressure cap, an ACDelco<sup>®</sup> cap is recommended.

### NOTICE:

**Your surge tank pressure cap is a 9 psi (62kPa) pressure-type cap for use with medium duty cooling systems only. It must be tightly installed to prevent coolant loss and possible engine damage from overheating. Be sure the arrows on the cap line up with the top tube of the coolant surge tank.**

## Thermostat

Engine coolant temperature is controlled by one or more thermostats in the engine cooling system. The thermostat stops the flow of coolant through the radiator until the coolant reaches a preset temperature.

When you replace your thermostat, an ACDelco<sup>®</sup> thermostat is recommended for gasoline engines. Caterpillar<sup>®</sup> parts are recommended for diesel engines.

## Engine Coolant (Gasoline Engine)

The cooling system in your vehicle is filled with DEX-COOL<sup>®</sup> engine coolant. This coolant is designed to remain in your vehicle for 5 years or 150,000 miles (240 000 km), whichever occurs first, if you add only DEX-COOL<sup>®</sup> extended life coolant.

The following explains your cooling system and how to add coolant when it is low. If you have a problem with engine overheating, see “Engine Overheating” in the Index.

A 50/50 mixture of clean, drinkable water and DEX-COOL<sup>®</sup> coolant will:

- Give freezing protection down to -34°F (-37°C).
- Give boiling protection up to 252°F (122°C).
- Protect against rust and corrosion.
- Help keep the proper engine temperature.
- Let the warning lights and gages work as they should.

### NOTICE:

**When adding coolant, it is important that you use only DEX-COOL<sup>®</sup> (silicate-free) coolant. If coolant other than DEX-COOL is added to the system, premature engine, heater core or radiator corrosion may result. In addition, the engine coolant will require change sooner -- at 30,000 miles (50 000 km) or 24 months, whichever occurs first. Damage caused by the use of coolant other than DEX-COOL<sup>®</sup> is not covered by your new vehicle warranty.**

## What to Use

Use a mixture of one-half *clean, drinkable water* and one-half DEX-COOL<sup>®</sup> coolant which won't damage aluminum parts. If you use this coolant mixture, you don't need to add anything else.

### CAUTION:

**Adding only plain water to your cooling system can be dangerous. Plain water, or some other liquid like alcohol, can boil before the proper coolant mixture will. Your vehicle's coolant warning system is set for the proper coolant mixture. With plain water or the wrong mixture, your engine could get too hot but you wouldn't get the overheat warning. Your engine could catch fire and you or others could be burned. Use a 50/50 mixture of clean, drinkable water and DEX-COOL<sup>®</sup> coolant.**

### NOTICE:

**If you use an improper coolant mixture, your engine could overheat and be badly damaged. The repair cost wouldn't be covered by your warranty. Too much water in the mixture can freeze and crack the engine, radiator, heater core and other parts.**

If you have to add coolant more than four times a year, have your dealer check your cooling system.

### NOTICE:

**If you use the proper coolant, you don't have to add extra inhibitors or additives which claim to improve the system. These can be harmful.**

## Checking Coolant



**Coolant Recovery Tank  
(Gasoline Engines -- Specialty Hood)**



**Coolant Recovery Tank  
(Gasoline Engines -- Sloped Hood)**



### Surge Tank (Caterpillar® Diesel Engines)

When your engine is cold, the coolant level should be at the COLD level, or a little higher, on the coolant recovery tank with the gasoline engine, or at the COLD FULL mark, visible through the surge tank, with the diesel engine.

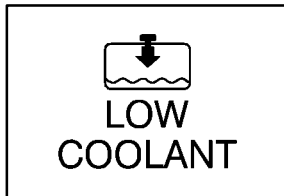

If this light comes on and stays on, it means you're low on engine coolant.

See "Lights, Low Coolant Warning Light" in the Index for further information.

### Adding Coolant

If you need more coolant, add the proper DEX-COOL® coolant mixture *at the coolant recovery tank or the surge tank.*



**⚠ CAUTION:**

Turning the radiator pressure cap (on a gasoline engine) or the surge tank cap (on a diesel engine) when the engine and radiator are hot can allow steam and scalding liquids to blow out and burn you badly. With the coolant recovery system, you will almost never have to add coolant at the radiator. Never turn the radiator pressure cap or the surge tank pressure cap -- even a little -- when the engine and radiator are hot.

Add coolant mixture at the recovery tank or the surge tank, but be careful not to spill it.

**⚠ CAUTION:**

You can be burned if you spill coolant on hot engine parts. Coolant contains ethylene glycol, and it will burn if the engine parts are hot enough. Don't spill coolant on a hot engine.

Some conditions, such as trapped air in the cooling system, can affect the coolant level in the radiator. If you need to add coolant to the radiator, follow the steps listed under "How to Add Coolant to the Radiator." See "Engine Overheating" in the Index.

## Engine Coolant (Caterpillar<sup>®</sup> Diesel Engine)

If your vehicle has a Caterpillar diesel engine, see the Caterpillar<sup>®</sup> Operation & Maintenance Manual provided with your vehicle to find out what to add, also when and how to service your cooling system.

## Power Steering Fluid

See your Maintenance Schedule for when to check your power steering fluid.

### How To Check Power Steering Fluid

Check your power steering fluid only when the engine is warm. If the engine isn't warm, you probably won't get an accurate reading.



Vehicles with diesel engines have a sight glass. If you can see fluid in the glass, you have enough.

Other models have a cap with a dipstick. If you have one, unscrew the cap and check the dipstick. It should be between ADD and FULL (if the engine is warm).

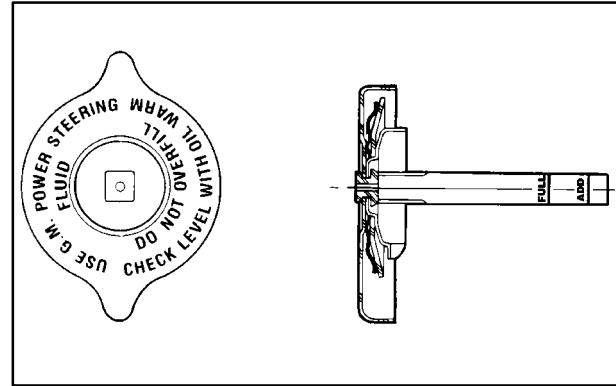

If you need to add some, put in only enough of the correct fluid to bring the level up to the FULL mark (if you have the dipstick) or so you can see fluid in the glass, if you have a sight glass.

## What to Use

To determine what kind of fluid to use, see “Recommended Fluids and Lubricants” in the Index.

### NOTICE:

**When adding power steering fluid or making a complete fluid change, always use the proper fluid. Failure to use the proper fluid can cause leaks and damage hoses and seals.**

**If your power steering fluid level is low, this can cause the PRIMARY BRAKE or AUX BRAKE warning lights to come on. If either light remains on after you have added power steering fluid to the proper level, then shut off the engine for 10 seconds. This should reset the brake warning lights. If one or both lights stay on, though, then see “Hydraulic Brake Warning Lights” in the Index.**

## Windshield Washer Fluid

### What to Use

When you need windshield washer fluid, be sure to read the manufacturer’s instructions before use. If you will be operating your vehicle in an area where the temperature may fall below freezing, use a fluid that has sufficient protection against freezing.

### Adding Washer Fluid



Open the cap labeled WASHER FLUID ONLY. Add washer fluid until the tank is full.

**NOTICE:**

- **When using concentrated washer fluid, follow the manufacturer's instructions for adding water.**
- **Don't mix water with ready-to-use washer fluid. Water can cause the solution to freeze and damage your washer fluid tank and other parts of the washer system. Also, water doesn't clean as well as washer fluid.**
- **Fill your washer fluid tank only three-quarters full when it's very cold. This allows for expansion if freezing occurs, which could damage the tank if it is completely full.**
- **Don't use engine coolant (antifreeze) in your windshield washer. It can damage your washer system and paint.**

## Brakes

### Brake Fluid



If your vehicle has hydraulic brakes, there's a brake master cylinder. The brake master cylinder reservoir is here. Refer to the Maintenance Schedule to determine when to check your brake fluid.

**⚠ CAUTION:**

**Don't add brake fluid before you check the level. If you do, you could get too much brake fluid. Brake fluid could spill on the hot engine and it can catch fire. You could be burned and your vehicle could be damaged.**

**Checking Brake Fluid**

Apply the brake pedal several times with the ignition off. Then clean one of the reservoir caps and the area around the cap, and remove it. The fluid level should be even with the bottom ring of the filler opening.



If it's low, add enough fluid to fill the reservoir to the proper level.

**What to Add**

Use the proper fluid listed in your Maintenance Schedule. Use new brake fluid from a sealed container only.

Always clean the brake fluid reservoir cap and the area around the cap before removing it. This will help keep dirt from entering the reservoir.

 **CAUTION:**

With the wrong kind of fluid in your brake system, your brakes may not work well, or they may not even work at all. This could cause a crash. Always use the proper brake fluid.

**NOTICE:**

- **Using the wrong fluid can badly damage brake system parts. For example, just a few drops of mineral-based oil, such as engine oil, in your brake system can damage brake system parts so badly that they'll have to be replaced. Don't let someone put in the wrong kind of fluid, and don't use DOT-5 silicone brake fluid.**

**NOTICE: (Continued)**

**NOTICE: (Continued)**

- **If you spill brake fluid on your vehicle's painted surfaces, the paint finish can be damaged. Be careful not to spill brake fluid on your vehicle. If you do, wash it off immediately. See "Appearance Care" in the Index.**

**Four-Wheel Disc Brakes (Hydraulic Only)**

Your vehicle has four-wheel disc brakes.

Some driving conditions or climates may cause a brake squeal when the brakes are first applied or lightly applied. This does not mean something is wrong with your brakes.

Brake linings should always be replaced as complete axle sets.

## Four-Wheel and Six-Wheel Drum Brakes (Air Only)

The brake drums should be removed and inspected each time the tires are removed for rotation or changing. When you have the front brakes replaced, have the rear brakes inspected, too.

Brake linings should always be replaced as complete axle sets.

### Brake Pedal Travel

See your dealer if the brake pedal does not return to normal height, or if there is a rapid increase in pedal travel. This could be a sign of brake trouble.

### Brake Adjustment

Every time you make a brake stop, your brakes adjust for wear.

### Air Brake Systems (If Equipped)

If you have air brakes, it is important to get rid of moisture in the system. Moisture will damage your system if it isn't removed daily.

There are two ways to do this. One is automatic if your air-brake vehicle has the optional moisture ejector. If your vehicle doesn't have that option, however, you must drain the air reservoirs every day.



Drain them at full system pressure. To be sure you're at full pressure, check your air pressure gage. It should read at least 100 psi (692 kPa).

### Moisture Ejector (Option)

If you have air brakes with a moisture ejector, the valve automatically ejects moisture from the reserve tank when the air compressor cycles.

## Air Dryer (Option)

If your vehicle has air brakes, it may have an air dryer. This collects and removes dirt, moisture or other foreign matter from the air prior to entering the brake system. It is mounted on the left frame rail.



If your dryer is a Bendix-Westinghouse, it has a filter that you need to change at intervals. See your Maintenance Schedule for more about servicing this filter.

## Alcohol Injector (Option)

If your vehicle has air brakes, it may have an alcohol injector. It is on the frame or crossmember at the right front corner of the vehicle.

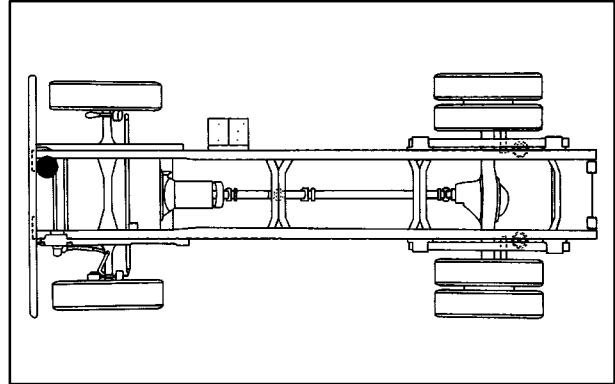

The alcohol injector helps prevent moisture in the air brake system from freezing. Use it only in cold weather, 32°F (0°C) or below.



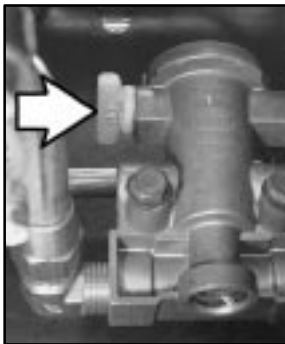

To turn it on in cold weather, turn the valve so that the word ON is on top. When the temperature is above freezing, turn the valve to OFF.

During the cold weather season, you may find that you need to check this bottle once a week.

## Replacing Brake System Parts

The braking system on a vehicle is complex. Its many parts have to be of top quality and work well together if the vehicle is to have really good braking. Your vehicle was designed and tested with top-quality GM brake parts. When you replace parts of your braking system -- for example, when your brake linings wear down and you have to have new ones put in -- be sure you get new approved GM replacement parts. If you don't, your brakes may no longer work properly. For example, if someone puts in brake linings that are wrong for your vehicle, the balance between your front and rear brakes can change -- for the worse. The braking performance you've come to expect can change in many other ways if someone puts in the wrong replacement brake parts.

## Electric/Hydraulic Parking Brake Fluid

If you have an electric/hydraulic parking brake, a good time to check the fluid level is when you check the fluid levels under the hood.



If you need to add fluid, use Dexron III automatic transmission fluid (GM Part Number 12345881).

## How to Check and Add Fluid

First, apply the parking brake. To check the fluid level, look at the MAX and MIN lines on the side of the reservoir. If the level is below the MAX line, add fluid. To add fluid, clean away any dirt around the reservoir cap. Remove the reservoir cap and add enough fluid to bring it up to the MAX level.

### **NOTICE:**

**Always use proper fluid (automatic transmission fluid), not brake fluid. Failure to use the proper fluid can cause leaks and damage hoses and seals.**

## Clutch Pedal Free Travel

If you have a manual transmission, your clutch will need adjustment when pedal free travel gets down to about 1 1/4 inch (32 mm), as measured at the clutch pedal pad. You should have 1 1/2 to 2 inches (38 to 51 mm) of clutch pedal free travel. Your Maintenance Schedule has more on this.

If your clutch ever needs service, be sure to use only genuine GM clutch replacement parts.

## Chassis Lubrication

Your Maintenance Schedule provides all of the required chassis lubrication intervals and identifies proper lubricants to use. Be sure to see your Maintenance Schedule before performing any chassis lubrication service. To determine location of chassis lubrication items, use the following charts.

### Single Axle Models

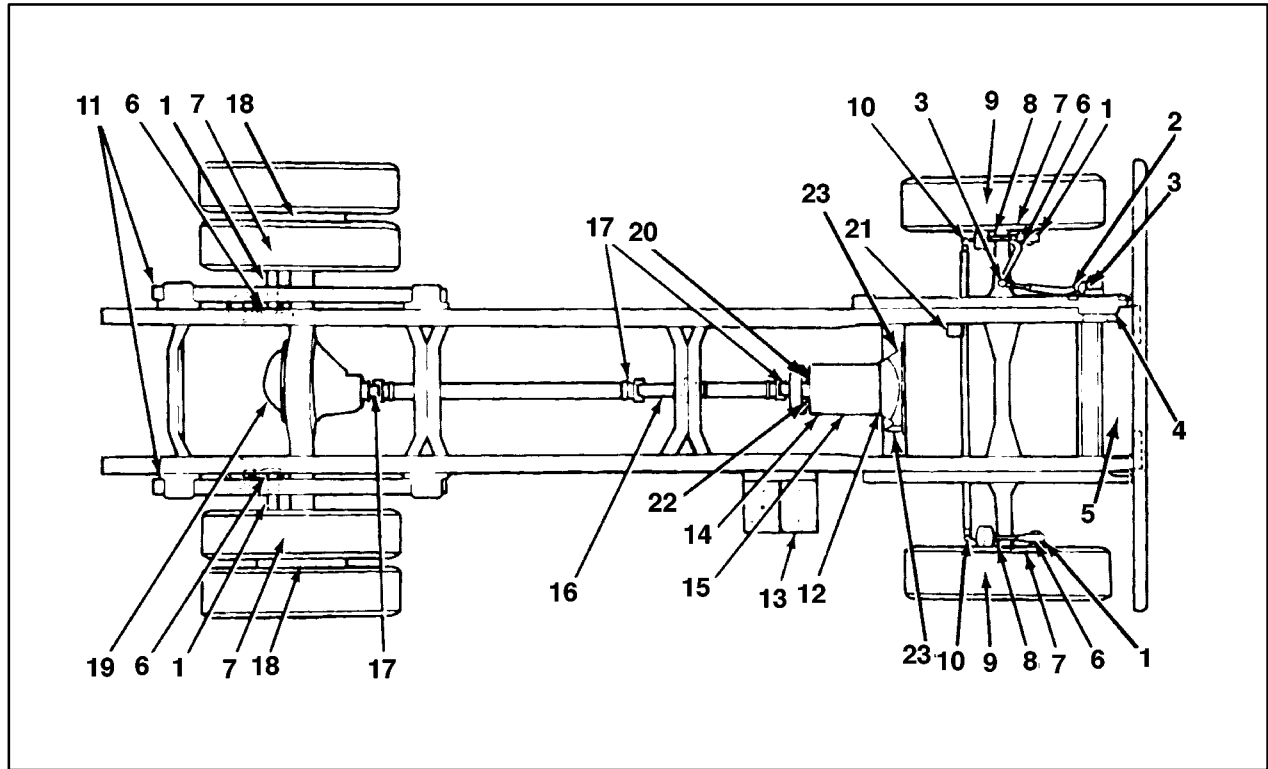

ITEM NO.	ITEM	REMARKS
1	Brake Camshaft ✓, Brake Caliper Rails (If Equipped)\$	One fitting each (apply sparingly). For caliper rails, apply Aero Shell #5 Lubricant.
2	Steering Column Slip Joint*	One fitting.
3	Steering Drag Link Ends	One fitting at each end.
4	Steering Column U-Joints	One fitting each joint.
5	Pivot Points and Hinges	Apply chassis lubricant.
6	Slack Adjuster ✓	One fitting.
7	Brake Cam Roller Pins at interface of pin and shoe ✓	Apply engine oil.
8	Front Steering Knuckles	One fitting each side, lower bushing (hand-operated grease gun only). Hand-pack upper bearing.
9	Front Wheel Bearings	Hand-pack or lubricate.
10	Steering Tie Rod Ends	One fitting each end.
11	Spring Slip Pads* (Multi-Leaf Only)	Apply chassis lubricant.
12	Clutch Release Bearing*	Cup or fitting.
13	Battery Terminal (except "ST" type)	Keep coated with petroleum jelly.
14	Parking Brake Bell Crank*\$	One fitting.

<b>ITEM NO.</b>	<b>ITEM</b>	<b>REMARKS</b>
15	Transmission	Fill to level of filler plug.
16	Transmission-Auto*†	Check fluid level.
17	Propshaft Slip Joint	One fitting each joint; lubricate with GM Part No. 1051344 Wheel Bearing Lubricant.
18	Propshaft U-Joints	One fitting each joint (1480 and 1550 Series); lubricate with GM Part No. 1051344 Wheel Bearing Lubricant. Two fittings each joint (1610 Series and larger); lubricate with GM Part No. 1051344 Wheel Bearing Lubricant.
19	Rear Wheel Bearing	Hand-pack or lubricate.
20	Rear Axle	Fill to level of filler plug.
21	Parking Brake Clevis Pin\$	Apply chassis lubricant.
22	Master Cylinder \$	Fill to 1/4" (6 mm) below opening.
23	Parking Brake Lever Pivot*\$	Apply chassis lubricant.

\* Applies to some vehicles.

✓ Applies to air brakes only.

† Refer to Allison Transmission Operator's Manual.

\$ Applies to hydraulic brakes only.

## Tandem Axle Models

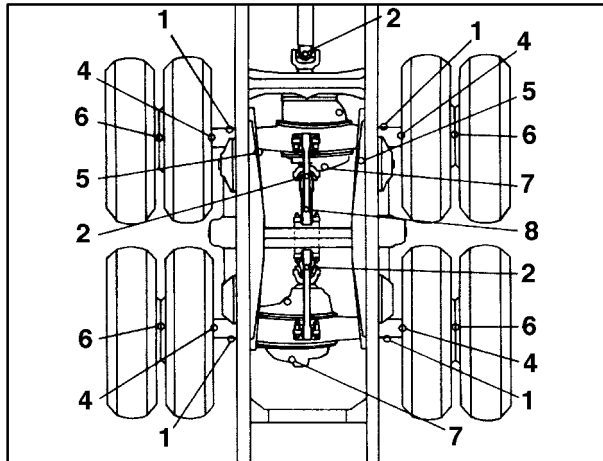

ITEM NO.	ITEM	REMARKS
1	Brake Camshafts	One fitting each.
2	Propshaft U-Joint	One fitting each joint (1480 and 1550 Series). Lubricate with GM Part No. 1051344, Wheel Bearing Lubricant.
4	Brake Shoe Roller Pins	Apply engine oil at pin to shoe joint only.
5	Rear Spring Pin	One fitting each side.
6	Wheel Bearings	Hand-pack or lubricate.
7	Rear Axles	Fill to level of filler plug.
8	Propshaft Slip Joint	Two fittings each side. Lubricate with GM Part No. 1051344 Wheel Bearing Lubricant.

## Battery

Your new vehicle comes with one or more ACDelco Freedom<sup>®</sup> maintenance free batteries. When it's time for a new battery, we recommend an ACDelco Freedom maintenance free battery. Be sure it has the replacement number shown on the original battery's label.

## Vehicle Storage

If you're not going to drive your vehicle for 25 days or more, remove the black, negative (-) cable from the battery. This will help keep your battery from running down. (If your vehicle has more than one battery, be sure to remove the negative (-) battery cable from each battery.)



### CAUTION:

**Batteries have acid that can burn you and gas that can explode. You can be badly hurt if you aren't careful. See "Jump Starting" in the Index for tips on working around a battery without getting hurt.**

When you are ready to use the vehicle again, refer to the engine starting procedure in the Index.

Contact your dealer to learn how to prepare your vehicle for longer storage periods.



## Windshield Wiper Blade Insert Replacement



Windshield wiper blades should be inspected at least twice a year for wear or cracking. See “Wiper Blade Check” in Section 7 of this manual under Part B “Owner Checks and Services” for more information.

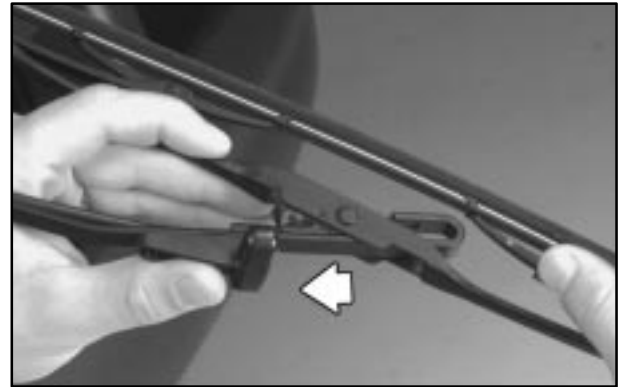

Replacement blades come in different types and are removed in different ways.

Here's how to remove the Sheppard's Hook type:

1. Pull the windshield wiper arm away from the windshield.
2. Push the release lever and slide the wiper assembly toward the driver's side of the vehicle.
3. Install a new blade by reversing Steps 1 and 2.

## Other Service Items

### Component Box

Your vehicle has a component box along the left frame rail.

What is in the box depends on what options are on your vehicle. Normally, the fuel filter, air dryer, Luberfiner oil filter, emission canister or other components are in there.



To get into the box, you first have to remove the top cover. To do that, remove the two 8 mm bolts on top and the single 8 mm bolt at the top front. Then, pull the cover toward you and lift it off.

You can then remove the front cover if you need to, by removing the two 8 mm bolts and pulling it off.

When you're through, be sure to put the front cover on, before you put on the top cover.

### Fuel Filter (Gasoline Engines)

The steel fuel filter is located inside the component box at the rear. See your Maintenance Schedule for recommended service intervals.

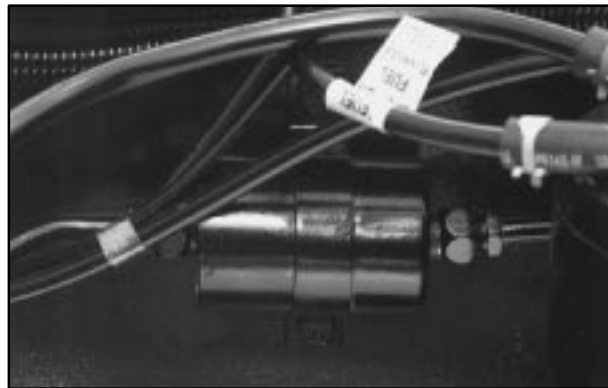

If your vehicle is equipped with the optional Davco spin-on type filter, it is also located in the component box.

## Fuel Filter (Diesel Engines)

The ACDelco® fuel filter is located in the component box. See your Maintenance Schedule for recommended service intervals.

## Primary Fuel Filter and Water Separator (Option)

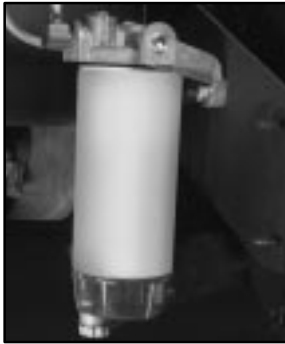

If you have a Caterpillar® diesel engine, you may have this spin-on filter. It is in the component box on the driver's side behind the fender.

It has a clear plastic drain bowl at the bottom. Check the drain bowl occasionally for any water or particles. To drain the bowl, shut off the engine. Then partially open the drain valve at the bottom of the filter. See "Engine Oil" in the Index for proper disposal procedures.

## Secondary Fuel Filter and Water Separator/Heater (Option)



If you have a Caterpillar® diesel engine, you may have this spin-on filter and fuel separator/heater. It is mounted on the passenger's side of the engine.

It has a metal drain bowl at the bottom. Occasionally, check the bowl for any water or particles. To check or drain the bowl, shut off the engine. Then push up on the spring loaded drain valve until clear fuel is flowing from the valve. The particles or water will drain out first. See "Engine Oil" in the Index for proper disposal procedures.

## Automatic Ether Injection System (Option)



If your diesel engine vehicle has this feature, the ether cylinder is on the upper right rear side of the engine compartment.

To change an empty ether cylinder, follow these steps.

1. Loosen the 5/16 inch screw head on the cylinder-to-bracket clamp.
2. Spread the clamp apart.
3. Clean any dirt from the neck of the cylinder and the top of the valve before you take out the cylinder.
4. Check the inside of the valve for any foreign matter. Clean the valve as necessary.
5. Cover the valve to protect it from dirt and take out the cylinder.
6. Install a new gasket whenever you take out the cylinder. Use only one gasket and spread a light film of clean oil on it before installation.
7. Put in the new cylinder. Turn it clockwise until it just starts to contact the gasket.
8. Tighten the cylinder another half turn (180 degrees). Don't over-tighten.
9. Retighten the cylinder clamp.

## Front Wheel Bearings with Oil-Filled Hubs



If your vehicle has oil-filled hubs, occasionally check to see if they have enough oil. You can tell by looking into the sight glass to see if there is oil there.

If there isn't, clean the rubber fill plug in the center of the glass, and then remove it. Be careful not to allow any dirt or water to get into the oil. Add enough of the recommended oil to bring it up to the level mark that you'll see on the glass.

Refer to your Maintenance Schedule for the proper oil to use.

When you fill the hub, check the glass again after driving a short distance. It takes a while for the oil to flow through the system, and you may find that you have to add a little more to fill it to the proper level.

## Air Conditioning System

Every now and then, have your dealership check your air conditioning system to be sure it has not lost any cooling ability. If you think the system is not working properly, have your GM Truck dealer check it out as soon as possible.

The air conditioning won't work when the temperature outside is below 40°F (4°C).

### **NOTICE:**

**If your vehicle is equipped with factory air conditioning, the system is charged with the R-134a refrigerant. Servicing of the air conditioning system should be performed by a trained service technician.**

## Muffler/Catalytic Converter Assemblies (Diesel Engines)

Some vehicles equipped with a Caterpillar® diesel engine utilize a catalytic converter-muffler assembly. If your vehicle is equipped with a catalytic converter-muffler, some special procedures may need to be followed when servicing your vehicle. Consult your GM Truck dealer who is an authorized Caterpillar® engine dealer for service.

To determine your vehicle's muffler type, examine the muffler outer housing. If your system is a catalytic converter-muffler type, the housing will be stamped with the CAT logo.

## Tires

Your new vehicle comes with high-quality tires made by a leading tire manufacturer. If you ever have questions about your tire warranty and where to obtain service, see your GM Warranty booklet for details.

### CAUTION:

**Poorly maintained and improperly used tires are dangerous.**

- **Overloading your tires can cause overheating as a result of too much friction. You could have an air-out and a serious accident. See “Loading Your Vehicle” in the Index.**
- **Underinflated tires pose the same danger as overloaded tires. The resulting accident could cause serious injury. Check all tires frequently to maintain the recommended pressure. Tire pressure should be checked when your tires are cold.**
- **Overinflated tires are more likely to be cut, punctured or broken by a sudden impact -- such as when you hit a pothole. Keep tires at the recommended pressure.**
- **Worn, old tires can cause accidents. If your tread is badly worn, or if your tires have been damaged, replace them.**

## Inflation -- Tire Pressure

The Certification/Tire label, which is on the driver's door, shows the correct inflation pressures for your tires when they're cold. "Cold" means your vehicle has been sitting for at least three hours or driven no more than 1 mile (1.6 km).

### NOTICE:

**Don't let anyone tell you that underinflation or overinflation is all right. It's not. If your tires don't have enough air (underinflation), you can get the following:**

- Too much flexing
- Too much heat
- Tire overloading
- Bad wear
- Bad handling
- Bad fuel economy.

**NOTICE: (Continued)**

### NOTICE: (Continued)

**If your tires have too much air (overinflation), you can get the following:**

- Unusual wear
- Bad handling
- Rough ride
- Needless damage from road hazards.

### When to Check

Check your tires once a month or more. Also, check the tire pressure of the spare tire.

### How to Check

Use a good quality pocket-type gage to check tire pressure. You can't tell if your tires are properly inflated simply by looking at them. Radial tires may look properly inflated even when they're underinflated.

Be sure to put the valve caps back on the valve stems. They help prevent leaks by keeping out dirt and moisture.

## Rims and Wheels

Rims and wheels are stamped with a maximum load and cold inflation rating. Be sure you don't exceed these limits.

## Dual Tire Operation

When the vehicle is new, or whenever a wheel, wheel bolt or wheel nut is replaced, check the wheel nut torque as indicated:

If your vehicle has stud piloted or hub piloted wheels, tighten the wheel stud nuts to the specified torque values at 100 miles (160 km), 500 miles (800 km) and 1,000 miles (1 600 km) and then every 1,000 miles (1 600 km) thereafter.

For proper torque, see “Wheel Nut Torque” in the Index.

The outer tire on a dual wheel setup generally wears faster than the inner tire. Your tires will wear more evenly and last longer if you rotate the tires periodically. If you're going to be doing a lot of driving on high-crown roads, you can reduce tire wear by adding 5 psi (35 kPa) to the tire pressure in the outer tires. Be sure to return to the recommended pressures when no longer driving under those conditions. See “Changing a Flat Tire” in the Index for more information.



### CAUTION:

**If you operate your vehicle with a tire that is badly underinflated, the tire can overheat. An overheated tire can lose air suddenly or catch fire. You or others could be injured. Be sure all tires (including the spare, if any) are properly inflated.**



## When It's Time for New Tires

Replace your tires when the tread depth is down to 1/8 of an inch (3.2 mm) for the front tires, or 1/16 of an inch (1.6 mm) for a rear tire. Also, you need a new tire if:

- You can see cord or fabric showing through the tire's rubber.
- The tread or sidewall is cracked, cut or snagged deep enough to show cord or fabric.
- The tire has a bump, bulge or split.
- The tire has a puncture, cut or other damage that can't be repaired well because of the size or location of the damage.



### CAUTION:

**Mixing tires could cause you to lose control while driving. If you mix tires of different types -- like radial and bias-belted tires -- the vehicle may not handle properly, and you could have a crash. Be sure to use the same type of tires all around.**

When you replace tires, make sure they are the same size, load range, speed rating and construction type (bias, bias-belted or radial) as your original tires.

## Wheel Alignment and Tire Balance

The wheels on your vehicle were aligned at the factory to give you the longest tire life and best overall performance.

Proper front wheel alignment must be maintained in order to ensure efficient steering, good directional stability, and prevent abnormal tire wear. If you notice unusual tire wear or your vehicle is pulling one way or the other, the alignment may need to be reset. If you notice your vehicle vibrating when driving on a smooth road, your wheels may need to be balanced.

## Tightening the Wheel Nuts

### CAUTION:

Wheel nuts that are not tight can work loose. If all the nuts on a wheel come off, the wheel can come off the vehicle, causing a serious crash. All wheel nuts must be properly tightened. Follow the rules in this section to be sure they are.

This section lets you know how often to check the tightness of the wheel nuts on your vehicle and how tight they must be.

First, use these pictures to decide what kind of wheels you have.

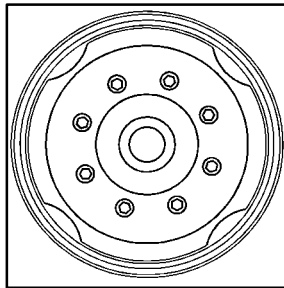

**Hub-Piloted Type,  
8-Hole**

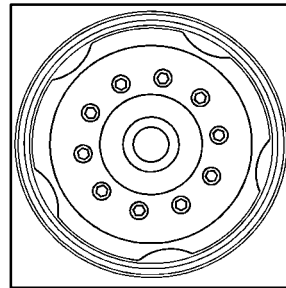

**Hub-Piloted Type,  
10-Hole**

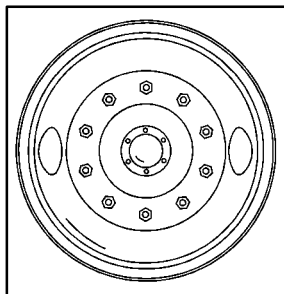

**Stud-Piloted Type, 10-Hole**

Then, follow the steps below for the wheels you have.

### Cast-Type Wheel

1. Put the tire and rim assembly on the axle hub.
2. Install the rim spacer at the rear.
3. Install the outer rear tire and rim assembly so that its valve stem is exactly opposite the valve stem on the inner tire and rim assembly.
4. Install the rim clamps and nuts. Position them properly.

#### NOTICE:

**If you tighten a nut when a rim clamp is not positioned properly, it can damage the rim and also cause the wheel to wobble in operation. Be sure to position the rim clamps properly before you go on to the next step.**

5. Finger-tighten the nuts. Be sure that all of the wheel clamps are seated all the way around the wheel.
6. Tighten all of the nuts using the following diagram. Be sure to use the one that matches your wheels.

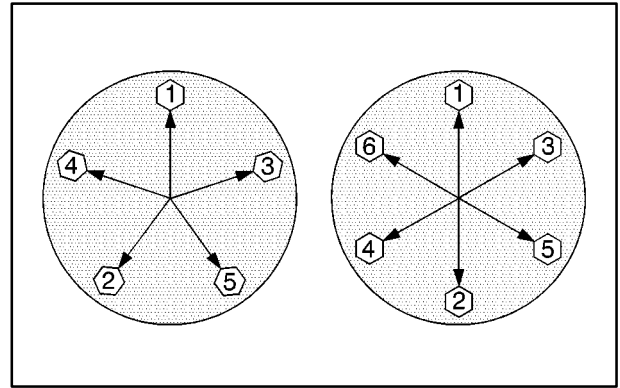

7. Now repeat Step 6, but this time tighten the nuts to 200 lb-ft (271 N·m) of torque.
8. Turn the wheel and measure along the sidewall to see how much wheel run-out there is. There should be no more than 1/8 inch (3 mm) on the front wheels and 3/16 inch (5 mm) on the rear wheels. If there is too much wheel run-out, you can try loosening the nuts on the side where there is the most run-out and tightening the opposite nuts. When you finally have the tire running true, tighten all of the nuts to 200 lb-ft (271 N·m).

## Stud-Piloted 10-Stud Wheel

The studs and nuts used on the right side of the vehicle have right-hand threads. Those used on the left side have left-hand threads. It is easy to tell by looking at the nuts, because they are stamped R or L.

1. Put the tire and rim assembly on the axle hub.
2. Put on the wheel nuts. If you use oil or grease on the wheel studs or nuts, the wheel nuts can't tighten properly. This could let the wheel come off as you are driving.
3. Finger-tighten the nuts on the rear inner wheels and the front wheels.
4. Tighten these nuts to 575 lb-ft (780 N·m), unless you have aluminum wheels and/or aluminum hubs. If you have aluminum wheels and/or aluminum hubs, tighten the nuts only to 475 lb-ft (644 N·m). Use the following diagram to do this.

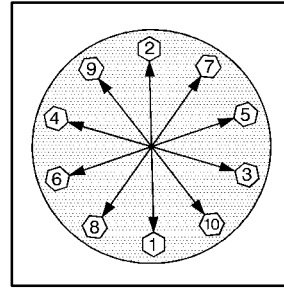

**Front or Inner Dual  
Wheel**

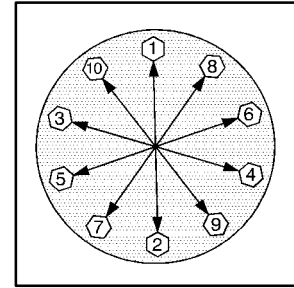

**Outer Dual Wheel**

5. Install the outer rear tire and rim assembly so that its valve stem is exactly opposite the valve stem on the inner tire and rim assembly.
6. Put on the wheel nuts.
7. Finger-tighten the wheel nuts.
8. Tighten the nuts to the same torque numbers shown in Step 4.

Whenever tightening both the inner and outer rear wheel nuts, first loosen the outer wheel nuts. Then tighten the inner nuts. Finally, tighten the outer nuts.

**⚠ CAUTION:**

**Never use oil or grease on studs or nuts. If you do, the nuts might come loose. Your wheel could fall off, causing a serious accident.**

**Hub-Piloted Wheels, 8-Hole or 10-Hole**

The studs and nuts used with these wheels have right-hand threads.

1. With intermittent pilot pads, position a pad at 12 o'clock to center the wheel and reduce run-out.
2. Put the tire and rim assembly on the axle hub. Install the outer rear tire and rim assembly so that its valve stem is exactly opposite the valve stem on the inner tire and rim assembly.
3. Put on the wheel nuts.
4. Finger-tighten the nuts.

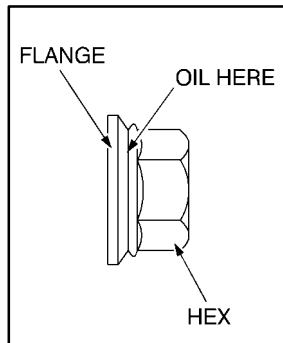

5. Oil the surfaces between the nuts and washers as shown. Do not oil the studs or the threads of the nut.

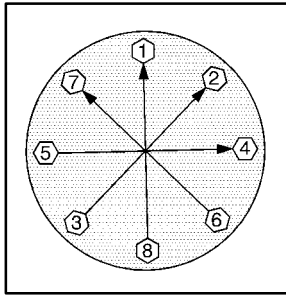

**8-Hole**

6. Tighten the nuts to 400 lb-ft (542 N·m) if an eight-hole stud or 480 lb-ft (650 N·m) if a 10-hole stud, use the following diagrams.

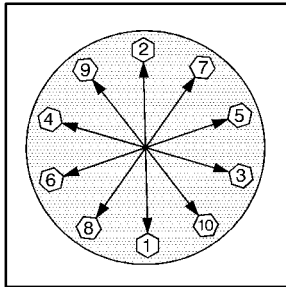

**10-Hole  
(Front or Inner Dual  
Wheel)**

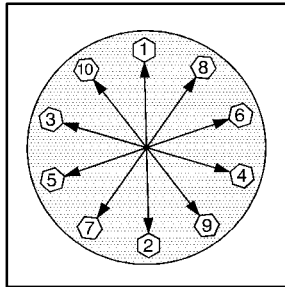

**10-Hole  
(Outer Dual Wheel)**

## **⚠ CAUTION:**

**If wheel studs are damaged, they can break. If all the studs on a wheel broke, the wheel could come off and cause a serious crash. If any stud is damaged because of a loose-running wheel, it could be that all of the studs are damaged. To be sure, replace all studs on the wheel. If the stud holes in a wheel have become larger, the wheel could collapse in operation. Replace any wheel if its stud holes have become larger or distorted in any way. Inspect hubs and hub piloted wheels for damage. Because of loose running wheels, piloting pad damage may occur and require replacement of the entire hub, for proper centering of the wheels.**

 **CAUTION:**

**Rust or dirt on a wheel, or on the parts to which it is fastened, can make the wheel nuts become loose after a time. The wheel could come off and cause an accident. When you change a wheel, remove any rust or dirt from the places where the wheel attaches to the vehicle. In an emergency, you can use a cloth or paper towel to do this; but be sure to use a scraper or wire brush later, if you need to, to get all the rust or dirt off.**

### How Often to Check

Wheel tightness is so important you should have a technician check nut tightness on all wheels with a torque wrench every 1,000 miles (1 600 km).

When your vehicle is new or when a wheel or fastener is new you should have a technician tighten the wheel stud and rim clamp nuts, with a torque wrench, at 100, 500 and 1,000 miles (160, 800 and 1 600 km). The reason for this is that the clamping system has to seat before the fasteners will stay tightened.

## Wheel Replacement

Replace any wheel that is bent, cracked or badly rusted. If wheel nuts keep coming loose, replace the wheel. If the wheel leaks air, replace it.

Your dealer will know the kind of wheel you need.

 **CAUTION:**

**A leaking wheel could fail without warning. A wheel designed for tubeless tires could be leaking because it is damaged. Don't use an inner tube or some other thing to try to stop the leaking. Get a new wheel of the proper type.**

 **CAUTION:**

Without the correct wheel, you may not be able to stop properly, and you could have other problems like a tire air-out. You could have a collision. If you don't go to your dealer to get a new wheel, be sure you get the correct one. Each new wheel should match the original wheel in load-carrying capacity, inflation pressure capacity, diameter, width, offset and mounting configuration.

Using wheels and tires with higher load-carrying limits than the original wheels and tires doesn't change the GAWR or the GVWR of your vehicle.

**NOTICE:**

The wrong wheel can cause trouble in bearing life, brake cooling, speedometer/odometer calibration, headlamp aim, bumper height, vehicle ground clearance, stopping distance and tire clearance to the body and chassis. You could also have other problems like a tire air-out.

**Used Replacement Wheels** **CAUTION:**

Putting a used wheel on your vehicle is dangerous. You can't know how it's been used or how many miles it's been driven. It could fail suddenly and cause an accident. If you have to replace a wheel, use a new GM original equipment wheel.



## Appearance Care

Remember, cleaning products can be hazardous. Some are toxic. Others can burst into flame if you strike a match or get them on a hot part of the vehicle. Some are dangerous if you breathe their fumes in a closed space. When you use anything from a container to clean your vehicle, be sure to follow the manufacturer's warnings and instructions. And always open your doors or windows when you're cleaning the inside.

*Never* use these to clean your vehicle:

- Gasoline
- Benzene
- Naphtha
- Carbon Tetrachloride
- Acetone
- Paint Thinner
- Turpentine
- Lacquer Thinner
- Nail Polish Remover

They can all be hazardous -- some more than others -- and they can all damage your vehicle, too.

Don't use any of these unless this manual says you can. In many uses, these will damage your vehicle:

- Alcohol
- Laundry Soap
- Bleach
- Reducing Agents

## Cleaning the Inside of Your Vehicle

Use a vacuum cleaner often to get rid of dust and loose dirt. Wipe vinyl, leather, plastic and painted surfaces with a clean, damp cloth.

### Cleaning of Fabric/Carpet

Your dealer has two cleaners, Multi-Purpose Interior Cleaner and Capture Non-Solvent Dry Spot and Soil Remover for cleaning fabric and carpet. They will clean normal spots and stains very well. You can get GM-approved cleaning products from your dealer. (See "Appearance Care and Materials" in the Index.)

Here are some cleaning tips:

- Always read the instructions on the cleaner label.
- Clean up stains as soon as you can -- before they set.
- Carefully scrape off any excess stain.

- Use a clean cloth or sponge, and change to a clean area often. A soft brush may be used if stains are stubborn.
- If a ring forms on fabric after spot cleaning, clean the entire area immediately or it will set.

## Using Multi-Purpose Interior Cleaner on Fabric

1. Vacuum and brush the area to remove any loose dirt.
2. Always clean a whole trim panel or section. Mask surrounding trim along stitch or welt lines.
3. Mix powdered cleaner following the directions on the container label to form thick suds.
4. Use suds only and apply with a clean sponge. Don't saturate the material and don't rub it roughly.
5. As soon as you've cleaned the section, use a sponge to remove the suds.
6. Wipe cleaned area with a clean, damp towel or cloth.
7. Wipe with a clean cloth and let dry.

## Special Fabric Cleaning Problems

Stains caused by such things as catsup, coffee (black), egg, fruit, fruit juice, milk, soft drinks, vomit, urine and blood can be removed as follows:

1. Carefully scrape off excess stain, then sponge the soiled area with cool water.
2. If a stain remains, follow the multi-purpose interior cleaner instructions described earlier.
3. If an odor lingers after cleaning vomit or urine, treat the area with a water/baking soda solution: 1 teaspoon (5 ml) of baking soda to 1 cup (250 ml) of lukewarm water.
4. Let dry.

Stains caused by candy, ice cream, mayonnaise, chili sauce and unknown stains can be removed as follows:

1. Carefully scrape off excess stain.
2. First, clean with cool water and allow to dry completely.
3. If a stain remains, follow instructions for Multi-Purpose Interior Cleaner.

## Fabric Protection

Your vehicle has upholstery that has been treated with Scotchgard™ Fabric Protector, a 3M product. It protects fabrics by repelling oil and water, which are the carriers of most stains. Even with this protection, you still need to clean your upholstery often to keep it looking new.

Further information on cleaning is available by calling 1-800-433-3296 (in Minnesota, 1-800-642-6167).

## Cleaning Vinyl

Use warm water and a clean cloth.

- Rub with a clean, damp cloth to remove dirt. You may have to do it more than once.
- Things like tar, asphalt and shoe polish will stain if you don't get them off quickly. Use a clean cloth and a vinyl/leather cleaner. See your dealer for this product.

## Cleaning the Top of the Instrument Panel

Use only mild soap and water to clean the top surfaces of the instrument panel. Sprays containing silicones or waxes may cause annoying reflections in the windshield and even make it difficult to see through the windshield under certain conditions.

## Cleaning Interior Plastic Components

Use only a mild soap and water solution on a soft cloth or sponge. Commercial cleaners may affect the surface finish.

## Care of Safety Belts

Keep belts clean and dry.

### CAUTION:

**Do not bleach or dye safety belts. If you do, it may severely weaken them. In a crash, they might not be able to provide adequate protection. Clean safety belts only with mild soap and lukewarm water.**

## Cleaning Glass Surfaces

Glass should be cleaned often. GM Glass Cleaner or a liquid household glass cleaner will remove normal tobacco smoke and dust films on interior glass. (See “Appearance Care and Materials” in the Index.)

Don’t use abrasive cleaners on glass, because they may cause scratches. Avoid placing decals on the inside rear window, since they may have to be scraped off later.

## Cleaning the Outside of the Windshield and Wiper Blades

If the windshield is not clear after using the windshield washer, or if the wiper blade chatters when running, wax, sap or other material may be on the blade or windshield.

Clean the outside of the windshield with GM Windshield Cleaner, Bon Ami<sup>®</sup> Powder (non-scratching glass cleaning powder), GM Part No. 1050011. The windshield is clean if beads do not form when you rinse it with water.

Grime from the windshield will stick to the wiper blades and affect their performance. Clean the blade by wiping vigorously with a cloth soaked in full-strength windshield washer solvent. Then rinse the blade with water.

Check the wiper blades and clean them as necessary; replace blades that look worn.

## Weatherstrips

Silicone grease on weatherstrips will make them last longer, seal better, and not stick or squeak. Apply silicone grease with a clean cloth at least every six months. During very cold, damp weather more frequent application may be required. (See “Recommended Fluids and Lubricants” in the Index.)

## Cleaning the Outside of Your Vehicle

The paint finish on your vehicle provides beauty, depth of color, gloss retention and durability.

### Washing Your Vehicle

The best way to preserve your vehicle's finish is to keep it clean by washing it often with lukewarm or cold water.

Don't wash your vehicle in the direct rays of the sun. Use a car washing soap. Don't use strong soaps or chemical detergents. Be sure to rinse the vehicle well, removing all soap residue completely. You can get GM-approved cleaning products from your dealer. (See "Appearance Care and Materials" in the Index.) Don't use cleaning agents that are petroleum based, or that contain acid or abrasives. All cleaning agents should be flushed promptly and not allowed to dry on the surface, or they could stain. Dry the finish with a soft, clean chamois or an all-cotton towel to avoid surface scratches and water spotting.

High pressure vehicle washes may cause water to enter your vehicle.

### Cleaning Exterior Lamps/Lenses

Use lukewarm or cold water, a soft cloth and a vehicle washing soap to clean exterior lamps and lenses. Follow instructions under "Washing Your Vehicle."

### Finish Care

Occasional waxing or mild polishing of your vehicle by hand may be necessary to remove residue from the paint finish. You can get GM-approved cleaning products from your dealer. (See "Appearance Care and Materials" in the Index.)

Your vehicle may have a "basecoat/clearcoat" paint finish. The clearcoat gives more depth and gloss to the colored basecoat. Always use waxes and polishes that are non-abrasive and made for a basecoat/clearcoat paint finish.

#### **NOTICE:**

**Machine compounding or aggressive polishing on a basecoat/clearcoat paint finish may dull the finish or leave swirl marks.**

Foreign materials such as calcium chloride and other salts, ice melting agents, road oil and tar, tree sap, bird droppings, chemicals from industrial chimneys, etc., can damage your vehicle's finish if they remain on painted surfaces. Wash the vehicle as soon as possible. If necessary, use non-abrasive cleaners that are marked safe for painted surfaces to remove foreign matter.

Exterior painted surfaces are subject to aging, weather and chemical fallout that can take their toll over a period of years. You can help to keep the paint finish looking new by keeping your vehicle garaged or covered whenever possible.

### Protecting Exterior Bright Metal Parts

Bright metal parts should be cleaned regularly to keep their luster. Washing with water is all that is usually needed. However, you may use chrome polish on chrome or stainless steel trim, if necessary.

Use special care with aluminum trim. To avoid damaging protective trim, never use auto or chrome polish, steam or caustic soap to clean aluminum. A coating of wax, rubbed to high polish, is recommended for all bright metal parts.

### Cleaning Tires

To clean your tires, use a stiff brush with a tire cleaner.

#### **NOTICE:**

**When applying a tire dressing always take care to wipe off any overspray or splash from all painted surfaces on the body or wheels of the vehicle. Petroleum-based products may damage the paint finish and tires.**

### Sheet Metal Damage

If your vehicle is damaged and requires sheet metal repair or replacement, make sure the body repair shop applies anti-corrosion material to the parts repaired or replaced to restore corrosion protection.

## Finish Damage

Any stone chips, fractures or deep scratches in the finish should be repaired right away. Bare metal will corrode quickly and may develop into a major repair expense.

Minor chips and scratches can be repaired with touch-up materials available from your dealer or other service outlets. Larger areas of finish damage can be corrected in your dealer's body and paint shop.

## Underbody Maintenance

Chemicals used for ice and snow removal and dust control can collect on the underbody. If these are not removed, accelerated corrosion (rust) can occur on the underbody parts such as fuel lines, frame, floor pan and exhaust system even though they have corrosion protection.

At least every spring, flush these materials from the underbody with plain water. Clean any areas where mud and other debris can collect. Dirt packed in closed areas of the frame should be loosened before being flushed. Your dealer or an underbody vehicle washing system can do this for you.

## Chemical Paint Spotting

Some weather and atmospheric conditions can create a chemical fallout. Airborne pollutants can fall upon and attack painted surfaces on your vehicle. This damage can take two forms: blotchy, ringlet-shaped discolorations, and small irregular dark spots etched into the paint surface.

Although no defect in the paint job causes this, GM will repair, at no charge to the owner, the surfaces of new vehicles damaged by this fallout condition within 12 months or 12,000 miles (20 000 km) of purchase, whichever occurs first.

This applies only to materials manufactured and sold by General Motors. Bodies, body conversions or equipment not made or sold by General Motors are not covered.

## GM Vehicle Care/Appearance Materials

PART NUMBER	SIZE	DESCRIPTION	USAGE
994954	23 in. x 25 in.	Polishing Cloth – Wax Treated	Exterior polishing cloth
1050172	16 oz. (0.473 L)	Tar and Road Oil Remover	Removes tar, road oil and asphalt
1050173	16 oz. (0.473 L)	Chrome Cleaner and Polish	Use on chrome, stainless steel, nickel, copper and brass
1050174	16 oz. (0.473 L)	White Sidewall Tire Cleaner	Removes soil and black marks from whitewalls
1050214	32 oz. (0.946 L)	Vinyl Cleaner	Cleans vinyl tops, upholstery and convertible tops
1050427	23 oz. (0.680 L)	Glass Cleaner	Removes dirt, grime, smoke and fingerprints
1052918**	8 oz. (0.237 L)	Armor All™ Protectant	Protects leather, wood, acrylics, Plexiglas™, plastic, rubber and vinyl
1052925	16 oz. (0.473 L)	Multi-Purpose Interior Cleaner	Cleans carpets, seats, interior trim, door panels and floor mats
1052929	16 oz. (0.473 L)	Wheel Cleaner	Spray on and rinse with water
1052930	8 oz. (0.237 L)	Capture Dry Spot Remover	Attracts, absorbs and removes soils on fabric
12345721	2.5 sq. ft.	Synthetic Chamois	Shines vehicle without scratching
12345725	12 oz. (0.354 L)	Silicone Tire Shine	Spray on tire shine
12377964*	16 oz. (0.473 L)	Finish Enhancer	Removes dust, fingerprints and surface contaminants
12377966*	16 oz. (0.473 L)	Cleaner Wax	Removes light scratches and oxidation and protects finish
12377984*	16 oz. (0.473 L)	Surface Cleaner	Removes contaminants, blemishes and swirl marks
See your General Motors Parts Department for these products. See “Recommended Fluids and Lubricants” in the Index.		* For exterior use only. ** Not recommended for use on instrument panels.	



## Vehicle Identification Number (VIN)

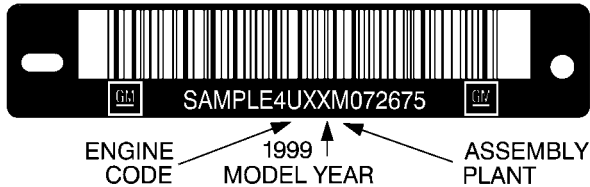

This is the legal identifier for your vehicle. It appears on a plate in the front corner of the instrument panel, on the driver's side. You can see it if you look through the windshield from outside your vehicle. The VIN also appears on the Vehicle Certification and Service Parts labels and the certificates of title and registration.

### Engine Identification

The 8th character in your VIN is the engine code. This code will help you identify your engine, specifications and replacement parts.

### Service Statement

One of these statements is on your Certification/Tire label. Here is what each one means.

**TRUCK SERVICE** -- A vehicle made to carry property or special equipment. It is made for uniform frame loading. That includes using the vehicle to pull a full trailer.

**TRUCK-TRACTOR** -- A vehicle made to draw other vehicles. It's made to carry part of the load of the trailer. It is made for point frame loading, usually for a semi-trailer ("fifth wheel").

**MAX. VERT. CG** -- The highest allowable vertical center of gravity, at the highest allowable GVWR. It's measured from level ground in inches.

**TRUCK-CANADA** -- A vehicle first sold in Canada with a non-school bus application, or cab models with regular production option RQ2 ("truck service").

**TRACTOR-CANADA** -- A cab model with regular production option RQ3 ("truck-tractor service").

## Service Parts Identification Label

You'll find this label in a location determined by the body manufacturer. It's very helpful if you ever need to order parts. On this label is:

- your VIN,
- the model designation,
- paint information and
- a list of all production options and special equipment.

Be sure that this label is not removed from the vehicle.

## Electrical System

### Add-On Electrical Equipment

#### **NOTICE:**

**Don't add anything electrical to your vehicle unless you check with your dealer first. Some electrical equipment can damage your vehicle and the damage wouldn't be covered by your warranty. Some add-on electrical equipment can keep other components from working as they should.**

### Headlamp Wiring

The headlamp wiring is protected by a circuit breaker in the light switch. An electrical overload will cause the lights to go on and off, or in some cases to remain off. If this happens, have your headlamp wiring checked right away.

### Windshield Wiper Fuses

The windshield wiper motor is protected by a circuit breaker inside the motor and a circuit breaker in the fuse block. If the motor overheats, the wipers will stop until the motor cools. If the overload is caused by an electrical problem, be sure to get it fixed.

### Fusible Links

A fusible link is a short piece of wire several gage sizes smaller than the circuit it protects. It will melt in an overload situation, opening the circuit.

Your starter relay and other circuits have these fusible links. The size is printed on the insulation. If the insulation is burned beyond recognition, consult your GM dealer for the proper size. Replace a fusible link with one of the same size and insulation type. Fusible link insulation is a special purpose high-temperature material.

The hydraulic brake booster motor feed circuit and starter relay circuit are protected by a fusible link. Vehicles with a diesel engine have a fusible link for the intake heater feed circuit. Vehicles equipped with an electronically controlled diesel engine also have a fusible link for the engine control unit.

## Power Windows and Other Power Options

Circuit breakers in the fuse panel protect the power windows and other power accessories. When the current load is too heavy, the circuit breaker opens and closes. This protects the circuit until the current load returns to normal or the problem is fixed.

## Fuses and Circuit Breakers

The wiring circuits in your vehicle are protected from short circuits by a combination of fuses, circuit breakers, maxi-fuses and fusible links. This greatly reduces the chance of a fire caused by an electrical problem. There may be a fuse taped to the wiring harness inside the battery box and one near the generator also taped to the wiring harness.

There are two circuit breaker/fuse blocks in your vehicle: the instrument panel circuit breaker block and the maxi-fuse block.

### Instrument Panel Circuit Breaker Block

This fuse block is in the lower portion of the instrument panel, to the left of the steering column.



To open the door, pull up and outward on the recessed door handle and the door will snap out.

To install the door, place the lower door into the bottom retainer and push the top of the door in until it snaps into place.

If you ever have a problem on the road and don't have a spare circuit breaker, you can borrow one of the correct value. Just pick some feature of your vehicle that you can get along without -- like the radio or cigarette lighter -- and use its circuit breaker if it is of the value you need. Remember to replace the circuit breaker as soon as you can.

These circuit breakers are non-cycling; do not replace them with cycling circuit breakers. Also, don't use circuit breakers of higher amperage than those indicated on the circuit breaker block.

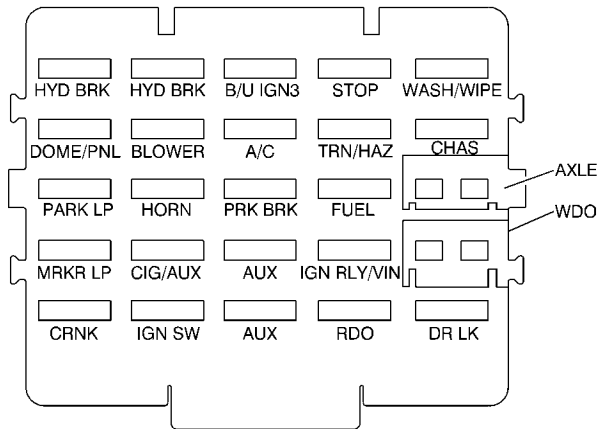

Name	Circuits Protected
HYD BRK	Brake Pump Motor Relay
HYD BRK	Brake Alarm Module

Name	Circuits Protected
B/U IGN3	Fuel Filter Relay, Blower Motor Relays, ABS Power Relay, Back-Up Lamps, Auxiliary Wiring Relay, IGN 3 Relay, Power Window Relay, Vehicle Interface Module, Transmission Temperature Gage
STOP	Stoplamps
WASH/WIPE	Windshield Wipers/Washer, Accessory Relay
DOME/PNL	Dome Lamp, Radio Receiver, Instrument Panel Lights, A/C Controller, Headlamp/Seatbelt Module
BLOWER	Blower Motor
A/C	A/C Clutch Compressor, A/C Controller
TRN/HAZ	Turn Signals, Hazard Flashers

<b>Name</b>	<b>Circuits Protected</b>	<b>Name</b>	<b>Circuits Protected</b>
CHAS	Exhaust Brake, Air Suspension Dump Valve, Air Dryer, HYD ABS ECHU	CIG/AUX	Cigarette Lighter, Auxiliary Power Jacks
PARK LP	Auxiliary Wiring, Air Conditioner Controls, Parking Lamps, Turn Signals, Taillamps, Stoplamps, Marker Lamps, Trailer Running Lamps, Lighted Mirrors, Radio Receiver, Mirror Clearance Lamps	AUX	Auxiliary Wiring Relay
HORN	Horn/Diagnostic Connector	IGN RLY/VIN	Vehicle Interface Module (Diesel Engines) or Generator, Coil, Injectors (Gasoline Engines)
PRK BRK	Parking Brake Module	WDO	Power Windows
FUEL	Heated Fuel Filter (Diesel Engines) or Fuel Pump (Gasoline Engines)	CRNK	Starter Relay
AXLE	Heated Mirrors, Radiator Shutters, Two-Speed Axle Motor, Two-Speed Axle Switch	IGN SW	Instrument Panel Cluster Telltales
MRKR LP	Roof Marker Lamps, Trailer Marker Lamps, Marker Lamp Relay	AUX	Auxiliary Wiring
		RDO	Radio, Auxiliary Wiring
		DR LK	Power Door Locks

## Maxi-Fuse Block

When a circuit goes out, first check the instrument panel circuit breaker block. If no circuit breakers are out there, the problem could be in the maxi-fuse block.

This block uses blade-type fuses. It's on the upper passenger side of the engine compartment at the rear.



To access the maxi-fuse block, gently squeeze both sides of the cover to unlatch the tabs at the top. Then, unsnap both attachments at the bottom and remove the cover.

Power is fed through these fuses to devices such as the headlamp switch, ignition switch feed circuits and the auxiliary brake pump (hydraulic brake vehicles).

Be sure to replace maxi-fuses with maxi-fuses of the same rating. Do not use maxi-fuses of higher amperage than those indicated on the maxi-fuse block.

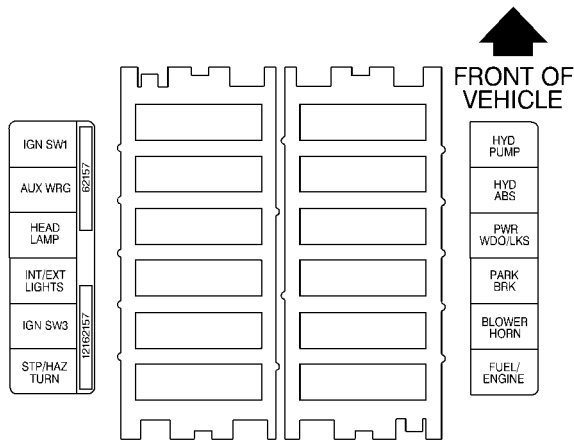

Name	Circuits/Circuit Breakers Protected
STP/HAZ TURN	Stop Lamp, Turn Signal/Hazard Lights, Fuel, Ignition Relay (Gasoline Engines)
IGN SW3	Air Conditioner, Ignition Switch, Axle, Chassis

Name	Circuits/Circuit Breakers Protected
INT/EXT LIGHTS	Parking Lamps, Dome/Panel Lights
HEAD LAMP	Headlamps, Daytime Running Lamps
AUX WRG	Auxiliary, Park Brake
IGN SW1	Ignition Switch, Wash/Wipe, Crank, Radio
HYD PUMP	Hydraulic Brake, Brake Pump Motor
HYD ABS	EHCU
PWR WDO/LCKS	Window, Door Locks
PARK BRK	Parking Brake Motor
BLOWER HORN	Blower, Horn, Cigarette Lighter/Auxiliary
FUEL/ENGINE	Empty

## Replacement Bulbs

It is recommended that you use an AC<sup>®</sup> type bulb whenever you need to replace one.

Before you replace any bulbs, be sure that all lamps are off and the engine isn't running.

## Capacities and Specifications

Replacement part numbers listed in this section are based on the latest information available at the time of printing. They are subject to later change. If a part listed here isn't the same as the part in your vehicle when it was built, or if you have any questions, please contact your GM Truck dealer.

### Engine Identification and Data

Engine RPO	LG5	LP4/L21
Engine Type	7.2L L6	7.4L V8
Fuel System	HEUI	SPFI
Firing Order	1-5-3-6-2-4	1-8-4-3-6-5-7-2

### Wheel Nut Torque

Refer to "Tightening the Wheel Nuts" in this section for wheel nut torque information.

## Cooling System Capacity

Model	Quarts (Liters)
7.2L .....	32.0 (30.0)
with automatic transmission .....	30.0 (28.4)
7.4L .....	25.0 (23.7)
with automatic transmission .....	23.0 (22.7)

Above capacities (volumes) are approximate.

## Crankcase Capacity

Capacities (volumes) shown are for normal refill. Add oil as indicated when the oil filter element is changed. Capacities given are approximate -- keep level within the operating range. Do not operate with fluid level below the ADD line.

Engine	Capacity-- Quarts (Liters)
7.2L	21 (19.0)*
7.4L	8 (7.5)

\*Additional oil is required with auxiliary oil filter systems. Make sure to add enough extra oil to fill the auxiliary oil filter system. For vehicles equipped with the LUBERFINER 750-C, add 14 quarts (13.25 L).



Extending the recommended oil change interval requires the use of an infrared oil analysis program which shows the condition of the oil and its additives. For more information, consult your GM Truck dealer, who is an authorized Caterpillar® engine dealer.

## Transmission Capacity

Capacities (volumes) shown are approximate. For manual transmissions, the correct oil level is to the bottom of the fluid fill plug opening. The oil capacity will vary, due to the angle of the transmission, with the vehicle. For automatic transmissions, see the Allison Automatic Transmission Operator's Manual for oil check and maintenance information.

<b>Manual Transmission</b>	<b>Pints (Liters)</b>
RT6609 .....	12.0 (5.7)
RT6610 .....	12.0 (5.8)
RTO6610 .....	12.0 (5.8)

RT6613 .....	16.0 (7.5)
RT7608LL .....	19.5 (9.3)
RT8609 .....	15.0 (7.0)
FS4205A, FS4205B, FS4205C .....	12.5 (5.9)
5205A, FS5205C .....	12.5 (5.9)
FS5306 .....	18.0 (8.5)
FS6305A, FS6305B .....	19.0 (9.0)
FS6306 .....	19.5 (9.2)
FS7206 .....	20.0 (9.5)
T8607B .....	36.0 (17.0)

<b>Automatic Transmission</b>	<b>Pints (Liters)</b>
AT542 (for oil pan filter change) .....	30.0 (14.0)*
AT545 (for oil pan filter change) .....	40.0 (19.0)*
MT643 (for oil pan filter change) .....	13.0 (24.5)*
MT653 (for oil pan filter change) .....	36.0 (17.0)*

\*Add two pints (one liter) when changing spin-on filter.

## Rear Axle Lubricant Capacity

Single Speed Axle	Lubricant, Pints (Liters)
15040S	21.0 (10.1)
19060S	28.0 (12.8)
21060D	28.0 (14.7)
21060S	28.0 (14.7)
22060S	28.0 (14.7)
22080S	40.0 (20.3)
23080S	40.0 (20.3)
23431	40.0 (20.3)
23105S	48.0 (22.7)
26085P	41.0 (19.5)
26105S	48.0 (22.7)
30105S	46.0 (23.2)
Two-Speed Axle	Lubricant, Pints (Liters)
15040T	24.0 (11.5)
19060T	35.0 (17.5)
21060T	35.0 (17.5)
22060T	35.0 (17.5)
23080T	39.0 (19.9)
26080T	41.0 (19.5)

Above capacities (volumes) are approximate.

Tandem Axles	Lubricant, Pints (Liters)
DS344 (front)	29.0 (15.1)
RS344 (rear)	28.0 (13.2)
DS454 (front)	29.0 (15.1)
RS454 (rear)	28.0 (13.2)
DS404, DS404P (front)	29.0 (15.1)
RS404 (rear)	34.0 (16.1)
DT402P (front)	34.0 (16.1)
RT402 (rear)	34.0 (16.1)

Above capacities (volumes) are approximate.

## Fuel Tank Capacity

Model	Gallons (Liters)
Standard	50 (189.0)
Optional	35 (132.5)
Optional	60 (227.1)
Optional*	70 (264.0)
Optional**	100 (378.0)

\* Two 35-gallon (132 L) tanks

\*\*Two 50-gallon (189 L) tanks

Above capacities (volumes) are approximate.

## Air Conditioning Refrigerants

Not all air conditioning refrigerants are the same. If the air conditioning system in your vehicle needs refrigerant, be sure the proper refrigerant is used. If you're not sure, ask your dealer.

## Air Conditioning Refrigerant Capacity

Refrigerant R-134a . . . . . 2.5 lbs. (1.134 kg)

This capacity (volume) is approximate.

## Normal Maintenance Replacement Parts

### Allison Transmission External Filters

Engine	GM (AC) Part Number
7.2L . . . . .	25011122 (PF897)
7.4L . . . . .	25011122 (PF897)

### Air Compressor Filter

Air Compressor	GM Part Number
Bendix Tu-Flo 550 (13.2 CFM)	2467368

## Service Replacement Part and Filter Recommendations

Engine	7.2L	7.4L
RPO	LG5	LP4/L21
Spark Plug	—	AC Type R41-932
—Gap	—	0.060 inch (1.52 mm)
—Torque	—	22.0 lb. ft. (30.0 Nm)
Oil Filter	CAT <sup>®</sup> 2P4004	AC Type PF-932
PCV Valve	—	AC Type CV-774C
Air Cleaner*	Donaldson P522606	Donaldson P533355
Fuel Filter	AC-TP-915 Pri- mary**	AC Type GF-481
Pressure Caps	RC-54	—

\*Optional Davco (K28) D350921 spin-on type filter located in component box.

\*\*Optional Cold Weather (KUK) Racor B6484GM spin-on type located in component box. Optional Davco heated fuel water separator mounted on the side of the diesel engine.



# NOTES

---

---

---

---

---

---

---

---

---

---

---

---

---

---

---

---

---

---

---

---

---

---

---

---

---

## Section 7 Scheduled Maintenance Services

---

This section covers the maintenance required for your vehicle. Your vehicle needs these services to retain its safety, dependability and emission control performance.

7-2	Introduction	7-23	Part B: Owner Checks and Services
7-4	Part A: Scheduled Maintenance Services	7-28	Part C: Recommended Fluids and Lubricants
7-5	Scheduled Maintenance	7-31	Part D: Maintenance Record

**IMPORTANT:  
KEEP ENGINE OIL  
AT THE PROPER  
LEVEL AND CHANGE AS  
RECOMMENDED**



*Have you purchased the GM Protection Plan? The Plan supplements your new vehicle warranties. See your Warranty and Owner Assistance booklet, or your GM dealer for details.*

## **Introduction**

### **Your Vehicle and the Environment**

Proper vehicle maintenance not only helps to keep your vehicle in good working condition, but also helps the environment. All recommended maintenance procedures are important. Improper vehicle maintenance can even affect the quality of the air we breathe. Improper fluid levels or the wrong tire inflation can increase the level of emissions from your vehicle. To help protect our environment, and to keep your vehicle in good condition, please maintain your vehicle properly.

## How This Section is Organized

This maintenance schedule is divided into five parts:

“**Part A: Scheduled Maintenance Services**” shows what to have done and how often. Some of these services can be complex, so unless you are technically qualified and have the necessary equipment, you should let your dealer’s service department or another qualified service center do these jobs.

### CAUTION:

**Performing maintenance work on a vehicle can be dangerous. In trying to do some jobs, you can be seriously injured. Do your own maintenance work only if you have the required know-how and the proper tools and equipment for the job. If you have any doubt, have a qualified technician do the work.**

If you are skilled enough to do some work on your vehicle, you will probably want to get the service information. See “Service and Owner Publications” in the Index.

“**Part B: Owner Checks and Services**” tells you what should be checked and when. It also explains what you can easily do to help keep your vehicle in good condition.

“**Part C: Recommended Fluids and Lubricants**” lists some recommended products to help keep your vehicle properly maintained. These products, or their equivalents, should be used whether you do the work yourself or have it done.

“**Part D: Maintenance Record**” provides a place for you to record the maintenance performed on your vehicle. Whenever any maintenance is performed, be sure to write it down in this part. This will help you determine when your next maintenance should be done. In addition, it is a good idea to keep your maintenance receipts. They may be needed to qualify your vehicle for warranty repairs.

## Part A: Scheduled Maintenance Services

### Using Your Maintenance Schedule

We at General Motors want to help you keep your vehicle in good working condition. But we don't know exactly how you'll drive it. You may drive very short distances only a few times a week. Or you may drive long distances all the time in very hot, dusty weather. You may use your vehicle in making deliveries or in many other ways.

Because of all the different ways people use their vehicles, maintenance needs vary. You may need more frequent checks and replacements. So please read the following and note how you drive. If you have any questions on how to keep your vehicle in good condition, see your GM dealer.

This part tells you the maintenance services you should have done and when you should schedule them. If you go to your dealer for your service needs, you'll know that GM-trained and supported service people will perform the work using genuine GM parts.

The proper fluids and lubricants to use are listed in Part C. Make sure whoever services your vehicle uses these. All parts should be replaced and all necessary repairs done before you or anyone else drives the vehicle.

This schedule is for vehicles that:

- carry passengers and cargo within recommended limits. You will find these limits on your vehicle's Certification/Tire label. See "Loading Your Vehicle" in the Index.
- are driven on reasonable road surfaces within legal driving limits.
- use the recommended fuel. See "Fuel" in the Index.

### Scheduled Maintenance Supplements

If your vehicle has a Caterpillar<sup>®</sup> diesel engine, your GM Owner's Manual is supplemented by the Caterpillar<sup>®</sup> Diesel Engine Operation & Maintenance Manual. If your vehicle has an Allison transmission, your GM Owner's Manual is supplemented by an Allison Transmission Operator's Manual. Always refer to these manuals for related maintenance services.



## Scheduled Maintenance

The services shown in this schedule up to 100,000 miles (166 000 km) should be performed after 100,000 miles (166 000 km) at the same intervals. The services shown after 100,000 miles (166 000 km) should be performed at those same intervals.

This vehicle has a computer that lets you know when to change your engine oil. This is not based on mileage, but on engine revolutions and engine operating temperature. When the computer has calculated that the oil needs changing, the Oil Life Indicator will indicate that a change is necessary.

See “Footnotes” at the end of this Maintenance Schedule for further explanation of maintenance services and Caterpillar<sup>®</sup> diesel application.

### 100 Miles (160 km)

- Wheel stud nut service. (45)

### 500 Miles (800 km)

- Wheel stud nut service. (45)

### 1,000 Miles (1 600 km)

- Wheel stud nut service. (45)(46)

### 3,000 Miles (5 000 km)

- Engine oil and filter service. (3)(9)
- Check fluid levels (or every 3 months, whichever occurs first). (1)(2)(6)
- Clutch pedal free travel service. (10)
- Rear axle air shift motor service. (11)

### 6,000 Miles (10 000 km)

- Engine oil and filter service. (3)(9)
- Check fluid levels (or every 3 months, whichever occurs first). (1)(2)(6)
- Chassis lubrication service (or every 6 months, whichever occurs first). (12)
- Lubricate door hinge pins and rollers with engine oil.
- Wheels and tires service. (15)
- Hydraulic brake service (or every 6 months, whichever occurs first). (7)
- Hydraulic parking brake service (or every 6 months, whichever occurs first). (8)
- Clutch pedal free travel service. (10)

### 9,000 Miles (15 000 km)

- Engine oil and filter service. (3)(9)
- Check fluid levels (or every 3 months, whichever occurs first). (1)(2)(6)

## 12,000 Miles (20 000 km)

- Engine oil and filter service. (3)(9)
- Check fluid levels (or every 3 months, whichever occurs first). (1)(2)(6)
- Chassis lubrication service (or every 6 months, whichever occurs first). (12)
- Lubricate door hinge pins and rollers with engine oil.
- Wheels and tires service. (15)
- Hydraulic brake service (or every 6 months, whichever occurs first). (7)
- Hydraulic parking brake service (or every 6 months, whichever occurs first). (8)
- Engine drive belts service (or every 12 months, whichever occurs first). (18)
- Clutch pedal free travel service. (10)
- Throttle linkage service. (19)
- Thermostatically controlled engine cooling fan service. (4)(20)
- Shields and underhood insulation service. (4)(5)(21)
- Check air brake relay valve operation and check for leaks (or every month, or every 300 hours, whichever occurs first).

## 15,000 Miles (25 000 km)

- Engine oil and filter service. (3)(9)
- Check fluid levels (or every 3 months, whichever occurs first). (1)(2)(6)
- Steering system service. (13)
- Front and rear suspension service. (14)
- Spring-to-axle U-bolts and shackle bolts service. (16)
- Exhaust system service (or every 6 months, whichever occurs first). (3)(4)(17)
- Air brake service (or every 6 months, whichever occurs first). (39)

## 18,000 Miles (30 000 km)

- Engine oil and filter service. (3)(9)
- Check fluid levels (or every 3 months, whichever occurs first). (1)(2)(6)
- Chassis lubrication service (or every 6 months, whichever occurs first). (12)
- Inspect door hinge pins and bushings and replace as necessary. Lubricate door hinge pins and rollers with engine oil.

- Replace air conditioning filter dryer (or every 18 months, whichever occurs first, and whenever refrigerant charge is lost for any reason).
- Wheels and tires service. (15)
- Hydraulic brake service (or every 6 months, whichever occurs first). (7)
- Hydraulic brake caliper service (or every 6 months, whichever occurs first). (22)
- Hydraulic parking brake service (or every 6 months, whichever occurs first). (8)
- Clutch pedal free travel service. (10)
- Clean air brake application valve (or every 3 months, or every 300 hours, whichever occurs first); lubricate linkage.

### **21,000 Miles (35 000 km)**

- Engine oil and filter service. (3)(9)
- Check fluid levels (or every 3 months, whichever occurs first). (1)(2)(6)

### **24,000 Miles (40 000 km)**

- Engine oil and filter service. (3)(9)
- Check fluid levels (or every 3 months, whichever occurs first). (1)(2)(6)

- Chassis lubrication service (or every 6 months, whichever occurs first). (12)
- Lubricate door hinge pins and rollers with engine oil.
- Wheel bearing (grease type) service (or every 24 months, whichever occurs first, and whenever hubs are removed). (23)
- Wheels and tires service. (15)
- Hydraulic brake service (or every 6 months, whichever occurs first). (7)
- Hydraulic parking brake service (or every 6 months, whichever occurs first). (8)
- Engine drive belts service (or every 12 months, whichever occurs first). (18)
- Clutch pedal free travel service. (10)
- Throttle linkage service. (19)
- Thermostatically controlled engine cooling fan service. (4)(20)
- Shields and underhood insulation service. (4)(5)(21)
- Air intake system service (or every 24 months, whichever occurs first). (4)(5)(24)
- Thermostatically controlled air cleaner service (or every 24 months, whichever occurs first). (3)(4)(25)†

(Continued)

## 24,000 Miles (40 000 km) (Continued)

- Evaporative Control System service (if equipped) (or every 24 months, whichever occurs first). (3)(26)†
- Rear axle air shift motor service. (11)
- Check air brake relay valve operation and check for leaks (or every month, or every 300 hours, whichever occurs first).
- Air brake chamber service (or every 2 months, whichever occurs first). (41)
- Trailer brake hand control valve service (or every 3 months, or 900 hours, whichever occurs first). (42)

## 27,000 Miles (45 000 km)

- Engine oil and filter service. (3)(9)
- Check fluid levels (or every 3 months, whichever occurs first). (1)(2)(6)

## 30,000 Miles (50 000 km)

- Engine oil and filter service. (3)(9)
- Check fluid levels (or every 3 months, whichever occurs first). (1)(2)(6)
- Chassis lubrication service (or every 6 months, whichever occurs first). (12)
- Replace fuel filter(s) (or every 12 months, whichever occurs first). (3)

- Air cleaner filter replacement service (or every 24 months, whichever occurs first). (3)(4)(27)
- Steering system service. (13)
- Front and rear suspension service. (14)
- Spring-to-axle U-bolts and shackle bolts service. (16)
- Exhaust system service (or every 6 months, whichever occurs first). (3)(4)(17)
- Air brake service (or every 6 months, whichever occurs first). (39)
- Lubricate door hinge pins and rollers with engine oil.
- Wheels and tires service. (15)
- Hydraulic brake service (or every 6 months, whichever occurs first). (7)
- Hydraulic parking brake service (or every 6 months, whichever occurs first). (8)
- Clutch pedal free travel service. (10)
- Air brake automatic slack adjuster service (or every 500 hours, whichever occurs first). (40)

## 33,000 Miles (55 000 km)

- Engine oil and filter service. (3)(9)
- Check fluid levels (or every 3 months, whichever occurs first). (1)(2)(6)

### **36,000 Miles (60 000 km)**

- Engine oil and filter service. (3)(9)
- Check fluid levels (or every 3 months, whichever occurs first). (1)(2)(6)
- Chassis lubrication service (or every 6 months, whichever occurs first). (12)
- Inspect door hinge pins and bushings and replace as necessary. Lubricate door hinge pins and rollers with engine oil.
- Replace air conditioning filter dryer (or every 18 months, whichever occurs first, and whenever refrigerant charge is lost for any reason).
- Wheels and tires service. (15)
- Hydraulic brake service (or every 6 months, whichever occurs first). (7)
- Hydraulic brake caliper service (or every 6 months, whichever occurs first). (22)
- Hydraulic parking brake service (or every 6 months, whichever occurs first). (8)
- Engine drive belts service (or every 12 months, whichever occurs first). (18)
- Clutch pedal free travel service. (10)
- Throttle linkage service. (19)
- Thermostatically controlled engine cooling fan service. (4)(20)

- Shields and underhood insulation service. (4)(5)(21)
- Check air brake relay valve operation and check for leaks (or every month, or every 300 hours, whichever occurs first).
- Clean air brake application valve (or every 3 months, or every 300 hours, whichever occurs first); lubricate linkage.

### **39,000 Miles (65 000 km)**

- Engine oil and filter service. (3)(9)
- Check fluid levels (or every 3 months, whichever occurs first). (1)(2)(6)

### **42,000 Miles (70 000 km)**

- Engine oil and filter service. (3)(9)
- Check fluid levels (or every 3 months, whichever occurs first). (1)(2)(6)
- Chassis lubrication service (or every 6 months, whichever occurs first). (12)
- Lubricate door hinge pins and rollers with engine oil.
- Wheels and tires service. (15)
- Hydraulic brake service (or every 6 months, whichever occurs first). (7)
- Hydraulic parking brake service (or every 6 months, whichever occurs first). (8)
- Clutch pedal free travel service. (10)

## 45,000 Miles (75 000 km)

- Engine oil and filter service. (3)(9)
- Check fluid levels (or every 3 months, whichever occurs first). (1)(2)(6)
- Steering system service. (13)
- Front and rear suspension service. (14)
- Spring-to-axle U-bolts and shackle bolts service. (16)
- Exhaust system service (or every 6 months, whichever occurs first). (3)(4)(17)
- Air brake service (or every 6 months, whichever occurs first). (39)

## 48,000 Miles (80 000 km)

- Engine oil and filter service. (3)(9)
- Check fluid levels (or every 3 months, whichever occurs first). (1)(2)(6)
- Chassis lubrication service (or every 6 months, whichever occurs first). (12)
- Lubricate door hinge pins and rollers with engine oil.
- Wheel bearing (grease type) service (or every 24 months, whichever occurs first, and whenever hubs are removed). (23)
- Wheels and tires service. (15)
- Hydraulic brake service (or every 6 months, whichever occurs first). (7)

- Hydraulic parking brake service (or every 6 months, whichever occurs first). (8)
- Engine drive belts service (or every 12 months, whichever occurs first). (18)
- Clutch pedal free travel service. (10)
- Throttle linkage service. (19)
- Thermostatically controlled engine cooling fan service. (4)(20)
- Shields and underhood insulation service. (4)(5)(21)
- Air intake system service (or every 24 months, whichever occurs first). (4)(5)(24)
- Thermostatically controlled air cleaner service (or every 24 months, whichever occurs first). (3)(4)(25)†
- Evaporative Control System service (if equipped) (or every 24 months, whichever occurs first). (3)(26)†
- Rear axle air shift motor service. (11)
- Check air brake relay valve operation and check for leaks (or every month, or every 300 hours, whichever occurs first).
- Air brake chamber service (or every 2 months, whichever occurs first). (41)
- Trailer brake hand control valve service (or every 3 months, or 900 hours, whichever occurs first). (42)

### 51,000 Miles (85 000 km)

- Engine oil and filter service. (3)(9)
- Check fluid levels (or every 3 months, whichever occurs first). (1)(2)(6)

### 54,000 Miles (90 000 km)

- Engine oil and filter service. (3)(9)
- Check fluid levels (or every 3 months, whichever occurs first). (1)(2)(6)
- Chassis lubrication service (or every 6 months, whichever occurs first). (12)
- Inspect door hinge pins and bushings and replace if necessary. Lubricate door hinge pins and rollers with engine oil.
- Replace air conditioning filter dryer (or every 18 months, whichever occurs first, and whenever refrigerant charge is lost for any reason).
- Wheels and tires service. (15)
- Hydraulic brake service (or every 6 months, whichever occurs first). (7)
- Hydraulic brake caliper service (or every 6 months, whichever occurs first). (22)
- Hydraulic parking brake service (or every 6 months, whichever occurs first). (8)
- Clutch pedal free travel service. (10)

- Spark plug service. (3)(28)
- Clean air brake application valve (or every 3 months, or every 300 hours, whichever occurs first); lubricate linkage.

### 57,000 Miles (95 000 km)

- Engine oil and filter service. (3)(9)
- Check fluid levels (or every 3 months, whichever occurs first). (1)(2)(6)

### 60,000 Miles (100 000 km)

- Engine oil and filter service. (3)(9)
- Check fluid levels (or every 3 months, whichever occurs first). (1)(2)(6)
- Chassis lubrication service (or every 6 months, whichever occurs first). (12)
- Replace fuel filter(s) (or every 12 months, whichever occurs first). (3)
- Air cleaner filter replacement service (or every 24 months, whichever occurs first). (3)(4)(27)
- Steering system service. (13)
- Front and rear suspension service. (14)
- Spring-to-axle U-bolts and shackle bolts service. (16)

*(Continued)*

## 60,000 Miles (100 000 km) (Continued)

- Exhaust system service (or every 6 months, whichever occurs first). (3)(4)(17)
- Air brake service (or every 6 months, whichever occurs first). (39)
- Lubricate door hinge pins and rollers with engine oil.
- Wheels and tires service. (15)
- Hydraulic brake service (or every 6 months, whichever occurs first). (7)
- Hydraulic parking brake service (or every 6 months, whichever occurs first). (8)
- Engine drive belts service (or every 12 months, whichever occurs first). (18)
- Clutch pedal free travel service. (10)
- Throttle linkage service. (19)
- Thermostatically controlled engine cooling fan service. (4)(20)
- Shields and underhood insulation service. (4)(5)(21)
- Positive Crankcase Ventilation (PCV) system service (or every 60 months, whichever occurs first). (3)(33)
- Check air brake relay valve operation and check for leaks (or every month, or every 300 hours, whichever occurs first).
- Air brake automatic slack adjuster service (or every 500 hours, whichever occurs first). (40)

## 63,000 Miles (105 000 km)

- Engine oil and filter service. (3)(9)
- Check fluid levels (or every 3 months, whichever occurs first). (1)(2)(6)

## 66,000 Miles (110 000 km)

- Engine oil and filter service. (3)(9)
- Check fluid levels (or every 3 months, whichever occurs first). (1)(2)(6)
- Chassis lubrication service (or every 6 months, whichever occurs first). (12)
- Lubricate door hinge pins and rollers with engine oil.
- Wheels and tires service. (15)
- Hydraulic brake service (or every 6 months, whichever occurs first). (7)
- Hydraulic parking brake service (or every 6 months, whichever occurs first). (8)
- Clutch pedal free travel service. (10)

## 69,000 Miles (115 000 km)

- Engine oil and filter service. (3)(9)
- Check fluid levels (or every 3 months, whichever occurs first). (1)(2)(6)



## 72,000 Miles (120 000 km)

- Engine oil and filter service. (3)(9)
- Check fluid levels (or every 3 months, whichever occurs first). (1)(2)(6)
- Chassis lubrication service (or every 6 months, whichever occurs first). (12)
- Inspect door hinge pins and bushings and replace as necessary. Lubricate door hinge pins and rollers with engine oil.
- Replace air conditioning filter dryer (or every 18 months, whichever occurs first, and whenever refrigerant charge is lost for any reason).
- Wheel bearing (grease type) service (or every 24 months, whichever occurs first, and whenever hubs are removed). (23)
- Wheels and tires service. (15)
- Hydraulic brake service (or every 6 months, whichever occurs first). (7)
- Hydraulic brake caliper service (or every 6 months, whichever occurs first). (22)
- Hydraulic parking brake service (or every 6 months, whichever occurs first). (8)
- Engine drive belts service (or every 12 months, whichever occurs first). (18)
- Clutch pedal free travel service. (10)
- Throttle linkage service. (19)
- Thermostatically controlled engine cooling fan service. (4)(20)
- Shields and underhood insulation service. (4)(5)(21)
- Air intake system service (or every 24 months, whichever occurs first). (4)(5)(24)
- Thermostatically controlled air cleaner service (or every 24 months, whichever occurs first). (3)(4)(25)
- Fuel tank, fuel cap and fuel lines service (or every 72 months, whichever occurs first). (3)(30) †
- EGR system inspection (or every 72 months, whichever occurs first). (3)(31)
- Electronic Vacuum Regulator Valve (EVRV) inspection (or every 72 months, whichever occurs first). (3)(32)
- Evaporative Control System Service (if equipped) (or every 24 months, whichever occurs first). (3)(26) †
- Rear axle air shift motor service. (11)
- Check air brake relay valve operation and check for leaks (or every month, or every 300 hours, whichever occurs first).

*(Continued)*

## 72,000 Miles (120 000 km) (Continued)

- Clean air brake application valve (or every 3 months, or every 300 hours, whichever occurs first); lubricate linkage.
- Air brake chamber service (or every 2 months, whichever occurs first). (41)
- Trailer brake hand control valve service (or every 3 months, or 900 hours, whichever occurs first). (42)

## 75,000 Miles (125 000 km)

- Engine oil and filter service. (3)(9)
- Check fluid levels (or every 3 months, whichever occurs first). (1)(2)(6)
- Steering system service. (13)
- Front and rear suspension service. (14)
- Spring-to-axle U-bolts and shackle bolts service. (16)
- Exhaust system service (or every 6 months, whichever occurs first). (3)(4)(17)
- Air brake service (or every 6 months, whichever occurs first). (39)

## 78,000 Miles (130 000 km)

- Engine oil and filter service. (3)(9)
- Check fluid levels (or every 3 months, whichever occurs first). (1)(2)(6)

- Chassis lubrication service (or every 6 months, whichever occurs first). (12)
- Lubricate door hinge pins and rollers with engine oil.
- Wheels and tires service. (15)
- Hydraulic brake service (or every 6 months, whichever occurs first). (7)
- Hydraulic parking brake service (or every 6 months, whichever occurs first). (8)
- Clutch pedal free travel service. (10)

## 81,000 Miles (135 000 km)

- Engine oil and filter service. (3)(9)
- Check fluid levels (or every 3 months, whichever occurs first). (1)(2)(6)
- Wheel bearings service -- Eaton Axle (oil-filled) (or every 24 months, whichever occurs first). (1)(23)

## 84,000 Miles (140 000 km)

- Engine oil and filter service. (3)(9)
- Check fluid levels (or every 3 months, whichever occurs first). (1)(2)(6)
- Chassis lubrication service (or every 6 months, whichever occurs first). (12)
- Lubricate door hinge pins and rollers with engine oil.
- Wheels and tires service. (15)

- Hydraulic brake service (or every 6 months, whichever occurs first). (7)
- Hydraulic parking brake service (or every 6 months, whichever occurs first). (8)
- Engine drive belts service (or every 12 months, whichever occurs first). (18)
- Clutch pedal free travel service. (10)
- Throttle linkage service. (19)
- Thermostatically controlled engine cooling fan service. (4)(20)
- Shields and underhood insulation service. (4)(5)(21)
- Check air brake relay valve operation and check for leaks (or every month, or every 300 hours, whichever occurs first).

### **87,000 Miles (145 000 km)**

- Engine oil and filter service. (3)(9)
- Check fluid levels (or every 3 months, whichever occurs first). (1)(2)(6)

### **90,000 Miles (150 000 km)**

- Engine oil and filter service. (3)(9)
- Check fluid levels (or every 3 months, whichever occurs first). (1)(2)(6)
- Chassis lubrication service (or every 6 months, whichever occurs first). (12)

- Replace fuel filter(s) (or every 12 months, whichever occurs first). (3)
- Air cleaner filter replacement service (or every 24 months, whichever occurs first). (3)(4)(27)
- Steering system service. (13)
- Front and rear suspension service. (14)
- Spring-to-axle U-bolts and shackle bolts service. (16)
- Exhaust system service (or every 6 months, whichever occurs first). (3)(4)(17)
- Air brake service (or every 6 months, whichever occurs first). (39)
- Inspect door hinge pins and bushings and replace as necessary. Lubricate door hinge pins and rollers with engine oil.
- Replace air conditioning filter dryer (or every 18 months, whichever occurs first, and whenever refrigerant charge is lost for any reason).
- Wheels and tires service. (15)
- Hydraulic brake service (or every 6 months, whichever occurs first). (7)
- Hydraulic brake caliper service (or every 6 months, whichever occurs first). (22)
- Hydraulic parking brake service (or every 6 months, whichever occurs first). (8)

*(Continued)*

## 90,000 Miles (150 000 km) (Continued)

- Clutch pedal free travel service. (10)
- Air brake automatic slack adjuster service (or every 500 hours, whichever occurs first). (40)
- Clean air brake application valve (or every 3 months, or every 300 hours, whichever occurs first); lubricate linkage.

## 93,000 Miles (155 000 km)

- Engine oil and filter service. (3)(9)
- Check fluid levels (or every 3 months, whichever occurs first). (1)(2)(6)

## 96,000 Miles (160 000 km)

- Engine oil and filter service. (3)(9)
- Check fluid levels (or every 3 months, whichever occurs first). (1)(2)(6)
- Chassis lubrication service (or every 6 months, whichever occurs first). (12)
- Lubricate door hinge pins and rollers with engine oil.
- Wheel bearing (grease type) service (or every 24 months, whichever occurs first, and whenever hubs are removed). (23)
- Wheels and tires service. (15)
- Hydraulic brake service (or every 6 months, whichever occurs first). (7)

- Hydraulic parking brake service (or every 6 months, whichever occurs first). (8)
- Engine drive belts service (or every 12 months, whichever occurs first). (18)
- Clutch pedal free travel service. (10)
- Throttle linkage service. (19)
- Thermostatically controlled engine cooling fan service. (4)(20)
- Shields and underhood insulation service. (4)(5)(21)
- Air intake system service (or every 24 months, whichever occurs first). (4)(5)(24)
- Thermostatically controlled air cleaner service (or every 24 months, whichever occurs first). (3)(4)(25)†
- Evaporative Control System Service (if equipped) (or every 24 months, whichever occurs first). (3)(26)†
- Rear axle air shift motor service. (11)
- Check air brake relay valve operation and check for leaks (or every month, or every 300 hours, whichever occurs first).
- Air brake chamber service (or every 2 months, whichever occurs first). (41)
- Trailer brake hand control valve service (or every 3 months, or 900 hours, whichever occurs first). (42)

**99,000 Miles (165 000 km)**

- Engine oil and filter service. (3)(9)
- Check fluid levels (or every 3 months, whichever occurs first). (1)(2)(6)

**100,000 Miles (166 000 km)**

- Change power steering fluid (or every 36 months, whichever occurs first). (13)
- Front axle service (or every 36 months, whichever occurs first). (38)
- Rear axle service -- Eaton, Rockwell, Spicer Axles (or every 12 months, whichever occurs first). (1)(37)
- Exhaust brake service (if equipped). Check for excessive spindle free play and smooth operation. Lubricate ball joint cap.
- Accelerator control cable replacement (diesel) (or every 36 months, whichever occurs first). (19)
- Air brake service (or every 12 months, or 3,600 hours, whichever occurs first). (44)

**150,000 Miles (240 000 km)**

- Cooling system service (or every 60 months since last service, whichever occurs first). (3)(35)

**200,000 Miles (320 000 km)**

- Remove, disassemble, clean and inspect the air brake trailer supply valve (or every 2 years, or 7,200 hours, whichever occurs first).

**250,000 Miles (400 000 km)**

- Wheel bearings service -- Eaton Axle (oil-filled) (or every 36 months, whichever occurs first). (2)(23)
- Rear axle service -- Eaton, Rockwell, Spicer Axles (or every 36 months, whichever occurs first). (2)(37)
- Manual transmission fluid replacement (or every 60 months, whichever occurs first).

**300,000 Miles (480 000 km)**

- Remove, disassemble, clean and inspect the air brake air dryer (or every 3 years, or 10,800 hours, whichever occurs first). Replace dessicant on Bendix-Westinghouse units.

## Footnotes

† = The U.S. Environmental Protection Agency or the California Air Resources Board has determined that the failure to perform this maintenance item will not nullify the emission warranty or limit recall liability prior to the completion of the vehicle's useful life. We, however, urge that all recommended maintenance services be performed at the indicated intervals and the maintenance be recorded.

(1) = If your vehicle has an Allison automatic transmission, your GM Owner's Manual is supplemented by an Allison Transmission Operator's Manual. Always refer to these manuals for related maintenance services.

(2) = Check the fluid level in the manual transmission.

(3) = An Emission Control Service.

(4) = A Noise Emission Control Device.

(5) = Applies only to vehicles sold in the United States.

(6) = Check fluid level in brake master cylinder, clutch master cylinder (if equipped), power steering pump, axle, transmission and hydraulic spring parking brake pump (if equipped). A low fluid level in the brake master cylinder can indicate worn brake linings and should be checked accordingly.

(7) = Inspect brake lines and hoses for proper hook-up, binding, leaks, cracks, chafing, etc. Inspect disc brake pads for wear and rotors for surface condition. Check brake pedal for excessive free play or travel (or every 6 months, whichever occurs first) and have serviced if needed. Check brakes more often if driving habits and conditions result in frequent braking.

(8) = Inspect hydraulic parking brake drum and linings for wear or cracks and check linkage and adjustment. Check spring brake actuator and pump for leaks. Note: The spring brake section of the actuator is non-serviceable.

(9) = This vehicle has an Engine Oil Life Monitor. This monitor will show you when to change the engine oil and filter -- usually between 3,000 miles (5 000 km) and 7,500 miles (12 500 km) since your last oil change. Under severe conditions, the indicator may come on before 3,000 miles (5 000 km). Never drive your vehicle more than 7,500 miles (12 500 km) or 12 months without an oil and filter change.

The system won't detect dust in the oil. So if you drive in a dusty area, be sure to change your oil and filter every 3,000 miles (5 000 km) or sooner if the Change Oil Light comes on. Remember to reset the Oil Life Monitor whenever the oil is changed. For more information, see "Change Oil Light" in the Index.

(10) = Check clutch pedal for free travel. Press pedal by hand until resistance is felt. Free travel should be maintained at 1.5 to 2 inches (38 to 51 mm) measured at the clutch pedal pad. Make checks at 3,000 miles (5 000 km) and 6,000 miles (10 000 km) and then every 6,000 miles (10 000 km) thereafter.

(11) = Inspect rear axle air shift motor for fluid leaks. Remove plug to check fluid level. Inspect air lines and hoses for proper hook-up, binding, leaks, etc. Inspect at 3,000 miles (5 000 km) and 24,000 miles (40 000 km) and then every 24,000 miles (40 000 km) thereafter.

(12) = Chassis Lubrication Service: Lubricate all grease fittings in front suspension, front axle and steering linkage. DO NOT lubricate kingpin bushings with air pressure equipment; instead, use a hand grease gun to ensure complete purge and eliminate sealer cap distortion. Lubricate transmission and shift linkage, hood latches and hood hinges, parking brake lever pivot, clevis pins and linkage, disc brake caliper rails, clutch linkage and release bearing (if equipped), propeller shaft slip joint, universal joint, brake camshaft bracket, slack adjusters, pedal shaft, clutch cross shaft and clutch pedal springs. Lubricate suspension, axle and steering linkage more often when operating under dusty or muddy conditions and in excessive off-road use.

(13) = Check steering system:

- Look for damaged, loose or missing parts. Also look for parts showing signs of wear or lack of lubrication. Replace parts as needed. Also check steering gear mounting bolts, pitman arm nut, gear housing upper cover and side cover attaching bolts, steering column mounting bolts and cardan joint clamp bolts; tighten if necessary. (See service manual.)
- Inspect power steering hoses, tubes and fittings for leaks. Hoses and lines must not be twisted, kinked or tightly bent. Make sure clips, clamps, supporting tubes and hoses are in place and properly secured.
- Check steering gear for leakage around pitman shaft and housing. If leakage is evident (lubricant oozing out, not just oily film), leak should be corrected immediately.

(14) = Check front and rear suspension. Look for damaged, loose or missing parts or parts showing signs of wear or lack of lubrication. Replace parts as needed.

(15) = Adjust tire pressures as indicated on the Certification/Tire label for optimum tire life. See “Tires” in the Index for further details. Check tires for excessive or abnormal wear or damage. Also check for damaged wheels. Replace wheels and/or tires as needed.

(16) = Check spring-to-axle U-bolts and shackle bolts for proper torque. See the service manual for torque sequence and specifications. When parts are replaced, the torque must be checked and adjusted more often during the first 6,000 miles (10 000 km). Check torque at 500 miles (800 km) and 2,000 miles (3 000 km) after first use of parts.

(17) = Check complete exhaust system and cab areas near the exhaust system for broken, damaged, missing or out-of-position parts. Also inspect for open seams, holes, loose connections or other conditions which could let exhaust fumes seep into the driver compartment. Needed repairs should be made at once. To help maintain system integrity, replace exhaust pipes whenever a new muffler is put on.

(18) = Check all engine drive belts for cracks, fraying, wear and proper tension. Adjust or replace as needed.

(19) = Check throttle linkage for damaged or missing parts (including throttle return springs), interference or binding. Fix any problems at once. Do not lubricate accelerator and cruise control cables.

(20) = With the engine off and below normal operating temperature, check to see that the thermostatically controlled engine cooling fan can be rotated by hand on viscous-operated drives. Replace as needed.

(21) = Check shields and underhood insulation for damage or looseness. Adjust or replace as needed.

(22) = Lubricate caliper housing, caliper support spring and caliper support key.

(23) = Wheel bearing service:

- Grease type -- Clean, inspect and lubricate with the proper wheel bearing grease at designated intervals or when hubs are removed. See “Recommended Fluids and Lubricants” in the Index.
- Oil-filled type -- Some wheel bearings are lubricated by rear axle lubricant. When you have oil-filled hubs, use lubricant identical to that used in your rear axle. Lubricant change intervals are the same for front and rear axles. However, you must maintain oil level at the OIL LEVEL mark between change intervals. See “Recommended Fluids and Lubricants” in the Index.

(24) = Check the air intake system installation to see that gaskets are seated properly and all hose connections, fasteners and other components are tight. For gasoline engines, also check to be sure the air cleaner housing is properly seated, that the cover fits tightly and that the wing nut is tight. Tighten connections and fasteners or replace parts as required.



(25) = Check thermostatically controlled air cleaner installation to make certain that all ducts are connected and correctly installed. Also, check valve for proper operation.

(26) = Evaporative Control System Service (if equipped): Check all fuel and vapor lines and hoses for proper connections and correct routing (or every 24 months, whichever occurs first). Replace parts as needed.

(27) = Replace air cleaner filter (or every 24 months, whichever occurs first). Replace filter more often if driving in dusty conditions. Ask your dealer for the proper replacement intervals for your driving conditions.

(28) = Replace spark plugs. Inspect wires for damage. Check the wire boot and boot heat shield fit at spark plugs and coil. Replace parts as needed.

(30) = Check the fuel tank, fuel cap and fuel lines for damage which could cause leakage. Inspect fuel cap for correct sealing ability and any indications of damage. Check fuel cap gasket for even filler neck imprint. Replace parts as needed.

(31) = Check EGR system as described in the service manual. See “Service and Owner Publications” in the Index.

(32) = Inspect Electronic Vacuum Regulator Valve (EVRV) filter for excessive contamination or plugging. If needed, clean filter with solution of soap and water, let dry and install.

(33) = Check the PCV system for proper operation and clean PCV valve. Replace hoses as needed.

(34) = Replace PCV valve and blow out the PCV valve hose with compressed air. Replace hoses as needed.

(35) = Drain, flush and refill cooling system. See “Recommended Fluids and Lubricants” in the Index for what to use. Inspect hoses. Clean radiator, condenser, pressure cap and neck. Pressure test cooling system and pressure cap. For Caterpillar® diesel engines, always refer to the Caterpillar Diesel Engine Operation & Maintenance Manual for coolant recommendations and change intervals.

(37) = Rear axle service: Change the lubricant. See “Recommended Fluids and Lubricants” in the Index.

(38) = Front axle service: Re-pack upper kingpin roller bearing.

(39) = Air brake service:

- Inspect brake lines and hoses for proper hook-up, binding, leaks, cracks, chafing, etc. Inspect drum brake linings for wear or cracks. Inspect other brake parts at each wheel, including drums, wheel cylinders and piston heat shields and boots. Check brake pedal for excessive free play or travel (or every 6 months, whichever occurs first) and have serviced if needed. Check brakes more often if driving habits and conditions result in frequent braking.

- Test air lines for leaks; tighten as needed. Replace compressor filter.
- Inspect air parking brake chamber for leaks and damage. Inspect lines and hoses for leaks, cracks, chafing, etc. Also check all attachments for tightness, wear or damage. Note: The spring brake section of the rear brake diaphragms are non-serviceable.
- Replace the air compressor filter element, mounted on the air compressor. For remote air compressor intake service, refer to air cleaner filter replacement.

(40) = Clean and lubricate air brake automatic slack adjuster. Check pushrod travel and auto adjustment operation. Have serviced if needed.

(41) = Air brake chamber service: Check operation, mounting, clamps and air lines and check for leaks.

(42) = Trailer brake hand control valve service: Check operation; lubricate cam and follower.

(44) = Air brake service: Remove, disassemble, clean and inspect the safety valve, standard brake chamber, quick release valve, quick release/double check valve combination, parking brake control valve, double check valve, pressure protection valve and alcohol injector.

Remove, disassemble and clean the application valve; replace parts showing wear. Remove, disassemble, clean and inspect the spring brake control valve; replace rubber parts.

(45) = For Stud Piloted Wheels Only: Tighten the wheel stud nuts to the specified torque values at 100 miles (160 km), 500 miles (800 km) and 1,000 miles (1 600 km) and then every 1,000 miles (1 600 km) thereafter. See “Tightening the Wheel Nuts” in the Index.

(46) = For Hub Piloted Wheels Only: Tighten the wheel stud nuts to the specified torque values at 1,000 miles (1 600 km). Thereafter, tighten them 1,000 miles (1 600 km) after each time the wheel is removed. See “Tightening the Wheel Nuts” in the Index.

(47) = Short Trip/City Maintenance Schedule. See “Maintenance Schedule Definition” in the introduction pages at the beginning of this section.

(48) = Long Trip/Highway Maintenance Schedule. See “Maintenance Schedule Definition” in the introduction pages at the beginning of this section.

## Part B: Owner Checks and Services

Listed in this part are owner checks and services which should be performed at the intervals specified to help ensure the safety, dependability and emission control performance of your vehicle.

For your safety and that of others, any of the safety-related components that may have been damaged in an accident should be checked and any needed repairs made before operating the vehicle.

At the minimum, these routine checks should be made every 6 months or 6,000 miles (10 000 km), whichever occurs first. Whenever repairs are needed, have them completed before operating the vehicle.

### At Each Fuel Fill

*It is important for you or a service station attendant to perform these underhood checks at each fuel fill.*

### Engine Oil Level Check

Check the engine oil level and add the proper oil if necessary. See “Engine Oil” in the Index for further details.

### Engine Coolant Level Check

Check the engine coolant level and add DEX-COOL<sup>®</sup> coolant mixture if necessary. See “Engine Coolant” in the Index for further details.

### Windshield Washer Fluid Level Check

Check the windshield washer fluid level in the windshield washer tank and add the proper fluid if necessary. See “Windshield Washer Fluid” in the Index for further details.

### Tire Inflation Check

Check tire inflation cold. Make sure tires are inflated to the pressures specified on the Certification/Tire label. See “Tires” in the Index for further details.

## At Least Twice a Year

### Restraint System Check

Make sure the safety belt reminder light (if equipped) and all your belts, buckles, latch plates, retractors and anchorages are working properly. Look for any other loose or damaged safety belt system parts. If you see anything that might keep a safety belt system from doing its job, have it repaired. Have any torn or frayed safety belts replaced.

### Wiper Blade Check

Inspect wiper blades for wear or cracking. Replace blade inserts that appear worn or damaged or that streak or miss areas of the windshield. Also see “Wiper Blades, Cleaning” in the Index.

### Weatherstrip Lubrication

Silicone grease on weatherstrips will make them last longer, seal better, and not stick or squeak. Apply silicone grease with a clean cloth. During very cold, damp weather more frequent application may be required. (See “Recommended Fluids and Lubricants” in the Index.)

### Body Lubrication Service

Lubricate all surfaces such as door checks, door lock bolts, lock strike plates, door hinge bushings and dovetail bumper wedges. Where oil holes are provided, a driplless oil can be used. The seat adjusters, seat track, door weatherstrips and rubber hood bumpers should also be lubricated.

Part C tells you what to use. More frequent lubrication may be required when exposed to a corrosive environment.

### Parking Brake Check

Park on a fairly steep hill and hold the vehicle with the parking brake only. This checks holding ability.

## Starter Switch Check

**CAUTION:**

**When you are doing this check, the vehicle could move suddenly. If it does, you or others could be injured. Follow the steps below.**

1. Before you start, be sure you have enough room around the vehicle.
2. Firmly apply both the parking brake (see “Parking Brake” in the Index if necessary) and the regular brakes.  
**NOTE:** Do not use the accelerator pedal, and be ready to turn off the engine immediately if it starts.
3. On automatic transmission vehicles, try to start the engine in each gear. The starter should work only in PARK (P), if equipped, or NEUTRAL (N). If the starter works in any other position, your vehicle needs service.

## Automatic Transmission Shift Indicator Check

Check that the indicator points to the gear chosen.

## Steering Check

Be alert for any changes in steering action, abnormal front tire wear or steering wheel position. An inspection or service is needed when the steering wheel is harder to turn or has too much free play, or if there are strange sounds when turning or parking.

## Brake System Check

Be alert to illumination of the low air warning lamp or for the tone alarm, or changes in braking action, such as repeated pulling to one side, unusual sounds when braking or increased brake pedal travel. Make sure air brake system reservoirs are drained daily with full system air pressure, and check system for leaks. Any of these conditions could indicate the need for brake system inspection and/or service.

## Engine Cooling System Service

Inspect the hoses and have them replaced if they are cracked, swollen or deteriorated. Inspect all pipes, fittings and clamps; replace as needed. Clean the outside of the radiator and air conditioning condenser. To help ensure proper operation, a pressure test of the cooling system and pressure cap is recommended at least once a year.

## Exhaust System Check

Be alert for any changes in the sound of the exhaust system or any smell of fumes. These are signs the system may be leaking. Have it checked and/or repaired at once. Refer to “Engine Exhaust” and “Running Your Engine While You’re Parked” in the Index.

## Windshield Wipers and Washers Check

Check operation and condition of the wiper blades. Check the flow of the washer spray.

## Defroster Check

Move the control to the defrost symbol and the fan to HI or the high symbol. Then check the airflow from the ducts at the inside base of the windshield.

## Mirrors and Sun Visors Check

Check that friction joints hold mirrors and sun visors in place.

## Seat Adjuster Check

When adjusting a manual seat, be sure seat adjusters latch by attempting to move the seat after latching.

## Lamps Check

Check panel lighting, warning lights, indicator lights and interior lamps. On the outside, check: license plate lamps, sidemarker lamps, reflectors or lights on outside mirrors, headlamps, parking lamps, identification and clearance lamps, taillamps, brake lamps, turn signals, backup lamps and hazard warning flashers. Have headlamp aim checked at once if beams seem improperly aimed.

## Glass, Mirrors, Lamps and/or Reflectors Condition Check

Look for broken, scratched, dirty or damaged glass, mirrors, lamps or reflectors that could reduce the view or visibility or cause injury. Replace, clean or repair promptly.

### **Door Latches Check**

Check that doors close, latch and lock tightly. Check for broken, damaged or missing parts that might prevent tight latching.

### **Hood Latches Check**

Check that the hood closes firmly. Check for broken, damaged, loose or missing parts that might prevent tight latching. Make sure the secondary latch (if equipped) keeps the hood from opening all the way when the primary latch is released.

### **Fluid Leaks Check**

Check for fuel, coolant, oil or other fluid leaks by looking at the surface beneath the vehicle after it has been parked for a while.

### **Underbody Inspection**

Corrosive materials used for ice, snow removal and dust control can collect on the underbody. If these materials are not removed, accelerated corrosion (rust) can occur on underbody parts such as fuel lines, frame, floor pan and exhaust system. At least every spring, flush these

materials from the underbody with plain water. Take care to clean well any areas where mud and other debris can collect. Sediment packed in closed areas of the frame should be loosened before being flushed.

### **Engine Cover Check**

Check that the cab's engine cover and seal (if equipped) are not torn or damaged. Be sure that the cover is bolted down firmly to the floor.

### **At Least Once a Year**

#### **Key Lock Cylinders Service**

Lubricate the key lock cylinders with the lubricant specified in Part C.

#### **Underbody Flushing Service**

At least every spring, use plain water to flush any corrosive materials from the underbody. Take care to clean thoroughly any areas where mud and other debris can collect.

#### **Tractor Protection (Breakaway) Valve Check**

On air brake models, remove, disassemble, clean and inspect the tractor protection (breakaway) valve.

## Part C: Recommended Fluids and Lubricants

NOTE: Fluids and lubricants identified below by name, part number or specification may be obtained from your dealer.

USAGE	FLUID/LUBRICANT
Engine Oil (Gasoline Engine)	Engine Oil with the American Petroleum Institute Certified For Gasoline Engines “Starburst” symbol of the proper viscosity. To determine the preferred viscosity for your vehicle’s engine, see “Engine Oil” in the Index.
Engine Oil (Caterpillar Diesel Engine)	See the Caterpillar® Operation & Maintenance Manual for Engine Oil recommendations.
Engine Coolant (GM Gasoline Engine)	50/50 mixture of clean, drinkable water and use only GM Goodwrench® DEX-COOL® or Havoline® DEX-COOL® Coolant. See “Engine Coolant” in the Index.

USAGE	FLUID/LUBRICANT
Engine Coolant (Caterpillar Diesel Engine)	See the Caterpillar® Operation & Maintenance Manual for Engine Coolant recommendations.
Hydraulic Brake System	Delco Supreme 11® Brake Fluid (GM Part No. 12377967 or equivalent DOT-3 Brake Fluid).
Windshield Washer Solvent	GM Optikleen® Washer Solvent (GM Part No. 1051515) or equivalent.
Clutch Bearing Lubricant	Clutch Bearing Lubricant (GM Part No. 12345777 or equivalent) or NLGI #3 consistency.
Exhaust Brake Ball Joint Cap Lubricant	High-Temperature Grease (GM Part No. 1051344 or equivalent) or NLGI #3 consistency.
Spring Parking Brake Hydraulic Pump	DEXRON® -III Automatic Transmission Fluid.



<b>USAGE</b>	<b>FLUID/LUBRICANT</b>
Brake Caliper Housing, Caliper Support Spring and Caliper Support Key	Aeroshell #5 Grease (GM Part No. 12377969 or equivalent).
Air Brake System Alcohol Evaporator	Commercial grade of Methyl Alcohol as specified in GM 6015-M.
Power Steering System	GM Power Steering Fluid (GM Part No. 1052884 - 1 pint, 1050017 - 1 quart, or equivalent).
Manual Transmission	Synthetic Manual Transmission Fluid (GM Part No. 12345724) is the recommended lubricant to use.

<b>USAGE</b>	<b>FLUID/LUBRICANT</b>
Automatic Transmission	See the Allison Transmission Operator's Manual for correct Transmission Fluid.
Chassis Lubrication	Chassis Lubricant (GM Part No. 12377985 or equivalent) or lubricant meeting requirements of NLGI # 2, Category LB or GC-LB.
Wheel Bearing Grease	Wheel Bearing Lubricant meeting requirements of NLGI # 2, Category GC or GC-LB (GM Part No. 1051344 or equivalent).

<b>USAGE</b>	<b>FLUID/LUBRICANT</b>
Front Wheel Bearings with Oil Filled Hubs	SAE 75W-90 Synthetic Axle Lubricant for Medium Duty Trucks (GM Part No. 12345841 or equivalent).
Rear Axle	SAE 75W-90 Synthetic Axle Lubricant for Medium Duty Trucks (GM Part No. 12345841 or equivalent).
Rear Axle Shift Motor Lubricant	Refrigerant Oil (GM Part No. 5416939).

<b>USAGE</b>	<b>FLUID/LUBRICANT</b>
Propshafts and Splines	Wheel Bearing Lubricant meeting requirements of NLGI # 2, Category GC or GC-LB (GM Part No. 1051344 or equivalent).
Cab -- Door Hinges and Latches	Multi-Purpose Lubricant, Superlube <sup>®</sup> (GM Part No. 12346241 or equivalent).
Weatherstrip Conditioning	Dielectric Silicone Grease (GM Part No. 12345579 or equivalent).
Weatherstrip Squeaks	Synthetic Grease with Teflon, Superlube <sup>®</sup> (GM Part No. 12371287 or equivalent).

## Part D: Maintenance Record

After the scheduled services are performed, enter the date, odometer reading and services performed on the maintenance record charts provided here. Any additional information from “Owner Checks and Services” can be

added on the following record pages. Also, you should retain all maintenance receipts. Your owner information portfolio is a convenient place to store them.

<b>Maintenance Record</b>			
<b>DATE</b>	<b>ODOMETER READING</b>	<b>SERVICED BY</b>	<b>MAINTENANCE PERFORMED</b>

## Maintenance Record

DATE	ODOMETER READING	SERVICED BY	MAINTENANCE PERFORMED

## Section 8 Customer Assistance Information

---

Here you will find out how to contact GMC if you need assistance. This section also tells you how to obtain service publications and how to report any safety defects.

8-2 Customer Satisfaction Procedure  
8-3 Customer Assistance for Text Telephone (TTY) Users  
8-3 Customer Assistance Offices  
8-5 Roadside Assistance  
8-5 Warranty Information  
8-6 Reporting Safety Defects to the United States Government

8-6 Reporting Safety Defects to the Canadian Government  
8-7 Reporting Safety Defects to General Motors  
8-7 Ordering Service and Owner Publications in Canada

## Customer Satisfaction Procedure



Your satisfaction and goodwill are important to your dealer and to GMC. Normally, any concerns with the sales transaction or the operation of your vehicle will be resolved by your dealer's sales or service departments. Sometimes, however, despite the best intentions of all concerned, misunderstandings can occur. If your concern has not been resolved to your satisfaction, the following steps should be taken:

**STEP ONE** -- Discuss your concern with a member of dealership management. Normally, concerns can be quickly resolved at that level. If the matter has already been reviewed with the sales, service or parts manager, contact the owner of the dealership or the general manager.

**STEP TWO** -- If after contacting a member of dealership management, it appears your concern cannot be resolved by the dealership without further help, contact the GMC Consumer Relations Manager by calling 1-800-GMC-8782 (1-800-462-8782, Customer Assistance prompt). In Canada, contact GM of Canada Customer Communication Centre in Oshawa by calling 1-800-263-3777 (English) or 1-800-263-7854 (French).

We encourage you to call the toll-free number in order to give your inquiry prompt attention. Please have the following information available to give the Customer Assistance Representative:

- Vehicle Identification Number (This is available from the vehicle registration or title, or the plate at the top left of the instrument panel and visible through the windshield.)
- Dealership name and location
- Vehicle delivery date and present mileage

When contacting GMC, please remember that your concern will likely be resolved at a dealer's facility. That is why we suggest you follow Step One first if you have a concern.

## Customer Assistance for Text Telephone (TTY) Users

To assist customers who are deaf, hard of hearing, or speech-impaired and who use Text Telephones (TTYs), GMC has TTY equipment available at its Customer Assistance Center. Any TTY user can communicate with GMC by dialing: 1-800-GMC-8583 (1-800-462-8583). (TTY users in Canada can dial 1-800-263-3830.)

## Customer Assistance Offices

GMC encourages customers to call the toll-free number for assistance. If a U.S. customer wishes to write to GMC, the letter should be addressed to GMC's Customer Assistance Center.

### United States

Pontiac-GMC Customer Assistance Center  
P.O. Box 436008  
Pontiac, MI 48343-6008

1-800-GMC-8782 (1-800-462-8782)  
1-800-462-8583 (For Text Telephone devices (TTYs))  
Roadside Assistance: 1-800-GMC-8782

## Canada

General Motors of Canada Limited  
Customer Communication Centre, 163-005  
1908 Colonel Sam Drive  
Oshawa, Ontario L1H 8P7

1-800-263-3777 (English)  
1-800-263-7854 (French)  
1-800-263-3830 (For Text Telephone devices (TTYs))  
Roadside Assistance: 1-800-268-6800

## All Overseas Locations

GMODC - Customer Communication Centre  
169-007  
1908 Colonel Sam Drive  
Oshawa, Ontario L1H 8P7

Telephone: 905-644-4112  
Fax: 905-644-4866

## Caribbean Numbers

1-800-496-9992 (English) Puerto Rico  
1-800-496-9993 (Spanish) Puerto Rico  
1-800-751-4135 (English) Dominican Republic  
1-800-751-4136 (Spanish) Dominican Republic  
1-800-496-9994 U.S. Virgin Islands  
1-800-389-0009 Bahamas  
1-800-534-0122 Bermuda, Barbados, Antigua & B.V.I.

If toll free service is not available in the Caribbean,  
call Puerto Rico 1-787-763-1315.



## Roadside Assistance

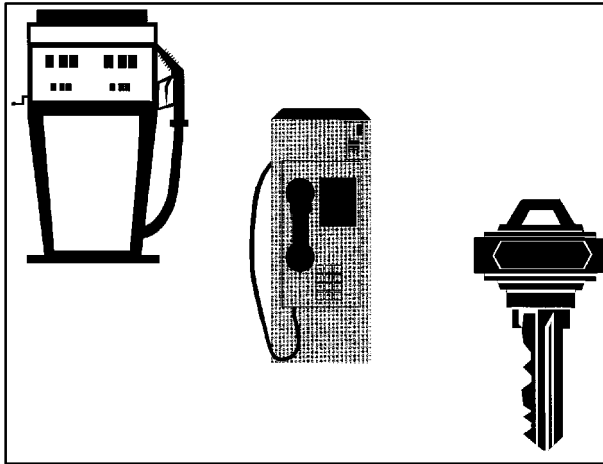

GM Medium Duty Truck's Roadside Assistance provides stranded owners with towing service for disabled vehicles.

This service combines the efforts of trained telephone representatives with a network of GM Medium Duty Truck's dealer services.

Just dial Medium Duty Roadside Assistance at 1-800-GMC-8782 (1-800-462-8782) to reach a qualified representative who can assist you in a repair or arrange a tow. Other recommended services can also be arranged for situations such as retrieving locked-in keys, changing a tire or delivering gasoline, at a charge to the owner. We also provide dealer information at no charge such as location of the nearest authorized medium duty GM Truck dealer and their hours of operation.

Roadside Assistance is available 24 hours a day, 7 days a week, 365 days a year, including weekends and holidays. Should you have any questions about Roadside Assistance, call the GMC Roadside Assistance Center or contact your dealer.

## Warranty Information

Your vehicle comes with a separate warranty booklet that contains detailed warranty information.

## **REPORTING SAFETY DEFECTS TO THE UNITED STATES GOVERNMENT**

If you believe that your vehicle has a defect which could cause a crash or could cause injury or death, you should immediately inform the National Highway Traffic Safety Administration (NHTSA), in addition to notifying General Motors.

If NHTSA receives similar complaints, it may open an investigation, and if it finds that a safety defect exists in a group of vehicles, it may order a recall and remedy campaign. However, NHTSA cannot become involved in individual problems between you, your dealer or General Motors.

To contact NHTSA, you may either call the Auto Safety Hotline toll-free at 1-800-424-9393 (or 366-0123 in the Washington, D.C. area) or write to:

NHTSA, U.S. Department of Transportation  
Washington, D.C. 20590

You can also obtain other information about motor vehicle safety from the hotline.

## **REPORTING SAFETY DEFECTS TO THE CANADIAN GOVERNMENT**

If you live in Canada, and you believe that your vehicle has a safety defect, you should immediately notify Transport Canada, in addition to notifying General Motors of Canada Limited. You may write to:

Transport Canada  
330 Sparks Street  
Tower C  
Ottawa, Ontario K1A 0N5

## **REPORTING SAFETY DEFECTS TO GENERAL MOTORS**

In addition to notifying NHTSA (or Transport Canada) in a situation like this, we certainly hope you'll notify us. Please call us at 1-800-GMC-8782 (1-800-462-8782), or write:

Pontiac-GMC Customer Assistance Center  
P.O. Box 436008  
Pontiac, MI 48343-6008

In Canada, please call us at 1-800-263-3777 (English) or 1-800-263-7854 (French). Or, write:

General Motors of Canada Limited  
Customer Communication Centre, 163-005  
1908 Colonel Sam Drive  
Oshawa, Ontario L1H 8P7

## **Ordering Service and Owner Publications in Canada**

Service manuals, owner's manuals and other service literature are available for purchase for all current and past model General Motors vehicles.

The toll-free telephone number for ordering information in Canada is 1-800-668-5539.

# 1999 GMC SERVICE PUBLICATIONS ORDERING INFORMATION

*The following publications covering the operation and servicing of your vehicle can be purchased by filling out the Service Publication Order Form in this book and mailing it in with your check, money order, or credit card information to Helm, Incorporated (address below.)*

## CURRENT PUBLICATIONS FOR 1999 GMC

### SERVICE MANUALS

Service Manuals have the diagnosis and repair information on engines, transmission, axle, suspension, brakes, electrical, steering, body, etc.

RETAIL SELL PRICE: \$90.00

### TRANSMISSION, TRANSAXLE, TRANSFER CASE UNIT REPAIR MANUAL

This manual provides information on unit repair service procedures, adjustments and specifications for the 1999 GM transmissions, transaxles and transfer cases.

RETAIL SELL PRICE: \$50.00

### SERVICE BULLETINS

Service Bulletins give technical service information needed to knowledgeable service General Motors cars and trucks. Each bulletin contains instructions to assist in the diagnosis and service of your vehicle.

### OWNER'S INFORMATION

Owner publications are written directly for Owners and intended to provide basic operational information about the vehicle. The owner's manual will include the Maintenance Schedule for all models.

In-Portfolio: Includes a Portfolio, Owner's Manual and Warranty Booklet.

RETAIL SELL PRICE: \$15.00

Without Portfolio: Owner's Manual only.

RETAIL SELL PRICE: \$10.00

### CURRENT & PAST MODEL ORDER FORMS

Service Publications are available for current and past model GM vehicles. To request an order form, please specify year and model name of the vehicle.

**PLEASE COMPLETE THE ORDER FORM SHOWN ON THE FOLLOWING PAGE AND MAIL TO:**

Helm, Incorporated • P.O. Box 07130 • Detroit, MI 48207

**OR ORDER TOLL FREE: 1-800-551-4123**

Monday-Friday 8:00 AM – 6:00 PM Eastern Time

For Credit Card Orders Only (VISA–MasterCard–Discover)

<p align="center"><b>ORDER TOLL FREE</b>  <i>(NOTE: For Credit Card Holders Only)</i>  <b>1-800-551-4123</b>                  (Monday-Friday 8:00 AM – 6:00 PM EST)                  FAX Orders Only 1-313-865-5927</p>	<p>Orders will be mailed within 10 days of receipt. Please allow adequate time for postal service. If further information is needed, write to the address shown below or call 1-800-551-4123. Material cannot be returned for credit without packing slip with return information within 30 days of delivery. On returns, a re-stocking fee may be applied against the original order.</p>
---	--

1 9 9 9 G M	PUBLICATION FORM NUMBER	ITEM DESCRIPTION	VEHICLE MODEL		QTY.	PRICE EACH*	TOTAL PRICE
			NAME	YEAR			
		Service Manual		1999		\$90.00	
		Car & Light Truck Transmission Unit Repair		1999		\$50.00	
		Owner's Manual In Portfolio		1999		\$15.00	
		Owner's Manual Without Portfolio		1999		\$10.00	

<b>S H I P T O</b>	<p><b>NOTE:</b> Dealers and Companies please provide dealer or company name, and also the name of the person to whose attention the shipment should be sent.                  Mail completed order form to:                  HELM, INCORPORATED • P.O. Box 07130 • Detroit, MI 48207                  For purchases outside U.S.A. please write to the above address for quotation.</p>		
	_____		
	(CUSTOMER'S NAME)	(ATTENTION)	
	_____		
	(STREET ADDRESS—NO P.O. BOX NUMBERS)		
	(CITY)	(STATE)	(ZIP CODE)
DAYTIME TELEPHONE NO. _____		(     ) AREA CODE	

<b>P A Y M E N T</b>	<input type="checkbox"/> <b>Check or Money Order payable to Helm, Inc. (USA funds only — do not send cash.)</b>		<b>TOTAL MATERIAL</b>	
	<input type="checkbox"/> MasterCard		Michigan Purchasers add 6% sales tax	
	<input type="checkbox"/> VISA		<b>U.S. Order Processing</b> <b>\$5.00</b>	
	<input type="checkbox"/> Discover		<b>Canadian Postage (See Note Below)</b>	
	Account Number: <input type="text"/> <input type="text"/> <input type="text"/> <input type="text"/> <input type="text"/> <input type="text"/> <input type="text"/> <input type="text"/> <input type="text"/> <input type="text"/> <input type="text"/> <input type="text"/> <input type="text"/> <input type="text"/> <input type="text"/> <input type="text"/> <input type="text"/> <input type="text"/>		<b>GRAND TOTAL</b>	
	Expiration Date mo/yr: <input type="text"/> <input type="text"/> <input type="text"/> <input type="text"/>		Check here if your billing address is different from your shipping address shown. <input type="checkbox"/>	
_____ CUSTOMER SIGNATURE				

GM-GMC-ORD99    \*(Prices are subject to change without notice and without incurring obligation. Allow ample time for delivery.)

Note to Canadian Customers: All listed prices are quoted in U.S. funds. Canadian residents are to make checks payable in U.S. funds. To cover Canadian postage, add \$11.50 plus the U.S. order processing.



# NOTES

---

---

---

---

---

---

---

---

---

---

---

---

---

---

---

---

---

---

---

---

---

---

---

## Section 9 Index

---

### Air

Brake System Warning Light	2-59
Cleaner	6-17
Cleaner Filter	6-77
Compressor Filter	6-77
Conditioning	3-5, 6-77
Conditioning Refrigerants	6-77
Dryer	6-34
Filter Restriction Indicator	6-17
Suspension	2-19
Air Brake Systems	6-33
Air Dryer	6-34
Alcohol Injector	6-34
Moisture Ejector	6-33
Alcohol Injector	6-34
Alignment and Balance, Tire	6-51
AM-FM Stereo	3-8
AM-FM Stereo with Remote Cassette Tape Player	3-10
Antenna	3-12
Antifreeze	6-23
Anti-Lock	
Brakes	4-7
Brake System Warning Light	2-61, 4-7
Appearance Care	6-59
Appearance Care Materials	6-66

Apply Park Brake Warning Light	2-60
Ashtray	2-47
Audio Systems	3-7
Automatic Transmission Fluid	6-18
Automatic Transmission Shift Indicator Check	7-25
Auxiliary Power Jacks	2-48
Axle, Rear	6-20
Airshift Control	2-19
Differential Lock Control	2-41
Fluid Capacity	6-76
Shift Motor	6-20
Two-Speed Electric Shift Control	2-17
Towing	5-15

<b>B</b> attery	6-42
Battery, Jump Starting	5-5
Brake	
Adjustment	6-33
Air Brake Systems	6-33
Air Parking Brake	2-26
Electric/Hydraulic Parking Brake	2-25
Electric/Hydraulic Parking Brake Fluid	6-36
Exhaust	2-16
Fluid	6-30

Brake (Continued)		Child Restraints	1-26
Four-Wheel and Six-Wheel Drum	6-33	Securing in the Center Seat Position	1-31
Four-Wheel Disc	6-32	Top Strap	1-30
Hydraulic Systems	4-7	Cigarette Lighter	2-47
Master Cylinder	6-30	Circuit Breaker Block, Instrument Panel	6-69
Parking	2-23	Cleaner, Air	6-17
Pedal Travel	6-33	Cleaning	
Propshaft Brake Burnish Procedure	2-24	Fabric	6-59
Releasing Air-Operated Parking Brakes	5-15	Glass	6-62
Replacing System Parts	6-35	Inside of Your Vehicle	6-59
System Check	7-25	Instrument Panel	6-61
System Warning Lights	2-57	Outside of Your Vehicle	6-63
Brake, Anti-Lock	4-7	Safety Belts	6-61
Braking	4-6	Special Problems	6-60
Braking in Emergencies	4-9	Tires	6-64
Break-In, New Vehicle	2-5	Vinyl	6-61
		Windshield and Wiper Blades	6-62
<b>C</b> apacities and Specifications	6-74	Clock, Setting the	3-7
Carbon Monoxide	2-29, 2-30, 4-27	Clutch Pedal Free Travel	6-37
Cassette Tape Player Care	3-12	Comfort Controls	3-2
Center Passenger Position	1-22	Component Box	6-44
Certification/Tire Label	4-28, 6-67	Connections, Trailer	2-49
Changing a Flat Tire	5-34	Control of a Vehicle	4-6
Charging System Light	2-56	Coolant	6-23
Chassis Lubrication	6-37	Heater, Engine	2-15
Check Gages Light	2-67	Recovery Tank	5-22
Checking Your Restraint Systems	1-36	Surge Tank	5-29
Chemical Paint Spotting	6-65		



Cooling System		
Capacity	6-74	
Diesel Engines	5-27, 6-25	
Gasoline Engines	5-20, 6-23	
Crankcase Capacity	6-74	
Cruise Control	2-36	
Customer Assistance for Text Telephone Users	8-3	
Customer Assistance Information	8-1	
Customer Satisfaction Procedure	8-2	
<b>D</b> amage		
Finish	6-65	
Sheet Metal	6-64	
Daytime Running Lamps	2-44	
Daytime Running Lamps Indicator Light	2-67	
Defects, Reporting Safety	8-6, 8-7	
Defensive Driving	4-2	
Defogging	3-6	
Diesel Engine Exhaust Brake	2-16	
Diff Lock Indicator Light	2-63	
Do Not Shift Light	2-57	
Dome Lamps	2-46	
Door		
Latches Check	7-27	
Locks	2-4	
Power Locks	2-4	
Driver Position	1-11	
Driving		
City	4-19	
Defensive	4-2	
Drunken	4-3	
Freeway	4-20	
In a Blizzard	4-26	
In Rain and on Wet Roads	4-16	
Night	4-15	
On Curves	4-10	
On Hill and Mountain Roads	4-22	
On Snow and Ice	4-24	
Through Water	4-18	
Winter	4-24	
Drunken Driving	4-3	
<b>E</b> lectrical Equipment, Adding	6-68	
Electrical System	6-68	
Engine		
Air Cleaner Filter	6-77	
Air Control	2-42	
Automatic Shutdown	2-11	
Coolant (Caterpillar <sup>®</sup> Diesel Engine)	6-27	
Coolant (Gasoline Engine)	6-23	
Coolant Heater	2-15	
Coolant Level Check	7-23	
Coolant Temperature Gage	2-62	
Cooling System Capacity	6-74	
Crankcase Capacity	6-74	
Diesel, Warm-Up	2-11	
Exhaust	2-29, 2-30, 4-27	
Fan Breakage	6-3	
Fan Noise	5-33	
Fast Idle System	2-12	

Engine (Continued)	
Fuse Blocks	6-69, 6-72
Identification	6-67
Oil	6-13, 6-17
Oil Filters and PCV Valves	6-77
Oil Level Check	7-23
Overheating	5-18
Road Speed Governor	2-54
Running While Parked	2-30
Specifications	6-74
Starter Over-Crank Protection	2-7
Starting	2-7, 2-10
Engine Oil	6-13, 6-17
Additives	6-16
Checking	6-13
Diesel Engines	6-17
Filters	6-77
Oil Life Monitor	6-16
Pressure Gage	2-66
Used	6-16
What Kind to Use	6-14
When to Add	6-14
When to Change	6-16
Ether Injection System	6-46
Exhaust	
Brake	2-16
Engine	2-29, 2-30, 4-27
System Check	7-26
<b>F</b> abric Cleaning	6-59
Filling a Portable Fuel Container	6-8
Filling Your Tank	6-7
Filter	
Air Cleaner	6-77
Air Compressor	6-77
Engine Oil	6-77
Filterminder Gage	2-70
Finish Care	6-63
Finish Damage	6-65
Flashers, Hazard Warning	5-2
Flat Tire, Changing	5-34
Fluid Leaks Check	7-27
Fluids and Lubricants	7-28
Footnotes	7-18
French Language Manual	ii
Front Towing	5-10, 5-14
Front Wheel Bearings with Oil-Filled Hubs	6-47
Fuel	
Diesel Engine	6-5
Filling a Portable Container	6-8
Filling Your Tank	6-7
Filter	6-44, 6-77
Gage	2-68
Gasoline Engine	6-4
Tank Capacity	6-76
Water in Fuel	6-5
Fuels in Foreign Countries -- Gasoline	6-6
Fuses and Circuit Breakers	6-69
Fusible Links	6-68

<b>G</b> ages	
Air Pressure	2-69
Engine Coolant Temperature	2-61
Engine Oil Pressure	2-65
Filterminder	2-70
Fuel	2-68
Hourmeter	2-70
Oil Pressure	2-65
Speedometer	2-53
Tachometer	2-54
Transmission Temperature	2-69
Voltmeter	2-56
Guide en Français	ii
<b>H</b> azard Warning Flasher Switch	5-3
Hazard Warning Flashers	5-2
Head Restraints	1-3
Headlamps	2-43
High/Low Beam Changer	2-34
Wiring	6-68
Heating	3-5
Highway Hypnosis	4-21
Hill and Mountain Roads	4-22
Hood	
Access Panels	6-10
Checking Things Under	6-9
Latches Check	7-27
Horn	2-31
Hourmeter Gage	2-70
Hydraulic Brake Warning Light	2-58
Hydroplaning	4-18
<b>I</b> gnition Positions	2-6
Inflation, Tire	6-49
Inspections	
Engine Cover Check	7-27
Underbody	7-27
Instrument Panel	2-50
Circuit Breaker Block	6-69
Cleaning	6-61
Cluster	2-52
Intake Heater Indicator Light	2-63
Inter-Axle Differential Lock Control	2-40
<b>J</b> ump Starting	5-5
<b>K</b> eys	2-2
<b>L</b> abels	
Certification/Tire	4-28, 6-67
Service Parts Identification	6-67
Vehicle Identification Number	6-67
Lamp and Bulb Data	6-74
Lamp Check	7-26

Lamps . . . . .	2-43	Locks	
Dome . . . . .	2-46	Door . . . . .	2-4
On Reminder . . . . .	2-44	Power Door . . . . .	2-4
Latches, Seatback . . . . .	1-3	Lubricants and Fluids . . . . .	7-28
Leaving Your Vehicle . . . . .	2-5	Lubrication Service, Body . . . . .	7-24
Lighter . . . . .	2-47		
Lights		<b>M</b> aintenance Record . . . . .	7-31
Air Brake System Warning . . . . .	2-59	Owner Checks and Services . . . . .	7-23
Anti-Lock Brake System Warning . . . . .	2-61, 4-7	Recommended Fluids and Lubricants . . . . .	7-28
Apply Park Brake Warning . . . . .	2-60	Scheduled Maintenance Services . . . . .	7-4
Brake System Warning . . . . .	2-57	Maintenance, Underbody . . . . .	6-65
Charging System Indicator . . . . .	2-56	Malfunction Indicator Lamp . . . . .	2-64
Check Gages Indicator . . . . .	2-67	Manual Fast Idle Indicator Light . . . . .	2-62
Daytime Running Lamps Indicator . . . . .	2-67	Manual Transmission Fluid . . . . .	6-19
Diff Lock Indicator . . . . .	2-63	Marker and Clearance Lamps . . . . .	2-45
Do Not Shift Warning . . . . .	2-57	Maxi-Fuse Block . . . . .	6-72
Hydraulic Brake System Warning . . . . .	2-58	Mirrors	
Intake Heater Indicator . . . . .	2-63	Convex Outside . . . . .	2-46
Lamp and Bulb Data . . . . .	6-74	Heated Outside . . . . .	2-47
Low Coolant Warning . . . . .	2-62	Inside Rearview . . . . .	2-46
Parking Brake Warning . . . . .	2-60	Outside . . . . .	2-46
Parking Brake Indicator . . . . .	2-60	Model Reference . . . . .	vi
Safety Belt Reminder . . . . .	1-7, 2-55	Moisture Ejector . . . . .	6-33
Service Park Brake Warning . . . . .	2-60	Mountain Roads . . . . .	4-22
Service Trans Filter Indicator . . . . .	2-64	Muffler/Catalytic Converter Assembly . . . . .	6-48
Manual Fast Idle Indicator Light . . . . .	2-62	Multifunction Lever . . . . .	2-32
Loading Your Vehicle . . . . .	4-28		

<b>N</b> ew Vehicle “Break-In” .....	2-5	<b>R</b> adiator .....	5-25
Night Vision .....	4-15	Radiator Pressure Cap .....	6-21
Noise Control System .....	6-11	Radiator Shutters .....	2-13
<b>O</b> dometer .....	2-53	Radio Reception .....	3-10
Off-Road Recovery .....	4-12	Rear Axle .....	6-20
Oil, Engine .....	6-13, 6-17	Airshift Control .....	2-19
Owner Checks and Services .....	7-23	Differential Lock Control .....	2-41
Owner Publications Order Form .....	8-9	Fluid Capacity .....	6-76
Owner Publications, Ordering .....	8-8	Shift Motor .....	6-20
<b>P</b> aint Spotting, Chemical .....	6-65	Two-Speed Electric Shift Control .....	2-17
Parking .....		Towing .....	5-15
Brake .....	2-24	Recovery Tank, Coolant .....	5-22
Brake Check .....	7-24	Refrigerants, Air Conditioning .....	6-77
Brake Indicator Light .....	2-60	Releasing Air Operated Parking Brake .....	5-15
Over Things That Burn .....	2-29	Remote Cassette Tape Player .....	3-10
Passing .....	4-12	Replacement Wheels .....	6-57
Power .....		Replacing Safety Belts .....	1-36
Door Locks .....	2-4	Reporting Safety Defects .....	8-6, 8-7
Option Fuses .....	6-69	Restraints .....	
Steering .....	4-9	Checking .....	1-36
Steering Fluid .....	6-28	Child .....	1-26
Windows .....	2-31	Head .....	1-3
Power Take-Off (PTO) .....	4-31	Replacing Parts After a Crash .....	1-36
Pregnancy, Use of Safety Belts .....	1-21	System Check .....	7-24
Pressure Caps .....	6-77	Right Passenger Position .....	1-21
Problems on the Road .....	5-1	Roadside Assistance .....	8-5
Publications, Service and Owner .....	8-8	Rocking Your Vehicle .....	5-38

<b>S</b> afety Belts .....	1-6	Height Adjustment .....	1-4
Adults .....	1-11	Lumbar Adjustments .....	1-5
Care .....	6-61	National .....	1-4
Center Passenger Position .....	1-22	Securing a Child Restraint .....	1-31
Children .....	1-23	Service .....	6-2
Driver Position .....	1-11	Bulletins, Ordering .....	8-8
Extender .....	1-36	Manuals, Ordering .....	8-8
How to Wear Properly .....	1-11	Park Brake Warning Light .....	2-60
Lap Belt .....	1-22	Parts Identification Label .....	6-67
Lap-Shoulder Belt .....	1-12	Publications, Ordering .....	8-8
Larger Children .....	1-33	Trans Filter Indicator Light .....	2-64
Questions and Answers .....	1-10	Work, Doing Your Own .....	6-3
Reminder Light .....	1-7, 2-55	Service and Appearance Care .....	6-1
Replacing After a Crash .....	1-36	Service and Owner Publications .....	8-8
Right Passenger Position .....	1-21	Sheet Metal Damage .....	6-64
Smaller Children and Babies .....	1-23	Signal-Stat Turn Signal .....	2-33, 5-4
Use During Pregnancy .....	1-21	Skidding .....	4-14
Why They Work .....	1-8	Specifications, Engine .....	6-74
Safety Defects, Reporting .....	8-6, 8-7	Speedometer .....	2-53
Safety Warnings and Symbols .....	iii	Starter Switch Check .....	7-25
Scheduled Maintenance .....	7-5	Starting Your Diesel Engine .....	2-10
Scheduled Maintenance Services .....	7-4	Starting Your Gasoline Engine .....	2-7
Seat Adjuster Check .....	7-26	Steam .....	5-18
Seatback Latches .....	1-3	Steering .....	4-9
Seats		Check .....	7-25
Bucket and Bench .....	1-2	In Emergencies .....	4-11
Chugger-Snubber Lock-Out .....	1-6	Power .....	4-9
Controls .....	1-2	Tips .....	4-10
Cushion Adjustment .....	1-5	Wheel, Tilt .....	2-31
Fore-and-Aft Adjustment .....	1-5		

Storage, Vehicle	6-42	Trailer Brake Hand Control Valve	2-39
Stuck: In Sand, Mud, Ice or Snow	5-37	Trailer Connections	2-49
Sun Visors	2-48	Transmission	
Surge Tank, Coolant	5-29	Automatic	2-20, 6-18
Surge Tank Pressure Cap	6-22	Automatic Transmission External Filter	6-19
Symbols, Vehicle	v	Double-Clutching	2-22
		Filters	6-77
<b>T</b> ape Player Care	3-12	Fluid, Automatic	6-18
Theft	2-5	Fluid Capacity	6-75
Thermostat	6-22	Manual	2-22, 6-19
Tilt Steering Wheel	2-31	Manual, Fluid	6-19
Tire Loading	6-48	Third Gear Hold	2-21
Tires	6-48	Using the Clutch	2-22
Changing a Flat	5-34	Automatic	6-18
Cleaning	6-64	Manual	6-19
Dual Tire Operation	6-50	TTY Users	8-3
Inflation	6-49	Turn and Lane Change Indicator	2-33
Inflation Check	7-23		
Loading	6-48	<b>U</b> nderbody Maintenance	6-65
Pressure	6-49		
Rims and Wheels	6-50	<b>V</b> ehicle	
Wheel Replacement	6-57	Control	4-6
When It's Time for New	6-51	Damage Warnings	iv
Top Strap	1-30	Identification Number	6-67
Torque, Wheel Nut	6-52, 6-74	Loading	4-28
Towing Your Vehicle	5-9	Storage	6-42
		Ventilation System	3-6
		Visors, Sun	2-48
		Voltmeter	2-56

<b>W</b> arning Devices . . . . .	5-4	Windshield Washer	
Warning Lights and Gages . . . . .	2-55	Fluid . . . . .	2-35
Warranty Information . . . . .	8-5	Fluid Level Check . . . . .	7-23
Washer Fluid, Windshield . . . . .	2-35, 6-29	Windshield Wipers . . . . .	2-35
Washing Your Vehicle . . . . .	6-63	Blade Cleaning . . . . .	6-62
Weatherstrips . . . . .	6-62	Blade Replacement . . . . .	6-43
Wheel		Fuses . . . . .	6-68
Alignment . . . . .	6-51	Low Speed Delay . . . . .	2-35
Nut Torque . . . . .	6-52, 6-74	Winter Driving . . . . .	4-24
Replacement . . . . .	6-57	Wiper Blade Check . . . . .	7-24
Tightening the Wheel Nuts . . . . .	6-52	Wiring, Headlamp . . . . .	6-68
Windows . . . . .	2-30		
Manual . . . . .	2-30		
Power . . . . .	2-31		