

SERVICE STANDARDS



CenterPoint[™]
Energy

Always There.

4-12-2021 Revision of the CNP Service Standards Book – (Effective Date 5-10-2021)

1. ******* Global renumbering of all Illustrations 1 thru 41 *******
2. **Section 204 – Change in Customer’s Wiring Installation - (Page 15)**
Revised paragraph. Add: “rewire due to damage”, “Any rewire or” and “current edition of the CenterPoint Electric Service Standards.”
3. **Section 300 – Types of Services - (Page 20).**
Revised: 301 – Single Phase, 480V, remove 480/240V 2 Wire.
Revised: 303 – Three Phase, Revised Notes – Removed: Bullet, Revised: 3th Bullet
Revised : 303 – 480V, 3-Wire, Added last three(3) Bullets
4. **Article 403.3 – Clearances – (Page 24)**
Revised: “Service drop shall be located no closer than **3 ft.**” Revised: “**5 ft.** to doors, porches, or similar locations”. Changes to align with NESC/NEC.
5. **Article 403 – Clearances - Updated Illustration 4 - (Page 25).**
Added: Service Outlet Access dimensions . 4FT(TYP.)
6. **Article 403.8 – Clearances – New Article (Page 29).**
Service Outlet Access requires sufficient workspace for the safe use of non-self-supporting ladders (i.e. extension/straight ladders). *When a ladder is leaned against a wall, the bottom of the ladder should be one-quarter of the ladder’s working length away from the wall.*
7. **Article 405.1 – Residential Service Outlet Rack – (Page 31).**
Updated Illustration 10. Increase height of Service Outlets above the Service Drop attachment.
8. **Article 408 – Service Entrance Conductors - (Page 34).**
Revised paragraph: “are extended from the customer’s conduit/raceway into a Meter Mounting Device above the level of uninsulated live parts, listed weatherproof fittings shall be required per NEC Article 312.2”. Added: “Service Entrance Conductors must be continuous from the Point of Delivery to the meter socket. Conductors shall not pass through any junction box or condulets, Etc.”
9. **Article 415 – Customer Installed Underground Conductors - (Page 41 and 42)**
Revised Illustration 15: Added Gas Meter Location. **Notes 1:** “the meter shall maintain a minimum 36” horizontal distance from a gas meter regulating vent and shall not be located above or below the vent.” **Note 7:** “Emergency Disconnects shall be installed outside the building with the breaker box installed either inside or outside the building”
10. **Article 416.3 – Cable Terminal Boxes – (Page 44)**
Revise paragraph. Add “the Customer is responsible for bonding the terminal box per NEC Table 250.102(C)(1).”
11. **Article 418 – Illustration 19A & 19B (Page 52)**
Revise Illustration 19A and 19B: Remove neutral jumper from 1-Phase 3-Wire Meter Cans.
12. **Article 419.1.2 – Self-Contained Meters Rated at 320 Ampere (Page 54).**
Revised title and paragraph. Removed: “more than 200”. Added: “ at 320”.
13. **Article 419.2 – Meter Mounting Devices – (Page 54)**
Revised paragraph. Add “Service Conductor extensions or taps(daisy chain) are prohibited from the original gutter.”
14. **Article 419.2 – Meter Mounting Devices – (Page 56)**
Revised Illustration 21- Acceptable Grounding Practice for Multi-Metering Installation.
Reduced Illustration to one Installation Practice.

15. **Article 419.4 – Meter Mounting Clearances – (Page 56)**
Revised Paragraph : “the meter shall maintain a minimum 36” horizontal distance from a gas meter regulating vent and shall not be located above or below the vent.”
16. **Article 419.5 – Service Cable Tap Box –Multi-Tenant Services - (Page 57 and 58).**
Revised Paragraph: Updated Service Conductor Designations. Added “Underground Service Conductor extensions or taps(daisy chain) are prohibited from the Tap Box”.
Added: “Customer is responsible for bonding the terminal box per NEC Table 250.102(C)(1).”
Revised Illustration 22A: Added Grounding Electrode and “Bonding per NEC Article 250.102”.
Revised Notes: #2 – Added “Underground” and removed “entrance”.
17. **Article 421 – Meter Location – (Page 59).**
421.2 - “the meter shall maintain a minimum 36” horizontal distance from a gas meter regulating vent and shall not be located above or below the vent”.
421.3 - Revised Paragraph: Changed from 7’ to 6’-7”.
18. **Article 502 – Service Drops – (Page 69)**
Update Illustration 26. Added: “Metallic/Schedule 40 PVC(or Greater) ” to 1-1/4” conduit on Notes: G) and H).
19. **Article 503.3 – Clearances for Service Drop – (Page 72)**
Revised Paragraph: “Service drop shall be located no closer than **3 ft.**” Revised: “**5 ft.** to doors, porches, or similar locations”. Changes to align with NESC/NEC.
20. **Article 507.2 – Anchorage for Service Drop: Open Wire Drop. – (Page 73,74 and 75).**
Added Illustration 29. Revised Paragraph: “when Service Entrance phase conductors do not exceed 2-500 KCMIL per phase, see Illustration 29”. **Update Illustration 30.** Added: “Metallic/Schedule 40 PVC(or Greater)” to 1-1/4” conduit on Notes: A) and C). Note D: Added “stranded”
21. **Article 508 – Service Entrance Conductors – (Page 76)**
Added: “**Service Entrance Conductors shall be continuous from the Point of Delivery to the CT box. Conductors shall not pass through any junction box or condulets, etc**”
22. **Article 513.2 – Instrument Transformer Installation – (Page 82 and 83)**
Update Illustration 34. Added: “Metallic/Schedule 40 PVC” to 1-1/4” Conduit to Notes: A) and C).
Article 513.3/513.4 – Metering Potential Transformer Box/Meter Can - Revised Paragraph. Added: “Metallic conduit, schedule 40 PVC conduit (or greater)” to 1-1/4” conduit. Added: “Flexible conduit is prohibited”.
23. **Article 513.5 – Indoor Mounted Current Transformer. – (Page 83).**
Revised Paragraph. Added: “The CT Can shall be installed between 24” to 48” inches from the bottom to finished grade as necessary clearance to install, remove and test equipment.”
24. **Article 513.9 – Service Mast Installation – (Page 89)**
Revised Paragraph: Added “metallic conduit or schedule 40 PVC conduit(or greater)”
25. **Article 513.11 – Meter Equipment Bonding - (Page 90).**
Revised Illustration 40. Revised Bullets: Added – “Coil 5Ft. for Company to make final connection to Bonding Lug”. Added: “Stranded Insulated”
26. **Article 514.1 – Methods of Installing Metering Equipment – (Page 91).**
Revised Paragraph: **6”** on top and bottom. Current transformer boxes shall be installed **24” to 48”** from the bottom to finished grade”

POWER LINE SAFETY

A foremost concern at CenterPoint Energy is the safety of our customers and employees. We exercise a great deal of care ensuring that our facilities are safe. But even with our many precautions, electrical contact accidents have occurred.

REMEMBER, ELECTRIC POWER LINES CAN KILL!

When you are working near power lines or moving tools and equipment (cranes, scaffolds, derricks, piping, etc.) near power lines, stay alert. The Texas Health and Safety Code, Chapter 752, prohibits all activities in which persons or equipment MAY come within six (6) feet of energized overhead high voltage power lines, and Federal Regulations, Title 29, Part 1919.180(i) and Part 1926.550(a)(15) and 1910.333 require a minimum clearance of ten (10) feet from power lines. These laws carry both criminal and civil liabilities. In addition, contractors and owners are legally responsible for the safety of construction workers under these laws. If you or your company must work near overhead power lines, contact us at the appropriate service center location (see page 5). We will help you arrange for the lines to be deenergized and/or moved. Make your work place a safe one, and remember to LOOK UP AND LIVE near overhead lines. For information on the above or on electrical safety programs, contact CenterPoint Energy's Public Safety Department as listed on page 5.

LAST REVISED 4-12-21

FOREWORD

Experience has shown that certain standard practices are necessary to assure every customer of CenterPoint Energy the best possible electric service. In compiling this **edition of Service Standards for the guidance of customers, contractors, electricians, architects, and engineers**, the basic purpose has been to keep them as simple and nonrestrictive as possible.

These Service Standards supplement and are subordinate to the terms and conditions for the delivery of electric service on file in the Company's offices. They are also intended to supplement and not to be in conflict with the current edition of the National Electrical Code, National Electrical Safety Code, or of any regulatory authority having jurisdiction.

MANY PROVISIONS IN THESE SERVICE STANDARDS DISCUSS THE COMPANY'S VIEWS, BASED ON APPLICABLE CODES AND ORDINANCES, CONCERNING THE MANNER IN WHICH CUSTOMER WIRING AND EQUIPMENT SHOULD BE INSTALLED AND MAINTAINED BY THE CUSTOMER. IN EXPRESSING THESE VIEWS, THE COMPANY DOES NOT INTEND TO IMPLY THAT IT WILL INSPECT CUSTOMER WIRING AND EQUIPMENT TO ENSURE CONFORMITY WITH THESE VIEWS. THE CUSTOMER IS SOLELY RESPONSIBLE FOR INSTALLING, INSPECTING AND MAINTAINING ALL CUSTOMER WIRING AND EQUIPMENT.

The updated Service Standards are located on the CenterPoint Energy website at <http://www.centerpointenergy.com/en-us/documents/service-standards.pdf>

Paper copies will only be provided upon request.

For service connection issues, please refer to the Turn Down/Unexecutable Codes located on the CenterPoint Energy website at <http://www.centerpointenergy.com/en-us/Documents/TURN-DOWN-CODES.pdf>

In the text, the substantial changes from the previous issue of the Service Standards have been marked, as this paragraph is, with a vertical line in the left margin.

COMPANY OFFICES

Customers should contact the nearest Company Office or Service Center listed below regarding information referred to in the Service Standards. Meter boxes required for transformer rated installations and service anchorage bolts may be obtained from any of the Company service centers. Location maps of the Service Centers may be found starting on page 93.

SERVICE CENTERS	ADDRESS	CITY, STATE ZIP	TELEPHONE NO.	Boundary Map
BAYTOWN	333 Ward Road	Baytown, TX 77520	(281) 425-7352	P. 93
BELLAIRE	4300 Bissonnet Blvd	Bellaire, TX 77401	(713) 945-4292 Ext. 3	P. 94
BRAZORIA	700 E. FM1462	Rosharon, TX 77583	(281) 595-6170	P. 95
CYPRESS	18018 Huffmeister	Cypress, TX 77429	(832) 773-6020	P. 96
FORT BEND	4011 Avenue H	Rosenberg, TX 77471	(281) 341-4904	P. 97
GALVESTON	502 27 th	Galveston, TX 77550	(409) 765-4165	P. 98
GREENSPPOINT	2301 Gears Road	Houston, TX 77067	(713) 945-4636	P. 99
HARRISBURG	3000 Harrisburg	Houston, TX. 77003	(713) 207-4558	P. 100
HUMBLE	10010 F.M. 1960 Rd. W	Humble, TX 77338	(713) 945-8936	P. 101
KATY	5431 Highway Blvd.	Katy, TX 77492	(281) 391-5104	P. 102
SOUTH HOUSTON (BLDG. F)	4700 South Shaver	Houston, TX 77034	(713) 945-6970	P. 103
SPRING BRANCH	3401 Brittmoore	Houston, TX 77043	(713) 945-4531	P. 104
SUGARLAND	13300 West Bellfort	Houston, TX 77099	(281) 561-2967	P. 105
COMPANY OFFICES				
CENTERPOINT TOWER	1111 Louisiana	Houston, TX 77002	(713) 207-1111	-
PUBLIC SAFETY	4700 South Shaver	Houston, TX 77034	(713) 945-6706	-

CONTENTS

	Page	
Power Line Safety	3	
<i>Foreword</i>	4	
<i>Company Offices</i>	5	
<i>Table of Contents</i>	6-8	
Section 100-Definitions	Page	Article
AMS Meter.....	9	101
Application for Service.....	9	102
Company	9	103
Connected Load..	9	104
Customer	9	105
Customer Extension.....	9	106
Customer's Installation	9	107
Customer's Service Equipment.....	9	108
Distribution Lines.....	9	109
Electric Service...	10	110
Harmonics	10	111
Manufactured Home.....	10	112
Meter	10	113
Meter Mounting Devices	10	114
Meter Box.....	10	115
Metering Current Transformer Box	10	116
Metering Potential Transformer Box.....	10	117
Meter Loop.....	10	118
Mobile Home.....	10	119
Modular Home	11	120
National Electrical Code.....	11	121
National Electrical Safety Code	11	122
Overhead Distribution Areas	11	123
Point of Delivery	11	124
Rate Schedule Classification	11	125
Retail Electric Provider (REP)	11	126
Service Cable Tap Box.....	11	127
Service Drop.....	11	128
Service Entrance Conductor	12	129
Service Lateral.....	12	130
Service Location.	12	131
Service Outlet.....	12	132
Service Outlet Location and Data Statement.	12	133
Transmission and/or Distribution Service Provider (TDSP)	12	134
Type of Service	12	135
Underground Distribution Areas	12	136
Underground Street Network Areas	12	137
Underground Radial Areas	13	138
Underground Residential Distribution Areas	13	139

Section 200 – General Information

Application for Service..... 14 201
Agreement for Service..... 15 202
Service Outlet Location and Data Statement 15 203
Change in Customer's Wiring Installation..... 15 204
Change in Location of Existing Service Facilities..... 15 205
Attachments to Company's Property 15 206
Customer Wiring 16 207
Grounding..... 16 208
Utilization Voltage 17 209
Energizing of Customer's Service... 17 210
Responsibility for Customer's Installation..... 17 211
Motor Protection Devices 17 212
Customer Communication or Tone Systems 18 213
Antennas (Radio, Television, Communication, etc.)... 18 214
Customer-Owned Generation Equipment..... 18 215
Electrified Fences 19 216

Section 300 - Types of Service

Single-Phase 20 301
208/120 volt, 3-wire 20 301
240/120 volt, 3-wire 20 301
480 volt, 3-wire 20 301
7,200 or 19,920 volt, 2-wire 20 301
Two-Phase 20 302
12,470/7,200 volt, 3-wire 20 302
34,500/19,920 volt, 3-wire 20 302
Three-Phase 20 303
208Y/120 volt network, 4-wire 20 303
208Y/120 Volt, 4-wire..... 20 303
240/120 volt, 4-wire, delta 20 303
480 volt, 3-wire 20 303
480Y/277 volt, 4-wire 20 303
2,400 volt, 3-wire, delta.... 20 303
4,160Y/2,400 volt, 4-wire 20 303
12,470Y/7,200 volt, 4-wire 20 303
34,500Y/19,920 volt, 4 wire 20 303

**SECTION 400 - RESIDENTIAL AND SMALL COMERCIAL
SELF-CONTAINED METER SERVICE INSTALLATIONS**

General Information 21 400
Services 21 401
Overhead Service 21 402
Service Drop..... 22 402
Clearances 24 403
Location of Service Outlet 29 404
Grouping Service Outlets 30 405
Point of Attachment..... 32 406
Anchorage for Service Drop..... 33 407
Service Entrance Conductors..... 34 408
Transformer Installations on Customer's Premises..... 35 409
Temporary Installations.... 35 410
Underground Service..... 35 411

Commercial Underground	35	411
Mobile Home Parks.....	35	412
Underground Service Laterals in Overhead Areas	36	413
Underground Service in Underground Residential Areas	40	414
Customer Installed Underground Conductors	40	415
Service to Apartments, Townhomes or Condominiums.....	44	416
Meter Loops	47	417
Meter Installations.....	48	418
Methods of Installing Meter Mounting Devices.....	53	419
Height of Meters.	58	420
Meter Location	59	421
Meter Pole Installations.....	61	422
Meter Installation Sequence	62	423

**SECTION 500 - LARGE COMMERCIAL INSTRUMENT
TRANSFORMER RATED METER SERVICE INSTALLATIONS**

General Information	65	500
Services	67	501
Overhead Service	67	502
Service Drop.....	68	502
Clearance for Service Drop	71	503
Location of Service Outlets	72	504
Grouping Service Outlets	72	505
Point of Attachment.....	73	506
Anchorage for Service Drop.....	73	507
Service Entrance Conductors.....	75	508
Transformer Installation on Customer's Premises	75	509
Temporary Installations.....	75	510
Underground Service.....	76	511
Commercial Underground	76	511
Underground Service Laterals in Overhead Areas	76	512
Meter Installations.....	80	513
Methods of Installing Meter Equipment.....	90	514
Meter Location	91	515
Meter Seals.....	91	516
Meter Installation Sequence	92	517

Service Center Boundaries

93-105

Lone Star Notification Center.....

106

SERVICE STANDARDS

CENTERPOINT ENERGY

SECTION 100-DEFINITIONS

- 100** The following is a list of terms and definitions used in this manual.
- 101** **AMS Meter:** Advanced Metering System or Smart Meter used for both residential and commercial services to measure the electric power and energy supplied to a customer.
- 102** **Application for Service:** The agreement or contract between the Company and the Customer under which Electric Service is supplied and taken.
- 103** **Company:** CenterPoint Energy
- 104** **Connected Load:** The combined manufacturer's rated capacity of all motors and other electric powered devices on the Customer's premises, which may, at the will of the Customer, be operated.
- 105** **Customer:** Any individual, partnership, association, firm, public or private corporation, or governmental agency now being served or hereafter to be served, using the Electric Service of the Company at any specified location.
- 106** **Customer Extension:** Any addition to the Company's existing distribution facilities required to render Electric Service to a Customer.
- 107** **Customer's Installation:** All wiring, appliances, or apparatus of any kind owned or operated by the Customer on the Customer's side of the Point of Delivery used in connection with the Customer's ability to take and use the Electric Service of the Company.
- 108** **Customer's Service Equipment:** The necessary equipment and accessories, located near the point of entrance of supply conductors to a building, which constitute the main control and means of disconnecting the supply to that building. This equipment usually consists of a circuit breaker or a switch and fuses.
- 109** **Distribution Lines:** The Company's lines located along streets, alleys, highways, or easements on private property when used or intended for use for general distribution of Electric Service to Customers of the Company.

- 110 Electric Service:** The availability of electric power and energy, regardless of whether any electric power and energy is actually used. The supplying of Electric Service by the Company consists of maintaining the approximate voltage, phase, and frequency agreed upon, at the Point of Delivery by means of facilities adequate for carrying the load which the Company is thereby obligated to supply by reason of the known requirements.
- 111 Harmonics:** Integer multiples of the fundamental power system frequency (sixty cycles per second), which have a negative effect on the power system. Harmonics are generated by the non-continuous manner in which electronically controlled (non-linear) equipment draws current. See Article 500.1 and 500.2.
- 112 Manufactured Home:** Built on a non-removable chassis (Federal Construction Safety Standards Act (HUD/CODE) requirement) and designed to be used as a dwelling, with or without a permanent foundation, when connected to required utilities. Mobile Homes are defined as manufactured homes in HUD regulations and the NEC Code also includes mobile homes in their definition of manufactured homes.
- 113 Meter:** An instrument, or instruments, together with auxiliary equipment, for measuring the electric power and energy supplied to a Customer.
- 114 Meter Mounting Devices:** The devices owned and furnished by the Customer for mounting and/or enclosing the Company's self-contained Metering Equipment.
- 115 Meter Box:** A metal box furnished by the Company and installed by the Customer at the Customer's expense to house transformer rated meters.
- 116 Metering Current Transformer Box:** A metal box furnished by the Company and installed by the Customer at the Customer's expense, for enclosing the Company's metering current transformers where required.
- 117 Metering Potential Transformer Box:** A metal box furnished by the Company and installed by the Customer at the Customer's expense, for enclosing the Company's metering potential transformers where required.
- 118 Meter Loop:** The opening in and extension of the Customer's Service Entrance Conductors provided for installation of the Company's Meter.
- 119 Mobile Home:** A factory assembled structure or structures transportable in one or more sections that is built on a permanent chassis (integrated frame and axles) and designed to be used as a dwelling without a permanent foundation where connected to the required utilities. The metal frame that the house is hauled on is also the structural floor support of the home and stays as part of the home after installation. The term Mobile Home includes manufactured homes. The requirements in the

NEC treat mobile and manufactured homes the same unless specifically stated otherwise.

- 120 Modular Home:** Designed, engineered and built in a factory-controlled environment and then carried in sections by special trucks to a building site where they are put together by a builder on a permanent foundation, similar to regular home construction. Unlike mobile homes, modular homes do not have integrated frames and axles. For the purposes of these Service Standards, CenterPoint_Energy will treat Modular Homes and Developer/Contractor Built Homes the same.
- 121 National Electrical Code:** The current edition of the National Electrical Code (ANSI/NFPA-70) as published by the National Fire Protection Association.
- 122 National Electrical Safety Code:** The current edition of the National Electrical Safety Code (ANSI C2) as issued by the Secretariat (IEEE) of the ANSI C2 Committee.
- 123 Overhead Distribution Areas:** The area or areas served by the Company's overhead distribution system as differentiated from the underground system.
- 124 Point of Delivery:** The point where the electric energy first leaves the line or apparatus owned by the Company and enters the line or apparatus owned by the Customer, unless otherwise specified in the Customer's Agreement for Service. This is not necessarily the point of location of the Company's Meter.
- 125 Rate Schedule Classification:** The classification of the Customer's Electric Service, the amount of electric power supplied, the rate area and the purpose for which the Electric Service is to be used.
- 126 Retail Electric Provider (REP):** A person (or company) that sells electric energy to retail Customers in this state (Texas). As provided in PURA ¶ 31.002(17), a Retail Electric Provider may not own or operate generation assets. As provided in PURA ¶ 39.353(b), a Retail Electric Provider is not an Aggregator.
- 127 Service Cable Tap Box:** An enclosure designed with busbars for the purpose of terminating Service Conductors from the electric utility point of supply and for terminating Service Entrance Conductors to individual tenant services.
- 128 Service Drop:** The Overhead Service Conductors extending from the Company's Overhead Distribution System to the Customer's Service Entrance Conductors at the Point of Delivery.

- 129 Service Entrance Conductors:** The wires or bus bars provided by the Customer extending from the Customer's Service Equipment to the terminals of the Service Drop or Service Lateral.
- 130 Service Lateral:** The Underground Service conductors between the street and/or easement, including any risers at a pole or from transformers, and the first point of connection to the Service Entrance Conductors in a terminal box or Meter. (Underground Service conductors are owned and maintained by the Customer.)
- 131 Service Location:** Conductors on the utility side of the service point are not covered by the NEC. CenterPoint Energy (CNP) specifies the location of the service point. Service entrance conductors go from the Service Point through the meter socket to the Service Equipment (breakers, fuses or switches), CNP has equipment specifications and/or service requirements beyond the Code for meter sockets, metering cabinets, and metering compartments within switchgear, switchboards and panelboards. See Section 412 and 418.3 of these Service Standards for use of Self-Contained Meter Pedestals in mobile home parks.
- 132 Service Outlet:** The outside terminal portion of the Customer's Installation to which the Company's Service Drop is connected.
- 133 Service Outlet Location and Data Statement:** A written statement prepared by the CenterPoint Energy representative for the guidance of the Company and the REP, or his representative. This statement shows the estimated load to be served, the Type of Service which the Company proposes to make available, and the agreed location for the Customer's Service Outlet at the specific premises under consideration.
- 134 Transmission and/or Distribution Service Provider (TDSP):** An Entity that owns or operates for compensation in this state (Texas) equipment or Facilities to transmit and/or distribute electricity, and whose rates for Transmission Services, Distribution Services, or both is set by a Governmental Authority.
- 135 Type of Service:** The characteristics of Electrical Service described in terms of frequency, phase, nominal system voltage and number of wires.
- 136 Underground Distribution Areas:** Those areas where Electrical Service is supplied by the Company from its underground distribution facilities as described in Articles 135, 136, and 137.
- 137 Underground Street Network Areas:** Those areas designated by the Company where established 208Y/120 volt street secondary network systems are in operation.

- 138 Underground Radial Areas:** Those areas where Electric Service is supplied by the Company from its underground distribution facilities connected to a radial supply.
- 139 Underground Residential Distribution (URD) Areas:** Those residential areas where special contractual arrangements have been made for single-phase 240/120 Volt underground service to all Customers in a subdivision or specified area.

SECTION 200 - GENERAL INFORMATION

200 This section contains information on how to obtain service and outlines standards to be followed to ensure safe and reliable service. **Consequently, the Company reserves the right to refuse service to any installation not meeting these Standards.**

201 Application for Service

201.1 Requests for service or changes in service may be made by calling the CenterPoint Energy Customer Service Department at (713) 207-2222 or 1-800-332-7143 to verify address and obtain an ESI-ID. The Customer must then select and contact a certified Retail Electric Provider to make application for service. A list of approved retail energy providers can be found by calling 1-866-PWR-4TEX (1-866-797-4839), or on the internet at www.powertochoose.org. All requests for service or changes in service should be made as early as possible. Customers requesting either overhead or underground electric service may be required to grant permanent easements for these facilities. This easement document outlines specific obligations to keep the easement free from obstructions and appurtenances.

201.2 It will facilitate the prompt rendering of Electrical Service to new Customers or additional Electric Service to existing Customers if the following information is supplied to the Service Consultant during the early planning stages of the project.

- Exact Location of premises, including building's street address or lot and block number and name of subdivision, if building numbers or street names have not been established. **THE STREET ADDRESS, WHEN ESTABLISHED, SHALL BE DISPLAYED AND SHALL BE VISIBLE FROM THE STREET. IN ALL CASES, APARTMENT ADDRESSES ARE TO BE PLACED ON OR ADJACENT TO THE APARTMENT DOOR (NOT IN OR ON WINDOWS)**

- The Type of Service desired including voltage, phase or special requirements of the load.

- An Electrical Load Analysis. (General nature and estimated amount of load, such as lighting, motors, air conditioning and heating applications, including voltage, rating and number of Motors and other items to be used.)

- The approximate date the Customer's Installation will be ready for service.

- The name of the Electrical Contractor performing the installation.

- A site plan.

- A warranty deed, if easements are required.

202 Agreement for Service

The Company will supply to a Customer, at any specific premise, only one of the Types of Service listed in Section 300 of the Service Standards and such service will be covered by one agreement for service.

The Customer's Installation is to be so arranged that all Electric Service under one **agreement for service can be supplied at one Point of Delivery and measured by one meter.**

203 Service Outlet Location and Data Statement

Before work is started on the Customer's installation, the Customer or his Contractor shall secure from the Company a Service Outlet Location and Data Statement for guidance in making the installations. This statement will specify the service facility arrangement necessary to secure service connection, including the Type of Service which the Company proposes to make available and the specified location for the Customer's Service Outlet.

204 Change in Customer's Wiring Installation

When planning additions or alterations to the Customer's installation, the Customer shall notify the Company and their Retail Electric Provider since most building alterations or rewiring work will necessitate some change in the Company's facilities. The Customer or his Contractor shall not assume that a remodel, service increase or rewire due to damage will be served from the same Point of Delivery as the old service. Any rewire or additional wiring, shall comply with the current National Electrical Code, adopted code by the authority having jurisdiction and the current edition of the CenterPoint Electric Service Standards. In localities having electrical ordinances, approval by the city inspecting authority having jurisdiction will be required before the Company is permitted to reconnect the service.

205 Change in Location of Existing Service Facilities

The Company may require a Customer to pay the expense of change in the Point of Delivery, location of Service Drop, or location of Metering Equipment when such changes are requested by the Customer. Where a service pole or poles must be set to provide proper clearance around or over driveways, garages, trees, or other obstructions on the premises, a charge shall be made for each service pole required.

206 Attachments to Company's Property

The Company's street light standards, poles, wires, towers, structures, and other facilities are provided for the exclusive purpose of supplying Electric Service. Any non-authorized radio or television equipment or wires, ropes, signs, banners, etc., are prohibited from being attached to poles, wires, towers, or structures or located near enough to such facilities as to present a hazard. The Company reserves the rights to remove all such hazards without notice.

When the Company's poles with approved customer equipment attached need to be relocated or replaced, the Customer is responsible for relocating all of their equipment at their cost within 30 days of receipt of written notification.

207 Customer Wiring

- 207.1** The Customer's wiring installation should conform to the requirements of the National Electrical Code and the National Electrical Safety Code, State, Municipal requirements in force at the time the installation is made and the Company Service Standards as to Service Outlet Location, Service Drop, Meter Location and height, etc. Compliance with all such codes and requirements is the sole responsibility of the Customer for all Customer wiring and equipment. The Company does not inspect Customer wiring and equipment, and the supplying of Electric Service by the Company does not mean that Customer wiring and equipment has been inspected or approved by the Company.
- 207.2** Certain city ordinances prohibit the Company from supplying Electric Service to a Customer until a permit has been received by the Company from the proper City authority.
- 207.3** For the Customer's and Company's mutual safety, the Company reserves the right to decline to serve or continue to serve any installation that is declared by the Company or the proper authorities to be unsafe and a hazard. In all such cases, the Customer or a representative will be notified, wherever possible, and a reasonable period of time allowed for the correction of such unsafe condition. In no case, however, does the supplying of Electric Service by the Company indicate that the Company assumes any responsibility for the Customer's wiring or its safety or adequacy.
- 207.4** For the Company to supply electrical service, two or more separately metered services shall not be electrically connected to a common device on the load side of the service disconnects.

208 Grounding

- 208.1** To assure maximum safety, the Customer should provide an adequate and permanent grounding conductor attached to the neutral terminal of the main-line switch, or where a main-line switch is not required, the breaker box.
- 208.2** For all Service Entrance Conductors the grounded neutral conductor should be electrically continuous from the Service Outlet through the Meter Loop. The grounded conductor should be positively identified either by use of white insulation, white paint at terminals, or by other suitable methods.
- 208.3** The grounding conductor shall be sized and installed in accordance with Illustration 3 on Page 23 and the National Electrical Code.

209 Utilization Voltage

209.1 A clear understanding of utilization voltage is essential for optimum operation of utilization equipment. Utilization voltage is the voltage at the line terminals of the utilization equipment. It should not be confused with service voltage which is the voltage at the point where the electric systems of the supplier and user are connected, which is the Point of Delivery. Utilization voltage may vary with each location of utilization equipment. In practice the service voltage may differ from the nominal system voltage which is designated voltage class rather than a specific voltage.

209.2 It is recommended that the Customer install Transient Voltage Surge Suppression at the line terminals or receptacles for all critical equipment and sensitive electronic appliances. Transient Voltage Surge Suppressors should be UL 1449 listed and are readily available from electrical contractors and retail stores.

210 Energizing of Customer's Service

For the mutual protection of the Customer and the Company, only authorized employees of the Company are permitted to make and energize the connection between the Company's Service Drop and the Customer's Service Entrance conductors.

211 Responsibility for Customer's Installation

211.1 The Company will not perform any electric wiring on the Customer's premises other than the installation of its Service Drop and Metering Equipment, as described in this manual.

211.2 The Customer is solely responsible for any accidents, fires, or failures (including meter disconnect fuses) resulting from the condition and use of his wiring installation or equipment.

211.3 The Customer should check carefully to see that phase connections and rotation are correct when first starting motors and to see that three-phase motors are not "single-phasing."

211.4 Customers requiring service at voltages of 7,200 volts and above must provide at the Point of Delivery a Company-approved disconnecting means and proper overload and short-circuit protection. Customers shall submit plans in accordance with CenterPoint Energy Specification 600-007-231-458 to Electric Engineering for approval.

212 Motor Protection Devices

212.1 All motors need protective devices to safeguard the motors, the wiring, and the equipment they operate from damage that might be caused by overloading, short circuits, single-phasing, large fluctuations in voltage, etc.

212.2 The Company's Power System is designed to provide high speed reclosing of its protective devices following power interruptions resulting from lightning or other causes. In most instances these power interruptions will be of extremely short duration. The Company recommends that under-voltage motor protection be equipped with time delay devices to permit motors to ride through these short duration interruptions.

212.3 It is recommended that overcurrent protective devices be provided in each phase to afford some motor-running protection of three-phase, three-wire motors against "single-phasing" unless complete protection for single-phase operation is provided, such as a relay which will detect a "single-phasing" condition.

212.4 Protective devices of the kind described above are readily available through most electrical contractors. The Company will advise the Customer regarding the type required for any particular case.

213 Customer Communication or Tone Systems

Modulated carriers or pulsed carrier systems shall not be impressed upon the electric service conductors, furnished by the Company, for conveying intelligence, for control purposes or for signal purposes beyond the Customer's premises. In instances where carriers are impressed upon the Customer's privately-owned electric distribution system, the owner of such systems shall provide filters to isolate the carrier signals from the Company's facilities.

214 Antennas (Radio, Television, Communication, Etc.)

Customers are cautioned to check the location of power lines in the immediate vicinity where an antenna is to be installed and to remember the danger to life and property should any part of the antenna come into contact with a power line during inclement weather.

215 Customer-Owned Generation Equipment

215.1 Customer generation equipment may be installed and operated after application for such installation and operation has been received and approved by CenterPoint Energy. Customer generation equipment will be classified as either non-parallel or parallel generation.

215.2 Non-parallel generation equipment must operate separately from the Company's facilities. Examples include emergency power for homes, schools, hospitals, businesses, computer installations, and other utilities (water, wastewater, telephone, and gas). Non-parallel generation equipment will operate under specific terms and conditions as established in the latest revision of the CenterPoint Energy Specification 007-231-82.

- 215.3** Customers may operate generation equipment in parallel with the Company distribution system under specific terms and conditions as established in the latest revision of CenterPoint Energy specification 007-231-76.
- 215.4** Before Customer-owned generating equipment may be interconnected to the Company system, application must be made and approved. (See CenterPoint Energy specification 007-231-76.) For more information, contact the Service Consultant at the nearest Company Office. (See page 5)
- 215.5** Customers may not install or use any transfer switch on the high side (CenterPoint Energy side) of the meter or any transfer switch between the meter and the meter socket jaws.
- 215.6** Customer owned standby generators that are to be permanently installed, must be located on the load side (customer side) of the meter, behind a service entrance rated device that prevents tying the running generator into the CenterPoint Energy system, whether the CNP lines are hot or dead.
- 216** **Electrified Fences**
Use of the Company's electric service to energize fencing or to energize devices which simultaneously energize fencing is prohibited.

300 - TYPES OF SERVICE

SECTION 300 - TYPES OF SERVICE		
TYPE	OVERHEAD	UNDERGROUND
301 - SINGLE PHASE		
208/120 V 3-wire	<ul style="list-style-type: none"> Not Available 	<ul style="list-style-type: none"> Company option Underground Street Network only Spot locations with existing 208/120 V supply (Downtown Network) Less than 10 kVA All equipment must be for use at 208 V
240/120 V 3-wire	<ul style="list-style-type: none"> Standard Service Less than 334 kVA 	<ul style="list-style-type: none"> Company option Locations with existing 240/120 V supply Less than 250 kVA
480/240 V 3-wire	<ul style="list-style-type: none"> Governmental entities for lighting only Less than 50 kVA No paralleling of transformers allowed 	<ul style="list-style-type: none"> Governmental entities for lighting only Less than 50 kVA No paralleling of transformers allowed
7,200 or 19,920 2-wire	<ul style="list-style-type: none"> Company option More than 200 kVA, but less than 334 kVA In accordance with CenterPoint Energy Specification 600-007-231-458 	<ul style="list-style-type: none"> Not Available
302 - TWO PHASE		
12,470/7,200 3-wire OR 34,500/19,920 3-wire	<ul style="list-style-type: none"> Company option More than 200 kVA, but less than 334 kVA Load must be balanced between phases In accordance with CenterPoint Energy Specification 600-007-231-458 	<ul style="list-style-type: none"> Not Available
303 - THREE PHASE		
	<ul style="list-style-type: none"> Commercial and industrial customers with a total demand of at least 50 kVA or one 3-phase motor 3-hp or more Not generally available to residential customers For 3-phase, 3-wire service, customer must provide a fourth wire for equipment bonding and metering purposes, which shall run from the Point of Delivery to the Customer's service equipment and be sized in accordance with the National Electrical Code. 	
208Y/120 V 4-wire grd neutral	<ul style="list-style-type: none"> Standard Service Permanent Service only Balanced 3-phase load All equipment must be rated for use at 208 V All phase conductors must be the same size Single-phase load equally divided More than 75 kVA and maximum 300 kVA Secondary conductors more than 50 feet long require Company review to maintain required voltage 	<ul style="list-style-type: none"> Standard Service Permanent Service only Balanced 3-phase load All equipment must be rated for use at 208 V All phase conductors must be the same size Single-phase load equally divided <u>Pad Mounted Installation</u> <ul style="list-style-type: none"> More than 301 kVA and maximum 1000 kVA <u>Network Area (Company option)</u> <ul style="list-style-type: none"> More than 10 kVA Available in spot locations with existing 208Y/120 V
240/120 V, delta 4-wire grd neutral	<ul style="list-style-type: none"> Standard Service Max demand 70 kVA single-phase, 170 kVA three-phase (240 kVA total) Consult Company for service options. Phase wire permanently identified, power orange Secondary conductors more than 50 feet long require Company review to maintain required voltage 	<ul style="list-style-type: none"> Company Option Max demand 100 kVA single-phase, 250 kVA three-phase (350 kVA total) Consult Company for service options. Pad mounted transformer installation (Two URD)
480 V 3-wire	<ul style="list-style-type: none"> Company Option All phase conductors must be the same size More than 75 kVA and maximum 501 kVA Limited to one service per transformer bank Not grounded at the transformer 4th Wire required for bonding (See above) 	<ul style="list-style-type: none"> Company Option All phase conductors must be the same size More than 501 kVA and maximum 3000 kVA Limited to one service per transformer bank Not grounded at the transformer 4th Wire required for bonding (See above)
480Y/277 V 4-wire grd neutral	<ul style="list-style-type: none"> Standard Service All phase conductors must be the same size More than 75 kVA and maximum 501 kVA 	<ul style="list-style-type: none"> Standard Service All phase conductors must be the same size More than 501 kVA and maximum 3000 kVA
2,400 V 3-wire	<ul style="list-style-type: none"> Company option More than 150 kVA and maximum 501 kVA 	<ul style="list-style-type: none"> Company option 12 kV area only More than 501 kVA and maximum 5000 kVA
4,160Y/2,400 V 4-wire grd neutral	<ul style="list-style-type: none"> Company Option More than 150 kVA and maximum 501 kVA 	<ul style="list-style-type: none"> Company Option More than 501 kVA and maximum 5000 kVA
12,470Y/7,200 V 4-wire grd neutral	<ul style="list-style-type: none"> Company option More than 200 kVA In accordance with CenterPoint Energy Specification 600-007-231-458 	<ul style="list-style-type: none"> Company option More than 200 kVA In accordance with CenterPoint Energy Specification 600-007-231-458 Available in padmounted metering configuration
34,500Y/19,920 V 4-wire grd neutral	<ul style="list-style-type: none"> Company option More than 200 kVA In accordance with CenterPoint Energy Specification 600-007-231-458 	<ul style="list-style-type: none"> Company option Not available in dedicated 35kV underground system More than 200 kVA Available in padmounted metering configuration In accordance with CenterPoint Energy Specification 600-007-231-458

SECTION 400 - RESIDENTIAL AND SMALL COMMERCIAL SELF-CONTAINED METER SERVICE INSTALLATIONS

400 GENERAL INFORMATION

The Customer's wiring installation should conform to the requirements of the National Electrical Code and the National Electrical Safety Code, State, Municipal requirements in force at the time the installation is made and the Company Service Standards as to Service Outlet Location, Service Drop, Meter Location and height, etc. Compliance with all such codes and requirements is the sole responsibility of the Customer for all Customer wiring and equipment. The Company does not inspect Customer wiring and equipment, and the supplying of Electric Service by the Company does not mean that Customer wiring and equipment has been inspected or approved by the Company.

General requirements detailed in Section 200 governing service installations are available from the Company's Service Consultants in the area. Customers or customer's representative should contact the Service Consultants as early as possible to ensure that adequate time is allowed for the preparation of individual specifications, cost estimates, ordering equipment and acquiring easements, if required.

401 SERVICES

The Company will supply to a Customer, at each Point of Delivery, only one of the Types of Service listed in these Service Standards. The Customer's installation is to be so arranged that the Company can measure the power used by the Customer with one meter.

OVERHEAD SERVICE

402 SERVICE DROP

402.1 Requirements: The Company will install one Service Drop from the Company's Distribution Lines to the Customer's Service Outlet. For Service Entrance Conductors sized 200 Amperes or less, and Service Voltages of 240 volts, a twisted Service Drop will be used. (See Illustration 1 - Typical Residential Service Mast, page 22). Open wire type Service Drops must be used for 480 volt and 208 Volt services for conductor sizes larger than 4/0 aluminum. (See Illustration 2 - Typical Open Wire Service Mast, page 22) Where Service Outlets are grouped (See Article 405), the combined ampacity of all Service Outlets shall determine the type of Service Drop. (See Illustration 3 – Arrangement of Overhead Service Equipment, page 23)

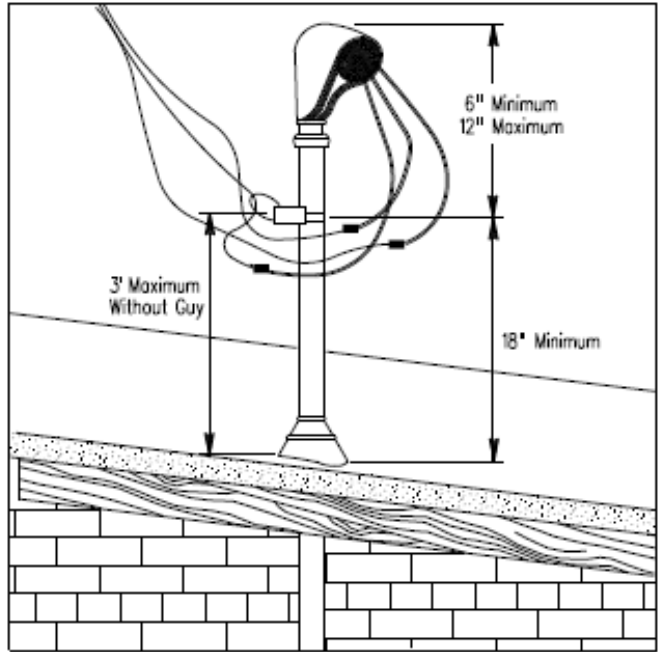

TYPICAL RESIDENTIAL SERVICE MAST
 (Article 406.2)
 Illustration 1

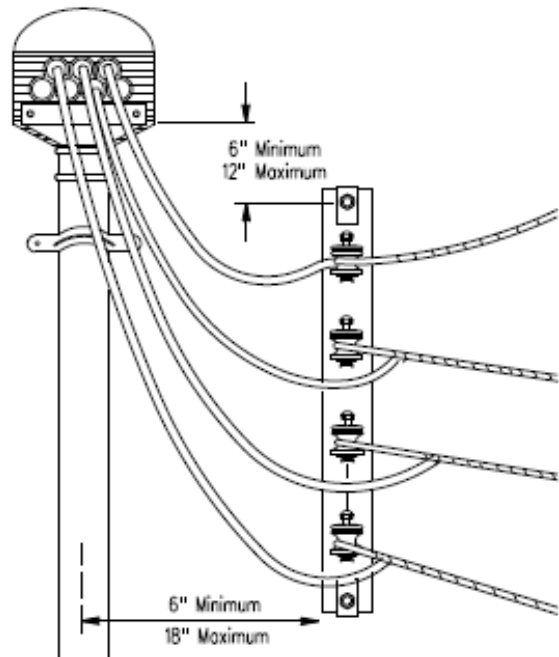

TYPICAL OPEN WIRE SERVICE MAST
 (Article 406 - 407.3)
 Illustration 2

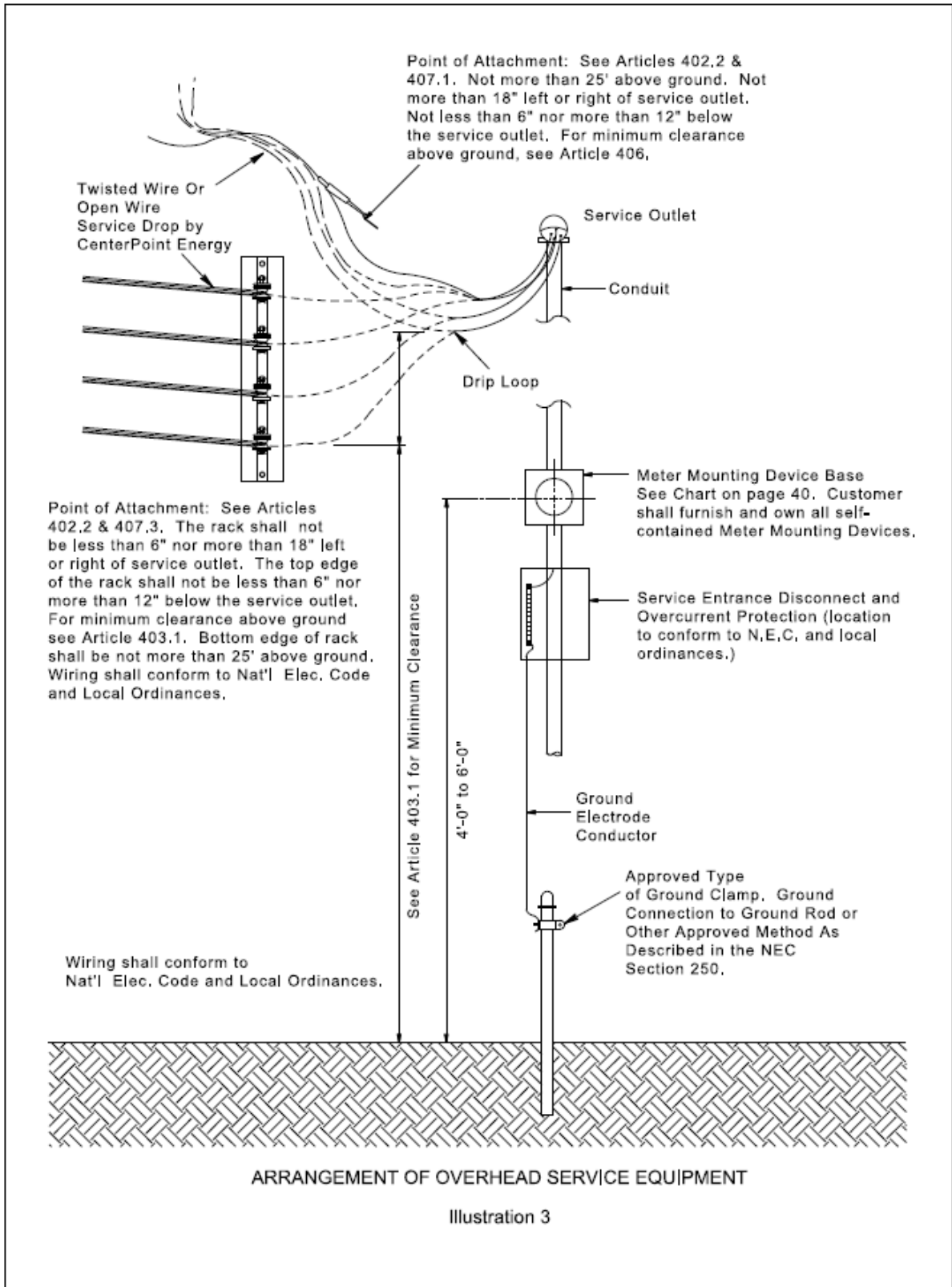

402.2 Service Drop Length: The maximum length of Service Drop which the Company will install will be governed by the amount and Type of Service and will be determined by Company personnel. Allowable voltage drop and mechanical factors, determined by the size and number of wires, impose limits on its length.

403 CLEARANCES

403.1 Service Drop Conductors, when not in excess of 600 volts, shall have the minimum clearances at the lowest point of the drip loop or service drop as required by Illustrations 4 and 5 - Clearances for Service Drop, pages 25 &26.

403.2 If an existing service is being modified and any revision in the service entrance raceway is made, the modified service must conform to the heights and clearances outlined in Illustrations 4 and 5 - Clearances for Service Drop, pages 25 & 26.

403.3 Service drop shall be located no closer than **3 ft.** to windows and **5 ft.** to doors, porches or similar locations from which the Service Outlet may be accessible. **This clearance is an NESC/NEC requirement and must be maintained.**

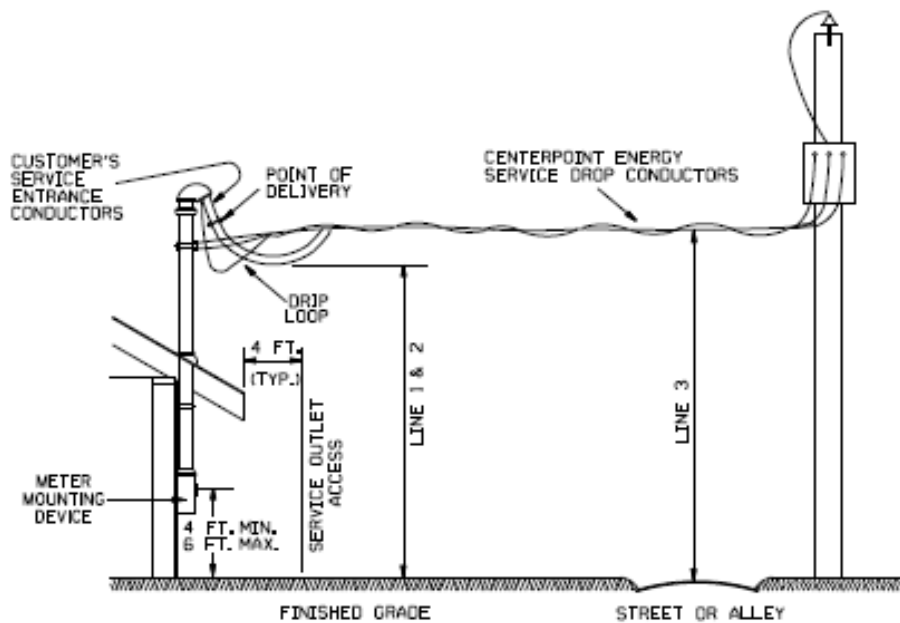

HORIZONTAL CLEARANCE

Service drop conductors attached to a building shall not pass closer than 3 ft. to windows and 5 ft. to doors, porches or similar locations from which the service outlet may be accessible.

VERTICAL CLEARANCE TO GROUND FOR SERVICE DROP CONDUCTORS

	TWIST SECONDARY WITH BARE NEUTRAL	SECONDARY CONDUCTOR	
		0-480Y/277V	480 V
1. Areas accessible to pedestrians, finished grade sidewalks, residential driveways or where truck traffic is not encountered. (Trucks shall be defined as any vehicle exceeding 8 ft. in height).	12 FT.	12 FT.	15 FT.
2. Over non-residential driveways, parking lots, alleys, or other areas subject to truck traffic.	18 FT.	18 FT.	
3. Over public streets and roads.	22 FT.	22 FT.	

EXCEPTIONS TO LINE (1)

Drip loops for 120/240 Volt, single phase, 3 wire twisted service with bare messenger shall have a 10 ft. minimum clearance from ground, if located at the electrical service entrance of the building.

- ① Twisted secondary with insulated neutral used in contaminated areas shall have the same clearance as secondary conductors 0-480v.

CLEARANCES FOR SERVICE DROP (ARTICLE 403)

ILLUSTRATION 4

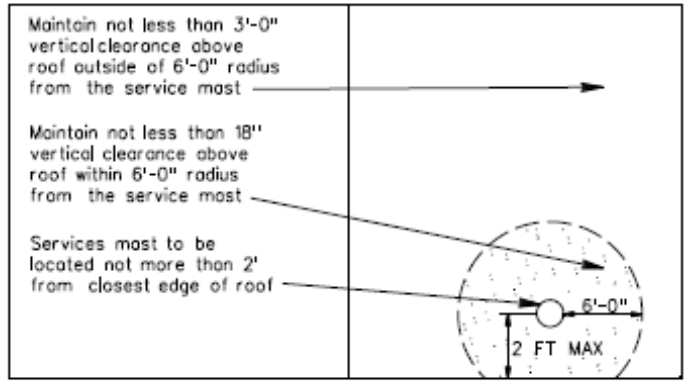

PLAN VIEW

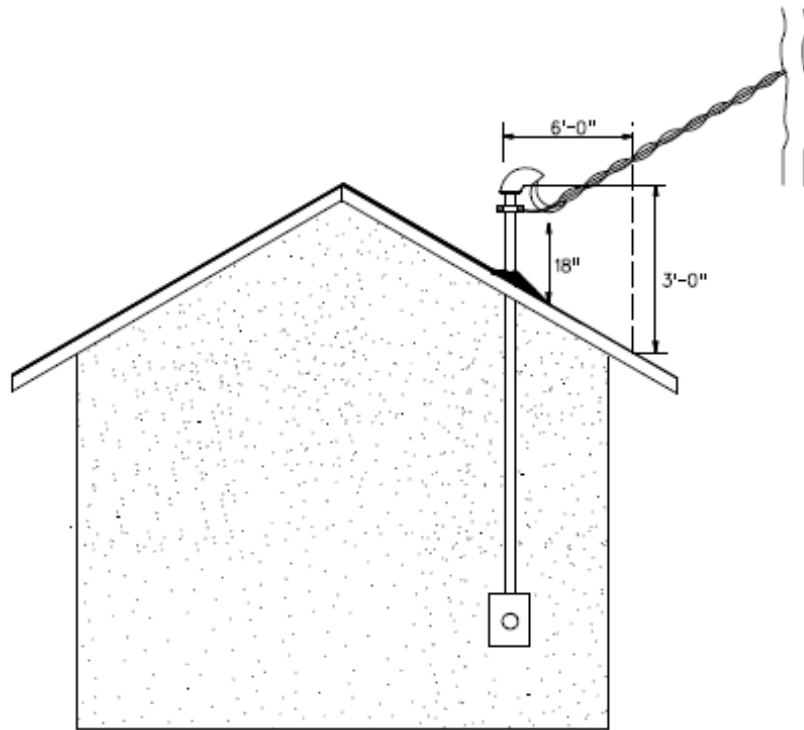

ELEVATION VIEW

CLEARANCE OF SERVICE DROP TERMINATING ON SUPPORT MAST

ILLUSTRATION 5

403.4 Clearance near or around swimming pools shall adhere to Illustration 6 - Clearances of Wires, Conductors or Cables Installed Around Swimming Areas (See below).

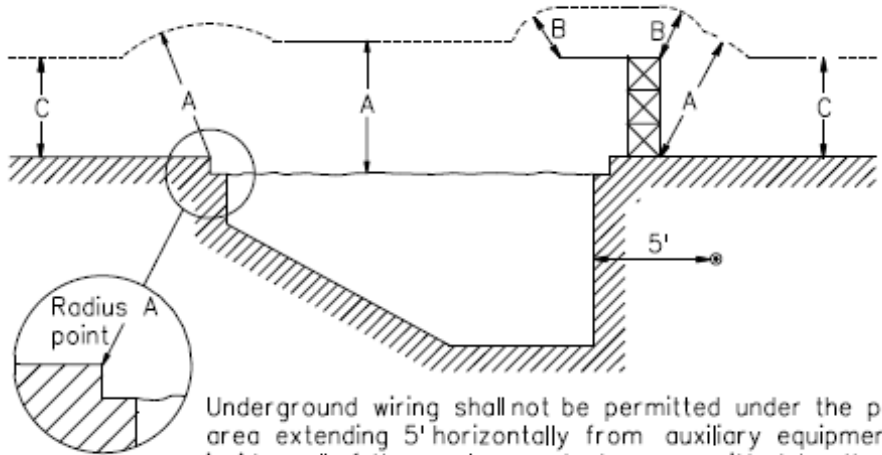

Underground wiring shall not be permitted under the pool or under the area extending 5' horizontally from auxiliary equipment or from the inside wall of the pool, except where permitted by the NESC latest edition.

TYPE CLEARANCE REQUIRED (See A, B, and C in above sketch)	OVERHEAD TWISTED SUPPLY, CONDUCTORS
A) Clearance in any direction from the water level edge of pool, base of diving board, or anchored raft.	22'-6"
B) Clearance in any direction to the diving platform or tower.	14'-6"
C) Vertical clearance over adjacent land.	Clearance shall be as required by OH Distribution Standard 05-100

- ① The above table does not apply to a pool fully enclosed by a solid or screened permanent structure.
- ② These clearances apply to all wires, cable or conductors within 10 ft horizontally of the edge of the swimming pool, diving platform or diving tower.
- ③ Greater clearance is required for twisted secondary with insulated neutral used in contaminated areas and open wire supply conductors.
- ④ Clearances stated above is on NESC requirement and must be maintained.

CLEARANCES OF WIRES, CONDUCTORS OR CABLES
INSTALLED AROUND SWIMMING AREAS

(Article 403.4)
Illustration 6

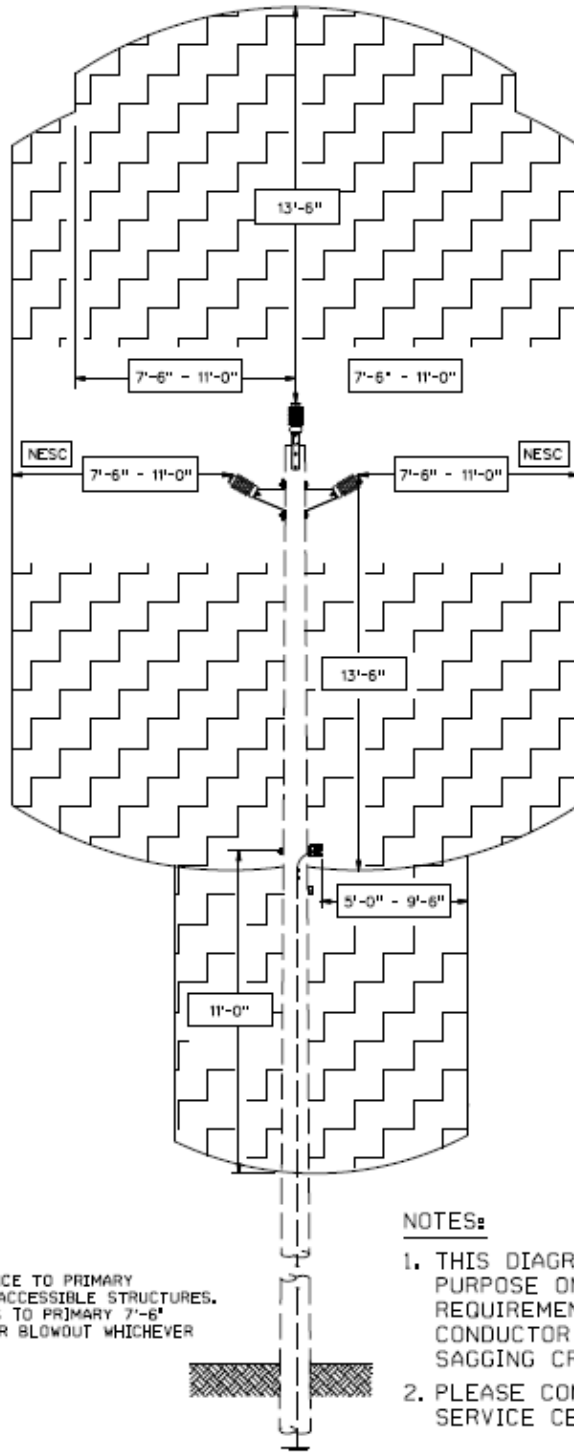

LEGEND:

 - NESC VERTICAL CLEARANCE TO PRIMARY 13'-6" ABOVE OR BELOW ACCESSIBLE STRUCTURES. HORIZONTAL CLEARANCES TO PRIMARY 7'-6" OR 4'-6" PLUS CONDUCTOR BLOWOUT WHICHEVER IS GREATER.

NOTES:

1. THIS DIAGRAM IS FOR ILLUSTRATION PURPOSE ONLY. EXACT NESC CLEARANCE REQUIREMENTS ARE BASED ON FRAMING, CONDUCTOR TYPE AND CONDUCTOR SAGGING CRITERIA.
2. PLEASE CONTACT THE NEAREST SERVICE CENTER IN YOUR AREA.

**CLEARANCE REQUIREMENTS FROM OVERHEAD LINES 50KV & BELOW
ILLUSTRATION 7**

403.5 Service Drops must be free of contact with trees. The customer shall trim all trees required to provide the necessary clearances. **Customer should not trim trees around primary lines.**

403.6 **Under no circumstances will the Company attach its Service Drop to an intermediate structure installed by the Customer between the Company's Distribution Lines and the Customer's Service Outlet.**

403.7 Where a service pole or poles must be set to provide proper clearance around or over driveways, garages, trees, or other obstructions on the premises, a charge shall be made for each such service pole required.

403.8 Service Outlet Access requires sufficient workspace for the safe use of non-self-supporting ladders (i.e. extension/straight ladders). *When a ladder is leaned against a wall, the bottom of the ladder should be one-quarter of the ladder's working length away from the wall.*

404 LOCATION OF SERVICE OUTLET

404.1 Located at a sufficient height above ground level to provide proper clearances for the Service Drop, as required by Illustration 4 - Clearances for Service Drop, page 25. For the twisted type Service Drop, the Service Outlet shall not be more than 18" horizontally, and not less than **6"** nor more than **12"** above the Point of Attachment see Illustration 3 - Arrangement of Overhead Service Equipment, on page 23).

For the open wire type Service Drop, the Service Outlet shall not be less than 6" nor more than **18"** horizontally and not less than **6"** nor more than **12"** above the Point of Attachment. (See Illustration 2 - Typical Open Wire Service Mast, on page 22).

404.2 Located so that the Company's Service Drop or the Customer's Service Entrance Conductors are not closer than **12"** to telephone or communication wires, whether in the air or on the building.

405 GROUPING SERVICE OUTLETS

If a building has an established Service Outlet location which conforms to the above requirements, then any additional Service Outlets shall be located within 18" of this established point (See Illustration 8 – Grouping of Service Outlets). **NO MORE THAN SIX WEATHERHEADS SHALL BE INSTALLED AT EACH SERVICE OUTLET LOCATION.** If the established location does not conform to these requirements, then all Service Outlets shall be combined at a satisfactory point specified by the Company. When the total cross-sectional area of all Service Entrance Conductors at a service outlet location exceed 2-1,000 KCMIL per phase, a bus bar type weatherhead must be used. See Illustration 9 – Typical Commercial Open Wire Service Installation (See below).

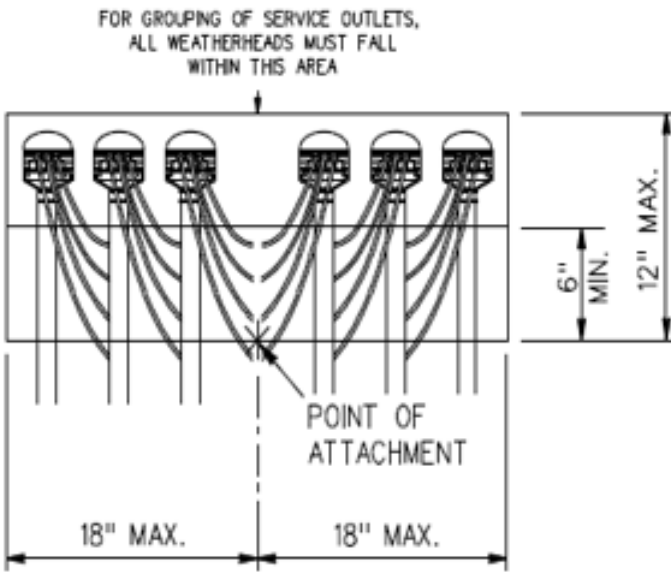

**GROUPING OF SERVICE OUTLETS
(Article 405)**

Illustration 8

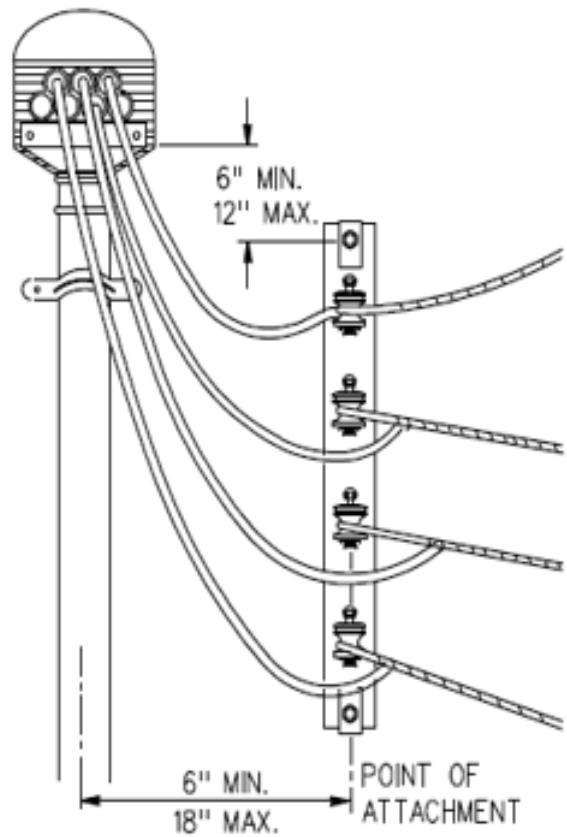

**TYPICAL COMMERCIAL OPEN WIRE
SERVICE INSTALLATION
(Article 405)**

Illustration 9

405.1 Residential (Townhomes) Service Outlet Rack: In townhome developments where service grouping is desired, a free-standing service outlet rack may be used (See Illustration 10, (below) & and 11, (next page).

Minimum Requirements

- 4" x 6" timber pressure treated with penta/creosote, 6" round pole or a steel pole of equivalent strength buried a minimum of 4'-0" and set in concrete
- Maximum six Service Outlets per rack
- 36" clearance area in front of rack
- Meter mounting 4'-0" to 6'-0" above finished grade
- 12'-0" minimum clearance to ground for Service Drop Conductors
- The rack must be capable of withstanding a pull of 300 lbs.
- The Point of Attachment must be a minimum 14'-0" above finished grade
- Customer shall not install any attachments to the rack including decorative lattice which may pose a hazard to Company personnel
- Maximum 200 Amp Service Outlet
- See Article 403, Clearances for Service Drop, Illustration 4, page 25

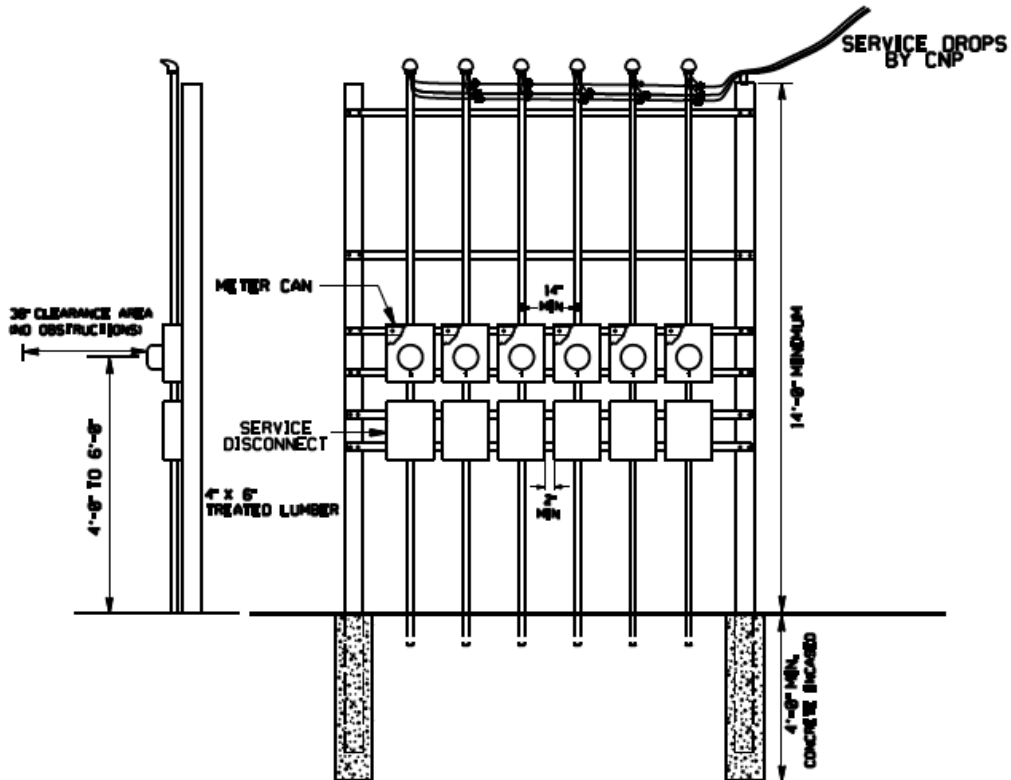

**SERVICE RACK
MINIMUM REQUIREMENT
ILLUSTRATION 10**

Alternate Design (Illustration 11)

- Customer to furnish conduit and cable to pedestal
- Conduit 2'-0" minimum depth
- Requires exclusive Company Easement
- Meter Rack placement outside of Company Easement.
- Contact Area Service Consultant for service requirements
- See Article 416 – Service to Apartments, Townhomes or Condominiums
- See Minimum requirements listed on the previous page.

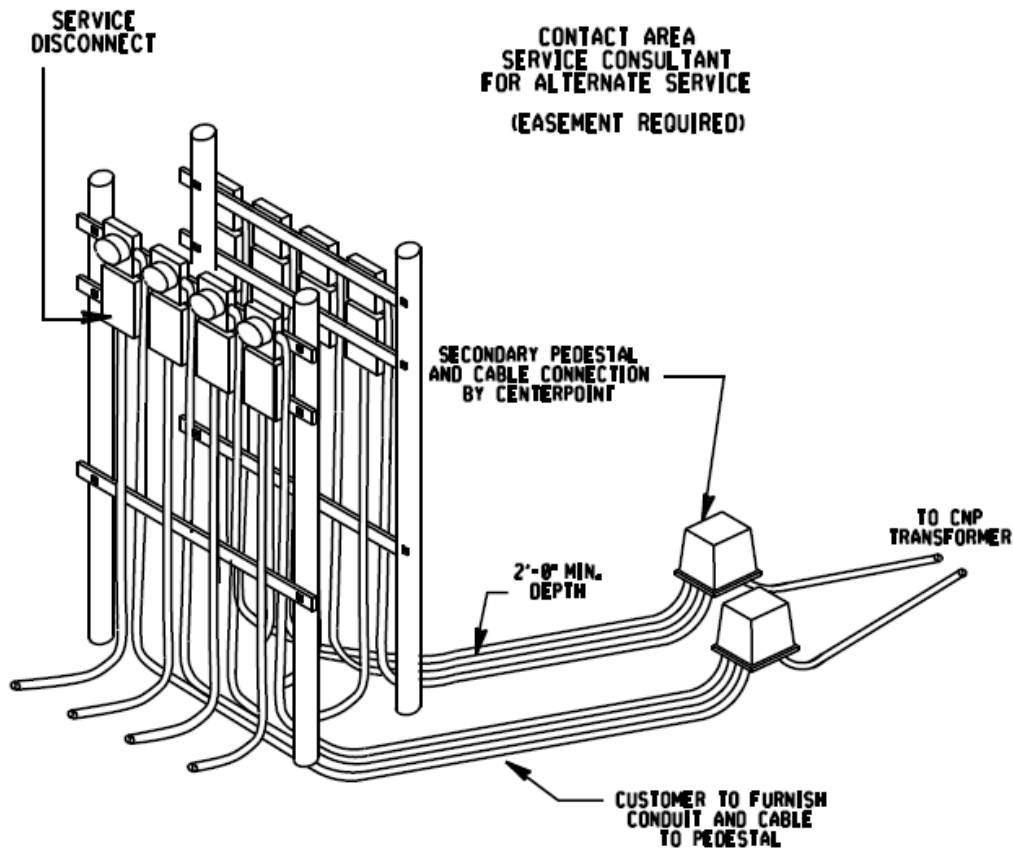

**SERVICE RACK-ALTERNATE DESIGN
ILLUSTRATION 11**

406 POINT OF ATTACHMENT

406.1 Provisions: A solid Point of Attachment for supporting the Service Drop on the building shall be provided by the Customer at a point which will comply with the provisions of ARTICLE 402. **The Point of Attachment shall not be more than 25 feet above ground, unless a greater height is required for proper clearance** (See Illustration 3 - Arrangement of Overhead Service Equipment, page 23).

Company personnel will specify on the Service Outlet Location, the height of the Point of Attachment if it must be less than the minimum or greater than **25 ft.** above grade.

406.2 Clearances: Where the required heights and clearances specified above cannot be maintained, the Customer shall provide an extension support, which is of a permanent nature and of sufficient strength to support the Service Drop at the required minimum clearance. In such cases, the Customer's Service Outlet is to be located above the service support at a height which will permit the required clearances. A typical service mast installation is shown in Illustration 1 - Typical Residential Service Mast, on page 22. In such an installation, **2"** or larger galvanized iron conduit, **2"** or larger intermediate metal conduit, or **3"** or larger rigid aluminum conduit shall be used. If a Service Mast will not have sufficient strength to properly support the Service Drop, installation of a service bracket will be required.

407 ANCHORAGE FOR SERVICE DROP

407.1 Installation: Where the building is of wood construction and permits use of a screw hook and the structure furnished by the Customer is capable of withstanding a pull of 300 lbs., the twisted Service Drop support will be furnished and installed by the Company. Where installation of a screw hook is not practical, the Customer shall install the Service Drop support in accordance with ARTICLE 407.2. Where an open wire Service Drop is to be used, the Customer shall install the Service Drop support in accordance with ARTICLE 407.3. The Type of Service Drop (twisted or open wire) to be installed shall be determined in accordance with ARTICLE 402. The service drop support must be installed as securely as possible to minimize damage to the installation from storms, falling branches, or other hazards.

407.2 Twisted Service Drop: For a twisted Service Drop, when impractical to use a screw hook, the Customer shall install one **5/8"** galvanized machine bolt of sufficient length for the threaded end of the bolt to extend 2" beyond the surface of the wall and so installed that it shall be capable of withstanding a pull of 300 lbs.

407.3 Open Wire Drop: For an open wire Service Drop, the Customer shall install a secondary rack fastened to his structure with two **5/8"** galvanized machine bolts of sufficient length for the threaded end of the bolt to extend 2" beyond the surface of the wall and so installed that each bolt will be capable of withstanding a pull of **300 lbs.** The bolts shall be installed vertically **16"** apart with the bottom bolt not less than **12' - 0"** nor higher than **23' - 4"** above ground level. When required ground clearance cannot be obtained otherwise, the Customer's Contractor shall secure written permission from the Company to install the bolts horizontally with the same spacing as for vertical installation. The Company will supply the bolts and rack when requested by the customer. See Illustration 2-Typical Open Wire Service Mast, page 22.

408 SERVICE ENTRANCE CONDUCTORS

The Service Entrance Conductors, as defined in ARTICLE 127 may be installed in schedule 40 or greater rigid non-metallic conduit, rigid metal conduit, electrical metallic tubing (EMT) or intermediate metal conduit except where subject to physical damage, such as near a parking area, driveway or gate. Only schedule 80 rigid non-metallic conduit, rigid metal conduit or intermediate metal conduit may **be used for the service entrance conduit where subject to physical damage** see Illustration 12- Arrangement of Meter Mounting Device (see below). Where Service Entrance Conductors are extended from the customer's conduit/raceway into a Meter Mounting Device above the level of uninsulated live parts, listed weatherproof fittings shall be required per NEC Article 312.2.

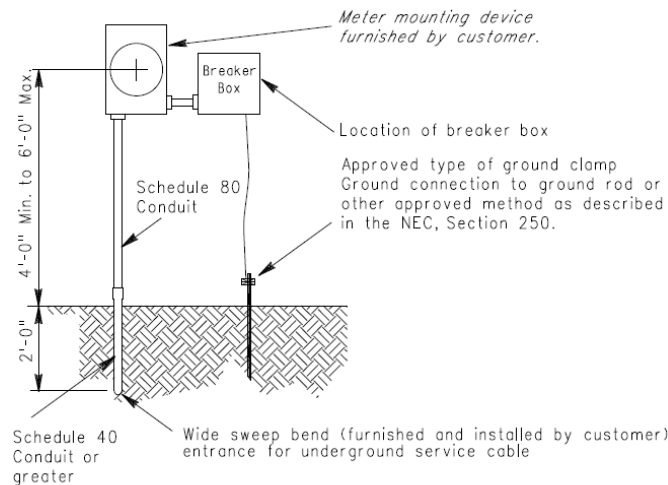

ARRANGEMENT OF METER MOUNTING DEVICE

Illustration 12

Except for service to internally located metering rooms, as approved by the Company's Electric Engineering Department, the service raceway shall not be run through attics, in partitions, or in other enclosed spaces. Service Entrance Conductors must be continuous from the Point of Delivery to the meter socket. Conductors shall not pass through any junction box or condulets, etc. In Addition, Service Entrance Conductors shall extend beyond the service entrance fitting a distance sufficient to permit connections to the Company's Service Drop, but in no case less than 18" where a twisted wire Service Drop is to be used or no less than 36" where an open wire Service Drop is to be used. (See ARTICLE 402). Except for multi-occupancy projects converting from master to multi-metering, Service Entrance Conductors shall not be installed in the same conduit or raceway with other wiring of the Customer, nor shall load wires from a meter be run in the same conduit or raceway with unmetered conductors. Customers contemplating the use of pre-wired/ganged type enclosures should consult the Company's Service Consultant in the area. Such installations require special contractual arrangements and submittal of detailed manufacturer's specifications for acceptance by Electric Engineering.

409 TRANSFORMER INSTALLATIONS ON CUSTOMER'S PREMISES

Under certain conditions, where large loads or considerable distances are encountered, it may be necessary to install transformers on the Customer's premises either overhead, or, at the Company's option and with special contractual arrangements, on the ground, or at the Company's option and with special contractual arrangements, in a transformer vault. Transformers or other Company equipment should be installed in areas readily accessible by Company vehicles for maintenance and replacement. Vehicular access shall not be blocked by permanent structures or landscaping. The requirements of such installations vary widely, and it is necessary in each case for the Customer to consult the Service Consultant in the area so that satisfactory arrangements may be made to cover the installation. This contact should be made in the planning stages or as early as possible to ensure that adequate time is allowed for ordering equipment and acquisition of easements.

410 TEMPORARY INSTALLATIONS

Where service is required for construction or other temporary purposes, the Customer shall provide a suitable location and anchorage for the Company's Service Drop and Meter. Temporary service will be installed at the Customer's expense. (See ARTICLE 422.2 for temporary Meter poles.) Temporary meter poles may not be placed within the utility easement. Meter mounting devices used in temporary installations shall be supplied by the Customer or his Contractor and shall meet the requirements listed under Article 418.2.

UNDERGROUND SERVICE

411 COMMERCIAL UNDERGROUND:

Commercial Customers desiring Underground Service should contact the Service Consultant in the area so that Electric Engineering may develop the Service Specifications as required.

412 MOBILE HOME PARKS:

Customers desiring underground service to mobile home parks utilizing self-contained Meter pedestals should contact the Company's Service Consultant in the area so that satisfactory arrangements can be made. Such installations generally require additional contractual arrangements. The Company shall make all connections between the Company's equipment, cables, or conductors and the Customer's Service Entrance Conductors. Consult the Company's Service Consultant in the area for charges for standby time of Company personnel during installation of service conductors by electrical contractors into three-phase pad-mounted transformers. Clearance near or around swimming pools shall adhere to the requirements listed in Illustration 6 - Clearances of Wires, Conductors or Cables installed around swimming areas, on page 27.

413 UNDERGROUND SERVICE LATERALS IN OVERHEAD AREAS

413.1 Requirements: It is necessary for Customers planning to install secondary underground service in Overhead Distribution Areas to consult the Service Consultant in the area to arrange for a Service Outlet Location and Data Statement as set forth in Article 203 and obtain the necessary Service Specifications for the installation. The Customer's underground riser conduit may be installed on CenterPoint Energy-poles where the pole is located on Customer's property or immediately adjacent in the street right-of-way or utility easement. No more than four (4) conductors per phase and neutral shall be accepted per metered service (no more than 16 conductors per pole total for all services).

Customer's conduit installed on poles shall be only rigid metal, intermediate metal, or PVC Schedule 80. When the underground service entrance conduit is PVC and the riser on the pole is rigid or intermediate metal conduit, the Customer or Customer's contractor shall ground all risers in accordance with requirements of the National Electrical Code.

Customer's service riser may be installed on a service pole if located on the Customer's property. Service poles will be provided ONLY if the standard service extension requires them. If service poles are not required for standard service extension, the Customer shall install and maintain a separate pole for the underground riser. **The maximum conduit riser attached directly to a pole shall not exceed one 3" conduit.** Larger conduit and multiple conduits may be installed on poles of sufficient strength, but they must be installed on stand-off brackets (See Illustration 13 – Conduit risers on stand-off brackets, next page). When the Company's poles with approved customer equipment attached need to be relocated or replaced, the customer is responsible for relocating all their equipment at their cost within 30 days of receipt of written notification.

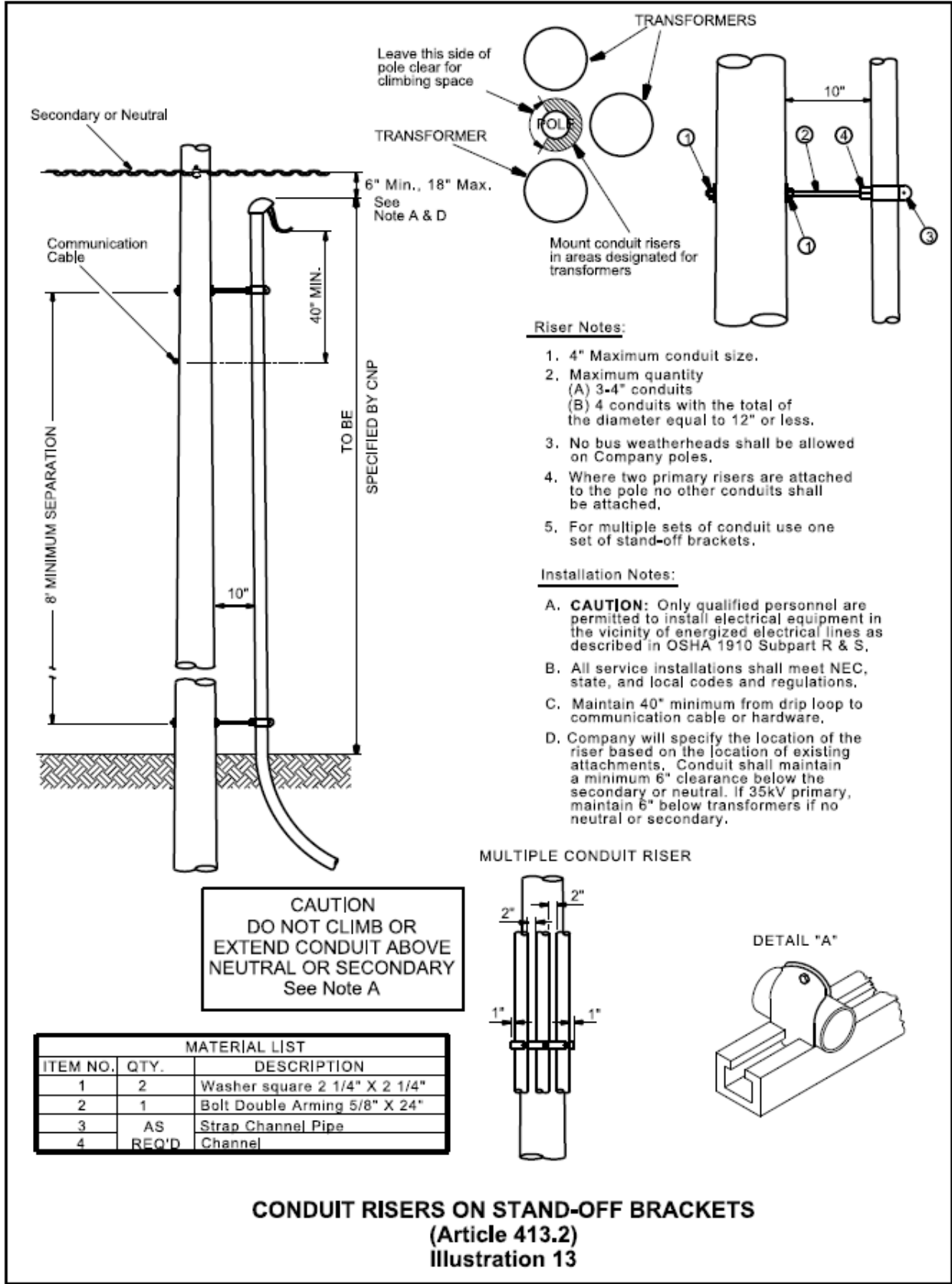

Leave this side of pole clear for climbing space

TRANSFORMER
6" Min., 18" Max.
See Note A & D

Mount conduit risers in areas designated for transformers

Riser Notes:

1. 4" Maximum conduit size.
2. Maximum quantity
(A) 3-4" conduits
(B) 4 conduits with the total of the diameter equal to 12" or less.
3. No bus weatherheads shall be allowed on Company poles.
4. Where two primary risers are attached to the pole no other conduits shall be attached.
5. For multiple sets of conduit use one set of stand-off brackets.

Installation Notes:

- A. **CAUTION:** Only qualified personnel are permitted to install electrical equipment in the vicinity of energized electrical lines as described in OSHA 1910 Subpart R & S.
- B. All service installations shall meet NEC, state, and local codes and regulations.
- C. Maintain 40" minimum from drip loop to communication cable or hardware.
- D. Company will specify the location of the riser based on the location of existing attachments. Conduit shall maintain a minimum 6" clearance below the secondary or neutral. If 35kV primary, maintain 6" below transformers if no neutral or secondary.

CAUTION
DO NOT CLIMB OR
EXTEND CONDUIT ABOVE
NEUTRAL OR SECONDARY
See Note A

MATERIAL LIST		
ITEM NO.	QTY.	DESCRIPTION
1	2	Washer square 2 1/4" X 2 1/4"
2	1	Bolt Double Arming 5/8" X 24"
3	AS	Strap Channel Pipe
4	REQ'D	Channel

MULTIPLE CONDUIT RISER

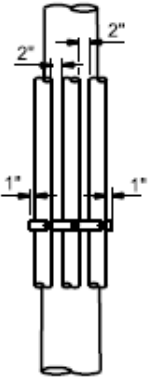

DETAIL "A"

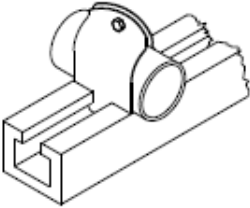

CONDUIT RISERS ON STAND-OFF BRACKETS
(Article 413.2)
Illustration 13

413.2 Service Conduit: Customer may attach service conduit not larger than 3" inside diameter directly to the pole. The Company's Service Consultant in the area will specify on the Service Outlet Location when the Customer must attach the service conduit directly to the pole, as in residential areas. Conduit risers shall be permitted in order of service requests as shown by the Illustration 14 - Conduit Risers Attached Directly to Pole, (next page). In the event a Company's primary riser is attached to the pole, the primary riser shall be considered the #1 Customer, and any further Customer service risers shall be installed on a stand-off bracket as #2, #3, or #4 riser on the pole. In the case where two primary risers are attached to the pole, no other conduit may be attached to the pole. See Illustration 14, (next page).

Customers must use standoff brackets for service conduit larger than 3" inside diameter. A maximum conduit size of 4" will be allowed. See Illustration 13 - Conduit Risers on Stand-off Brackets, for suggested installation, page 37.

CAUTION
 DO NOT CLIMB OR EXTEND
 CONDUIT ABOVE NEUTRAL
 OR SECONDARY
 See Note A

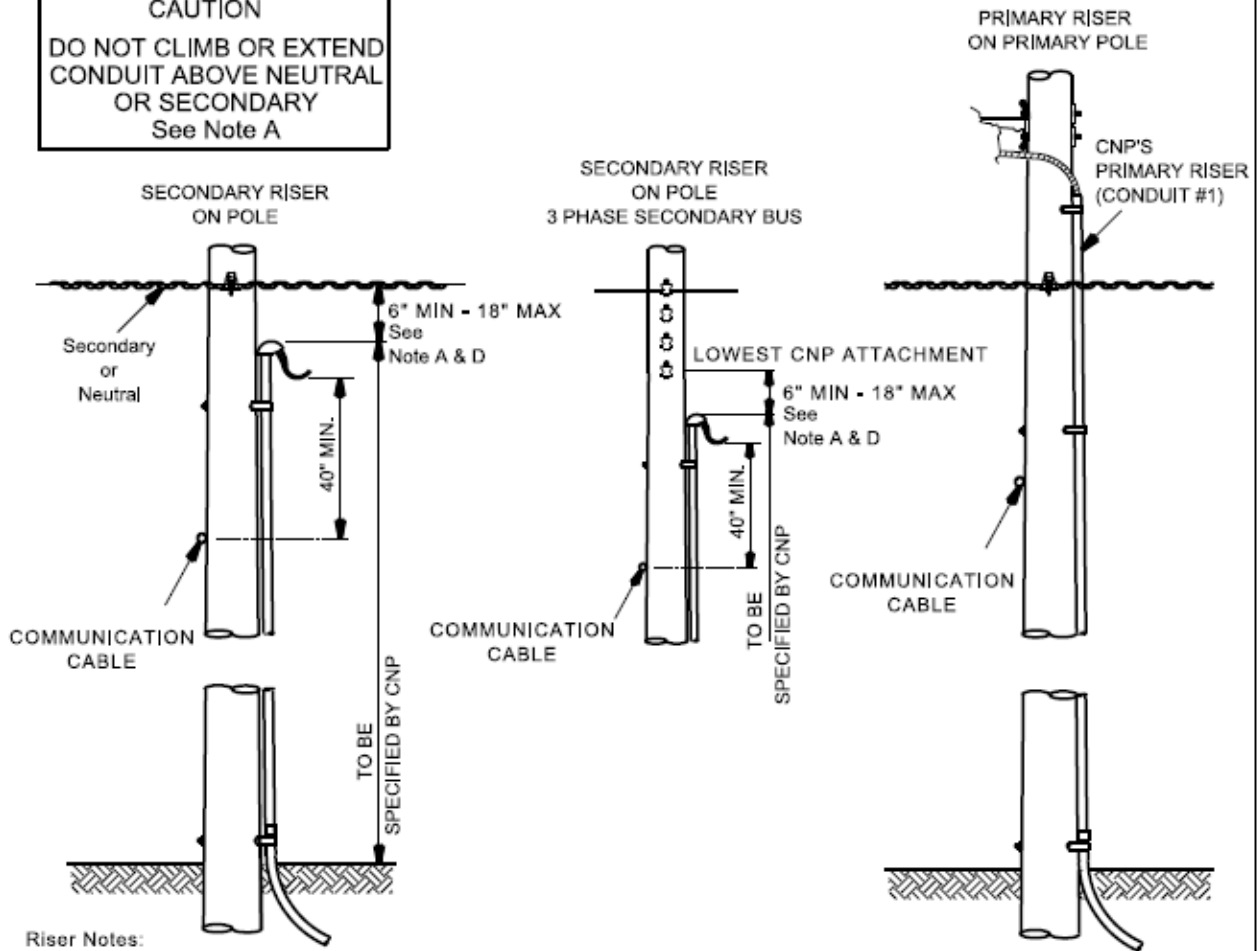

Riser Notes:

1. 1 - 3" Conduit Maximum
2. Treat existing CenterPoint Energy Primary Riser as conduit #1 in Detail "A", and Customer's Riser as conduits #2, #3, or #4.
3. Customer shall furnish all conductor and material to point of connection.
4. For multiple conduit installation see illustration 8.

Installation Notes:

- A. **CAUTION:** Only qualified personnel are permitted to install electrical equipment in the vicinity of energized electrical lines as described in OSHA 1910 Subpart R & S.
- B. All service installations shall meet NEC, state, and local codes and regulations.
- C. Maintain 40" minimum from drip loop to communication cable or hardware.
- D. Company will specify the location of the riser based on the location of existing attachments, Conduit shall maintain a minimum 6" clearance below the secondary or neutral. If 35kV primary, maintain 6" below transformers if no neutral or secondary.

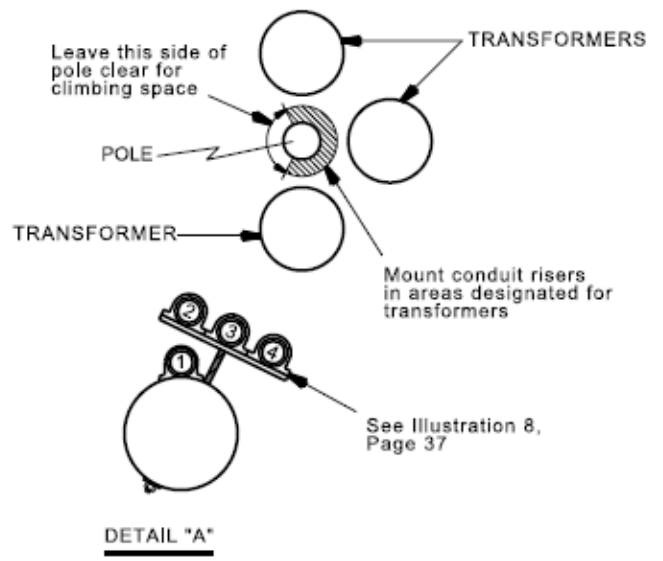

CONDUIT RISERS ATTACHED DIRECTLY TO POLE
 (Article 413.2)
 Illustration 14

413.3 Service Riser Protection: Customer may not install theft deterrents that pose a safety hazard to CNP personnel.

414 UNDERGROUND SERVICE IN UNDERGROUND RESIDENTIAL AREAS

414.1 Since Underground Residential Distribution (URD) areas are established by special contractual arrangements, special conditions for service may exist, and the Customer must request URD Service Specifications through the Company's Service Consultant in the area.

414.2 In the Underground Residential Distribution Area, the only type of service available to each Customer shall be the type known as single-phase 120/240 volt, three-wire, 60 hertz. This service is available to residential Customers only.

415 CUSTOMER INSTALLED UNDERGROUND CONDUCTORS

415.1 Requirements: In URD areas, the Customer or his Contractor shall furnish and install the service conductors (Service Lateral) in accordance with Illustration 15 - Arrangement of Residential Underground Equipment, (next page). The Company will make all connections between the Customer's service conductors (Service Lateral) and the Company's conductors and equipment.

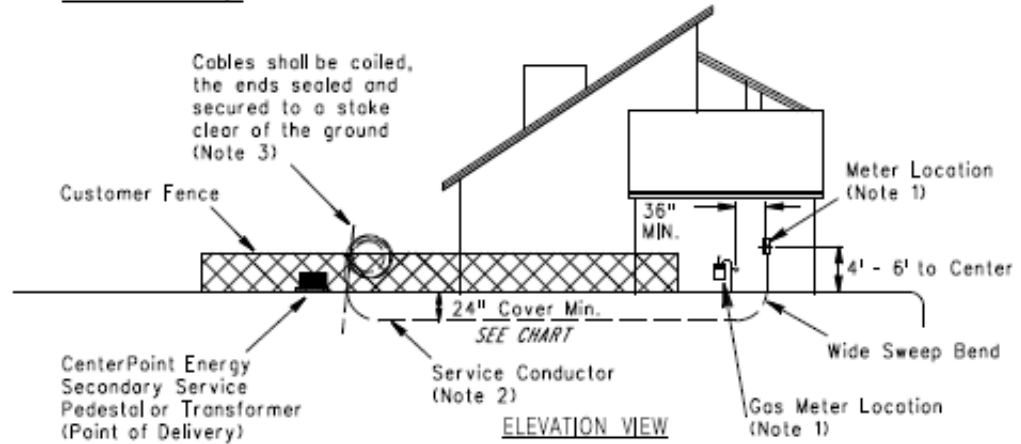
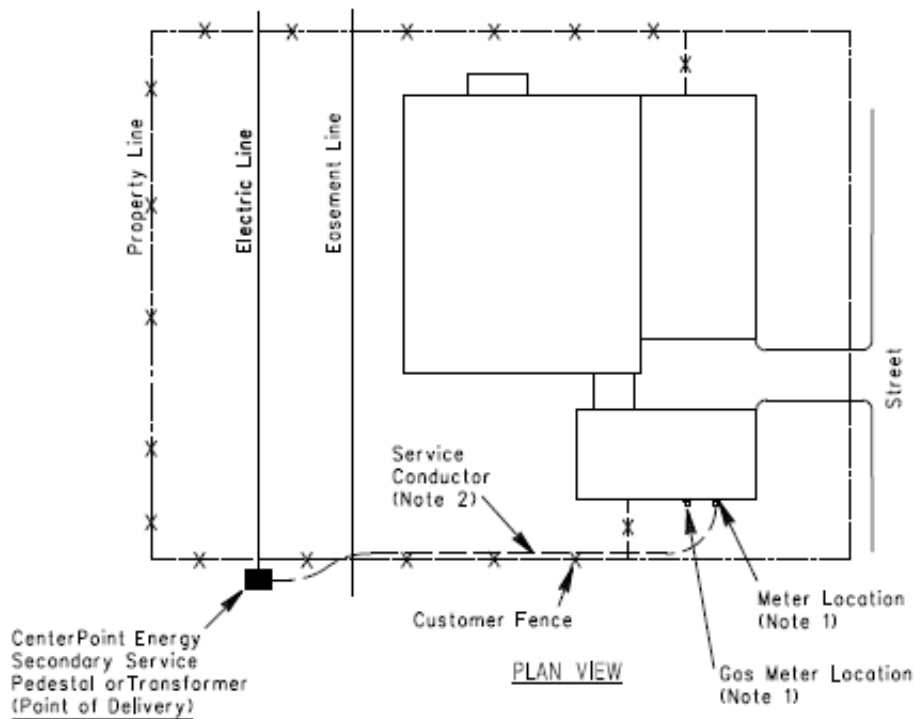

Minimum Cover for Underground Conductors:

Direct Buried Cable or Conduit shall be installed to meet the following minimum requirements:

Cover	Wiring Method
24 Inches	Over Direct Buried Cables.
6 Inches	Over Rigid Metal Conduit.
6 Inches	Over Intermediate Metal Conduit.
18 Inches	Over Rigid Nonmetallic Conduit approved for direct burial without concrete encasement.
18 Inches	Over other approved raceways.

* Wiring shall conform to the National Electric Code (latest revision) and local ordinances.

ARRANGEMENT OF RESIDENTIAL UNDERGROUND EQUIPMENT
(Article 415.1)
Illustration 15

NOTES: ARRANGEMENT OF RESIDENTIAL UNDERGROUND EQUIPMENT

1. Meter mounting device shall be furnished by the Customer and installed by the Customer or Customer's electrical contractor. Location should be on the side of the house or garage where accessibility, height, working clearance, etc. comply with Section 400 of the Service Standards. In addition, the meter shall maintain a minimum 36" horizontal distance from a gas meter regulating vent and shall not be located above or below the vent.
2. Customer's contractor shall furnish and install service to the following specifications:
 - A. Refer to ARTICLE 415 for conductor requirements.
 - B. Cable shall be installed a minimum of 2 ft. below grade if using direct burial cable. Bottom of trench and backfill immediately above cable shall be fine soil or sand, free of rocks, concrete, or hard objects which might damage cable. Aluminum and aluminum alloy cables require the utmost care in handling and installation, most installations are especially susceptible to nicks and scratches, and careless handling may result in failure of the cable.
3. Customer's contractor shall install service cable to within 1 ft. of secondary service hole or transformer pad. (Contractor shall contact the Company's Service Consultant in the area for proper location of service cable connections, if not apparently evident on ground.) Service brought to transformer pads shall be left opposite the small notched "V" mark on transformer pad. Ten (10) feet of service cable shall be left for connection to a secondary pedestal or transformer. The cable shall be coiled and secured to a stake as to be clear of the ground. Cut ends shall be made watertight by an approved sealing method immediately after cutting. Caution should be observed when digging within the area to avoid damage to telephone, other cables, and gas pipe coatings. Damage to any utility equipment shall be immediately reported to owner of utility. CenterPoint Energy will not be responsible for damage by persons other than its own personnel.
4. Temporary service poles shall be set outside the confines of the utility easement.
5. For temporary services only, the height of the meter mounting device on temporary meter poles in URD areas may be reduced below the requirements of ARTICLE 420, but in no event shall the center line of the meter mounting device be lower than 3 ft. above grade.
6. All services shall be properly grounded.
7. Emergency Disconnects shall be installed outside the building with the breaker box installed either inside or outside the building.
8. Construction in areas where electrical installations are governed by city ordinance shall meet requirements of all applicable ordinances and codes.
9. The service entrance conduit may be schedule 40 or greater rigid non-metallic conduit, electrical metallic tubing (EMT), rigid metal conduit, or intermediate metal conduit except where subject to physical damage, such as near a parking area, driveway, or gate. Only schedule 80 rigid non-metallic conduit, rigid metal conduit or intermediate metal conduit may be used for the service entrance conduit where subject to physical damage. (See Illustration 12 - Arrangement of Meter Mounting Device, page 34).

415.2 Service Conductors: Conductors shall be listed as “USE” rated and sized for load according to the National Electrical Code latest edition and shall be clearly marked as suitable for direct burial. Suitable conductor types are USE, THW, THHW, TW, RHW, THWN, and XHHW. Direct buried conductors shall be clearly marked as to type. Other conductor types require CenterPoint Energy approval. Conductors must be installed with at least 24" of cover. The bottom of the trench and backfill immediately above the conductors shall be of fine soil or sand, free of any hard objects which could damage conductors. Conductors in conduit shall be installed in accordance with the National Electrical Code latest edition or as approved by the local governing authorities.

415.3 Conductors in Conduit: Conduit shall be buried in accordance with the National Electrical Code latest edition, however, the conduit at the transformer or pedestal end of the run shall have at least 24" of cover. Cables installed in conduit shall be of types listed in ARTICLE 415.2. Service cables must be installed within 1 ft. of the secondary pedestal or transformer pad as shown in the Illustration #16 (see below).

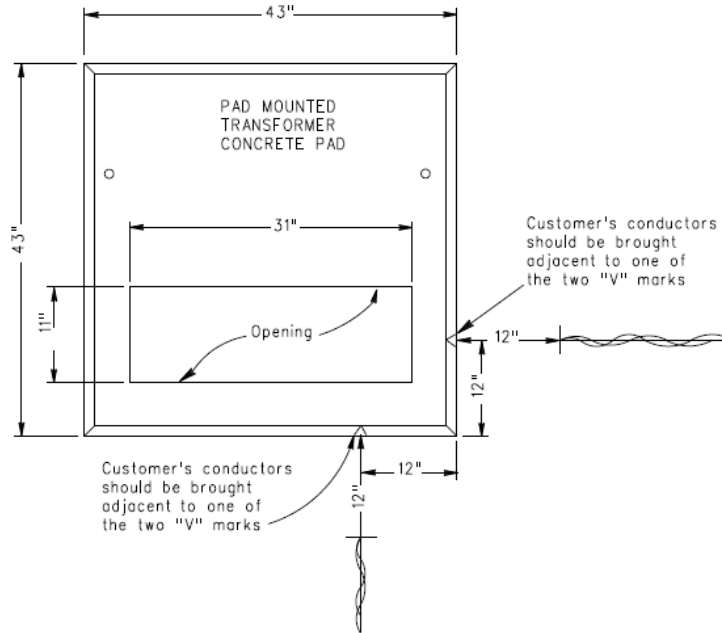

ARRANGEMENT OF SERVICE CONDUCTORS AT SINGLE-PHASE PAD-MOUNTED TRANSFORMERS

Illustration 16

415.4 Installation: Service cables brought to transformer pads shall be left adjacent to the small notch "V" in the transformer pad, (See Illustration 16) or adjacent to the secondary pedestal. The cable shall be coiled and secured to a stake so as to be clear of the ground. Cut ends must be made watertight by an approved sealing method immediately after cutting. Caution should be observed when digging within the area to avoid damage to other utility facilities. Damage to any utility equipment must be reported immediately to the owner of such equipment. (See Lone Star Notification Center, page 107).

415.5 Temporary Service (Underground): Temporary service for home construction within the URD area will be available only at designated locations adjacent to existing energized transformers or energized secondary cable junction boxes. The applicant for temporary service or contractor must install a temporary meter pole. Temporary meter poles may not be placed within the utility easement. A charge will be made for the temporary service. Meter mounting devices used for temporary service shall be supplied by the Customer or his Contractor and shall meet the requirements listed under ARTICLE 418.2.

415.6 Swimming Pools: Underground conductors in the proximity of a swimming pool or its auxiliary equipment must conform to the latest edition of National Electrical Code. See Illustration 6 - Clearance of Wires, Conductors or Cables installed around swimming areas, on page 27.

416 SERVICE TO APARTMENTS, TOWNHOMES OR CONDOMINIUMS

416.1 Requirements: The Company, by special contractual arrangements, will provide underground service to apartment complexes. This service will be single-phase, 120/240 Volt, 60 hertz and metered separately for each apartment unit. The Company's Service Consultant in the area should be contacted for contractual information and Service Specifications for the part of the electrical services facilities to be installed by the owner of the apartment complex.

416.2 Master-Metering: The apartment complexes that are served from master-metered distribution system may be converted to individual unit metering, if re-wiring is done to provide a separate electric service to each unit and special contractual arrangements are made with the Company. Before making conversion plans the owner should contact the Company's Service Consultant in the area for the Terms and Conditions for converting a master-metered system to a multi-metered system.

416.3 Cable Terminal Boxes: Whenever more than four sets of Service Entrance Conductors (maximum of 4 sets of 350 KCMIL conductors) are to be served from a Company-owned pad-mounted transformer, services shall be supplied from a cable terminal box. In addition, the Customer is responsible for bonding the terminal box per NEC Table 250.102(C)(1). Customer's service equipment must be suitable for the maximum fault current available or the Customer shall install current limiters. Current limiters shall not be installed within pad-mounted transformers. The Company will, upon request, furnish guidelines for the fabrication of a typical cable terminal box. The use of a cable terminal box must be in accordance with applicable codes, electrical ordinances and CenterPoint Energy Specification 600-007-241-02 (Installation of Underground Electrical Service to Apartments, Townhomes or Condominiums). Cable terminal box typical details are shown in Illustration 17 – Typical Cable Terminal Box Details, (next page). All cable terminal box fabricators shall be pre-approved. For approvals contact Electric Engineering, Standards and Materials.

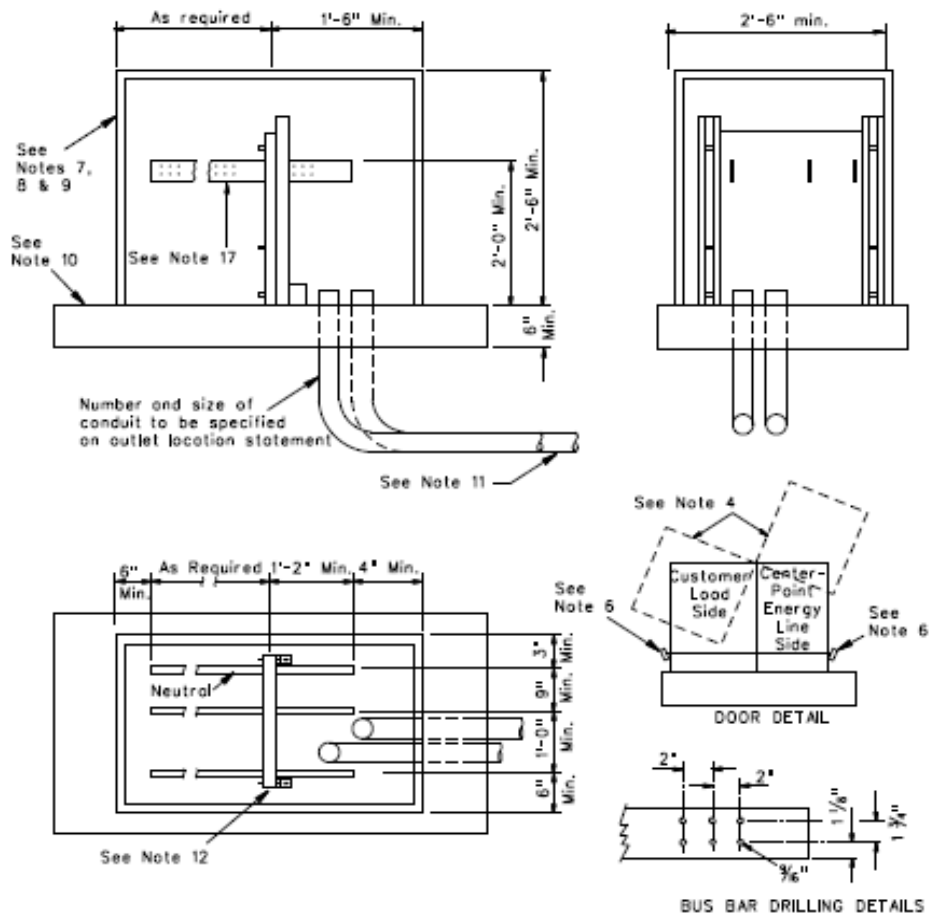

CABLE TERMINAL BOX DETAILS (TYP)
Illustration 17

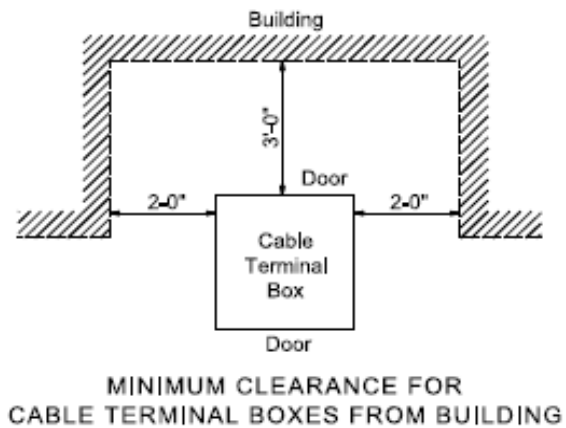
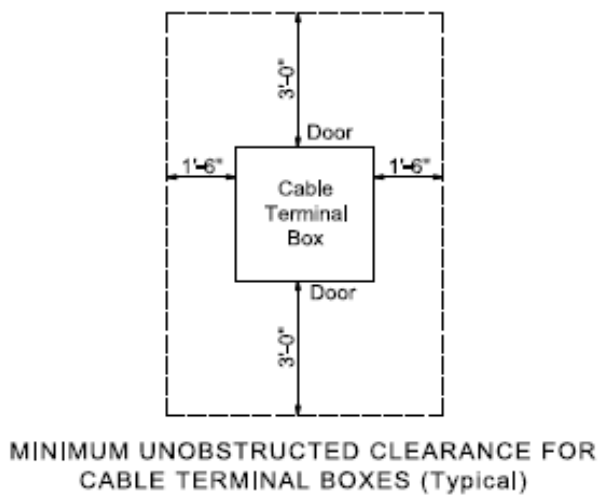

CABLE TERMINAL BOX CLEARANCES
Illustration 17A

NOTES: TYPICAL CABLE TERMINAL BOX DETAIL

1. The above reflects general requirements and as such show typical details only. Any equivalent designs submitted shall be considered.
2. Cable terminal box will be served by service lateral from CenterPoint Energy's transformer in CenterPoint Energy's easement.
3. Cable terminal box and concrete foundation shall be owned, installed and maintained by the owner. The location of the cable terminal box with respect to the transformer will be by mutual agreement between CenterPoint Energy and the contractor or owner. The clearance requirements stated in Illustration 17A, Page 45 are for the life of the service.
4. Cable terminal box shall be made with two separate compartments; one side for CenterPoint Energy connections and the other side for owner's connections. Doors on both sides will be secured by a three-point latch system.
5. CenterPoint Energy's lock will be on CenterPoint Energy's compartment of cable terminal box.
6. The owner shall provide for locking the owner's compartment of the cable terminal box. (Entire cable terminal box shall be tamper proof in accordance with AMERICAN NATIONAL STANDARD ANSI C57.12.28 latest edition.
7. Fiberglass or other material shall not be acceptable.
8. Aluminum shall be used in all coastal areas such as Galveston and Freeport.
9. Cable terminal box shall be weathertight.
10. Cable terminal box shall be mounted and secured on concrete foundation in a level position. Foundation to be capable of supporting junction box and maintaining it in a level position.
11. The owner shall install conduit from CenterPoint Energy service lateral to cable terminal box before CenterPoint Energy's transformer and pad is installed.
12. Insulating barriers to be 1/2" thick and meet NEMA Code N-1, XX, GP01 or GP03.
13. All bus bars shall be rigidly supported.
14. Bus bars shall not be formed inside the cable terminal box.
15. Each phase bus bar shall be a minimum of 1/4" X 4".
16. Aluminum bars shall be tin plated at connection points. Bus requirements of two thousand Amps and above will consist of a tinned copper design.
17. The owner shall make provisions for 3 sets of 2-hole lugs per bus bar for CenterPoint Energy's side of cable terminal box.
18. The owner shall make provisions as required for the owner's requirements on owner's side of cable terminal box.
19. The cable terminal box shall have sufficient mechanical strength and momentary rating to withstand short circuit current given on outlet location statement.
20. CenterPoint Energy will connect facilities on its side of the cable terminal box. The owner shall connect his on his side.
21. All cable terminal box fabricators shall be pre-approved. For approvals contact Electric Engineering, Standards and Materials.

416.4 High-Rise Apartment/Multi-Unit Building: High-rise apartments or other multi-unit high-rise complexes that are to be individually metered and served with 120/240-volt single-phase service, may allocate space within the building for transformers if the total single-phase load exceeds 500 kVA. Additionally, the Company may require that the Customer's wiring total single-phase load be separated into two or three equal portions.

416.5 Meter Room Specifications: The Company prefers that meter rooms not be utilized. If meter rooms must be used, they require approval by Electric Engineering prior to construction. Contact a Company Service Consultant for the specification necessary to address the installation of the advanced metering system (AMS) in meter rooms for single story and multi-story buildings. AMS uses a wireless communication system which must be incorporated into the design of the meter room(s) to operate successfully.

- The Company shall have 24/7 access to all locations where meters are installed. A key storage lockbox to open meter room doors is acceptable. The key storage lockbox shall be easily accessible near the exterior door closest to the lowest meter room.
- For single story and multi-story buildings, where meters cannot be located on an exterior wall, meter room(s) shall be located as close to an outside perimeter wall as possible. All meter rooms in multi-story buildings shall be built in the same relative location on each floor where a metering room is required.
- Modular Metering Units must be approved by Company Personnel prior to installation.

417 METER LOOPS

The Customer shall provide the necessary wiring for the Meter Loop with the wire so arranged that the line (supply) side can be connected to the top terminals of the meter mounting and the load side to the bottom terminals. All conductors shall extend into the meter mounting device a minimum distance equal to the length of the meter mounting device trough. If an aluminum neutral conductor is used, it must be insulated. Where the service is three-phase, four-wire delta, ground and phase wires shall be permanently identified in accordance with latest edition of the National Electrical Code. The conductor serving power load (Hi-Leg) shall be permanently identified or have a distinctive orange covering. The Hi-Leg Conductor shall be connected to the far-right_meter socket_terminal (while facing the meter mounting device) on both the line and load sides. Meter mounting device shall be furnished and installed by the Customer for all Self-Contained installations. Only meter mounting devices which meet Company specifications will be acceptable on the Company's system. No Meter Loops shall be allowed on Company poles.

418 METER INSTALLATIONS

Only CenterPoint Energy or its designated representative is authorized to install, remove or relocate a meter. CenterPoint Energy reserves the right to discontinue service to anyone violating this ruling.

418.1 Meters and Metering Equipment: The Customer shall furnish and own all self-contained Meter Mounting Devices. Meter Mounting Devices shall be used for both indoor and outdoor self-contained installations and shall be furnished in accordance with ARTICLE 418.2. Relocation and/or maintenance of the Meter Mounting Devices will also be the responsibility of the Customer's Contractor. All connections to the Meter Mounting Devices shall be made by the Customer's contractor, except instrument transformer rated installations. All connections to the Company's equipment shall be made by Company personnel only. Existing three-phase residential Customers planning wiring changes shall contact the nearest Company office before making changes.

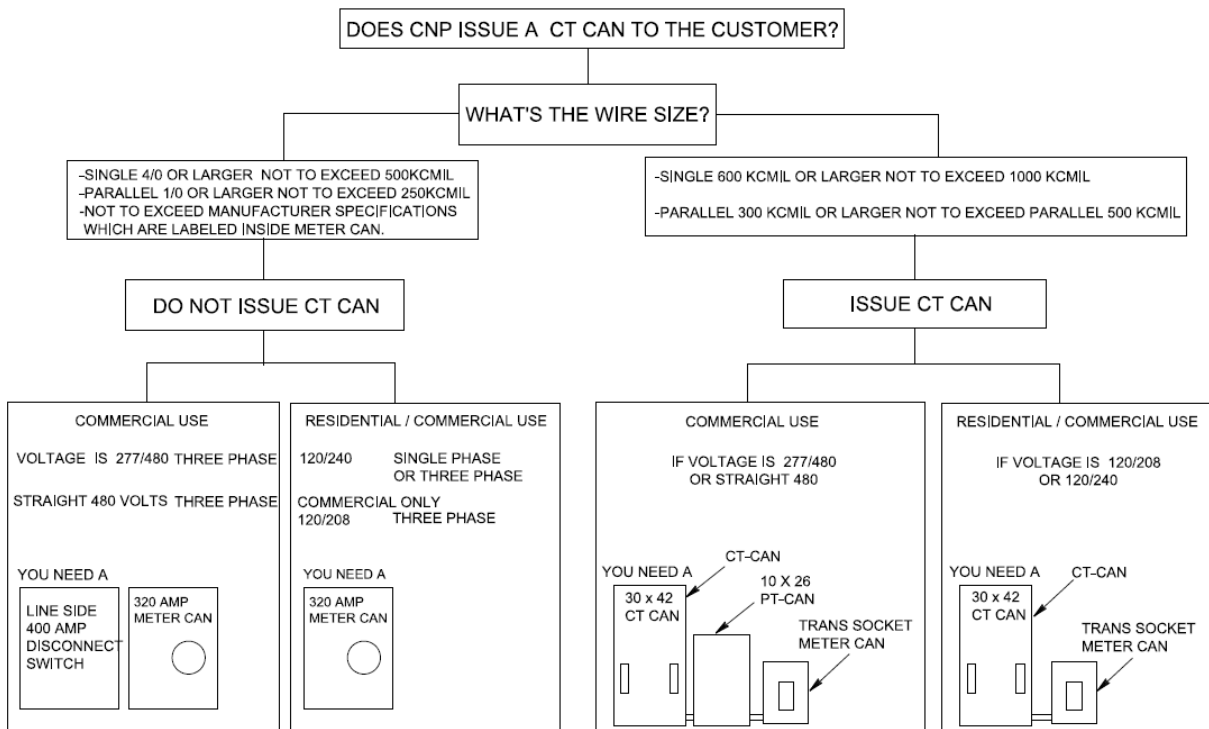

METER CAN DECISION FLOW CHART
Illustration 18

418.2 Meter Mounting Device: It shall be the responsibility of the Customer or his Contractor to purchase the proper type of meter mounting device for residential or commercial service in accordance with the Self-Contained Meter Mounting Device Chart, on this page. Meter mounting device shall be installed by the Customer's Contractor. The types of meter mounting devices are designed to carry the continuous current as indicated for the several types of services shown. Conductors

installed in the Meter Mounting Devices shall be within the range of approved sizes as listed on the UL labeling (lug sizes) within the Meter Mounting Device or the Company will not install its Meters. The customer's main service breaker shall be sized for the meter mounting device used (i.e. up to a 200 Amp main for a 200 Amp meter can and up to a 400 amp main for a 320 amp service). In addition, for 320 Amp Meter Mounting Devices, the 320 Amp Specifications on pages 50 and 51 of these Service Standards also apply. **The Customer will be responsible for any damage to the Company's metering devices, plus labor charges to repair.**

The conduit shall enter and leave the meter mounting device at location of existing hubs or knockouts. The Customer or his Contractor shall close all unused openings by means of galvanized metal plugs or hole closer. Line and load conductors to the meter mounting device shall not be run in the same conduit.

SELF-CONTAINED METER DEVICE CHART RESIDENTIAL SERVICE

TYPE OF SERVICE				Meter Mounting Device
PHASE	WIRE	VOLTAGE (VOLT)	AMPACITY (AMP) (Continuous Rating)	FIGURE (Next Page)
1	3 (Note 4)	120/208	200	2
1	3	120/240	125 or 200	1
1	3	120/240	320	See 320 Amp Illustration 19A&B, pg 52
3	4 (Note 2)	240/120	200	3
3	4 (Note 2)	240/120	320	See 320 Amp Illustration 19A&B, pg 52

COMMERCIAL SERVICE

TYPE OF SERVICE				Meter Mounting Device
PHASE	WIRE	VOLTAGE (VOLT)	AMPACITY (AMP) (Continuous Rating)	FIGURE (Next Page)
1	3	120/240	125 200, or 320	See 320 Amp Illustration 19A&B, pg 52
1	3 (Note 4)	120/208	200	2
3	4	240/120	200 or 320	See 320 Amp Illustration 19A&B, pg 52
3	4	208/120	200 or 320	See 320 Amp Illustration 19A&B, pg 52
3	4	480/277	200 or 320	See 320 Amp Illustration 19A&B, pg 52
3	3 (Note 1, 3)	480	200 or 320	See 320 Amp Illustration 19A&B, pg 52

Notes:

- (1) Requires a bonding conductor, Article 303.
- (2) Three-phase residential services are not generally available. Article 303.
- (3) Fifth terminal lug shall be isolated from the can.
- (4) Fifth terminal lug shall be bonded to the service neutral conductor.
Service provided for Underground Street Network only (See Article 301)

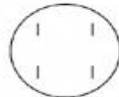

Figure 1
1Ø 3w 120/240



Figure 2
1Ø 3w 120/208
3Ø 3w Δ 480



Figure 3
3Ø 4w Y 208/120 or 480/277
3Ø 4w Δ 240/120

Meter Mounting Device General Specifications

All materials, construction, and testing shall be in accordance with the American National Standards Institute (ANSI) C12.7, Requirements for Watthour Meter Sockets, latest revision.

The meter socket housing shall be fabricated of steel, or aluminum in accordance with U/L Standard 414, latest revision and be suitable for outdoor use in accordance with NEMA 3R, latest revision.

All meter cans shall be painted after fabrication and finish coats shall provide a tough non-chalking weather resistant finish.

Performance requirements for meter sockets shall be in accordance with applicable performance sections of ANSI C12.7 and UL-414 (latest revisions).

Meter socket shall be tested in a certified test lab to meet Underwriters Laboratory (U/L) Standard 414, latest revision, performance requirements and labeled as such.

Socket jaws shall be rated for 600 volts.

Five terminal cans shall have the fifth terminal located in the 9 o'clock position.

Fifth terminal lug shall be isolated from the can.

A neutral connection or contact must be accessible from the meter socket opening. A fifth neutral jaw will suffice for 120/208V Y services. (Exception: 3 Phase, 3 Wire Can)

Knockouts shall not be above any energized surfaces with the meter in place.

Minimum inside dimensions of the enclosure shall be sufficient to provide ample room for the distribution of the maximum-size conductors for which the socket is intended. Internal wiring space shall be such as to allow line or load conductors, or both, entering either or both ends of the enclosure to be readily routed to the proper terminals.

Meter socket installation shall be in accordance with CenterPoint Energy Service Standards, latest revision and meet any code requirements that may be enforced by the local Public Authority.

Maintenance on all Customer owned devices is the responsibility of the Customer.

For specialized metering requirements, contact the Service Consultant at the nearest Company office.

125 Amp and 200 Amp Meter Mounting Device

Socket jaws shall be rated for 125 Amp or 200 Amp continuous current capability.

Meter socket bypass devices are not allowed except for approved 200 Amp modular sockets.

All meter sockets will be ring type. Meter sockets with ringless covers will not be allowed. All single-phase four terminal 125Amp and 200 Amp cans shall have tamper proof lids (TP Bar construction).

320 Amp Meter Mounting Device

Socket jaws shall be rated for continuous current capability.

Meter sockets shall be offset or side wireway models unless the socket is 3 Phase, 3 Wire (See illustrations # 19A, page 52). For approved modular mounted sockets, straight connected bus is acceptable.

Terminal jaws shall be equipped with a by-pass feature operable by use of a lever that controls the clamping of the meter blades (Jaw release) and allows for current by-pass when the need for meter removal is required. By-pass current capacity shall be 320 amperes continuous. Horn-type, sliding-type and automatic bypasses are not permitted.

The socket shall be capable of utilizing mechanical or compression lug connectors (3/8" or 1/2" studs) for the following conductor sizes and maintain U/L standards for wire bending radius requirements.

Single Conductors: (Note: Wire sizes over 500 KCMIL will
4/0 – 500KCMIL (Single Lug Assembly) require CT Rated meter installation)
Parallel Conductors:
1/0 – 250KCMIL (Twin Lug Assembly)

Terminals shall be 3/8" or 1/2" cold headed zinc plated steel studs to accommodate mechanical or compression lugs. The studs shall be attached to tin-plated mounting plates compatible with aluminum or copper lugs.

All meter sockets shall have an insulated protective safety shield.

The meter can lid shall have a ringless meter opening only, with a latch and sealing/locking provision. No screws are allowed on meter can lids.

The cover (lid) of the meter socket shall be such that it cannot be placed over the meter with the bypass lever in the bypassed position and must be tamper resistant.

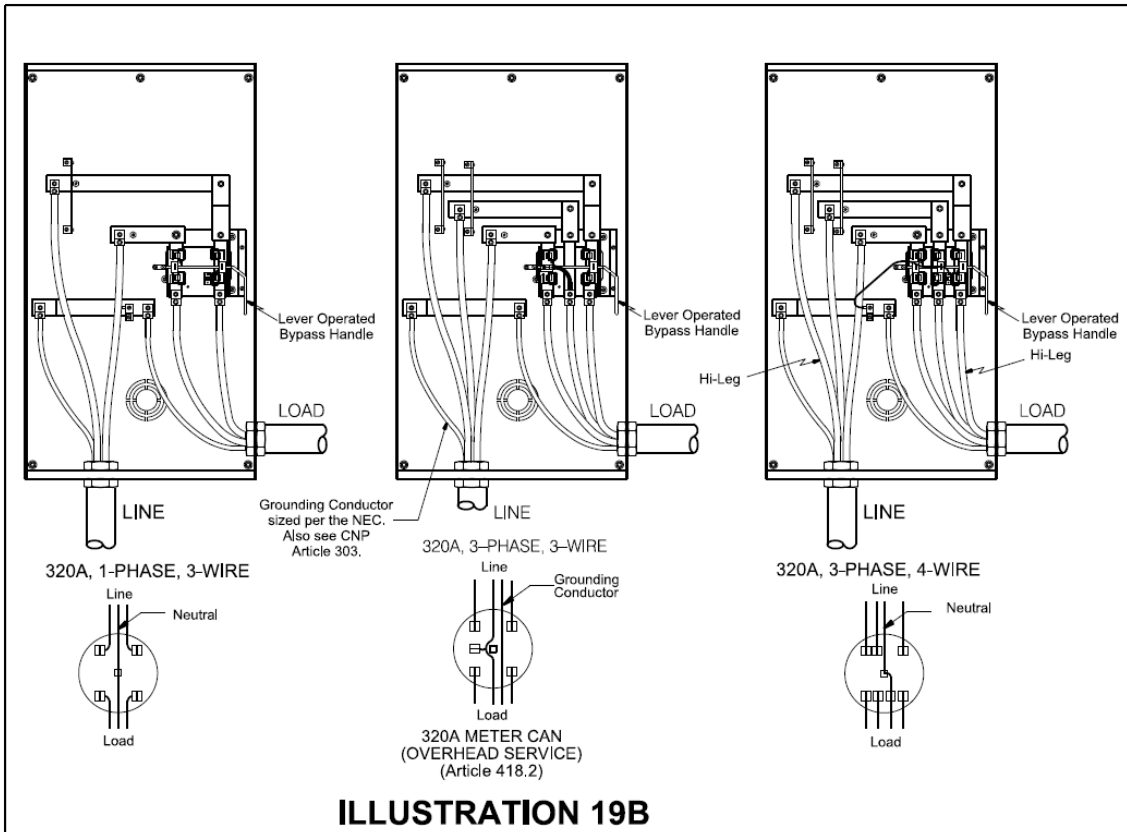
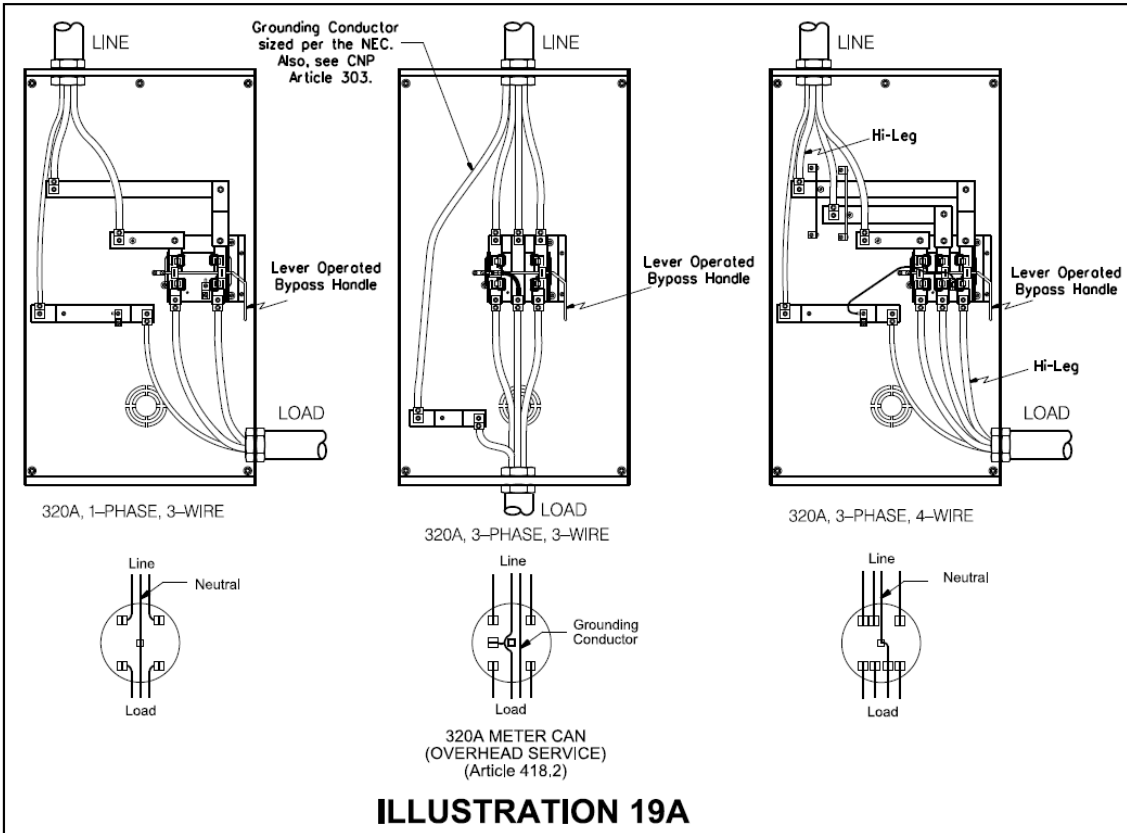

418.3 Self-Contained Meter Pedestals: Self-contained meter pedestals are to be used only in mobile home parks served from underground facilities and for power supply metering of Cable TV (CATV) installations. **Where used, self-contained meter pedestals SHALL BE FURNISHED, INSTALLED AND MAINTAINED BY THE CUSTOMER** after contractual arrangements (See ARTICLE 412) for the installation of underground facilities have been completed. The pedestals shall meet the following minimum requirements. The meter mounting device shall have an ampacity of 200 amps for mobile home park applications and an ampacity of not less than 50 amps for CATV power supply applications. At the pedestal, an adequate disconnecting means shall be provided for each service on the load side of the meter. The ground rod connection shall be made at ground level for easy access. The neutral conductor shall come into the pedestal at least to the switch box ground terminal. The pedestal shall extend not less than 30" below final grade. If required, adequate stabilization material shall be added to ensure that the pedestal will remain vertical at all times. Customers contemplating the use of self-contained meter pedestals should submit detailed manufacturer's specifications for acceptance by Electric Engineering.

418.4 Pre-Wired Modular/Ganged Type Meter Banks: Pre-wired modular/ganged type meter banks may be utilized under certain conditions. The Company will not allow modular/ganged type meter bank installations where each service is individually owned or where there is a lack of common ownership. **CUSTOMERS CONTEMPLATING THE USE OF PRE-WIRED/GANGED TYPE ENCLOSURES SHOULD CONSULT THE COMPANY'S SERVICE CONSULTANT IN THE AREA. SUCH INSTALLATIONS REQUIRE SPECIAL CONTRACTUAL ARRANGEMENTS AND SUBMITTAL OF DETAILED MANUFACTURER'S SPECIFICATIONS FOR ACCEPTANCE BY ELECTRIC ENGINEERING.**

418.4.1 Blank Covers for Modular Meter Banks: Blank covers may be used to prevent access to meter sockets while meters are not in place. Where used, it **SHALL MEET MANUFACTURE'S SPECIFICATIONS AND BE FURNISHED BY THE CUSTOMER** with company approval.

419 METHODS OF INSTALLING METER MOUNTING DEVICES

419.1 Requirements: Meter mounting devices shall not be used as junction boxes for the Customer's wiring. Customer's wiring shall be installed in Meter Mounting Devices, as follows:

419.1.1 Meter Mounting Devices for Socket Type Meters rated at 200 amperes or less: Only one conduit and one set of Service Entrance Conductors shall be used on the line side, and one conduit and one set of Service Entrance Conductors shall be used on the load side of meter mounting device.

419.1.2 Meter Mounting Devices for Self-Contained Meters rated at 320 Amperes: Meter mounting devices rated at 320 amperes shall not be used where the anticipated load and service entrance conductors have a rating of 200 amperes or less. No more than two conduit and two sets of Service Entrance Conductors shall be used on the line side and no more than two conduits and two sets of Service Entrance Conductors shall be used on the load side of the meter mounting device. The conductors do not have to be the same size for line and load. The Customer or Customer's contractor shall make all connections to the Meter Mounting Device, except for instrument transformer rated installations. (For more information on 320 Amp meter mounting devices, see ARTICLE 418.2 and Illustration 19A & 19B on page 52.

419.2 Meter Mounting Device

Multiple occupancy service usually requires that Service Entrance Conductors be in a sealable weatherproof wiring trough similar to the arrangements shown for single-phase installations in Illustration 20 - Multiple Installation Using Wiring Gutter and Individual Meter Mounting Devices, (next page). Line taps shall be made in the wiring trough by the electrical contractor. For three phase service fed from a multi-tenant line gutter, the electrical contractor is responsible for providing and maintaining A-B-C clockwise rotation to the line side of the self-contained meter mounting device. **No more than four (4) weatherheads and four (4) conductors per phase and neutral shall be allowed in a wiring gutter installation.** Service Conductor extensions or taps(daisy chain) are prohibited from the original gutter. Pre-wired/ganged type installations shall be limited to one (1) weatherhead and one (1) conductor per phase and neutral. Accepted grounding and bonding practices for multi-meter installation are shown in Illustration 21 - Acceptable Grounding and Bonding Practice for Multi-Metering Installation, on page 56.

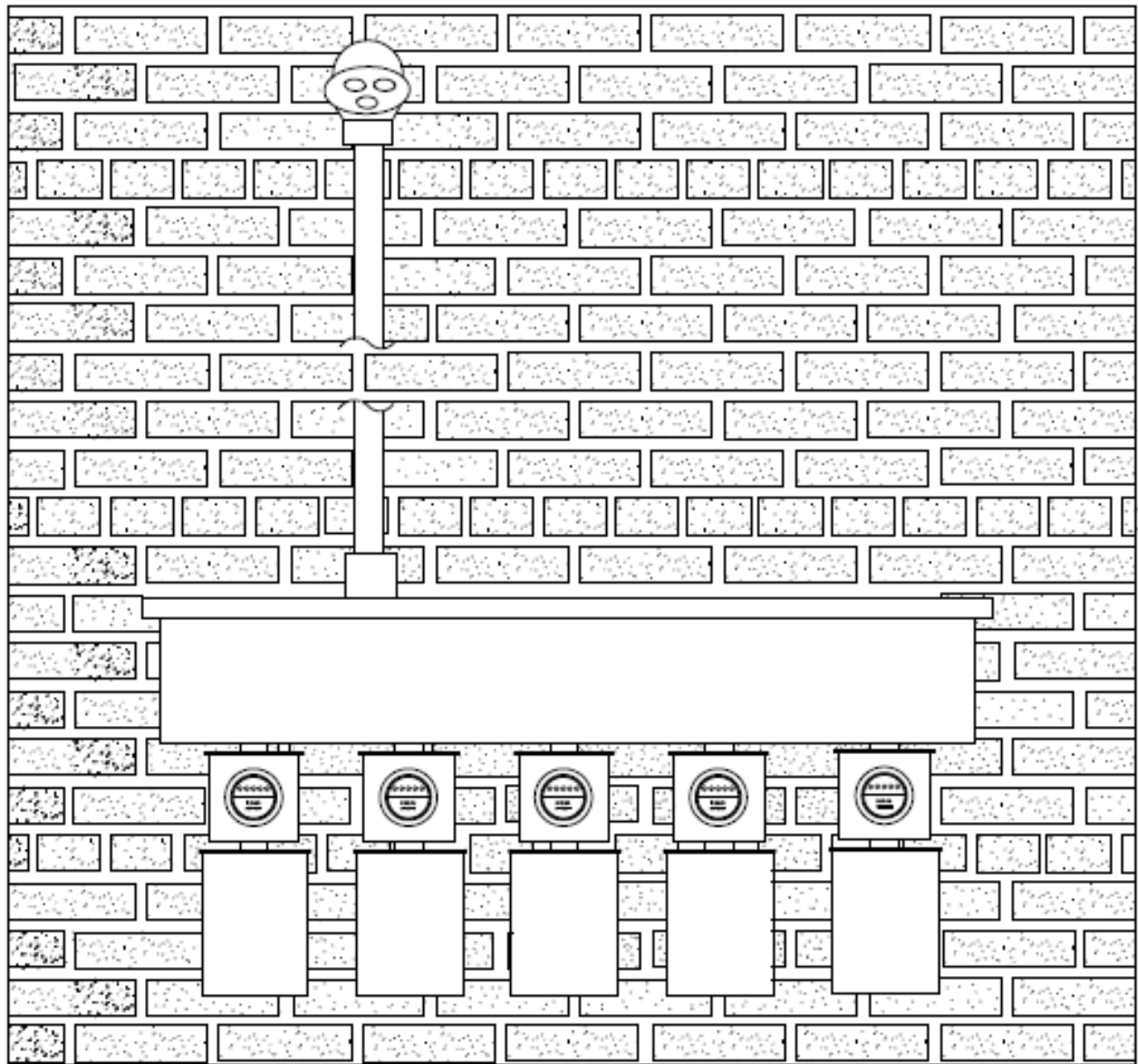

MULTIPLE INSTALLATIONS USING WIRE GUTTER AND
INDIVIDUAL METER MOUNTING DEVICES
(Article 419.2)
Illustration 20

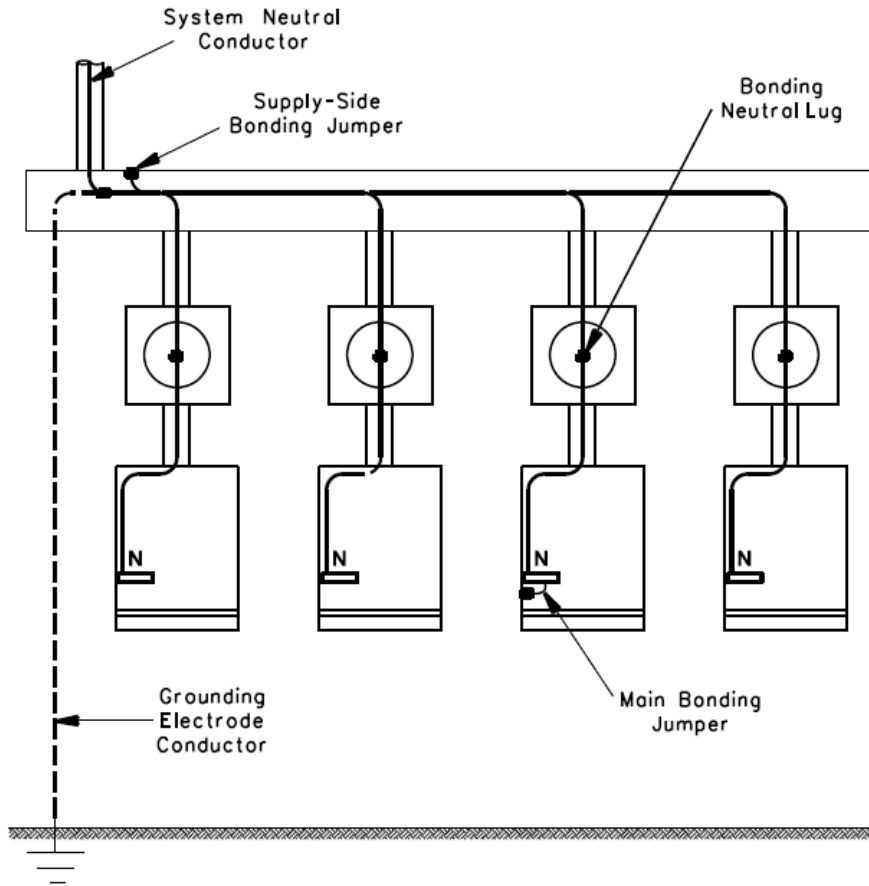

1. No bonding connectors will be permitted in meter mounting device.
2. No double lugging or splicing will be permitted in meter mounting device.
3. Grounding/bonding connectors must be sized in accordance with N.E.C.

ACCEPTABLE GROUNDING AND BONDING
PRACTICE FOR MULTI-METERING INSTALLATION
(Article 419)

Illustration 21

419.3 Meter Mounting: Meter Mounting Devices shall be installed so that the display of the meter is level.

419.4 Clearances: Meter Mounting Devices shall be installed by the Customer or the Customer's Contractor with a free space of at least **36"** in front and **2"** on the sides, top and bottom, as necessary clearance to install, remove, and to test equipment. The free space shall be over the Customer's property or public ways and shall not encroach upon the property of others even though there may be a utility easement in the area of encroachment. In addition, the meter shall maintain a minimum 36" horizontal distance from a gas meter regulating vent and shall not be located above or below the vent.

419.5 Service Cable Tap Box – Multi-Tenant Services: In Multiple-Tenant buildings where additional services are likely, a bus conductor service cable tap box may be required similar to Illustration 22A, (see below). A Multiple occupancy service usually requires that Service Conductors be in a sealable weather-tight wiring tap box similar to Illustration 22B(see below). From the Point of Delivery, Service Conductors must enter directly into the Service Cable Tap Box. Service Entrance Conductor line taps shall be made in the Tap Box by the electrical contractor. Service Conductor extensions or taps(daisy chain) are prohibited from the Tap Box. For three phase service fed from a multi-tenant line gutter, the electrical contractor is responsible for providing and maintaining A-B-C clockwise rotation to the line side of the self-contained meter mounting device. Accepted grounding and bonding practices for multi-meter installations are shown in Illustration 21(page 56). In addition, the customer is responsible for bonding the Service Tap Box per NEC Table 250.102(C)(1).

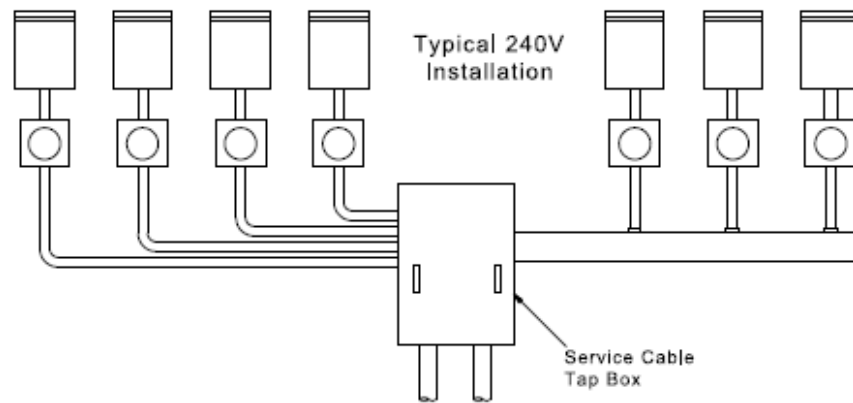
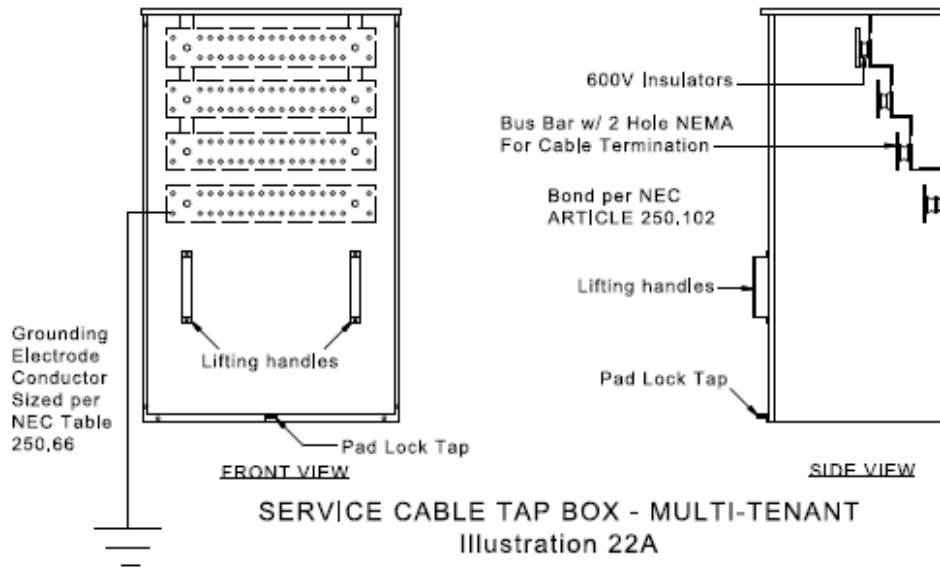

MULTI-TENANT SERVICES USING SERVICE CABLE TAP BOX
Illustration 22B

NOTES: TYPICAL SERVICE CABLE TAP BOX DETAILS

1. The above reflects general requirements and as such show typical details only. Any equivalent designs submitted shall be considered.
2. Service Cable Tap Box will be served by Underground Service Conductors from the Company's transformer or customer's weather-head.
3. Service Cable Tap Box and conductors shall be owned, installed and maintained by the owner.
4. Service Cable Tap Box shall be lockable and can accept a CenterPoint Energy lock.
5. Covers shall be fastened with machine screws or bolts. Hinged covers shall not be permitted.
6. Covers shall have two handles for cover removal.
7. Non-Metallic material such as fiberglass shall not be acceptable.
8. Service Cable Tap Box shall be weather-tight and fabricated from minimum 12GA Steel or equivalent metal.
9. The bottom of Service Cable Tap Box shall be a minimum of 6" above finished grade.
10. 600V Insulators are required for supporting the energized bus bar.
11. Bus bars shall be sized to physically accommodate the maximum number of tenant services anticipated and predrilled for conductor tie-ins.
12. All bus bars shall be rigidly supported and protected from physical damage.
13. The phase arrangement on three phase horizontal common power and vertical buses shall be A-B-C from front to back, top to bottom, or left to right as viewed from the front of the Service Cable Tap Box. B phase shall be that phase having the higher voltage to ground on three phase, 4-wire, Delta connected systems. The phases shall be permanently marked.
14. The bus arrangement shall include spaced holes or multi-port lugs for cable termination.
15. Service Cable Tap Box shall have sufficient mechanical strength and momentary rating to withstand short circuit current given on outlet location statement.
16. All Service Cable Tap Box fabricators shall be pre-approved. For approvals, contact Electric Engineering, Standards and Materials.
17. For use on service voltages through 480V.

Exception: Residential Occupancies

420 HEIGHT OF METERS

- 420.1 Socket Bases:** The height of meter mounting devices shall be such that the center of the opening for the meter is between **4 ft.** and **6 ft.** above final grade. In flood zones, see Article 421.8.

420.2 Pedestals: The height of self-contained meter pedestals used in mobile home parks shall be such that the center of the opening for the meter is between 3 ft. and 6 ft. above ground level.

421 METER LOCATION

421.1 All metering equipment shall be installed on the supply side of the main switch. No Customer-owned device(s) shall be allowed ahead of the meter except those required by the Company. (See ARTICLE 423)

421.2 All residential and combination residential and commercial service meters shall be installed outdoors. In residential areas where service is supplied underground, the meter should be located on the side of the house instead of the rear of the house. (See Illustration 15, on page 41) **In residential areas where service is supplied overhead and the house is accessible to overhead service drops to a rear corner, the meter should be located on the side of the house instead of the rear. In all cases the meter should be located in a position that is accessible to Company employees at all times without Customer assistance .** In addition, the meter shall maintain a minimum 36" horizontal distance from a gas meter regulating vent and shall not be located above or below the vent.

421.3 Meters are to be installed immediately above or below line gutter except for 480Y/277 volt service or 480 volt service, in which case the required meter disconnect will be between the line gutter and the meter and shall be located so the height of the operating handle is not less than 4 feet and not more than 6'-7" above finish grade. (See Article 423) Also, a minimum 4" clearance should be provided to the right of the meter disconnect to allow adequate clearance for locking.

421.4 Meters shall not be located where they will interfere with traffic on sidewalks or driveways, or where they will obstruct the opening of doors or windows.

421.5 Metering equipment shall be installed on a wall which is a substantial part of the building itself or on a meter pole. Temporary partitions, etc., which are subject to replacement or excessive vibration shall not be used. Meters or metering equipment shall not be installed on the Company's poles.

421.6 Grouping: Where more than one meter is installed, the meters shall be grouped at a point accessible at all times to the Customer's and Company employees. **EACH METER MOUNTING DEVICE SHALL BE CLEARLY AND PERMANENTLY MARKED ON THE OUTSIDE TO SHOW THE APARTMENT AND/OR ADDRESS TO BE SERVED BY THE METER.** It shall be the responsibility of the Customer or his Contractor to ensure the accuracy of the markings with respect to the apartment and/or address. For changes in existing wiring, the Customer should consult the Service Consultant in the area.

421.7 Wiring Gutter: On apartment buildings which are served 120/240, 120/208 volts,

single phase, the wiring trough with individual meter mounting devices in Illustration 20 on page 55 may be used. Where space limitations will not permit placing all meter mounting devices on the same level, the meter installation may be made by arranging them in two tiers. The center of the opening for the meters in the lower tier shall not be less than **2.5 ft.** above finished grade-level and the center of the opening for the meters in the upper tier shall not be more than **6.5 ft** above finished grade level. The center of the meter opening for a "building service" or any meter mounting devices requiring a kVA demand-type meter shall not be greater than **6 ft** above finished grade-level. Where space limitations will not permit placing meter mounting devices as outlined above, or if the installation involves multiple three-phase installations and they cannot be arranged at the same height, consult the Company's Service Consultant or the nearest Company Office listed on page 5.

421.8 Flood Zone: By Company special permission, Meter mounting devices may be mounted at a height greater than 6 ft. above ground where required due to local building codes. Contact the Service Consultant in the area where flood plain construction occurs. For this installation, a platform with a stairway and handrail approved by a local building official shall be provided and maintained by the customer so metering equipment is readily accessible to company employees as shown in Illustration 23 (see below).

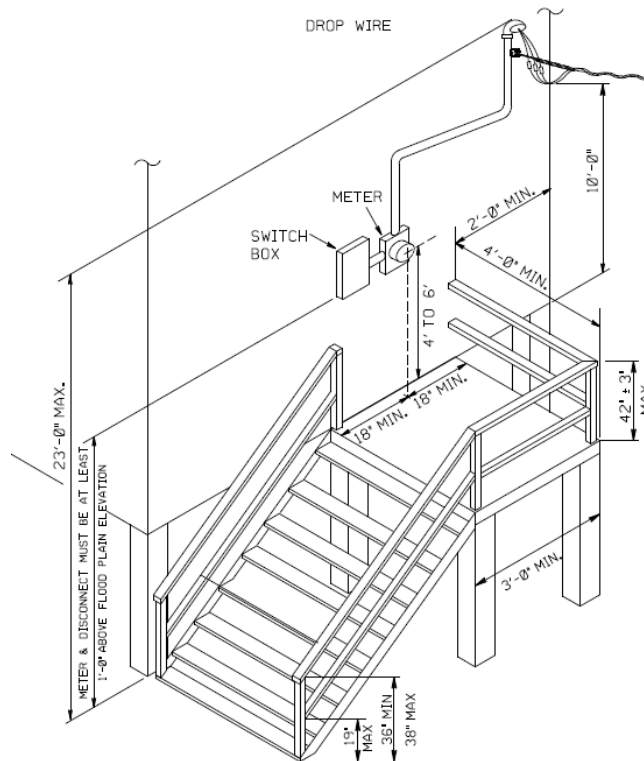

METER LOCATED WITHIN
FLOOD PLAIN AREAS
Illustration 23

422 METER POLE INSTALLATIONS

422.1 Requirements: A meter pole is required in those cases where suitable location, clearance, and anchorage as called for in Articles 403, 404 and 406 are not available on the Customer's premises. Even if the conditions set forth in Articles 403, 404 and 406 are satisfied, the Customer has the option to install a meter pole. Meter poles are installed and maintained by the customer at his expense and shall not be installed in utility easements. Meter poles required by the Company or at the Customer's discretion shall be a round pole, a 4" x 6" timber pressure treated with penta/creosote or a steel pole of equivalent strength. The use of alternate types of meter poles must have Company approval before installation. All meter poles shall provide the point of attachment, clearances, and anchorage as described herein. The pole setting depth shall be a minimum of 4 ft., or 2 ft. plus 10% of the pole length, whichever is greater. Steel poles shall be truck accessible. The Company will not provide service to any customer owned steel pole that is not truck accessible. The customer must provide a readily accessible Service Disconnect at the meter pole.

422.2 Temporary Service: Meter poles for temporary service of 125 Amperes or less may be 4" x 4", or larger, timber if well anchored and braced to withstand the strain of the Service Drops. Such meter poles may be used only when the Company's Service Drops will not cross a street or roadway. When the Company's Service Drops must cross a street or roadway, the Customer may pay the Company for the cost of installation and removal of a service pole. As an alternative, the Customer may install a 30 ft., round creosoted meter pole (25 ft. above ground) on his property and within 70 ft. of the Company's pole so that proper road clearance of the Service Drops may be maintained. Temporary meter poles may not be installed in utility easements. Meter Mounting Devices used for temporary single-phase service (T-Saw) installations shall be supplied by the Customer or his Contractor and shall meet the requirements shown in Article 418.2.

422.3 Meter Seals: It is the practice of the Company to seal or lock all meters. Only the Company's agents and persons authorized by law are permitted to remove a Company seal or lock.

**423 METER INSTALLATION SEQUENCE – 240V & BELOW
SELF-CONTAINED**

SERVICE – METER – SWITCH – FUSE - LOAD

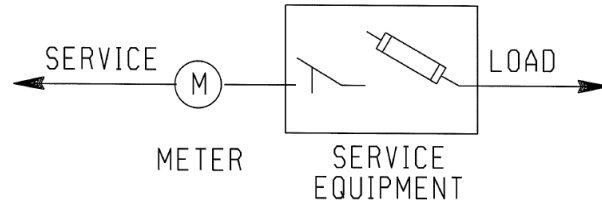

METER INSTALLATION SEQUENCE – 480V SELF-CONTAINED

SERVICE - METER DISCONNECT - METER – SWITCH - FUSE - LOAD

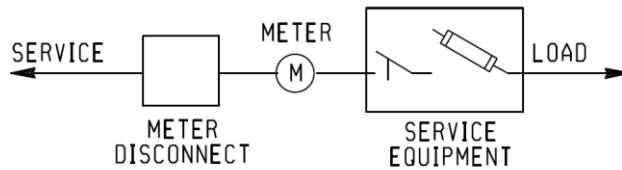

Meter Disconnect Switch Informational Note: Per UL 98 Standard for Enclosed and Deadfront Switches, the maximum short-circuit rating for a non-fusible switch is 10,000 Amps which is typically below the available fault current of most 480V self-contained metered services. The use of a fusible switch will meet the requirements specified in NEC 230.82(3) for a meter disconnect switch.

The meter disconnect switch shall not be used as a service disconnect and shall be locked and sealed under the exclusive control of the Company. See Illustration 24, (see below). In addition, it must comply with the requirements specified in **NEC 230.82[3] for FIELD LABELING BY CUSTOMER** as well as all other applicable NEC requirements. Note: The meter can is not to be used as a junction box, so the grounded neutral conductor must run straight through the meter can without splices. For certain multi-level structures, the most feasible method of serving individually metered tenants often includes metering gutters located within the building proper and remote to the Point of Delivery of Electric Service. With such service arrangements, National Electrical Code requirements, building design, and Customer wiring costs also make the installation of a disconnecting means between the Point of Delivery and the remote metering gutter a desirable alternative. **REQUESTS FOR THE INSTALLATION OF A DISCONNECTING MEANS ON THE LINE SIDE OF A REMOTE METERING GUTTER MUST BE REFERRED TO ELECTRIC ENGINEERING FOR APPROVAL OF THE ARRANGEMENT DURING EARLY DESIGN STAGES, PRIOR TO INSTALLATION OF EQUIPMENT.** Failure to obtain the required approval may result in the Company refusing to energize equipment installed by the Customer. The sequence of connections for individual meter installations served from a metering gutter shall be as stated above. The service disconnecting means shall be installed at a readily accessible location either outside of a building or structure, or inside nearest the point of entrance of the service conductors. The intent of the foregoing is to locate the disconnecting means as close as possible to the meter. **For all new services, Company personnel must be able to verify that the main disconnect is open before energizing service.**

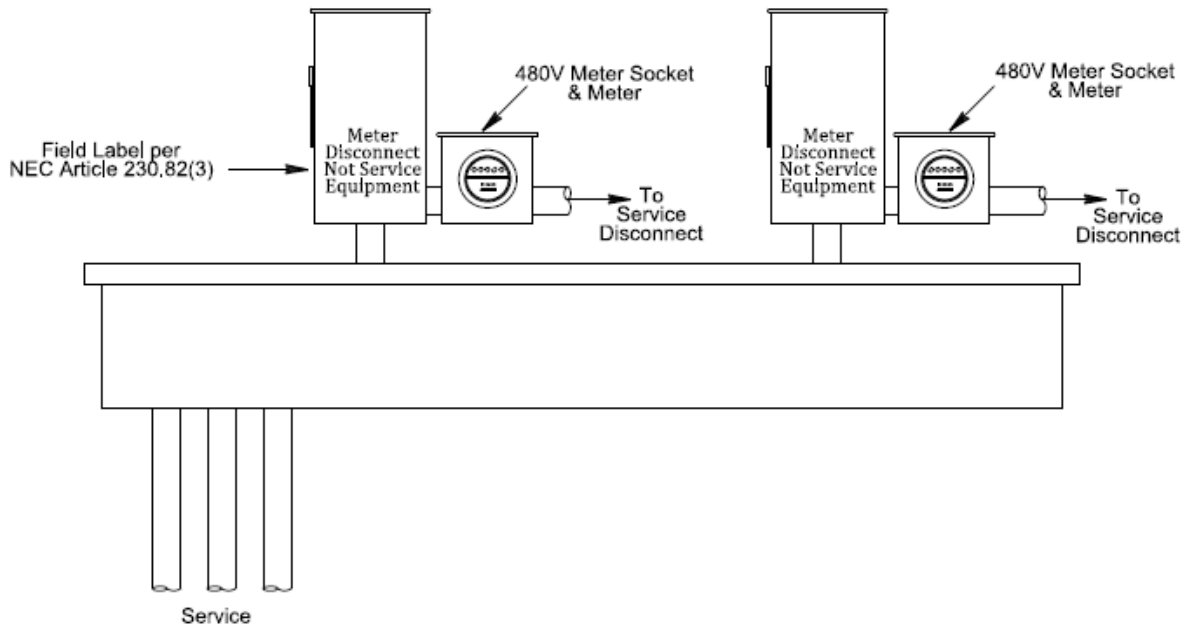

**480V METERS INSTALLATION SEQUENCE
(Article 423)
Illustration 24**

NOTES:

Service Entrance Conductors: (See Articles 402.1 and 408.) Phase conductors for permanent installations must not be smaller than #6 CU or #4 AL, unless approved by the Company.

Service Entrance Raceway: (See Article 408.)

Meter Mounting Device: Meter Mounting Device is to be furnished and installed by the Customer. (See Article 418.2 of CenterPoint Energy Service Standards for correct size of meter mounting device)

Service Entrance Disconnect and Overcurrent Protection: Externally and manually operable with overcurrent protection (fusing or breaker setting) not greater than capacity of service entrance conductors; May be located inside or outside of building; Must be rain tight if mounted outdoors, either on a building or on a pole.

Grounding Electrode Conductor: The grounding electrode conductor shall be continuous without splices from the neutral bus in the service equipment to the grounding electrode. The grounding electrode conductor, minimum size #8, or its enclosure shall be securely fastened to the surface on which it is carried. A #4, or larger, conductor may be exposed but shall be protected if exposed to severe physical damage. A #6 grounding conductor that is free from exposure to physical damage shall be permitted to be run along the surface of the building construction without metal covering or protection where it is rigidly stapled to the construction; otherwise, it shall be in conduit, electrical metallic tubing, or cable armor. Grounding conductors smaller than #6 shall be in conduit, electrical metallic tubing, or cable armor. The National Electrical Code requires grounding to a "Grounding Electrode." A driven ground rod is preferred by CenterPoint Energy.

Bonding (Jumper) Conductor: A bonding conductor (jumper) shall not be installed on the meter socket neutral lug. The meter socket neutral lug bonds the meter socket to the grounded system conductor.

SECTION 500 – LARGE COMMERCIAL INSTRUMENT TRANSFORMER RATED METER SERVICE INSTALLATIONS

500 GENERAL INFORMATION

The Customer’s wiring installation should conform to the requirements of the National Electrical Code and the National Electrical Safety Code, State, Municipal requirements in force at the time the installation is made and the Company Service Standards as to Service Outlet Location, Service Drop, Meter Location and height, etc. Compliance with all such codes and requirements is the sole responsibility of the Customer for all Customer wiring and equipment. The Company does not inspect Customer wiring and equipment, and the supplying of Electric Service by the Company does not mean that Customer wiring and equipment has been inspected or approved by the Company. General requirements detailed in Section 200 governing service installations are available from the Company’s Service Consultants in the area. **Large Service Customers should contact the appropriate key Accounts Representative in the planning stages or as early as possible to ensure adequate time is allowed for the preparation of individual specifications, ordering equipment and acquiring easements, if required.**

500.1 Motor Starting Currents

Motors generally require a starting current substantially greater than their normal running current. An abnormal drop in supply voltage results when starting currents are excessive. It is essential that the Customer’s motors not exceed allowable starting characteristics to minimize detrimental effects upon equipment. Contact the Service Consultant in the area upon adding any new motor load of 250 horsepower or more. DC and Adjustable Speed Drive motors generate harmonic currents that may severely distort the customer’s voltage and could affect service to other CenterPoint Energy customers. Therefore, before installing DC or Adjustable Speed Drive motors totaling over 250 hp, please submit to the Service Consultants each harmonic current, in percent of fundamental 60 Hertz frequency, generated by the motor. Where harmonic currents at CenterPoint Energy’s meter exceed IEEE Standard 519 limits, the customer will be required to filter the disruptive frequencies. Before placing orders for motor control equipment, Customers contemplating the installation of large motors shall consult the nearest Company Office (See page 5) to ascertain the allowable motor starting currents at the specified location. Customers wanting to operate a group of motors from a single control shall consult with the Company to ascertain the allowable motor starting currents at the specified location.

500.2 Loads Having Abnormal Electric Characteristics

Certain types of equipment have electrical characteristics which may cause serious fluctuations of voltage and interfere with the service of the Company to its Customers. In such cases the Company shall decline to serve such equipment under the Company's established Rate Schedules until the Customer, at his expense, has provided suitable apparatus to hold the effects of such fluctuations within reasonable limits. Circumstances may require such equipment to be supplied from a separate service and, in such event, the Company may require additional contractual arrangements and may meter such services separately from other services supplied to the Customer.

Installation of X-ray equipment may require special equipment on the part of both the Customer and the Company. The Company shall be consulted before any special wiring is started for X-ray equipment.

An increasing segment of Customer load today incorporates electronic components and can cause harmonic distortion in the Customer's voltage and current. This distortion can cause negative effects in the Customer's operations and can affect the service to other CenterPoint Energy Customers. For this reason, CenterPoint Energy requires limits to harmonic distortion in compliance with IEEE Standard 519 and in accordance with CenterPoint Energy Specification 007-231-83 to insure proper service to all Customers. The following are examples of harmonic producing equipment devices.

- DC or variable frequency AC motors utilized in air conditioning chillers and blower motors, pump motors and plastic extrusion, etc.
- Electronic equipment such as computers and microprocessor controls.
- Equipment utilizing arcing devices including:
 - Arc furnaces
 - Welders, and
 - Florescent, sodium and mercury vapor lighting with high-efficiency electronic ballast-controlled lighting.

Power factor correction capacitors can magnify harmonic distortion. **Before installing any of the equipment discussed above or other similar devices including power factor correction capacitors, contact the Service Consultant in the area for guidance to ensure the proposed loads will not exceed CenterPoint Energy's or IEEE Standard 519 limits.**

500.3 Ranges, Ovens and Other Heating Devices

Large heating devices to be operated from 3-wire or 4-wire service shall have the elements connected so that the load is evenly divided between the wires, or phases, when such equipment is equipped with automatic control that may cause frequent connection and disconnection of the load. The Customer shall consult with the Company concerning the allowable variation in load. The Customer

shall consult with the nearest Company office and determine the exact type of service to be supplied before placing orders for heating equipment other than the portable or plug-in type.

500.4 Heavy Duty Portable Equipment

Contractors, builders and others contemplating the temporary use of heavy-duty portable equipment such as floor sanders, welders, tile polishers, etc., are required to apply to the nearest Company Office and make satisfactory arrangements before connecting any such equipment to convenience out-lets or other light-duty circuits. In cases of non-compliance with this regulation, they will be held liable for any damage to the Company's service facilities.

500.5 Customer Owned Generating Equipment

Before Customer-owned generating equipment may be interconnected to the Company system, application must be made and approved. (See CenterPoint Energy Specification 007-231-76.) For more information, contact the Service Consultant at the nearest Company Office. (See Article 215 pages 18-19).

500.6 Fire Pumps

Where a Fire Pump Service is to be **individually metered**, it shall be served through a C.T. Metered Service. (See Instrument Transformer Rated Meter Installation Sequence, Article 517 and Metering C.T. Box, Article 513.5).

501 SERVICES

The Company will supply to a Customer, at each Point of Delivery, only one of the Types of Service listed in these Service Standards. The Customer's installation is to be so arranged that the Company can measure the power used by the Customer with one meter.

OVERHEAD SERVICE

502 SERVICE DROP

502.1 Requirements: For the Company to provide service, the weatherhead must face the direction of the service drop. The Company will install one Service Drop from the Company's distribution Lines to the Customer's Service Outlet. Open wire type Service Drop, which requires a seven-point rack (see Illustration 25), must be used for 480-volt, 3 wire delta service (See Illustration 25 - Typical Commercial Open Wire Service Installation, page 68). Twist conductor is allowed only for 277/480v, 4 wire service and 240/480v, 3 wire single phase (governmental entities for lighting only). Where Service Outlets are grouped (See ARTICLE 505), the combined ampacity of all Service Outlets shall determine the type of Service Drop. (See Illustration 26 – Arrangement of Overhead Commercial Service Equipment, page 69.)

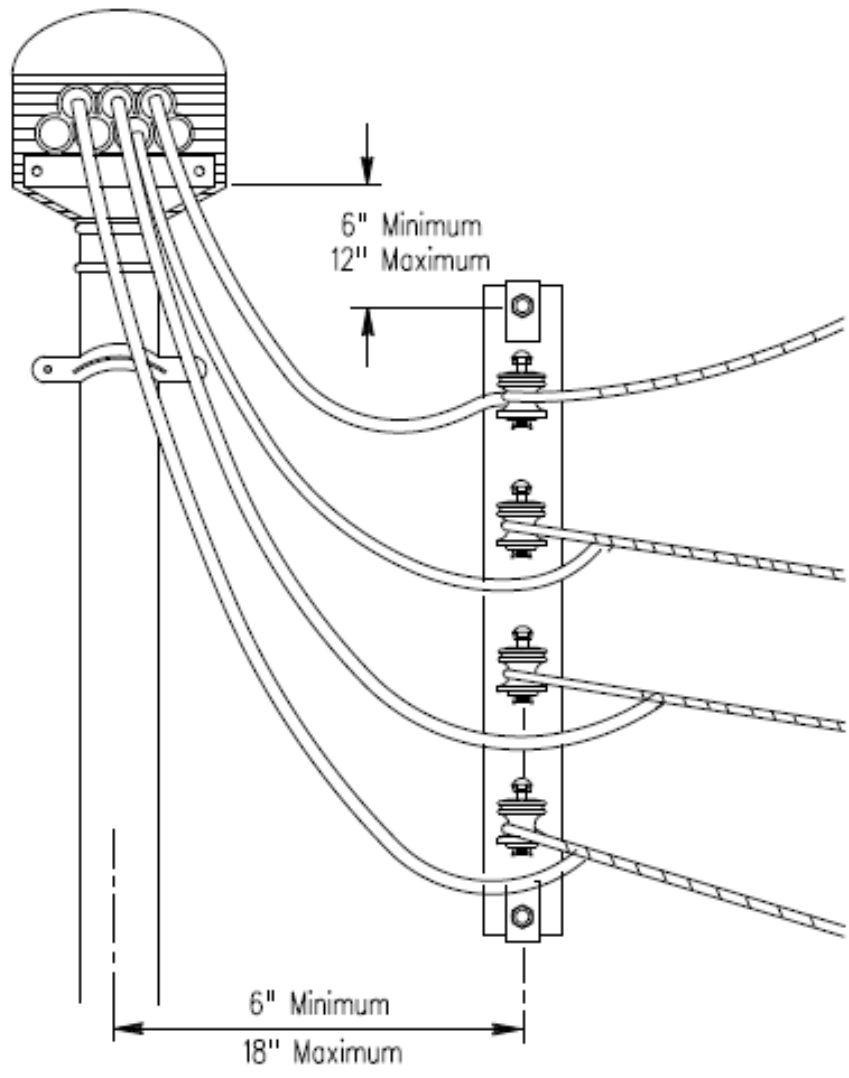

TYPICAL COMMERCIAL OPEN WIRE SERVICE INSTALLATION
(Article 502)
Illustration 25

**FREE STANDING CT BUS BAR
WEATHERHEAD - SINGLE CUSTOMER
SEE SERVICE STANDARDS**

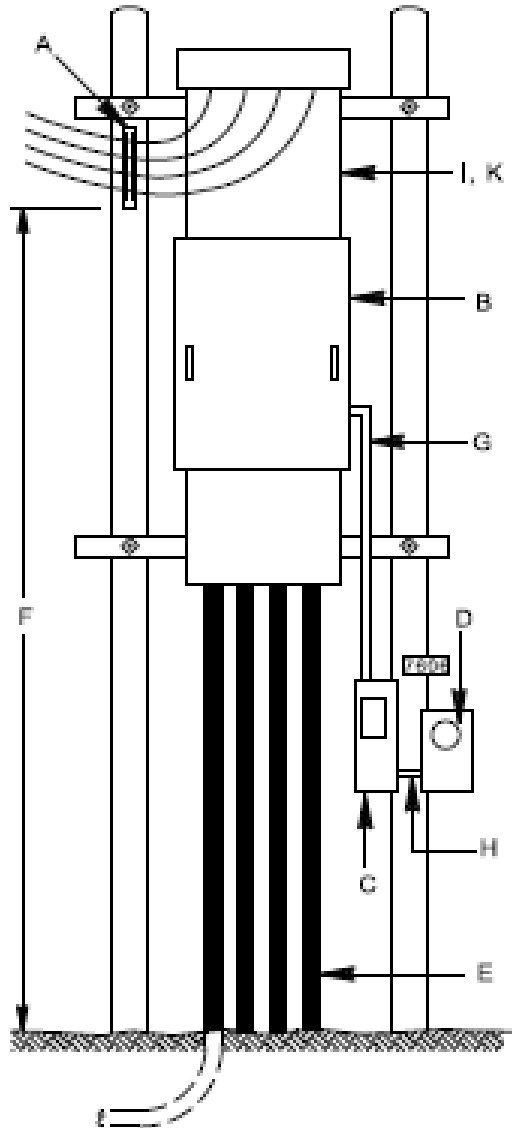

- A) 7 Point Rack
Installed by the Customer or his contractor, always located on the same side as the neutral and its location is specified by CNP.
- B) 30" X 42" Current Transformer Box
Furnished by the Company and installed by the customer or his contractor. Bus bar weatherhead installations with CT compartments are to be used for Single Customer applications only. The CT compartment on a bus bar arrangement will only be used for CNP metering equipment. It shall not be used as a junction box by the customer.
- C) 10" X 28" Potential Transformer Box (If Required)
Furnished by the Company and installed by the customer or his contractor.
- D) Meter Box and Meter
The Meter Box furnished by Company and installed by the customer or his contractor.
- E) Conduit
Installed by the customer and sized to accommodate the Underground Service Conductors
- F) Service Drop Clearance
See Section 503.1 for Ground Clearance and Service Condition.
- G) 1 1/4" Metallic/Schedule 40 PVC Conduit(or Greater)
Furnished and installed by the customer or his contractor. Used to connect the CT metering box, the P.T. Box and the protective meter box. The 1 1/4" conduit shall not exceed 50' in distance.
- H) 1 1/4" Metallic/Schedule 40 PVC Conduit or nipple to be installed between potential transformer box and protective meter box, using knockout holes provided.
- I) All free standing bus bar weatherheads must face or be perpendicular to the transformer pole location. The point of attachment (7 point rack) must be located on the structure on the same side as the transformer pole location.
- J) Service Riser Protection:
Customer may not install theft deterrents that pose a safety hazard to CNP personnel.
- K) Supply Side Bonding:
Installed by the customer per the NEC using Mechanical Lugs

NOTE:

**WEATHERHEAD MUST FACE
THE DIRECTION OF THE SERVICE
DROP. SEE NOTE I**

**ARRANGEMENT OF OVERHEAD COMMERCIAL
SERVICE EQUIPMENT
(BUS BAR WEATHERHEAD)
Illustration 26**

FREE STANDING BUS BAR
WEATHERHEAD - MULTI- CUSTOMER
SEE SERVICE STANDARDS

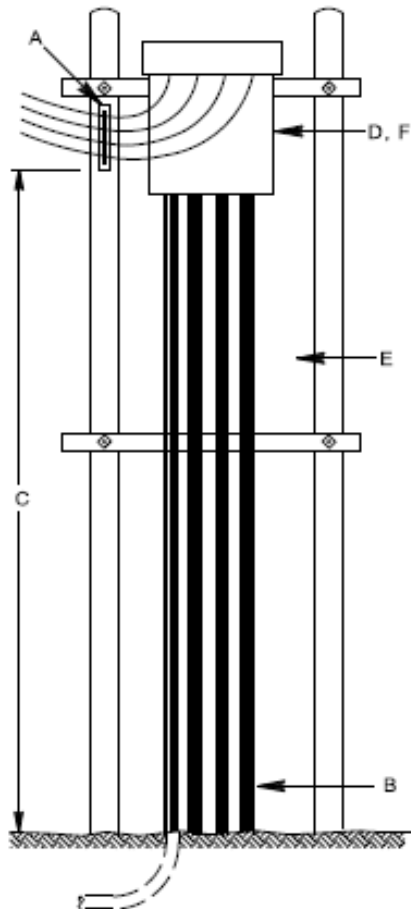

- A) 7 Point Rack
Installed by the Customer or his contractor, always located on the same side as the neutral and its location is specified by CNP.
- B) Conduit
Installed by the customer and sized to accommodate the Underground Service Conductors
- C) Service Drop Clearance
See Section 503.1 for Ground Clearance and Service Condition.
- D) All free standing bus bar weatherheads must face or be perpendicular to the transformer pole location. The point of attachment (7 point rack) must be located on the structure on the same side as the transformer pole location.
- E) Service Riser Protection:
Customer may not install theft deterrants that pose a safety hazard to CNP personnel.
- F) Supply Side Bonding:
Installed by the customer per the NEC using Mechanical Lugs

NOTE:
WEATHERHEAD MUST FACE
THE DIRECTION OF THE SERVICE
DROP. SEE NOTE D

ARRANGEMENT OF OVERHEAD COMMERCIAL
SERVICE EQUIPMENT
(BUS BAR WEATHERHEAD)
Illustration 27

502.2 Service Drop Length

The maximum length of Service Drop which the Company installs will be governed by the amount and Type of Service and will be determined by Company personnel. Allowable voltage drop and mechanical factors, determined by the size and number of wires of Service Drop, impose limits on its length.

502.3 Service Poles

Where a service pole or poles must be set to provide proper clearance around or over driveways, garages, trees, or other obstructions on the premises, a charge shall be made for each such service pole required.

503 CLEARANCE FOR SERVICE DROP

503.1 Service Drop Conductors, when not in excess of 600 volts, shall at least have the minimum clearances at the lowest point of the drip loop or service drop listed in Illustration 28 – Clearances for Service Drop. (See below)

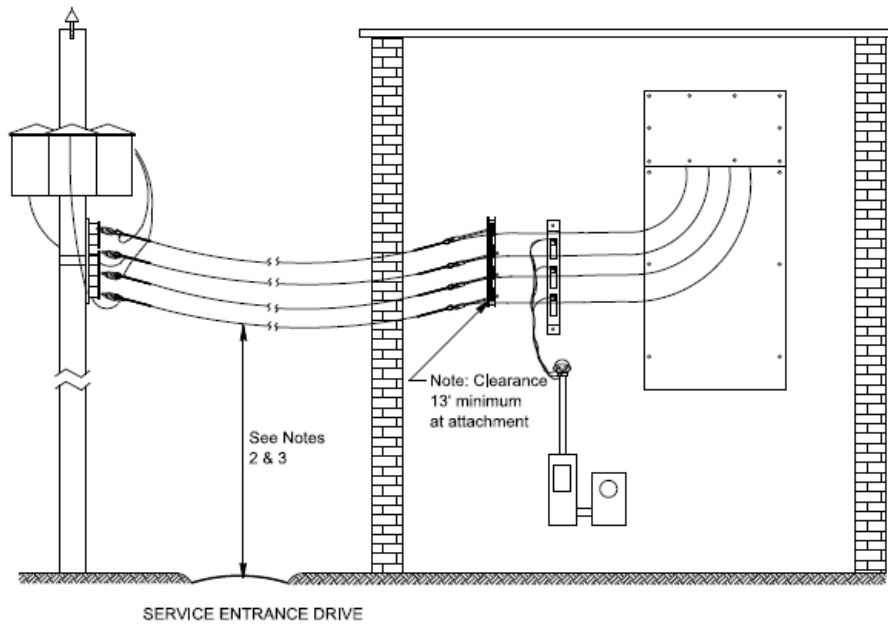

HORIZONTAL CLEARANCE

Service drop conductors attached to a building shall not pass closer than 3 ft. to windows, doors, or porches from which the service outlet may be accessible.

VERTICAL CLEARANCE TO GROUND FOR SERVICE DROP CONDUCTORS

	SECONDARY CONDUCTOR	
	0-480V/277	480V
1. Areas accessible to pedestrians, finished grade, sidewalks, residential driveways, or where truck traffic is not encountered. (Trucks shall be defined as any vehicle exceeding 8ft. in height)	12 FT.	15 FT.
2. Over non-residential driveways, parking lots, alleys, or other areas subject to truck traffic,	18 FT.	
3. Over public streets and roads.	22 FT.	

**CLEARANCES FOR SERVICE DROP
Illustration 28**

503.2 If an existing service is being modified and any revision in the service entrance raceway is made, the modified service must conform to the heights and clearances outlined in Illustration 28 (page 71).

503.3 Located no closer than 3 ft. to windows **and 5 ft.** to doors, porches or similar locations from which the Service Drop may be accessible. **This clearance is an NESC/NEC requirement and must be maintained.**

503.4 *Service Drops must be free of contact with trees. The customer shall trim all trees required to provide the necessary clearances.*

503.5 **Under no circumstances will the Company attach its Service drop to an intermediate structure installed by the Customer between the Company's Distribution Lines and the Customer's Service Outlet.**

504 LOCATION OF SERVICE OUTLET

504.1 The location must be at a sufficient height above ground level to provide proper clearances for the Service Drop, as required by ARTICLE 503. For the open wire type Service Drop, the Service Outlet shall not be less than **6"** no more than **18"** horizontally and not less than **6"** nor more than **12"** above the Point of Attachment. (See Illustration 25 – Typical Commercial Open Wire Service Installation, on page 68).

504.2 Service Outlet shall be located so that neither the Company's Service Drop nor the Customer's Service Entrance Conductors are nearer than 12" to any telephone or signal wires, whether in the air or on the building.

505 GROUPING OF SERVICE OUTLETS

If a building has an established Service Outlet location which conforms to the above requirements, then any additional Service Outlets shall be located within **18"** of this established point. **NO MORE THAN SIX WEATHERHEADS SHALL BE INSTALLED AT EACH SERVICE OUTLET LOCATION.** If the established location does not conform to these requirements, then all Service Outlets shall be combined at a satisfactory point specified by the Company. When the total cross-sectional area of all Service Entrance Conductors at a service outlet location exceed 2-1000 KCMIL per phase, a bus bar type weatherhead must be used. (See Illustration 27 – Arrangement of Overhead Commercial Service Equipment, on page 70).

506 POINT(S) OF ATTACHMENT

506.1 Provisions: A solid Point of Attachment for supporting the Service Drop on the building shall be provided by the Customer at a point which will comply with the provisions of ARTICLES 503 and 505. **The Point of Attachment shall not be more than 25 feet above ground.** (See Illustration 28, on page 71). Company personnel will specify on the Service Outlet Location, the height of the Point of Attachment if it must be less than the minimum or greater than **25 ft.** above grade.

506.2 Clearances: Where the required heights and clearances specified above cannot be maintained, the Customer shall provide an extension support, which is of a permanent nature and of sufficient strength to support the Service Drop at the required minimum clearance. In such cases, the Customer's Service Outlet is to be located above the service support at a height which will permit the required clearance. If a Service Mast will not have sufficient strength to properly support the Service Drop, installation of a service bracket will be required.

507 ANCHORAGE FOR SERVICE DROP

507.1 Installation: The Customer shall install the Service Drop support in accordance with ARTICLE 506.2. The type of Service Drop (open wire) to be installed shall be determined in accordance with ARTICLE 502. The service drop support must be installed as securely as possible to minimize damage to the installation from storms, falling branches, or other hazards.

507.2 Open Wire Drop: For an open wire Service Drop the Customer shall install a secondary rack fastened to his structure with two **5/8"** galvanized machine bolts of sufficient length for the threaded end of the bolt to extend **2"** beyond the surface of the wall and so installed that each bolt will be capable of withstanding a pull of **300 lbs.** The bolts shall be installed vertically **16"** apart with the bottom bolt not less than **12'-0"** nor higher than **23'-4"** above ground level. When required ground clearance cannot be obtained otherwise, the Customer's Contractor shall secure written permission from the company to install the bolts horizontally with the same spacing as for vertical installation. The company will supply the bolts and rack when requested by the customer. When the service entrance phase conductors exceed 2-500 KCMIL per phase, the Service Drop anchorage arrangements shall be in accordance with Illustration 30 – Weatherhead Arrangement for Outdoor Metering, page 75. In Addition, when service entrance phase conductors **do not** exceed 2-500 KCMIL per phase, see Illustration 29 – Weatherhead Conduit Spacing - CT Box Arrangement for Outdoor Metering, page 74.

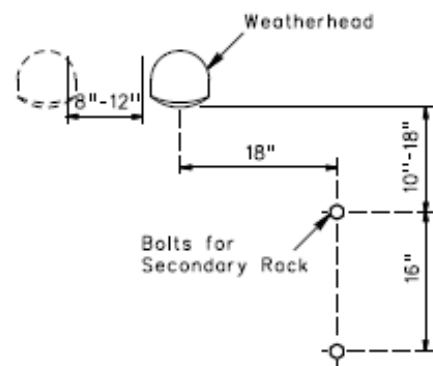
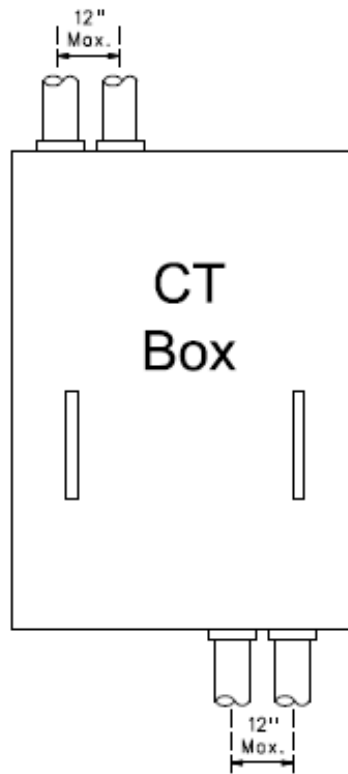

VERTICAL RACK ARRANGEMENT
ONE OR TWO WEATHERHEAD

WEATHERHEAD CONDUIT SPACING
CT BOX ARRANGEMENT FOR OUTDOOR METERING

(Article 507.2)
Illustration 29

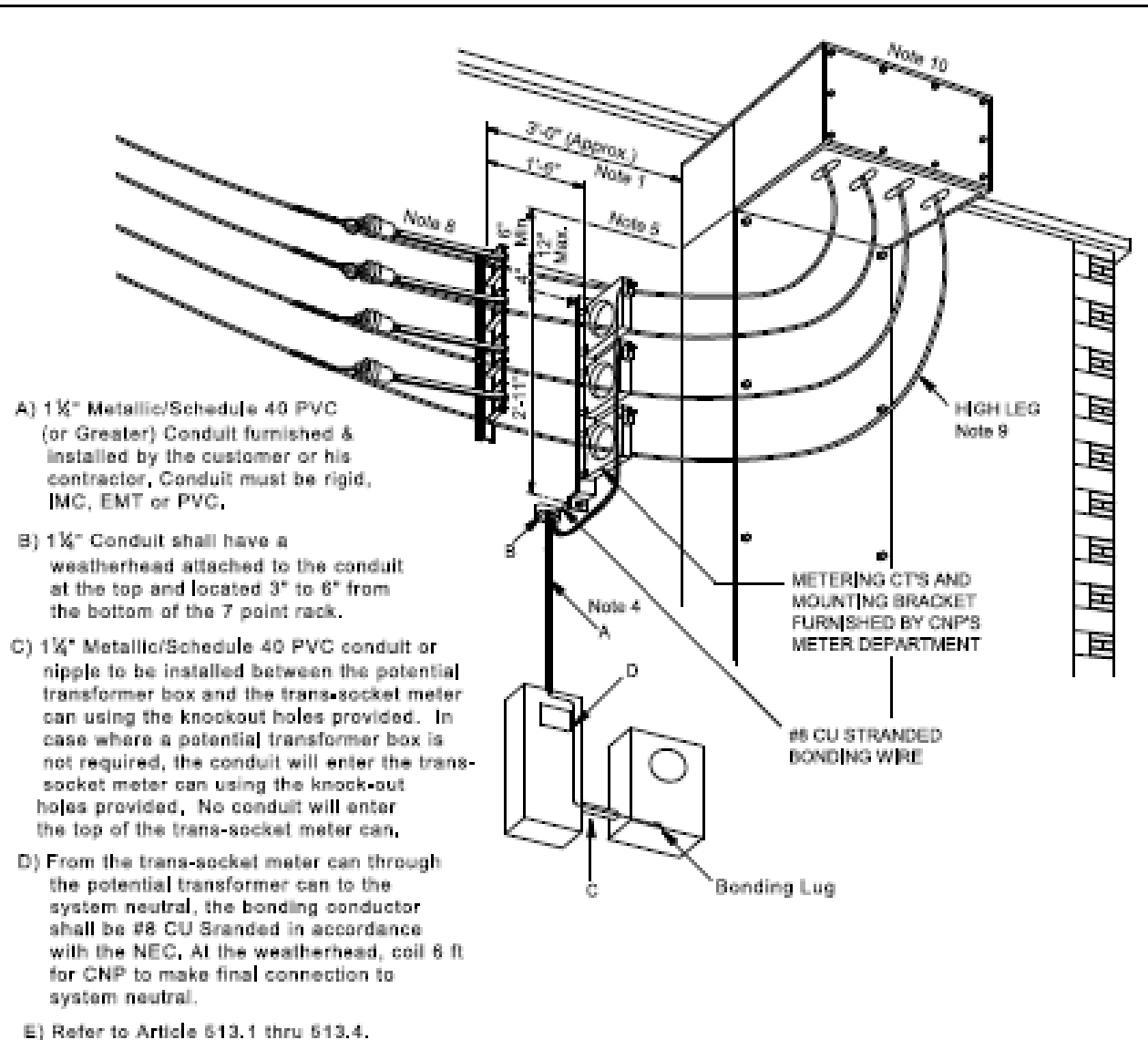

Notes:

1. If outdoor current transformers are not used, this dimension shall be reduced to 1' - 6",
2. Customer to install three (3) 5/8" machine bolts in wall, sixteen (16) inches apart vertically with two (2) inches of threads protruding. Each bolt shall be capable of withstanding a pull of three hundred (300) pounds,
3. This point of attachment shall not be more than 23 feet nor less than the minimum stated in Article 503,
4. Customer to install two (2) 1/2" G.I. bolts protruding 2" from wall for outdoor metering only. See Note 1,
5. Attachment must be installed below weatherhead 6" to 12" maximum.
6. A seven-point rack shall be installed with anchorage as in Note 2.
7. For pole mounted installation, two pole structure must be used.
8. If conditions permit, one extension link part #111096 may be deleted per leg.
9. High leg will always be opposite of the neutral for all 240/120V, three phase, 4 wire Delta Services.
10. Bus bar weatherhead for phase conductors larger than 2 - 1000 KCMIL.

WEATHERHEAD ARRANGEMENT FOR OUTDOOR METERING

Illustration 30

508 SERVICE ENTRANCE CONDUCTORS

The Service entrance Conductors, as defined in ARTICLE 127, shall be installed in rigid metal conduit, intermediate metal conduit, electrical metallic tubing, Schedule 80 PVC conduit, or, as permitted by the local governing authority, may be an approved service entrance cable. Service Entrance Conductors shall be provided with a listed weatherproof entrance fitting where they extend from the Customer's conduit or raceway. **Service Entrance Conductors shall be continuous from the Point of Delivery to the CT box. Conductors shall not pass through any junction box or condulets, etc.**

Except for service to internally located metering rooms, as approved by the Company's Electric Engineering Department, the service raceway shall not be run through attics, in partitions, or in other enclosed spaces. Service Entrance Conductors shall extend beyond the service entrance fitting a distance sufficient to permit connection to the Company's Service Drop, but no less than 36" where an open wire Service Drop is to be used. (See Article 502.1.)

Except for multi-occupancy projects converting from master to multi-metering, Service Entrance Conductors shall not be installed in the same conduit or raceway with other wiring of the Customer, nor shall load wires from a meter be run in the same conduit or raceway with unmetered conductors. Customers contemplating the use of pre-wired/ganged type enclosures should consult the Company's Service Consultant in the area. Such installations require special contractual arrangements and submittal of detailed manufacturer's specifications for acceptance by Electric Engineering.

509 TRANSFORMER INSTALLATIONS ON CUSTOMER'S PREMISES

Under certain conditions, where large loads or considerable distances are encountered, it may be necessary to install transformers on the Customer's premises either overhead, or, at the Company's options and with special contractual arrangements, on the ground, or at the Company's options and with special contractual arrangements, in a transformer vault. See Article 512 for primary underground service in Overhead Areas. Transformers or other company equipment shall be installed in areas readily accessible by company vehicles for maintenance and replacement. Vehicular access shall not be blocked by permanent structures or landscaping. The requirements of such installations vary widely, and it is necessary in each case for the Customer to consult the Company's Service Consultant in the area so that satisfactory arrangements may be made to cover the installation. This contact should be made as early as possible to ensure that adequate time is allowed for ordering equipment and acquisition of easements.

510 TEMPORARY INSTALLATIONS

Where service is required for construction or other temporary purposes, the Customer shall provide a suitable location and anchorage for the Company's Service Drop and Meter. Temporary service will be installed at the Customer's expense.

UNDERGROUND SERVICE

511 COMMERCIAL UNDERGROUND

Commercial Customers desiring Underground Service should contact the Service Consultant in the area so that Electric Engineering may develop the Service Specifications as required. The Company shall make all connections between the Company's equipment, cables, or conductors and the Customer's Service Entrance Conductors. Consult the Company's Service Consultant in the area for charges for standby time of Company personnel during installation of service conductors by electrical contractors into three-phase pad-mounted transformers.

512 UNDERGROUND SERVICE LATERALS IN OVERHEAD AREAS

512.1 Requirements: It is necessary for Customers planning to install Secondary Underground Service in Overhead Distribution Areas to consult the Service Consultant in the area to arrange for a Service Outlet Location and Data Statement as set forth in ARTICLE 203 and obtain the necessary Service Specifications for the installation. The Customer's Underground riser conduit may be installed on CenterPoint Energy poles where the poles are located on Customer's property or immediately adjacent in the street right-of-way or utility easement. Customer's service riser may be installed on a service pole if located on the Customer's property. Service poles will be provided ONLY if the standard service extension requires them. If service poles are not required for standard service extension, the Customer shall install and maintain a separate pole for the underground riser. **The maximum riser conduit attached directly to a service pole shall not exceed one 3" conduit.** Larger conduit and multiple conduits may be installed on poles of sufficient strength, but they must be installed on stand-off brackets (See Illustration 31 – Conduit Riser on Stand-off Brackets, next page).

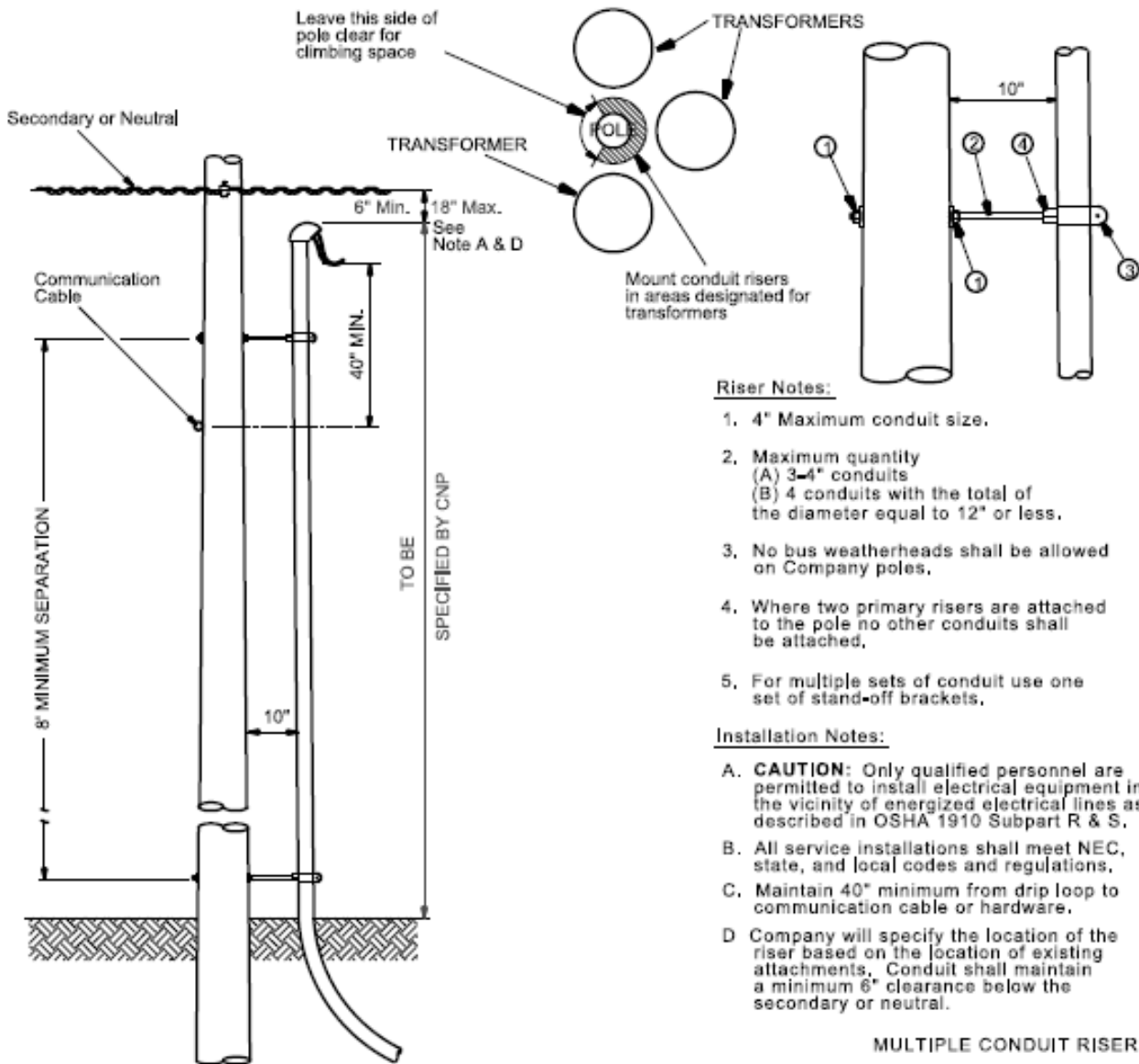

Riser Notes:

1. 4" Maximum conduit size.
2. Maximum quantity
(A) 3-4" conduits
(B) 4 conduits with the total of the diameter equal to 12" or less.
3. No bus weatherheads shall be allowed on Company poles.
4. Where two primary risers are attached to the pole no other conduits shall be attached.
5. For multiple sets of conduit use one set of stand-off brackets.

Installation Notes:

- A. **CAUTION:** Only qualified personnel are permitted to install electrical equipment in the vicinity of energized electrical lines as described in OSHA 1910 Subpart R & S.
- B. All service installations shall meet NEC, state, and local codes and regulations.
- C. Maintain 40" minimum from drip loop to communication cable or hardware.
- D. Company will specify the location of the riser based on the location of existing attachments. Conduit shall maintain a minimum 6" clearance below the secondary or neutral.

CAUTION
DO NOT CLIMB OR
EXTEND CONDUIT ABOVE
NEUTRAL OR SECONDARY
See Note A

MATERIAL LIST		
ITEM NO.	QTY.	DESCRIPTION
1	2	Washer square 2 1/4" X 2 1/4"
2	1	Bolt Double Arming 5/8" X 24"
3	AS	Strap Channel Pipe
4	REQ'D	Channel

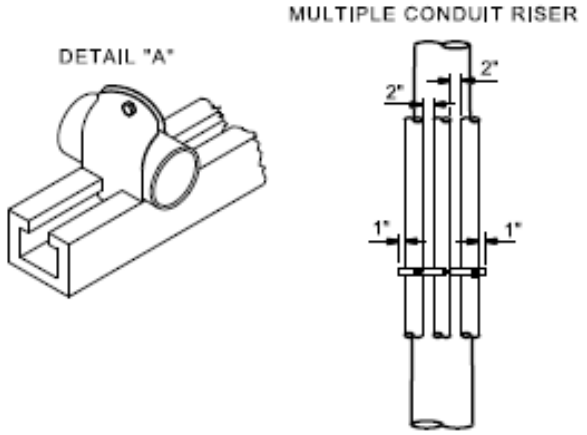

CONDUIT RISERS ON CONDUIT STAND-OFF BRACKETS
(Article 512.3)
Illustration 31

No more than four (4) conductors per phase and neutral shall be accepted per metered service (no more than 16 conductors per pole total for all services). (See ARTICLE 513.5 for limitation of conductors inside a metering current transformer box.) Customers' conduit installed on poles shall be only rigid metal, intermediate metal, or PVC Schedule 80. When the underground service entrance conduit is PVC and the riser on the pole is rigid or intermediate metal conduit, the Customer or Customer's contractor shall ground the riser in accordance with the National Electrical Code.

512.2 Service Conduit: Customer may attach service conduit not larger than 3" inside diameter directly to the pole. The Company's Service Consultant in the area will specify the Service Outlet Location when the Customer must attach the service conduit directly to the pole, as in residential areas. Conduit risers shall be permitted in order of service requests as shown in Illustration 32 – Conduit Risers Attached Directly to Pole on page 80. In the event a Company primary riser is attached to the pole, the primary riser shall be considered the #1 Customer, and any further Customer service risers shall be attached at the #2, #3, or #4 riser on pole. In the case where two Company primary risers are attached to the pole, no other conduit may be attached to the pole. See Illustration 32, page 80. Primary Underground Service in the Overhead Distribution Areas shall be supplied where, in the judgment of the Company, the size or service requirements of the load make such installation necessary. See ARTICLE 509 for Transformer Installation on Customer's premises.

CAUTION
DO NOT CLIMB OR EXTEND
CONDUIT ABOVE NEUTRAL
OR SECONDARY
 See Note A

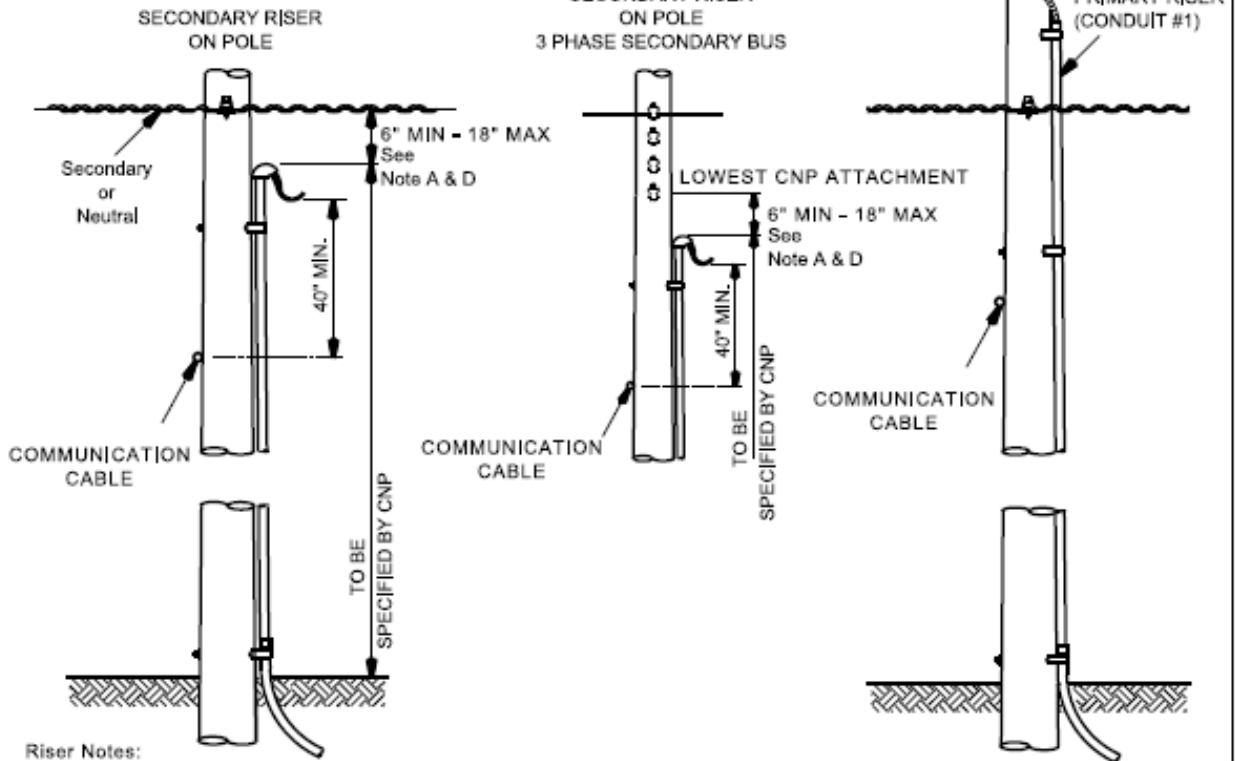

Riser Notes:

1. 1 - 3" Conduit Maximum
2. Treat existing CenterPoint Energy Primary Riser as conduit #1 in Detail "A", and Customer's Riser as conduits #2, #3, or #4.
3. Customer shall furnish all conductor and material to point of connection.
4. For multiple conduit installation see Illustration 8.

Installation Notes:

- A. **CAUTION:** Only qualified personnel are permitted to install electrical equipment in the vicinity of energized electrical lines as described in OSHA 1910 Subpart R & S.
- B. All service installations shall meet NEC, state, and local codes and regulations.
- C. Maintain 40" minimum from drip loop to communication cable or hardware.
- D. Company will specify the location of the riser based on the location of existing attachments. Conduit shall maintain a minimum 6" clearance below the secondary or neutral. If 35kV primary, maintain 6" below transformers if no neutral or secondary.

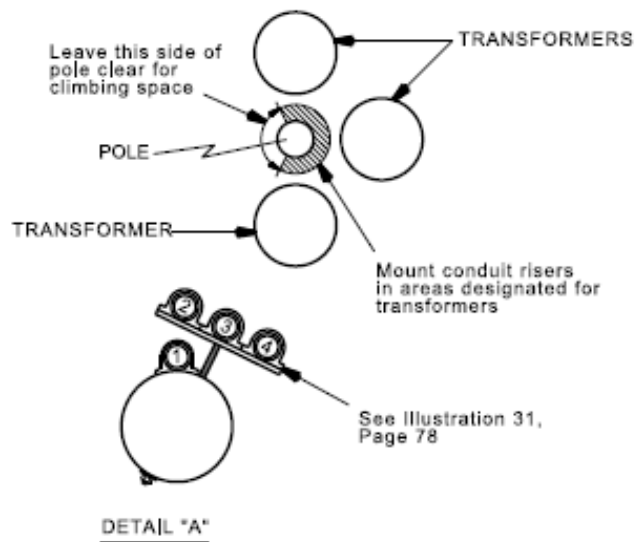

CONDUIT RISERS ATTACHED DIRECTLY TO POLE
 (Article 413.2)
 Illustration 32

512.3 Standoff Brackets: Customers must use standoff brackets for service conduit larger than 3” inside diameter. A maximum conduit size of 4” will be allowed. See Illustration 31 – Conduit Risers on Conduit Stand-off Bracket, on page 78, for suggested installation.

512.4 Service Riser Protection: Customer may not install theft deterrents that pose a safety hazard to CNP personnel.

513 METER INSTALLATIONS

Only CenterPoint Energy or its designated representative is authorized to install, remove or relocate a meter. CenterPoint Energy reserves the right to discontinue service to anyone violating this ruling.

513.1 Meter and Metering Equipment:

For instrument transformer rated installations, the Company shall furnish and own all equipment directly connected with the housing and protection of Meters and Metering Equipment. Application for such equipment will be made at the nearest Company Office listed on page 5. The customer will be asked to furnish the location of the establishment to be served, name of owner, and the type and size wire to be used in the Meter Loop at the location where the metering enclosure is to be installed. Meters and Instrument Transformers, where required, shall be installed by the Company at its expense. All connections to the Company’s Service equipment shall be made by Company personnel only. **Where a metering current transformer box or outdoor CT service is installed, a meter box and a 10” x 26” metering potential transformer box (if required) will be furnished by the Company and installed by the Customer or his Contractor.**

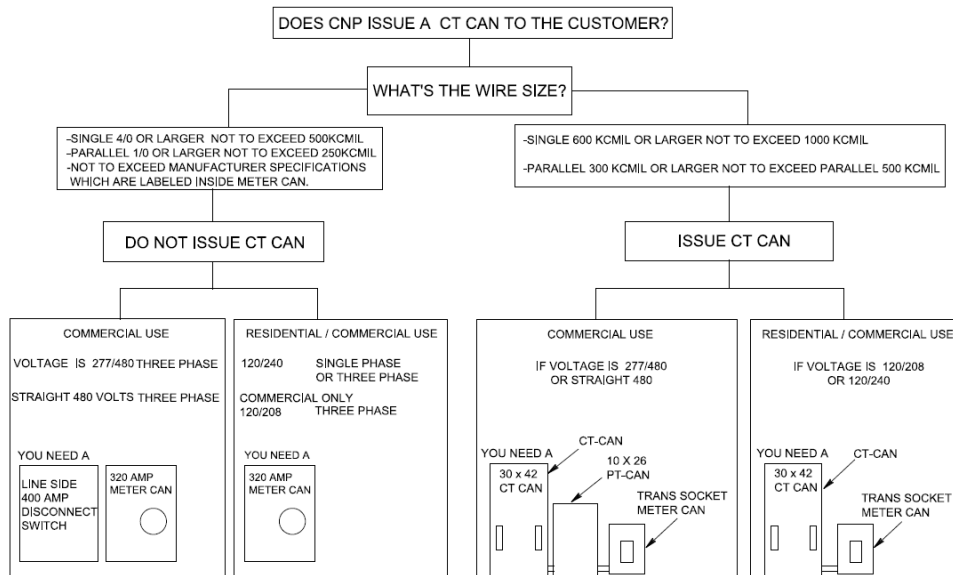

METER CAN DECISION FLOW CHART
Illustration 33

513.2 Instrument Transformer Installations

Applications: When the ampacity of the Service Entrance Conductors is greater than the ampacity of the Meter Mounting Device Information shown on page 81, it will be necessary for the Company to use current transformers in the metering installation. Potential transformers will be required on 480 volt and 480Y/277 Volt services.

Overhead Service: Where service is provided by Overhead Service Drops, current transformers will be mounted in a Metering Current Transformer Box in accordance with ARTICLE 513.5; or, they may be mounted outdoors without a Metering Current Transformer Box in accordance with ARTICLE 513.7. When required, potential transformers shall be mounted in a metering potential Transformer Box in accordance with Article 513.4. See Illustration 34 – Typical Outdoor Metering for Single Customer. (See Below) Service requiring current transformer installations may be paralleled in accordance with requirements outlined in Articles 513.3-513.9.

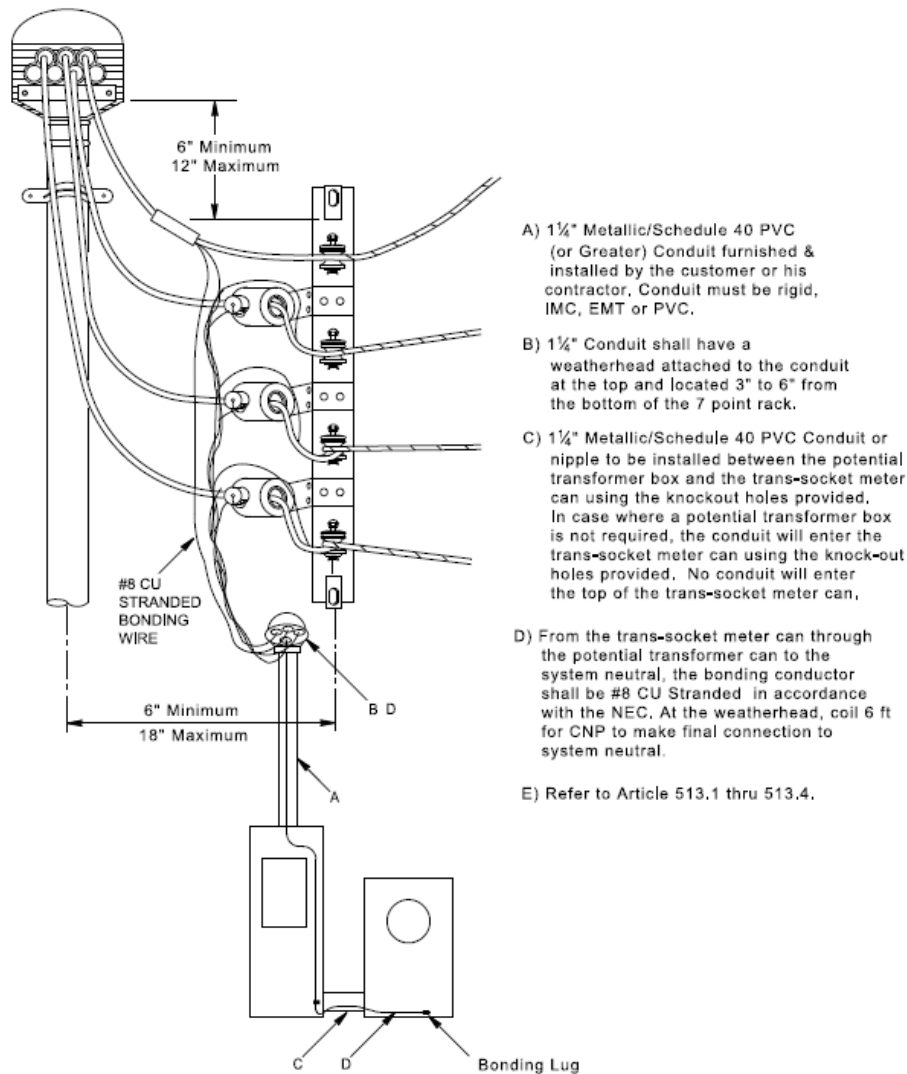

TYPICAL OUTDOOR METERING FOR SINGLE CUSTOMER
ILLUSTRATION 34

513.3 Metering Potential Transformer Box

Where a metering current transformer box or outdoor CT service is installed for 480 volt or 480Y/277 volt service, a 10" x 26" Metering Potential Transformer Box will be furnished by the Company and installed by the Customer or his contractor. The 10" x 26" metering potential transformer box shall be mounted between 4ft and 6ft above ground or floor level. Where a metering current transformer box is installed, the 10" x 26" metering potential transformer box shall be connected to the metering current transformer box with 1 1/4" metallic conduit, schedule 40 PVC conduit(or greater) or a 1 1/4" metallic nipple. Where an outdoor CT service is installed, 1 1/4" metallic conduit, schedule 40 PVC conduit(or greater) shall be run from the 10" x 26" metering potential transformer box to the bottom of the 7-point rack. Flexible conduit is prohibited. An outdoor weatherhead shall be installed on the conduit. The placement of the 10" x 26" metering potential transformer box shall not exceed 50' in distance from the current transformer mounting location.

513.4 Meter Can

Meter can will be installed adjacent to the metering potential transformer box and connected with a 1 1/4" metallic, schedule 40 PVC conduit(or greater) or nipple using the pre-cut 1 1/4 in. knockout holes at the base of the meter can. Flexible conduit is prohibited. No conduit will enter the top of the meter can. Where a metering potential transformer box is not required, the meter can will be installed with the same mounting requirements as the metering potential transformer box as listed in Article 513.3.

INDOOR MOUNTED CURRENT TRANSFORMERS

513.5 Metering Current Transformer Box (C.T. Can)

Metering Current Transformer Boxes will be furnished by the Company and installed by the Customer or his Contractor. The CT Can shall be installed between 24" to 48" from the bottom to finished grade as necessary clearance to install, remove and test equipment. For Services with ampacity in excess of the Self-Contained Meter Device Chart shown on page 48 or 81, a **30" x 42"** Metering Current Transformer Box should be used. (See Article 514.2 for wiring methods.) The Service Entrance Phase Conductors installed in a Metering Current Transformer Box may be made up of one wire (600 KCMIL through 1,000 KCMIL conductor) or two identical wires in parallel per phase (300 KCMIL through 500 KCMIL conductors). Each pair of paralleled phase conductors shall be the same color or shall be taped together or otherwise marked for easy identification. Conductors may not be paralleled where the total combined area per phase is less than 600 KCMIL (two 300 KCMIL) or greater than 1,000 KCMIL (2-500 KCMIL). **NO MORE THAN TWO CONDUCTORS PER PHASE SHALL BE USED REGARDLESS OF CONDUCTOR SIZE.** When the total cross-sectional area of Service Entrance Conductors are greater than 1,000 KCMIL (2-500 KCMIL) per phase, a bus bar type current transformer installation must be used, as shown in Illustration 35 – Bus Bar Drilling in Current Transformer Box, next page.

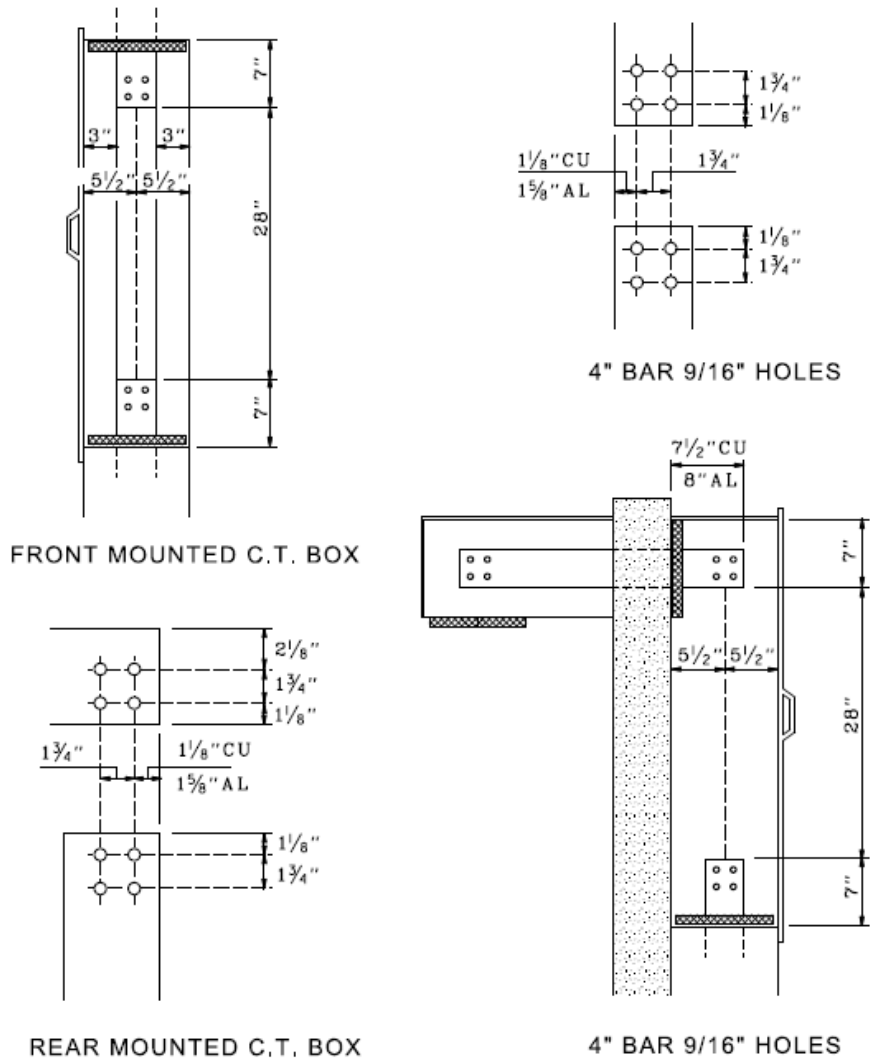

BUS BAR DRILLING IN CURRENT TRANSFORMER BOX

ILLUSTRATION 35

513.6 Bus Bar Weatherhead: When the service entrance requires conductors greater than **2-1000 KCMIL** per phase, a bus bar type weatherhead must be used. If the service entrance requires conductors less than or equal to **2-1,000 KCMIL** per phase, then the Customer may utilize either a bus bar type weatherhead or a conventional type weatherhead installation (See Illustration 30 – Weatherhead Arrangement for Outdoor Metering, page 75) or Illustration 34, page 82 with outdoor current transformers. See ARTICLE 513.7 – 514.2 for outdoor current transformer installation. Typical details of a bus bar type weatherhead are shown in the Illustrations 36-39, on pages 85-88. **All bus bar weatherheads must be approved by Company personnel.**

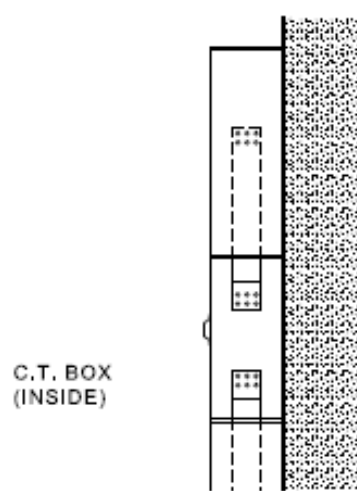
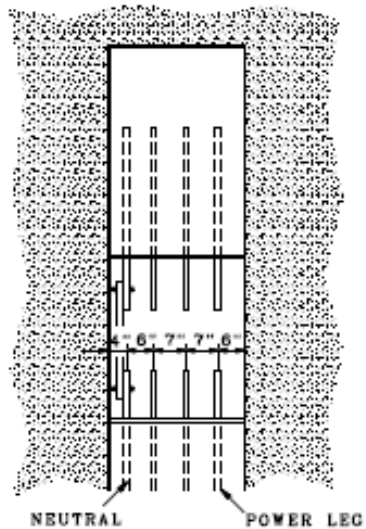
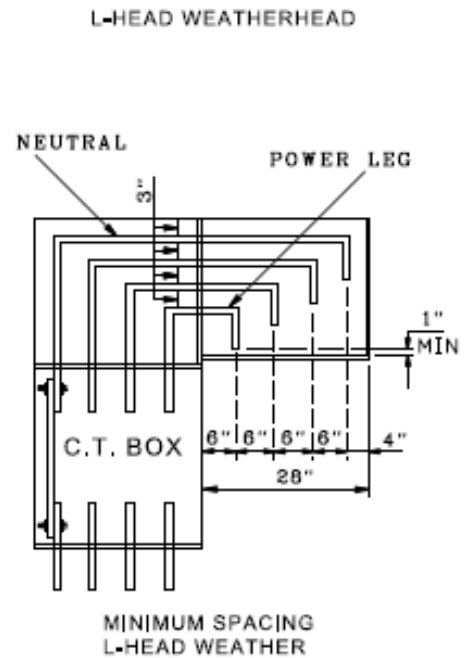
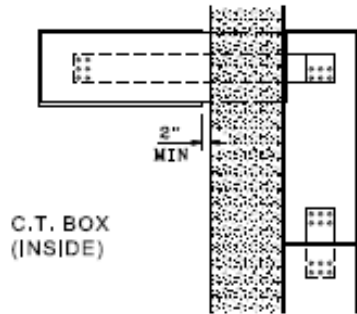
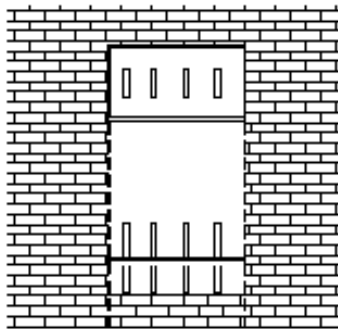
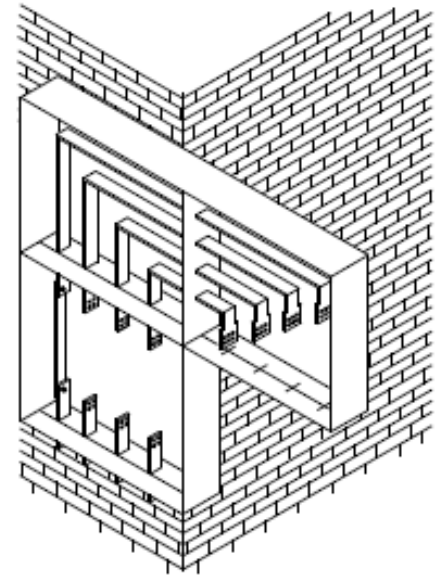
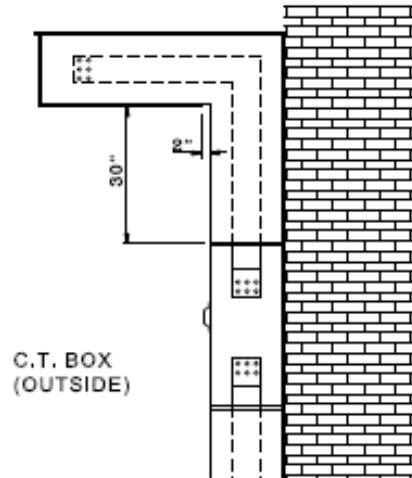
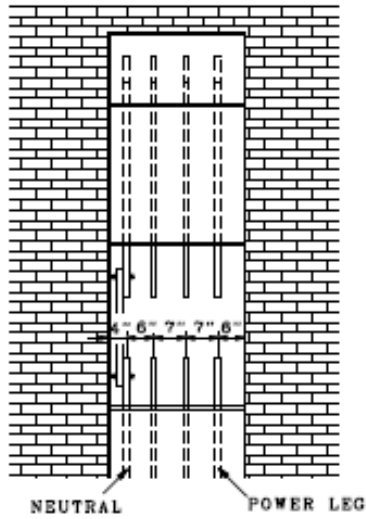

STANDARD WEATHERHEAD ASSEMBLY WITH MINIMUM CLEARANCES

FOR DIMENSIONS IN C.T. BOX, SEE STANDARD BUS ARRANGEMENT IN METERING CURRENT TRANSFORMER BOX.

NOTE: THE NEUTRAL BUS BAR(S) MUST BE ON THE SAME SIDE OF THE WEATHERHEAD AS THE PROPOSED POINT OF ATTACHMENT (7-POINT RACK) ON EVERY WEATHERHEAD.

TYPICAL BUS WEATHERHEAD, STANDARD AND L-HEAD

ILLUSTRATION 36

BUS BAR DRILLING - STANDARD WEATHERHEAD

BLACK PHENOLIC RESIN (GRADE N-1 OR XX)
OR PHENOLITE (GRADE GPO-3) SIZES AND
DRILLING DETAILS - STANDARD

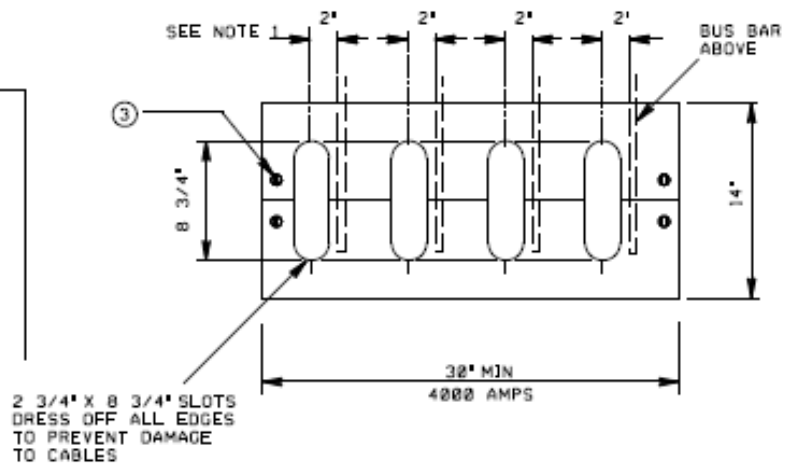
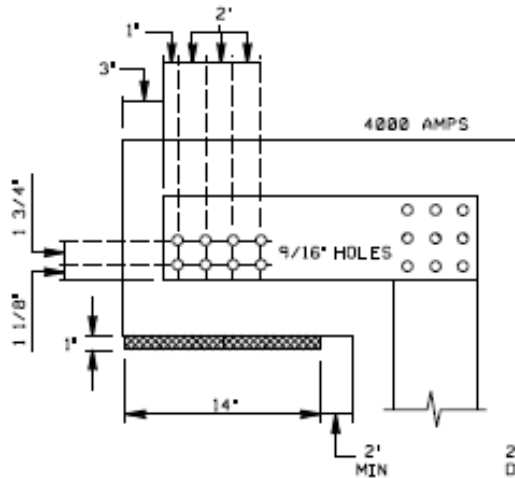
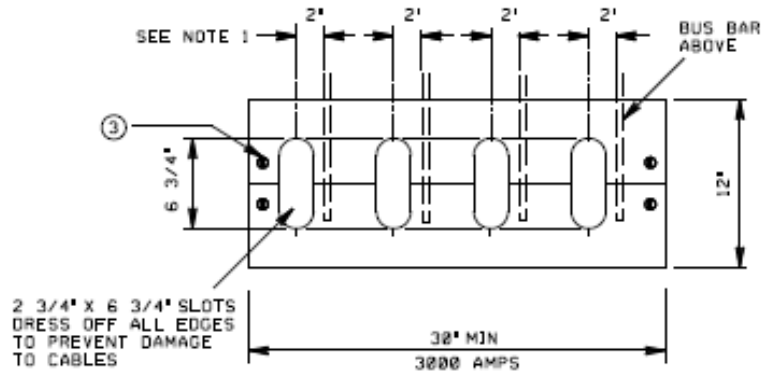
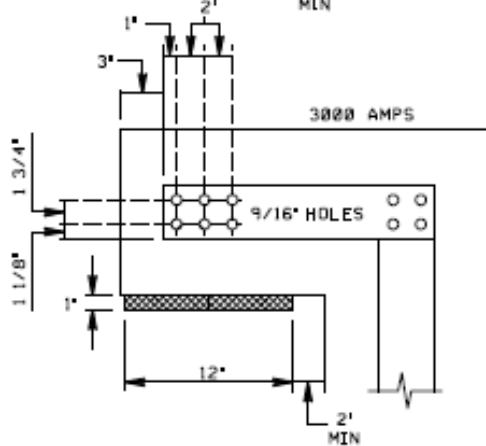
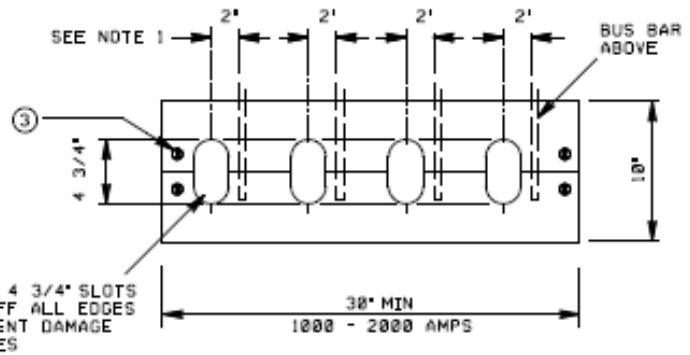
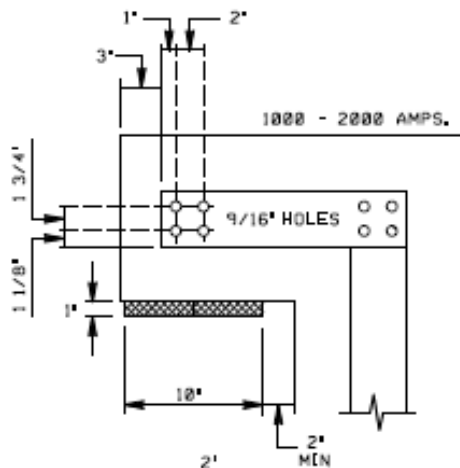

- ① CENTER LINE OF SLOT TO BE 2" OFF SURFACE OF BUS BAR.
- ② RADIUS OF PREDRILLED SLOTS TO BE 1 3/8".
- ③ WILDLIFE BARRIER MOUNTING MINIMUM 2" MACHINE BOLTS.

TYPICAL BUS WEATHERHEAD, STANDARD AND L-HEAD
Illustration 37

BUS BAR DRILLING - L-HEAD WEATHERHEAD BLACK PHENOLIC RESIN (GRADE N-1 OR XX)
OR PHENOLITE (GRADE GPO-3) SIZES AND
DRILLING DETAILS - STANDARD

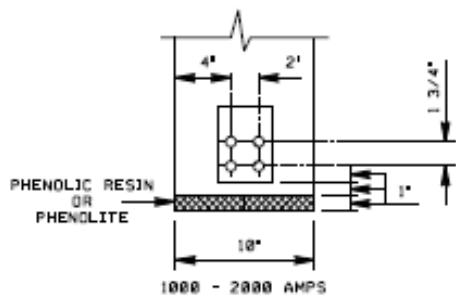

1000 - 2000 AMPS

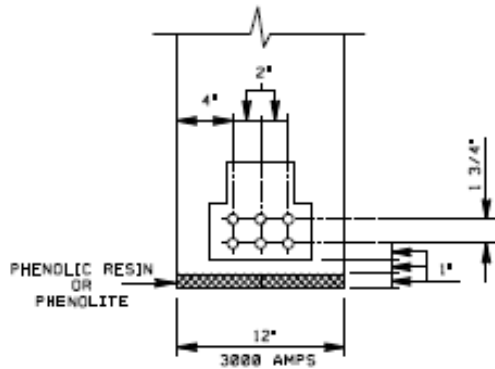

3000 AMPS

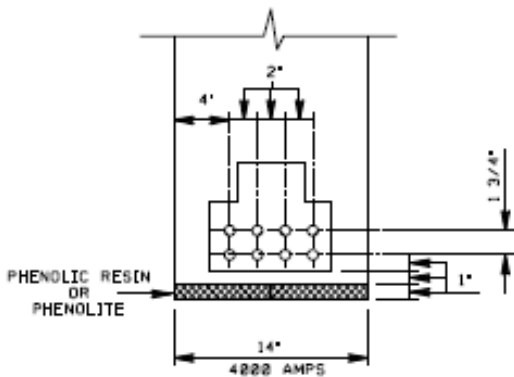

4000 AMPS

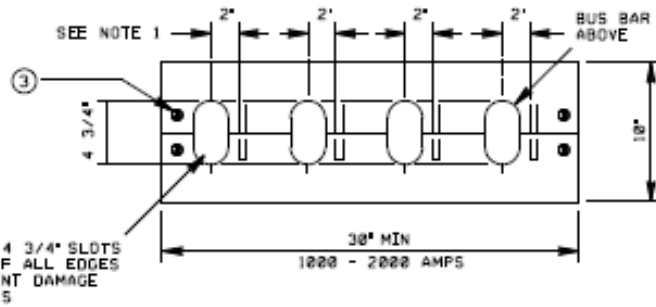

2 3/4" X 4 3/4" SLOTS
DRESS OFF ALL EDGES
TO PREVENT DAMAGE
TO CABLES

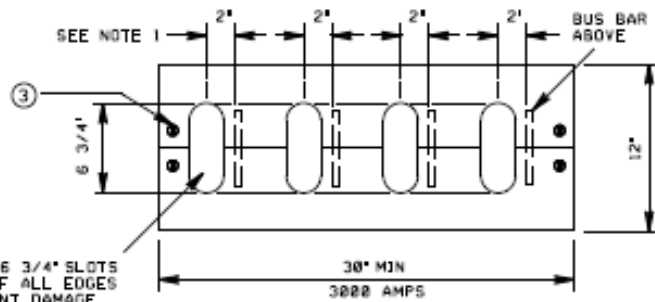

2 3/4" X 6 3/4" SLOTS
DRESS OFF ALL EDGES
TO PREVENT DAMAGE
TO CABLES

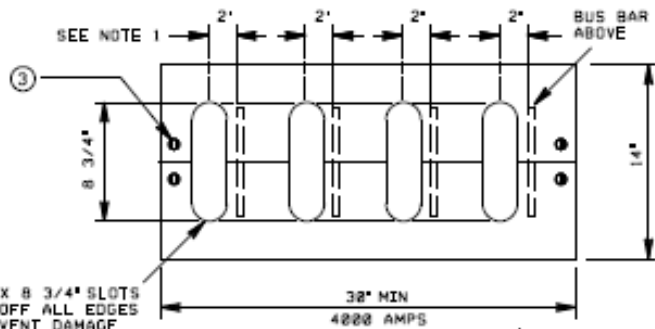

2 3/4" X 8 3/4" SLOTS
DRESS OFF ALL EDGES
TO PREVENT DAMAGE
TO CABLES

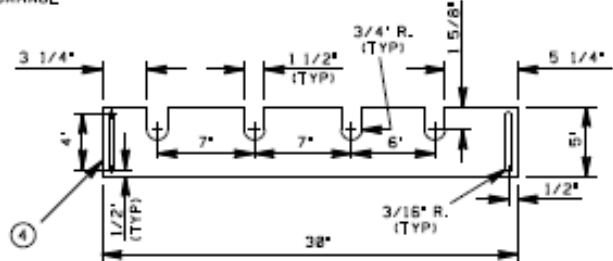

2 EA-WJLDLIFE BARRIERS
1/4" PHENOLIC RESIN

- ① CENTER LINE OF SLOT TO BE 2" OFF SURFACE OF BUS BAR.
- ② RADIUS OF PREDRILLED SLOTS TO BE 1 3/8".
- ③ WJLDLIFE BARRIER MOUNTING MINIMUM 2" MACHINE BOLTS.
- ④ MOUNTED OVER EXISTING WEATHERHEAD OPENING.

BUS BAR DRILLING, L-HEAD WEATHERHEAD
Illustration 38

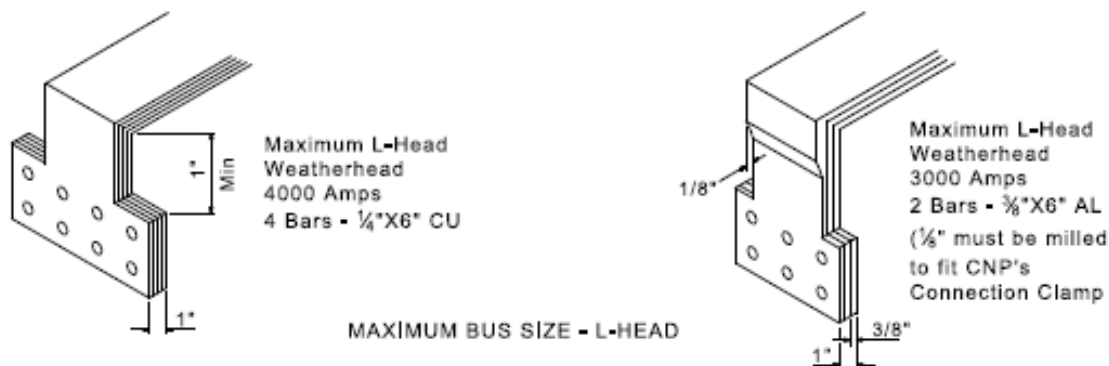
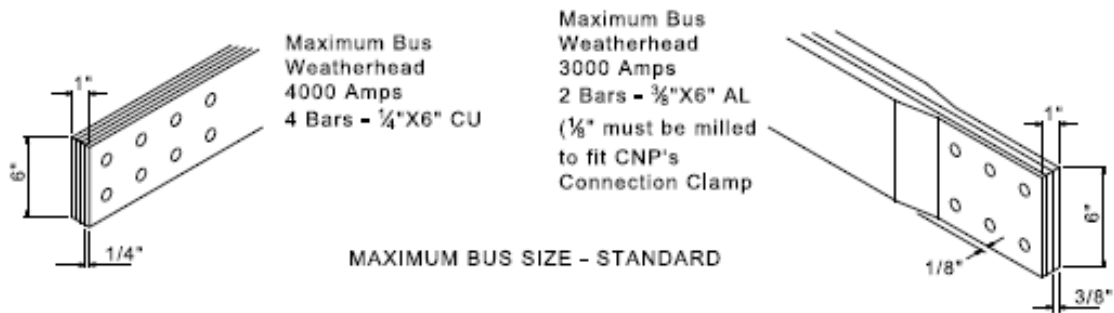

NOTES:

1. The Weatherhead shall be arranged to match the phasing type, number and size of CNP's conductors.
2. Weatherheads shall have sufficient mechanical strength and momentary rating to withstand the following short circuit currents:

CONTINUOUS RATING IN AMPS	SHORT CIRCUIT CURRENT IN AMPS RMS SYMMETRICAL	
	240 VOLTS	480 VOLTS
600 - 1000	35,500	35,000
1001 - 1600	68,000	53,000
1601 - 2000	68,000	60,500
2001 - 3000	98,500	85,600
3001 - 4000	140,000	85,600

3. The bottom of each weatherhead shall be equipped with removable covers of one (1) inch thick, black phenolic resin (grade N-1, or XX), or Phenolite (grade GPC-3), fastened with bolts and wing nuts arranged to take CNP meter seals. Cover shall be drilled for entrance of the conductors and split to allow removal of the covers without disconnecting the conductors.
4. The front cover of the weatherhead shall also be removable and arranged to take meter seal so as to allow access to the connections.
5. Weatherhead shall be installed with a minimum of three (3) feet of clear working space adjacent to all removable covers.
6. All connectors for connecting cables to bus weatherhead will be supplied by the CNP.
7. Each weatherhead shall include wildlife barrier boards. See Details on Illustration 38.

MAXIMUM BUS BAR STANDARD & L-HEAD WEATHERHEAD
Illustration 39

OUTDOOR MOUNTED CURRENT TRANSFORMERS (Outdoor C.T.)

- 513.7 Service Entrance Phase Conductors:** Where a building is designed to be occupied by a single Customer (one meter) and is served from an Overhead Service Drop, one set of outdoor mounted current transformers may be utilized. Where potential transformers are required, see Article 513.3. Service Entrance Phase Conductors for outdoor metering transformer installations may be made up of one wire (600 KCMIL through 1,000 KCMIL conductor) or two identical wires per phase (300 KCMIL through 500 KCMIL conductors). Each pair of parallel phase conductors shall be of the same color or shall be taped together securely or otherwise marked for easy identification. Conductors may not be paralleled where the total combined area per phase is less than 600 KCMIL (2-300 KCMIL) or greater than 1,000 KCMIL (2-500 KCMIL). **NO MORE THAN TWO CONDUCTORS PER PHASE SHALL BE USED REGARDLESS OF CONDUCTOR SIZE.**
- 513.8 Mounting Devices:** Where Service Entrance Conductors do not exceed 2-500 KCMIL per phase, the current transformers will be mounted on a standard secondary rack installed by the Customer or his Contractor in accordance with Illustration 34 – Weatherhead Arrangements for Outdoor Metering, on page 82. The Customer shall attach the rack to his structure with two 5/8” galvanized machine bolts of such length that the threaded end of the bolt will extend 2” beyond the surface of the wall, and the bolts are to be anchored so that each bolt will be capable of withstanding a pull of **300 lbs.** Where Service Entrance Conductors exceed 2-500 KCMIL (1-1,000 KCMIL) per phase, the current transformers will be mounted on a separate mounting bracket supplied and installed by the Company. The Customer shall install two 1/2” galvanized bolts with the threaded ends protruding 2” from the wall in accordance with Illustration 30 – Weatherhead Arrangements for Outdoor Metering, on page 75.
- 513.9 Service Mast Installations:** Where a service mast type installation is used in conjunction with outdoor mounted current transformers, the Customer shall provide 1 1/4” metallic conduit or schedule 40 PVC conduit (or greater) through the roof connecting to the 10” x 26” meter box/metering potential transformer box.
- 513.10 Customers Ineligible for Outdoor C.T. Service:** In a building where more than one Customer (more than one meter) is to be served from a single Overhead Service Drop, outdoor metering shall not be used and each Customer (meter) requiring current transformers must install a Metering Current Transformer Box (and a Metering Potential Transformer Box, if required.) However, where service has been provided to a building occupied by only one Customer (one meter) utilizing outdoor mounted metering transformers and the building is later divided so as to add one or more additional Customers (meters), the added Customers will be served through self-contained metering or current transformer metering as required. Each added Customer requiring current or potential transformers must install a metering Current Transformer Box (and a Metering Potential Transformer Box, if required) and a protective meter box. The original outdoor metered service may be retained, but not more than two additional weatherheads, with a maximum of 1-1,000 KCMIL per phase in each weatherhead, will

be connected to the Service Drop, provided the total combined load does not exceed 1,500 kVA.

513.11 Meter Equipment Bonding:

- The customer is responsible for bonding connections for cable and bus CT Services.
- All non-current carrying metallic parts to be effectively bonded with copper conductors.
- The Meter Box, PT Box and CT Box shall be bonded with nut/bolt bonding lugs.
- The Bonding Conductor (Supply Side Bonding) for the CT Box shall be in accordance with NEC Table 250.102(C)(1). Coil 5 Ft. for the Company to make final connection to Bonding Lug.
- From the Meter Box to the CT Box, the Bonding Conductor shall be #8 CU stranded insulated in accordance with the NEC.
- The Company will install the secondary wiring between the instrument transformers and the meter. Also, the Company will install the final bonding connection to system neutral.

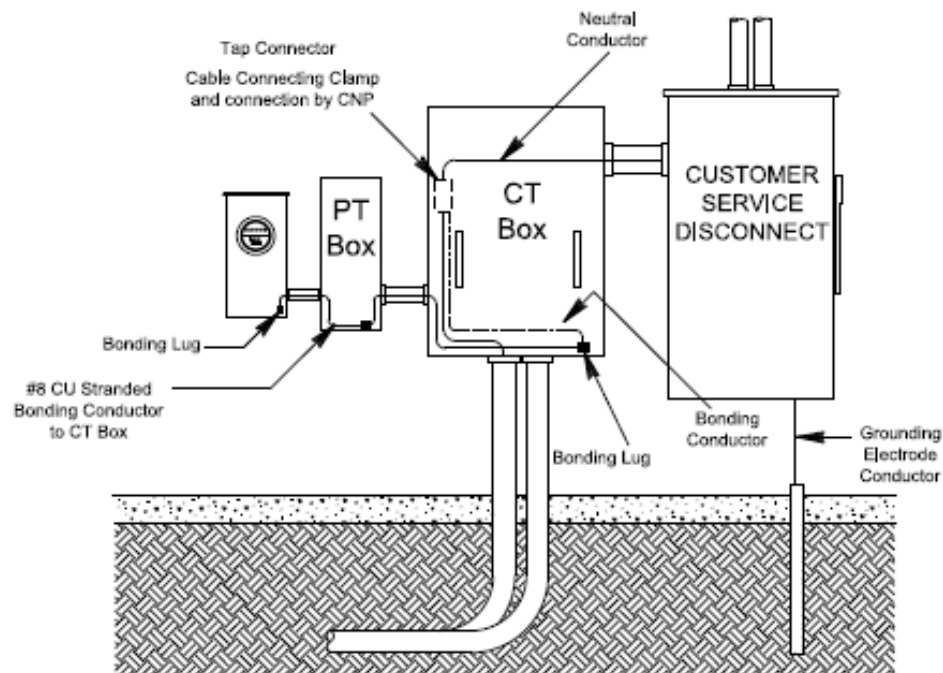

METER EQUIPMENT BONDING
(TYPICAL CABLE SERVICE)

Illustration 40

514 METHODS OF INSTALLING METERING EQUIPMENT

514.1 Metering current and potential transformer boxes and meter boxes shall be installed by the Contractor with a free space of at least **36"** in front, **2"** on the sides and **6"** on top and bottom. Current transformer boxes shall be installed **24" to 48"** from the bottom to finished grade as necessary clearance to install, remove, and to test equipment. The free space shall be over the Customer's property or public ways and shall not encroach upon the property of others even though there may be a utility easement in the area of encroachment. The Customer shall install a meter box as required at a location which will provide these clearances, and which will meet all conditions listed in Article 513.

514.2 Where a Metering Current Transformer Box is used, it should be mounted with the service and load conduits entering and leaving on opposite end sections of the box. If necessary, the conduit may enter the back of the box at the extreme ends. The length of both line and load leads entering the Metering Current Transformer Box shall be **48"** for **30" x 42"** boxes. If both line and load conduits must enter one end section of the **30" x 42"** box, one set of lead must be **72"** long and the other set of leads must be **48"** long. Holes cut in Metering Current Transformer Boxes must be cut with a hole cutter and must not be burned. If hubs are installed in Metering Current Transformer Boxes, they must be waterproof and not welded, brazed, or soldered. See Illustration 41-Current Transformer Box Modification (see below).

GENERAL INSTRUCTIONS FOR USING 30" X 42"
CURRENT TRANSFORMER BOX

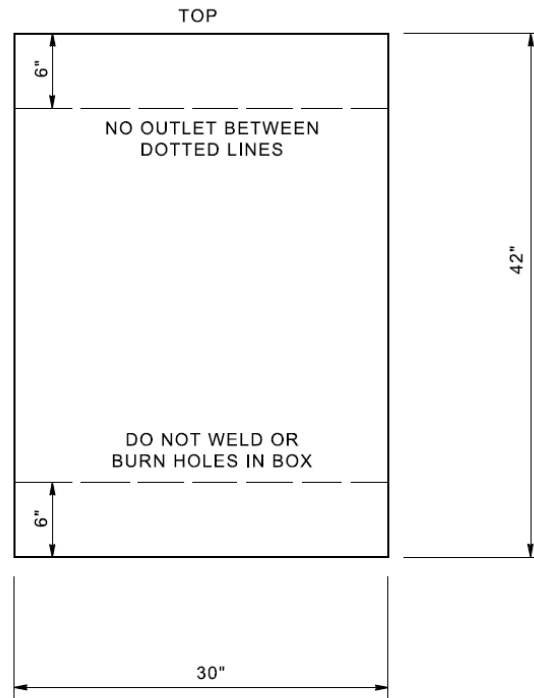

CURRENT TRANSFORMER BOX MODIFICATION

ILLUSTRATION 41

515 METER LOCATION

515.1 In all cases, the meter should be located in a position that is readily accessible to Company employees at all times without Customer assistance.

515.2 All instrument transformer rated meters shall be installed outdoors where practical. In locations where outdoor installations are impractical, commercial and industrial meters may be installed indoors; but the Company must be consulted prior to the installation.

515.3 Meters shall not be located where they will interfere with traffic on sidewalks or driveways, or where they will obstruct the opening of doors or windows.

515.4 In those special cases where metering equipment is installed indoors, it shall be located in a clean, dry place, free from vibration and readily accessible during normal working hours. It shall not be installed in toilets, bathrooms, elevators shafts, boiler rooms, attics, balconies, kitchens, stairways, ventilators, storage sheds, moving machinery or hazardous locations.

515.5 Metering equipment shall be installed on a wall which is a substantial part of the building itself or on a meter pole. Temporary partitions, etc., which are subject to replacement or excessive vibration shall not be used. Meters or metering equipment shall not be installed on the Company's poles.

515.6 Meters or current transformers shall not be installed in or directly on switchgear cabinets.

516 METER SEALS

It is the regular practice of the Company to seal or lock all meters, meter test switches, terminal boxes, current transformer cabinets and terminals of current transformers. No one but the Company's agents and persons authorized by law are permitted to remove a Company seal or lock.

517 INSTRUMENT TRANSFORMER RATED METER INSTALLATION SEQUENCE

THE SEQUENCE OF CONNECTIONS SHALL BE AS FOLLOWS:

SERVICE – METER – SWITCH – FUSE - LOAD

For certain multi-level structures, the most feasible method of serving individually metered tenants often includes metering gutters located within the building proper and remote to the Point of Delivery of Electric Service. With such service arrangements, National Electrical Code requirements, building design, and Customer wiring costs also make the installation of a disconnecting means between the Point of Delivery and the remote metering gutter a desirable alternative. **REQUESTS FOR THE INSTALLATION OF A DISCONNECTING MEANS ON THE LINE SIDE OF A REMOTE METERING GUTTER MUST BE REFERRED TO ELECTRIC ENGINEERING FOR APPROVAL OF THE ARRANGEMENT DURING EARLY DESIGN STAGES, PRIOR TO INSTALLATION OF EQUIPMENT.** Failure to obtain the required approval may result in the Company refusing to energize equipment installed by the Customer. The sequence of connections for individual meter installations served from a metering gutter shall be as stated above. The service disconnecting means shall be installed at a readily accessible location either outside of a building or structure, or inside nearest the point of entrance of the service conductors. The intent of the foregoing is to locate the disconnecting means as close as possible to the meter. **For all new services, Company personnel must be able to verify that the main disconnect is open before energizing service.**

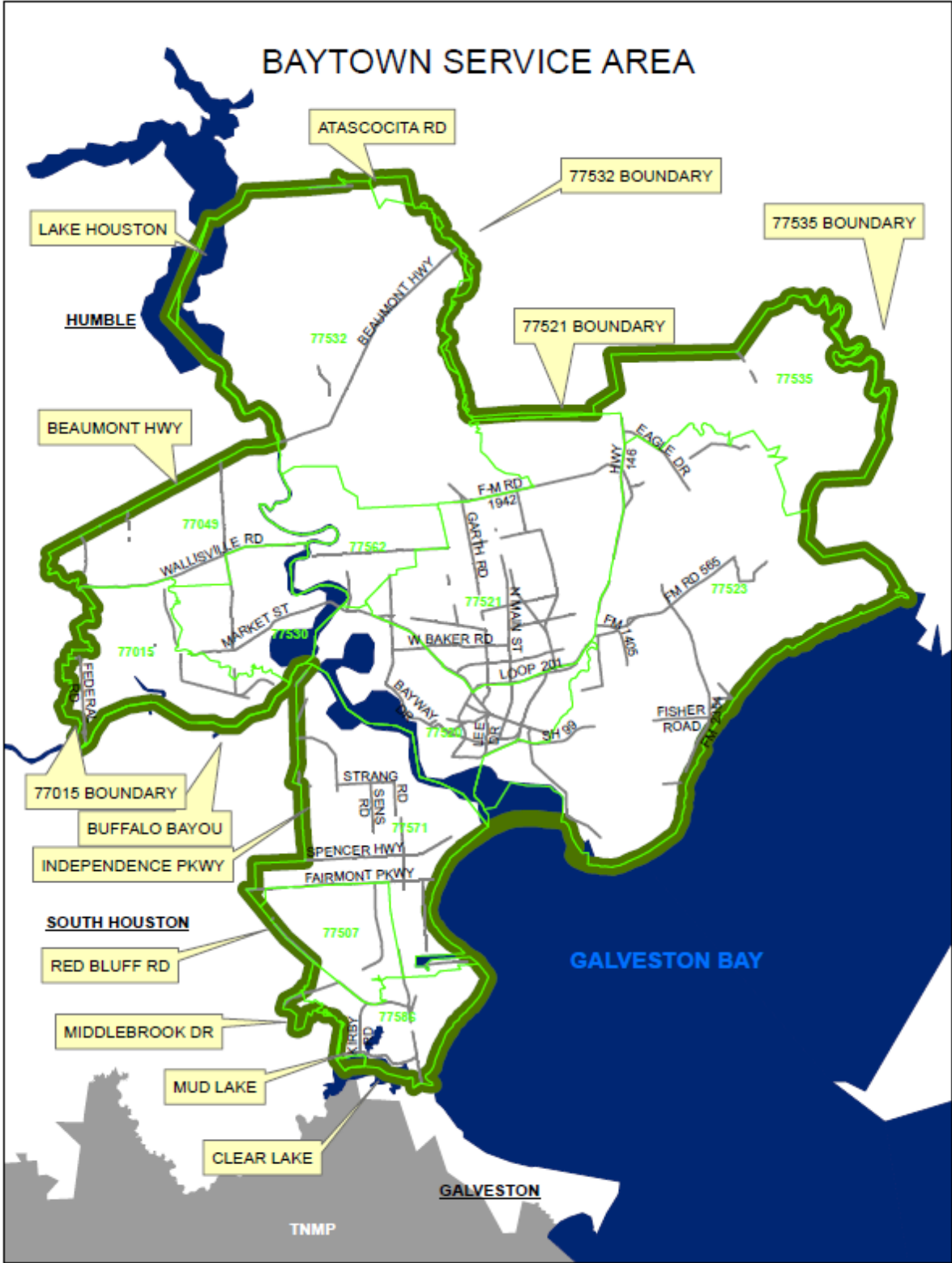

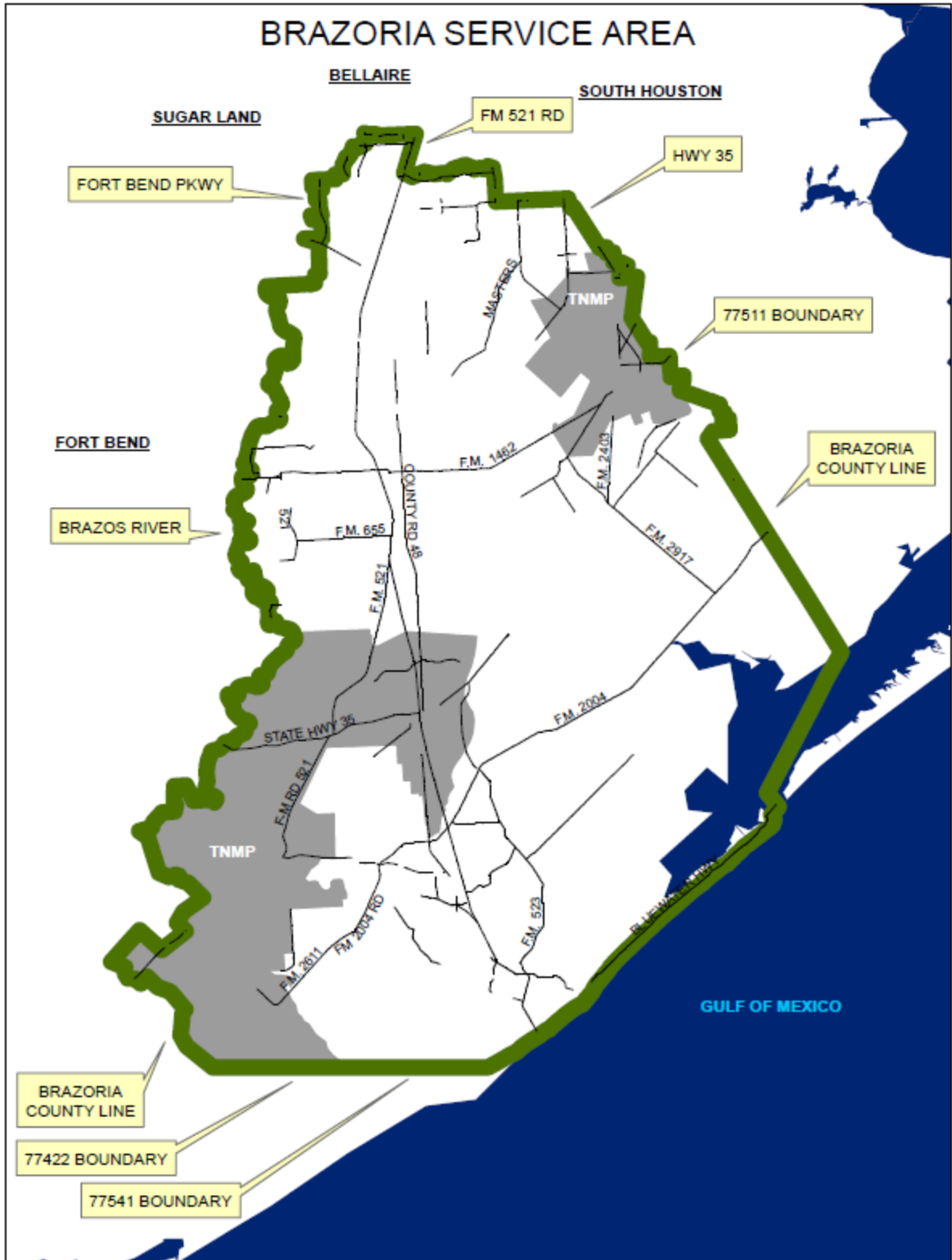

FORT BEND SERVICE AREA

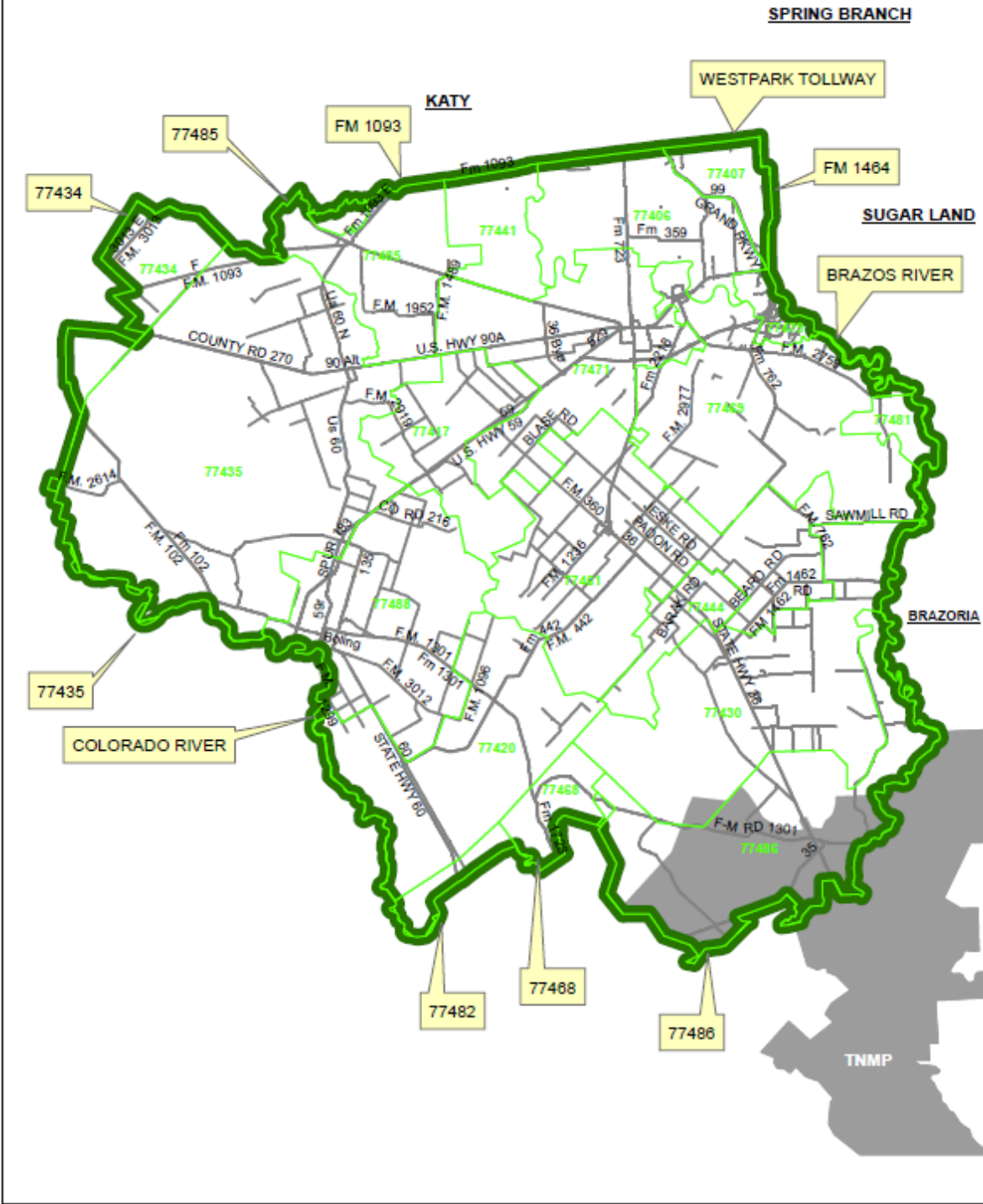

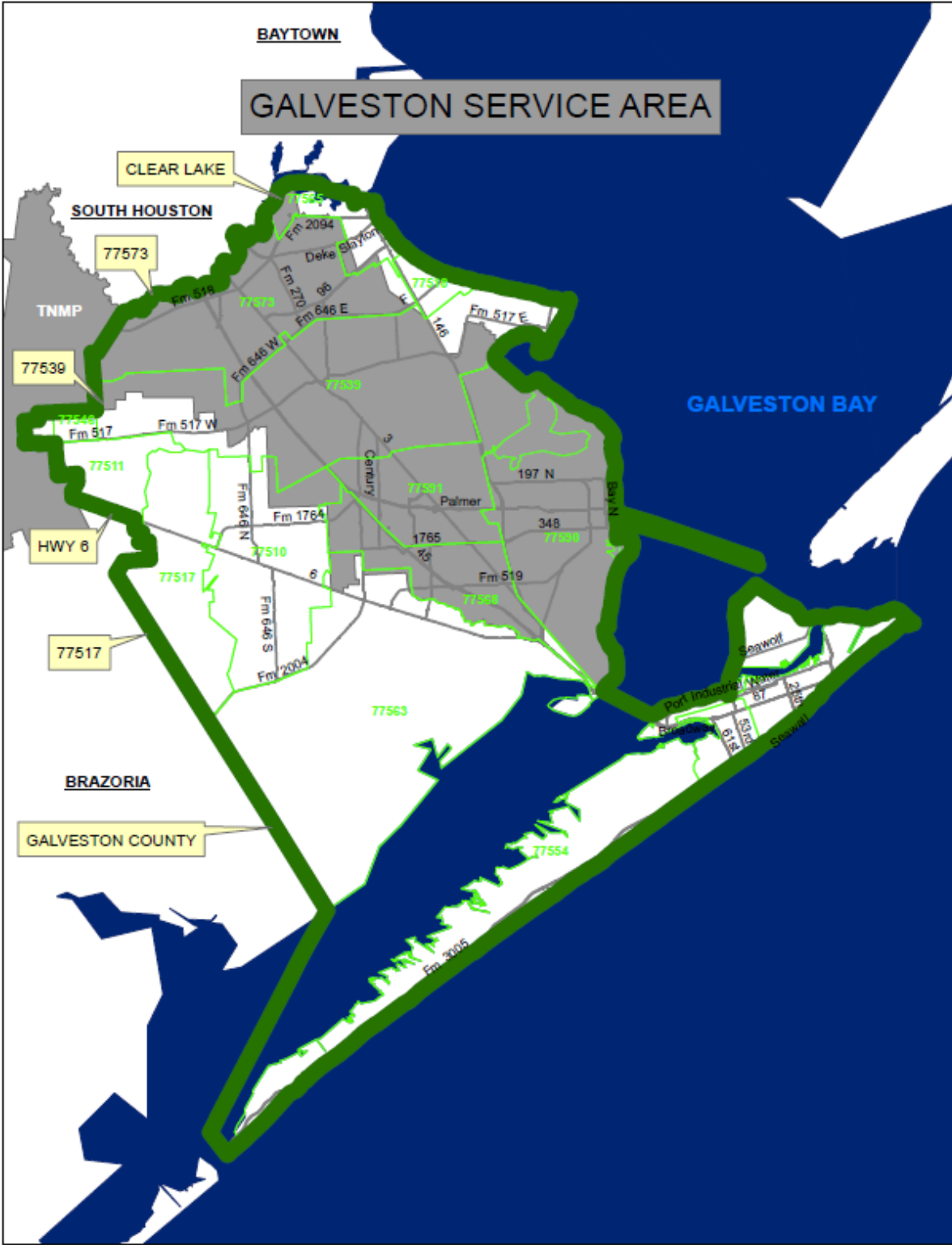

GREENSPPOINT SERVICE AREA

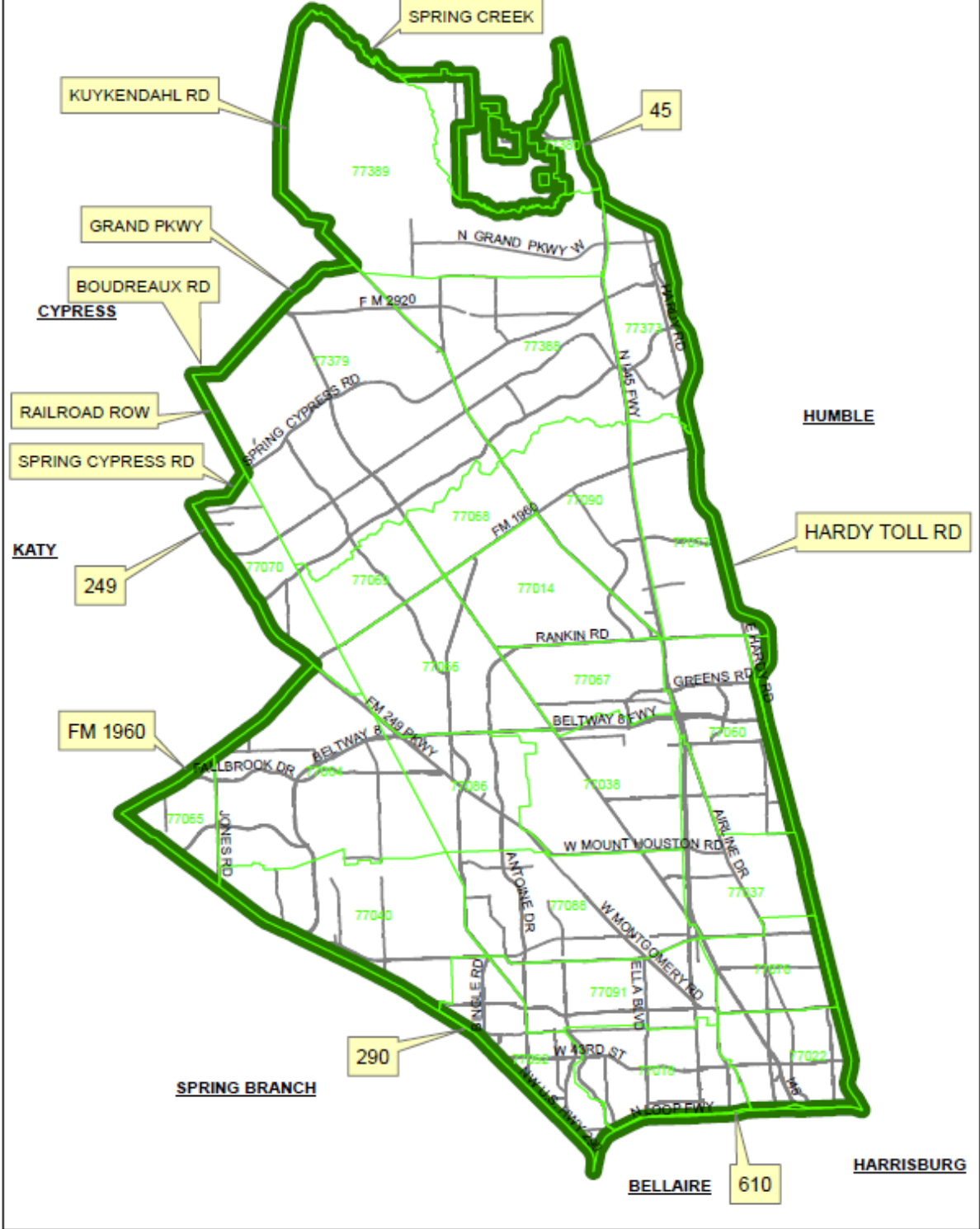

HARRISBURG SERVICE AREA

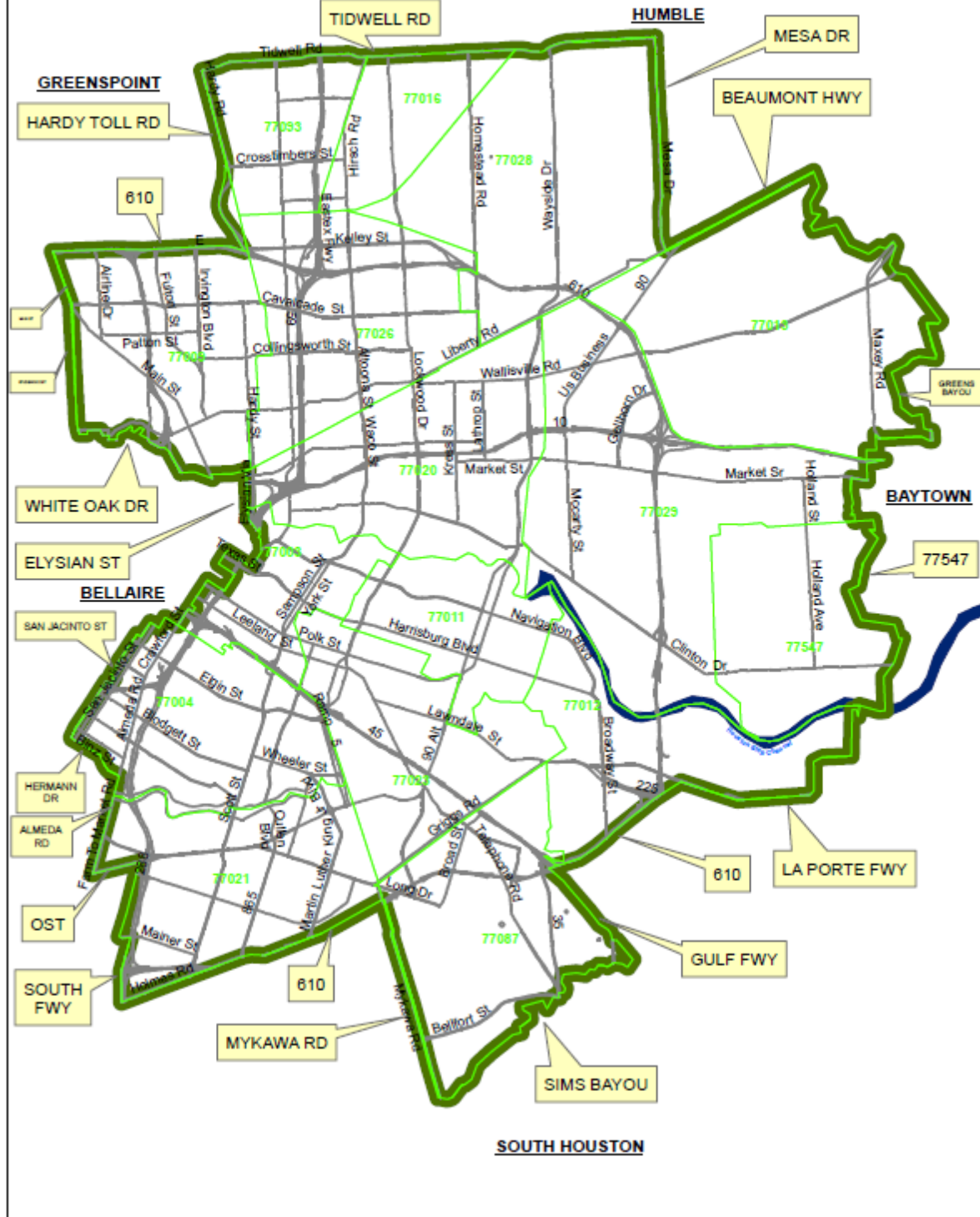

HUMBLE SERVICE AREA

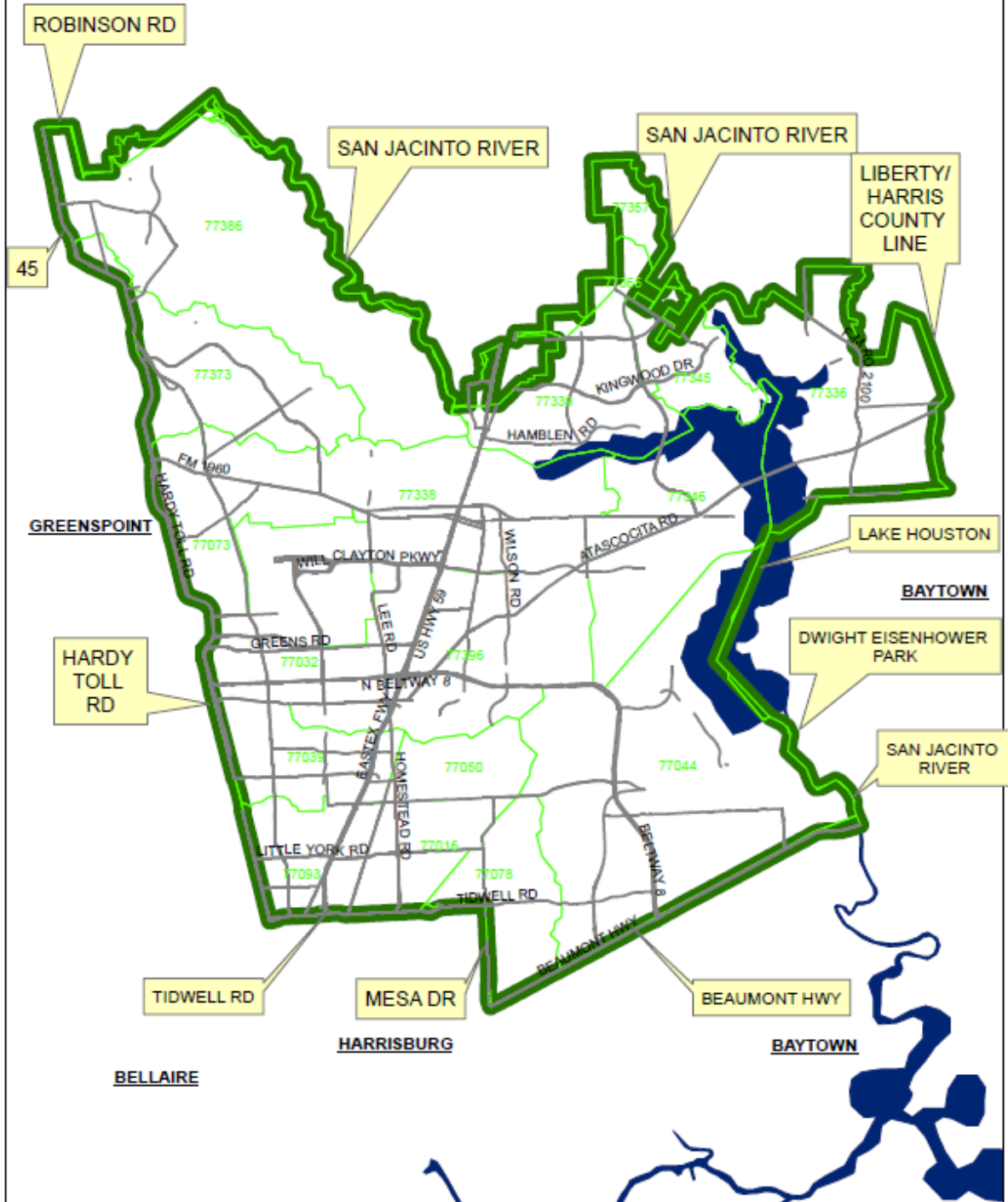

KATY SERVICE AREA

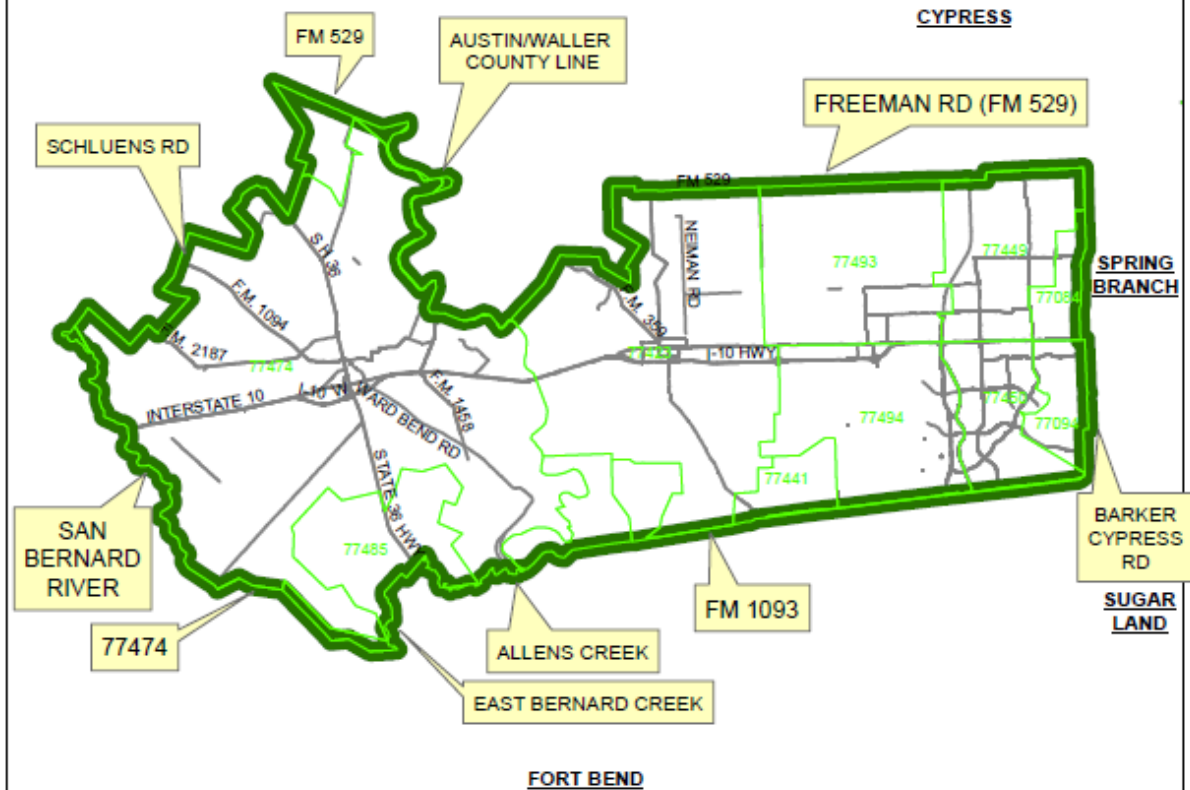

SOUTH HOUSTON SERVICE AREA

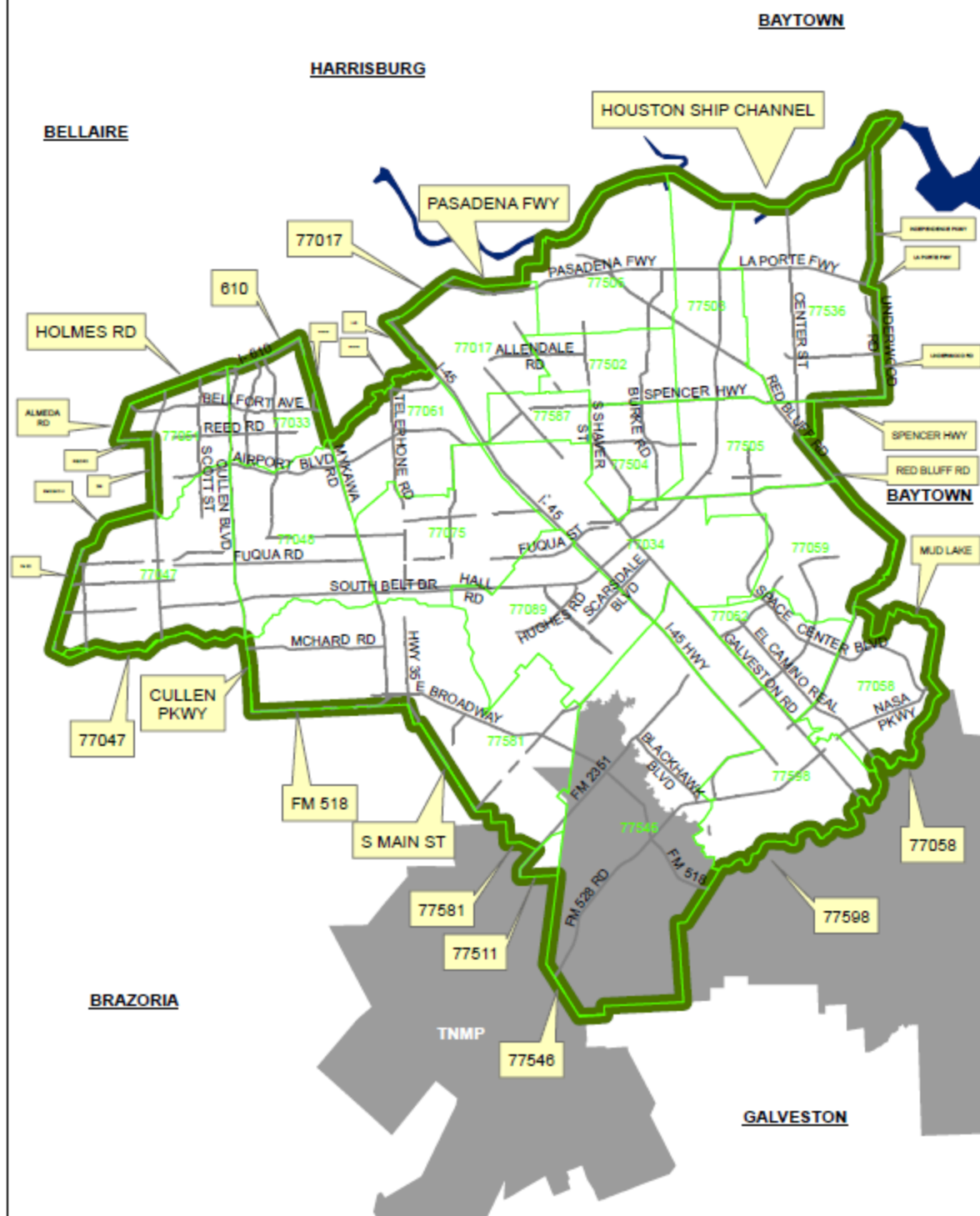

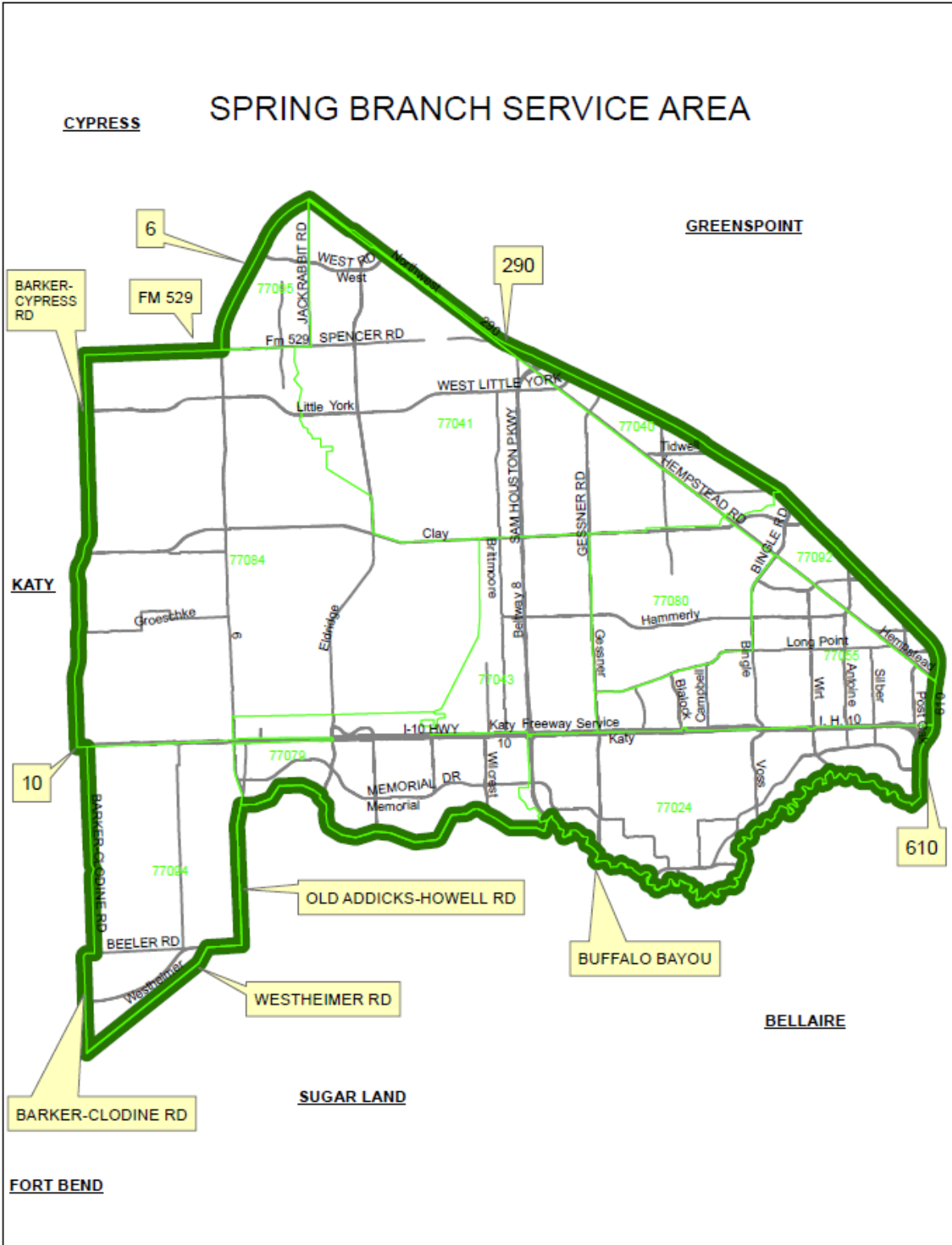

SUGAR LAND SERVICE AREA

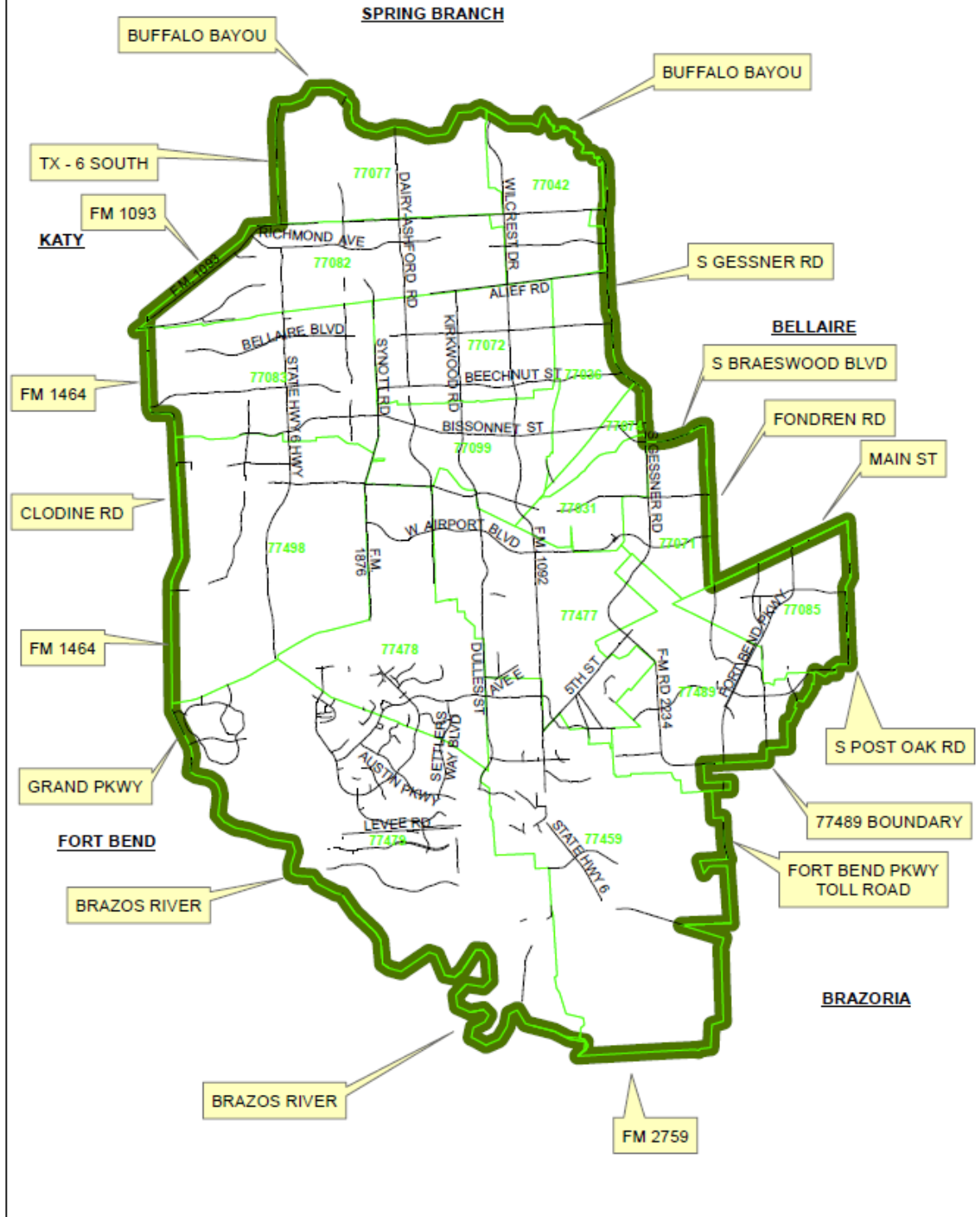

LONE STAR NOTIFICATION CENTER

OSHA Rule 1926.651 Requires Previous Notification

CALL BEFORE YOU DIG

713-223-4567

or Toll Free

1-800-669-8344

Or 811 (www.call811.com) nationwide number

When you need to evacuate in the Houston area, there is a single number you can call to be sure you don't encounter the inconvenience of digging into underground power lines.

Just call the special operator who is on duty 24 hours a day, seven days a week at 223-4567 or 1-800-669-8344. Tell the operator who, what, when and where about your excavation plans **at least 48** hours before you begin. Your message is relayed to each of the area utilities. If they have underground lines in the area, they will either contact you directly, or will stake out the job site with color coded markers to show you where their lines are located.

Here are the colors:

Red – Electric power lines or conduits.

Orange – Communication lines or other hazardous lines.

Yellow – Gas, oil, petroleum or other hazardous lines.

Green – Storm and sanitary sewer lines.

Blue – Water lines

If, for any reason, you should cut an underground line, the same numbers can also be used to notify any of the utilities. So remember these numbers, and save yourself time and trouble when you need to dig.

713-223-4567 or Toll Free 1-800-669-8344 or 811