

2003 Cadillac Seville Owner Manual

| | | | |
|-----------------------------------------------|------|------------------------------------------------|-------|
| Seats and Restraint Systems | 1-1 | Trip Computer | 3-77 |
| Front Seats | 1-2 | Audio System(s) | 3-78 |
| Safety Belts | 1-6 | Driving Your Vehicle | 4-1 |
| Child Restraints | 1-24 | Your Driving, the Road, and Your Vehicle | 4-2 |
| Supplemental Inflatable Restraint (SIR) | 1-44 | Towing | 4-31 |
| Restraint System Check | 1-52 | Service and Appearance Care | 5-1 |
| Features and Controls | 2-1 | Service | 5-3 |
| Keys | 2-3 | Fuel | 5-4 |
| Doors and Locks | 2-9 | Checking Things Under the Hood | 5-10 |
| Windows | 2-15 | Headlamp Aiming | 5-51 |
| Theft-Deterrent Systems | 2-19 | Bulb Replacement | 5-55 |
| Starting and Operating Your Vehicle | 2-23 | Windshield Wiper Blade Replacement | 5-62 |
| Mirrors | 2-37 | Tires | 5-63 |
| OnStar [®] System | 2-42 | Appearance Care | 5-83 |
| HomeLink [®] Transmitter | 2-44 | Vehicle Identification | 5-91 |
| Storage Areas | 2-48 | Electrical System | 5-92 |
| Sunroof | 2-50 | Capacities and Specifications | 5-100 |
| Vehicle Personalization | 2-51 | Normal Maintenance Replacement Parts | 5-101 |
| Instrument Panel | 3-1 | Maintenance Schedule | 6-1 |
| Instrument Panel Overview | 3-4 | Maintenance Schedule | 6-2 |
| Climate Controls | 3-28 | Customer Assistance Information | 7-1 |
| Warning Lights, Gages and Indicators | 3-37 | Customer Assistance Information | 7-2 |
| Driver Information Center (DIC) | 3-53 | Reporting Safety Defects | 7-9 |
| | | Index | 1 |



GENERAL MOTORS, GM, the GM Emblem, CADILLAC, the CADILLAC Crest & Wreath and the name SEVILLE are registered trademarks of General Motors Corporation.

This manual includes the latest information at the time it was printed. We reserve the right to make changes after that time without further notice. For vehicles first sold in Canada, substitute the name "General Motors of Canada Limited" for Cadillac Motor Car Division whenever it appears in this manual.

Please keep this manual in your vehicle, so it will be there if you ever need it when you're on the road. If you sell the vehicle, please leave this manual in it so the new owner can use it.

Canadian Owners

You can obtain a French copy of this manual from your dealer or from:

Helm, Incorporated
P.O. Box 07130
Detroit, MI 48207

How to Use This Manual

Many people read their owner's manual from beginning to end when they first receive their new vehicle. If you do this, it will help you learn about the features and controls for your vehicle. In this manual, you will find that pictures and words work together to explain things.

Index

A good place to look for what you need is the Index in back of the manual. It is an alphabetical list of what is in the manual, and the page number where you will find it.

Safety Warnings and Symbols

You will find a number of safety cautions in this book. We use a box and the word CAUTION to tell you about things that could hurt you if you were to ignore the warning.

 **CAUTION:**

These mean there is something that could hurt you or other people.

In the caution area, we tell you what the hazard is. Then we tell you what to do to help avoid or reduce the hazard. Please read these cautions. If you don't, you or others could be hurt.

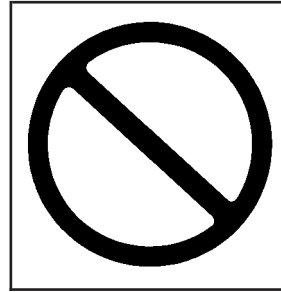

You will also find a circle with a slash through it in this book. This safety symbol means “Don’t,” “Don’t do this” or “Don’t let this happen.”

Vehicle Damage Warnings

Also, in this book you will find these notices:

Notice: These mean there is something that could damage your vehicle.

A notice will tell you about something that can damage your vehicle. Many times, this damage would not be covered by your warranty, and it could be costly. But the notice will tell you what to do to help avoid the damage.

When you read other manuals, you might see CAUTION and NOTICE warnings in different colors or in different words.

You'll also see warning labels on your vehicle. They use the same words, CAUTION or NOTICE.

































Vehicle Symbols

Your vehicle has components and labels that use symbols instead of text. Symbols, used on your vehicle, are shown along with the text describing the operation or information relating to a specific component, control, message, gage or indicator.

If you need help figuring out a specific name of a component, gage or indicator, reference the following topics:

- Seats and Restraint Systems in Section 1
- Features and Controls in Section 2
- Instrument Panel Overview in Section 3
- Climate Controls in Section 3
- Warning Lights, Gages and Indicators in Section 3
- Audio System(s) in Section 3
- Engine Compartment Overview in Section 5

These are some examples of vehicle symbols you may find on your vehicle:

| | | | | | | | | | | | |
|----------------------------------------------------|-----------------------------------------------------------------------------------|-----------------------------------------------------------------------------------------------------------|---------------------------------------------------------------------------------------------------------------------------------------------------------------------|--------------------------------------------------------------------------------------|------------------------------------------------------------------------------------|------------------------------|-------------------------------------------------------------------------------------|-------------------------------|-------------------------------------------------------------------------------------|--------------------------|-------------------------------------------------------------------------------------|
| CAUTION POSSIBLE INJURY |  | LATCH BOTH LAP AND SHOULDER BELTS TO PROTECT OCCUPANT DO NOT TWIST SAFETY BELT WHEN ATTACHING |   | MASTER LIGHTING SWITCH |  | ENGINE COOLANT TEMP |  | FUSE BOX ACCESS |  | | |
| PROTECT EYES BY SHIELDING |  | FASTEN SEAT BELTS |  | AIR BAG |  | TURN SIGNALS |  | BATTERY CHARGING SYSTEM |  | ENGINE COOLANT FAN |  |
| CAUSTIC BATTERY ACID COULD CAUSE BURNS |  | MOVE SEAT FULLY REARWARD SECURE CHILD SEAT |  | DO NOT INSTALL A REAR-FACING CHILD RESTRAINT IN THIS SEATING POSITION |  | PARKING LAMPS |  | BRAKE |  | FUEL |  |
| AVOID SPARKS OR FLAMES |  | PULL BELT OUT COMPLETELY THEN SECURE CHILD SEAT |  | DO NOT INSTALL A FORWARD-FACING CHILD RESTRAINT IN THIS SEATING POSITION |  | HAZARD WARNING FLASHER |  | COOLANT |  | OWNER'S MANUAL |  |
| SPARK OR FLAME COULD EXPLODE BATTERY |  | POWER WINDOW |  | DOOR LOCK UNLOCK |  | DAYTIME RUNNING LAMPS |  | ENGINE OIL PRESSURE |  | SERVICE |  |
| | | | | | | FOG LAMPS |  | ANTI-LOCK BRAKES |  | SERVICE MANUAL |  |

 **NOTES**

Section 1 Seats and Restraint Systems

| | | | |
|------------------------------------------------|------|-----------------------------------------------------------------------|------|
| Front Seats | 1-2 | Top Strap | 1-33 |
| Power Seats | 1-2 | Top Strap Anchor Location | 1-35 |
| Power Lumbar | 1-2 | Lower Anchorages and Top Tethers for Children (LATCH System) | 1-36 |
| Heated Seats | 1-3 | Securing a Child Restraint Designed for the LATCH System | 1-38 |
| Reclining Seatbacks | 1-3 | Securing a Child Restraint in a Rear Seat Position | 1-38 |
| Head Restraints | 1-5 | Securing a Child Restraint in the Right Front Seat Position | 1-41 |
| Safety Belts | 1-6 | Supplemental Inflatable Restraint (SIR) | 1-44 |
| Safety Belts: They Are for Everyone | 1-6 | Where Are the Air Bags? | 1-46 |
| Questions and Answers About Safety Belts | 1-10 | When Should an Air Bag Inflate? | 1-49 |
| How to Wear Safety Belts Properly | 1-11 | What Makes an Air Bag Inflate? | 1-49 |
| Driver Position | 1-12 | How Does an Air Bag Restrain? | 1-50 |
| Safety Belt Use During Pregnancy | 1-18 | What Will You See After an Air Bag Inflates? | 1-50 |
| Right Front Passenger Position | 1-19 | Servicing Your Air Bag-Equipped Vehicle | 1-52 |
| Rear Seat Passengers | 1-19 | Restraint System Check | 1-52 |
| Safety Belt Pretensioners | 1-23 | Checking Your Restraint Systems | 1-52 |
| Safety Belt Extender | 1-23 | Replacing Restraint System Parts After a Crash | 1-53 |
| Child Restraints | 1-24 | | |
| Older Children | 1-24 | | |
| Infants and Young Children | 1-26 | | |
| Child Restraint Systems | 1-30 | | |
| Where to Put the Restraint | 1-33 | | |

Front Seats

Power Seats



The power seat controls are located on the outboard sides of the front seat cushions.

- Move the front of the seat control up or down to adjust the front portion of the cushion.
- Move the rear of the seat control up or down to adjust the rear portion of the cushion.
- Lift up or push down on the center of the seat control to move the entire seat up or down.
- Slide the seat control forward or rearward to move the seat forward or rearward.

Power Lumbar



If your vehicle has this feature, the control is located on the outboard sides of the front seats.

Use the power seat controls first to get the proper position, then continue with the lumbar adjustment.

Press the lumbar control forward to increase support and rearward to decrease support. Press the control up or down to raise or lower the support mechanism.

Keep in mind that as your seating position changes, as it may during long trips, so should the position of your lumbar support. Adjust the seat as needed.

Heated Seats



The front seat controls are located in the center console. The rear seat controls are located on the rear doors.

Push the button once for a high setting, twice for a low setting, and a third time to turn off the heated seat. The LO setting warms the seatback and cushion until the seat approximates body temperature. The HI setting heats the seat to a slightly higher temperature.

The heated seats can only be used when the ignition is turned on. The heating elements in the seats automatically turn off when the vehicle's ignition is turned off.

Only the outboard rear seat positions have heating elements.

Reclining Seatbacks



The reclining front seatback controls are located on the outboard side of each front seat.

Press the top of the control forward or rearward to adjust the seatback angle. Push the control up or down to adjust the head restraint and shoulder belt height positions.

See *Head Restraints on page 1-5*.



Don't have a seatback reclined if your vehicle is moving.

⚠ CAUTION:

Sitting in a reclined position when your vehicle is in motion can be dangerous. Even if you buckle up, your safety belts can't do their job when you're reclined like this.

The shoulder belt can't do its job. In a crash, you could go into it, receiving neck or other injuries.

The lap belt can't do its job either. In a crash the belt could go up over your abdomen. The belt forces would be there, not at your pelvic bones. This could cause serious internal injuries.

For proper protection when the vehicle is in motion, have the seatback upright. Then sit well back in the seat and wear your safety belt properly.

Head Restraints



Adjust your head restraint so that the top of the restraint is closest to the top of your head. This position reduces the chance of a neck injury in a crash.



The switches used to adjust the front head restraints are located on the outboard side of each front seat.

Use the vertical power seat switch to move a front seat head restraint up or down. Pull up or push down on the switch to move the head restraint up or down. Moving the head restraint also changes the height of the shoulder belt.

The head restraints tilt forward and rearward also.

To tilt the head restraints forward, grasp the top of the restraint and move it forward to where you want it to go until you hear a click. It will then be locked into that position until you need to move it again. Pulling forward past the last position will allow the restraint to return to an upright position.

The rear head restraints are adjustable, also. They tilt forward and rearward like the front head restraints, but they do not move up and down.

Safety Belts

Safety Belts: They Are for Everyone

This part of the manual tells you how to use safety belts properly. It also tells you some things you should not do with safety belts.

CAUTION:

Don't let anyone ride where he or she can't wear a safety belt properly. If you are in a crash and you're not wearing a safety belt, your injuries can be much worse. You can hit things inside the vehicle or be ejected from it. You can be seriously injured or killed. In the same crash, you might not be, if you are buckled up. Always fasten your safety belt, and check that your passengers' belts are fastened properly too.

CAUTION:

It is extremely dangerous to ride in a cargo area, inside or outside of a vehicle. In a collision, people riding in these areas are more likely to be seriously injured or killed. Do not allow people to ride in any area of your vehicle that is not equipped with seats and safety belts. Be sure everyone in your vehicle is in a seat and using a safety belt properly.



Your vehicle has a light that comes on as a reminder to buckle up. See *Safety Belt Reminder Light* on page 3-41.

In most states and all Canadian provinces, the law says to wear safety belts. Here's why: *They work.*

You never know if you'll be in a crash. If you do have a crash, you don't know if it will be a bad one.

A few crashes are mild, and some crashes can be so serious that even buckled up a person wouldn't survive. But most crashes are in between. In many of them, people who buckle up can survive and sometimes walk away. Without belts they could have been badly hurt or killed.

After more than 30 years of safety belts in vehicles, the facts are clear. In most crashes buckling up does matter... a lot!

Why Safety Belts Work

When you ride in or on anything, you go as fast as it goes.

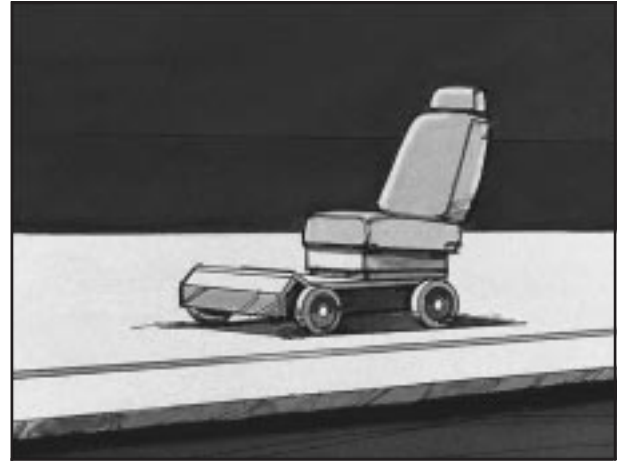

Take the simplest vehicle. Suppose it's just a seat on wheels.



Put someone on it.

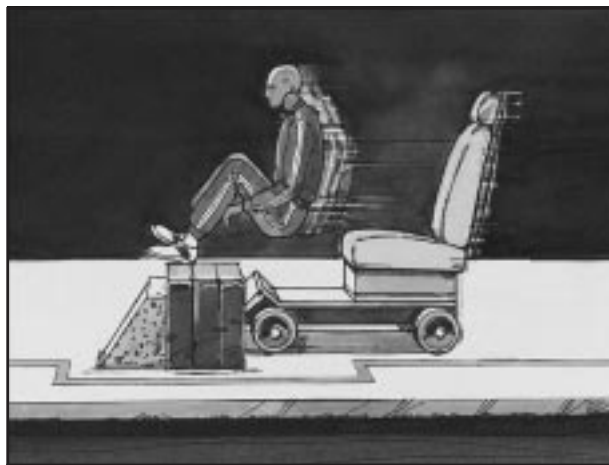

Get it up to speed. Then stop the vehicle. The rider doesn't stop.



The person keeps going until stopped by something. In a real vehicle, it could be the windshield...



or the instrument panel...

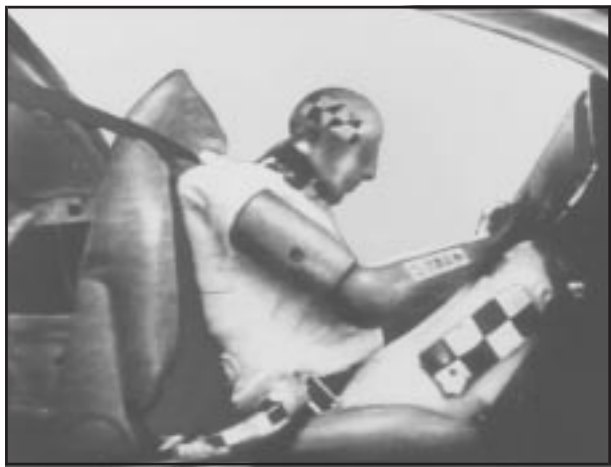

or the safety belts!

With safety belts, you slow down as the vehicle does. You get more time to stop. You stop over more distance, and your strongest bones take the forces. That's why safety belts make such good sense.

Questions and Answers About Safety Belts

Q: Won't I be trapped in the vehicle after an accident if I'm wearing a safety belt?

A: You *could* be – whether you're wearing a safety belt or not. But you can unbuckle a safety belt, even if you're upside down. And your chance of being conscious during and after an accident, so you *can* unbuckle and get out, is *much* greater if you are belted.

Q: If my vehicle has air bags, why should I have to wear safety belts?

A: Air bags are in many vehicles today and will be in most of them in the future. But they are supplemental systems only; so they work *with* safety belts – not instead of them. Every air bag system ever offered for sale has required the use of safety belts. Even if you're in a vehicle that has air bags, you still have to buckle up to get the most protection. That's true not only in frontal collisions, but especially in side and other collisions.

Q: If I'm a good driver, and I never drive far from home, why should I wear safety belts?

A: You may be an excellent driver, but if you're in an accident – even one that isn't your fault – you and your passengers can be hurt. Being a good driver doesn't protect you from things beyond your control, such as bad drivers.

Most accidents occur within 25 miles (40 km) of home. And the greatest number of serious injuries and deaths occur at speeds of less than 40 mph (65 km/h).

Safety belts are for everyone.

How to Wear Safety Belts Properly

This part is only for people of adult size.

Be aware that there are special things to know about safety belts and children. And there are different rules for smaller children and babies. If a child will be riding in your vehicle, see *Older Children on page 1-24* or *Infants and Young Children on page 1-26*. Follow those rules for everyone's protection.

First, you'll want to know which restraint systems your vehicle has.

We'll start with the driver position.

Driver Position

This part describes the driver's restraint system.

Lap-Shoulder Belt

The driver has a lap-shoulder belt. Here is how to wear it properly.

1. Close and lock the door.
2. Adjust the seat so you can sit up straight. To see how, see "Seats" in the Index.



3. Pick up the latch plate and pull the belt across you. Do not let it get twisted.

The lap-shoulder belt may lock if you pull the belt across you very quickly. If this happens, let the belt go back slightly to unlock it. Then pull the belt across you more slowly.

4. Push the latch plate into the buckle until it clicks. Pull up on the latch plate to make sure it is secure. If the belt is not long enough, see *Safety Belt Extender on page 1-23*.

Make sure the release button on the buckle is positioned so you would be able to unbuckle the safety belt quickly if you ever had to.

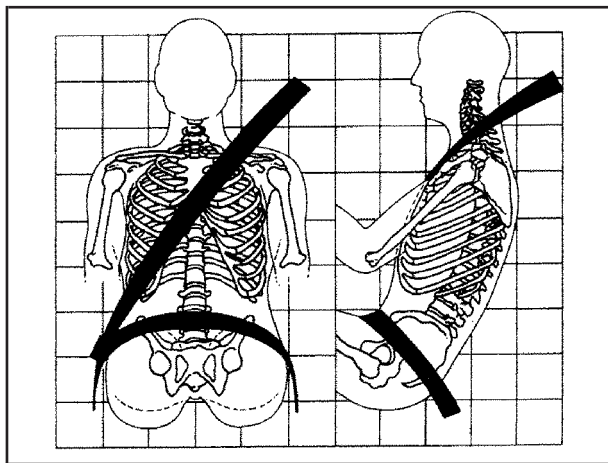

Shoulder Belt Height Adjuster

Before you begin to drive, move the shoulder belt adjuster to the height that is right for you. Adjust the height so that the shoulder portion of the belt is centered on your shoulder. The belt should be away from your face and neck, but not falling off your shoulder.

The lap part of the belt should be worn low and snug on the hips, just touching the thighs. In a crash, this applies force to the strong pelvic bones. And you would be less likely to slide under the lap belt. If you slid under it, the belt would apply force at your abdomen. This could cause serious or even fatal injuries. The shoulder belt should go over the shoulder and across the chest. These parts of the body are best able to take belt restraining forces.

The safety belt locks if there is a sudden stop or crash, or if you pull the belt very quickly out of the retractor.

Q: What's wrong with this?

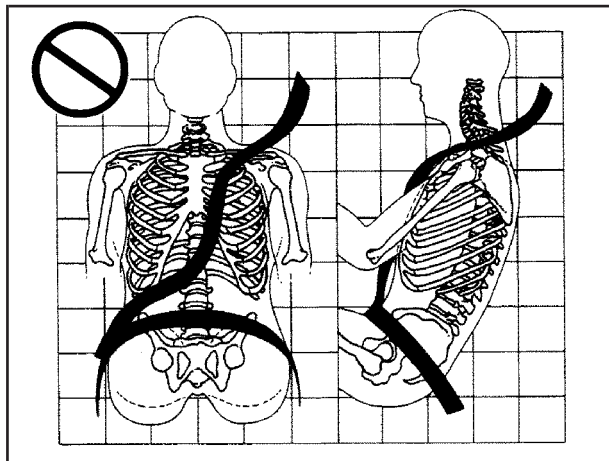

A: The shoulder belt is too loose. It will not give nearly as much protection this way.

⚠ CAUTION:

You can be seriously hurt if your shoulder belt is too loose. In a crash, you would move forward too much, which could increase injury. The shoulder belt should fit against your body.

Q: What's wrong with this?

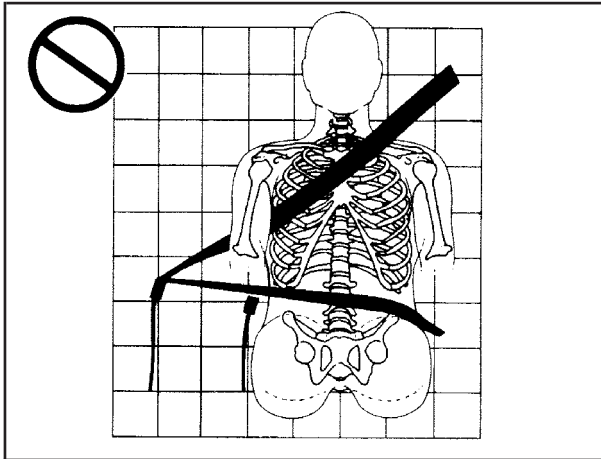

A: The belt is buckled in the wrong place.

⚠ CAUTION:

You can be seriously injured if your belt is buckled in the wrong place like this. In a crash, the belt would go up over your abdomen. The belt forces would be there, not at the pelvic bones. This could cause serious internal injuries. Always buckle your belt into the buckle nearest you.

Q: What's wrong with this?

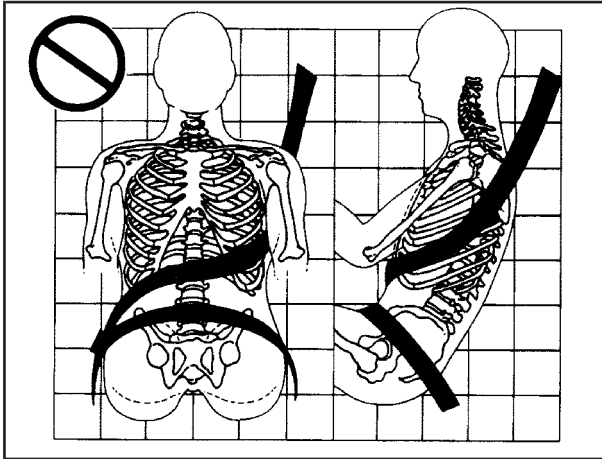

A: The shoulder belt is worn under the arm. It should be worn over the shoulder at all times.

⚠ CAUTION:

You can be seriously injured if you wear the shoulder belt under your arm. In a crash, your body would move too far forward, which would increase the chance of head and neck injury. Also, the belt would apply too much force to the ribs, which aren't as strong as shoulder bones. You could also severely injure internal organs like your liver or spleen.

Q: What's wrong with this?

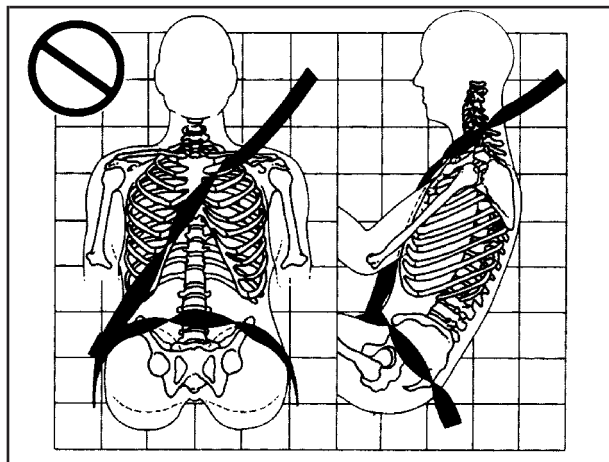

A: The belt is twisted across the body.

⚠ CAUTION:

You can be seriously injured by a twisted belt. In a crash, you wouldn't have the full width of the belt to spread impact forces. If a belt is twisted, make it straight so it can work properly, or ask your dealer to fix it.



To unlatch the belt, just push the button on the buckle. The belt should go back out of the way.

Before you close the door, be sure the belt is out of the way. If you slam the door on it, you can damage both the belt and your vehicle.

Safety Belt Use During Pregnancy

Safety belts work for everyone, including pregnant women. Like all occupants, they are more likely to be seriously injured if they don't wear safety belts.

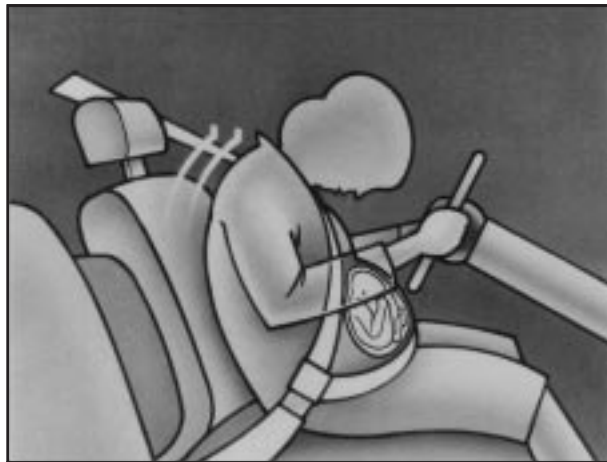

A pregnant woman should wear a lap-shoulder belt, and the lap portion should be worn as low as possible, below the rounding, throughout the pregnancy.

The best way to protect the fetus is to protect the mother. When a safety belt is worn properly, it's more likely that the fetus won't be hurt in a crash. For pregnant women, as for anyone, the key to making safety belts effective is wearing them properly.

Right Front Passenger Position

To learn how to wear the right front passenger's safety belt properly, see *Driver Position on page 1-12*.

The right front passenger's safety belt works the same way as the driver's safety belt — except for one thing. If you ever pull the lap portion of the belt out all the way, you will engage the child restraint locking feature. If this happens, just let the belt go back all the way and start again.

Rear Seat Passengers

It's very important for rear seat passengers to buckle up! Accident statistics show that unbelted people in the rear seat are hurt more often in crashes than those who are wearing safety belts.

Rear passengers who aren't safety belted can be thrown out of the vehicle in a crash. And they can strike others in the vehicle who are wearing safety belts.

Rear Seat Passenger Positions

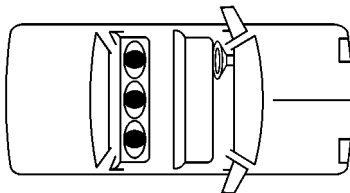

Lap-Shoulder Belt

All rear seating positions have lap-shoulder belts. Here's how to wear one properly.



1. Pick up the latch plate and pull the belt across you. Don't let it get twisted.

The shoulder belt may lock if you pull the belt across you very quickly. If this happens, let the belt go back slightly to unlock it. Then pull the belt across you more slowly.

2. Push the latch plate into the buckle until it clicks.



If the belt stops before it reaches the buckle, tilt the latch plate and keep pulling until you can buckle it.

Pull up on the latch plate to make sure it is secure.

If the belt is not long enough, see *Safety Belt Extender* on page 1-23.

Make sure the release button on the buckle is positioned so you would be able to unbuckle the safety belt quickly if you ever had to.



3. To make the lap part tight, pull down on the buckle end of the belt as you pull up on the shoulder part.

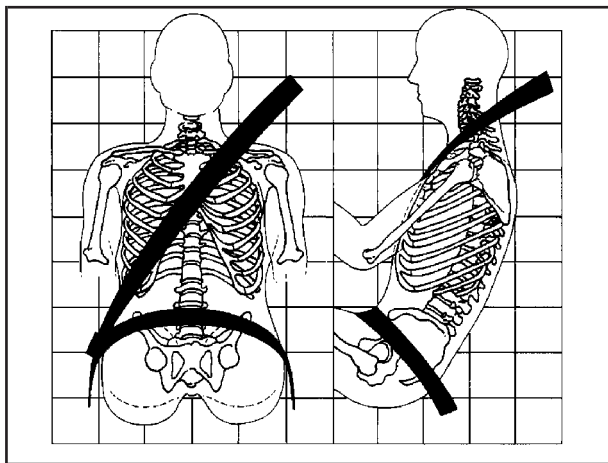

The lap part of the belt should be worn low and snug on the hips, just touching the thighs. In a crash, this applies force to the strong pelvic bones. And you'd be less likely to slide under the lap belt. If you slid under it, the belt would apply force at your abdomen. This could cause serious or even fatal injuries. The shoulder belt should go over the shoulder and across the chest. These parts of the body are best able to take belt restraining forces.

The safety belt locks if there's a sudden stop or a crash, or if you pull the belt very quickly out of the retractor.

⚠ CAUTION:

You can be seriously hurt if your shoulder belt is too loose. In a crash, you would move forward too much, which could increase injury. The shoulder belt should fit against your body.



To unlatch the belt, just push the button on the buckle.

Safety Belt Pretensioners

Your vehicle has safety belt pretensioners. You'll find them on the buckle end of the safety belts for the driver and right front passenger. They help the safety belts reduce a person's forward movement in a moderate to severe crash in which the front of the vehicle hits something.

Pretensioners work only once. If they activate in a crash, you'll need to get new ones, and probably other new parts for your safety belt system. See *Replacing Restraint System Parts After a Crash* on page 1-53.

Safety Belt Extender

If the vehicle's safety belt will fasten around you, you should use it.

But if a safety belt isn't long enough to fasten, your dealer will order you an extender. It's free. When you go in to order it, take the heaviest coat you will wear, so the extender will be long enough for you. The extender will be just for you, and just for the seat in your vehicle that you choose. Don't let someone else use it, and use it only for the seat it is made to fit. To wear it, just attach it to the regular safety belt.

Child Restraints

Older Children



Older children who have outgrown booster seats should wear the vehicle's safety belts.

Q: What is the proper way to wear safety belts?

A: If possible, an older child should wear a lap-shoulder belt and get the additional restraint a shoulder belt can provide. The shoulder belt should not cross the face or neck. The lap belt should fit snugly below the hips, just touching the top of the thighs. It should never be worn over the abdomen, which could cause severe or even fatal internal injuries in a crash.

Accident statistics show that children are safer if they are restrained in the rear seat.

In a crash, children who are not buckled up can strike other people who are buckled up, or can be thrown out of the vehicle. Older children need to use safety belts properly.



⚠ CAUTION:

Never do this.

Here two children are wearing the same belt. The belt can't properly spread the impact forces. In a crash, the two children can be crushed together and seriously injured. A belt must be used by only one person at a time.

- Q:** What if a child is wearing a lap-shoulder belt, but the child is so small that the shoulder belt is very close to the child's face or neck?
- A:** If the child is sitting in a seat next to a window, move the child toward the center of the vehicle. If the child is sitting in the center rear seat passenger position, move the child toward the safety belt buckle. In either case, be sure that the shoulder belt still is on the child's shoulder, so that in a crash the child's upper body would have the restraint that belts provide.



⚠ CAUTION:

Never do this.

Here a child is sitting in a seat that has a lap-shoulder belt, but the shoulder part is behind the child. If the child wears the belt in

CAUTION: (Continued)

CAUTION: (Continued)

this way, in a crash the child might slide under the belt. The belt's force would then be applied right on the child's abdomen. That could cause serious or fatal injuries.

The lap portion of the belt should be worn low and snug on the hips, just touching the child's thighs. This applies belt force to the child's pelvic bones in a crash.

Infants and Young Children

Everyone in a vehicle needs protection! This includes infants and all other children. Neither the distance traveled nor the age and size of the traveler changes the need, for everyone to use safety restraints. In fact, the law in every state in the United States and in every Canadian province says children up to some age must be restrained while in a vehicle.

Every time infants and young children ride in vehicles, they should have the protection provided by appropriate restraints. Young children should not use the vehicle's adult safety belts alone, unless there is no other choice. Instead, they need to use a child restraint.



⚠ CAUTION:

People should never hold a baby in their arms while riding in a vehicle. A baby doesn't weigh much -- until a crash. During a crash a baby will become so heavy it is not possible to hold it. For example, in a crash at only 25 mph (40 km/h), a 12-lb. (5.5 kg) baby will suddenly become a 240-lb. (110 kg) force on a person's arms. A baby should be secured in an appropriate restraint.



⚠ CAUTION:

Children who are up against, or very close to, any air bag when it inflates can be seriously injured or killed. Air bags plus lap-shoulder belts offer outstanding protection for adults and older children, but not for young children and infants. Neither the vehicle's safety belt system nor its air bag system is designed for them. Young children and infants need the protection that a child restraint system can provide.

Q: What are the different types of add-on child restraints?

A: Add-on child restraints, which are purchased by the vehicle's owner, are available in four basic types. Selection of a particular restraint should take into consideration not only the child's weight, height and age but also whether or not the restraint will be compatible with the motor vehicle in which it will be used.

For most basic types of child restraints, there are many different models available. When purchasing a child restraint, be sure it is designed to be used in a motor vehicle. If it is, the restraint will have a label saying that it meets federal motor vehicle safety standards.

The restraint manufacturer's instructions that come with the restraint state the weight and height limitations for a particular child restraint. In addition, there are many kinds of restraints available for children with special needs.

 **CAUTION:**

Newborn infants need complete support, including support for the head and neck. This is necessary because a newborn infant's neck is weak and its head weighs so much compared with the rest of its body. In a crash, an infant in a rear-facing seat settles into the restraint, so the crash forces can be distributed across the strongest part of an infant's body, the back and shoulders. Infants always should be secured in appropriate infant restraints.

 **CAUTION:**

The body structure of a young child is quite unlike that of an adult or older child, for whom the safety belts are designed. A young child's hip bones are still so small that the vehicle's regular safety belt may not remain low on the hip bones, as it should. Instead, it may settle up around the child's abdomen. In a crash, the belt would apply force on a body area that's unprotected by any bony structure. This alone could cause serious or fatal injuries. Young children always should be secured in appropriate child restraints.

Child Restraint Systems

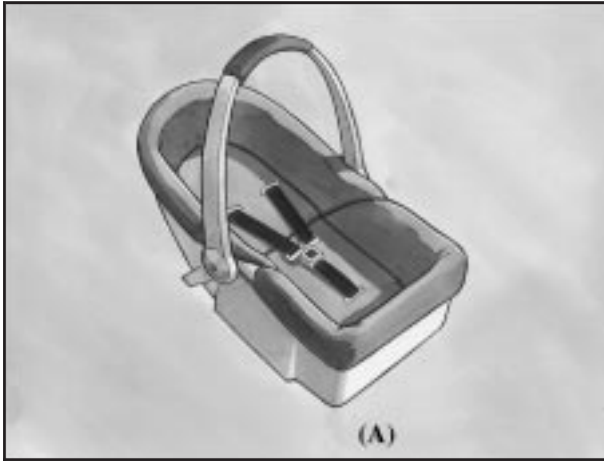

An infant car bed (A), a special bed made for use in a motor vehicle, is an infant restraint system designed to restrain or position a child on a continuous flat surface. Make sure that the infant's head rests toward the center of the vehicle.

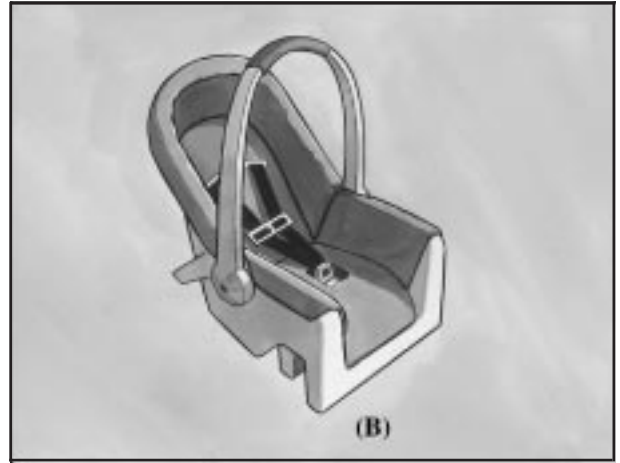

A rear-facing infant seat (B) provides restraint with the seating surface against the back of the infant. The harness system holds the infant in place and, in a crash, acts to keep the infant positioned in the restraint.

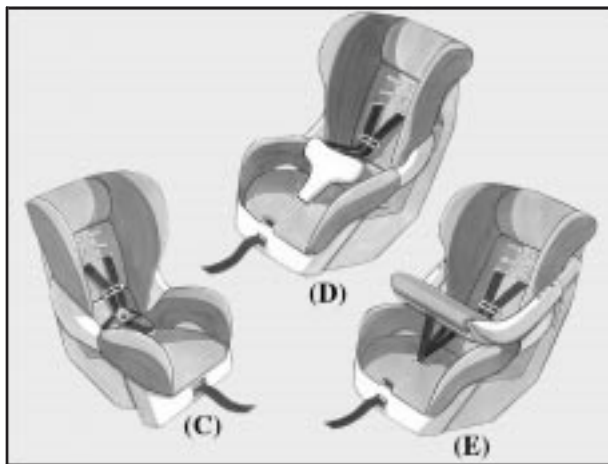

A forward-facing child seat (C-E) provides restraint for the child's body with the harness and also sometimes with surfaces such as T-shaped or shelf-like shields.

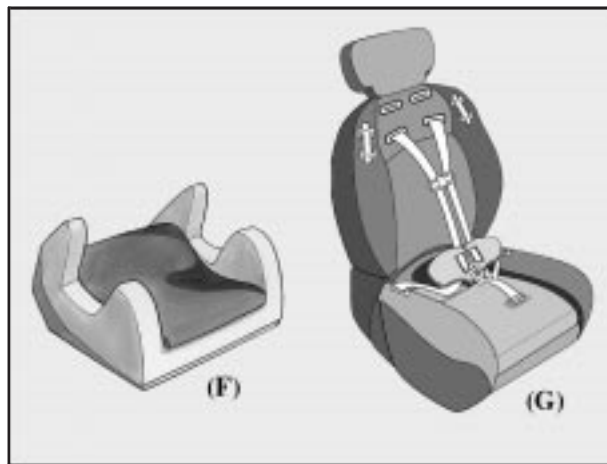

A booster seat (F-G) is a child restraint designed to improve the fit of the vehicle's safety belt system. Some booster seats have a shoulder belt positioner, and some high-back booster seats have a five-point harness. A booster seat can also help a child to see out the window.

Q: How do child restraints work?

A: A child restraint system is any device designed for use in a motor vehicle to restrain, seat, or position children. A built-in child restraint system is a permanent part of the motor vehicle. An add-on child restraint system is a portable one, which is purchased by the vehicle's owner.

For many years, add-on child restraints have used the adult belt system in the vehicle. To help reduce the chance of injury, the child also has to be secured within the restraint. The vehicle's belt system secures the add-on child restraint in the vehicle, and the add-on child restraint's harness system holds the child in place within the restraint.

One system, the three-point harness, has straps that come down over each of the infant's shoulders and buckle together at the crotch. The five-point harness system has two shoulder straps, two hip straps and a crotch strap. A shield may take the place of hip straps. A T-shaped shield has shoulder straps that are attached to a flat pad which rests low against the child's body. A shelf- or armrest-type shield has straps that are attached to a wide, shelf-like shield that swings up or to the side.

When choosing a child restraint, be sure the child restraint is designed to be used in a vehicle. If it is, it will have a label saying that it meets federal motor vehicle safety standards.

Then follow the instructions for the restraint. You may find these instructions on the restraint itself or in a booklet, or both. These restraints use the belt system in your vehicle, but the child also has to be secured within the restraint to help reduce the chance of personal injury. When securing an add-on child restraint, refer to the instructions that come with the restraint which may be on the restraint itself or in a booklet, or both, and to this manual. The child restraint instructions are important, so if they are not available, obtain a replacement copy from the manufacturer.

Where to Put the Restraint

Accident statistics show that children are safer if they are restrained in the rear rather than the front seat. We, therefore, recommend that child restraints be secured in a rear seat, including an infant riding in a rear-facing infant seat, a child riding in a forward-facing child seat and an older child riding in a booster seat. *Never* put a rear-facing child restraint in the front passenger seat. Here's why:

CAUTION:

A child in a rear-facing child restraint can be seriously injured or killed if the right front passenger's air bag inflates. This is because the back of the rear-facing child restraint would be very close to the inflating air bag. Always secure a rear-facing child restraint in a rear seat.

You may secure a forward-facing child restraint in the right front seat, but before you do, always move the front passenger seat as far back as it will go. It's better to secure the child restraint in a rear seat.

Wherever you install it, be sure to secure the child restraint properly.

Keep in mind that an unsecured child restraint can move around in a collision or sudden stop and injure people in the vehicle. Be sure to properly secure any child restraint in your vehicle – even when no child is in it.

Top Strap

Some child restraints have a top strap, or “top tether.” It can help restrain the child restraint during a collision. For it to work, a top strap must be properly anchored to the vehicle. Some top strap-equipped child restraints are designed for use with or without the top strap being anchored. Others require the top strap always to be anchored. Be sure to read and follow the instructions for your child restraint. If yours requires that the top strap be anchored, don't use the restraint unless it is anchored properly.

If the child restraint does not have a top strap, one can be obtained, in kit form, for many child restraints. Ask the child restraint manufacturer whether or not a kit is available.

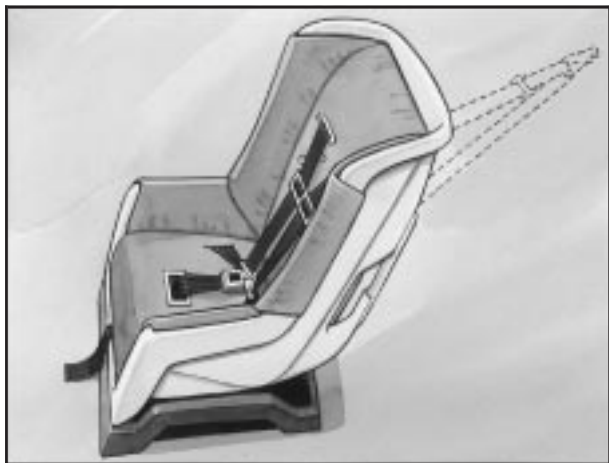

In Canada, the law requires that forward-facing child restraints have a top strap, and that the strap be anchored. In the United States, some child restraints also have a top strap. If your child restraint has a top strap, it should be anchored.

Anchor the top strap to one of the following anchor points. Be sure to use an anchor point located on the same side of the vehicle as the seating position where the child restraint will be placed.

If you have an adjustable head restraint, route the top strap under it.

Once you have the top strap anchored, you'll be ready to secure the child restraint itself. Tighten the top strap when and as the child restraint manufacturer's instructions say.

Top Strap Anchor Location

Your vehicle has top strap anchors already installed for the rear seating positions. You'll find the two rear outboard anchors behind the rear seat on the filler panel.

In order to get to one of these brackets, you'll have to open the trim cover. When using a top strapped-equipped child restraint in a rear outboard position, be sure to route the top strap under the head restraint.

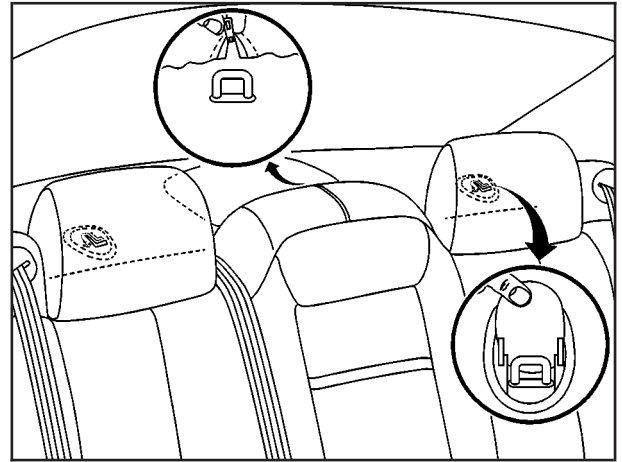

The top strap anchor for the center rear seating position is located at the top of the seat. In order to get to this bracket, you'll have to unzip the seat cover.

Lower Anchorages and Top Tethers for Children (LATCH System)

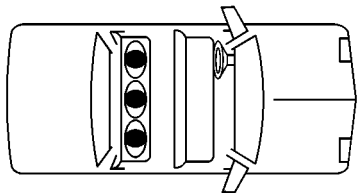

Your vehicle has the LATCH system. You'll find anchors (A) in all three rear seating positions.



To assist you in locating the lower anchors for this child restraint system, each seating position with the LATCH system will have the LATCH system symbol on the seatback directly above the anchors.

In order to use the system, you need either a forward-facing child restraint that has attaching points (B) at its base and a top tether anchor (C), or a rear-facing child restraint that has attaching points (B), as shown here.

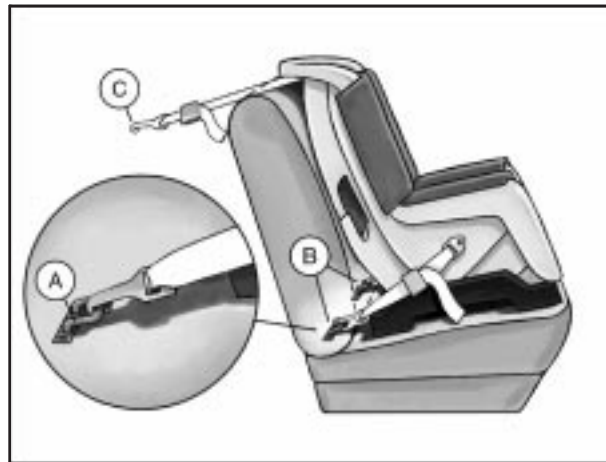

- A. Vehicle anchor
- B. LATCH system attachment points
- C. Top strap

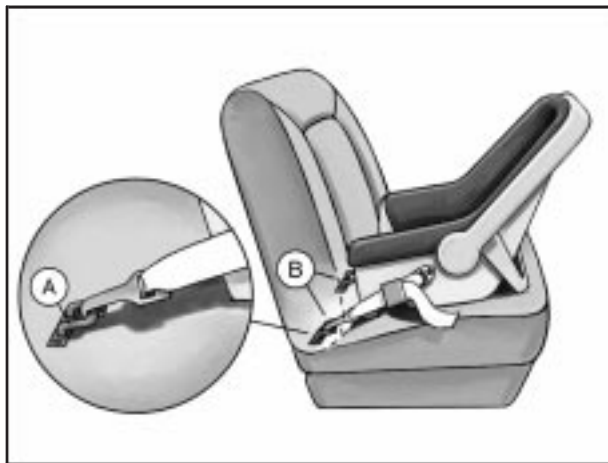

A. Vehicle anchor

B. LATCH system attachment points

Use the LATCH system instead of the vehicle's safety belts to secure a child restraint.

⚠ CAUTION:

If a LATCH-type child restraint isn't attached to its anchorage points, the restraint won't be able to protect the child correctly. In a crash, the child could be seriously injured or killed. Make sure that a LATCH-type child restraint is properly installed using the anchorage points, or use the vehicle's safety belts to secure the restraint. See "Securing a Child Restraint Designed for the LATCH System" or "Securing a Child Restraint in a Rear Seat Position" in the Index for information on how to secure a child restraint in your vehicle.

Securing a Child Restraint Designed for the LATCH System

1. Find the anchors for the seating position you want to use, where the bottom of the seatback meets the back of the seat cushion.
2. Put the child restraint on the seat.
3. Attach the anchor points on the child restraint to the anchors in the vehicle. The child restraint instructions will show you how.
4. If the child restraint is forward-facing, attach the top strap to the top strap anchor. See *Top Strap on page 1-33*. Tighten the top strap according to the child restraint instructions.
5. Push and pull the child restraint in different directions to be sure it is secure.

To remove the child restraint, simply unhook the top strap from the top tether anchor and then disconnect the anchor points.

Securing a Child Restraint in a Rear Seat Position

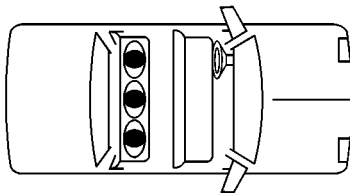

If your child restraint is equipped with the latch system, see *Lower Anchorages and Top Tethers for Children (LATCH System) on page 1-36*.

You'll be using the lap-shoulder belt. See *Top Strap on page 1-33* if the child restraint has one. Be sure to follow the instructions that came with the child restraint. Secure the child restraint when and as the instructions say.

1. Put the restraint on the seat.
2. Pick up the latch plate, and run the lap and shoulder portions of the vehicle's safety belt through or around the restraint. The child restraint instructions will show you how.



Tilt the latch plate to adjust the belt if needed.



3. Buckle the belt. Make sure the release button is positioned so you would be able to unbuckle the safety belt quickly if you ever had to.

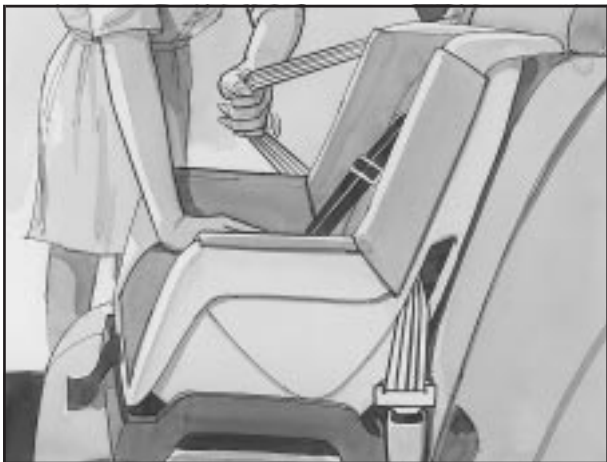

4. To tighten the belt, pull up on the shoulder belt while you push down on the child restraint. If you're using a forward-facing child restraint, you may find it helpful to use your knee to push down on the child restraint as you tighten the belt.
5. Push and pull the child restraint in different directions to be sure it is secure.

To remove the child restraint, just unbuckle the vehicle's safety belt and let it go back all the way. The safety belt will move freely again and be ready to work for an adult or larger child passenger.

Securing a Child Restraint in the Right Front Seat Position

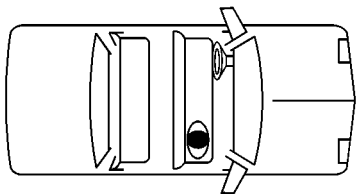

If your child restraint is equipped with the LATCH system, see *Lower Anchorages and Top Tethers for Children (LATCH System)* on page 1-36.

Your vehicle has a right front passenger air bag. *Never* put a rear facing child restraint in this seat. Here's why:

CAUTION:

A child in a rear-facing child restraint can be seriously injured or killed if the right front passenger's air bag inflates. This is because

CAUTION: (Continued)

CAUTION: (Continued)

the back of the rear-facing child restraint would be very close to the inflating air bag. Always secure a rear-facing child restraint in a rear seat.

Although a rear seat is a safer place, you can secure a forward-facing child restraint in the right front seat.

You'll be using the lap-shoulder belt. See the earlier part about the *Top Strap* on page 1-33, if the child restraint has one. Be sure to follow the instructions that came with the child restraint. Secure the child in the child restraint when and as the instructions say.

1. Because your vehicle has a right front passenger air bag, always move the seat as far back as it will go before securing a forward-facing child restraint. See *Power Seats* on page 1-2.
2. Put the restraint on the seat.
3. Pick up the latch plate, and run the lap and shoulder portions of the vehicle's safety belt through or around the restraint. The child restraint instructions will show you how.



4. Buckle the belt. Make sure the release button is positioned so you would be able to unbuckle the safety belt quickly if you ever had to.



5. Pull the rest of the lap belt all the way out of the retractor to set the lock.



6. To tighten the belt, feed the lap belt back into the retractor while you push down on the child restraint. You may find it helpful to use your knee to push down on the child restraint as you tighten the belt.
7. Push and pull the child restraint in different directions to be sure it is secure.

To remove the child restraint, just unbuckle the vehicle's safety belt and let it go back all the way. The safety belt will move freely again and be ready to work for an adult or larger child passenger.

Supplemental Inflatable Restraint (SIR)

This part explains the frontal and side impact Supplemental Inflatable Restraint (SIR) systems or air bag systems.

Your vehicle has four air bags – a frontal air bag for the driver, another frontal air bag for the right front passenger, a side impact air bag for the driver, and another side impact air bag for the right front passenger.

Frontal air bags are designed to help reduce the risk of injury from the force of an inflating frontal air bag. But these air bags must inflate very quickly to do their job and comply with federal regulations.

Here are the most important things to know about the air bag systems:

CAUTION:

You can be severely injured or killed in a crash if you aren't wearing your safety belt – even if you have air bags. Wearing your safety belt during a crash helps reduce your chance of

CAUTION: (Continued)

CAUTION: (Continued)

hitting things inside the vehicle or being ejected from it. Air bags are designed to work with safety belts but don't replace them.

Frontal air bags for the driver and right front passenger are designed to deploy only in moderate to severe frontal and near frontal crashes. They aren't designed to inflate at all in rollover, rear or low-speed frontal crashes, or in many side crashes. And, for some unrestrained occupants, frontal air bags may provide less protection in frontal crashes than more forceful air bags have provided in the past.

The side impact air bags for the driver and right front passenger are designed to inflate only in moderate to severe crashes where something hits the side of your vehicle. They aren't designed to inflate in frontal, in rollover or in rear crashes.

Everyone in your vehicle should wear a safety belt properly – whether or not there's an air bag for that person.

 **CAUTION:**

Both frontal and side impact air bags inflate with great force, faster than the blink of an eye. If you're too close to an inflating air bag, as you would be if you were leaning forward, it could seriously injure you. Safety belts help keep you in position for air bag inflation before and during a crash. Always wear your safety belt, even with frontal air bags. The driver should sit as far back as possible while still maintaining control of the vehicle. Front occupants should not lean on or sleep against the door.

 **CAUTION:**

Anyone who is up against, or very close to, any air bag when it inflates can be seriously injured or killed. Air bags plus lap-shoulder belts offer the best protection for adults, but not for young children and infants. Neither the vehicle's safety belt system nor its air bag system is designed for them. Young children and infants need the protection that a child restraint system can provide. Always secure children properly in your vehicle. To read how, see the part of this manual called "Older Children" or "Infants and Young Children."



United States



Canada

There is an air bag readiness light on the instrument panel, which shows AIR BAG or the air bag symbol.

The system checks the air bag electrical system for malfunctions. The light tells you if there is an electrical problem. See *Air Bag Readiness Light on page 3-42* for more information.

Where Are the Air Bags?



The driver's frontal air bag is in the middle of the steering wheel.



The right front passenger's frontal air bag is in the instrument panel on the passenger's side.



The driver's side impact air bag is in the side of the driver's seatback closest to the door.



The right front passenger's side impact air bag is in the side of the passenger's seatback closest to the door.

⚠ CAUTION:

If something is between an occupant and an air bag, the bag might not inflate properly or it might force the object into that person causing severe injury or even death. The path of an inflating air bag must be kept clear. Don't put anything between an occupant and an air bag, and don't attach or put anything on the steering wheel hub or on or near any other air bag covering. Don't let seat covers block the inflation path of a side impact air bag.

When Should an Air Bag Inflate?

The driver's and right front passenger's frontal air bags are designed to inflate in moderate to severe frontal or near-frontal crashes. But they are designed to inflate only if the impact speed is above the system's designed "threshold level."

If your vehicle goes straight into a wall that doesn't move or deform, the threshold level is about 9 to 15 mph (14 to 24 km/h). The threshold level can vary, however, with specific vehicle design, so that it can be somewhat above or below this range.

If your vehicle strikes something that will move or deform, such as a parked car, the threshold level will be higher. The driver's and right front passenger's frontal air bags are not designed to inflate in rollovers, rear impacts, or in many side impacts because inflation would not help the occupant.

The side impact air bags are designed to inflate in moderate to severe side crashes. A side impact air bag will inflate if the crash severity is above the system's designed "threshold level." The threshold level can vary with specific vehicle design. Side impact air bags are

not designed to inflate in frontal or near-frontal impacts, rollovers or rear impacts, because inflation would not help the occupant. A side impact air bag will only deploy on the side of the vehicle that is struck.

In any particular crash, no one can say whether an air bag should have inflated simply because of the damage to a vehicle or because of what the repair costs were. For frontal air bags, inflation is determined by the angle of the impact and how quickly the vehicle slows down in frontal and near-frontal impacts. For side impact air bags, inflation is determined by the location and severity of the impact.

What Makes an Air Bag Inflate?

In an impact of sufficient severity, the air bag sensing system detects that the vehicle is in a crash. For both frontal and side impact air bags, the sensing system triggers a release of gas from the inflator, which inflates the air bag. The inflator, the air bag and related hardware are all part of the air bag modules inside the steering wheel, the instrument panel, and the side of the front seatbacks closest to the door.

How Does an Air Bag Restrain?

In moderate to severe frontal or near frontal collisions, even belted occupants can contact the steering wheel or the instrument panel. In moderate to severe side collisions, even belted occupants can contact the inside of the vehicle. The air bag supplements the protection provided by safety belts. Air bags distribute the force of the impact more evenly over the occupant's upper body, stopping the occupant more gradually. But the frontal air bags would not help you in many types of collisions, including rollovers, rear impacts, and many side impacts, primarily because an occupant's motion is not toward the air bag. Side impact air bags would not help you in many types of collisions, including frontal or near frontal collisions, rollovers, and rear impacts, primarily because an occupant's motion is not toward those air bags. Air bags should never be regarded as anything more than a supplement to safety belts, and then only in moderate to severe frontal or near-frontal collisions for the driver's and right front passenger's frontal air bags, and only in moderate to severe side collisions for the driver's and right front passenger's side impact air bag.

What Will You See After an Air Bag Inflates?

After the air bag inflates, it quickly deflates, so quickly that some people may not even realize the air bag inflated. Some components of the air bag module – the steering wheel hub for the driver's air bag, the instrument panel for the right front passenger's bag, the side of the seatback closest to the door for the driver and right front passenger's side impact air bags – will be hot for a short time. The parts of the bag that come into contact with you may be warm, but not too hot to touch. There will be some smoke and dust coming from the vents in the deflated air bags. Air bag inflation doesn't prevent the driver from seeing or being able to steer the vehicle, nor does it stop people from leaving the vehicle.

CAUTION:

When an air bag inflates, there is dust in the air. This dust could cause breathing problems for people with a history of asthma or other breathing trouble. To avoid this, everyone in

CAUTION: (Continued)

CAUTION: (Continued)

the vehicle should get out as soon as it is safe to do so. If you have breathing problems but can't get out of the vehicle after an air bag inflates, then get fresh air by opening a window or a door. If you experience breathing problems following an air bag deployment, you should seek medical attention.

Your vehicle has a feature that will automatically unlock the doors and turn the interior lamps on when the air bags inflate (if battery power is available). You can lock the doors again and turn the interior lamps off by using the door lock and interior lamp controls.

In many crashes severe enough to inflate an air bag, windshields are broken by vehicle deformation. Additional windshield breakage may also occur from the right front passenger air bag.

- Air bags are designed to inflate only once. After an air bag inflates, you'll need some new parts for your air bag system. If you don't get them, the air bag system won't be there to help protect you in another crash. A new system will include air bag

modules and possibly other parts. The service manual for your vehicle covers the need to replace other parts.

- Your vehicle is equipped with a crash sensing and diagnostic module, which records information about the frontal air bag system. The module records information about the readiness of the system, when the system commands air bag inflation and driver's safety belt usage at deployment. The module also records speed, engine rpm, brake and throttle data.
- Let only qualified technicians work on your air bag systems. Improper service can mean that an air bag system won't work properly. See your dealer for service.

Notice: If you damage the covering for the driver's or the right front passenger's air bag, or the air bag covering on the driver's and right front passenger's seatback, the bag may not work properly. You may have to replace the air bag module in the steering wheel, both the air bag module and the instrument panel for the right front passenger's air bag, or both the air bag module and seatback for the driver's and right front passenger's side impact air bag. Do not open or break the air bag coverings.

Servicing Your Air Bag-Equipped Vehicle

Air bags affect how your vehicle should be serviced. There are parts of the air bag systems in several places around your vehicle. Your dealer and the service manual have information about servicing your vehicle and the air bag systems. To purchase a service manual, see *Service Publications Ordering Information on page 7-10*.

CAUTION:

For up to 10 seconds after the ignition key is turned off and the battery is disconnected, an air bag can still inflate during improper service. You can be injured if you are close to an air bag when it inflates. Avoid yellow connectors. They are probably part of the air bag system. Be sure to follow proper service procedures, and make sure the person performing work for you is qualified to do so.

The air bag systems do not need regular maintenance.

Restraint System Check

Checking Your Restraint Systems

Now and then, make sure the safety belt reminder light and all your belts, buckles, latch plates, retractors and anchorages are working properly. Look for any other loose or damaged safety belt system parts. If you see anything that might keep a safety belt system from doing its job, have it repaired.

Torn or frayed safety belts may not protect you in a crash. They can rip apart under impact forces. If a belt is torn or frayed, get a new one right away.

Also look for any opened or broken air bag covers, and have them repaired or replaced. (The air bag system does not need regular maintenance.)

Replacing Restraint System Parts After a Crash

CAUTION:

A crash can damage the restraint systems in your vehicle. A damaged restraint system may not properly protect the person using it, resulting in serious injury or even death in a crash. To help make sure your restraint systems are working properly after a crash, have them inspected and any necessary replacements made as soon as possible.

If you've had a crash, do you need new belts or LATCH system parts?

After a very minor collision, nothing may be necessary. But if the belts were stretched, as they would be if worn during a more severe crash, then you need new parts.

If the LATCH system was being used during a more severe crash, you may need new LATCH system parts.

If belts are cut or damaged, replace them. Collision damage also may mean you will need to have LATCH system, safety belt or seat parts repaired or replaced. New parts and repairs may be necessary even if the belt or LATCH system wasn't being used at the time of the collision.

If an air bag inflates, you'll need to replace air bag system parts. See the part on the air bag system earlier in this section.

If the frontal air bags inflate, you'll also need to replace the driver's and right front passenger's safety belt buckle assembly. Be sure to do so. Then the new buckle assembly will be there to help protect you in a collision.



NOTES

Section 2 Features and Controls

| | | | |
|--------------------------------------------------|------|---------------------------------------------------------------------|------|
| Keys | 2-3 | Ignition Positions | 2-24 |
| Remote Keyless Entry System | 2-5 | Starting Your Engine | 2-25 |
| Remote Keyless Entry System Operation | 2-6 | Engine Coolant Heater | 2-26 |
| Doors and Locks | 2-9 | Automatic Transaxle Operation | 2-28 |
| Door Locks | 2-9 | Parking Brake | 2-31 |
| Central Door Unlocking System | 2-10 | Shifting Into Park (P) | 2-32 |
| Power Door Locks | 2-10 | Shifting Out of Park (P) | 2-34 |
| Programmable Automatic Door Locks | 2-10 | Parking Over Things That Burn | 2-35 |
| Rear Door Security Locks | 2-11 | Engine Exhaust | 2-35 |
| Lockout Protection | 2-11 | Running Your Engine While You Are Parked | 2-36 |
| Leaving Your Vehicle | 2-11 | Mirrors | 2-37 |
| Trunk | 2-12 | Automatic Dimming Rearview Mirror with OnStar® | 2-37 |
| Windows | 2-15 | Automatic Dimming Rearview Mirror with OnStar® and Compass | 2-38 |
| Power Windows | 2-16 | Outside Power Mirrors | 2-40 |
| Sun Visors | 2-18 | Outside Automatic Dimming Mirror | 2-41 |
| Theft-Deterrent Systems | 2-19 | Outside Curb View Assist Mirror | 2-41 |
| PASS-Key® III | 2-21 | Outside Convex Mirror | 2-41 |
| PASS-Key® III Operation | 2-21 | Outside Heated Mirrors | 2-41 |
| Starting and Operating Your Vehicle | 2-23 | | |
| New Vehicle Break-In | 2-23 | | |

Section 2 Features and Controls

| | | | |
|---------------------------------------------|------|-----------------------------------------------|------|
| OnStar® System | 2-42 | Assist Handles | 2-49 |
| HomeLink® Transmitter | 2-44 | Garment Hooks | 2-49 |
| Programming the HomeLink® Transmitter | 2-45 | Umbrella Holder | 2-49 |
| Storage Areas | 2-48 | Floor Mats | 2-49 |
| Glove Box | 2-48 | Convenience Net | 2-49 |
| Cellular Telephone | 2-48 | Sunroof | 2-50 |
| Center Console Storage Area | 2-49 | Vehicle Personalization | 2-51 |
| Map Pocket | 2-49 | Memory Seat, Mirrors and Steering Wheel | 2-51 |

Keys

CAUTION:

Leaving children in a vehicle with the ignition key is dangerous for many reasons. A child or others could be badly injured or even killed.

They could operate the power windows or other controls or even make the vehicle move. If they turned the ignition to ACC or ON and moved the shift lever out of PARK (P), that would release the parking brake.

Don't leave the keys in a vehicle with children.



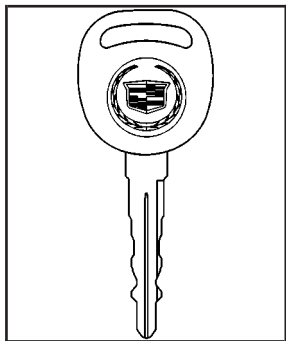

Master Key

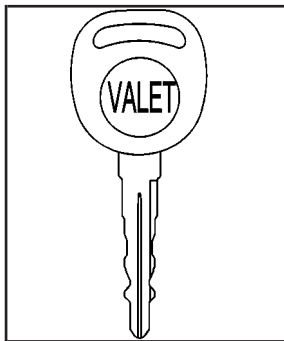

Valet Key

There is a master key that works all of the lock cylinders (driver's door, trunk, ignition and glove box).

There is also a VALET key which only operates the driver's door and the ignition.

Your vehicle has the PASS-Key[®] III vehicle theft system. Both the master and VALET key have a transponder in the key head that matches a decoder in the vehicle's steering column. If a replacement key or any additional key is needed, you must purchase this key from your dealer. The key will have PK3 stamped on it. Keep the bar code tag that came with the original keys. Give this tag to your dealer if you need a new key made.

Any new PASS-Key[®] III key must be programmed before it will start your vehicle. See *PASS-Key[®] III on page 2-21* for more information on programming your new key.

Notice: Your vehicle has a number of features that can help prevent theft. You can have a lot of trouble getting into your vehicle if you ever lock your keys inside. You may even have to damage your vehicle to get in. So be sure you have spare keys.

In an emergency, contact Cadillac Roadside Assistance. See *Roadside Service on page 7-6*.

If your vehicle is equipped with the OnStar[®] system with an active subscription and you lock your keys inside the vehicle, OnStar[®] may be able to send a command to unlock your vehicle. See *OnStar[®] System on page 2-42* for more information.

Remote Keyless Entry System

Your keyless entry system operates on a radio frequency subject to Federal Communications Commission (FCC) Rules and with Industry Canada.

This device complies with Part 15 of the FCC Rules. Operation is subject to the following two conditions:

1. This device may not cause interference, and
2. This device must accept any interference received, including interference that may cause undesired operation of the device.

This device complies with RSS-210 of Industry Canada. Operation is subject to the following two conditions:

1. This device may not cause interference, and
2. This device must accept any interference received, including interference that may cause undesired operation of the device.

Changes or modifications to this system by other than an authorized service facility could void authorization to use this equipment.

At times you may notice a decrease in range. This is normal for any remote keyless entry system. If the transmitter does not work or if you have to stand closer to your vehicle for the transmitter to work, try this:

- Check the distance. You may be too far from your vehicle. You may need to stand closer during rainy or snowy weather.
- Check the location. Other vehicles or objects may be blocking the signal. Take a few steps to the left or right, hold the transmitter higher, and try again.
- Check to determine if battery replacement is necessary. See “Battery Replacement” under *Remote Keyless Entry System Operation on page 2-6*.
- If you are still having trouble, see your dealer or a qualified technician for service.

Remote Keyless Entry System Operation

With this system you can lock and unlock your doors or unlock your trunk from about 3 feet (1 m) up to 30 feet (9 m) away using the remote keyless entry transmitter supplied with your vehicle.



🔒 (Lock): Press this button to lock the doors. The parking lamps will flash once and the horn will sound once. Pressing lock arms the theft-deterrent system.

The parking lamps will not flash, however, if the manual parking lamps are left on. Remote confirmation is not operational if a door is open.

You can program your vehicle so the parking lamps will not flash and the horn will not sound. For more information, see *DIC Vehicle Personalization on page 3-64*.

🔓 (Unlock): Press this button to unlock the driver's door. The parking lamps on your vehicle will flash twice. The parking lamps will not flash if they have been turned on manually. Remote confirmation is not operational if a door is open.

Press this button again within one to five seconds to unlock the other doors. It will also disarm the theft-deterrent system and turn on the interior lamps at night.

You can program your vehicle so the parking lamps will not flash. For more information, see *DIC Vehicle Personalization on page 3-64*.

 **(Fuel Door):** Press this button to open the fuel door. The valet lockout switch must be in the OFF position for this feature to work. See *Valet Lockout Switch* under *Theft-Deterrent Systems* on page 2-19 for more information.

 **(Trunk):** Press this button to open the trunk. The valet lockout switch must be in the OFF position for this feature to work. See *Valet Lockout Switch* under *Theft-Deterrent Systems* on page 2-19 for more information.

The remote keyless entry transmitter can be used to recall the memory settings for up to two drivers. For more information, see *DIC Vehicle Personalization* on page 3-64 and *Memory Seat, Mirrors and Steering Wheel* on page 2-51.

Matching Transmitter(s) to Your Vehicle

Each remote keyless entry transmitter is coded to prevent another transmitter from unlocking your vehicle. If a transmitter is lost or stolen, a replacement can be purchased through your dealer. Remember to bring any remaining transmitters with you when you go to your dealer. When the dealer matches the replacement transmitter to your vehicle, any remaining transmitters must also be matched. Once your dealer has coded the new transmitter, the lost transmitter will not unlock your vehicle. Each vehicle can have a maximum of four transmitters matched to it.

Vehicles are delivered with two transmitters. See your dealer for information on how to obtain additional transmitters.

Battery Replacement

Under normal use, the battery in your remote keyless entry transmitter should last about four years.

You can tell the battery is weak if the transmitter won't work at the normal range in any location. If you have to get close to your vehicle before the transmitter works, it's probably time to change the battery.

Notice: When replacing the battery, use care not to touch any of the circuitry. Static from your body transferred to these surfaces may damage the transmitter.



1. Use an object like a coin to pry open the transmitter.

2. Once the transmitter is separated, use an object like a pencil to remove the old battery. Do not use a metal object.



3. Insert the new battery as the instructions under the cover indicate.
4. Snap the transmitter back together tightly to be sure no moisture can enter.
5. Press any button on the remote keyless entry transmitter to resynchronize the transmitter.
6. Check the operation of the transmitter.

Doors and Locks

Door Locks

CAUTION:

Unlocked doors can be dangerous.

- Passengers — especially children — can easily open the doors and fall out of a moving vehicle. When a door is locked, the handle will not open it. You increase the chance of being thrown out of the vehicle in a crash if the doors are not locked. So, wear safety belts properly and lock the doors whenever you drive.
- Young children who get into unlocked vehicles may be unable to get out. A child can be overcome by extreme heat and can suffer permanent injuries or even death from heat stroke. Always lock your vehicle whenever you leave it.
- Outsiders can easily enter through an unlocked door when you slow down or stop your vehicle. Locking your doors can help prevent this from happening.

There are several ways to lock and unlock your vehicle.

Because your vehicle has the theft-deterrent system, you must unlock the doors with the key or remote keyless entry transmitter to avoid setting off the alarm.

From the outside, use either the key or the remote keyless entry transmitter.



From the inside, use the manual lock levers located at the top of the door panel near the window.

Push down the manual lock lever to lock the door. To unlock the door, pull up on the lever.

Central Door Unlocking System

Your vehicle has a central door unlocking mode and a theft-deterrent system. When unlocking the driver's door, you can unlock the other doors by holding the key in the turned position for a few seconds or by quickly turning the door key twice in the lock cylinder.

Power Door Locks



The power door lock switches are located on the door panels near the windows.

Press the bottom part of the power door lock switch located on either front door to lock all of the doors at once. Press the top of the switch to unlock all of the doors at once.

The power door lock switches located on the rear doors can also lock all the doors at once by pressing the bottom part of them, but they cannot unlock the doors.

Programmable Automatic Door Locks

Your vehicle is programmed so that, when the doors are closed, the ignition is on and the shift lever is moved out of PARK (P), all the doors will lock. The doors will unlock every time you stop the vehicle and move the shift lever into PARK (P).

If someone needs to get out while your vehicle is not in PARK (P), have the person use the manual lever or power door lock switch. When the door is closed again, it will not lock automatically. Use the manual lever or power door lock switch to lock the door.

With the vehicle in PARK (P) and the ignition in ON, the door locks can be programmed through prompts displayed on the Driver Information Center (DIC). These prompts allow the driver to choose various lock and unlock settings. For programming information, see *DIC Vehicle Personalization* on page 3-64.

Rear Door Security Locks

Your vehicle is equipped with rear door security locks that prevent passengers from opening the rear doors on your vehicle from the inside.

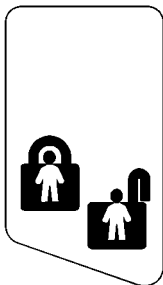

The rear door security locks are located on the inside edge of each rear door. You must open the doors to access them.

To use these locks, do the following:

1. Move the lever on the door all the way up to the engaged position.
2. Close the door.
3. Do the same thing to the other rear door lock.

The rear doors on your vehicle cannot be opened from the inside when this feature is in use.

When you want to open a rear door when the security lock is on, do the following:

1. Unlock the door using the remote keyless entry transmitter, the front door power lock switch or by lifting the rear door manual lock.
2. Then open the door from the outside.

To cancel the rear door security lock, do the following:

1. Unlock the door and open it from the outside.
2. Move the lever all the way down.
3. Do the same for the other rear door.

The rear door locks will now work normally.

Lockout Protection

Leaving your key in any ignition position with any door open will disable the power door lock switches as well as the lock button on the remote keyless entry transmitter. If you close the doors, you can lock them using the remote keyless entry transmitter. It is always recommended that you remove the ignition key when locking your vehicle.

The anti-lockout feature can be overridden by holding the power door lock switch for three seconds or longer.

Leaving Your Vehicle

If you are leaving your vehicle, open the door, set the locks from the inside, get out and close the door.

Trunk

CAUTION:

It can be dangerous to drive with the trunk lid open because carbon monoxide (CO) gas can come into your vehicle. You can't see or smell CO. It can cause unconsciousness and even death. If you must drive with the trunk lid open or if electrical wiring or other cable connections must pass through the seal between the body and the trunk lid:

- Make sure all other windows are shut.
- Turn the fan on your heating or cooling system to its highest speed and select the control setting that will force outside air into your vehicle. See "Climate Control System" in the Index.
- If you have air outlets on or under the instrument panel, open them all the way.

See "Engine Exhaust" in the Index.

Trunk Lock Release



The trunk lock release button is located on the left side of the instrument panel below the lamp controls.

Press the trunk lock release button upward to open the trunk. To use this feature, your vehicle must be in PARK (P) or NEUTRAL (N) and the valet lockout switch must be in the OFF position.

You can also press the button with the trunk symbol on the remote keyless entry transmitter to open the trunk. To disable this feature, see *Valet Lockout Switch* under *Theft-Deterrent Systems* on page 2-19.

Trunk Lid Tie Down

CAUTION:

Driving with the trunk lid open can allow dangerous CO (carbon monoxide) gas to come into your vehicle. You can't see or smell CO. It can cause unconsciousness and even death. If you ever need to drive with your trunk lid open, then:

- Make sure all windows, the rear seat pass-through and sunroof are closed.
- Turn the fan on your heating and cooling system to its highest speed, with the setting on AUTO and temperature between 65°F (18°C) and 85°F (29°C). This forces fresh outside air into your vehicle.
- Open all air ducts on the instrument panel.

Don't use the trunk lid tie down if you are towing a trailer because of the danger of CO.

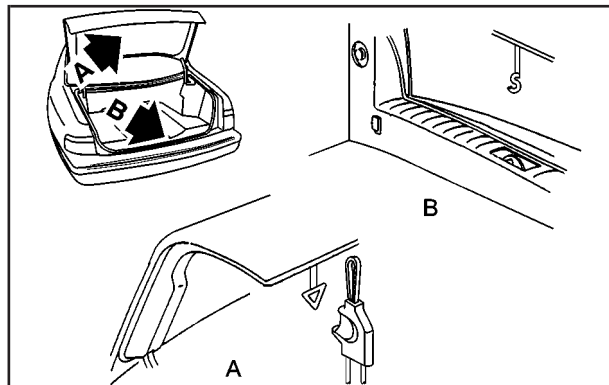

Your vehicle may be equipped with a trunk-lid tie down. This feature is used to secure the trunk lid if it will not close completely, such as when carrying large packages in the trunk. Use the following steps to secure the trunk lid:

1. Attach the clip end of the tie down to the D ring on the trunk lid (A).
2. Attach the hook end of the tie down to the striker located at the center of the trunk sill (B).
3. Tighten the tie down by pulling the free end of the cord until secure.
4. To remove the tie down, press the clip end release and loosen the cord.

Emergency Trunk Release Handle

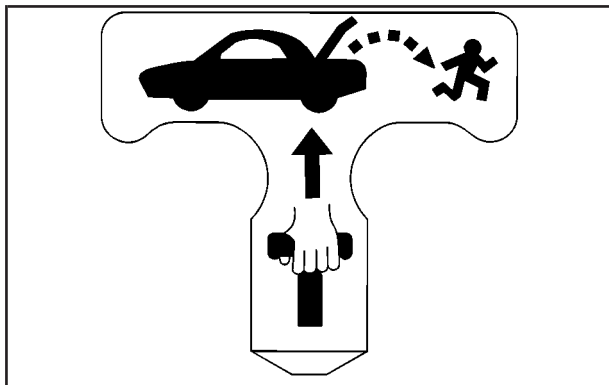

Notice: The emergency trunk release handle is not designed to be used to tie down the trunk lid or as an anchor point when securing items in the trunk. Improper use of the emergency trunk release handle could damage it.

There is a glow-in-the-dark trunk release handle located inside the trunk on the latch. This handle will glow following exposure to light. Pull the release handle upward to open the trunk from the inside.

Rear Seat Pass-Through Door

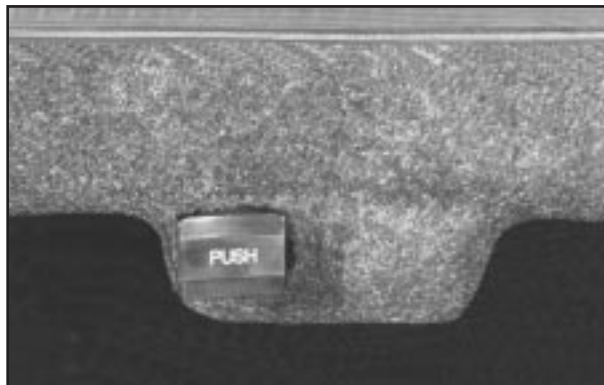

Your vehicle may be equipped with a rear seat pass-through door. The button for this feature is located in the trunk.

The rear-seat armrest must be down for the pass-through door to open. To release the pass-through door, press the PUSH button located in the center of the trunk panel.

Windows

⚠ CAUTION:

Leaving children in a vehicle with the windows closed is dangerous. A child can be overcome by the extreme heat and can suffer permanent injuries or even death from heat stroke. Never leave a child alone in a vehicle, especially with the windows closed in warm or hot weather.



Power Windows



The power window switches are located on the armrest near each window. Press the up or down arrows on the switches to raise or lower the windows.

Your vehicle has Retained Accessory Power (RAP) that allows you to use the power windows once the ignition has been turned off. For more information, see “Retained Accessory Power (RAP)” under *Ignition Positions* on page 2-24.

Express-Down Window

This feature is on all power windows. Press the down arrow on the switch to the second position to activate the express-down feature. If you want to stop the window as it is lowering, press the down arrow on the switch again.

Express-Up Window

This feature is on both front power windows. Press the up arrow on the switch to the second position to activate the express-up feature. If you want to stop the window as it is raising, press the up arrow on the switch again.

Programming the Power Windows

If the battery on your vehicle has been recharged, disconnected or is not working, you will need to reprogram each front power window for the express-up feature to work. Before reprogramming, you will need to replace or recharge your vehicle's battery.

To program each front window, follow these steps:

1. With the ignition in ACC or ON, or when RAP is active, close all doors.
2. Press and hold the down arrow on the power window switch until the window has fully opened.
3. Press the up arrow on the power window switch until the window is fully closed.
4. Continue holding the switch up for approximately two seconds after the window is completely closed.

The window is now programmed. Repeat the process for the other front window.

Anti-Pinch Feature

If a hand, an arm or another object is above the middle of the window and is in the path of the window when the express-up feature is active, the window will stop at the obstruction and express-open to a preset factory position.

CAUTION:

Pressing and holding the power window control will turn off the anti-pinch feature. If this happens, a power window won't stop if something gets in the way. You or others could be injured, and your window could be damaged. Be careful not to press and hold the power window control.

Window Lockout



The rear window lockout button is located on the driver's door armrest next to the window switches.

Press this button to disable the rear window controls. The light on the button will illuminate, indicating that the feature is in use. The rear windows still can be raised or lowered using the driver's window switches when the lockout feature is active.

To restore power to the rear windows, press the button again. The light on the button will go out.

Sun Visors

Swing down the primary visor to block out glare. It can also be detached from the center mount and moved to the side while the auxiliary sunshade remains to block the glare from the front. The visors also have side-to-side slide capability.

The visors also have a storage flap.

Lighted Visor Vanity Mirrors

Pull the visor down and lift the cover. Move the slide switch up or down to brighten or dim the lamp.

Theft-Deterrent Systems

Vehicle theft is a big business, especially in some cities. Although your vehicle has a number of theft-deterrent features, we know that nothing we put on it can make it impossible to steal.



The SECURITY light is located on the instrument panel cluster.

If the ignition is off and any door is open, the SECURITY light will flash, reminding you to arm the system.

To arm the system, do the following:

1. Open the door.
2. Lock the door using the power door lock switch with the door open or the remote keyless entry transmitter. The SECURITY light should come on and stay on.
3. Close all the doors. The SECURITY light should go off within approximately 30 seconds.

If a door or a trunk is opened without a key or a remote keyless entry transmitter, the horn will sound and the lamps will flash for about 30 seconds.

Remember, the theft-deterrent system won't arm if you lock the doors with a key or use the manual door lock. It activates only if you use a power door lock with the door open or the remote keyless entry transmitter.

To avoid activating the alarm by accident do the following:

- The vehicle should be locked with the door key or the manual door lock after the doors are closed if you don't want to arm the theft-deterrent system.
- Always unlock a door with a key or use the remote keyless entry transmitter. Pressing the unlock button on the remote keyless entry transmitter disables the theft-deterrent system. Unlocking a door any other way will activate the alarm when a door or the trunk is opened.

If you activate the alarm by accident, unlock the driver's door with your key. You can also turn off the alarm by using the unlock button on the remote keyless entry transmitter, or by starting the car with a valid key.

Changes or modifications made to this system by other than an authorized service facility could void authorization to use the theft system.

Testing the Alarm

1. From inside the vehicle, roll down the window, then get out of the vehicle, keeping the door open.
2. From outside of the vehicle, with the door open, lock the vehicle using the power door lock or the remote keyless entry transmitter and close the door. Wait 30 seconds until the SECURITY lamp goes off.
3. Reach in and unlock the door using the manual lock and open the door. The horn will sound and the hazard lights will flash.

You can turn off the alarm by unlocking the driver's door with your key, using the unlock button on the remote keyless entry transmitter or by starting the car with a valid key.

If the alarm does not sound when it should, check to see if the horn works. The horn fuse may be blown. To replace the fuse, see *Fuses and Circuit Breakers on page 5-93*. If the fuse does not need to be replaced, you may need to have your vehicle serviced.

To reduce the possibility of theft, always arm the theft-deterrent system when leaving your vehicle.

Valet Lockout Switch



The valet lockout switch is located inside the glove box.

Press the switch to ON to disable the use of the trunk, fuel door, garage door opener and cellular telephone (option). The remote keyless entry transmitter cannot open the trunk if the valet lockout switch is in ON.

Press this switch to OFF to enable the use of the trunk, fuel door, garage door opener and optional cellular telephone.

Locking the glove box with your key will also help to secure your vehicle.

PASS-Key® III

Your PASS-Key® III system operates on a radio frequency subject to Federal Communications Commission (FCC) Rules and with Industry Canada.

This device complies with Part 15 of the FCC Rules. Operation is subject to the following two conditions:
(1) this device may not cause harmful interference, and
(2) this device must accept any interference received, including interference that may cause undesired operation.

This device complies with RSS-210 of Industry Canada. Operation is subject to the following two conditions:
(1) this device may not cause interference, and
(2) this device must accept any interference received, including interference that may cause undesired operation of the device.

Changes or modifications to this system by other than an authorized service facility could void authorization to use this equipment.

PASS-Key® III uses a radio frequency transponder in the key that matches a decoder in your vehicle.

PASS-Key® III Operation

Your vehicle is equipped with the PASS-Key® III (Personalized Automotive Security System) theft-deterrent system. PASS-Key® III is a passive theft-deterrent system. This means you don't have to do anything different to arm or disarm the system. It works when you insert or remove your key from the ignition.

When the PASS-Key® III system senses that someone is using the wrong key, it shuts down the vehicle's starter and fuel systems. The starter will not work and fuel will stop being delivered to the engine. Anyone using a trial-and-error method to start the vehicle will be discouraged because of the high number of electrical key codes.

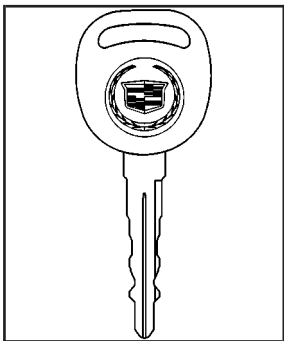

When trying to start the vehicle, if the engine does not start and the SECURITY light comes on, the key may have a damaged transponder. Turn the ignition off and try again.

If the engine does not start, and the key appears to be undamaged, try another ignition key. At this time, you may also want to check the fuse. See *Fuses and Circuit Breakers on page 5-93*. If the engine still does not start with the other key, your vehicle needs service. If your vehicle does start, the first key may be faulty. See your dealer who can service the PASS-Key® III to have a new key made.

It is possible for the PASS-Key® III decoder to learn the transponder value of a new or replacement key. Up to 10 additional keys may be programmed for the vehicle. This procedure is for learning additional keys only.

Canadian Owners: If you lose or damage your keys, only a GM dealer can service PASS-Key® III to have new keys made. To program additional keys you will require two current driver's keys (black in color). You must add a step to the following procedure. After Step 2, repeat Steps 1 and 2 with the second current driver's key. Then continue with Step 3.

To program the new key do the following:

1. Verify that the new key has PK3 stamped on it.
2. Insert the current driver's key in the ignition and start the engine. If the engine will not start see your dealer for service.
3. After the engine has started, turn the key to OFF, and remove the key.
4. Insert the key to be programmed and turn it to ON within 10 seconds of removing the previous key.

5. The SECURITY light will turn off once the key has been programmed. It may not be apparent that the SECURITY light went on due to how quickly the key is programmed.
6. Repeat the Steps 1 through 4 if additional keys are to be programmed.

If you are ever driving and the SECURITY light comes on and stays on, you will be able to restart your engine if you turn it off. Your PASS- Key[®] III system, however, is not working properly and must be serviced by your dealer. Your vehicle is not protected by the PASS-Key[®] III system at this time.

If you lose or damage a PASS-Key[®] III key, contact your dealer to have a new key made.

In an emergency, contact Cadillac Roadside Assistance. See *Roadside Service* on page 7-6.

Starting and Operating Your Vehicle

New Vehicle Break-In

Notice: Your vehicle doesn't need an elaborate "break-in." But it will perform better in the long run if you follow these guidelines:

- Don't drive at any one speed — fast or slow — for the first 500 miles (805 km). Don't make full-throttle starts.
- Avoid making hard stops for the first 200 miles (322 km) or so. During this time your new brake linings aren't yet broken in. Hard stops with new linings can mean premature wear and earlier replacement. Follow this breaking-in guideline every time you get new brake linings.
- Don't tow a trailer during break-in. See "Towing a Trailer" in the Index for more information.

Ignition Positions

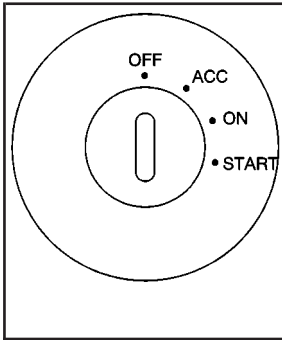

With the key in the ignition switch, located on the instrument panel, you can turn the key to four different positions:

OFF: This is the only position in which you can insert or remove the key. This position also locks the transaxle. It's a theft-deterrent feature.

ACC (Accessory): This position lets you use things like the radio, windshield wipers, power windows and optional sunroof when the engine is off. Use ACC if you must have your vehicle in motion while the engine is off (for example, if your vehicle is being pushed or towed).

ON: This is the position for driving.

START: This position starts the engine.

Notice: If your key seems stuck in OFF and you can't turn it, be sure you are using the correct key; if so, is it all the way in? Turn the key only with your hand. Using a tool to force it could break the key or the ignition switch. If none of this works, then your vehicle needs service.

Retained Accessory Power (RAP)

The following accessories on your vehicle may be used for up to 10 minutes after the ignition key is turned from ON to OFF:

- Cellular Phone (If Equipped)
- Radio
- Power Windows
- Audio Steering Wheel Controls
- Sunroof (Option)

Power to these accessories stops after 10 minutes or if a door is opened. If you want power for another 10 minutes, close all the doors and turn the ignition key to ON and then back to OFF. If the cellular phone is being used while retained accessory power is active, the timer is suspended to avoid interruption of the call. The timer resets to 10 minutes at the end of the call.

Starting Your Engine

Move your shift lever to PARK (P) or NEUTRAL (N). Your engine won't start in any other position – that's a safety feature. To restart when you're already moving, use NEUTRAL (N) only.

Notice: Do not try to shift to PARK (P) if your vehicle is moving. If you do, you could damage the transaxle. Shift to PARK (P) only when your vehicle is stopped.

1. With your foot off the accelerator pedal, turn your ignition key to START. When the engine starts, let go of the key. The idle speed will go down as your engine gets warm.

Notice: Holding your key in START for longer than 15 seconds at a time will cause your battery to be drained much sooner. And the excessive heat can damage your starter motor. Wait about 15 seconds between each try to help avoid draining your battery or damaging your starter.

2. If it doesn't start within 10 seconds, hold your key in START for about 10 seconds at a time until your engine starts. Wait about 15 seconds between each try.
3. If your engine still won't start (or starts but then stops), it could be flooded with too much gasoline. Try pushing your accelerator pedal all the way to the floor and holding it there as you hold the key in START for about three seconds. If the vehicle starts briefly but then stops again, do the same thing.

Notice: Your engine is designed to work with the electronics in your vehicle. If you add electrical parts or accessories, you could change the way the engine operates. Before adding electrical equipment, check with your dealer. If you do not, your engine might not perform properly.

Engine Coolant Heater

Your vehicle may be equipped with an engine coolant heater.

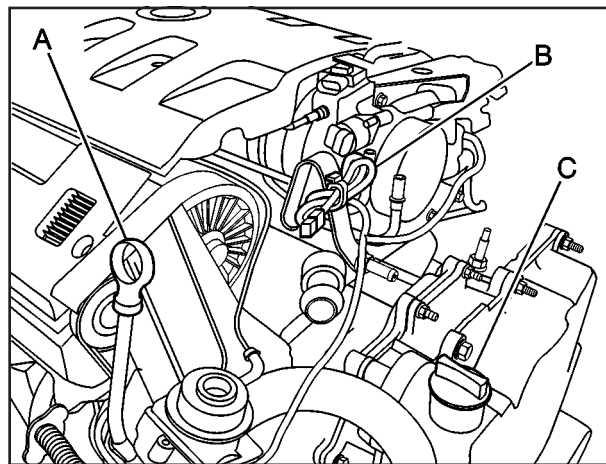

- A. Engine Oil Dipstick Location
- B. Engine Coolant Heater Cord
- C. Transaxle Dipstick/Fluid Fill Location

In very cold weather, 0°F (-18°C) or colder, the engine coolant heater can help. You'll get easier starting and better fuel economy during engine warm-up. Usually, the coolant heater should be plugged in a minimum of four hours prior to starting your vehicle. At temperatures above 32°F (0°C), use of the coolant heater is not required.

To Use the Engine Coolant Heater

1. Turn off the engine.
2. Open the hood and unwrap the electrical cord.
The electrical cord is located on the driver's side of the engine, behind the transaxle dipstick/fluid fill location (C) and next to the engine.
3. Plug it into a normal, grounded 110-volt AC outlet.

CAUTION:

Plugging the cord into an ungrounded outlet could cause an electrical shock. Also, the wrong kind of extension cord could overheat and cause a fire. You could be seriously injured.

CAUTION: (Continued)

CAUTION: (Continued)

Plug the cord into a properly grounded three-prong 110-volt AC outlet. If the cord will not reach, use a heavy-duty three-prong extension cord rated for at least 15 amps.

4. Before starting the engine, be sure to unplug and store the cord as it was before to keep it away from moving engine parts. If you don't, it could be damaged.

How long should you keep the coolant heater plugged in? The answer depends on the outside temperature, the kind of oil you have, and some other things. Instead of trying to list everything here, we ask that you contact your dealer in the area where you'll be parking your vehicle. The dealer can give you the best advice for that particular area.

Automatic Transaxle Operation

There are several different positions for the shift lever.



PARK (P): This position locks the front wheels. It's the best position to use when you start the engine because your vehicle can't move easily.

CAUTION:

It is dangerous to get out of your vehicle if the shift lever is not fully in PARK (P) with the parking brake firmly set. Your vehicle can roll.

CAUTION: (Continued)

CAUTION: (Continued)

Do not leave your vehicle when the engine is running unless you have to. If you have left the engine running, the vehicle can move suddenly. You or others could be injured. To be sure your vehicle will not move, even when you are on fairly level ground, always set your parking brake and move the shift lever to PARK (P). See “Shifting Into Park (P)” in the Index. If you are pulling a trailer, see “Towing a Trailer” in the Index.

Ensure the shift lever is fully in PARK (P) before starting the engine. Your vehicle has an automatic transaxle shift lock control system. You have to fully apply your regular brakes before you can shift from PARK (P) while the ignition key is in ON. If you cannot shift the shift lever all the way into PARK (P), ease pressure on the shift lever and push the shift lever all the way into PARK (P) as you maintain brake application. Then move the shift lever into the gear you wish. See *Shifting Out of Park (P)* on page 2-34.

REVERSE (R): Use this gear to backup.

Notice: Shifting to **REVERSE (R)** while your vehicle is moving forward could damage your transaxle. Shift to **REVERSE (R)** only after your vehicle is stopped.

Also use this gear to rock your vehicle back and forth to get out of snow, ice or sand without damaging your transaxle. See *If You Are Stuck: In Sand, Mud, Ice or Snow* on page 4-30 for additional information.

NEUTRAL (N): In this position, the engine doesn't connect with the wheels. To restart when you're already moving, use **NEUTRAL (N)** only. Also use **NEUTRAL (N)** when your vehicle is being towed.

 **CAUTION:**

Shifting into a drive gear while your engine is running at high speed is dangerous. Unless your foot is firmly on the brake pedal, your vehicle could move very rapidly. You could lose control and hit people or objects. Do not shift into a drive gear while your engine is running at high speed.

AUTOMATIC OVERDRIVE (D): This position is for normal driving. If you need more power for passing, and you're:

- Going less than 35 mph (55 km/h), push the accelerator pedal about halfway down.
- Going about 35 mph (55 km/h) or more, push the accelerator all the way down.

The transaxle will shift down to the next gear and have more power.

Notice: If your vehicle seems to start up rather slowly, or if it seems not to shift gears as you go faster, something may be wrong with a transaxle system sensor. If you drive very far that way, your vehicle can be damaged. So, if this happens, have your vehicle serviced right away. Until then, you can use **SECOND (2)** when you are driving less than 35 mph (55 km/h) and **AUTOMATIC OVERDRIVE (D)** for higher speeds.

THIRD (3): This position is also used for normal driving, however, it offers more power and lower fuel economy than AUTOMATIC OVERDRIVE (Ⓓ).

Here are examples for using THIRD (3) instead of AUTOMATIC OVERDRIVE (Ⓓ):

- When driving on hilly, winding roads.
- When going down a steep hill.

SECOND (2): This position gives you more power. You can use SECOND (2) on hills. It can help control your speed as you go down steep mountain roads, but then you would also want to use your brakes off and on.

Notice: Don't shift into SECOND (2) unless you are going slower than 65 mph (105 km/h), or you can damage your engine.

FIRST (1): This position gives you even more power than SECOND (2). You can use it on very steep hills, or in deep snow or mud.

If the traction control switch is off, your vehicle will not go into FIRST (1) gear and the vehicle will accelerate from stop more slowly. This can help in deep snow or mud conditions. When the traction control is turned off, a message will light up on the Driver Information Center (DIC).

Notice: If your front wheels won't turn, don't try to drive. This might happen if you were stuck in very deep sand or mud or were up against a solid object. You could damage your transaxle. Also, if you stop when going uphill, don't hold your vehicle there with only the accelerator pedal. This could overheat and damage the transaxle. Use your brakes to hold your vehicle in position on a hill.

Performance Shift Display (STS Only)

When your vehicle detects a change in driving conditions, it will automatically initiate the appropriate performance shift mode. When this occurs, the gear display on the instrument panel cluster will change to indicate that the transaxle has shifted to a different gear. For example, the gear display on the cluster may indicate D, 3, 2, or 1 even though the gearshift lever is still in AUTOMATIC OVERDRIVE (Ⓓ). Once the performance shift mode ends, the gear display on the instrument panel cluster will return to normal.

Parking Brake



The parking brake pedal is located to the left of the regular brake pedal, near the driver's door.

To set the parking brake, hold the regular brake pedal down with your right foot and push the parking brake pedal down with your left foot.

If the ignition is on, the brake system warning light on the instrument panel cluster should come on. If it doesn't, you need to have your vehicle serviced.

When you move out of PARK (P) or NEUTRAL (N) and the engine is running, the parking brake should release. If the parking brake has not been fully released and you try to drive off with the parking brake on, the brake system warning light will come on and stay on and a multiple chime will sound. See *Brake System Warning and Parking Brake Indicator Light on page 3-43* for more information.

If the parking brake doesn't fully release, you can manually release the pedal. However, be sure to read the following paragraphs:

CAUTION:

Always shift to PARK (P) before pulling the manual release lever. If your hand or arm is in the way of the pedal you could be hurt. The pedal springs back quickly. Keep your hand and arm away when you use the manual release lever.

Before releasing the manual parking brake, be sure to put the vehicle in PARK (P) and turn the ignition to OFF.

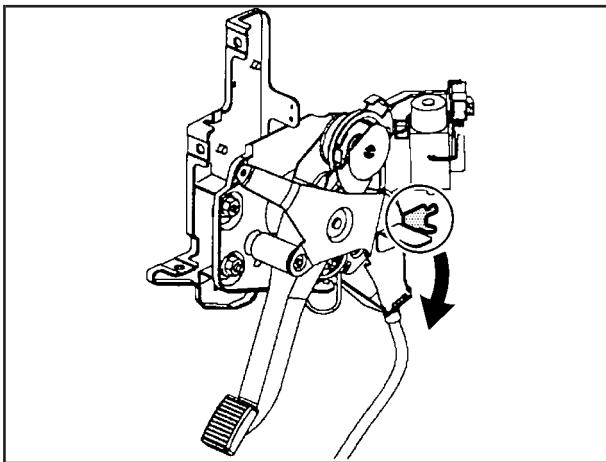

Reach under the driver's side of the instrument panel and pull down on the manual release lever, which is located behind the parking brake pedal. Pull down on the yellow tab as shown by the arrow in the illustration. If the parking brake does not release, you should have your vehicle towed to your dealer for service.

Notice: Driving with the parking brake on can cause your rear brakes to overheat. You may have to replace them, and you could also damage other parts of your vehicle.

If you are towing a trailer and are parking on a hill, see *Towing a Trailer* on page 4-35.

Shifting Into Park (P)

CAUTION:

It can be dangerous to get out of your vehicle if the shift lever is not fully in PARK (P) with the parking brake firmly set. Your vehicle can roll. If you have left the engine running, the vehicle can move suddenly. You or others could be injured. To be sure your vehicle will not move, even when you are on fairly level ground, use the steps that follow. If you are pulling a trailer, see "Towing a Trailer" in the Index.

1. Hold the brake pedal down with your right foot.



2. Move the shift lever into PARK (P) by pushing the lever all the way toward the front of your vehicle and then to the left.

3. With your right foot still holding the brake pedal down, set the parking brake.
4. Turn the ignition key to OFF.
5. Remove the key and take it with you. If you can leave your vehicle with the ignition key in your hand, your vehicle is in PARK (P).

Leaving Your Vehicle With the Engine Running

CAUTION:

It can be dangerous to leave your vehicle with the engine running. Your vehicle could move suddenly if the shift lever is not fully in PARK (P) with the parking brake firmly set. And, if you leave the vehicle with the engine running, it could overheat and even catch fire. You or others could be injured. Do not leave your vehicle with the engine running.

If you have to leave your vehicle with the engine running, be sure your vehicle is in PARK (P) and your parking brake is firmly set before you leave it.

Torque Lock

If you are parking on a hill and you don't shift your transaxle into PARK (P) properly, the weight of the vehicle may put too much force on the parking pawl in the transaxle. You may find it difficult to pull the shift lever out of PARK (P). This is called "torque lock." To prevent torque lock, set the parking brake and then shift into PARK (P) properly before you leave the driver's seat. To find out how, see *Shifting Into Park (P) on page 2-32*.

If torque lock does occur, you may need to have another vehicle push yours a little uphill to take some of the pressure from the parking pawl in the transaxle, so you can pull the shift lever out of PARK (P).

Shifting Out of Park (P)

Your vehicle has an automatic transaxle shift lock control system. You have to fully apply your regular brakes before you can shift from PARK (P) when the ignition is ON. See *Automatic Transaxle Operation on page 2-28*.

If you cannot shift out of PARK (P), ease the pressure on the shift lever. Push the shift lever all the way into PARK (P) as you maintain brake application. Then move the shift lever into the gear you want. If you ever hold the pedal down but still can't shift out of PARK (P), try the following:

1. Turn the ignition key to ACC. Open and close the driver's door to turn off the RAP feature.
2. Apply and hold the brake until the end of Step 4.
3. Shift to NEUTRAL (N).
4. Start the vehicle and then shift to the drive gear you want.
5. Have the vehicle fixed as soon as you can.

Parking Over Things That Burn

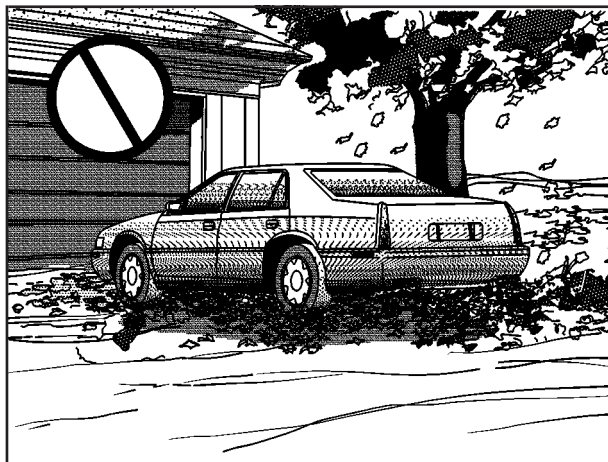

CAUTION:

Things that can burn could touch hot exhaust parts under your vehicle and ignite. Do not park over papers, leaves, dry grass or other things that can burn.

Engine Exhaust

CAUTION:

Engine exhaust can kill. It contains the gas carbon monoxide (CO), which you can not see or smell. It can cause unconsciousness and death.

You might have exhaust coming in if:

- Your exhaust system sounds strange or different.
- Your vehicle gets rusty underneath.
- Your vehicle was damaged in a collision.
- Your vehicle was damaged when driving over high points on the road or over road debris.
- Repairs were not done correctly.
- Your vehicle or exhaust system had been modified improperly.

If you ever suspect exhaust is coming into your vehicle:

- Drive it only with all the windows down to blow out any CO; and
- Have your vehicle fixed immediately.

Running Your Engine While You Are Parked

It's better not to park with the engine running. But if you ever have to, here are some things to know.

CAUTION:

Idling the engine with the climate control system off could allow dangerous exhaust into your vehicle. See the earlier Caution under “Engine Exhaust.”

Also, idling in a closed-in place can let deadly carbon monoxide (CO) into your vehicle even if the climate control fan is at the highest setting. One place this can happen is a garage. Exhaust — with CO — can come in easily. NEVER park in a garage with the engine running.

Another closed-in place can be a blizzard. See “Winter Driving” in the Index.

CAUTION:

It can be dangerous to get out of your vehicle if the shift lever is not fully in PARK (P) with the parking brake firmly set. Your vehicle can roll. Don't leave your vehicle when the engine is running unless you have to. If you've left the engine running, the vehicle can move suddenly. You or others could be injured. To be sure your vehicle won't move, even when you're on fairly level ground, always set your parking brake after you move the shift lever to PARK (P).

Follow the proper steps to be sure your vehicle won't move. See *Shifting Into Park (P)* on page 2-32.

If you are parking on a hill and if you're pulling a trailer, also see *Towing a Trailer* on page 4-35.

Mirrors

Automatic Dimming Rearview Mirror with OnStar[®]

Your vehicle may have an automatic dimming rearview mirror with OnStar[®] system controls. For more information about OnStar[®], see *OnStar[®] System on page 2-42*.

When the automatic dimming feature is turned on, the mirror automatically changes to reduce glare from headlamps behind you. A photocell on the mirror senses when it is becoming dark outside. Another photocell built into the mirror face senses when headlamps are behind you.

At night, when the glare is too bright, the mirror will gradually darken to reduce glare. This change may take a few seconds. The mirror will return to its clear, daytime state when the glare is reduced.

Mirror Operation

 **(On/Off):** This is the on/off button, located on the lower left side of the mirror face.

To turn the automatic dimming feature on or off, press the on/off button. The indicator light will be illuminated when the automatic dimming feature is on.

Cleaning the Mirror

When cleaning the mirror, use a paper towel or similar material dampened with glass cleaner. Do not spray glass cleaner directly on the mirror as that may cause the liquid cleaner to enter the mirror housing.

Automatic Dimming Rearview Mirror with OnStar[®] and Compass

Your vehicle may have an automatic dimming rearview mirror with a compass display. The mirror also contains OnStar[®] controls. For more information see *OnStar[®] System on page 2-42*.

The automatic dimming feature functions the same as that of the automatic dimming rearview mirror without a compass. See *Automatic Dimming Rearview Mirror with OnStar[®] on page 2-37*.

The mirror also includes an eight-point compass display in the upper right corner of the mirror face. When on, the compass automatically calibrates as the vehicle is driven.

Mirror Operation

 **(On/Off):** The on/off button is located on the lower left side of the mirror face for the automatic dimming and compass functions of the rearview mirror.

To turn on the automatic dimming feature, press and hold the on/off button for about three seconds. To turn off automatic dimming, press and hold the on/off button for about three seconds again. The indicator light will illuminate when this feature is active. The automatic dimming feature is active each time the vehicle is started.

Compass Operation

Press the on/off button once to turn the compass on or off.

When the ignition and the compass feature are on, the compass will show two character boxes for about two seconds. After two seconds, the mirror will display the compass heading.

Compass Calibration

If after two seconds, the display does not show a compass heading (for example, N for North), there may be a strong magnetic field interfering with the compass. Such interference may be caused by a magnetic antenna mount, magnetic note pad holder or a similar magnetic item. If the letter C should ever appear in the compass window, the compass may need calibration.

The mirror can be calibrated by driving the vehicle in circles at 5 mph (8 km/h) or less until the display reads a direction.

The compass can be placed in calibration mode manually by pressing and holding the on/off button until a C is shown in the compass display.

Compass Variance

The zone is set to zone eight upon leaving the factory. It will be necessary to adjust the compass to compensate for compass variance if you live outside zone eight. Under certain circumstances, as during a long distance cross-country trip, it will be necessary to adjust for compass variance. Compass variance is the difference between earth's magnetic north and true geographic north. If not adjusted to account for compass variance, your compass could give false readings.

To adjust for compass variance do the following:

1. Find the current location and variance zone number on the following zone map.
2. Press and hold the on/off button until a zone number appears in the display.

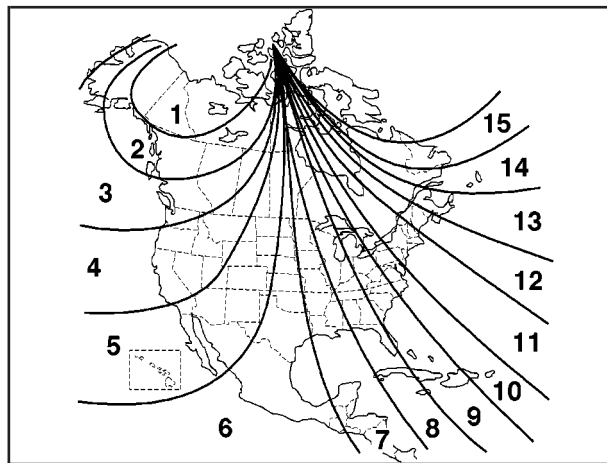

3. Once the zone number appears in the display, press the on/off button quickly until the correct zone number appears in the display. Stop pressing the button and the mirror will return to normal operation. If C appears in the compass window, the compass may need calibration. See *Compass Calibration* listed previously.

Cleaning the Mirror

When cleaning the mirror, use a paper towel or similar material dampened with glass cleaner. Do not spray glass cleaner directly on the mirror as that may cause the liquid cleaner to enter the mirror housing.

Outside Power Mirrors



The control on the driver's door armrest operates both outside rearview mirrors.

Press (R) on the selector switch to choose the right mirror or (L) to choose the left mirror. The center position is off and will not allow the mirrors to move if the control pad is touched.

To adjust a mirror, press the arrows on the control pad to move the mirror in the direction you want the mirror to go. Adjust each mirror so you can see the side of your vehicle and the area behind your vehicle.

The mirrors can be manually folded inward to prevent damage when going through an automatic car wash. To fold, push the mirror toward the vehicle. To return the mirror to its original position, push outward. Be sure to return both mirrors to their original unfolded positions before driving.

The mirrors can also be programmed for personalization and parallel parking feature if you have the optional memory package. For more information, see *Memory Seat, Mirrors and Steering Wheel* on page 2-51 and *DIC Vehicle Personalization* on page 3-64.

Outside Automatic Dimming Mirror

If your vehicle is equipped with this feature, the driver's side mirror will adjust for the glare of headlamps behind you. This feature is controlled by the on and off settings on the automatic dimming rearview mirror. See *Automatic Dimming Rearview Mirror with OnStar®* on page 2-37.

Outside Curb View Assist Mirror

If your vehicle is equipped with memory mirrors, it will also be capable of performing the curb view assist mirror feature. This feature will cause the passenger's mirror to tilt to a factory programmed position when the vehicle is in REVERSE (R). This feature may be useful in allowing you to view the curb when you are parallel parking.

When the vehicle is shifted out of REVERSE (R) and a five-second delay has occurred, the passenger's mirror will return to its original position.

If further adjustment is needed after the mirror is tilted, the mirror switch may be used.

This feature can be enabled/disabled through the Driver Information Center (DIC). See *DIC Vehicle Personalization* on page 3-64 for more information.

Outside Convex Mirror

Your passenger's side mirror is convex. A convex mirror's surface is curved so you can see more from the driver's seat. This mirror does not have a dimming feature.

CAUTION:

A convex mirror can make things (like other vehicles) look farther away than they really are. If you cut too sharply into the right lane, you could hit a vehicle on your right. Check your inside mirror or glance over your shoulder before changing lanes.

Outside Heated Mirrors

When you operate the rear window defogger, it also warms both outside mirrors to help clear them of fog or ice. See *Dual Climate Control System* on page 3-28 for more information.

OnStar® System



OnStar® uses global positioning system (GPS) satellite technology, wireless communications, and call centers to provide you with a wide range of safety, security, information and convenience services.

A complete OnStar® user's guide and the terms and conditions of the OnStar® Subscription Service Agreement are included in your vehicle's glove box literature. For more information, visit www.onstar.com, contact OnStar® at 1-888-4-ONSTAR (1-888-466-7827), or press the blue OnStar® button to speak to an OnStar® advisor 24 hours a day, 7 days a week.

A completed Subscription Service Agreement is required prior to delivery of OnStar® services and prepaid calling minutes are also required for OnStar® Personal Calling and OnStar® Virtual Advisor use. Terms and conditions of the Subscription Service Agreement can be found at www.onstar.com.

OnStar® Services

One of the following plans is normally included for a specific duration with each vehicle equipped with OnStar®. You can upgrade or extend your OnStar® service plan to meet your needs.

Safe and Sound Plan

- Automatic Notification of Air Bag Deployment
- Emergency Services
- Roadside Assistance
- Stolen Vehicle Assistance
- AccidentAssist
- Remote Door Unlock
- Remote Diagnostics
- Online Concierge

Directions and Connections Plan

- All Safe and Sound Plan services
- Route Support
- RideAssist
- Information and Convenience Services

Luxury and Leisure Plan

- All Directions and Connections Plan services
- Personal Concierge

OnStar® Personal Calling

With OnStar® Personal Calling, you have a safer way to stay connected while driving. It's a hands-free wireless phone that's integrated into your vehicle. You can place calls nationwide using voice-activated dialing with no contracts and no additional roaming charges. To find out more about OnStar® Personal Calling, refer to the OnStar® user's guide in your vehicle's glove box, or call OnStar® at 1-888-4-ONSTAR (1-888-466-7827).

OnStar® Virtual Advisor

With OnStar® Virtual Advisor you can listen to the news, entertainment and informative topics, such as traffic and weather reports. You are able to listen and reply to your e-mail through your vehicle's speakers.

OnStar® Steering Wheel Controls

You can use the steering wheel controls with OnStar®.



The controls are located on the left side of the steering wheel.

Press the top part of the control to access OnStar®. You will hear a ready prompt from the system, and then you can begin your OnStar® session or begin making calls.

If your vehicle has the optional Navigation system or cellular phone, the ready prompt will come from that system first. You must say the word phone to access OnStar®.

If your vehicle has both optional systems, the ready prompt will come from the Navigation system first. When you say the word phone after the ready prompt, you will access the cellular phone.

If you prefer to use OnStar® to make calls, you must repeat the word phone again after the cellular phone ready prompt.

To end a communication session, press the bottom part of the control that says END.

HomeLink® Transmitter



HomeLink®, a combined universal transmitter and receiver, provides a way to replace up to three hand-held transmitters used to activate devices such as gate operators, garage door openers, entry door locks, security systems and home lighting. Additional HomeLink® information can be found on the internet at www.homelink.com or by calling 1-800-335-3515.

If your vehicle is equipped with the HomeLink® Transmitter, it complies with Part 15 of the FCC Rules. Operation is subject to the following two conditions: (1) this device may not cause harmful interference, and (2) this device must accept any interference received, including interference that may cause undesired operation.

This device complies with RSS-210 of Industry Canada. Operation is subject to the following two conditions: (1) this device may not cause interference, and (2) this device must accept any interference, including interference that may cause undesired operation of the device.

Changes and modifications to this system by other than an authorized service facility could void authorization to use this equipment.

Programming the HomeLink® Transmitter

Do not use the HomeLink® Transmitter with any garage door opener that does not have the “stop and reverse” feature. This includes any garage door opener model manufactured before April 1, 1982. If you have a newer garage door opener with rolling codes, please be sure to follow steps 6 through 8 to complete the programming of your HomeLink® Transmitter.

Read the instructions completely before attempting to program the HomeLink® Transmitter. Because of the steps involved, it may be helpful to have another person available to assist you in programming the transmitter.

Keep the original transmitter for use in other vehicles as well as for future HomeLink® programming. It is also recommended that upon the sale of the vehicle, the programmed HomeLink® buttons should be erased for security purposes. Refer to “Erasing HomeLink® Buttons” or, for assistance, contact HomeLink® on the internet at: www.homelink.com or by calling 1-800-355-3515.

Be sure that people and objects are clear of the garage door or gate operator you are programming. When programming a garage door, it is advised to park outside of the garage.

It is recommended that a new battery be installed in your hand-held transmitter for quicker and more accurate transmission of the radio frequency.

Your vehicle's engine should be turned off while programming the transmitter. Follow these steps to program up to three channels:

1. Press and hold down the two outside buttons, releasing only when the indicator light begins to flash, after 20 seconds. Do not hold down the buttons for longer than 30 seconds and do not repeat this step to program a second and/or third transmitter to the remaining two HomeLink® buttons.
2. Position the end of your hand-held transmitter about 1 to 3 inches (3 to 8 cm) away from the HomeLink® buttons while keeping the indicator light in view.
3. Simultaneously press and hold both the desired button on HomeLink® and the hand-held transmitter button. Do not release the buttons until Step 4 has been completed.

Some entry gates and garage door openers may require you to substitute Step 3 with the procedure noted in “Gate Operator and Canadian Programming” later in this section.

4. The indicator light will flash slowly at first and then rapidly after HomeLink® successfully receives the frequency signal from the hand-held transmitter. Release both buttons.
5. Press and hold the newly-trained HomeLink® button and observe the indicator light.

If the indicator light stays on constantly, programming is complete and your device should activate when the HomeLink® button is pressed and released.

To program the remaining two HomeLink® buttons, begin with Step 2 under “Programming HomeLink®.” Do not repeat Step 1 as this will erase all of the programmed channels.

If the indicator light blinks rapidly for two seconds and then turns to a constant light, continue with Steps 6 through 8 following to complete the programming of a rolling-code equipped device (most commonly, a garage door opener).

6. Locate in the garage, the garage door opener receiver (motor-head unit). Locate the “Learn” or “Smart” button. This can usually be found where the hanging antenna wire is attached to the motor-head unit.
7. Firmly press and release the “Learn” or “Smart” button. The name and color of the button may vary by manufacturer.

You will have 30 seconds to start Step 8.

8. Return to the vehicle. Firmly press and hold the programmed HomeLink® button for two seconds, then release. Repeat the press/hold/release sequence a second time, and depending on the brand of the garage door opener (or other rolling code device), repeat this sequence a third time to complete the programming.

HomeLink® should now activate your rolling-code equipped device.

To program the remaining two HomeLink® buttons, begin with Step 2 of “Programming HomeLink®.” Do not repeat Step 1.

Gate Operator and Canadian Programming

Canadian radio-frequency laws require transmitter signals to “time out” or quit after several seconds of transmission. This may not be long enough for HomeLink® to pick up the signal during programming. Similarly, some U.S. gate operators are manufactured to “time out” in the same manner.

If you live in Canada, or you are having difficulty programming a gate operator by using the “Programming HomeLink®” procedures (regardless of where you live), replace Step 3 under “Programming HomeLink®” with the following:

Continue to press and hold the HomeLink® button while you press and release every two seconds (cycle) your hand-held transmitter until the frequency signal has been successfully accepted by HomeLink®. The indicator light will flash slowly at first and then rapidly. Proceed with Step 4 under “Programming HomeLink®” to complete.

Using HomeLink®

Press and hold the appropriate HomeLink® button for at least half of a second. The indicator light will come on while the signal is being transmitted.

Erasing HomeLink® Buttons

To erase programming from the three buttons do the following:

1. Press and hold down the two outside buttons until the indicator light begins to flash, after 20 seconds.
2. Release both buttons. Do not hold for longer than 30 seconds.

HomeLink® is now in the train (learning) mode and can be programmed at any time beginning with Step 2 under “Programming HomeLink®.”

Individual buttons can not be erased, but they can be reprogrammed. See “Reprogramming a Single HomeLink® Button” next.

Reprogramming a Single HomeLink® Button

To program a device to HomeLink® using a HomeLink® button previously trained, follow these steps:

1. Press and hold the desired HomeLink® button. Do not release the button.
2. The indicator light will begin to flash after 20 seconds. While still holding the HomeLink® button, proceed with Step 2 under “Programming HomeLink®.”

Resetting Defaults

To reset HomeLink® to default settings do the following:

1. Hold down the two outside buttons for about 20 seconds until the indicator light begins to flash.
2. Continue to hold both buttons until the HomeLink® indicator light turns off.
3. Release both buttons.

For questions or comments, contact HomeLink® at 1-800-355-3515, or on the internet at www.homelink.com.

Storage Areas

Glove Box

The glove box is located in front of the passenger’s seat on the instrument panel. To lock the glove box door, insert the master key into the lock cylinder and turn it clockwise. Turn the key counterclockwise to unlock the door.

Cellular Telephone

Your vehicle may have been prewired for dealer installation of a portable cellular telephone system. The system has steering wheel telephone controls and information output through the Driver Information Center (DIC). Voice activation with remote record and hands-free operation are standard features. For more information, contact your dealer. A user’s guide is provided with the telephone.

Center Console Storage Area

The center console comes with a storage tray, a storage compartment for CDs or tapes, a dual cupholder that unfolds, a coinholder, an optional phone and an armrest. The cupholder can be opened by pressing on the surface panel located in front of the armrest and unfolding it. Close the lid to secure it.

Map Pocket

The map/storage pockets are located on each front door as well as on the passenger's and driver's seatbacks.

Assist Handles

A handle above each door can be used when getting out of your vehicle.

Garment Hooks

For your convenience, a garment hook is attached to each rear assist handle.

Umbrella Holder

The driver's and passenger's front seat cushion may be equipped with an umbrella holder. Gently slide the umbrella into the slot located under the front portion of the driver's or passenger's seat cushion.

Floor Mats

Your vehicle is equipped with rubber-backed front and rear floor mats. Keep them clean by vacuuming and using a spot cleaner, if necessary. Do not machine wash.

Convenience Net

Your vehicle may be equipped with a convenience net. The net attaches to the floor of the trunk. Put small loads, like grocery bags, behind the net. It can help keep them from falling over during sharp turns or quick starts and stops.

The net is not for larger, heavier loads. Store them in the trunk as far forward as you can. When not using the net, hook the net to the tabs securing it to the sill plate.

Sunroof

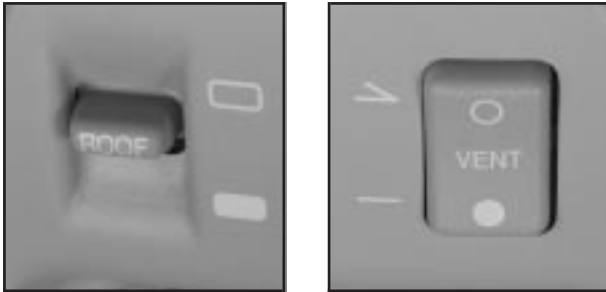

The two switches that operate the optional sunroof are located on the overhead console and include VENT, ROOF, open and close.

Press and hold the ROOF switch rearward to the first position to open the glass panel and sunshade. The sunshade also can be opened or closed manually. To close the glass panel, press and hold the ROOF switch forward. As the sunroof reaches the closed position, it will open slightly toward the vent position and then drop down to the closed position to provide a better seal.

Press and release the ROOF switch rearward to the second position to express-open the glass panel to the comfort stop position, approximately half-way open. The comfort stop position is designed to help reduce noise and make the rear seat passengers more comfortable.

The glass panel may then be fully opened by pressing the ROOF switch again.

If you press and hold the ROOF switch in the express-open position for more than one second, the express-open operation will be over-ridden and the sunroof will stop when the switch is released.

To stop the glass panel when express opening, press the ROOF or VENT switch forward or rearward and release.

To vent the glass panel, press and hold the VENT switch in the open position. The sunshade must be opened manually when using the vent position. To close the glass panel, press and hold the VENT switch in the close position.

The ROOF and VENT switches work only when the ignition is on or when RAP is active. See “Retained Accessory Power (RAP)” under *Ignition Positions* on page 2-24.

Vehicle Personalization

Memory Seat, Mirrors and Steering Wheel



If your vehicle has this feature, the controls are located on the driver's door panel.

These buttons are used to program and recall memory settings for the driver's seating and outside rearview mirror positions.

Use the following steps to program each button:

1. Adjust the driver's seat (including the seatback recliner, lumbar, head restraint and shoulder belt height adjustments), both outside mirrors and the steering wheel to a comfortable position.
2. Press the MEMORY SET button.
3. Within five seconds, press button 1 for Driver 1. A single beep will sound through the driver's side front speaker to let you know that the position has been stored.

A second mirror, seating and steering wheel position can be programmed by repeating the above steps and pressing button 2 (for Driver 2). Each time a memory button is pressed, a single beep will sound. Each time button 1 or 2 is pressed and released while the vehicle is in PARK (P), the memory positions will be recalled. If the vehicle is not in PARK (P), the memory buttons must be pressed and held to recall the stored positions.

If you use the remote keyless entry transmitter to enter your vehicle, automatic seat and mirror movement will occur. The numbers on the back of the transmitters, 1 and 2, correspond to the numbers on the buttons on the door panel.

When the key is placed in the ignition in OFF and you have entered the vehicle without using the remote keyless entry transmitter, the seats and mirrors will automatically adjust to the programmed position of the last driver.

To stop recall movement of the memory feature at any time, press one of the power seat controls or memory buttons.

Two personalized exit positions can be set by first recalling the driving position (by pressing 1 or 2), then positioning the steering wheel and seat in the desired exit positions. Then press and release the MEMORY SET button and, within five seconds, press the EXIT button. With the vehicle in PARK (P), the exit position for the previously set driver can be recalled by pressing the EXIT button. The mirrors, power lumbar and shoulder belt height positions will not be stored or recalled for the exit positions.

Further programming for automatic seat and mirror movement can be done using the Driver Information Center (DIC). You can select or not select the following:

- Automatic seat and mirror movement when the vehicle is unlocked with the remote keyless entry transmitter, or
- automatic seat and mirror movement when a key is placed in the ignition.

For programming information, see *DIC Vehicle Personalization on page 3-64*.

Section 3 Instrument Panel

| | | | |
|---------------------------------------------------|------|-----------------------------------------------------------------|------|
| Instrument Panel Overview | 3-4 | Safety Belt Reminder Light | 3-41 |
| Hazard Warning Flashers | 3-6 | Air Bag Readiness Light | 3-42 |
| Other Warning Devices | 3-7 | Charging System Light | 3-43 |
| Horn | 3-7 | Brake System Warning and Parking Brake Indicator Light | 3-43 |
| Tilt Wheel | 3-7 | Anti-Lock Brake System Warning Light | 3-44 |
| Turn Signal/Multifunction Lever | 3-9 | Traction Control System (TCS) Warning Light | 3-45 |
| Exterior Lamps | 3-16 | Engine Coolant Temperature Warning Light | 3-46 |
| Interior Lamps | 3-21 | Engine Coolant Temperature Gage | 3-46 |
| Ultrasonic Rear Parking Assist (URPA) | 3-24 | Malfunction Indicator Lamp | 3-47 |
| Accessory Power Outlets | 3-26 | Oil Pressure Light | 3-50 |
| Ashtrays and Cigarette Lighter | 3-27 | Security Light | 3-51 |
| Climate Controls | 3-28 | Fog Lamp Light | 3-51 |
| Dual Climate Control System | 3-28 | Lights On Reminder | 3-51 |
| Outlet Adjustment | 3-33 | Cruise Control Light | 3-51 |
| Rear Climate Control System | 3-34 | Fuel Gage | 3-52 |
| Passenger Compartment Air Filter | 3-35 | Driver Information Center (DIC) | 3-53 |
| Steering Wheel Climate Controls | 3-35 | DIC Controls and Displays | 3-53 |
| Climate Controls Personalization | 3-36 | DIC Warnings and Messages | 3-56 |
| Warning Lights, Gages and Indicators | 3-37 | Climate Controls and Radio System Personalization | 3-63 |
| Instrument Panel Cluster | 3-38 | DIC Vehicle Personalization | 3-64 |
| Speedometer and Odometer | 3-39 | | |
| Tachometer | 3-41 | | |

Section 3 Instrument Panel

| | | | |
|-----------------------------------------------------------------------|------|-----------------------------------------------------------------------|-------|
| Trip Computer | 3-77 | Radio Personalization with Home and Away Feature | 3-102 |
| Oil Life Indicator | 3-77 | Theft-Deterrent Feature | 3-102 |
| Audio System(s) | 3-78 | Audio Steering Wheel Controls | 3-103 |
| Setting the Time for Radios without Radio Data Systems (RDS) | 3-78 | Understanding Radio Reception | 3-103 |
| Setting the Time for Radios with Radio Data Systems (RDS) | 3-78 | Care of Your Cassette Tape Player | 3-104 |
| Radio with Cassette and CD (Base Level) | 3-79 | Care of Your CDs | 3-105 |
| Radio with Cassette and CD (Up Level) | 3-87 | Care of Your CD Player | 3-105 |
| Navigation/Radio System | 3-98 | Diversity Antenna System | 3-106 |
| Console-Mounted CD Changer | 3-99 | XM™ Satellite Radio Antenna System (48 Contiguous US States) | 3-106 |

Instrument Panel Overview

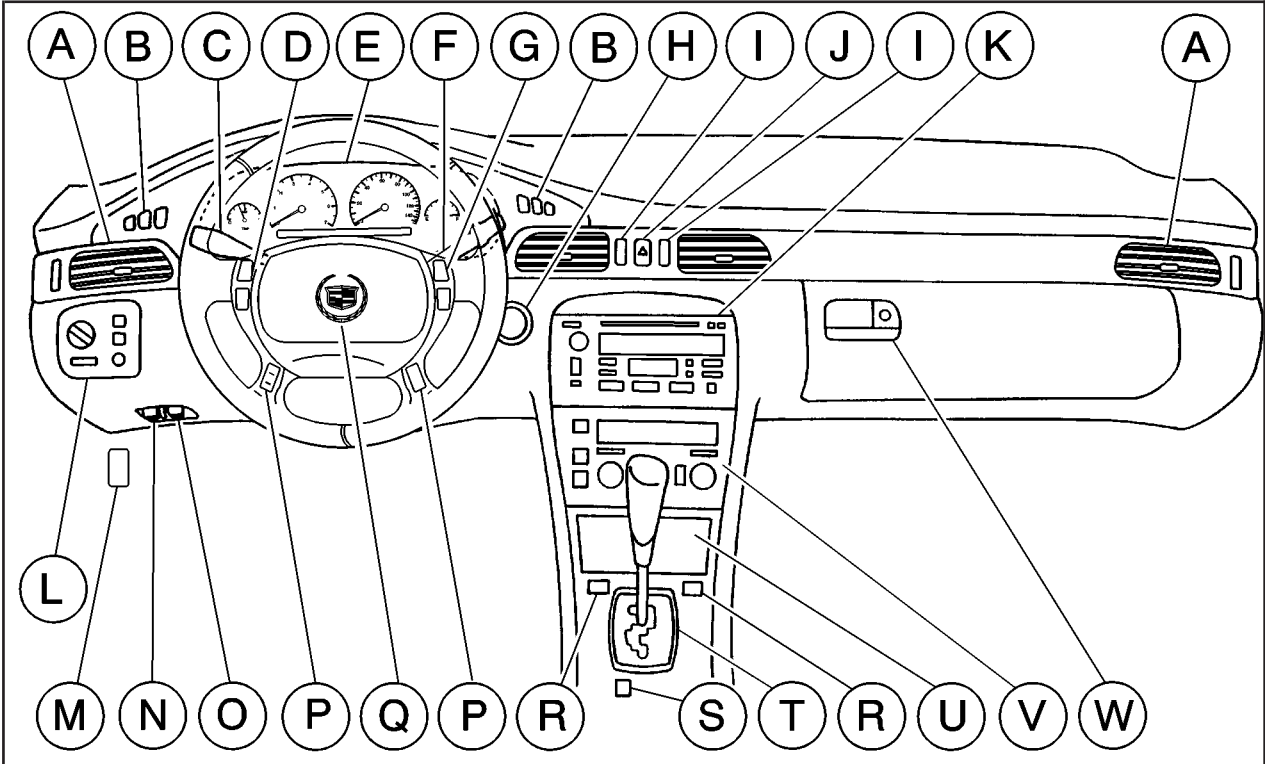

The main components of the instrument panel are the following:

- A. Air Outlets. See *Outlet Adjustment on page 3-33*.
- B. Driver Information Center (DIC) Buttons. See *DIC Controls and Displays on page 3-53*.
- C. Turn Signal/Multifunction Lever. See *Turn Signal/Multifunction Lever on page 3-9*.
- D. Climate Controls and OnStar® Steering Wheel Controls (or Cellular Telephone Controls, If Equipped).
See *Steering Wheel Climate Controls on page 3-35* and *OnStar® System on page 2-42*.
- E. Instrument Panel Cluster. See *Instrument Panel Cluster on page 3-38*.
- F. Windshield Wiper/Washer Lever. See “Windshield Wipers” under *Turn Signal/Multifunction Lever on page 3-9*.
- G. Audio Steering Wheel Controls. See *Audio Steering Wheel Controls on page 3-103*.
- H. Ignition Switch. See *Ignition Positions on page 2-24*.
 - I. Air Outlet Thumbwheel. See *Outlet Adjustment on page 3-33*.
 - J. Hazard Warning Flasher Button. See *Hazard Warning Flashers on page 3-6*.
- K. Audio System. See *Audio System(s) on page 3-78*.
- L. Exterior Lamp Controls. See *Exterior Lamps on page 3-16*.
- M. Hood Release. See *Hood Release on page 5-11*.
- N. Fuel Door Release. See *Filling Your Tank on page 5-6*.
- O. Trunk Release Button. See *Trunk on page 2-12*.
- P. Cruise Control. See “Cruise Control” under *Turn Signal/Multifunction Lever on page 3-9*.
- Q. Horn. See *Horn on page 3-7*.
- R. Heated Seat Controls. See *Heated Seats on page 1-3*.
- S. Traction Control System (TCS) Button. See *Traction Control System (TCS) on page 4-9*.
- T. Console Shift Lever. See *Automatic Transaxle Operation on page 2-28*.
- U. Optional Ashtray. See *Ashtrays and Cigarette Lighter on page 3-27*.
- V. Climate Controls. See *Dual Climate Control System on page 3-28*.
- W. Glove Box. See *Glove Box on page 2-48*.

Hazard Warning Flashers

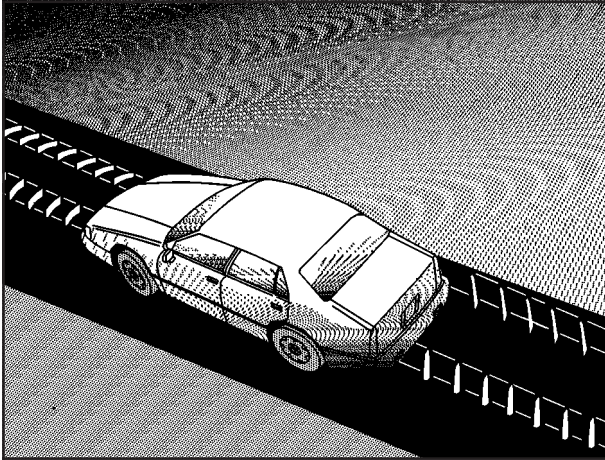

Your hazard warning flashers let you warn others. They also let police know you have a problem. Your front and rear turn signal lamps will flash on and off.



The hazard warning button is located on the center of the instrument panel between the two air vents.

Your hazard warning flashers work no matter what position the key is in, and even if the key isn't in.

Press the button to make the front and rear turn signal lamps flash on and off. Press the button again to turn the flashers off.

When the hazard warning flashers are on, the turn signals won't work.

Other Warning Devices

If you carry reflective triangles, you can set one up at the side of the road about 300 feet (100 m) behind your vehicle.

Horn

The horn can be sounded by pressing on the center of the steering wheel pad.

Tilt Wheel

A tilt wheel allows you to adjust the steering wheel before you drive. You can raise the steering wheel to the highest level to give your legs more room when you enter and exit the vehicle.

The lever that allows you to tilt the steering wheel is located on the left side of the steering column.

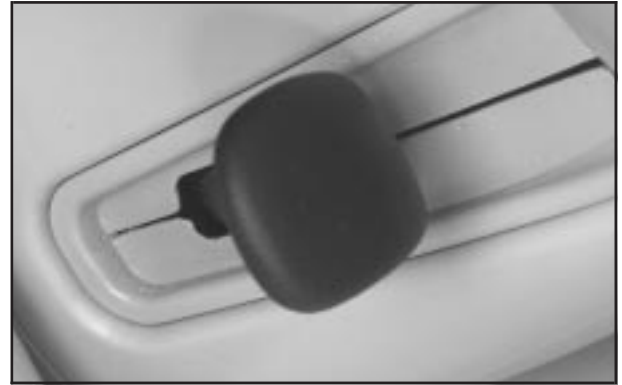

To tilt the wheel, hold the wheel and pull the lever. Then move the wheel to a comfortable position and release the lever to lock the wheel in place.

Power Tilt Wheel and Telescopic Steering Column



If your vehicle has this feature, the power tilt wheel control is located on the outboard side of the steering column.

To operate the power tilt feature, push the control up and the steering wheel will tilt up. Push the control down and the steering wheel will go down.

If the power tilt control is pressed up or down and held in that position, there will be a slight movement and a slight pause followed by a continuous movement in the direction the control is being pressed. This allows very fine control of the steering wheel position. If the control is bumped, the steering wheel moves approximately one degree in the direction commanded.

Push the control forward and the steering wheel moves toward the front of the vehicle. Push the control rearward and the steering wheel moves toward the rear of the vehicle. To set the memory position, see *DIC Vehicle Personalization on page 3-64* and *Memory Seat, Mirrors and Steering Wheel on page 2-51*.

Turn Signal/Multifunction Lever



The lever located on the left side of the steering column includes the following:

- Turn and Lane Change Signals
- Headlamp High/Low-Beam Changer
- Flash-To-Pass

For information on the exterior lamps, see *Exterior Lamps* on page 3-16.

Turn and Lane-Change Signals

To signal a turn, move the lever on the left side of the steering wheel all the way up or down. The lever returns automatically when the turn is complete.

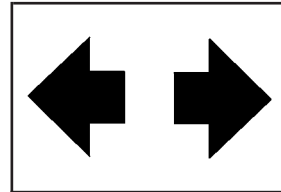

An arrow located on the instrument panel cluster will flash in the direction of the turn or lane change.

Raise or lower the lever until the arrow starts to flash to signal a lane change. Hold it there until the lane change is complete. The lever returns when it is released.

If the turn signal is left on, a warning chime will sound and the Driver Information Center (DIC) will display TURN SIGNAL ON after driving about a mile to remind you to turn it off.

Arrows that flash rapidly when signaling for a turn or lane change may be caused by a burned-out signal bulb. Other drivers won't see the turn signal.

Replace burned-out bulbs to help avoid possible accidents. Check the fuse and for burned-out bulbs if the arrow fails to work when signaling a turn. See *Fuses and Circuit Breakers* on page 5-93.

Headlamp High/Low-Beam Changer

When the low-beam headlamps are on, push the turn signal lever away from you to change the headlamps to high beam.

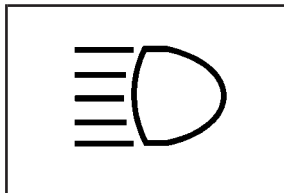

This light on the instrument panel cluster will be on, indicating high-beam usage.

Pull the turn signal lever toward you to return to low-beam headlamps.

Flash-To-Pass

This feature lets you use the high-beam headlamps to signal the driver in front of you that you want to pass.

Pull the turn signal lever toward you briefly to flash-to-pass. When you do, the following will occur:

- If the headlamps are either off or in the Daytime Running Lamps (DRL) mode, the high-beam headlamps will turn on. They'll stay on as long as you hold the lever there. Release the lever to turn them off.
- If the headlamps are on low beam, they will remain active and the high beam will also illuminate until you release the lever.

Windshield Wipers



You can control the windshield wipers by moving the lever with the wiper symbol on it. This lever is located on the right side of your steering column. For information on wiper-activated headlamp operation, refer to *Exterior Lamps* on page 3-16.

The following is a list of the available settings:

LO or HI: Move the lever up to LO for steady wiping at a slow speed. Move the lever higher to HI for steady wiping at a high speed.

INT (Delay): Move the lever up to the INT position, then turn the INT ADJ band, which is located on the lever, to adjust the delay time. The higher you turn the INT ADJ band, the more frequently the wipers will operate.

OFF: Lower the lever to its resting position (OFF) to turn off the wipers.

MIST: Pull the lever down once and release it for a single wipe cycle. For more cycles, hold the lever down in the MIST position longer.

To wash the windshield, press the button located at the tip of the lever.

Be sure to clear ice and snow from the wiper blades before using them. If they're frozen to the windshield, carefully loosen or thaw them. If the blades do become damaged, get new blades or blade inserts.

Heavy snow or ice can overload the wiper motor. A circuit breaker will stop the motor until it cools. Clear away snow or ice to prevent an overload.

Your vehicle is equipped with wiper-activated headlamps. After the windshield wipers have been on for approximately six seconds, the headlamps will automatically turn on. See *Wiper Activated Headlamps* under *Exterior Lamps on page 3-16* for more information.

Rainsense™ II Wipers

Your vehicle may be equipped with Rainsense™ II wipers. The moisture sensor for this feature is mounted on the interior side of the windshield below the rearview mirror and is used to automatically operate the wipers by monitoring the amount of moisture build-up on the windshield. Wipes occur as needed to clear the windshield depending on driving conditions and the sensitivity setting. In light rain or snow, fewer wipes will occur. In heavy rain or snow, wipes will occur more frequently. The Rainsense™ wipers operate in a delay mode as well as a continuous low or high speed as needed. If the system is left on for long periods of time, occasional wipes may occur without any moisture on the windshield. This is normal and indicates that the Rainsense™ system is activated.

The Rainsense™ system can be activated by moving the wiper stalk up to the INT position and turning the INT ADJ band to one of the five sensitivity levels. The bottom INT ADJ position is the lowest sensitivity setting, level one. This allows more rain or snow to collect on the windshield between wipes. Turning the INT ADJ band away from you to the higher sensitivity levels allows less rain or snow to collect on the windshield between wipes.

The top position is the highest sensitivity setting, level five. A single wipe will occur each time you turn the INT ADJ band to a higher sensitivity level to indicate that the sensitivity level has been increased.

Notice: The wipers must be turned off when going through a car wash to avoid damage.

The MIST and “wash” cycles operate as normal and are not affected by the Rainsense™ function. The Rainsense™ system can be overridden at any time by manually changing the wiper control to LO or HI speed.

While Rainsense™ is active, the headlamps will turn on automatically. The headlamps will turn off again once the wipers turn off if it is light enough outside. If it is dark, they will remain on. See “Wiper-Activated Headlamps” under *Exterior Lamps on page 3-16* for more information.

Notice: Do not place stickers or other items on the exterior glass surface directly in front of the moisture sensor. Doing this could cause the moisture sensor to malfunction.

Windshield Washer

The windshield washer has both a “demand” mode and a “programmed” mode, depending on the amount of windshield washer fluid you need.

CAUTION:

In freezing weather, do not use your washer until the windshield is warmed. Otherwise the washer fluid can form ice on the windshield, blocking your vision.

To spray washer fluid on the windshield in the programmed mode, press and release the button on the tip of the lever. The washer will provide a measured amount of fluid to the windshield and the wiper will either stop or return to your original wiping speed. To spray washer fluid on the windshield in the demand mode, press and hold the button until you have enough fluid, and the wipers will either stop or return to your original wiping speed.

CHECK WASHER FLUID will be displayed on the Driver Information Center (DIC) when the washer fluid reaches a low level.

Cruise Control

With cruise control, you can maintain a speed of about 25 mph (40 km/h) or more without keeping your foot on the accelerator. This is helpful on long trips. Cruise control does not work at speeds below about 25 mph (40 km/h). When cruise control is on, you will see a CRUISE light on the instrument panel cluster.

When you apply your brakes, the cruise control shuts off.

CAUTION:

- **Cruise control can be dangerous where you can not drive safely at a steady speed. So, do not use your cruise control on winding roads or in heavy traffic.**

CAUTION: (Continued)

CAUTION: (Continued)

- **Cruise control can be dangerous on slippery roads. On such roads, fast changes in tire traction can cause needless wheel spinning, and you could lose control. Do not use cruise control on slippery roads.**

If your vehicle is in cruise control when the traction control system begins to limit wheel spin, the cruise control will automatically disengage. See *Traction Control System (TCS)* on page 4-9. When road conditions allow you to safely use it again, you may turn the cruise control back on.

Setting Cruise Control

CAUTION:

If you leave your cruise control on when you are not using cruise, you might hit a button and go into cruise when you do not want to. You could be startled and even lose control. Keep the cruise control switch off until you want to use cruise control.



The buttons to operate cruise control are located on the steering wheel.

1. Press CRUISE ON/OFF, located on the bottom left of the steering wheel, to turn cruise control on. An indicator light will come on to show that the cruise control is on.
2. Get up to the speed you want.
3. Press SET/CST (coast) located on the bottom right of the steering wheel. The CRUISE light will display on the instrument panel cluster.
4. Remove your foot from the accelerator pedal.

Resuming a Set Speed

Suppose you set your cruise control at a desired speed and then you apply the brake. This shuts off the cruise control. But you don't need to reset it.

Once the vehicle is traveling approximately 25 mph (40 km/h) or more, you can press RES/ACC (resume/accelerate) to return to your desired preset speed. The CRUISE light will be displayed again.

The vehicle will return to and stay at your preset speed. If you press and hold RES/ACC, the vehicle speed will increase until you release the button or apply the brake. Unless you want to go faster, do not press and hold RES/ACC.

Increasing Speed While Using Cruise Control

There are two ways to go to a higher speed:

- Use the accelerator pedal to get to the higher speed. Press SET/CST, then release it and the accelerator pedal. You will now cruise at the higher speed.
- Press RES/ACC. Hold it there until you get up to the speed that you want, and then release it. To increase your speed in very small amounts, briefly press RES/ACC and then release it. Each time you do this, your vehicle will speed up approximately 1 mph (1.6 km/h) faster.

The accelerate feature will only work after you have set the cruise control speed by pressing SET/CST.

Reducing Speed While Using Cruise Control

There are two ways to reduce your speed while using cruise control:

- Press SET/CST until you reach the lower speed you want, then release it.
- To slow down in very small amounts, press SET/CST briefly. Each time you do this, the vehicle will slow down approximately 1 mph (1.6 km/h).

Passing Another Vehicle While Using Cruise Control

Use the accelerator pedal to increase your speed. When you take your foot off the pedal, your vehicle will slow down to the cruise control speed you set earlier.

Using Cruise Control on Hills

How well your cruise control will work on hills depends upon your speed, load and the steepness of the hills. When going up steep hills, you may have to step on the accelerator pedal to maintain your speed. When going downhill, you may have to brake or shift to a lower gear to keep your speed down. Applying the brake or shifting into a lower gear will take you out of cruise control. If you need to apply the brake or shift to a lower gear due to the grade of the downhill slope, you may not want to attempt to use your cruise control feature.

Ending Cruise Control

To turn off the cruise control, step lightly on the brake pedal or press CRUISE ON/OFF on the steering wheel.

Erasing Speed Memory

When you turn off the cruise control or the ignition, your cruise control set speed memory is erased.

Exterior Lamps



The control located on the left side of the instrument panel operates the exterior lamps.

 **(Exterior Lamp Control):** Turn the control with this symbol on it to operate the exterior lamps.

The exterior lamp control has three positions:

 **(Off):** Turn the control to this position to turn off all lamps except the Daytime Running Lamps (DRL).

 **(Parking Lamps):** Turn the control to this position to turn on the parking lamps together with the following:

- Sidemarkers Lamps
- Taillamps
- License Plate Lamps
- Instrument Panel Lights

The parking brake indicator light will come on and stay on while the parking lamps are on with the engine off and the ignition in ACC or ON.

 **(Headlamps):** Turn the control to this position to turn on the headlamps, together with the previously listed lamps and lights.

Your vehicle may be equipped with High Intensity Discharge (HID) headlamps. These headlamps come on at a lower intensity and gradually increase to full brightness.

Wiper-Activated Headlamps

This feature activates the headlamps and parking lamps after the windshield wipers have been in use for about six seconds. To operate, the Twilight Sentinel® feature must be turned on.

When the exterior lamp control is in the off or parking lamp position and the wiper control is on INT, LO or HI, the HEADLAMPS SUGGESTED message will appear on the Driver Information Center (DIC).

When the ignition is turned to OFF, the wiper-activated headlamps will immediately turn off. The wiper-activated headlamps will also turn off if the Twilight Sentinel® or the windshield wipers are turned off.

Lamps On Reminder

A warning chime will sound if the exterior lamp control is left on in either the headlamp or parking lamp position and the driver's door is opened with the ignition off.

Daytime Running Lamps

Daytime Running Lamps (DRL) can make it easier for others to see the front of your vehicle during the day. DRL can be helpful in many different driving conditions, but they can be especially helpful in the short periods after dawn and before sunset. Fully functional daytime running lamps are required on all vehicles first sold in Canada.

The DRL system will make the high-beam headlamps come on at reduced brightness when the following conditions are met:

- It is still daylight and the ignition is on,
- the exterior lamp control is in the off position and
- the transaxle is not in PARK (P).

When DRL are on, only your high-beam headlamps (at reduced brightness) will be on. No other exterior lamps such as the parking lamps, taillamps, etc. will be on when the DRL are being used. Your instrument panel won't be lit up either.

When the Twilight Sentinel® lever is on and it's dark enough outside, the high-beam headlamps (at reduced intensity) will turn off and normal low-beam headlamp operation will occur.

When the Twilight Sentinel[®] lever is on and it's bright enough outside, the regular lamps will go off, and the high-beam headlamps at reduced brightness will take over. If you start your vehicle in a dark garage, the automatic headlamp system will come on immediately. Once you leave the garage, it will take approximately one minute for the automatic headlamp system to change to DRL if it is light outside. During that delay, your instrument panel cluster may not be as bright as usual. Make sure your instrument panel brightness knob is in the full bright position. See "Instrument Panel Brightness" under *Interior Lamps on page 3-21*.

If it's dark enough outside and the Twilight Sentinel[®] lever is off, a HEADLAMPS SUGGESTED message will display on the Driver's Information Center (DIC). This message informs the driver that turning on the exterior lamps is recommended even though the DRL are still illuminated. Turning on the Twilight Sentinel[®] or the headlamps will deactivate the DRL and remove the HEADLAMPS SUGGESTED message. If the parking lamps or the fog lamps were turned on instead, the DRL will still deactivate and the HEADLAMPS SUGGESTED message will continue to be displayed.

To idle your vehicle with the DRL off at night, turn off the Twilight Sentinel[®] and shift the transaxle into PARK (P). Placing your vehicle in PARK (P) disables the DRL. The DRL will stay off until you shift out of PARK (P).

To drive your vehicle with the DRL off, turn off the Twilight Sentinel[®] and manually turn on the parking lamps or fog lamps.

As with any vehicle, you should turn on the regular headlamp system when you need it.

Fog Lamps

Use the fog lamps for better vision in foggy or misty conditions.

 (**Fog Lamps**): Press the button with this symbol on it, located next to the exterior lamp control, to turn the fog lamps on.

When the ignition is on and you press the fog lamp button, a small indicator light in the fog lamp button, the LIGHTS ON and fog lamp indicator lights on the instrument panel cluster will come on to indicate that the fog and the parking lamps are on.

Press the fog lamp button again to turn off the fog lamps.

If you turn on the high-beam headlamps, the fog lamps will turn off. They'll turn back on again when you switch to low-beam headlamps.

When the Twilight Sentinel[®] is on and the fog lamps are turned on, the fog lamps, headlamps and parking lamps will remain on.

The ignition must be on for the fog lamps to operate.

Cornering Lamps

The cornering lamps come on when the headlamps or parking lamps are on and you signal a turn with the multifunction lever. They provide more light for cornering.

Twilight Sentinel®



This lever is located below the exterior lamps control. It automatically turns the lamps on and off by sensing how dark it is outside.

To operate the Twilight Sentinel®, leave the exterior lamps control off and slide the TWILIGHT lever to any position but OFF.

If you move the lever all the way to the right, the lamps will remain on for approximately three minutes after the ignition has been turned to OFF. If you move the lever so it is barely on, the lamps will go off quickly when you turn the ignition switch out of OFF. You can adjust the delay time from only a few seconds to about three minutes.

If it's dark enough outside and the Twilight Sentinel® lever is off, a HEADLAMPS SUGGESTED message will display on the Driver Information Center (DIC). This message informs the driver that turning on the exterior lamps is recommended (it's become dark enough outside to require the headlamps and/or other exterior lamps). Turning on the Twilight Sentinel® or turning the exterior lamp control to the headlamp position will remove the HEADLAMPS SUGGESTED message.

Light Sensor

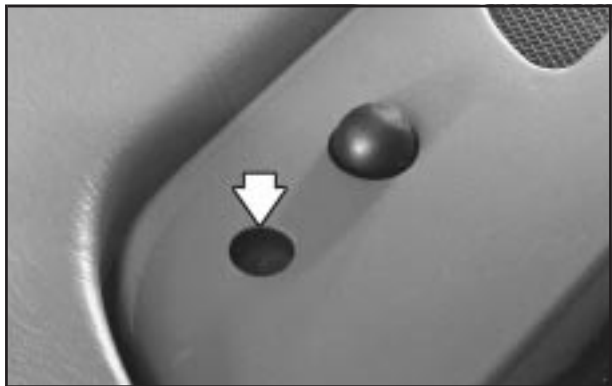

The light sensor for the Daytime Running Lamps (DRL) and the Twilight Sentinel[®] is located on the driver's side of the front defogger grille.

If you cover the sensor, it will read “dark” and the exterior lamps or the HEADLAMPS SUGGESTED message will be on whenever the ignition is on.

Exterior Lighting Battery Saver

If the manual parking lamps or headlamps have been left on, the exterior lamps will turn off approximately ten minutes after the ignition is turned to OFF. This protects against draining the battery in case you have accidentally left the headlamps or parking lamps on. The battery saver does not work if the headlamps are turned on after the ignition switch is turned to OFF.

If you need to leave the lamps on for more than 10 minutes, use the exterior lamp control to turn the lamps back on. To delay the lamps from turning off, see *Twilight Sentinel[®]* listed previously in this section.

Interior Lamps

Instrument Panel Brightness

This feature controls the brightness of the instrument panel lights.



The knob for this feature is located to the right of the Twilight Sentinel[®] lever.

Press the knob to release it to the outward position.

Turn the knob clockwise to brighten the lights and counterclockwise to dim them. Press the knob to return it to the original storage position.

Interior Lamps Control



The interior lamp lever, located in the overhead console, has three positions: OFF, AUTO and ON.

When the interior lamp lever is in OFF, the lamps are turned off. Only the driver's door controls and ignition switch backlighting functions will operate.

If the lever is in AUTO and a front door is opened, the overhead console light, front hush panel lamps and rear footwell lamps in the door will automatically come on. When the rear door is opened, all the front door lighting and rear overhead lamps will come on.

When the lever is in ON, the courtesy lamps are turned on. Also, all automatic interior lighting functions are terminated.

Entry Lighting

The entry lighting system automatically turns on the courtesy lamps and the backlighting to the door switches and to the exterior lamp control when a door is opened or if you press the remote keyless entry transmitter unlock button. If activated due to the transmitter, the lighting will remain active for about 40 seconds. Since the entry lighting system uses the light sensor, it must be dark outside in order for the courtesy lamps to turn on. The courtesy lamps turn off approximately 25 seconds after the last door is closed. They will dim to off if the ignition key is placed in ON, or immediately deactivate if the power locks are activated.

Parade Dimming

This feature prohibits dimming of the digital displays and backlighting during daylight hours when the key is in the ignition and the headlamps are on. This feature operates with the light sensor for the Twilight Sentinel[®] and is fully automatic. When the light sensor reads darkness outside and the parking lamps are active, the digital displays can be adjusted by turning the instrument panel brightness knob counterclockwise to dim and clockwise to brighten lighting.

Reading Lamps

The front reading lamps are located in the overhead console. These lamps and the interior courtesy lamps come on when a door is opened and it is dark outside. The rear reading lamps will not come on when a front door is opened.

The rear courtesy lamps are located on the rear headliner above the rear seat outboard positions. When a rear door is opened, both the front and rear reading lamps come on with the courtesy lamps.

Press the button near each lamp to turn it on and off.

If the reading lamps are left on, they automatically shut off 10 minutes after the ignition has been turned off.

Battery Load Management

The battery load management feature is designed to monitor the vehicle's electrical load and determine when the battery is in a heavy discharge condition. During times of high electrical loading, the engine may idle at a higher revolutions per minute (rpm) setting than normal to make sure the battery charges. High electrical loads may occur when several of the following are on: headlamps, high beams, fog lamps, rear window defogger, the climate control fan at high speeds, heated seats and engine cooling fans.

If the battery continues to discharge, even with the engine idling at a higher rpm setting, some electrical loads will automatically be reduced. When this occurs, the rear window defogger may take slightly longer to clear the glass, the heated seats may not get as warm as they usually do and the fan may cut back to a lower speed. For more battery saving information, see "Battery Saver Active Message" under *DIC Warnings and Messages on page 3-56*.

Inadvertent Power Battery Saver

This feature is designed to protect your vehicle's battery against drainage from the interior lamps, trunk lamp, glove box lamp, cigarette lighters or the garage door opener. When the ignition is turned off, the power to these features will automatically turn off after 10 minutes (three minutes if a new car has 15 miles (24 km) or less). Power will be restored for an additional 10 minutes if any door is opened, the trunk is opened or the courtesy lamp switch is turned on.

Ultrasonic Rear Parking Assist (URPA)

Ultrasonic Rear Parking Assist can help you to determine how close an object is to your rear bumper within a given area, making parking easier.

CAUTION:

Even with the Ultrasonic Rear Park Assist system, the driver must check carefully before backing up. The system does not operate above typical backing speeds of 3 mph (5 km/h) while parking. And, the system doesn't detect objects that are more than 5 feet (1.5 meters) behind the vehicle.

So, unless you check carefully behind you before and when you back up, you could strike children, pedestrians, bicyclists or pets behind you, and they could be injured or killed.

CAUTION: (Continued)

CAUTION: (Continued)

Whether or not you are using Rear Park Assist, always check carefully behind your vehicle before you back up and then watch closely as you do.

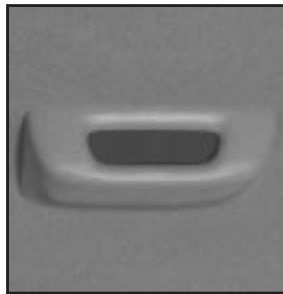

The URPA display is located inside the vehicle, above the rear window. It has three color-coded lights that can be seen through the rearview mirror or by turning around.

How the System Works

URPA comes on automatically when the shift lever is moved into REVERSE (R) and the vehicle speed is less than 3 mph (5 km/h). When the system comes on, the three lights on the display will illuminate to let you know that the system is working. URPA senses how close your vehicle is to an object. The distance is determined by the four ultrasonic sensors located on the rear bumper. When you shift into REVERSE (R) and an object is detected, the following will occur in sequence depending on the distance from the object:

- At 5 feet (1.5 m) a chime will sound and one amber light will be lit;
- at 40 inches (1.0 m) both amber lights will be lit;
- at 20 inches (0.5 m) a continuous chime will sound and all three lights (amber/amber/red) will be lit; and
- at 1 foot (0.3 m) a continuous chime will sound and all three lights (amber/amber/red) will flash.

URPA can detect objects 3 inches (7.6 cm) and wider, and at least 10 inches (25.4 cm) tall, but it cannot detect objects that are above trunk level. In order for the rear sensors to recognize an object, it must be within operating range.

If the URPA system is not functioning properly, the display will flash red, indicating that there is a problem. The light will also flash red while driving if a trailer is attached to your vehicle, or a bicycle or object is on the back of, or hanging out of your trunk. The light will continue to flash until the trailer or the object is removed and your vehicle is driven forward at least 15 mph (25 km/h).

It may also flash red if the ultrasonic sensors are not kept clean. So be sure to keep your rear bumper free of mud, dirt, snow, ice and slush or materials such as paint or the system may not work properly. If after cleaning the rear bumper and driving forward at least 15 mph (25 km/h), the display continues to flash red, see your dealer. For cleaning instructions, see *Cleaning the Outside of Your Vehicle on page 5-86*.

It may also flash red if your vehicle is moving in REVERSE (R) at a speed greater than 3 mph (5 km/h). Other conditions that may affect system performance include things like the vibrations from a jackhammer or the compression of air brakes on a very large truck.

As always, drivers should use care when backing up a vehicle. Always look behind you, being sure to check for other vehicles, obstructions and blind spots.

Accessory Power Outlets

Your vehicle is equipped with accessory power outlets. The outlets can be used to plug in electrical equipment such as a cellular telephone, CB radio, etc.

The accessory power outlets are located at the rear of the center console and on the lower inboard carpeted panel on the passenger's side of the vehicle.

Your vehicle may have a small cap that must be removed to access the accessory power outlet. If it does, when not using the outlet be sure to cover it with the protective cap.

The accessory power outlet will only operate when the ignition is in ACC or ON and for 10 minutes after turning the ignition OFF. If you would like the accessory power outlet to operate regardless of ignition position, and for extended periods of time, see your dealer for more information.

Notice: When using an accessory power outlet, maximum electrical load must not exceed amperage rating. Always turn off any electrical equipment when not in use. Leaving electrical equipment on for extended periods will drain your battery.

Certain accessory power plugs may not be compatible to the accessory power outlet and could result in blown vehicle or adapter fuses. If you experience a problem see your dealer for additional information on the accessory power plugs.

Notice: Adding some electrical equipment to your vehicle can damage it or keep other things from working as they should. This wouldn't be covered by your warranty. Check with your dealer before adding electrical equipment, and never use anything that exceeds the amperage rating.

Follow the proper installation instructions that are included with any electrical equipment you install.

Notice: Power outlets are designed for accessory plugs only. Do not hang any type of accessory or accessory bracket from the plug. Improper use of the power outlet can cause damage not covered by your warranty.

Ashtrays and Cigarette Lighter

The ashtrays and cigarette lighters may be ordered through your dealer.

Notice: Don't put papers or other flammable items into your ashtrays. Hot cigarettes or other smoking materials could ignite them, causing a damaging fire.

Front Ashtray

The front ashtray is located below the climate control system on the instrument panel.

Press on the lower edge of the cover to access the ashtray. To clean the ashtray, lift it out by pulling on the snuffer.

Rear Ashtray

The ashtrays are located on the door armrests. To use an ashtray, lift the lid.

Cigarette Lighter

Notice: Don't hold a cigarette lighter in with your hand while it is heating. If you do, it won't be able to back away from the heating element when it's ready. That can make it overheat, damaging the lighter and the heating element.

The front cigarette lighter is located on the center console in the passenger's side footwell. Open the flip out door to access the cigarette lighter. Your vehicle may also have a lighter on the back of the center console near the rear seat air outlet.

Press the lighter all the way in and release it. It will pop back out by itself once the element has heated for use.

Cigarette lighters can be used to provide electrical power to accessories. See *Accessory Power Outlets on page 3-26* for more information.

Climate Controls

Dual Climate Control System

With this system you can control the heating, cooling and ventilation for your vehicle.



Automatic Operation

AUTO (Automatic): When this button is pressed and the temperature is set, the system will automatically control the inside temperature, the air delivery mode and the fan speed. AUTO will appear on the display.

1. Press the AUTO button.
2. Adjust the temperature to a comfortable setting between 70°F (21°C) and 80°F (27°C).

Choosing the coldest or warmest temperature setting will not cause the system to heat or cool any faster. If you set the system at the warmest temperature setting, the system will remain in manual mode at that temperature and it will not go into automatic mode.

In cold weather, the system will start at reduced fan speeds to avoid blowing cold air into your vehicle until warmer air is available. The system will start out blowing air at the floor but may change modes automatically as the vehicle warms up to maintain the chosen temperature setting. The length of time needed for warm up will depend on the outside temperature and the length of time that has elapsed since your vehicle was last driven.

3. Wait for the system to regulate. This may take from 10 to 30 minutes. Then adjust the temperature, if necessary.

Do not cover the solar sensor located in the center of the instrument panel, near the windshield. For more information on the solar sensor, see "Sensors" later in this section.

When your vehicle is first started, the display will show the driver's temperature setting, the fan speed and the air delivery mode.

When the ENG/MET (English/metric) button on the Driver Information Center (DIC) is pressed, the display will show readings in Fahrenheit or Celsius. Use the ENG/MET button to toggle between them.

Manual Operation

< MODE > : Pressing the MODE switch and changing the mode cancels automatic operation and places the system in manual mode. Press AUTO to return to automatic operation.

To change the current mode, select one of the following:

 **(Vent)**: This mode directs air to the instrument panel outlets.

 **(Bi-Level)**: This mode directs approximately half of the air to the instrument panel outlets, and then directs most of the remaining air to the floor outlets. Some air may be directed toward the windshield. In automatic operation, cooler air is directed to the upper outlets and warmer air to the floor outlets.

 **(Floor)**: This mode directs most of the air to the floor outlets with some air directed to the outboard outlets (for the side windows) a little air directed to the windshield.

The MODE switch can also be used to select the floor/defog mode. Information on defogging and defrosting can be found later in this section.

 **(Fan)**: Press this switch to increase or decrease the fan speed. Pressing this switch cancels automatic operation and places the system in manual mode. Press AUTO to return to automatic operation.

If the airflow seems low when the fan speed is at the highest setting, the passenger compartment air filter may need to be replaced. For more information, see *Passenger Compartment Air Filter on page 3-35* and *Part A: Scheduled Maintenance Services on page 6-4*.

 **(Recirculation)**: This mode keeps outside air from coming in the vehicle. It can be used to prevent outside air and odors from entering your vehicle or to help heat or cool the air inside your vehicle more quickly. Press this button to turn the recirculation mode on or off. When the button is pressed, an indicator light will come on. The air-conditioning compressor also comes on.

TEMP (Driver's Temperature Knob): Press this knob to turn the climate control system on or off. Turn this knob clockwise or counterclockwise to manually increase or decrease the temperature inside your vehicle.

TEMP (Passenger's Temperature Knob): Press this knob to turn the passengers' climate control system controls on or off. Turn this knob to manually increase or decrease the temperature for the front passenger.

If the passenger's climate controls are turned off, the driver's temperature knob will control the temperature for the entire vehicle.

A/C (Air Conditioning): Press this button to override the automatic system and turn the air-conditioning system on or off. When in AUTO the air-conditioning compressor will come on automatically, as necessary.

On hot days, open the windows to let hot inside air escape; then close them. This helps to reduce the time it takes for your vehicle to cool down. It also helps the system to operate more efficiently.

For quick cool down on hot days:

1. Select the vent mode.
2. Select the recirculation mode.
3. Select A/C.
4. Select the coolest temperature.
5. Select the highest fan speed.
6. Open all outlets.

Using these settings together for long periods of time may cause the air inside your vehicle to become too dry. To prevent this from happening, after the air in your vehicle has cooled, turn the recirculation mode off.

The air-conditioning system removes moisture from the air, so you may sometimes notice a small amount of water dripping underneath your vehicle while idling or after turning off the engine. This is normal.

If your vehicle has the memory option, it can be used to recall your climate control settings. For more information, see *Climate Controls Personalization on page 3-36*.

Sensors

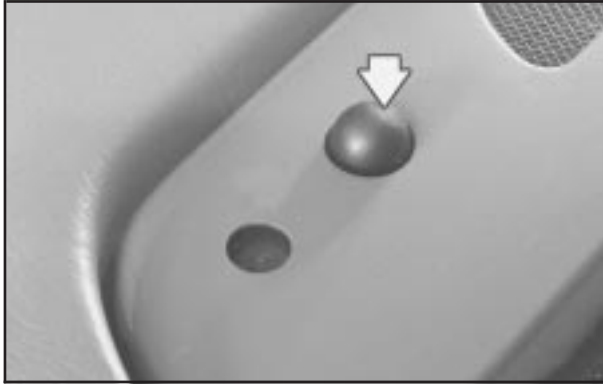

The solar sensor on your vehicle monitors the solar radiation inside your vehicle, then uses the information to maintain the selected temperature by initiating needed adjustments to the temperature, the fan speed and the air delivery system. The system may also supply cooler air to the side of the vehicle facing the sun. The recirculation mode will also be activated, as necessary. Do not cover the solar sensor located in the middle of the instrument panel, near the windshield or the system will not work properly.

There is also an outside temperature sensor located under the front bumper and an inside temperature sensor located to the left of the ignition switch. These sensors read the outside and inside air temperature and help to maintain the selected temperature inside the vehicle. If you cover these sensors, it could cause a false reading in the temperature.

Defogging and Defrosting

Fog on the inside of windows is a result of high humidity (moisture) condensing on the cool window glass. This can be minimized if the climate control system is used properly. There are two modes to clear fog from your windshield. Use the floor/defog mode to clear the windows of fog or moisture and warm the passengers. Use the defrost mode (FRONT) to remove fog or frost from the windshield more quickly.

< MODE > : Press this switch until floor/defog appears on the display.

 **(Floor/Defog):** This mode directs the air equally between the windshield and the floor outlets. When you select this mode, the system turns off recirculation and runs the air-conditioning compressor unless the outside temperature is at or below freezing. The recirculation mode cannot be selected while in the floor/defog mode.

 **FRONT (Defrost):** Pressing FRONT directs most of the air to the windshield and the side window outlets, with some air directed to the floor outlets. In this mode, the system will automatically turn off recirculation and run the air-conditioning compressor, unless the outside temperature is at or below freezing. Recirculation cannot be selected while in the defrost mode. Do not drive the vehicle until all the windows are clear.

Rear Window Defogger

The rear window defogger uses a warming grid to remove fog or frost from the rear window.

The rear window defogger will only work when the ignition is in ON.

 **REAR:** Press this button to turn the rear window defogger on or off. Be sure to clear as much snow from the rear window as possible.

The rear window defogger will turn off approximately 10 minutes after the button is pressed. If turned on again, the defogger will only run for approximately five minutes before turning off. The defogger can also be turned off by pressing the button again or by turning off the engine.

The heated outside rearview mirrors will heat to help clear fog or frost from the surface of the mirror when the REAR button is pressed.

Notice: Don't use a razor blade or something else sharp on the inside of the rear window. If you do, you could cut or damage the defogger and the repairs would not be covered by your warranty. Do not attach a temporary vehicle license, tape, a decal or anything similar to the defogger grid.

Outlet Adjustment

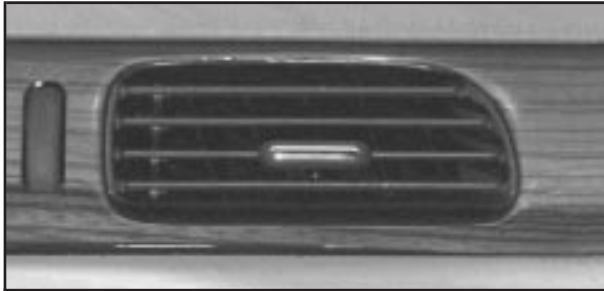

Use the levers located in the center of each outlet to change the direction of the airflow. Use the thumbwheels to open or close the outlets.

Operation Tips

- Clear away any ice, snow or leaves from the air inlets at the base of the windshield that may block the flow of air into your vehicle.
- Use of non-GM approved hood deflectors may adversely affect the performance of the system.
- Keep the path under the front seats clear of objects to help circulate the air inside of your vehicle more effectively.
- If the airflow seems low when the fan speed is at the highest setting, the passenger compartment air filter may need to be replaced. For more information, see *Passenger Compartment Air Filter on page 3-35* and *Part A: Scheduled Maintenance Services on page 6-4*.

Rear Climate Control System

Your vehicle has a rear climate-control system that allows the rear-seat passengers to adjust the direction of the airflow and the fan speed for the rear seating area. This system also works with the main climate-control system in your vehicle.

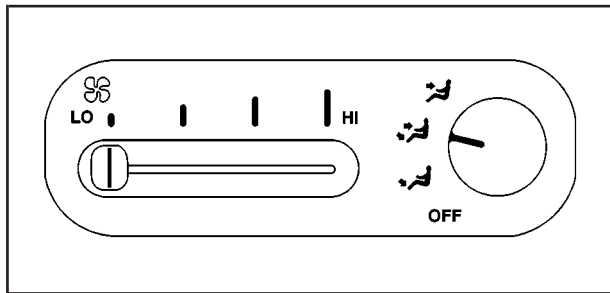

Rear Climate Control Panel

The control panel for this system is located on the back of the center console.

OFF: Turn the mode knob located on the rear climate control panel to this position to turn off the airflow.

If the passenger's temperature knob located on the main climate control panel is off, the rear climate control system will be turned off and the settings selected for the main climate control panel will also be selected for the rear seat passengers.

For more information on how to use the climate control system, see *Dual Climate Control System on page 3-28*. For more information on the air outlets, see *Outlet Adjustment on page 3-33*.

Operation

Mode Knob: Turn the knob to direct the airflow in the rear-seating area.

To change the current mode, select one of the following:

Vent: This mode directs air to the upper outlets, with some air directed to the floor outlets.

Bi-Level: This mode directs half the air to the upper outlets, and then directs the remaining air to the floor outlets.

Floor: This mode directs the air to the floor outlets.

Fan: Slide this lever to the left or right, between LO and HI, to decrease or increase the fan speed.

Be sure to keep the area under the front seats clear of any objects so that the air inside of your vehicle can circulate effectively.

Passenger Compartment Air Filter

Passenger compartment air, both outside air and recirculated air, is routed through a passenger compartment filter. The filter removes certain contaminants from the air, including pollen and dust particles.



The filter is located inside the air control module, with an access panel under the instrument panel near the accelerator pedal.

Reductions in airflow, which may occur more quickly in dusty areas, indicate that the filter needs to be replaced. The filter also should be replaced as part of routine scheduled maintenance. See *Part A: Scheduled*

Maintenance Services on page 6-4 for replacement intervals. See your dealer for assistance when changing the filter.

Your vehicle will not be damaged if you choose not to replace the filter once the old one is removed.

Steering Wheel Climate Controls

You can adjust the temperature using the steering wheel controls.



The control for the temperature is located on the left side of the steering wheel.

^ TEMP v (Temperature): Press the up or down arrow on this control to increase or decrease the temperature.

Climate Controls Personalization

If your vehicle is equipped with this feature, you can store and recall climate control settings for the temperature, the fan speed and the direction of the airflow.

Memory buttons 1 and 2 are located on the driver's door panel and correspond to the numbers 1 or 2 found on the back of each remote keyless entry transmitter.

To recall the climate control settings last stored on your transmitter, press the unlock button on your remote keyless entry transmitter and put the ignition in ACC or ON. The settings will be recalled.

To change the stored settings, do the following:

1. Select the desired temperature, fan speed and airflow mode. If desired, a separate temperature setting may also be selected for the front seat passenger. For information on how to do this, see *Dual Climate Control System on page 3-28*.

2. Locate memory buttons 1 and 2 on the driver's door panel.
3. Press the memory button on the door panel that corresponds to the number on the back of the transmitter you are programming, until you hear two beeps. The beeps confirm that your selection has been saved and can now be recalled. For more information on the memory feature, see *Memory Seat, Mirrors and Steering Wheel on page 2-51*.

Follow these steps each time you want to change the stored settings.

Warning Lights, Gages and Indicators

This part describes the warning lights and gages that may be on your vehicle. The pictures will help you locate them.

Warning lights and gages can signal that something is wrong before it becomes serious enough to cause an expensive repair or replacement. Paying attention to your warning lights and gages could also save you or others from injury.

Warning lights come on when there may be or is a problem with one of your vehicle's functions. As you will see in the details on the next few pages, some warning lights come on briefly when you start the engine just to let you know they're working. If you are familiar with this section, you should not be alarmed when this happens.

Gages can indicate when there may be or is a problem with one of your vehicle's functions. Often gages and warning lights work together to let you know when there's a problem with your vehicle.

When one of the warning lights comes on and stays on when you are driving, or when one of the gages shows there may be a problem, check the section that tells you what to do about it. Follow this manual's advice. Waiting to do repairs can be costly – and even dangerous. So please get to know your warning lights and gages. They're a big help.

Your vehicle also has a Driver Information Center (DIC) that works along with the warning lights and gages. See *Driver Information Center (DIC) on page 3-53* for more information.

Instrument Panel Cluster

The instrument panel cluster is designed to let you know at a glance how your vehicle is running. You'll know how fast you're going, how much fuel you're using and many of the other things you'll need to know to drive safely and economically.

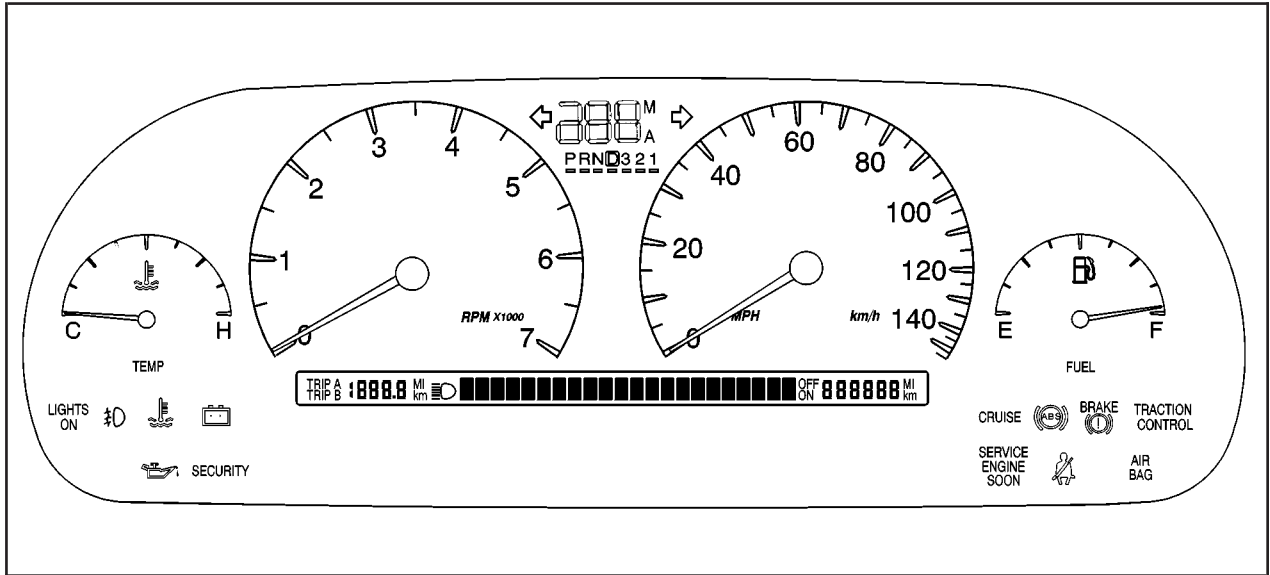

United States version shown, Canada similar

Speedometer and Odometer

The speedometer lets you see your speed in both miles per hour (mph) and kilometers per hour (km/h). The odometer shows how far your vehicle has been driven, in either miles (used in the United States) or kilometers (used in Canada).

You may wonder what happens if a vehicle has to have a new odometer installed. The new one may read the correct mileage. This is because your vehicle's computer has stored the mileage in memory.

Trip Odometers

The trip odometer can record the number of miles or kilometers traveled for up to two trips.



The trip odometer button is located to the left of the steering wheel on the instrument panel.

The two trip modes are indicated by Trip A and Trip B. In order to change from one mode to the other, press the A/B portion of the TRIP button.

By pressing the bottom of this button, you can tell how many miles have been recorded on either Trip A or Trip B since you last set the odometer back to zero.

Press the RESET part of the button until zeros appear to reset each trip mode.

If your vehicle is first sold in the United States, the trip odometer will return to zero after 999.9 miles (1 609 km). If your vehicle is first sold in Canada, the trip odometer will return to zero after 1 999.9 km (1,242 miles). The RESET TRIP A/B button only resets the trip mode (A or B) that is being displayed. Each trip mode must be reset individually.

Display Mode



This button is located between the RESET TRIP A/B button and the ENG/MET button to the left of the steering wheel on the instrument panel.

Press DSPL MODE to turn the backlighting and the digital speed image on and off.

English Metric Display



located to the left of the steering wheel on the instrument panel, you can go back and forth from English (miles) to metric (kilometers).

Other readings such as temperature, fuel and trip odometer also go back and forth between English and metric.

Vehicle Speed Limiter

This feature prevents your vehicle from exceeding speeds that the tires are not rated for. When this happens, the engine's fuel supply is shut off. When the vehicle speed slows, the fuel supply will come on again.

Tachometer

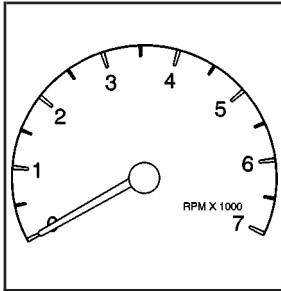

This gage indicates the engine speed in revolutions per minute (rpm).

Notice: Do not operate the engine with the tachometer in the shaded warning area, or engine damage may occur.

Engine Speed Limiter

This feature prevents the engine from operating at too many revolutions per minute (rpm). When the engine's rpm are critically high, the fuel supply to the engine is shut off. When the engine speed slows, the fuel supply will come on again. This helps prevent damage to the engine.

Safety Belt Reminder Light

When the key is turned to ON or START, a chime will come on for several seconds to remind people to fasten their safety belts.



The safety belt light will also come on and stay on for several seconds. If the driver's belt is already buckled, the light will come on briefly, but the chime will not sound.

Air Bag Readiness Light

There is an air bag readiness light on the instrument panel, which shows AIR BAG or the air bag symbol. The system checks the air bag's electrical system for malfunctions. The light tells you if there is an electrical problem. The system check includes the air bag sensors, the air bag modules, the wiring and the crash sensing and diagnostic module. For more information on the air bag system, see *Supplemental Inflatable Restraint (SIR)* on page 1-44.



United States

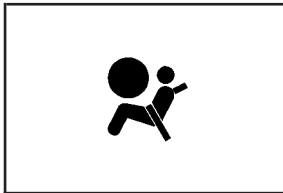

Canada

This light will come on when you start your vehicle, and it will flash for a few seconds. Then the light should go out. This means the system is ready.

If the air bag readiness light stays on after you start the vehicle or comes on when you are driving, your air bag system may not work properly. Have your vehicle serviced right away.

CAUTION:

If the air bag readiness light stays on after you start your vehicle, it means the air bag system may not be working properly. The air bags in your vehicle may not inflate in a crash, or they could even inflate without a crash. To help avoid injury to yourself or others, have your vehicle serviced right away if the air bag readiness light stays on after you start your vehicle.

The air bag readiness light should flash for a few seconds when you turn the ignition key to ON. If the light doesn't come on then, have it fixed so it will be ready to warn you if there is a problem.

Charging System Light

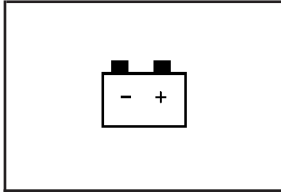

When you turn the key to ON or START, this light will come on briefly to show that the generator and battery charging systems are working properly.

If this light stays on, you need service and you should take your vehicle to the dealer at once. To save your battery until you get there, turn off all accessories.

Brake System Warning and Parking Brake Indicator Light

Your vehicle's hydraulic brake system is divided into two parts. If one part isn't working, the other part can still work and stop you. For good braking, though, you need both parts working well.

If the warning light comes on, there is a brake problem. Have your brake system inspected right away.

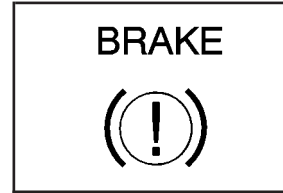

This light should come on briefly when you turn the ignition key to ON. If it doesn't come on then, have it fixed so it will be ready to warn you if there's a problem.

When the ignition is on, the brake system warning light will also come on when you set your parking brake. The light will stay on if your parking brake doesn't fully release. If it stays on after your parking brake is fully released, it means you have a brake problem.

CAUTION:

Your brake system may not be working properly if the brake system warning light is on. Driving with the brake system warning light on can lead to an accident. If the light is still on after you have pulled off the road and stopped carefully, have the vehicle towed for service.

If the light comes on while you are driving, pull off the road and stop carefully. You may notice that the pedal is harder to push. Or, the pedal may go closer to the floor. It may take longer to stop. If the light is still on, have the vehicle towed for service. See *Towing Your Vehicle* on page 4-31.

Anti-Lock Brake System Warning Light

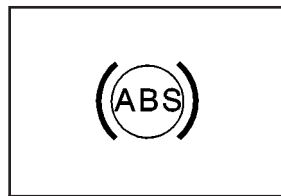

With the anti-lock brake system, the light(s) will come on when your engine is started and may stay on for several seconds. That's normal.

If the light stays on, turn the ignition to OFF. Or, if the light comes on when you're driving, stop as soon as possible and turn the ignition off. Then start the engine again to reset the system. If the light still stays on, or comes on again while you're driving, your vehicle needs service. If the regular brake system warning light isn't on, you still have brakes, but you don't have anti-lock brakes. If the regular brake system warning light is also on, you don't have anti-lock brakes and there's a problem with your regular brakes. See *Brake System Warning and Parking Brake Indicator Light* on page 3-43.

The anti-lock brake system warning light should come on briefly when you turn the ignition key to ON. If the light doesn't come on then, have it fixed so it will be ready to warn you if there is a problem.

Traction Control System (TCS) Warning Light



United States

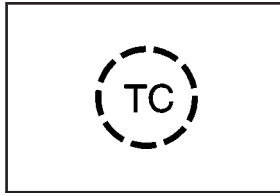

Canada

This warning light should come on briefly when the engine is started.

If the warning light doesn't come on then, have it fixed so it will be ready to warn you if there's a problem. If it stays on, or comes on when you're driving, there may be a problem with your traction control system and your vehicle may need service. When this warning light is on, the system will not limit wheel spin. Adjust your driving accordingly.

The traction control system warning light may come on for the following reasons:

- If there's a brake system problem that is specifically related to traction control, the traction control system will turn off and the warning light will come on.
- If the traction control system is affected by an engine-related problem, the system will turn off and the warning light will come on.

If the traction control system warning light comes on and stays on for an extended period of time when the system is turned on, your vehicle needs service.

Engine Coolant Temperature Warning Light

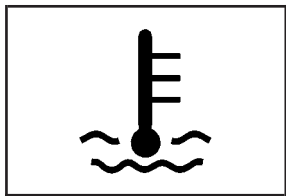

This light tells you that your engine has overheated. As a check, the light should come on for a few seconds when you start your engine.

If this light comes on and stays on, you should stop your vehicle and turn the engine off as soon as possible. A warning chime should also sound if this light comes on.

See *Engine Overheating* on page 5-28.

Engine Coolant Temperature Gage

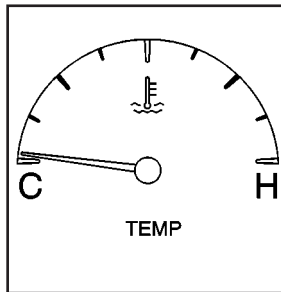

United States

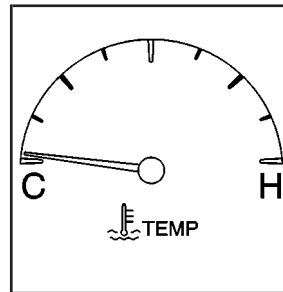

Canada

This gage shows the engine coolant temperature. If the gage pointer moves into the shaded area, the engine is too hot.

That reading means the same thing as the warning light – the engine coolant has overheated. See *Engine Overheating* on page 5-28.

Malfunction Indicator Lamp

Service Engine Soon Light in the United States or Check Engine Light in Canada

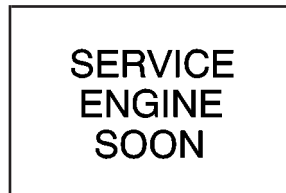

United States

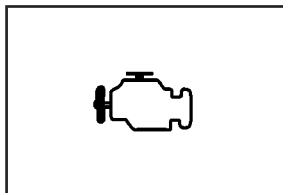

Canada

Your vehicle is equipped with a computer which monitors operation of the fuel, ignition and emission control systems.

This system is called OBD II (On-Board Diagnostics-Second Generation) and is intended to assure that emissions are at acceptable levels for the life of the vehicle, helping to produce a cleaner environment.

The SERVICE ENGINE SOON or CHECK ENGINE light comes on to indicate that there is a problem and service is required. Malfunctions often will be indicated by the system before any problem is apparent. This may prevent more serious damage to your vehicle. This system is also designed to assist your service technician in correctly diagnosing any malfunction.

Notice: If you keep driving your vehicle with this light on, after a while, your emission controls may not work as well, your fuel economy may not be as good and your engine may not run as smoothly. This could lead to costly repairs that may not be covered by your warranty.

Notice: Modifications made to the engine, transaxle, exhaust, intake or fuel system of your vehicle or the replacement of the original tires with other than those of the same Tire Performance Criteria (TPC) can affect your vehicle's emission controls and may cause this light to come on. Modifications to these systems could lead to costly repairs not covered by your warranty. This may also result in a failure to pass a required Emission Inspection/Maintenance test.

This light should come on, as a check to show you it is working, when the ignition is on and the engine is not running. If the light does not come on, have it repaired. This light will also come on during a malfunction in one of two ways:

- **Light Flashing** — A misfire condition has been detected. A misfire increases vehicle emissions and may damage the emission control system on your vehicle. Diagnosis and service may be required.
- **Light On Steady** — An emission control system malfunction has been detected on your vehicle. Diagnosis and service may be required.

If the Light Is Flashing

The following may prevent more serious damage to your vehicle:

- Reducing vehicle speed.
- Avoiding hard accelerations.
- Avoiding steep uphill grades.
- If you are towing a trailer, reduce the amount of cargo being hauled as soon as it is possible.

If the light stops flashing and remains on steady, see “If the Light Is On Steady” following.

If the light continues to flash, when it is safe to do so, *stop the vehicle*. Find a safe place to park your vehicle. Turn the key off, wait at least 10 seconds and restart the engine. If the light remains on steady, see “If the Light Is On Steady” following. If the light is still flashing, follow the previous steps, and see your dealer for service as soon as possible.

If the Light Is On Steady

You may be able to correct the emission system malfunction by considering the following:

Did you recently put fuel into your vehicle?

If so, reinstall the fuel cap, making sure to fully install the cap. See *Filling Your Tank on page 5-6*. The diagnostic system can determine if the fuel cap has been left off or improperly installed. A loose or missing fuel cap will allow fuel to evaporate into the atmosphere. A few driving trips with the cap properly installed should turn the light off.

Did you just drive through a deep puddle of water?

If so, your electrical system may be wet. The condition will usually be corrected when the electrical system dries out. A few driving trips should turn the light off.

Have you recently changed brands of fuel?

If so, be sure to fuel your vehicle with quality fuel. See *Gasoline Octane on page 5-4*. Poor fuel quality will cause your engine not to run as efficiently as designed. You may notice this as stalling after start-up, stalling when you put the vehicle into gear, misfiring, hesitation on acceleration or stumbling on acceleration. (These conditions may go away once the engine is warmed up.) This will be detected by the system and cause the light to turn on.

If you experience one or more of these conditions, change the fuel brand you use. It will require at least one full tank of the proper fuel to turn the light off.

If none of the above steps have made the light turn off, your dealer can check the vehicle. Your dealer has the proper test equipment and diagnostic tools to fix any mechanical or electrical problems that may have developed.

Emissions Inspection and Maintenance Programs

Some state/provincial and local governments have or may begin programs to inspect the emission control equipment on your vehicle. Failure to pass this inspection could prevent you from getting a vehicle registration.

Here are some things you need to know in order to help your vehicle pass an inspection:

Your vehicle will not pass this inspection if the SERVICE ENGINE SOON or CHECK ENGINE light is on or not working properly.

Your vehicle will not pass this inspection if the OBD (on-board diagnostic) system determines that critical emission control systems have not been completely diagnosed by the system. The vehicle would be considered not ready for inspection. This can happen if you have recently replaced your battery or if your battery has run down. The diagnostic system is designed to evaluate critical emission control systems during normal driving. This may take several days of routine driving. If you have done this and your vehicle still does not pass the inspection for lack of OBD system readiness, your GM dealer can prepare the vehicle for inspection.

Oil Pressure Light

CAUTION:

Do not keep driving if the oil pressure is low. If you do, your engine can become so hot that it catches fire. You or others could be burned. Check your oil as soon as possible and have your vehicle serviced.

Notice: Damage to your engine from neglected oil problems can be costly and is not covered by your warranty.

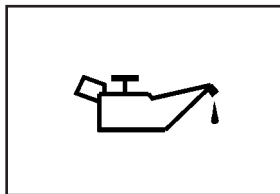

This light tells you if there could be a problem with your engine oil pressure.

The light goes on when you turn your key to ON or START. It goes off once you start your engine. That's a check to be sure the light works. If it doesn't come on, be sure to have it fixed so it will be there to warn you if something goes wrong.

When the light comes on and stays on, it means that oil isn't flowing through your engine properly. You could be low on oil and you might have some other system problem.

Security Light

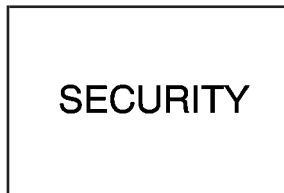

For information regarding this light, see *Theft-Deterrent Systems* on page 2-19.

Fog Lamp Light

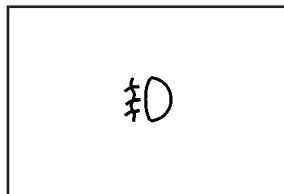

This light will come on when the fog lamps are in use. It will go out when the fog lamps are turned off.

For more information about the fog lamps, see “Fog Lamps” under *Exterior Lamps* on page 3-16.

Lights On Reminder

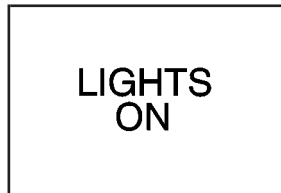

United States

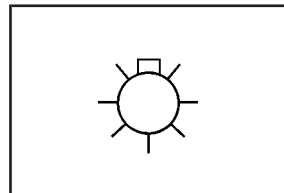

Canada

This light comes on whenever the parking lamps are on so that you know that your exterior lamps are on.

Cruise Control Light



This light comes on whenever the cruise control system is in use. It will go out when the system is turned off.

See “Cruise Control” under *Turn Signal/Multifunction Lever* on page 3-9 for more information.

Fuel Gage

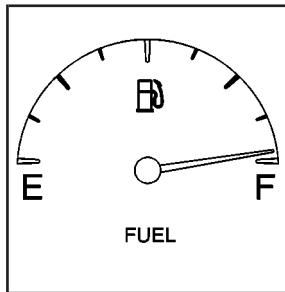

United States

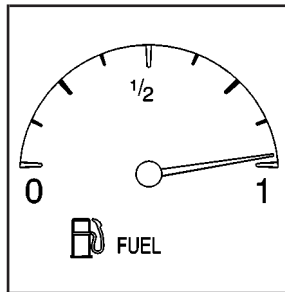

Canada

The fuel gage shows approximately how much fuel is in the tank. It works only when the ignition is in ON.

If the fuel supply gets down to approximately three gallons (11.4 L) of fuel remaining in the tank, the FUEL LEVEL LOW message will appear on the Driver Information Center (DIC) and a single chime will sound.

Here are a few concerns some owners have had about the fuel gage. All of these situations are normal and do not indicate that anything is wrong with the fuel gage:

- At the gas station the gas pump shuts off before the gage reads full.
- GAL FUEL USED on the DIC does not correspond exactly to the amount of fuel remaining as shown on the fuel gage.
- The gage may change when you turn, stop quickly or accelerate quickly.

Driver Information Center (DIC)

This display gives you the status of many of your vehicle's systems. The DIC is also used to display driver personalization features and warning/status messages. All messages will appear in the DIC display, located at the bottom of the instrument panel cluster.

DIC Controls and Displays



The Driver Information Center (DIC) buttons are located to the right of the steering wheel on the instrument panel, near the air outlets.

^ **INFO** v (**Information**): Pressing this button up or down will display the OUTSIDE TEMP, MILES RANGE, MPG AVG, MPG INST, GAL FUEL USED, AVG MPH, TIMER, BATTERY VOLTS, LF-RF-LR-RR TIRE (If Equipped), ENGINE OIL LIFE, TRANS FLUID LIFE, PHONE (Option) and FEATURE PROGRAMMING and Blank Display.

INFO (Information) RESET: Pressing this button will reset the MPG AVG, GAL FUEL USED, AVG MPH, TIMER, ENGINE OIL LIFE and TRANS FLUID LIFE. For more information about the trip odometer, see *Speedometer and Odometer on page 3-39*.

- **MPG AVG (Average Miles per Gallon)**: This message shows the approximate fuel economy you have averaged since the last time you reset the value. To reset the MPG AVG (Average Fuel Economy), press the INFO button to display the MPG AVG then press and hold the INFO RESET button until 0.0 MPG AVG is displayed.
- **GAL (Gallons) FUEL USED**: This message shows how much fuel has been used since the last reset. To learn how much fuel is used from a new starting point, press the RESET button while the GAL FUEL USED is displayed in the DIC.

- **AVG MPH (Average Miles per Hour):** This message shows the average speed you have traveled at since the last time you reset the value. To reset the value, press the INFO button to display AVG MPH then press and hold the INFO RESET button until 0.0 AVG MPH is displayed.
- **TIMER:** This feature is like a stopwatch, in that you can clock the time it takes to get from one point to another.

To operate, press the INFO button to display TIMER. Each of the fields for the hours, minutes and seconds are two numeric digits.

Once TIMER 00:00:00 is displayed, press the ON/OFF button to start the timing feature. Press the ON/OFF button again to stop it. If you will be starting and stopping your vehicle, during a trip for instance, the TIMER feature will automatically start timing where it left off when you last stopped. To reset it, press and hold the INFO RESET button until the display reads TIMER 00:00:00. Press the INFO button to exit from the TIMER display.

- **ENGINE OIL LIFE:** Press the INFO button to display ENGINE OIL LIFE, then press and hold the INFO RESET button until 100% ENGINE OIL LIFE is displayed. (This only needs to be reset after you have had the oil changed.)
- **TRANSMISSION FLUID LIFE MONITOR:** Under normal conditions, the rate of deterioration of the transmission fluid is slow. See *Part A: Scheduled Maintenance Services on page 6-4* for proper fluid and change intervals. To reset the transmission fluid life, press the INFO button to display TRANS FLUID LIFE, then press and hold the INFO RESET button until 100% TRANS FLUID LIFE is displayed. (This only needs to be reset after you have had the fluid changed.)

ON/OFF: Pressing this button turns the Personalization Features on and off. (FEATURE PROGRAMMING must be displayed on the DIC to begin actual programming.) This button also starts and stops the timer.

OUTSIDE TEMP (Temperature): This message shows the outside temperature. After this display has been on the DIC for about five seconds, the words OUTSIDE TEMP will disappear so that only the temperature remains.

MILES RANGE: This message shows about how many miles you can drive without refilling your fuel tank. Once the range drops below 40 miles (64 km) remaining, the display will show LOW.

MPG INST (Instantaneous Miles per Gallon): This message shows the instantaneous fuel economy which varies with your driving conditions, such as acceleration, braking and the grade of the road being traveled. The INFO RESET button does not function in this mode.

BATTERY VOLTS: This message shows the current battery voltage. If the voltage is normal the display will show BATTERY VOLTS OK. If the voltage drops below 10.5 volts, the display will show BATTERY VOLTS LOW. If the voltage is above 16 volts, the display will show BATTERY VOLTS HIGH. If the display shows the high or low message, you will need to have your battery checked. See *DIC Warnings and Messages on page 3-56* for more information.

LF-RF-LR-RR TIRE (If Equipped): On vehicles equipped with the tire pressure monitor, this message shows the tire pressure for each tire (left front, right front, left rear and right rear). Pressing the INFO button will scroll through the tire pressure for each of the four tires, such as the following:

- 34 PSI LF TIRE OK or
- 234 kPa LF TIRE OK

If a tire pressure is below 25 PSI (172 kPa) or above 38 PSI (265 kPa), the message will appear as shown above except it will show TIRE LOW or TIRE HIGH as appropriate. If desired, the tire pressure information can be programmed not to appear when using the INFO button to scroll through the DIC displays. See *DIC Vehicle Personalization on page 3-64*.

If a low or high tire pressure is detected by the system while driving, a CHECK TIRE PRESSURE message will appear in the display. If this occurs, press the INFO button to scroll to the tire(s) with a low or high pressure condition. See *DIC Warnings and Messages on page 3-56* for more information.

ENG/MET (English/Metric): Press this button to display information in the English (miles) or metric (kilometers) system.

DIC Warnings and Messages

These messages will appear if there is a problem sensed in one of your vehicle's systems. Vehicles that are first sold in Canada will have a number after each message. This number helps to identify the problem. You must then press INFO or INFO RESET to clear the display screen for further use. However, be sure to take any message that appears on the display screen seriously and remember that pressing the INFO or INFO RESET button will only make the message disappear, not the problem.

DIC messages can also be displayed in French, German, Spanish and Japanese. Contact your dealer to have the language display adjusted for your vehicle.

BATTERY NOT CHARGING – 7: This message will appear if the battery is not being charged. Have the electrical system checked by your dealership at your earliest convenience.

BATTERY SAVER ACTIVE – 27: This message is displayed when the vehicle has detected that the battery voltage is dropping beyond a reasonable point. The battery saver system will start reducing certain features of the vehicle that you may not be able to notice. At the point that features are disabled, this message is displayed. It means that the vehicle is trying to save the charge in the battery. Turn off unnecessary accessories to allow the battery to recharge.

BATTERY VOLTAGE HIGH – 8: This message shows that the electrical charging system is overcharging (more than 16 volts). To avoid being stranded, have the electrical system checked by your dealership. You can reduce the charging overload by using the accessories. Turn on the lamps and radio, set the climate control on AUTO and the fan speed on HI, and turn the rear window defogger on. You can monitor battery voltage on the DIC by pressing the INFO button. The normal range is 11.5 to 15.5 volts when the engine is running.

BATTERY VOLTAGE LOW – 6: This message will appear when the electrical system is charging less than 10 volts or if the battery has been drained. If this message appears immediately after starting, it is possible that the generator can still recharge the battery. The battery should recharge while driving but may take a few hours to do so. Consider using an auxiliary charger (be sure to follow the manufacturer's instructions) to boost the battery after returning home or to a final destination. If this message appears while driving or after starting your vehicle and stays on, have it checked immediately to determine the cause of this problem. To help the generator recharge the battery quickly, you can reduce the load on the electrical system by turning off the accessories. You can monitor battery voltage on the DIC by pressing the INFO button. The normal range is 11.5 to 15.5 volts.

CHANGE ENGINE OIL – 82: This means that the life of the engine oil has expired and it should be changed within 200 miles. After an oil change, the Oil Life Indicator must be reset. See *Oil Life Indicator on page 3-77*. See *Engine Oil on page 5-13*.

CHANGE TRANS FLUID – 47: This message will appear when it is time to change the transaxle fluid. See *Part A: Scheduled Maintenance Services on page 6-4* for the proper fluid and change intervals.

CHECK BRAKE FLUID – 37: This message will display if the ignition is in ON to inform the driver that the brake fluid level is low. Have the brake system serviced by a technician as soon as possible. See *Brake System Warning and Parking Brake Indicator Light on page 3-43*.

CHECK COOLANT LEVEL – 2: This message will appear when there is a low level of engine coolant. Have the cooling system serviced by a technician as soon as possible. See *Engine Coolant on page 5-25*.

CHECK FUEL GAGE – 50: This message will appear when the fuel supply is less than 5 gallons (18.9 L) and the display is turned off. A single chime will also sound when this message is displayed.

CHECK GAS CAP – 61: This message will appear if the gas cap has not been fully tightened. You should recheck your gas cap to ensure that it's on properly.

CHECK OIL LEVEL – 36: For correct operation of the low oil sensing system, your vehicle should be on a level surface. A false CHECK OIL LEVEL message may appear if the vehicle is parked on a grade. The oil level sensing system does not check for actual oil level if the engine has been off for a short period of time, and the oil level is never checked while the engine is running. If the CHECK OIL LEVEL message appears, and your vehicle has been parked on level ground with the engine off for at least 30 minutes, the oil level should be checked by observing the oil dipstick. Prior to checking the oil level, be sure the engine has been off for a few minutes and your vehicle is on a level surface. Then check the dipstick and add oil if necessary. See *Engine Oil on page 5-13*.

CHECK TIRE PRESSURE – 144: This message is displayed when the Tire Pressure Monitor (TPM) system detects a low or high tire pressure condition in one or more of the road tires. By pressing the INFO button up or down, the DIC display will show which tire or tires do not have the correct inflation pressure. A “LOW TIRE” condition exists when the tire’s air pressure is under 25 psi (172 kPa) and a “HIGH TIRE” condition exists when the tire’s air pressure is above 38 psi (262 kPa). The system will display the air pressure, the tire location (LF, RF, RR or LR) and if the air pressure is low or high. The tire pressure information is available in English or metric measurements. For example, a driver’s side front tire that is low may be shown as: 22 PSI LF TIRE LOW.

The correct tire inflation pressure should be set to those shown on the Tire Loading-Information Label, located on the rear edge of the driver’s door. For more information regarding proper tire inflation, see *Inflation -- Tire Pressure on page 5-64*. If a tire is low, you should stop as soon as possible and inspect your tire(s) for damage. If a tire is flat, see *If a Tire Goes Flat on page 5-73*.

Once the TPM system detects the low or high tire pressure condition, the message CHECK TIRE PRESSURE will be displayed whenever you start the engine. To remove or clear the CHECK TIRE PRESSURE message, you will need to set the tire(s) to the proper tire pressure. See *Inflation -- Tire Pressure on page 5-64*.

 **CAUTION:**

When the CHECK TIRE PRESSURE message is displayed on the Driver Information Center and the tire pressure is low, your vehicle’s handling capabilities will be reduced during severe maneuvers. If you drive too fast, you could lose control of your vehicle. You or others could be injured. Don’t drive over 55 mph (90 km/h) when the tire pressure is low. Drive cautiously and correct the tire pressure as soon as you can.

CHECK WASHER FLUID – 25: This message means that your vehicle is low on windshield washer fluid. See *Windshield Washer Fluid on page 5-39*.

DRIVER DOOR AJAR – 140: This message will display anytime the key is in ON, the transaxle is not in PARK (P) and the driver's door is open or ajar. A chime will sound when the vehicle's speed is greater than 3 mph (4.8 km/h).

DRIVE NO. X (1 OR 2): This message will be displayed with the key in ON and while entering FEATURE PROGRAMMING, but only if the vehicle is equipped with memory seats. The message will show which driver is activating the personalization feature. It will only stay on for five seconds. This message can be customized for you by your dealer.

ENGINE COOLANT HOT, IDLE ENGINE – 44: This message will appear when the engine coolant temperature is over 262°F (128°C). Stop and allow your vehicle to idle in PARK (P) until it cools down and the message is removed. Do not increase engine speed above a normal idle. If it does not cool down, turn off the engine and have it serviced before driving it again. Severe engine damage can result from an overheated engine. See *Engine Overheating on page 5-28*.

ENGINE HOT-AC OFF – 16: This message displays when the engine coolant becomes hotter than the normal operating temperature. To avoid added strain on a hot engine, the air conditioning compressor is automatically turned off. When the coolant temperature returns to normal, the A/C operation will automatically resume. You can continue to drive your vehicle. If this message continues to appear, have the system repaired as soon as possible to avoid compressor damage.

ENGINE OVERHEATED, STOP ENGINE – 42: This message will appear when the engine has overheated. Stop and turn the engine off immediately to avoid severe engine damage. See *Engine Overheating on page 5-28*. A multiple chime will also sound when this message is displayed.

ENGINE POWER REDUCED – 41: This message informs you that the vehicle is reducing engine power because the transaxle is being placed in gear under conditions that may cause damage to the vehicle's engine, transaxle or ability to accelerate.

FUEL LEVEL LOW – 11: This message serves as a warning that the fuel level in the tank is critically low. Stop for fuel soon. A single chime will sound when this message is displayed.

HEADLAMPS SUGGESTED – 23: If it's dark enough outside and the headlamps and Twilight Sentinel® controls are off, this message will display on the DIC. This message informs the driver that turning on the exterior lamps is recommended even though the DRL are still illuminated. It has become dark enough outside to require the headlamps and/or other exterior lamps. This message will also appear if the optional Rainsense™ wiping feature is on and the Twilight Sentinel® is off.

ICE POSSIBLE – 13: This message appears when the outside air temperature is cold enough to create icy road conditions.

LEFT REAR DOOR AJAR – 142: The left rear door is open or ajar when this message appears. The ignition must be in ON and the transaxle not in PARK (P) for this message to display. A chime will sound if the vehicle's speed is greater than 3 mph (5 km/h).

OIL PRESSURE LOW STOP ENGINE – 35: If this message appears while the engine is running, stop the engine and do not operate it until the cause of low oil pressure is corrected. Severe damage to the engine can result. A multiple chime will sound when this message is displayed.

PASSENGER DOOR AJAR – 141: The right front passenger's door is open or ajar when this message appears. The ignition must be in ON and the transaxle not in PARK (P) for this message to display. A chime will sound if the vehicle's speed is greater than 3 mph (5 km/h).

RIGHT REAR DOOR AJAR – 143: The right rear door is open or ajar when this message appears. The ignition must be in ON and the transaxle not in PARK (P) for this message to display. A chime will sound if the vehicle's speed is greater than 3 mph (5 km/h).

SERVICE AC SYSTEM – 14: This message appears when the electronic sensors that control the air conditioning and heating systems are no longer working. Have the climate control system serviced if you notice a drop in heating and air conditioning efficiency.

SERVICE AIR BAG – 83: There is a problem with the air bag system when this message appears. Let only a qualified technician work on your vehicle. Have your vehicle serviced by your dealership immediately.

SERVICE CHARGING SYS – 102: This message will display when a problem with the charging system has been detected. Have your vehicle serviced at your dealership.

SERVICE ELECTRICAL SYS – 106: This message will display if an electrical problem has occurred within the Powertrain Control Module (PCM) or the ignition switch. Have your vehicle serviced by your dealership.

SERVICE FUEL SYSTEM – 101: The Powertrain Control Module (PCM) has detected a problem within the fuel system when this message appears. Have your vehicle serviced by your dealership.

SERVICE IDLE CONTROL – 107: A problem with the idle control has occurred when this message displays. Have your vehicle serviced by your dealership.

SERVICE STABILITY SYS – 54: If you ever see the SERVICE STABILITY SYS message, it means there may be a problem with your stability enhancement system. If you see this message, try to reset the system (stop, turn off the engine, then start the engine again). If the SERVICE STABILITY SYS message still comes on, it means there is a problem. You should see your dealer for service. Reduce your speed and drive accordingly. A single chime will also sound when this message is displayed.

SERVICE STEERING – 127: This message is displayed when a problem has been detected in the magnetic speed variable assist steering system. If message comes on, service is required.

SERVICE SUSPENSION SYS – 84: This message is displayed to indicate that the suspension system is not operating properly. To correct this problem, have your vehicle serviced at your dealership.

SERVICE THEFT SYSTEM – 34: This message means there is a problem with the PASS-Key[®] III system. A fault has been detected in the system which means that the system is disabled and is not protecting the vehicle. The vehicle usually restarts, however, you may want to take your vehicle to your dealer before turning off the engine.

SERVICE TPM SYSTEM – 51: When this message is displayed, the Tire Pressure Monitor (TPM) system is not working properly. See your dealer for service.

SERVICE TRANSMISSION – 100: See your dealer for repair.

SERVICE VEHICLE SOON – 3: This message is displayed when a non-emissions related powertrain malfunction occurs. Have your vehicle serviced by a technician as soon as possible.

SPEED LIMIT TO 90 – 113: A failure in the suspension control system has occurred when this message appears. The Powertrain Control Module (PCM) determines the speed to which your vehicle is limited. Have your vehicle serviced if this message appears.

STABILITY SYS ENGAGED – 55: You may see the STABILITY SYS ENGAGED message on the Driver Information Center. It means that an advanced, computer-controlled system has come on to help your vehicle continue to go in the direction in which you're steering. This stability enhancement system activates when the computer senses that your vehicle is just starting to spin, as it might if you hit a patch of ice or other slippery spot on the road. When the system is on, you may hear a noise or feel a vibration in the brake pedal. This is normal.

When the STABILITY SYS ENGAGED message is on, you should continue to steer in the direction you want to go. The system is designed to help you in bad weather or other difficult driving situations by making the most of whatever road conditions will permit. If the STABILITY SYS ENGAGED message comes on, you'll know that something has caused your vehicle to start to spin, so you should consider slowing down. A single chime will also sound when this message is displayed.

STARTING DISABLED REMOVE KEY – 33: This message will appear when the PASS-Key® III system detects that an improper ignition key is being used to try to start the vehicle. Check the ignition key for damage. If it is damaged, it may need to be replaced. If it is not damaged, remove the key and try to start the vehicle again. If it still does not start, try another ignition key or see your dealer for service.

THEFT ATTEMPTED – 40: This message is displayed if the theft system has detected a break-in attempt while you were away from your vehicle.

TOP SPEED FUEL CUT-OFF – 111: This message will appear when the Powertrain Control Module (PCM) detects that the maximum speed for your vehicle has been reached. The speed of your vehicle will surge as the fuel supply is cut off. Your vehicle's top speed is based on the top speed rating of the tires. This ensures that your vehicle stays in a safe operating range for the tires.

TRACTION ENGAGED – 91: When your traction control system is limiting wheel spin, the TRACTION ENGAGED message will be displayed. Slippery road conditions may exist if this message is displayed, so adjust your driving accordingly. This message will stay on for a few seconds after the traction control system stops limited wheel spin.

TRACTION OFF – 89: This message will be displayed after the traction control system has been turned off using the TRAC ON/OFF button on the center console.

TRACTION READY – 90: This message informs the driver that the traction control system is available. Pressing the TRAC ON/OFF button on the center console once turns the traction control system off; pressing the button again turns the system back on. This message will automatically disappear from the display after five seconds.

TRACTION SUSPENDED – 56: This message displays when the traction control system has been temporarily shut off because your vehicle's brakes have overheated. This message does not indicate a problem with your vehicle's traction control system. After a few minutes, the traction control system will be available again and the TRACTION READY message will appear.

TRANS HOT IDLE ENGINE – 112: This message indicates that the transaxle fluid in your vehicle is too hot. Stop and allow your vehicle to idle until it cools down or until this message is removed.

TRUNK OPEN – 24: This message indicates that the trunk is open when the ignition is on.

TURN SIGNAL ON – 20: If you drive your vehicle for more than a mile with a turn signal on, this message will appear as a reminder to turn off the turn signal. A multiple chime will sound when this message is displayed.

VEHICLE OVERSPEED – 52: This message is displayed when the vehicle speed exceeds a certain limit as required by some export countries. A continuous chime will sound when this message is displayed.

Climate Controls and Radio System Personalization

These features allow both drivers to personalize their own climate control settings as well as their radio settings. For more information, see *Climate Controls Personalization on page 3-36* and *Radio Personalization with Home and Away Feature on page 3-102*.

The outside temperature is always available for display if it has been selected for a DIC display when your vehicle is running unless an overriding DIC message appears. You can change the temperature from Fahrenheit to Celsius by pressing the ENG/MET (English/metric) button on the instrument panel. For more information on the DIC, see *DIC Warnings and Messages on page 3-56*.

The electronic sensor can be affected by road or engine heat during idling, slow driving or when the engine is first started after a short trip. To ensure proper automatic climate control operation, the outside air temperature display may not update as quickly as expected. This is to allow the air surrounding the outside temperature sensor to be as close to the actual outside conditions as possible. This is determined by how much time has elapsed since the vehicle has been turned off and by vehicle speed.

DIC Vehicle Personalization

Your vehicle is equipped with personalization capabilities that allows you to program certain features to a preferred setting for up to two people. The number of programmable features varies depending upon which model of the vehicle is purchased. On all vehicles, features such as climate control settings, radio preset settings, exterior lighting at unlock, remote lock and unlock confirmation, and automatic door locks have already been programmed for your convenience. Some vehicles are equipped with additional features that can be programmed including the seat position, steering column position (if equipped) and outside mirror position. The navigation screen preferences (if equipped) will remain at the last set position.

If your vehicle is equipped with the ability to program additional personalization features, the driver's preferences are recalled by pressing the unlock button on the remote keyless entry transmitter or by pressing the appropriate memory button, 1 or 2, located on the driver's door. Certain features can be programmed not to recall until the key is placed in the ignition. To change feature preferences you must use one of the following procedures.

Entering Feature Programming

To enter feature programming mode, do the following:

1. Turn the ignition to ON, making sure the vehicle is in PARK (P).
2. If your vehicle has memory settings, press the appropriate memory button, 1 or 2, located on the driver's door panel. The DIC display will show either 1 or 2 depending on which button was selected. Make sure the number on the DIC display matches the number on the back of your key fob.
3. Press the INFO button until FEATURE PROGRAMMING appears on the DIC display.
4. Press the ON/OFF button to enter FEATURE PROGRAMMING.

Remote Recall Memory

If your vehicle has the optional memory package, you will have this feature. This feature recalls any previously programmed seat and mirror controls when the unlock button on the remote keyless entry transmitter is pressed. The telescoping steering column (if equipped) will return to its programmed position when the key is inserted in the ignition switch and turned to ON.

Programmable Modes

Mode 1: ON

Mode 2: OFF

Before your vehicle was shipped from the factory, it was programmed to Mode 1. The mode to which the vehicle was programmed may have been changed since it left the factory. To determine the mode to which the vehicle is programmed or to program the vehicle to a different mode, do the following:

1. Enter FEATURE PROGRAMMING following the instructions listed previously.
2. Press the down arrow on the INFO button until REMOTE RECALL MEMORY appears on the DIC display.

3. To turn on the feature, press the ON/OFF button until ON appears on the DIC display. To turn it off, press the ON/OFF button until OFF appears on the display.

The mode you selected is now set. You can either exit the programming mode by following the instructions later in this section or program the next feature available on your vehicle.

Key in Recall Memory

If your vehicle has the optional memory package, you will have this feature. This feature recalls any previously programmed seat and mirror controls when the key is inserted into the ignition. The telescoping steering column (if equipped) will return to its programmed position when the key is inserted in the ignition switch and turned to ON.

Programmable Modes

Mode 1: ON

Mode 2: OFF

Before your vehicle was shipped from the factory, it was programmed to Mode 2. The mode to which the vehicle was programmed may have been changed since it left the factory. To determine the mode to which the vehicle is programmed or to program the vehicle to a different mode, do the following:

1. Enter FEATURE PROGRAMMING following the instructions listed previously.
2. Press the down arrow on the INFO button until KEY IN RECALL MEMORY appears on the DIC display.
3. To turn on the feature, press the ON/OFF button until ON appears on the DIC display. To turn it off, press the ON/OFF button until OFF appears on the display.

The mode you selected is now set. You can either exit the programming mode by following the instructions later in this section or program the next feature available on your vehicle.

Auto Exit Seat

If your vehicle has the optional memory package, you will have this feature. This feature will move the driver's seat to the previously programmed exit position when the ignition is turned off and the driver's door is opened.

Programmable Modes

Mode 1: ON

Mode 2: OFF

Before your vehicle was shipped from the factory, it was programmed to Mode 2. The mode to which the vehicle was programmed may have been changed since it left the factory. To determine the mode to which the vehicle is programmed or to program the vehicle to a different mode, do the following:

1. Enter FEATURE PROGRAMMING following the instructions listed previously.
2. Press the down arrow on the INFO button until AUTO EXIT SEAT appears on the DIC display.

3. To turn on the feature, press the ON/OFF button until ON appears on the DIC display. To turn it off, press the ON/OFF button until OFF appears on the display.

The mode you selected is now set. You can either exit the programming mode by following the instructions later in this section or program the next feature available on your vehicle.

Auto Exit Steering Wheel

If your vehicle has the optional memory package, you may have this feature also. This feature will move the steering column to the driver's previously programmed exit position when the ignition is turned off and the driver's door is opened.

Programmable Modes

Mode 1: ON

Mode 2: OFF

Before your vehicle was shipped from the factory, it was programmed to Mode 1. The mode to which the vehicle was programmed may have been changed since it left the factory. To determine the mode to which the vehicle is programmed or to program the vehicle to a different mode, do the following:

1. Enter FEATURE PROGRAMMING following the instructions listed previously.
2. Press the down arrow on the INFO button until AUTO EXIT STRG WHEEL appears on the DIC display.
3. To turn on the feature, press the ON/OFF button until ON appears on the DIC display. To turn it off, press the ON/OFF button until OFF appears on the display.

The mode you selected is now set. You can either exit the programming mode by following the instructions later in this section or program the next feature available on your vehicle.

Lights Flash at Unlock

This feature allows the parking lamps to flash twice when the remote keyless entry transmitter is used to unlock the vehicle. All doors must be closed, and the lamps will not flash if the manual parking lamps or headlamps are active.

Programmable Modes

Mode 1: ON

Mode 2: OFF

Before your vehicle was shipped from the factory, it was programmed to Mode 1. The mode to which the vehicle was programmed may have been changed since it left the factory. To determine the mode to which the vehicle is programmed or to program the vehicle to a different mode, do the following:

1. Enter FEATURE PROGRAMMING following the instructions listed previously.
2. Press the down arrow on the INFO button until LIGHTS FLASH AT UNLOCK appears on the DIC display.

3. To turn on the feature, press the ON/OFF button until ON appears on the DIC display. To turn it off, press the ON/OFF button until OFF appears on the display.

The mode you selected is now set. You can either exit the programming mode by following the instructions later in this section or program the next feature available on your vehicle.

Lights Flash at Lock

This feature allows the parking lamps to flash once when the remote keyless entry transmitter is used to lock the vehicle. All doors must be closed for this feature to work, and the lamps will not flash if the manual parking lamps or headlamps are active.

Programmable Modes

Mode 1: ON

Mode 2: OFF

Before your vehicle was shipped from the factory, it was programmed to Mode 1. The mode to which the vehicle was programmed may have been changed since it left the factory. To determine the mode to which the vehicle is programmed or to program the vehicle to a different mode, do the following:

1. Enter FEATURE PROGRAMMING following the instructions listed previously.
2. Press the down arrow on the INFO button until LIGHTS FLASH AT LOCK appears on the DIC display.
3. To turn on the feature, press the ON/OFF button until ON appears on the DIC display. To turn it off, press the ON/OFF button until OFF appears on the display.

The mode you selected is now set. You can either exit the programming mode by following the instructions later in this section or program the next feature available on your vehicle.

Horn Sounds at Lock

This feature sounds the horn once when the remote keyless entry transmitter is used to lock the vehicle. All doors must be closed for this feature to work.

Programmable Modes

Mode 1: ON

Mode 2: OFF

Before your vehicle was shipped from the factory, it was programmed to Mode 2. The mode to which the vehicle was programmed may have been changed since it left the factory. To determine the mode to which the vehicle is programmed or to program the vehicle to a different mode, do the following:

1. Enter FEATURE PROGRAMMING following the instructions listed previously.
2. Press the down arrow on the INFO button until HORN SOUNDS AT LOCK appears on the DIC display.

3. To turn on the feature, press the ON/OFF button until ON appears on the DIC display. To turn it off, press the ON/OFF button until OFF appears on the display.

The mode you selected is now set. You can either exit the programming mode by following the instructions later in this section or program the next feature available on your vehicle.

Exterior Lights at Unlock

This feature turns on the exterior lamps when the remote keyless entry transmitter is used to unlock the vehicle. The lamps will remain on for about 20 seconds unless a door is opened, the ignition is turned to ACCESSORY, ON or START or the remote keyless entry transmitter is used to lock the vehicle.

Programmable Modes

Mode 1: ON

Mode 2: OFF

Before your vehicle was shipped from the factory, it was programmed to Mode 1. The mode to which the vehicle was programmed may have been changed since it left the factory. To determine the mode to which the vehicle is programmed or to program the vehicle to a different mode, do the following:

1. Enter FEATURE PROGRAMMING following the instructions listed previously.
2. Press the down arrow on the INFO button until EXT LIGHTS AT UNLOCK appears on the DIC display.
3. To turn on the feature, press the ON/OFF button until ON appears on the DIC display. To turn it off, press the ON/OFF button until OFF appears on the display.

The mode you selected is now set. You can either exit the programming mode by following the instructions later in this section or program the next feature available on your vehicle.

Doors Lock in Gear

With the ignition in ON and all the doors closed, this feature allows the vehicle's doors to automatically lock when the driver shifts the transaxle out of PARK (P).

Programmable Modes

Mode 1: ON

Mode 2: OFF

Before your vehicle was shipped from the factory, it was programmed to Mode 1. The mode to which the vehicle was programmed may have been changed since it left the factory. To determine the mode to which the vehicle is programmed or to program the vehicle to a different mode, do the following:

1. Enter FEATURE PROGRAMMING following the instructions listed previously.
2. Press the down arrow on the INFO button until DOORS LOCK IN GEAR appears on the DIC display.

3. To turn on the feature, press the ON/OFF button until ON appears on the DIC display. To turn it off, press the ON/OFF button until OFF appears on the display.

The mode you selected is now set. You can either exit the programming mode by following the instructions later in this section or program the next feature available on your vehicle.

Driver Unlock in PARK (P)

This feature allows the driver's door to automatically unlock when the vehicle is shifted into PARK (P). All other doors will remain locked until the unlock button on either front door armrest or on the remote keyless entry transmitter is pressed.

Programmable Modes

Mode 1: ON

Mode 2: OFF

Before your vehicle was shipped from the factory, it was programmed to Mode 2. The mode to which the vehicle was programmed may have been changed since it left the factory. To determine the mode to which the vehicle is programmed or to program the vehicle to a different mode, do the following:

1. Enter FEATURE PROGRAMMING following the instructions listed previously.
2. Press the down arrow on the INFO button until DRIVER UNLOCK IN PARK appears on the DIC display.
3. To turn on the feature, press the ON/OFF button until ON appears on the DIC display. To turn it off, press the ON/OFF button until OFF appears on the display.

The mode you selected is now set. You can either exit the programming mode by following the instructions later in this section or program the next feature available on your vehicle.

Driver Unlock Key Off

This feature allows the driver's door to automatically unlock when the ignition key is turned to OFF. All other doors will remain locked until the unlock button on either front door armrest or on the remote keyless entry transmitter is pressed.

Programmable Modes

Mode 1: ON

Mode 2: OFF

Before your vehicle was shipped from the factory, it was programmed to Mode 2. The mode to which the vehicle was programmed may have been changed since it left the factory. To determine the mode to which the vehicle is programmed or to program the vehicle to a different mode, do the following:

1. Enter FEATURE PROGRAMMING following the instructions listed previously.
2. Press the down arrow on the INFO button until DRIVER UNLOCK KEY OFF appears on the DIC display.

3. To turn on the feature, press the ON/OFF button until ON appears on the DIC display. To turn it off, press the ON/OFF button until OFF appears on the display.

The mode you selected is now set. You can either exit the programming mode by following the instructions later in this section or program the next feature available on your vehicle.

Doors Unlock in PARK (P)

This feature will automatically unlock all doors when the vehicle is shifted in to PARK (P).

Programmable Modes

Mode 1: ON

Mode 2: OFF

Before your vehicle was shipped from the factory, it was programmed to Mode 1. The mode to which the vehicle was programmed may have been changed since it left the factory. To determine the mode to which the vehicle is programmed or to program the vehicle to a different mode, do the following:

1. Enter FEATURE PROGRAMMING following the instructions listed previously.
2. Press the down arrow on the INFO button until DOORS UNLOCK IN PARK appears on the DIC display.
3. To turn on the feature, press the ON/OFF button until ON appears on the DIC display. To turn it off, press the ON/OFF button until OFF appears on the display.

The mode you selected is now set. You can either exit the programming mode by following the instructions later in this section or program the next feature available on your vehicle.

Doors Unlock Key Off

This feature will automatically unlock all doors when the ignition key is turned to OFF.

Programmable Modes

Mode 1: ON

Mode 2: OFF

Before your vehicle was shipped from the factory, it was programmed to Mode 2. The mode to which the vehicle was programmed may have been changed since it left the factory. To determine the mode to which the vehicle is programmed or to program the vehicle to a different mode, do the following:

1. Enter FEATURE PROGRAMMING following the instructions listed previously.
2. Press the down arrow on the INFO button until DRIVER UNLOCK KEY OFF appears on the DIC display.

3. To turn on the feature, press the ON/OFF button until ON appears on the DIC display. To turn it off, press the ON/OFF button until OFF appears on the display.

The mode you selected is now set. You can either exit the programming mode by following the instructions later in this section or program the next feature available on your vehicle.

Mirror to Curb In Reverse

If your vehicle has the optional memory package, you will have this feature. This feature will move the passenger's outside rearview mirror to a curb view position when the shift lever is placed in REVERSE (R), and it will return the mirror to the last known driving position when the shift lever is moved out of REVERSE (R). See *Outside Curb View Assist Mirror on page 2-41* for more information.

Programmable Modes

Mode 1: ON

Mode 2: OFF

Before your vehicle was shipped from the factory, it was programmed to Mode 2. The mode to which the vehicle was programmed may have been changed since it left the factory. To determine the mode to which the vehicle is programmed or to program the vehicle to a different mode, do the following:

1. Enter FEATURE PROGRAMMING following the instructions listed previously.
2. Press the down arrow on the INFO button until MIRROR TO CURB IN REV appears on the DIC display.
3. To turn on the feature, press the ON/OFF button until ON appears on the DIC display. To turn it off, press the ON/OFF button until OFF appears on the display.

The mode you selected is now set. You can either exit the programming mode by following the instructions later in this section or program the next feature available on your vehicle.

Tire Pressure Display

If your vehicle has the optional Tire Pressure Monitor (TPM) System, you will have this feature. This feature will allow the individual tire pressure readings to be displayed when using the INFO button to scroll through the DIC displays. Even with this feature programmed to be turned off, a low or high tire pressure condition will still cause the CHECK TIRE PRESSURE message to be displayed on the DIC. See *DIC Warnings and Messages on page 3-56* for more information.

Programmable Modes

Mode 1: ON

Mode 2: OFF

Before your vehicle was shipped from the factory, it was programmed to Mode 1. The mode to which the vehicle was programmed may have been changed since it left the factory. To determine the mode to which the vehicle is programmed or to program the vehicle to a different mode, do the following:

1. Enter FEATURE PROGRAMMING following the instructions listed previously.
2. Press the down arrow on the INFO button until TIRE PRESSURE DISPLAY appears on the DIC display.
3. To turn on the feature, press the ON/OFF button until ON appears on the DIC display. To turn it off, press the ON/OFF button until OFF appears on the display.

The mode you selected is now set. You can either exit the programming mode by following the instructions later in this section or program the next feature available on your vehicle.

Driver's Name Set/Recall

If your vehicle has the optional memory package, you will have this feature. This feature allows individual driver's names to be displayed in the DIC when the ignition is turned to ON. This feature only works when the remote keyless entry transmitter is used to unlock the vehicle or when buttons 1 or 2 on the driver's door are pressed. See your dealer for assistance in programming this feature.

Exiting Feature Programming

To exit FEATURE PROGRAMMING, press the INFO RESET or INFO button.

Trip Computer

Oil Life Indicator

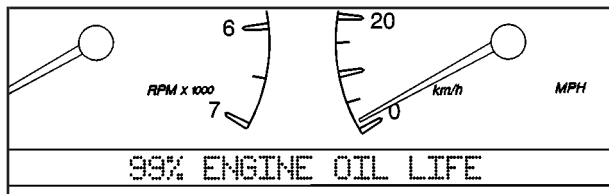

This feature lets you know when to change the engine oil. It's based on the engine oil temperatures and your driving patterns.

To see the display, press the INFO button several times until ENGINE OIL LIFE appears. If you see 99% ENGINE OIL LIFE, 99 percent of your current oil life remains.

The DIC may display a CHANGE ENGINE OIL message. For more information, see *Scheduled Maintenance on page 6-4*. If you see CHANGE ENGINE OIL, it means the oil life is gone and you should change the oil right away. The system doesn't check how much oil you have, so you'll still have to check for that. To see how, see *Engine Oil on page 5-13*.

When the oil is changed, you'll need to reset the system. See *Engine Oil on page 5-13*. Always keep a written record of the mileage and date when you changed your oil.

Audio System(s)

Notice: Before you add any sound equipment to your vehicle – like a tape player, CB radio, mobile telephone or two-way radio – be sure you can add what you want. If you can, it's very important to do it properly. Added sound equipment may interfere with the operation of your vehicle's engine, radio or other systems, and even damage them. Your vehicle's systems may interfere with the operation of sound equipment that has been added improperly.

So, before adding sound equipment, check with your dealer and be sure to check federal rules covering mobile radio and telephone units.

Your audio system has been designed to operate easily and to give years of listening pleasure. You will get the most enjoyment out of it if you acquaint yourself with it first. Figure out which radio you have in your vehicle, find out what your audio system can do and how to operate all of its controls to be sure you're getting the most out of the advanced engineering that went into it.

Your vehicle has a feature called Retained Accessory Power (RAP). With RAP, you can play your audio system even after the ignition is turned off. See "Retained Accessory Power (RAP)" under *Ignition Positions on page 2-24*.

Setting the Time for Radios without Radio Data Systems (RDS)

Press and hold HR until the correct hour appears on the display. Press and hold MN until the correct minute appears on the display. Display the time with the ignition off by pressing one of these buttons.

Setting the Time for Radios with Radio Data Systems (RDS)

Press and hold HR until the correct hour appears on the display. Press and hold MN until the correct minute appears on the display. Display the time when the ignition is off by pressing one of these buttons.

To synchronize the time with an FM station broadcasting Radio Data System (RDS) information, press and hold HR and MN at the same time until TIME UPDATED appears on the display. If the time is not available from the station, NO STATION TIME will appear on the display.

Radio with Cassette and CD (Base Level)



XM™ Radio Satellite Service (USA Only)

XM™ is a continental U.S. based satellite radio service that offers 100 coast to coast channels including music, news, sports, talk and children's programming. XM™ provides digital quality audio and text information, including song title and artist name. A service fee is required in order to receive the XM™ service. For more information, contact XM™ at www.xmradio.com or call 1-800-852-XXM (9696).

Playing the Radio

PWR (Power): Press this knob to turn the system on and off.

VOL (Volume): Turn this knob to increase or to decrease volume.

HR (Hour) or MN (Minute): Display the time with the ignition off by pressing one of these buttons.

SOURCE: Press this button to select a source, either cassette or compact disc. The audio source must be loaded to play. Available loaded sources are shown on the display. If a source is being used, it will be underlined on the display. If none of the audio sources are loaded, NO SOURCE LOADED will appear on the display. Press this button again or press BAND to switch back to the radio.

Finding a Station

BAND: Press this button to select weather, FM1, FM2, AM, or XM1, XM2 (USA only, if equipped).

TUNE SEEK: This button can be pressed to two positions. Press this button to the first position to manually tune to the next or to the previous stations. If this button is held at the first position for a few seconds, the radio will continue tuning until this button is released.

Press this button to the second position and release it to seek to the next or to the previous radio station.

The radio will seek only to stations that are in the selected band and only to those with a strong signal.

SCAN: Press this button for less than two seconds to scan radio stations. The radio will go to a station, play for five seconds, then go on to the next station. Press this button again to stop scanning.

To scan preset stations, press and hold SCAN for more than two seconds until you hear a beep. The radio will go to the first preset station stored on your pushbuttons, play for five seconds, then go on to the next preset station. Press SCAN again to stop scanning presets.

The radio will scan only to the stations that are in the selected band and only to those with a strong signal.

Setting Preset Stations

The six numbered pushbuttons let you return to your favorite stations. You can set up to 36 stations (six weather, six FM1, six FM2, six AM, six XM1 and six XM2 (USA only, if equipped), by performing the following steps:

1. Turn the radio on.
2. Press BAND to select weather, FM1, FM2, AM, or XM1, XM2.
3. Tune in the desired station.
4. Press and hold one of the six numbered pushbuttons for more than two seconds until you hear a beep.
5. Repeat the steps for each pushbutton. Whenever you press that numbered pushbutton for less than two seconds, the station you set will return.

When battery power is removed and later applied, you will not have to reset your radio presets because the radio remembers them.

Setting the Tone (Bass/Treble)

TONE: Press and release this button until the desired tone control (bass, treble or midrange) appears on the display. The radio keeps separate tone settings for each band, preset and source.

– **LEVEL +:** After selecting the desired tone control, press the plus or minus symbol on this button to select the desired level.

To save the tone settings for your presets, press and hold the numbered pushbutton for the desired preset for more than two seconds until you hear a beep.

Adjusting the Speakers (Balance/Fade)

 **(Speaker):** Press and release this button until the desired control (balance or fade) appears on the display.

– **LEVEL +:** After selecting the desired control, press the plus or minus symbol on this button to select the desired level.

PTY (Program Type): This button is inoperable on this radio, except if your radio is equipped with XM™ Satellite Radio Service.

Finding a PTY Station (XM™ Only)

To select and find a desired PTY perform the following:

1. Press PTY. PTY will be displayed on the screen.
2. Select a category by pressing – LEVEL +.
3. Once the desired category is displayed, press TUNE/SEEK to select the category and take you to the category's first station.
4. If you want to go to another station within that category, press TUNE/SEEK once to display the category, then press TUNE/SEEK again to go to another station.
5. If PTY times out and is no longer on the display, go back to Step 1.

SCAN: You can also scan through the channels within a category by performing the following:

1. Press PTY. PTY will be displayed on the screen.
2. Select a category by pressing – LEVEL +.
3. Once the desired category is displayed, press SCAN, and the radio will begin scanning within your chosen category.
4. Press SCAN again to stop at a particular section.

XM™ Radio Messages

| Radio Display Message | Condition | Action Required |
|---------------------------------|--------------------------------------------------------------------------------------------|------------------------------------------------------------------------------------------------------------------------------------------------------------------------------------------|
| XL (Explicit Language Channels) | XL on the radio display, after the channel name, indicates content with explicit language. | These channels, or any others, can be blocked at a customer's request, by calling 1-800-852-XXXM (9696). |
| XM Updating | Updating encryption code | The encryption code in your receiver is being updated, and no action is required. This process should take no longer than 30 seconds. |
| No XM signal | Loss of signal | Your system is functioning correctly, but you are in a location that is blocking the XM signal. When you move into an open area, the signal should return. |
| Loading XM | Acquiring channel audio (after 4 second delay) | Your radio system is acquiring and processing audio and text data. No action is needed. This message should disappear shortly. |
| Channel Off Air | Channel not in service | This channel is not currently in service. Tune in to another channel. |
| Channel Unavail | Channel no longer available | This previously assigned channel is no longer assigned. Tune to another station. If this station was one of your presets, you may need to choose another station for that preset button. |
| No Artist Info | Artist Name/Feature not available | No artist information is available at this time on this channel. Your system is working properly. |
| No Title Info | Song/Program Title not available | No song title information is available at this time on this channel. Your system is working properly. |

XM™ Radio Messages (cont'd)

| Radio Display Message | Condition | Action Required |
|-----------------------|---------------------------------------------------------|---------------------------------------------------------------------------------------------------------------------------------------------------------------------------------------------------------------------------------------------------------|
| No CAT Info | Category Name not available | No category information is available at this time on this channel. Your system is working properly. |
| Not Found | No channel available for the chosen category | There are no channels available for the category you selected. Your system is working properly. |
| No Information | No Text/Informational message available | No text or informational messages are available at this time on this channel. Your system is working properly. |
| XM Theftlocked | Theft lock active | The XM receiver in your vehicle may have previously been in another vehicle. For security purposes, XM receivers cannot be swapped between vehicles. If you receive this message after having your vehicle serviced, check with the servicing facility. |
| XM Radio ID | Radio ID label (channel 0) | If you tune to channel 0, you will see this message alternating with your XM Radio 8 digit radio ID label. This label is needed to activate your service. |
| Unknown | Radio ID not known (should only be if hardware failure) | If you receive this message when you tune to channel 0, you may have a receiver fault. Consult with your dealer. |
| Check XM Receiver | Hardware failure | If this message does not clear within a short period of time, your receiver may have a fault. Consult with your retail location. |

Playing a Cassette Tape

With the radio on, insert a cassette tape. The tape will begin playing as soon as it is inserted. When one side of your cassette tape is done playing, auto reverse plays the other side of your cassette tape. A cassette tape may be loaded with the radio off but it will not start playing until the radio is on. If you want to insert a cassette tape when the ignition is off, first press the eject button.

While the tape is playing, use the VOL, TONE, and LEVEL controls just as you do for the radio. Other controls may have different functions when a tape is inserted. The display will show an underlined tape symbol. TAPE PLAY will appear on the display when a tape is playing, with an arrow to indicate which side of the tape is playing.

Your cassette tape player automatically reduces background noise. Dolby® Noise Reduction is manufactured under a license from Dolby® Laboratories Licensing Corporation. Dolby® and the double-D symbol are trademarks of Dolby® Laboratories Licensing Corporation.

Auto CrO2 allows the cassette tape player to adjust to the type of cassette tape for clearer sound of CrO2 cassette tapes.

If an error appears on the display, see “Cassette Tape Messages” later in this section.

◀ **RW (Rewind):** Press the left arrow to rewind the tape rapidly. The radio will play while the tape rewinds. You may use your radio pushbuttons to tune to another station while in rewind. Press the left arrow again to return to playing speed.

FF ▶▶ **(Fast Forward):** Press the right arrow to fast forward to another part of the tape. The radio will play while the tape advances. You may use your radio pushbuttons to tune to another station while in fast forward. Press the right arrow again to return to playing speed.

⏏ **TUNE SEEK** ⏏: Your tape must have at least three seconds of silence between each selection for SEEK to work. Press the up or the down arrow to seek to the next or to the previous selection on the tape.

SCAN: Press this button to listen to selections for a few seconds. The tape will go to a selection, play for a few seconds, then go on to the next selection. Press this button again to stop scanning.

SIDE: Press this button to play the other side of the tape.

⏏ **(Eject):** Press this button, located to the right of the cassette tape slot to remove a tape. Eject may be activated with the radio off and/or the ignition off.

Cassette Tape Messages

If an error occurs while trying to play a cassette tape, it could be for one of the following reasons:

- The cassette tape is tight and the cassette player cannot turn the hubs of the tape. Hold the cassette tape with the open end down and try turning the right hub counterclockwise with a pencil. Flip the tape over and repeat. If the hubs do not turn easily, your cassette tape may be damaged and should not be used in the player. Try a new tape to be sure your player is working properly.
- The cassette tape is broken. (Check to see if your tape is broken. Try a new tape.)

CLEAN TAPE: If this message appears on the display, the cassette tape player needs to be cleaned. It will still play tapes, but you should clean it as soon as possible to prevent damage to the tapes and player. See *Care of Your Cassette Tape Player* on page 3-104.

If any error occurs repeatedly or if an error can't be corrected, contact your dealer.

Playing a Compact Disc

Insert a disc partway into the slot, label side up. The player will pull it in. If the ignition and the radio are on and the underlined compact disc symbol appears on the display, the disc will begin playing. A compact disc may be loaded with the radio off but it will not start playing until the radio is on. If you want to insert a disc when the ignition is off, first press the eject button.

The integral CD player can play the smaller 8 cm compact discs. Full-size compact discs and the smaller compact discs are loaded in the same manner.

If playing a CD-R the sound quality may be reduced due to CD-R quality, the method of recording, the quality of the music that has been recorded and the way the CD-R has been handled. You may experience an increase in skipping, difficulty in finding tracks and/or difficulty in loading and ejecting. If these problems occur try a known good CD.

Do not add paper labels to discs, they could get caught in the CD player.

Do not play 3 inch discs without a standard adapter disc.

If an error appears on the display, see "Compact Disc Messages" later in this section.

◀ **RW (Rewind):** Press and hold the left arrow to reverse the compact disc. Release it to return to playing speed.

FF ▶▶ **(Fast Forward):** Press and hold the right arrow to fast forward to another part of the compact disc. Release it to return to playing speed.

⏮ **TUNE SEEK** ⏭: Press the up or the down arrow to seek to the next or to the previous track.

SCAN: Press this button to listen to tracks for a few seconds. The compact disc will go to a track, play for a few seconds, then go on to the next track. Press this button again to stop scanning.

⏏ **(Eject):** Press this button, located to the right of the CD slot, to stop a CD when it is playing or to eject a CD when it is not playing. Eject may be activated with the radio off and/or the ignition off.

Compact Disc Messages

If the disc comes out, it could be for one of the following reasons:

- You're driving on a very rough road. When the road becomes smoother, the disc should play.
- It's very hot. When the temperature returns to normal, the disc should play.
- The disc is dirty, scratched, wet or upside down.
- The air is very humid. If so, wait about an hour and try again.
- There may have been a problem while burning the CD.
- The label may be caught in the CD player.

If the CD is not playing correctly, for any other reason, try a known good CD.

If any error occurs repeatedly or if an error can't be corrected, contact your dealer.

Radio with Cassette and CD (Up Level)



Radio Data System (RDS)

Your audio system is equipped with a Radio Data System (RDS). RDS features are available for use only on FM stations that broadcast RDS information.

With RDS, your radio can do the following:

- Seek to stations broadcasting the selected type of programming,
- receive announcements concerning local and national emergencies,
- display messages from radio stations, and
- seek to stations with traffic announcements.

This system relies upon receiving specific information from these stations and will only work when the information is available. In rare cases, a radio station may broadcast incorrect information that will cause the radio features to work improperly. If this happens, contact the radio station.

While you are tuned to an RDS station, the station name or the call letters will appear on the display instead of the frequency. RDS stations may also provide the time of day, a program type (PTY) for current programming and the name of the program being broadcast.

XM™ Radio Satellite Service (USA Only)

XM™ is a continental U.S. based satellite radio service that offers 100 coast to coast channels including music, news, sports, talk and children's programming. XM™ provides digital quality audio and text information, including song title and artist name. A service fee is required in order to receive the XM™ service. For more information, contact XM™ at www.xmradio.com or call 1-800-852-XXM (9696).

Playing the Radio

PWR (Power): Press this knob to turn the system on and off.

VOL (Volume): Turn this knob to increase or to decrease volume.

AVC (Automatic Volume Control): With AVC, your audio system monitors the noise in the vehicle. Then, AVC adjusts the volume level so that it always sounds the same to you.

To use AVC, press and hold the TONE button until AUTO VOLUME CONTROL OFF appears on the display. Then press the LEVEL plus symbol. AUTO VOLUME CONTROL ON will appear on the display. AVC VOLUME will appear on the display any time you adjust the volume while AVC is on. To turn AVC off, press and hold the TONE button until AUTO VOLUME CONTROL ON appears on the display. Then press the LEVEL minus symbol. AUTO VOLUME CONTROL OFF will appear on the display.

HR (Hour) or MN (Minute): Display the time with the ignition off by pressing one of these buttons.

SOURCE: Press this button to select a source, either cassette or compact disc. The audio source must be loaded to play. Available loaded sources are shown on the display. If a source is being used, it will be underlined on the display. If none of the audio sources are loaded, NO SOURCE LOADED will appear on the display. Press this button again or press BAND to switch back to the radio.

Finding a Station

BAND: Press this button to select weather, FM1, FM2, AM, or XM1, XM2 (USA only, if equipped).

↶ TUNE SEEK ↷: This button can be pressed to two positions. Press this button to the first position to manually tune to the next or to the previous stations. If this button is held at the first position for a few seconds, the radio will continue tuning until this button is released.

Press this button to the second position and release it to seek to the next or to the previous radio station.

The radio will seek only to stations that are in the selected band and only to those with a strong signal.

SCAN: Press this button for less than two seconds to scan radio stations. The radio will go to a station, play for five seconds, then go on to the next station. Press this button again to stop scanning.

To scan preset stations, press and hold SCAN for more than two seconds until you hear a beep. The radio will go to the first preset station stored on your pushbuttons, play for five seconds, then go on to the next preset station. Press SCAN again to stop scanning presets.

The radio will scan only to the stations that are in the selected band and only to those with a strong signal.

Setting Preset Stations

The six numbered pushbuttons let you return to your favorite stations and associated tone and DSP settings. The RDS PTY mode must be off to use this mode. You can set up to 36 stations (six weather, six FM1, six FM2, six AM, six XM1 and six XM2 (USA only, if equipped)), by performing the following steps:

1. Turn the radio on.
2. Press BAND to select weather, FM1, FM2, AM, or XM1, XM2.
3. Tune in the desired station.
4. Press and hold one of the six numbered pushbuttons for more than two seconds. Whenever you press that numbered pushbutton for less than two seconds, the station you set will return.
5. Repeat the steps for each pushbutton.

When battery power is removed and later applied, you will not have to reset your radio presets because the radio remembers them.

Setting the Tone (Bass/Treble)

TONE: Press and release this button until the desired tone BASS, TREBLE or MIDRANGE appears on the display. The radio keeps separate tone settings for each band, preset (except weather band presets) and source.

– **LEVEL +:** After selecting the desired tone control, press the plus or minus symbol on this button to select the desired level.

To save the tone settings for your presets, press and hold the numbered button for the desired preset for more than two seconds until you hear a beep.

Adjusting the Speakers (Balance/Fade)

TONE: Press and release this button until BALANCE or FADE appears on the display.

– **LEVEL +:** After selecting the desired control, press the plus or minus symbol on this button to select the desired level.

To save the tone settings for your presets, press and hold the numbered pushbutton for the desired preset for more than two seconds until you hear a beep.

Using Digital Signal Processing (DSP)

DSP: This feature is used to provide a choice of four different listening experiences: talk, front seat, ambience and spacious. DSP can be used while listening to the radio, cassette, CD, or XM™. Press this button to turn DSP on. Press and release this button until the desired selection appears on the display. To turn DSP off, press and hold this button until DSP OFF appears on the display. When DSP OFF is displayed, the system will provide the best overall audio performance. The radio keeps separate DSP settings for each band (except weather band, which is always set to talk), preset and source.

TALK: This setting should be used when listening to non-musical material such as news, talk shows, sports broadcasts and books on tape. TALK makes spoken words sound very clear.

FRONT SEAT: This setting adjusts the audio to give the driver the best possible sound qualities. Front Seat can be used at any time for any material. Rear seat passengers in the vehicle may not get the same effect.

AMBIENCE: This setting is used to enhance the stereo effect.

SPACIOUS: This setting is used to make the listening space seem larger.

RDS Messages

ALERT!: Alert warns of local or continental U.S.-based emergencies. When an alert announcement comes on the current radio station or a related network station, you will hear it, even if the volume is muted, a cassette tape or compact disc is playing, or if RDS mode is turned off. ALERT will appear on the display when an alert announcement plays. The radio uses TA volume during these announcements. To increase or to decrease volume, turn the PWR/VOL knob. TA VOLUME will appear on the display while the volume is being adjusted. If the radio tunes to a related network station for an alert announcement, it will return to the original station when the announcement is finished. If the cassette tape or compact disc player is playing, play will stop during the announcement. You will not be able to turn off alert announcements.

TA (Traffic): If TA appears on the display, the tuned station broadcasts traffic announcements and when a traffic announcement comes on the tuned radio station you will hear it.

If the current tuned station does not broadcast traffic announcements, press this button and the radio will seek to a station that does. When the radio finds a station that broadcasts traffic announcements, it will stop and TA will be displayed. When a traffic announcement comes on the tuned radio station you will hear it. If no station is found, NO TRAFFIC STATION FOUND will appear on the display.

If TA is on the display you can press the TA button to turn of the traffic announcements.

Your radio will play the traffic announcement even if the volume is muted or interrupt the play of a cassette tape or CD if the last tuned station broadcasts traffic announcements.

This function does not apply to XM™ Satellite Radio Service.

MSG (Message): If the current station has a message, MSG will appear on the display. Press the MSG button, to see the message. If the whole message does not appear on the display, parts of the message will appear every three seconds until the message is completed. To see the parts of the message faster than every three seconds, press the MSG button repeatedly. A new group of words will appear on the display with each press. Once the complete message has been displayed, MSG will disappear from the display until another new MSG is received.

For XM™ (USA only, if equipped), press this button while in XM mode to retrieve various pieces of information related to the current song or channel. By pressing and releasing the MSG button, you may retrieve four different categories of information: Artist Name/Feature, Song/Program Title, Channel Category that may be broadcast on that channel.

Each of the four information types may have multiple pages of text. To reach a category, press and release the MSG button consecutively until the desired type is displayed. If there are multiple pages of text for the information selected type, the radio will automatically display all the pages for that type at a rate of approximately one page every three seconds before timing out and returning to the default display. You may override this feature by pressing the MSG button to review all of the pages at your own pace.

Finding a PTY Station (RDS and XM™)

To select and find a desired PTY perform the following:

1. Press PTY. PTY will be displayed on the screen.
2. Select a category by pressing – LEVEL +.
3. Once the desired category is displayed, press TUNE/SEEK to select the category and take you to the category's first station.
4. If you want to go to another station within that category, press TUNE/SEEK once to display the category, then press TUNE/SEEK again to go to another station.
5. If PTY times out and is no longer on the display, go back to Step 1.

SCAN: You can also scan through the channels within a category by performing the following:

1. Press PTY. PTY will be displayed on the screen.
2. Select a category by pressing – LEVEL +.
3. Once the desired category is displayed, press SCAN, and the radio will begin scanning within your chosen category.
4. Press SCAN again to stop at a particular section.

XM™ Radio Messages

| Radio Display Message | Condition | Action Required |
|---------------------------------|--------------------------------------------------------------------------------------------|------------------------------------------------------------------------------------------------------------------------------------------------------------------------------------------|
| XL (Explicit Language Channels) | XL on the radio display, after the channel name, indicates content with explicit language. | These channels, or any others, can be blocked at a customer's request, by calling 1-800-852-XXXM (9696). |
| XM Updating | Updating encryption code | The encryption code in your receiver is being updated, and no action is required. This process should take no longer than 30 seconds. |
| No XM signal | Loss of signal | Your system is functioning correctly, but you are in a location that is blocking the XM signal. When you move into an open area, the signal should return. |
| Loading XM | Acquiring channel audio (after 4 second delay) | Your radio system is acquiring and processing audio and text data. No action is needed. This message should disappear shortly. |
| Channel Off Air | Channel not in service | This channel is not currently in service. Tune in to another channel. |
| Channel Unavail | Channel no longer available | This previously assigned channel is no longer assigned. Tune to another station. If this station was one of your presets, you may need to choose another station for that preset button. |
| No Artist Info | Artist Name/Feature not available | No artist information is available at this time on this channel. Your system is working properly. |
| No Title Info | Song/Program Title not available | No song title information is available at this time on this channel. Your system is working properly. |

XM™ Radio Messages (cont'd)

| Radio Display Message | Condition | Action Required |
|-----------------------|---------------------------------------------------------|---------------------------------------------------------------------------------------------------------------------------------------------------------------------------------------------------------------------------------------------------------|
| No CAT Info | Category Name not available | No category information is available at this time on this channel. Your system is working properly. |
| Not Found | No channel available for the chosen category | There are no channels available for the category you selected. Your system is working properly. |
| No Information | No Text/Informational message available | No text or informational messages are available at this time on this channel. Your system is working properly. |
| XM Theftlocked | Theft lock active | The XM receiver in your vehicle may have previously been in another vehicle. For security purposes, XM receivers cannot be swapped between vehicles. If you receive this message after having your vehicle serviced, check with the servicing facility. |
| XM Radio ID | Radio ID label (channel 0) | If you tune to channel 0, you will see this message alternating with your XM Radio 8 digit radio ID label. This label is needed to activate your service. |
| Unknown | Radio ID not known (should only be if hardware failure) | If you receive this message when you tune to channel 0, you may have a receiver fault. Consult with your dealer. |
| Check XM Receiver | Hardware failure | If this message does not clear within a short period of time, your receiver may have a fault. Consult with your retail location. |

Playing a Cassette Tape

With the radio on, insert a cassette tape. The tape will begin playing as soon as it is inserted. When one side of your cassette tape is done playing, auto reverse plays the other side of your cassette tape. A cassette tape may be loaded with the radio off but it will not start playing until the radio is on. If you want to insert a cassette tape when the ignition is off, first press the eject button.

While the tape is playing, use the VOL, TONE, LEVEL and DSP controls just as you do for the radio. Other controls may have different functions when a tape is inserted. The display will show an underlined tape symbol. TAPE PLAY will appear on the display when a tape is playing, with an arrow to indicate which side of the tape is playing.

If an error appears on the display, see "Cassette Tape Messages" later in this section.

1 PREV (Previous): Your tape must have at least three seconds of silence between each selection for previous to work. Press this pushbutton to seek to the previous selection on the tape.

2 NEXT: Your tape must have at least three seconds of silence between each selection for next to work. Press this pushbutton to seek to the next selection on the tape.

3 << RW (Rewind): Press this pushbutton to rewind the tape rapidly. The radio will play while the tape rewinds. Press RW again to return to playing speed.

4 FF >> (Fast Forward): Press this pushbutton to fast forward to another part of the tape. The radio will play while the tape advances. Press FF again to return to playing speed.

↖ SEEK ↙: Your tape must have at least three seconds of silence between each selection for the SEEK arrows to work. Press the up or the down arrow to seek to the next or to the previous selection on the tape.

SCAN: Press this button to listen to selections for a few seconds. The tape will go to a selection, play for a few seconds, then go on to the next selection. Press this button again to stop scanning.

SIDE: Press this button to play the other side of the tape.

△ (Eject): Press this button, located to the right of the cassette tape slot to stop a tape when it is playing or to eject a tape when it is not playing. Eject may be activated with the radio off and/or the ignition off.

Cassette Tape Messages

If an error occurs while trying to play a cassette tape, it could be one of the following has occurred:

- The cassette tape is tight and the cassette player cannot turn the hubs of the tape. Hold the cassette tape with the open end down and try turning the right hub counterclockwise with a pencil. Flip the tape over and repeat. If the hubs do not turn easily, your cassette tape may be damaged and should not be used in the player. Try a new tape to be sure your player is working properly.
- The cassette tape is broken. (Check to see if your tape is broken. Try a new tape.)

CLEAN TAPE: If this message appears on the display, the cassette tape player needs to be cleaned. It will still play tapes, but you should clean it as soon as possible to prevent damage to the tapes and player. See *Care of Your Cassette Tape Player on page 3-104*.

If any error occurs repeatedly or if an error can't be corrected, contact your dealer.

Your cassette tape player automatically reduces background noise. Dolby® Noise Reduction is manufactured under a license from Dolby® Laboratories Licensing Corporation. Dolby® and the double-D symbol are trademarks of Dolby® Laboratories Licensing Corporation.

Auto CrO2 allows the cassette tape player to adjust to the type of cassette tape for clearer sound for CrO2 cassette tapes.

Playing a Compact Disc

Insert a disc partway into the slot, label side up. The player will pull it in. If the ignition and the radio are on and the underlined compact disc symbol appears on the display, the disc will begin playing. A compact disc may be loaded with the radio off but it will not start playing until the radio is on. If you want to insert a disc when the ignition is off, first press the eject button.

The integral CD player can play the smaller 8 cm compact discs. Full-size compact discs and the smaller compact discs are loaded in the same manner.

If playing a CD-R the sound quality may be reduced due to CD-R quality, the method of recording, the quality of the music that has been recorded and the way the CD-R has been handled. You may experience an increase in skipping, difficulty in finding tracks and/or difficulty in loading and ejecting. If these problems occur try a known good CD.

Do not add paper labels to discs, they could get caught in the CD player.

Do not play 3 inch discs without a standard adapter disc.

If an error appears on the display, see “Compact Disc Messages” later in this section.

1 PREV (Previous): Press this pushbutton to seek to the previous track on the compact disc.

2 NEXT: Press this pushbutton to seek to the next track on the compact disc.

3 ⏪ RW (Rewind): Press this pushbutton to reverse the compact disc. Release it to return to playing speed.

4 FF ⏩ (Fast Forward): Press this pushbutton to fast forward to another part of the compact disc. Release it to return to playing speed.

6 RDM (Random): Press this pushbutton to listen to the tracks in random instead of sequential order. RDM will appear on the display. Press RDM to turn off random play. RDM will disappear from the display.

⏮ SEEK ⏭: Press the up or the down arrow to seek to the next or to the previous track.

SIDE: Press this pushbutton to play a CD when listening to the radio.

SCAN: Press this button to listen to tracks for a few seconds. The compact disc will go to a track, play for a few seconds, then go on to the next track. Press this button again to stop scanning.

⏏ (Eject): Press this button, located to the right of the CD slot, to stop a CD when it is playing or to eject a CD when it is not playing. Eject may be activated with the radio off and/or the ignition off.

Compact Disc Messages

If the disc comes out, it could be for one of the following reasons:

- You're driving on a very rough road. When the road becomes smoother, the disc should play.
- It's very hot. When the temperature returns to normal, the disc should play.
- The disc is dirty, scratched, wet or upside down.
- The air is very humid. If so, wait about an hour and try again.
- There may have been a problem while burning the CD.
- The label may be caught in the CD player.

If the CD is not playing correctly, for any other reason, try a known good CD.

If any error occurs repeatedly or if an error can't be corrected, contact your dealer.

Navigation/Radio System



Navigation/Radio Display and Controls

The display screen is located in the center of the instrument panel. There are “hard” buttons and a touch sensitive screen.

Your vehicle may be equipped with an AM-FM radio navigation system that includes digital signal processing (DSP), a radio data system (RDS) with program “type” selections (PTY) that will seek out the kind of music you want to listen to. The radio system can also communicate with your navigation system to broadcast announcements on traffic, weather, and emergency alert communications. For information on how to use this system, see the “Navigation System” manual.

Console-Mounted CD Changer

With the compact disc changer, you can play up to six discs continuously. Normal size discs may be played using the trays supplied in the magazine. The smaller discs (8 cm) can be played only with specially designed trays.



You must first load the magazine with discs before you can play a compact disc. Each of the six trays holds one disc. Load the trays from bottom to top, placing a disc in the tray label side up. If you load a disc label side down, the disc will not play and an error will occur. Repeat this procedure for loading up to 6 discs in the magazine.



Once you have loaded the discs in the magazine, slide open the door of the compact disc (CD) changer. Push the magazine into the changer in the direction of the arrow marked on top of the magazine.



Close the door by sliding it all the way to the right. When the door is closed, the changer will begin checking for discs in the magazine. This will continue for up to one and a half minutes, depending on the number of discs loaded.

Whenever a CD magazine with discs is loaded in the changer, the CD changer symbol will appear on the radio display. If the CD changer is checking the magazine for CDs, the CD symbol will flash on the display until the changer is ready to play.

When a CD begins playing, a disc and track number will be displayed. The disc numbers are listed on the front of the magazine.

Features of CD changer may be different due to your vehicle's audio system.

1 PREV (Previous)/⏮ TUNE SEEK ⏭: Press this pushbutton to seek to the previous track on the CD. If playing the first track of the CD, pressing the PREV pushbutton will seek to the last track of the CD.

2 NEXT/⏭ TUNE SEEK ⏮: Press this pushbutton to seek to the next track on the CD. If playing last track of the CD, pressing the NEXT pushbutton will seek to the first track of the CD.

3 ⏮ RW (Rewind)/⏮ RW (Rewind): Press and hold this pushbutton to reverse quickly through a track.

4 FF ⏭ (Fast Forward)/FF ⏭ (Fast Forward): Press and hold this pushbutton to advance quickly through a track.

5 DISC: Press this pushbutton to select the next disc in the changer. Each time you press this button, **LOADING** will appear on the display and the disc number on the radio display will go to that of the next available CD.

6 RDM (Random): Press this pushbutton to hear the tracks in random, rather than sequential, order. RDM will appear on the display. Press the PREV or NEXT pushbuttons while RDM is on the display to randomly seek through discs. Press RDM again to turn off random play. This feature may not be available on your radio.

SCAN: Press this button. You will hear the first few seconds of the first track on each disc. The CD will mute while scanning and SCAN will appear on the display. Press this button again to stop scanning.

SOURCE: Press this button if you have a disc loaded in the changer and the radio is on, to play a compact disc. To return to playing the radio, press BAND. Pressing source also switches between a tape or compact disc if both are loaded.

EJECT: Slide the CD changer door all the way open. Press the EJECT button and the magazine will eject.

Compact Disc Changer Errors

CD CHANGER ERROR: This message may be displayed for one of the following reasons:

- You're driving on a very rough road. When the road becomes smoother, the disc should play.
- The disc is dirty, scratched, wet or loaded label side up.
- The air is very humid. If so, wait about an hour and try again.

If any error occurs repeatedly or if an error cannot be corrected, contact your dealership. If your radio displays an error number, write it down and provide this information to your dealership when reporting the problem.

Radio Personalization with Home and Away Feature

If DRIVER 1 (HOME or AWAY) PRESETS or DRIVER 2 (HOME or AWAY) PRESETS appears in the display when the radio is first turned on, your vehicle is equipped with this feature.

This feature allows the driver to return to the last used audio source (radio, cassette, or CD) using the remote keyless entry transmitter. This feature can also store and recall AM and FM presets, volume, tone, and the last selected radio station. The number on the back of each transmitter (1 or 2) corresponds to driver 1 or 2. If transmitter 1 is used to enter the vehicle, the last used audio source and/or settings set by driver 1 will be recalled. If transmitter 2 is used to enter the vehicle, the last used audio source and/or settings set by driver 2 will be recalled. The settings can also be recalled by pressing the MEMORY seat buttons 1 or 2 located on the driver's door.

Your radio can store home and away presets. Home and away presets allow you to use one set of preset radio settings in the area where you live, and another set when you go out of town. You will not need to reprogram your presets every time you travel. With the radio off and the time displayed, use fast forward and reverse to select home or away presets. To select

the away presets, press and hold FF for five seconds until you hear a beep. The next time the radio comes on, the away presets will be active. To select the home presets, press and hold RW for five seconds until you hear a beep. The next time the radio comes on, the home presets will be active.

When battery power is removed and later applied, you will not have to reset your home radio presets because the radio remembers them. However, you will have to reset your away radio presets.

Theft-Deterrent Feature

THEFTLOCK® is designed to discourage theft of your radio. Your vehicle has a “built in” theft-deterrent feature on each radio that is automatic – there is no programming required. The radio in your vehicle cannot be used in any other vehicle. When the radio was originally installed in your vehicle at the factory, it stored the Vehicle Identification Number (VIN). Each time the ignition is turned on, the VIN is verified. If the vehicle's VIN does not match the VIN stored in the radio, THEFTLOCK® will be activated and the audio system will not play. If the radio is removed from your vehicle, the original VIN in the radio can be used to trace the radio back to your vehicle.

Audio Steering Wheel Controls



Some audio controls can be adjusted at the steering wheel. They include the following:

^ VOL v (Volume): Press the up or the down arrows to increase or to decrease volume.

^ SEL v (Select): While listening to the radio or to a XMTM Satellite Radio Service station, press the up or the down arrows to tune to the next or the previous preset radio station. While listening to a cassette tape, these arrows can be used to SEEK forward and rearward through the tape. Pressing these arrows while listening to a CD will cause the player to go to the next or the previous track.

Understanding Radio Reception

AM

The range for most AM stations is greater than for FM, especially at night. The longer range, however, can cause stations to interfere with each other. AM can pick up noise from things like storms and power lines. Try reducing the treble to reduce this noise if you ever get it.

FM Stereo

FM stereo will give you the best sound, but FM signals will reach only about 10 to 40 miles (16 to 65 km). Tall buildings or hills can interfere with FM signals, causing the sound to come and go.

XMTM Satellite Radio Service (USA Only)

XMTM Satellite Radio Service gives you digital radio reception from coast to coast. Just as with FM, tall buildings or hills can interfere with satellite radio signals, causing the sound to come and go. Your radio may display NO XM SIGNAL to indicate interference.

Cellular Phone Usage

Cellular phone usage may cause interference with your vehicle's radio. This interference may occur when making or receiving phone calls, charging the phone's battery, or simply having the phone on. This interference is described as an increased level of static while listening to the radio. If you notice static while listening to the radio, unplug the cellular phone and turn it off.

Weather Band

Weather band is restricted to speech and the audio quality is not as good as with the AM or FM bands. Depending on location, the radio should receive one or two channels.

Care of Your Cassette Tape Player

A tape player that is not cleaned regularly can cause reduced sound quality, ruined cassettes or a damaged mechanism. Cassette tapes should be stored in their cases away from contaminants, direct sunlight and extreme heat. If they aren't, they may not operate properly or may cause failure of the tape player.

Your tape player should be cleaned regularly after every 50 hours of use. Your radio may display CLEAN TAPE to indicate that you have used your tape player for 50 hours without resetting the tape clean timer. If this message appears on the display, your cassette tape player needs to be cleaned. It will still play tapes, but you should clean it as soon as possible to prevent damage to your tapes and player. If you notice a reduction in sound quality, try a known good cassette to see if the tape or the tape player is at fault. If this other cassette has no improvement in sound quality, clean the tape player.

For best results, use a scrubbing action, non-abrasive cleaning cassette with pads which scrub the tape head as the hubs of the cleaner cassette turn. The recommended cleaning cassette is available through your dealership.

The broken tape detection feature of your cassette tape player may identify the cleaning cassette as a damaged tape, in error. To prevent the cleaning cassette from being ejected, use the following steps:

1. Turn the ignition on.
2. Turn the radio off.
3. Press and hold the SOURCE button for two seconds. The tape symbol on the display will flash three times.
4. Turn the radio on and insert the scrubbing action cleaning cassette.
5. Eject the cleaning cassette after the manufacturer's recommended cleaning time.

After the cleaning cassette is ejected, the broken tape detection feature will be active again.

You may also choose a non-scrubbing action, wet-type cleaner which uses a cassette with a fabric belt to clean the tape head. This type of cleaning cassette will not eject on its own. A non-scrubbing action cleaner may not clean as thoroughly as the scrubbing type cleaner. The use of a non-scrubbing action, dry-type cleaning cassette is not recommended.

After you clean the player, press and hold the eject button for five seconds to reset the CLEAN TAPE indicator. The radio will display CLEAN TAPE MSG CLEARED to show the indicator was reset.

Cassettes are subject to wear and the sound quality may degrade over time. Always make sure the cassette tape is in good condition before you have your tape player serviced.

Care of Your CDs

Handle CDs carefully. Store them in their original cases or other protective cases and away from direct sunlight and dust. If the surface of a CD is soiled, dampen a clean, soft cloth in a mild, neutral detergent solution and clean it, wiping from the center to the edge.

Be sure never to touch the side without writing when handling CDs. Pick up CDs by grasping the outer edges or the edge of the hole and the outer edge.

Care of Your CD Player

The use of CD lens cleaners for CDs is not advised, due to the risk of contaminating the lens of the CD optics with lubricants internal to the CD mechanism.

Diversity Antenna System

Your AM-FM antennas are located in the windshield and rear window. Be sure that the inside surfaces of the windshield and rear window are not scratched and that the lines on the glass are not damaged. If the inside surfaces are damaged, they could interfere with radio reception. Also, for proper radio reception, the antenna connector located on the passenger's side top corner of the windshield and the antenna connector located on the driver's side top corner of the rear window need to be properly attached to the buttons on the glass.

Notice: Do not apply aftermarket glass tinting with metallic film. The metallic film in some tinting materials will interfere with or distort the incoming radio reception. Any damage caused to your backglass antenna due to metallic tinting materials will not be covered by your warranty.

Notice: Do not try to clear frost or other material from the inside of the front windshield and rear window with a razor blade or anything else that is sharp. This may damage the rear window defogger grid and affect your radio's ability to pickup stations clearly. The repairs wouldn't be covered by your warranty.

If, when you turn on your rear window defogger, you hear static on your radio station, it could mean that a defogger grid line has been damaged. If this is true, the grid line must be repaired.

If you choose to add an aftermarket cellular telephone to your vehicle, and the antenna needs to be attached to the glass, be sure that you do not damage the grid lines for the AM-FM antennas or place the cellular telephone antenna over the grid lines.

XM™ Satellite Radio Antenna System (48 Contiguous US States)

Your XM™ Satellite Radio antenna is located on the roof of your vehicle. Keep this antenna clear of snow and ice build up for clear radio reception.

Section 4 Driving Your Vehicle

| | | | |
|-------------------------------------------------------|------|------------------------------------------------------|------|
| Your Driving, the Road, and Your Vehicle | 4-2 | City Driving | 4-21 |
| Defensive Driving | 4-2 | Freeway Driving | 4-22 |
| Drunken Driving | 4-3 | Before Leaving on a Long Trip | 4-23 |
| Control of a Vehicle | 4-6 | Highway Hypnosis | 4-24 |
| Braking | 4-6 | Hill and Mountain Roads | 4-24 |
| Traction Control System (TCS) | 4-9 | Winter Driving | 4-26 |
| Magnetic Ride Control | 4-11 | If You Are Stuck: In Sand, Mud, Ice or Snow | 4-30 |
| Steering | 4-11 | Towing | 4-31 |
| Off-Road Recovery | 4-14 | Towing Your Vehicle | 4-31 |
| Passing | 4-14 | Recreational Vehicle Towing | 4-31 |
| Loss of Control | 4-16 | Loading Your Vehicle | 4-33 |
| Driving at Night | 4-17 | Towing a Trailer | 4-35 |
| Driving in Rain and on Wet Roads | 4-18 | | |

Your Driving, the Road, and Your Vehicle

Defensive Driving

The best advice anyone can give about driving is: Drive defensively.

Please start with a very important safety device in your vehicle: Buckle up. See *Safety Belts: They Are for Everyone* on page 1-6.

Defensive driving really means “be ready for anything.” On city streets, rural roads or freeways, it means “always expect the unexpected.”

Assume that pedestrians or other drivers are going to be careless and make mistakes. Anticipate what they might do. Be ready for their mistakes.

Rear-end collisions are about the most preventable of accidents. Yet they are common. Allow enough following distance. It is the best defensive driving maneuver, in both city and rural driving. You never know when the vehicle in front of you is going to brake or turn suddenly.

Defensive driving requires that a driver concentrate on the driving task. Anything that distracts from the driving task — such as concentrating on a cellular telephone call, reading, or reaching for something on the floor — makes proper defensive driving more difficult and can even cause a collision, with resulting injury. Ask a passenger to help do things like this, or pull off the road in a safe place to do them yourself. These simple defensive driving techniques could save your life.

Drunken Driving

Death and injury associated with drinking and driving is a national tragedy. It is the number one contributor to the highway death toll, claiming thousands of victims every year.

Alcohol affects four things that anyone needs to drive a vehicle:

- Judgment
- Muscular Coordination
- Vision
- Attentiveness.

Police records show that almost half of all motor vehicle-related deaths involve alcohol. In most cases, these deaths are the result of someone who was drinking and driving. In recent years, more than 16,000 annual motor vehicle-related deaths have been associated with the use of alcohol, with more than 300,000 people injured.

Many adults — by some estimates, nearly half the adult population — choose never to drink alcohol, so they never drive after drinking. For persons under 21, it is against the law in every U.S. state to drink alcohol. There are good medical, psychological and developmental reasons for these laws.

The obvious way to eliminate the leading highway safety problem is for people never to drink alcohol and then drive. But what if people do? How much is “too much” if someone plans to drive? It is a lot less than many might think. Although it depends on each person and situation, here is some general information on the problem.

The Blood Alcohol Concentration (BAC) of someone who is drinking depends upon four things:

- The amount of alcohol consumed
- The drinker’s body weight
- The amount of food that is consumed before and during drinking
- The length of time it has taken the drinker to consume the alcohol.

According to the American Medical Association, a 180 lb (82 kg) person who drinks three 12 ounce (355 ml) bottles of beer in an hour will end up with a BAC of about 0.06 percent. The person would reach the same BAC by drinking three 4 ounce (120 ml) glasses of wine or three mixed drinks if each had 1-1/2 ounces (45 ml) of liquors like whiskey, gin or vodka.



It is the amount of alcohol that counts. For example, if the same person drank three double martinis (3 ounces or 90 ml of liquor each) within an hour, the person's BAC would be close to 0.12 percent. A person who consumes food just before or during drinking will have a somewhat lower BAC level.

There is a gender difference, too. Women generally have a lower relative percentage of body water than men. Since alcohol is carried in body water, this means that a woman generally will reach a higher BAC level than a man of her same body weight will when each has the same number of drinks.

The law in an increasing number of U.S. states, and throughout Canada, sets the legal limit at 0.08 percent. In some other countries, the limit is even lower. For example, it is 0.05 percent in both France and Germany. The BAC limit for all commercial drivers in the United States is 0.04 percent.

The BAC will be over 0.10 percent after three to six drinks (in one hour). Of course, as we have seen, it depends on how much alcohol is in the drinks, and how quickly the person drinks them.

But the ability to drive is affected well below a BAC of 0.10 percent. Research shows that the driving skills of many people are impaired at a BAC approaching 0.05 percent, and that the effects are worse at night. All drivers are impaired at BAC levels above 0.05 percent. Statistics show that the chance of being in a collision increases sharply for drivers who have a BAC of 0.05 percent or above. A driver with a BAC level of 0.06 percent has doubled his or her chance of having a collision. At a BAC level of 0.10 percent, the chance of this driver having a collision is 12 times greater; at a level of 0.15 percent, the chance is 25 times greater!

The body takes about an hour to rid itself of the alcohol in one drink. No amount of coffee or number of cold showers will speed that up. "I will be careful" is not the right answer. What if there is an emergency, a need to take sudden action, as when a child darts into the street? A person with even a moderate BAC might not be able to react quickly enough to avoid the collision.

There is something else about drinking and driving that many people do not know. Medical research shows that alcohol in a person's system can make crash injuries worse, especially injuries to the brain, spinal cord or heart. This means that when anyone who has been drinking — driver or passenger — is in a crash, that person's chance of being killed or permanently disabled is higher than if the person had not been drinking.

 **CAUTION:**

Drinking and then driving is very dangerous. Your reflexes, perceptions, attentiveness and judgment can be affected by even a small amount of alcohol. You can have a serious — or even fatal — collision if you drive after drinking. Please do not drink and drive or ride with a driver who has been drinking. Ride home in a cab; or if you are with a group, designate a driver who will not drink.

Control of a Vehicle

You have three systems that make your vehicle go where you want it to go. They are the brakes, the steering and the accelerator. All three systems have to do their work at the places where the tires meet the road.

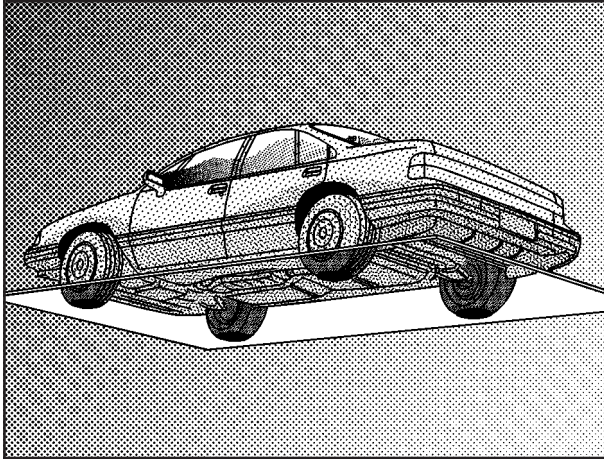

Sometimes, as when you are driving on snow or ice, it is easy to ask more of those control systems than the tires and road can provide. That means you can lose control of your vehicle. Also see *Traction Control System (TCS)* on page 4-9.

Braking

Braking action involves *perception time* and *reaction time*.

First, you have to decide to push on the brake pedal. That's *perception time*. Then you have to bring up your foot and do it. That's *reaction time*.

Average *reaction time* is about 3/4 of a second. But that's only an average. It might be less with one driver and as long as two or three seconds or more with another. Age, physical condition, alertness, coordination and eyesight all play a part. So do alcohol, drugs and frustration. But even in 3/4 of a second, a vehicle moving at 60 mph (100 km/h) travels 66 feet (20 m). That could be a lot of distance in an emergency, so keeping enough space between your vehicle and others is important.

And, of course, actual stopping distances vary greatly with the surface of the road (whether it's pavement or gravel); the condition of the road (wet, dry, icy); tire tread; the condition of your brakes; the weight of the vehicle and the amount of brake force applied.

Avoid needless heavy braking. Some people drive in spurts — heavy acceleration followed by heavy braking — rather than keeping pace with traffic. This is a mistake. Your brakes may not have time to cool between hard stops. Your brakes will wear out much faster if you do a lot of heavy braking. If you keep pace with the traffic and allow realistic following distances, you will eliminate a lot of unnecessary braking. That means better braking and longer brake life.

If your engine ever stops while you're driving, brake normally but don't pump your brakes. If you do, the pedal may get harder to push down. If your engine stops, you will still have some power brake assist. But you will use it when you brake. Once the power assist is used up, it may take longer to stop and the brake pedal will be harder to push.

Anti-lock Brake System (ABS)

Your vehicle has anti-lock brakes. ABS is an advanced electronic braking system that will help prevent a braking skid.

When you start your engine and begin to drive away, your anti-lock brake system will check itself. You may hear a momentary motor or clicking noise while this test is going on, and you may even notice that your brake pedal moves a little. This is normal.

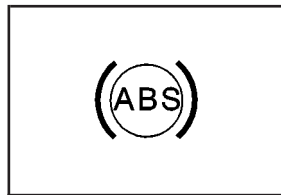

If there's a problem with the anti-lock brake system, this warning light will stay on. See *Anti-Lock Brake System Warning Light* on page 3-44.



Let's say the road is wet and you're driving safely. Suddenly, an animal jumps out in front of you. You slam on the brakes and continue braking. Here's what happens with ABS:

A computer senses that wheels are slowing down. If one of the wheels is about to stop rolling, the computer will separately work the brakes at each front wheel and at both rear wheels.

The anti-lock system can change the brake pressure faster than any driver could. The computer is programmed to make the most of available tire and road conditions. This can help you steer around the obstacle while braking hard.



As you brake, your computer keeps receiving updates on wheel speed and controls braking pressure accordingly.

Remember: Anti-lock doesn't change the time you need to get your foot up to the brake pedal or always decrease stopping distance. If you get too close to the vehicle in front of you, you won't have time to apply your brakes if that vehicle suddenly slows or stops. Always leave enough room up ahead to stop, even though you have anti-lock brakes.

Using Anti-Lock

Don't pump the brakes. Just hold the brake pedal down firmly and let anti-lock work for you. You may hear the anti-lock pump or motor operate, and feel the brake pedal pulsate, but this is normal.

Braking in Emergencies

With anti-lock, you can steer and brake at the same time. In many emergencies, steering can help you more than even the very best braking.

Traction Control System (TCS)

Your vehicle has a traction control system that limits wheel spin. This is especially useful in slippery road conditions. The system operates only if it senses that one or both of the front wheels are spinning or beginning to lose traction. When this happens, the system works the front brakes and reduces engine power to limit wheel spin.

The TRACTION ENGAGED message will display on the Driver Information Center when the traction control system is limiting wheel spin. See *DIC Warnings and Messages on page 3-56*. You may feel or hear the system working, but this is normal.

If your vehicle is in cruise control when the traction control system begins to limit wheel spin, the cruise control will automatically disengage. When road conditions allow you to safely use it again, you may reengage the cruise control. See "Cruise Control" under *Turn Signal/Multifunction Lever on page 3-9*.



United States

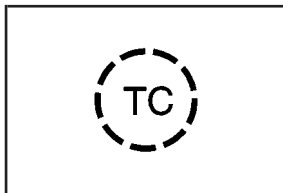

Canada

This warning light will come on to let you know if there's a problem with your traction control system.

See *Traction Control System (TCS) Warning Light on page 3-45*. When this warning light is on, the system will not limit wheel spin. Adjust your driving accordingly.

The traction control system automatically comes on whenever you start your vehicle. To limit wheel spin, especially in slippery road conditions, you should always leave the system on. But you can turn the traction control system off if you ever need to. You should turn the system off if your vehicle ever gets stuck in sand, mud or snow and rocking the vehicle is required. See "Rocking Your Vehicle To Get It Out" under *If You Are Stuck: In Sand, Mud, Ice or Snow on page 4-30*.



To turn the system off, press the TRAC ON/OFF button located on the center console.

The TRACTION OFF message will display on the Driver Information Center. If the system is limiting wheel spin when you press the button, the TRACTION OFF message will display – but the system won't turn off right away. It will wait until there's no longer a current need to limit wheel spin.

You can turn the system back on at any time by pressing the button again. The TRACTION READY message should display briefly on the Driver Information Center.

Magnetic Ride Control

Magnetic Ride Control automatically adjusts the ride of your vehicle. Automatic ride control is achieved through a computer used to control and monitor the suspension system. The controller receives input from various sensors to determine the proper system response. If the controller detects a problem within the system, the DIC will display a SERVICE SUSPENSION SYS message. See *DIC Warnings and Messages* on page 3-56 for more information. See your dealer for service.

Steering

Power Steering

If you lose power steering assist because the engine stops or the system is not functioning, you can steer but it will take much more effort.

Magnetic Speed Variable Assist Steering

Your vehicle may be equipped with a steering system that continuously adjusts the effort you feel when steering at all vehicle speeds. It provides ease when parking, yet a firm, solid feel at highway speeds.

Steering Tips Driving on Curves

It's important to take curves at a reasonable speed.

A lot of the "driver lost control" accidents mentioned on the news happen on curves. Here's why:

Experienced driver or beginner, each of us is subject to the same laws of physics when driving on curves. The traction of the tires against the road surface makes it possible for the vehicle to change its path when you turn the front wheels. If there's no traction, inertia will keep the vehicle going in the same direction. If you've ever tried to steer a vehicle on wet ice, you'll understand this.

The traction you can get in a curve depends on the condition of your tires and the road surface, the angle at which the curve is banked, and your speed. While you're in a curve, speed is the one factor you can control.

Suppose you're steering through a sharp curve. Then you suddenly accelerate. Both control systems — steering and acceleration — have to do their work where the tires meet the road. Adding the sudden acceleration can demand too much of those places. You can lose control. See *Traction Control System (TCS)* on page 4-9.

What should you do if this ever happens? Ease up on the accelerator pedal, steer the vehicle the way you want it to go, and slow down.

Since your vehicle is equipped with Stabilitrak[®] you may see the STABILITY SYS ENGAGED message on the Driver Information Center. See “Stability System Engaged Message” under *DIC Warnings and Messages* on page 3-56.

Speed limit signs near curves warn that you should adjust your speed. Of course, the posted speeds are based on good weather and road conditions. Under less favorable conditions you'll want to go slower.

If you need to reduce your speed as you approach a curve, do it before you enter the curve, while your front wheels are straight ahead.

Try to adjust your speed so you can “drive” through the curve. Maintain a reasonable, steady speed. Wait to accelerate until you are out of the curve, and then accelerate gently into the straightaway.

To help you steer in the direction you want to go, during certain sharp or sudden cornering maneuvers, gear selection is controlled. This will maximize the available drive wheel torque and minimize the transaxle response time and shift activity. During this kind of maneuver, the transaxle shifts automatically as vehicle speed changes.

Steering in Emergencies

There are times when steering can be more effective than braking. For example, you come over a hill and find a truck stopped in your lane, or a car suddenly pulls out from nowhere, or a child darts out from between parked cars and stops right in front of you. You can avoid these problems by braking — if you can stop in time. But sometimes you can't; there isn't room. That's the time for evasive action — steering around the problem.

Your vehicle can perform very well in emergencies like these. First apply your brakes.

See *Braking on page 4-6*. It is better to remove as much speed as you can from a possible collision. Then steer around the problem, to the left or right depending on the space available.

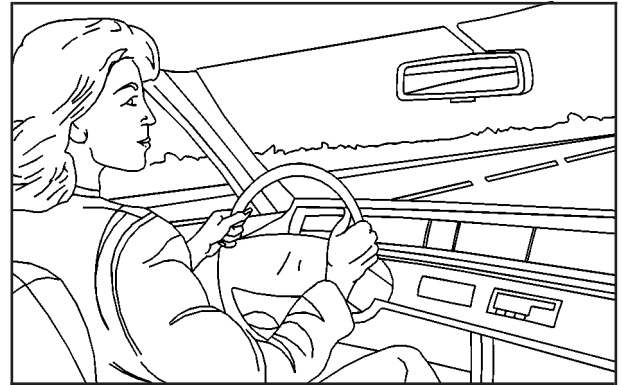

An emergency like this requires close attention and a quick decision. If you are holding the steering wheel at the recommended 9 and 3 o'clock positions, you can turn it a full 180 degrees very quickly without removing either hand. But you have to act fast, steer quickly, and just as quickly straighten the wheel once you have avoided the object.

The fact that such emergency situations are always possible is a good reason to practice defensive driving at all times and wear safety belts properly.

Off-Road Recovery

You may find that your right wheels have dropped off the edge of a road onto the shoulder while you're driving.

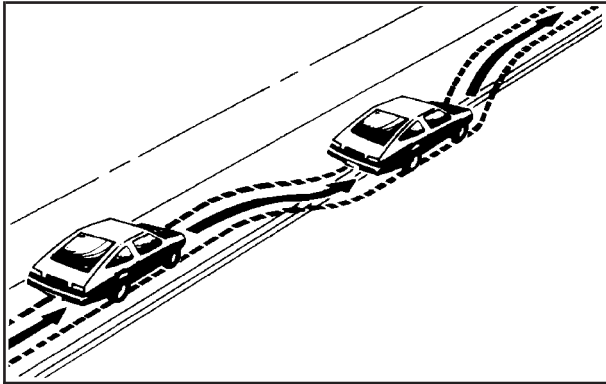

If the level of the shoulder is only slightly below the pavement, recovery should be fairly easy. Ease off the accelerator and then, if there is nothing in the way, steer so that your vehicle straddles the edge of the pavement. You can turn the steering wheel up to one-quarter turn until the right front tire contacts the pavement edge. Then turn your steering wheel to go straight down the roadway.

Passing

The driver of a vehicle about to pass another on a two-lane highway waits for just the right moment, accelerates, moves around the vehicle ahead, then goes back into the right lane again. A simple maneuver?

Not necessarily! Passing another vehicle on a two-lane highway is a potentially dangerous move, since the passing vehicle occupies the same lane as oncoming traffic for several seconds. A miscalculation, an error in judgment, or a brief surrender to frustration or anger can suddenly put the passing driver face to face with the worst of all traffic accidents — the head-on collision.

So here are some tips for passing:

- “Drive ahead.” Look down the road, to the sides and to crossroads for situations that might affect your passing patterns. If you have any doubt whatsoever about making a successful pass, wait for a better time.
- Watch for traffic signs, pavement markings and lines. If you can see a sign up ahead that might indicate a turn or an intersection, delay your pass. A broken center line usually indicates it's all right to pass (providing the road ahead is clear). Never cross a solid line on your side of the lane or a double solid line, even if the road seems empty of approaching traffic.

- Do not get too close to the vehicle you want to pass while you're awaiting an opportunity. For one thing, following too closely reduces your area of vision, especially if you're following a larger vehicle. Also, you won't have adequate space if the vehicle ahead suddenly slows or stops. Keep back a reasonable distance.
- When it looks like a chance to pass is coming up, start to accelerate but stay in the right lane and don't get too close. Time your move so you will be increasing speed as the time comes to move into the other lane. If the way is clear to pass, you will have a "running start" that more than makes up for the distance you would lose by dropping back. And if something happens to cause you to cancel your pass, you need only slow down and drop back again and wait for another opportunity.
- If other vehicles are lined up to pass a slow vehicle, wait your turn. But take care that someone isn't trying to pass you as you pull out to pass the slow vehicle. Remember to glance over your shoulder and check the blind spot.
- Check your mirrors, glance over your shoulder, and start your left lane change signal before moving out of the right lane to pass. When you are far enough ahead of the passed vehicle to see its front in your inside mirror, activate your right lane change signal and move back into the right lane. (Remember that your right outside mirror is convex. The vehicle you just passed may seem to be farther away from you than it really is.)
- Try not to pass more than one vehicle at a time on two-lane roads. Reconsider before passing the next vehicle.
- Don't overtake a slowly moving vehicle too rapidly. Even though the brake lamps are not flashing, it may be slowing down or starting to turn.
- If you're being passed, make it easy for the following driver to get ahead of you. Perhaps you can ease a little to the right.

Loss of Control

Let's review what driving experts say about what happens when the three control systems (brakes, steering and acceleration) don't have enough friction where the tires meet the road to do what the driver has asked.

In any emergency, don't give up. Keep trying to steer and constantly seek an escape route or area of less danger.

Skidding

In a skid, a driver can lose control of the vehicle. Defensive drivers avoid most skids by taking reasonable care suited to existing conditions, and by not "overdriving" those conditions. But skids are always possible.

The three types of skids correspond to your vehicle's three control systems. In the braking skid, your wheels aren't rolling. In the steering or cornering skid, too much speed or steering in a curve causes tires to slip and lose cornering force. And in the acceleration skid, too much throttle causes the driving wheels to spin.

A cornering skid is best handled by easing your foot off the accelerator pedal.

Remember: Any traction control system helps avoid only the acceleration skid. If your traction control system is off, then an acceleration skid is also best handled by easing your foot off the accelerator pedal.

If your vehicle starts to slide, ease your foot off the accelerator pedal and quickly steer the way you want the vehicle to go. If you start steering quickly enough, your vehicle may straighten out. Always be ready for a second skid if it occurs.

With Stabilitrak[®], you may see the STABILITY SYS ENGAGED message on the Driver Information Center. See "Stability Sys Engaged Message" under *DIC Warnings and Messages on page 3-56*.

Of course, traction is reduced when water, snow, ice, gravel or other material is on the road. For safety, you'll want to slow down and adjust your driving to these conditions. It is important to slow down on slippery surfaces because stopping distance will be longer and vehicle control more limited.

While driving on a surface with reduced traction, try your best to avoid sudden steering, acceleration or braking (including engine braking by shifting to a lower gear). Any sudden changes could cause the tires to slide. You may not realize the surface is slippery until your vehicle is skidding. Learn to recognize warning clues — such as enough water, ice or packed snow on the road to make a "mirrored surface" — and slow down when you have any doubt.

Remember: Any anti-lock brake system (ABS) helps avoid only the braking skid.

Driving at Night

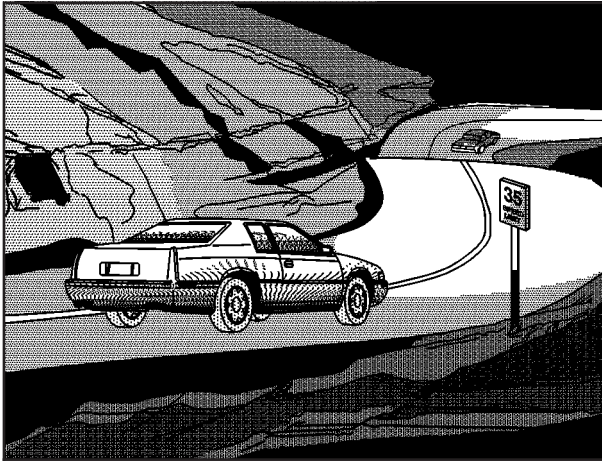

Night driving is more dangerous than day driving. One reason is that some drivers are likely to be impaired — by alcohol or drugs, with night vision problems, or by fatigue.

Here are some tips on night driving.

- Drive defensively.
- Don't drink and drive.
- Since you can't see as well, you may need to slow down and keep more space between you and other vehicles.
- Slow down, especially on higher speed roads. Your headlamps can light up only so much road ahead.
- In remote areas, watch for animals.
- If you're tired, pull off the road in a safe place and rest.

No one can see as well at night as in the daytime. But as we get older these differences increase. A 50-year-old driver may require at least twice as much light to see the same thing at night as a 20-year-old.

What you do in the daytime can also affect your night vision. For example, if you spend the day in bright sunshine you are wise to wear sunglasses. Your eyes will have less trouble adjusting to night. But if you're driving, don't wear sunglasses at night. They may cut down on glare from headlamps, but they also make a lot of things invisible.

You can be temporarily blinded by approaching headlamps. It can take a second or two, or even several seconds, for your eyes to readjust to the dark. When you are faced with severe glare (as from a driver who doesn't lower the high beams, or a vehicle with misaimed headlamps), slow down a little. Avoid staring directly into the approaching headlamps.

Keep your windshield and all the glass on your vehicle clean — inside and out. Glare at night is made much worse by dirt on the glass. Even the inside of the glass can build up a film caused by dust. Dirty glass makes lights dazzle and flash more than clean glass would, making the pupils of your eyes contract repeatedly.

Remember that your headlamps light up far less of a roadway when you are in a turn or curve. Keep your eyes moving; that way, it's easier to pick out dimly lighted objects. Just as your headlamps should be checked regularly for proper aim, so should your eyes be examined regularly. Some drivers suffer from night blindness — the inability to see in dim light — and aren't even aware of it.

Driving in Rain and on Wet Roads

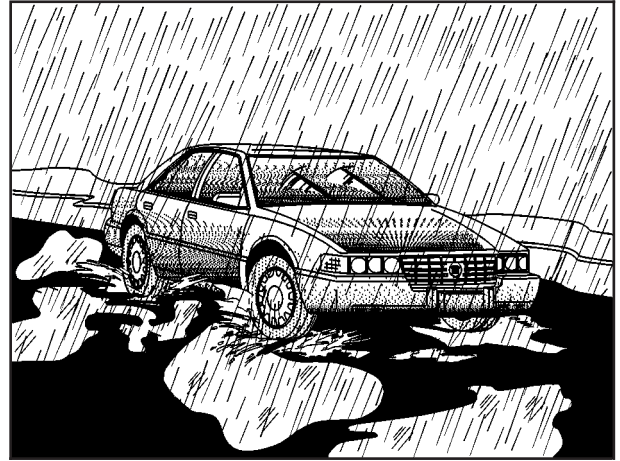

Rain and wet roads can mean driving trouble. On a wet road, you can't stop, accelerate or turn as well because your tire-to-road traction isn't as good as on dry roads. And, if your tires don't have much tread left, you'll get even less traction. It's always wise to go slower and be cautious if rain starts to fall while you are driving. The surface may get wet suddenly when your reflexes are tuned for driving on dry pavement.

The heavier the rain, the harder it is to see. Even if your windshield wiper blades are in good shape, a heavy rain can make it harder to see road signs and traffic signals, pavement markings, the edge of the road and even people walking.

It's wise to keep your windshield wiping equipment in good shape and keep your windshield washer tank filled with washer fluid. Replace your windshield wiper inserts when they show signs of streaking or missing areas on the windshield, or when strips of rubber start to separate from the inserts.

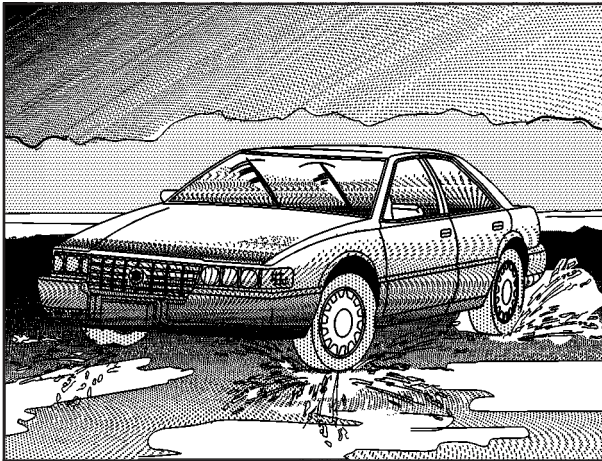

Driving too fast through large water puddles or even going through some car washes can cause problems, too. The water may affect your brakes. Try to avoid puddles. But if you can't, try to slow down before you hit them.

⚠ CAUTION:

Wet brakes can cause accidents. They will not work as well in a quick stop and may cause pulling to one side. You could lose control of the vehicle.

After driving through a large puddle of water or a car wash, apply your brake pedal lightly until your brakes work normally.

Hydroplaning

Hydroplaning is dangerous. So much water can build up under your tires that they can actually ride on the water. This can happen if the road is wet enough and you're going fast enough. When your vehicle is hydroplaning, it has little or no contact with the road.

Hydroplaning doesn't happen often. But it can if your tires do not have much tread or if the pressure in one or more is low. It can happen if a lot of water is standing on the road. If you can see reflections from trees, telephone poles or other vehicles, and raindrops "dimple" the water's surface, there could be hydroplaning.

Hydroplaning usually happens at higher speeds. There just isn't a hard and fast rule about hydroplaning. The best advice is to slow down when it is raining.

Driving Through Deep Standing Water

Notice: If you drive too quickly through deep puddles or standing water, water can come in through your engine's air intake and badly damage your engine. Never drive through water that is slightly lower than the underbody of your vehicle. If you can not avoid deep puddles or standing water, drive through them very slowly.

Driving Through Flowing Water

CAUTION:

Flowing or rushing water creates strong forces. If you try to drive through flowing water, as you might at a low water crossing, your vehicle can be carried away. As little as six inches of flowing water can carry away a smaller vehicle. If this happens, you and other vehicle occupants could drown. Do not ignore police warning signs, and otherwise be very cautious about trying to drive through flowing water.

Some Other Rainy Weather Tips

- Besides slowing down, allow some extra following distance. And be especially careful when you pass another vehicle. Allow yourself more clear room ahead, and be prepared to have your view restricted by road spray.
- Have good tires with proper tread depth. See *Tires on page 5-63*.

City Driving



One of the biggest problems with city streets is the amount of traffic on them. You'll want to watch out for what the other drivers are doing and pay attention to traffic signals.

Here are ways to increase your safety in city driving:

- Know the best way to get to where you are going. Get a city map and plan your trip into an unknown part of the city just as you would for a cross-country trip.
- Try to use the freeways that rim and crisscross most large cities. You'll save time and energy. See the next part, "Freeway Driving."
- Treat a green light as a warning signal. A traffic light is there because the corner is busy enough to need it. When a light turns green, and just before you start to move, check both ways for vehicles that have not cleared the intersection or may be running the red light.

Freeway Driving



Mile for mile, freeways (also called thruways, parkways, expressways, turnpikes or superhighways) are the safest of all roads. But they have their own special rules.

The most important advice on freeway driving is: Keep up with traffic and keep to the right. Drive at the same speed most of the other drivers are driving. Too-fast or too-slow driving breaks a smooth traffic flow. Treat the left lane on a freeway as a passing lane.

At the entrance, there is usually a ramp that leads to the freeway. If you have a clear view of the freeway as you drive along the entrance ramp, you should begin to check traffic. Try to determine where you expect to blend with the flow. Try to merge into the gap at close to the prevailing speed. Switch on your turn signal, check your mirrors and glance over your shoulder as often as necessary. Try to blend smoothly with the traffic flow.

Once you are on the freeway, adjust your speed to the posted limit or to the prevailing rate if it's slower. Stay in the right lane unless you want to pass.

Before changing lanes, check your mirrors. Then use your turn signal.

Just before you leave the lane, glance quickly over your shoulder to make sure there isn't another vehicle in your "blind" spot.

Once you are moving on the freeway, make certain you allow a reasonable following distance.

Expect to move slightly slower at night.

When you want to leave the freeway, move to the proper lane well in advance. If you miss your exit, do not, under any circumstances, stop and back up. Drive on to the next exit.

The exit ramp can be curved, sometimes quite sharply. The exit speed is usually posted. Reduce your speed according to your speedometer, not to your sense of motion. After driving for any distance at higher speeds, you may tend to think you are going slower than you actually are.

Before Leaving on a Long Trip

Make sure you're ready. Try to be well rested. If you must start when you're not fresh — such as after a day's work — don't plan to make too many miles that first part of the journey. Wear comfortable clothing and shoes you can easily drive in.

Is your vehicle ready for a long trip? If you keep it serviced and maintained, it's ready to go. If it needs service, have it done before starting out. Of course, you'll find experienced and able service experts in GM dealerships all across North America. They'll be ready and willing to help if you need it.

Here are some things you can check before a trip:

- *Windshield Washer Fluid:* Is the reservoir full? Are all windows clean inside and outside?
- *Wiper Blades:* Are they in good shape?
- *Fuel, Engine Oil, Other Fluids:* Have you checked all levels?
- *Lamps:* Are they all working? Are the lenses clean?
- *Tires:* They are vitally important to a safe, trouble-free trip. Is the tread good enough for long-distance driving? Are the tires all inflated to the recommended pressure?
- *Weather Forecasts:* What's the weather outlook along your route? Should you delay your trip a short time to avoid a major storm system?
- *Maps:* Do you have up-to-date maps?

Highway Hypnosis

Is there actually such a condition as “highway hypnosis”? Or is it just plain falling asleep at the wheel? Call it highway hypnosis, lack of awareness, or whatever.

There is something about an easy stretch of road with the same scenery, along with the hum of the tires on the road, the drone of the engine, and the rush of the wind against the vehicle that can make you sleepy. Don't let it happen to you! If it does, your vehicle can leave the road in *less than a second*, and you could crash and be injured.

What can you do about highway hypnosis? First, be aware that it can happen.

Then here are some tips:

- Make sure your vehicle is well ventilated, with a comfortably cool interior.
- Keep your eyes moving. Scan the road ahead and to the sides. Check your rearview mirrors and your instruments frequently.
- If you get sleepy, pull off the road into a rest, service or parking area and take a nap, get some exercise, or both. For safety, treat drowsiness on the highway as an emergency.

Hill and Mountain Roads



Driving on steep hills or mountains is different from driving in flat or rolling terrain.

If you drive regularly in steep country, or if you're planning to visit there, here are some tips that can make your trips safer and more enjoyable.

- Keep your vehicle in good shape. Check all fluid levels and also the brakes, tires, cooling system and transaxle. These parts can work hard on mountain roads.
- Know how to go down hills. The most important thing to know is this: let your engine do some of the slowing down. Shift to a lower gear when you go down a steep or long hill.

 **CAUTION:**

If you do not shift down, your brakes could get so hot that they would not work well. You would then have poor braking or even none going down a hill. You could crash. Shift down to let your engine assist your brakes on a steep downhill slope.

 **CAUTION:**

Coasting downhill in NEUTRAL (N) or with the ignition off is dangerous. Your brakes will have to do all the work of slowing down. They could get so hot that they would not work well. You would then have poor braking or even none going down a hill. You could crash. Always have your engine running and your vehicle in gear when you go downhill.

- Know how to go uphill. You may want to shift down to a lower gear. The lower gears help you climb the hill better.
- Stay in your own lane when driving on two-lane roads in hills or mountains. Don't swing wide or cut across the center of the road. Drive at speeds that let you stay in your own lane.
- As you go over the top of a hill, be alert. There could be something in your lane, like a stalled car or an accident.
- You may see highway signs on mountains that warn of special problems. Examples are long grades, passing or no-passing zones, a falling rocks area or winding roads. Be alert to these and take appropriate action.

Winter Driving



Here are some tips for winter driving:

- Have your vehicle in good shape for winter.
- You may want to put winter emergency supplies in your trunk.



Include an ice scraper, a small brush or broom, a supply of windshield washer fluid, a rag, some winter outer clothing, a small shovel, a flashlight, a red cloth and a couple of reflective warning triangles. And, if you will be driving under severe conditions, include a small bag of sand, a piece of old carpet or a couple of burlap bags to help provide traction. Be sure you properly secure these items in your vehicle.

Driving on Snow or Ice

Most of the time, those places where your tires meet the road probably have good traction.

However, if there is snow or ice between your tires and the road, you can have a very slippery situation. You'll have a lot less traction or "grip" and will need to be very careful.



What's the worst time for this? "Wet ice." Very cold snow or ice can be slick and hard to drive on. But wet ice can be even more trouble because it may offer the least traction of all. You can get wet ice when it's about freezing (32°F; 0°C) and freezing rain begins to fall. Try to avoid driving on wet ice until salt and sand crews can get there.

Whatever the condition — smooth ice, packed, blowing or loose snow — drive with caution.

Keep your traction control system on. It improves your ability to accelerate when driving on a slippery road. Even though your vehicle has a traction control system, you'll want to slow down and adjust your driving to the road conditions. See *Traction Control System (TCS) on page 4-9*.

Your anti-lock brakes improve your vehicle's stability when you make a hard stop on a slippery road. Even though you have the anti-lock braking system, you'll want to begin stopping sooner than you would on dry pavement. See *Braking on page 4-6*.

- Allow greater following distance on any slippery road.
- Watch for slippery spots. The road might be fine until you hit a spot that's covered with ice. On an otherwise clear road, ice patches may appear in shaded areas where the sun can't reach: around clumps of trees, behind buildings or under bridges. Sometimes the surface of a curve or an overpass may remain icy when the surrounding roads are clear. If you see a patch of ice ahead of you, brake before you are on it. Try not to brake while you're actually on the ice, and avoid sudden steering maneuvers.

If You're Caught in a Blizzard

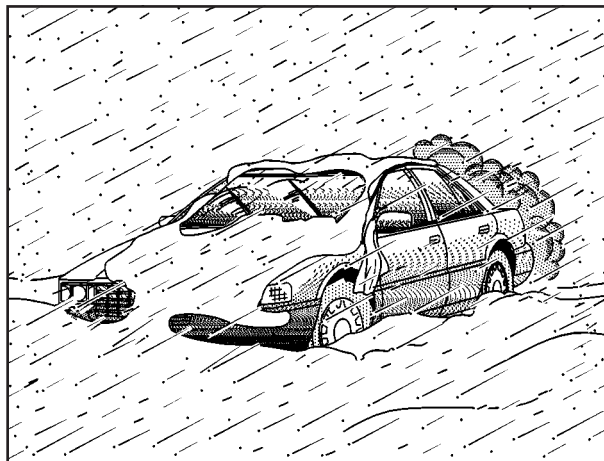

If you are stopped by heavy snow, you could be in a serious situation. You should probably stay with your vehicle unless you know for sure that you are near help and you can hike through the snow. Here are some things to do to summon help and keep yourself and your passengers safe:

- Turn on your hazard flashers.

- Tie a red cloth to your vehicle to alert police that you've been stopped by the snow.
- Put on extra clothing or wrap a blanket around you. If you have no blankets or extra clothing, make body insulators from newspapers, burlap bags, rags, floor mats — anything you can wrap around yourself or tuck under your clothing to keep warm.

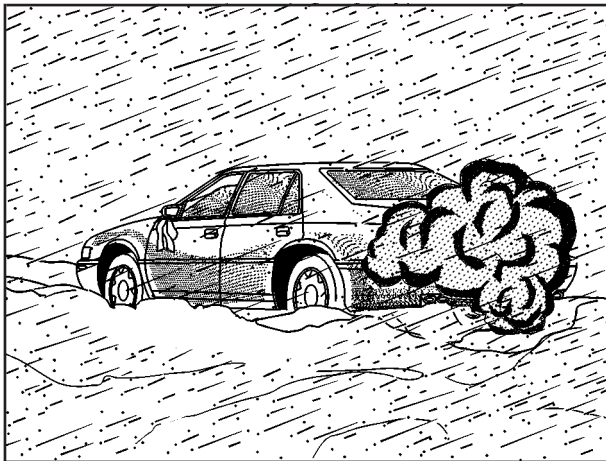

You can run the engine to keep warm, but be careful.

⚠ CAUTION:

Snow can trap exhaust gases under your vehicle. This can cause deadly CO (carbon monoxide) gas to get inside. CO could overcome you and kill you. You can not see it or smell it, so you might not know it is in your vehicle. Clear away snow from around the base of your vehicle, especially any that is blocking your exhaust pipe. And check around again from time to time to be sure snow does not collect there.

Open a window just a little on the side of the vehicle that is away from the wind. This will help keep CO out.

Run your engine only as long as you must. This saves fuel. When you run the engine, make it go a little faster than just idle. That is, push the accelerator slightly. This uses less fuel for the heat that you get and it keeps the battery charged. You will need a well-charged battery to restart the vehicle, and possibly for signaling later on with your headlamps. Let the heater run for a while.

Then, shut the engine off and close the window almost all the way to preserve the heat. Start the engine again and repeat this only when you feel really uncomfortable from the cold. But do it as little as possible. Preserve the fuel as long as you can. To help keep warm, you can get out of the vehicle and do some fairly vigorous exercises every half hour or so until help comes.

If You Are Stuck: In Sand, Mud, Ice or Snow

In order to free your vehicle when it is stuck, you will need to spin the wheels, but you don't want to spin your wheels too fast. The method known as "rocking" can help you get out when you're stuck, but you must use caution.

CAUTION:

If you let your tires spin at high speed, they can explode, and you or others could be injured. And, the transaxle or other parts of the vehicle can overheat. That could cause an engine compartment fire or other damage.

CAUTION: (Continued)

CAUTION: (Continued)

When you are stuck, spin the wheels as little as possible. Do not spin the wheels above 35 mph (55 km/h) as shown on the speedometer.

Notice: Spinning your wheels can destroy parts of your vehicle as well as the tires. If you spin the wheels too fast while shifting your transaxle back and forth, you can destroy your transaxle. See **"Rocking Your Vehicle To Get It Out."**

For information about using tire chains on your vehicle, see *Tire Chains* on page 5-72.

Rocking Your Vehicle To Get It Out

First, turn your steering wheel left and right. That will clear the area around your front wheels. You should turn your traction control system off. See *Traction Control System (TCS)* on page 4-9. Then shift back and forth between REVERSE (R) and a forward gear, spinning the wheels as little as possible. Release the accelerator pedal while you shift, and press lightly on the accelerator pedal when the transaxle is in gear. By slowly spinning your wheels in the forward and reverse directions, you will cause a rocking motion that may free your vehicle. If that doesn't get you out after a few tries, you may need to be towed out. If you do need to be towed out, see "Towing Your Vehicle" following.

Towing

Towing Your Vehicle

Consult your dealer or a professional towing service if you need to have your disabled vehicle towed. See *Roadside Service on page 7-6*.

If you want to tow your vehicle behind another vehicle for recreational purposes (such as behind a motorhome), see Recreational Vehicle Towing following.

Recreational Vehicle Towing

Recreational vehicle towing means towing your vehicle behind another vehicle – such as behind a motorhome. The two most common types of recreational vehicle towing are known as “dinghy towing” (towing your vehicle with all four wheels on the ground) and “dolly towing” (towing your vehicle with two wheels on the ground and two wheels up on a device known as a “dolly”).

With the proper preparation and equipment, many vehicles can be towed in these ways. See “Dinghy Towing” and “Dolly Towing,” following.

Here are some important things to consider before you do recreational vehicle towing:

- What’s the towing capacity of the towing vehicle? Be sure you read the tow vehicle manufacturer’s recommendations.
- How far will you tow? Some vehicles have restrictions on how far and how long they can tow.
- Do you have the proper towing equipment? See your dealer or trailering professional for additional advice and equipment recommendations.
- Is your vehicle ready to be towed? Just as you would prepare your vehicle for a long trip, you’ll want to make sure your vehicle is prepared to be towed. See *Before Leaving on a Long Trip on page 4-23*.

Dinghy Towing

Notice: Towing your vehicle with all four wheels on the ground will damage drivetrain components.

Your vehicle was not designed to be towed with all four wheels on the ground. If your vehicle must be towed, you should use a dolly. See *Dolly Towing* later in this section for more information.

Dolly Towing

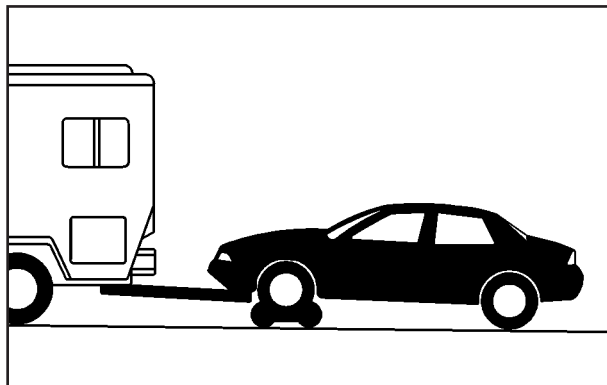

Your vehicle can be towed using a dolly. To tow your vehicle using a dolly, follow these steps:

1. Put the front wheels on the dolly.
2. Put the vehicle in PARK (P).
3. Set the parking brake and then remove the key.
4. Clamp the steering wheel in a straight-ahead position.
5. Release the parking brake.

Loading Your Vehicle

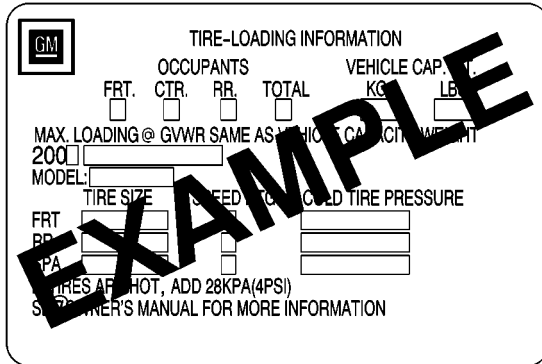

A GM logo is in the top left corner. The text reads: "TIRE-LOADING INFORMATION". Below this are two sections: "OCCUPANTS" with boxes for "FRT.", "CTR.", "RR.", and "TOTAL"; and "VEHICLE CAPACITY" with boxes for "KG." and "LB.". Below these is the text "MAX. LOADING @ GVWR SAME AS VEHICLE CAPACITY WEIGHT" followed by a box containing "200". Below that is "MODEL:" followed by a box. The next section is "TIRE SIZE" with boxes for "FRT.", "RR.", and "PA.". To the right of "TIRE SIZE" are "SPEED RATING" and "COLD TIRE PRESSURE" with corresponding boxes. Below these is the text "TIRES ARE HOT, ADD 28KPA(4PSI)" and "SEE OWNER'S MANUAL FOR MORE INFORMATION". A large, diagonal watermark "EXAMPLE" is overlaid across the center of the label.

Two labels on your vehicle show how much weight it may properly carry. The Tire-Loading Information label found on the rear edge of the driver's door tells you the proper size, speed rating and recommended inflation pressures for the tires on your vehicle. It also gives you important information about the number of people that can be in your vehicle and the total weight that you can carry. This weight is called the Vehicle Capacity Weight and includes the weight of all occupants, cargo and all options not installed in the factory.

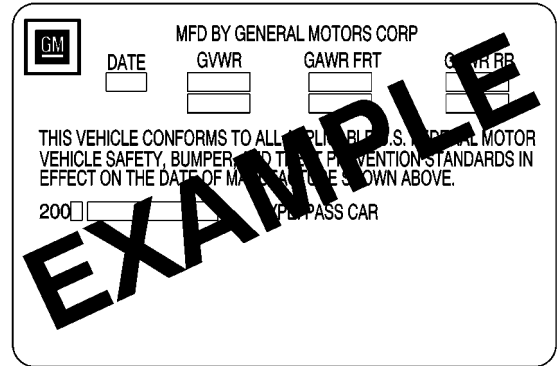

A GM logo is in the top left corner. The text reads: "MFD BY GENERAL MOTORS CORP". Below this are four boxes for "DATE", "GVWR", "GAWR FRT", and "GAWR RR". Below these boxes is the text: "THIS VEHICLE CONFORMS TO ALL APPLICABLE U.S. FEDERAL MOTOR VEHICLE SAFETY, BUMPER AND TRAFFIC PREVENTION STANDARDS IN EFFECT ON THE DATE OF MANUFACTURE SHOWN ABOVE." Below this is a box containing "200" followed by "PASS CAR". A large, diagonal watermark "EXAMPLE" is overlaid across the center of the label.

The other label is the Certification label, found on the rear edge of the driver's door. It tells you the gross weight capacity of your vehicle, called the Gross Vehicle Weight Rating (GVWR). The GVWR includes the weight of the vehicle, all occupants, fuel and cargo. Never exceed the GVWR for your vehicle, or the Gross Axle Weight Rating (GAWR) for either the front or rear axle.

If you do have a heavy load, you should spread it out. Don't carry more than 176 lbs. (80 kg) in your trunk.

CAUTION:

Do not load your vehicle any heavier than the GVWR, or either the maximum front or rear GAWR. If you do, parts on your vehicle can break, and it can change the way your vehicle handles. These could cause you to lose control and crash. Also, overloading can shorten the life of your vehicle.

Notice: Your warranty does not cover parts or components that fail because of overloading.

If you put things inside your vehicle – like suitcases, tools, packages, or anything else – they will go as fast as the vehicle goes. If you have to stop or turn quickly, or if there is a crash, they'll keep going.

CAUTION:

Things you put inside your vehicle can strike and injure people in a sudden stop or turn, or in a crash.

- Put things in the trunk of your vehicle. In a trunk, put them as far forward as you can. Try to spread the weight evenly.
- Never stack heavier things, like suitcases, inside the vehicle so that some of them are above the tops of the seats.
- Don't leave an unsecured child restraint in your vehicle.
- When you carry something inside the vehicle, secure it whenever you can.

Automatic Level Control

This feature keeps the rear of your vehicle level as the load changes. It's automatic – you don't need to adjust anything.

Towing a Trailer

CAUTION:

If you do not use the correct equipment and drive properly, you can lose control when you pull a trailer. For example, if the trailer is too heavy, the brakes may not work well — or even at all. You and your passengers could be seriously injured. You may also damage your vehicle; the resulting repairs would not be covered by your warranty. Pull a trailer only if you have followed all the steps in this section. Ask your dealer for advice and information about towing a trailer with your vehicle.

Your vehicle can tow a trailer if it is equipped with the proper trailer towing equipment. To identify what the vehicle trailering capacity is for your vehicle, you should read the information in *Weight of the Trailer* that appears later in this section. But trailering is different than just driving your vehicle by itself. Trailering means changes in handling, durability and fuel economy. Successful, safe trailering takes correct equipment, and it has to be used properly.

That's the reason for this part. In it are many time-tested, important trailering tips and safety rules. Many of these are important for your safety and that of your passengers. So please read this section carefully before you pull a trailer.

Load-pulling components such as the engine, transaxle, wheel assemblies and tires are forced to work harder against the drag of the added weight. The engine is required to operate at relatively higher speeds and under greater loads, generating extra heat. What's more, the trailer adds considerably to wind resistance, increasing the pulling requirements.

If You Do Decide To Pull A Trailer

If you do, here are some important points:

- There are many different laws, including speed limit restrictions, having to do with trailering. Make sure your rig will be legal, not only where you live but also where you'll be driving. A good source for this information can be state or provincial police.
- Consider using a sway control if your trailer will weigh 2,000 lbs (900 kg) or less. You should always use a sway control if your trailer will weigh more than 2,000 lbs (900 kg). You can ask a hitch dealer about sway controls.
- Don't tow a trailer at all during the first 1,000 miles (1 600 km) your new vehicle is driven. Your engine, axle or other parts could be damaged.
- Then, during the first 500 miles (800 km) that you tow a trailer, don't drive over 50 mph (80 km/h) and don't make starts at full throttle. This helps your engine and other parts of your vehicle wear in at the heavier loads.
- Obey speed limit restrictions when towing a trailer. Don't drive faster than the maximum posted speed for trailers, or no more than 55 mph (90 km/h), to save wear on your vehicle's parts.

Three important considerations have to do with weight:

- the weight of the trailer,
- the weight of the trailer tongue
- and the total weight on your vehicle's tires.

Weight of the Trailer

How heavy can a trailer safely be?

It depends on how you plan to use your rig. For example, speed, altitude, road grades, outside temperature and how much your vehicle is used to pull a trailer are all important. And, it can also depend on any special equipment that you have on your vehicle.

It should never weigh more than 2,000 lbs (900 kg) if you have an SLS model. If you have an STS model, the maximum trailer weight should never be more than 3,000 lbs (1 350 kg). These are total maximum weights including the load. But even that can be too heavy.

The maximum trailer weight for your vehicle can be determined from the Gross Combined Vehicle Weight (GCVW). The $GCVW = \text{curb weight} + \text{passenger's weight} + \text{cargo weight} + \text{trailer weight}$. The GCVW should never be more than 7,100 lbs (3 223 kg) total loaded vehicle and trailer for SLS models and 8,100 lbs (3 677 kg) total loaded vehicle and trailer for STS models.

You can ask your dealer for our trailering information or advice, or you can write us at:

Cadillac Customer Assistance Center
Cadillac Motor Car Division
P.O. Box 33169
Detroit, MI 48232-5169

In Canada write to:

General Motors of Canada Limited
Customer Communication Centre, 163-005
1908 Colonel Sam Drive
Oshawa, Ontario L1H 8P7

Weight of the Trailer Tongue

The tongue load (A) of any trailer is an important weight to measure because it affects the total or gross weight of your vehicle. The Gross Vehicle Weight (GVW) includes the curb weight of the vehicle, any cargo you may carry in it, and the people who will be riding in the vehicle. And if you tow a trailer, you must add the tongue load to the GVW because your vehicle will be carrying that weight, too. See *Loading Your Vehicle on page 4-33* for more information about your vehicle's maximum load capacity.

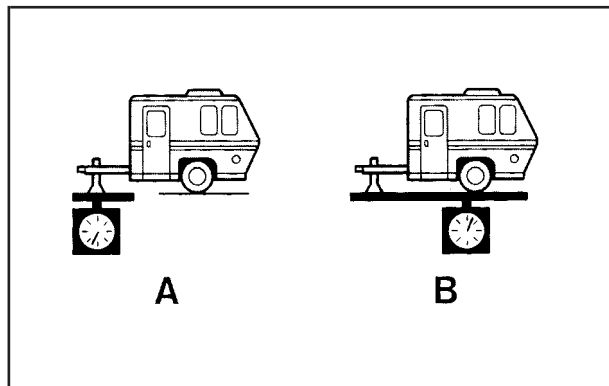

If you're using a weight-carrying hitch or a weight-distributing hitch, the trailer tongue (A) should weigh 10–15 percent of the total loaded trailer weight (B).

After you've loaded your trailer, weigh the trailer and then the tongue, separately, to see if the weights are proper. If they aren't, you may be able to get them right simply by moving some items around in the trailer.

Total Weight on Your Vehicle's Tires

Be sure your vehicle's tires are inflated to the upper limit for cold tires. You'll find these numbers on the Tire-Loading Information label at the rear edge of the driver's door or see *Loading Your Vehicle on page 4-33*. Then be sure you don't go over the GVW limit for your vehicle, including the weight of the trailer tongue.

Hitches

It's important to have the correct hitch equipment. Crosswinds, large trucks going by and rough roads are a few reasons why you'll need the right hitch. Here are some rules to follow:

- The rear bumper on your vehicle is not intended for hitches. Do not attach rental hitches or other bumper-type hitches to it. Use only a frame-mounted hitch that does not attach to the bumper.
- If you'll be pulling a trailer that, when loaded, will weigh more than 2,000 lbs (900 kg), be sure to use a properly mounted, weight-distributing hitch and sway control of the proper size. This equipment is very important for proper vehicle loading and good handling when you're driving.

- Will you have to make any holes in the body of your vehicle when you install a trailer hitch? If you do, then be sure to seal the holes later when you remove the hitch. If you don't seal them, deadly carbon monoxide (CO) from your exhaust can get into your vehicle. See *Engine Exhaust on page 2-35*. Dirt and water can, too.

Safety Chains

You should always attach chains between your vehicle and your trailer. Cross the safety chains under the tongue of the trailer so that the tongue will not drop to the road if it becomes separated from the hitch. Instructions about safety chains may be provided by the hitch manufacturer or by the trailer manufacturer. Follow the manufacturer's recommendation for attaching safety chains and do not attach them to the bumper. Always leave just enough slack so you can turn with your rig. And, never allow safety chains to drag on the ground.

Trailer Brakes

Because you have anti-lock brakes, don't try to tap into your vehicle's hydraulic brake system. If you do, both brake systems won't work well, or at all. If you tow more than 1,000 lbs (450 kg), use trailer brakes. Be sure to follow the instructions that come with the trailer or from the brake manufacturer.

Be sure to read and follow the instructions for the trailer brakes so you'll be able to install, adjust and maintain them properly. Be sure to read and follow the instructions for the trailer brakes so you'll be able to install, adjust and maintain them properly.

Driving with a Trailer

Towing a trailer requires a certain amount of experience. Before setting out for the open road, you'll want to get to know your rig. Acquaint yourself with the feel of handling and braking with the added weight of the trailer. And always keep in mind that the vehicle you are driving is now a good deal longer and not nearly as responsive as your vehicle is by itself.

Before you start, check the trailer hitch and platform (and attachments), safety chains, electrical connector, lamps, tires and mirror adjustment. If the trailer has electric brakes, start your vehicle and trailer moving and then apply the trailer brake controller by hand to be sure the brakes are working. This lets you check your electrical connection at the same time.

During your trip, check occasionally to be sure that the load is secure, and that the lamps and any trailer brakes are still working.

Following Distance

Stay at least twice as far behind the vehicle ahead as you would when driving your vehicle without a trailer. This can help you avoid situations that require heavy braking and sudden turns.

Passing

You'll need more passing distance up ahead when you're towing a trailer. And, because you're a good deal longer, you'll need to go much farther beyond the passed vehicle before you can return to your lane.

Backing Up

Hold the bottom of the steering wheel with one hand. Then, to move the trailer to the left, just move that hand to the left. To move the trailer to the right, move your hand to the right. Always back up slowly and, if possible, have someone guide you.

Making Turns

***Notice:* Making very sharp turns while trailering could cause the trailer to come in contact with the vehicle. Your vehicle could be damaged. Avoid making very sharp turns while trailering.**

When you're turning with a trailer, make wider turns than normal. Do this so your trailer won't strike soft shoulders, curbs, road signs, trees or other objects. Avoid jerky or sudden maneuvers. Signal well in advance.

Turn Signals When Towing a Trailer

When you tow a trailer, your vehicle may need a different turn signal flasher and/or extra wiring. Check with your dealer. The arrows on your instrument panel will flash whenever you signal a turn or lane change. Properly hooked up, the trailer lamps will also flash, telling other drivers you're about to turn, change lanes or stop.

When towing a trailer, the arrows on your instrument panel will flash for turns even if the bulbs on the trailer are burned out. Thus, you may think drivers behind you are seeing your signal when they are not. It's important to check occasionally to be sure the trailer bulbs are still working.

Driving on Grades

Reduce speed and shift to a lower gear *before* you start down a long or steep downgrade. If you don't shift down, you might have to use your brakes so much that they would get hot and no longer work well.

On long uphill grades, reduce speed to 45 to 50 mph (70 to 90 km/h) and avoid prolonged use of SECOND (2) gear and engine speeds above 3800 rpm.

Climbing grades steeper than four percent at temperatures above 90° F (32° C) with a loaded vehicle and trailer is not recommended. The cooling system may temporarily overheat. See *Engine Overheating on page 5-28*.

Parking on Hills

CAUTION:

You really should not park your vehicle, with a trailer attached, on a hill. If something goes wrong, your rig could start to move. People can be injured, and both your vehicle and the trailer can be damaged.

But if you ever have to park your rig on a hill, here's how to do it:

1. Apply your regular brakes, but do not shift into PARK (P).
2. Have someone place chocks behind the trailer wheels.
3. When the wheel chocks are in place, release the regular brakes until the chocks absorb the load.
4. Reapply the regular brakes. Then shift into PARK (P) firmly and apply your parking brake.
5. Release the regular brakes.

When You Are Ready to Leave After Parking on a Hill:

1. Apply your regular brakes and hold the pedal down while you:
 - start your engine,
 - shift into a gear, and
 - make sure the parking brake has released.
2. Let up on the brake pedal.
3. Drive slowly until the trailer is clear of the chocks.
4. Stop and have someone pick up and store the chocks.

Maintenance When Trailer Towing

Your vehicle will need service more often when you're pulling a trailer. See the Maintenance Schedule for more on this. Things that are especially important in trailer operation are automatic transaxle fluid (don't overfill), engine oil, drive belt, cooling system and brake system. Each of these is covered in this manual, and the Index will help you find them quickly. If you're trailering, it's a good idea to review this information before you start your trip.

Check periodically to see that all hitch nuts and bolts are tight.

Engine Cooling When Trailer Towing

Your cooling system may temporarily overheat during severe operating conditions. See *Engine Overheating on page 5-28*.

Section 5 Service and Appearance Care

| | | | |
|----------------------------------------------------------|------|-------------------------------------------------|------|
| Service | 5-3 | Power Steering Fluid | 5-38 |
| Doing Your Own Service Work | 5-3 | Windshield Washer Fluid | 5-39 |
| Adding Equipment to the Outside of Your Vehicle | 5-4 | Brakes | 5-40 |
| Fuel | 5-4 | Battery | 5-43 |
| Gasoline Octane | 5-4 | Jump Starting | 5-45 |
| Gasoline Specifications | 5-5 | Headlamp Aiming | 5-51 |
| California Fuel | 5-5 | Headlamp Horizontal Aiming | 5-53 |
| Additives | 5-6 | Headlamp Vertical Aiming | 5-53 |
| Fuels in Foreign Countries | 5-6 | Bulb Replacement | 5-55 |
| Filling Your Tank | 5-6 | High Intensity Discharge (HID) Lighting | 5-55 |
| Filling a Portable Fuel Container | 5-10 | Halogen Bulbs | 5-56 |
| Checking Things Under the Hood | 5-10 | Headlamps | 5-56 |
| Hood Release | 5-11 | Front Turn Signal Lamps | 5-59 |
| Engine Compartment Overview | 5-12 | Center High-Mounted Stoplamp (CHMSL) | 5-60 |
| Engine Oil | 5-13 | Taillamps and Turn Signal Lamps | 5-60 |
| Engine Air Cleaner/Filter | 5-19 | Replacement Bulbs | 5-61 |
| Automatic Transaxle Fluid | 5-21 | Windshield Wiper Blade Replacement | 5-62 |
| Engine Coolant | 5-25 | Tires | 5-63 |
| Coolant Surge Tank Pressure Cap | 5-28 | Inflation -- Tire Pressure | 5-64 |
| Engine Overheating | 5-28 | Tire Pressure Monitor System | 5-65 |
| Cooling System | 5-31 | Tire Inspection and Rotation | 5-67 |
| | | When It Is Time for New Tires | 5-68 |

Section 5 Service and Appearance Care

| | | | |
|--------------------------------------------|------|---------------------------------------------------|-------|
| Buying New Tires | 5-68 | Chemical Paint Spotting | 5-89 |
| Uniform Tire Quality Grading | 5-69 | Vehicle Care/Appearance Materials | 5-90 |
| Wheel Alignment and Tire Balance | 5-71 | Vehicle Identification | 5-91 |
| Wheel Replacement | 5-71 | Vehicle Identification Number (VIN) | 5-91 |
| Tire Chains | 5-72 | Service Parts Identification Label | 5-92 |
| If a Tire Goes Flat | 5-73 | Electrical System | 5-92 |
| Changing a Flat Tire | 5-74 | Add-On Electrical Equipment | 5-92 |
| Compact Spare Tire | 5-83 | Headlamp Wiring | 5-92 |
| Appearance Care | 5-83 | Windshield Wiper Fuses | 5-92 |
| Cleaning the Inside of Your Vehicle | 5-84 | Power Windows and Other Power Options | 5-92 |
| Care of Safety Belts | 5-86 | Fuses and Circuit Breakers | 5-93 |
| Weatherstrips | 5-86 | Removing the Rear Seat Cushion | 5-96 |
| Cleaning the Outside of Your Vehicle | 5-86 | Capacities and Specifications | 5-100 |
| Sheet Metal Damage | 5-88 | Normal Maintenance Replacement Parts | 5-101 |
| Finish Damage | 5-89 | | |
| Underbody Maintenance | 5-89 | | |

Service

Your dealer knows your vehicle best and wants you to be happy with it. We hope you will go to your dealer for all your service needs. You will get genuine GM parts and GM-trained and supported service people.

We hope you will want to keep your GM vehicle all GM. Genuine GM parts have one of these marks:



ACDelco®



GM Parts



GM
Goodwrench

Doing Your Own Service Work

If you want to do some of your own service work, you'll want to use the proper service manual. It tells you much more about how to service your vehicle than this manual can. To order the proper service manual, see *Service Publications Ordering Information on page 7-10*.

Your vehicle has an air bag system. Before attempting to do your own service work, see *Servicing Your Air Bag-Equipped Vehicle on page 1-52*.

You should keep a record with all parts receipts and list the mileage and the date of any service work you perform. See *Part E: Maintenance Record on page 6-16*.

CAUTION:

You can be injured and your vehicle could be damaged if you try to do service work on a vehicle without knowing enough about it.

- Be sure you have sufficient knowledge, experience, the proper replacement parts and tools before you attempt any vehicle maintenance task.

CAUTION: (Continued)

CAUTION: (Continued)

- **Be sure to use the proper nuts, bolts and other fasteners. “English” and “metric” fasteners can be easily confused. If you use the wrong fasteners, parts can later break or fall off. You could be hurt.**

Adding Equipment to the Outside of Your Vehicle

Things you might add to the outside of your vehicle can affect the airflow around it. This may cause wind noise and affect windshield washer performance. Check with your dealer before adding equipment to the outside of your vehicle.

Fuel

Use of the recommended fuel is an important part of the proper maintenance of your vehicle.

Gasoline Octane

Use regular unleaded gasoline with a posted octane of 87 or higher. However, for best performance and for trailer towing, you may wish to use middle grade or premium unleaded gasoline. If the octane is less than 87, you may get a heavy knocking noise when you drive. If this occurs, use a gasoline rated at 87 octane or higher as soon as possible. Otherwise, you might damage your engine.

Gasoline Specifications

It is recommended that gasoline meet specifications which were developed by the American Automobile Manufacturers Association and endorsed by the Canadian Vehicle Manufacturers Association for better vehicle performance and engine protection. Gasoline meeting these specifications could provide improved driveability and emission control system performance compared to other gasoline.



Canada Only

In Canada, look for the “Auto Makers’ Choice” label on the pump.

California Fuel

If your vehicle is certified to meet California Emission Standards (see the underhood emission control label), it is designed to operate on fuels that meet California specifications. If this fuel is not available in states adopting California emissions standards, your vehicle will operate satisfactorily on fuels meeting federal specifications, but emission control system performance may be affected. The malfunction indicator lamp may turn on (see *Malfunction Indicator Lamp on page 3-47*) and your vehicle may fail a smog-check test. If this occurs, return to your authorized GM dealer for diagnosis. If it is determined that the condition is caused by the type of fuel used, repairs may not be covered by your warranty.

Additives

To provide cleaner air, all gasolines in the United States are now required to contain additives that will help prevent engine and fuel system deposits from forming, allowing your emission control system to work properly. You should not have to add anything to your fuel. Gasolines containing oxygenates, such as ethers and ethanol, and reformulated gasolines may be available in your area to contribute to clean air. General Motors recommends that you use these gasolines, particularly if they comply with the specifications described earlier.

Notice: Your vehicle was not designed for fuel that contains methanol. Do not use fuel containing methanol. It can corrode metal parts in your fuel system and also damage the plastic and rubber parts. That damage would not be covered under your warranty.

Some gasolines that are not reformulated for low emissions may contain an octane-enhancing additive called methylcyclopentadienyl manganese tricarbonyl (MMT); ask the attendant where you buy gasoline whether the fuel contains MMT. General Motors does not recommend the use of such gasolines. Fuels containing MMT can reduce the life of spark plugs and the performance of the emission control system may

be affected. The malfunction indicator lamp may turn on. If this occurs, return to your authorized GM dealer for service.

Fuels in Foreign Countries

If you plan on driving in another country outside the United States or Canada, the proper fuel may be hard to find. Never use leaded gasoline or any other fuel not recommended in the previous text on fuel. Costly repairs caused by use of improper fuel would not be covered by your warranty.

To check the fuel availability, ask an auto club, or contact a major oil company that does business in the country where you will be driving.

Filling Your Tank

CAUTION:

Fuel vapor is highly flammable. It burns violently, and that can cause very bad injuries. Do not smoke if you are near fuel or refueling your vehicle. Keep sparks, flames and smoking materials away from fuel.



The fuel cap is located behind a hinged door on the driver's side of your vehicle.



The fuel door release button is located on the left side of the instrument panel below the exterior lamp control.

To open the fuel door, press the fuel door release button upward. The vehicle must be in PARK (P) or NEUTRAL (N) and the valet lockout button must be in OFF.



An alternate fuel door release strap is located inside the trunk on the driver's side of the vehicle.

Pull the strap to release the fuel door.



While refueling, hang the fuel cap by the tether from the hook on the fuel door.

To remove the fuel cap, turn it slowly to the left (counterclockwise). The fuel cap has a spring in it; if you let go of the cap too soon, it will spring back to the right.

 **CAUTION:**

If you get fuel on yourself and then something ignites it, you could be badly burned. Fuel can spray out on you if you open the fuel cap too quickly. This spray can happen if your tank is nearly full, and is more likely in hot weather. Open the fuel cap slowly and wait for any “hiss” noise to stop. Then unscrew the cap all the way.

Be careful not to spill fuel. Clean fuel from painted surfaces as soon as possible. See *Cleaning the Outside of Your Vehicle* on page 5-86.

When you put the fuel cap back on, turn it to the right (clockwise) until you hear a clicking sound. Make sure you fully install the cap. The diagnostic system can determine if the fuel cap has been left off or improperly installed. This would allow fuel to evaporate into the atmosphere. See *Malfunction Indicator Lamp* on page 3-47.

The CHECK GAS CAP message in the Driver Information Center (DIC) will come on if the fuel cap is not properly reinstalled.

Notice: If you need a new fuel cap, be sure to get the right type. Your dealer can get one for you. If you get the wrong type, it may not fit properly. This may cause your malfunction indicator lamp to light and may damage your fuel tank and emissions system. See “Malfunction Indicator Lamp” in the Index.

Filling a Portable Fuel Container

CAUTION:

Never fill a portable fuel container while it is in your vehicle. Static electricity discharge from the container can ignite the gasoline vapor. You can be badly burned and your vehicle damaged if this occurs. To help avoid injury to you and others:

- Dispense gasoline only into approved containers.
- Do not fill a container while it is inside a vehicle, in a vehicle's trunk, pickup bed or on any surface other than the ground.
- Bring the fill nozzle in contact with the inside of the fill opening before operating the nozzle. Contact should be maintained until the filling is complete.
- Do not smoke while pumping gasoline.

Checking Things Under the Hood

CAUTION:

An electric fan under the hood can start up and injure you even when the engine is not running. Keep hands, clothing and tools away from any underhood electric fan.

CAUTION:

Things that burn can get on hot engine parts and start a fire. These include liquids like fuel, oil, coolant, brake fluid, windshield washer and other fluids, and plastic or rubber. You or others could be burned. Be careful not to drop or spill things that will burn onto a hot engine.

Hood Release

To lift the hood, use the following steps:



1. Pull the lever inside the vehicle to open the hood. It is located on the lower left side of the instrument panel.

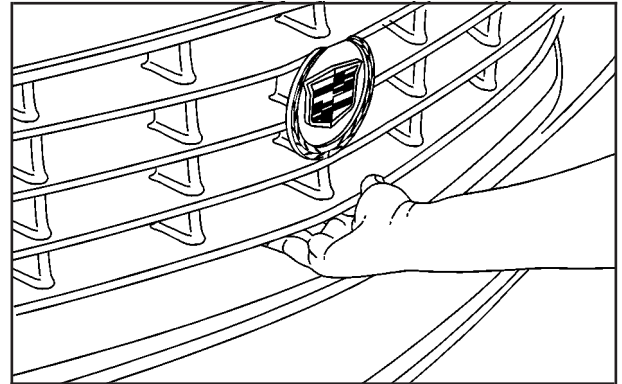

2. Then go to the front of the vehicle and find the secondary hood release which is located below the front grille.
3. Move the release lever to the left as you raise the hood.

Before closing the hood, be sure all filler caps are on properly. Then pull the hood down and close it firmly.

Engine Compartment Overview

When you open the hood, you'll see:

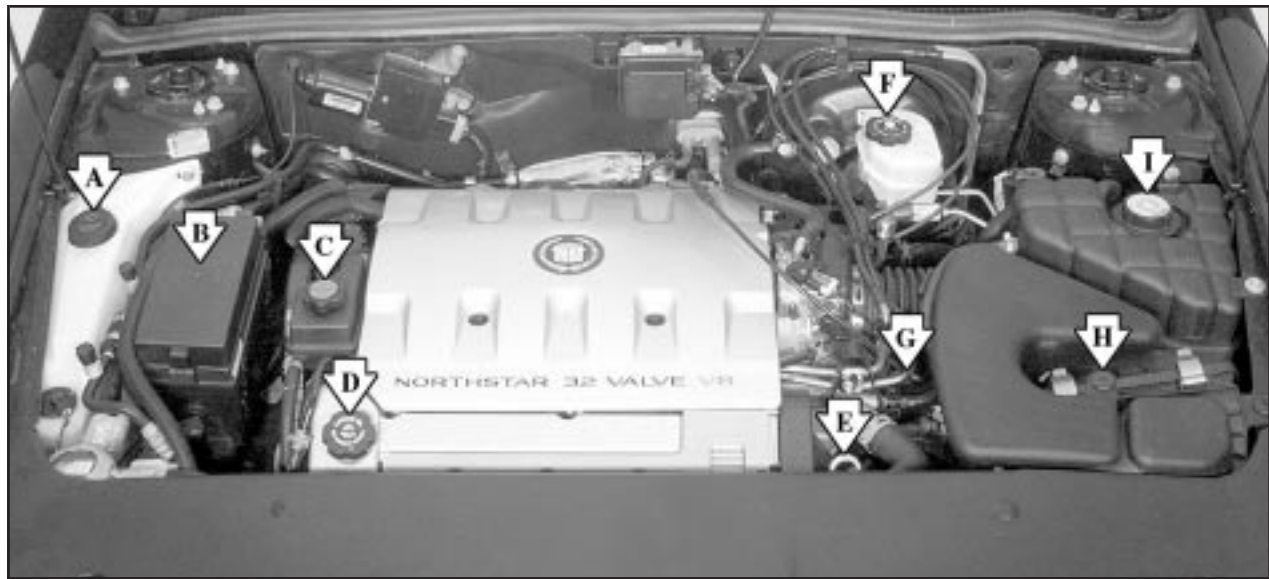

- A. Windshield Washer Fluid Reservoir. See *Windshield Washer Fluid* on page 5-39.
- B. Underhood Fuse Block. See “Underhood Fuse Block” *Fuses and Circuit Breakers* on page 5-93.
- C. Power Steering Fluid Reservoir. See *Power Steering Fluid* on page 5-38.
- D. Engine Oil Fill Location. See *Engine Oil* on page 5-13.
- E. Engine Oil Dipstick. See *Engine Oil* on page 5-13.
- F. Brake Master Cylinder Reservoir. See *Brakes* on page 5-40.
- G. Transaxle Fluid Cap and Dipstick. See *Automatic Transaxle Fluid* on page 5-21.
- H. Engine Air Cleaner/Filter. See *Engine Air Cleaner/Filter* on page 5-19.
- I. Engine Coolant Surge Tank and Pressure Cap. See *Coolant Surge Tank Pressure Cap* on page 5-28 and *Cooling System* on page 5-31.

Engine Oil

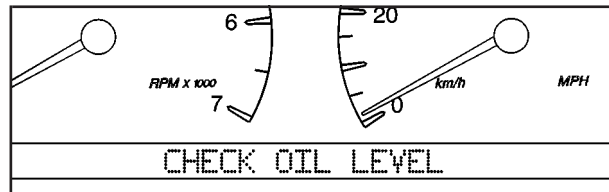

If the CHECK OIL LEVEL message appears on the instrument cluster, it means you need to check your engine oil level right away. For more information, see “CHECK OIL LEVEL” under *DIC Warnings and Messages* on page 3-56.

You should check your engine oil level regularly; this is an added reminder.

Checking Engine Oil

It's a good idea to check your engine oil every time you get fuel. In order to get an accurate reading, the oil must be warm and the vehicle must be on level ground.



The engine oil dipstick is located behind the radiator on the driver's side of the vehicle. The handle is a yellow loop. For more information on location see *Engine Compartment Overview on page 5-12*.

Turn off the engine and give the oil several minutes to drain back into the oil pan. If you don't, the oil dipstick might not show the actual level.

Pull out the dipstick and clean it with a paper towel or cloth, then push it back in all the way. Remove it again, keeping the tip down, and check the level.

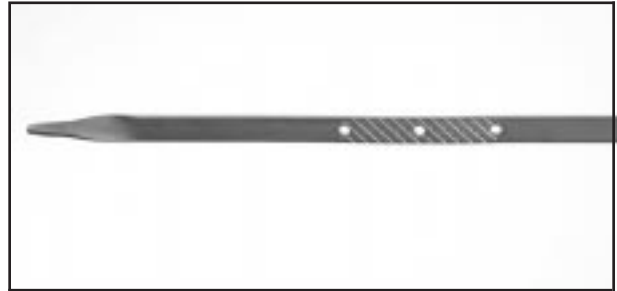

When to Add Engine Oil

If the oil is at or below the cross-hatched area at the tip of the dipstick, then you'll need to add at least one quart of oil. But you must use the right kind. This part explains what kind of oil to use. For engine oil crankcase capacity, see *Capacities and Specifications on page 5-100*.

Notice: Don't add too much oil. If your engine has so much oil that the oil level gets above the cross-hatched area that shows the proper operating range, your engine could be damaged.



The engine oil fill cap is located behind the radiator on the passenger's side of the vehicle. For more information on location, see *Engine Compartment Overview on page 5-12*.

Turn the cap counterclockwise to remove it.

Be sure to fill it enough to put the level somewhere in the proper operating range in the cross-hatched area. Push the dipstick all the way back in when you're through.

What Kind of Engine Oil to Use

Oils recommended for your vehicle can be identified by looking for the starburst symbol.

This symbol indicates that the oil has been certified by the American Petroleum Institute (API). Do not use any oil which does not carry this starburst symbol.

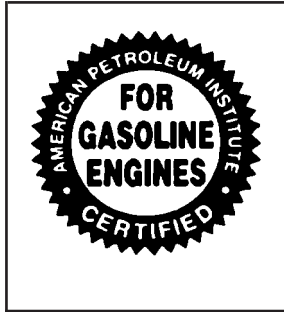

If you choose to perform the engine oil change service yourself, be sure the oil you use has the starburst symbol on the front of the oil container. If you have your oil changed for you, be sure the oil put into your engine is American Petroleum Institute certified for gasoline engines.

You should also use the proper viscosity oil for your vehicle, as shown in the viscosity chart.

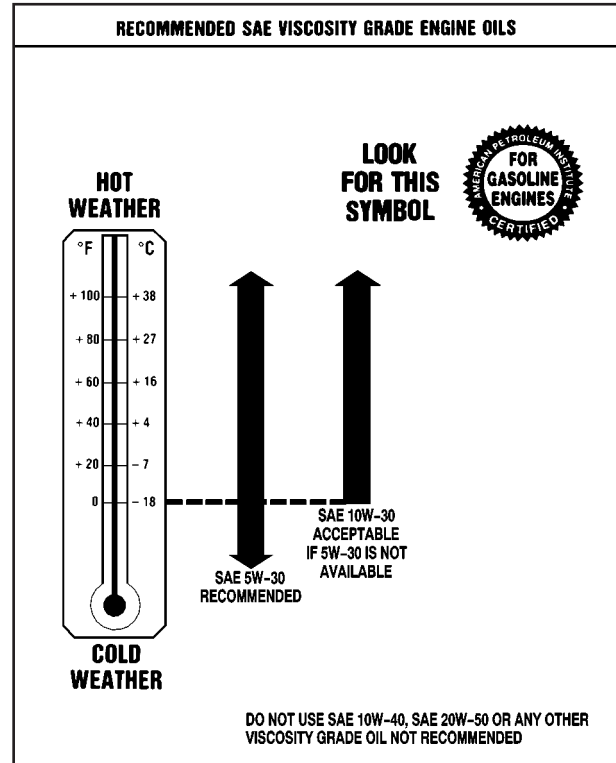

As in the chart shown previously, SAE 5W-30 is the only viscosity grade recommended for your vehicle. You should look for and use only oils which have the API Starburst symbol and which are also identified as SAE 5W-30. If you cannot find such SAE 5W-30 oils, you can use an SAE 10W-30 oil which has the API Starburst symbol, if it's going to be 0°F (-18°C) or above. Do not use other viscosity grade oils, such as SAE 10W-40 or SAE 20W-50 under any conditions.

Notice: Use only engine oil with the American Petroleum Institute Certified For Gasoline Engines starburst symbol. Failure to use the recommended oil can result in engine damage not covered by your warranty.

GM Goodwrench® oil meets all the requirements for your vehicle.

If you are in an area of extreme cold, where the temperature falls below -20°F (-29°C), it is recommended that you use either an SAE 5W-30 synthetic oil or an SAE 0W-30 oil. Both will provide easier cold starting and better protection for your engine at extremely low temperatures.

Engine Oil Additives

Don't add anything to your oil. The recommended oils with the starburst symbol are all you will need for good performance and engine protection.

When to Change Engine Oil (GM Oil Life System)

Your vehicle has a computer system that lets you know when to change the engine oil and filter. This is based on engine revolutions and engine temperature, and not on mileage. Based on driving conditions, the mileage at which an oil change will be indicated can vary considerably. For the oil life system to work properly, you must reset the system every time the oil is changed.

When the system has calculated that oil life has been diminished, it will indicate that an oil change is necessary. A CHANGE ENGINE OIL message in the Driver Information Center (DIC) will come on. Change your oil as soon as possible within the next two times you stop for fuel. It is possible that, if you are driving under the best conditions, the oil life system may not indicate that an oil change is necessary for over a year. However, your engine oil and filter must be changed at least once a year and at this time the system must be reset. Your dealer has GM-trained service people who will perform this work using genuine GM parts and reset the system. It is also important to check your oil regularly and keep it at the proper level.

If the system is ever reset accidentally, you must change your oil at 3,000 miles (5 000 km) since your last oil change. Remember to reset the oil life system whenever the oil is changed.

How to Reset the CHANGE ENGINE OIL Message

The GM Oil Life System™ calculates when to change your engine oil and filter based on vehicle use. Anytime your oil is changed, reset the system so it can calculate when the next oil change is required. If a situation occurs where you change your oil prior to a CHANGE ENGINE OIL message in the Driver Information Center (DIC) being turned on, reset the system.

After the oil has been changed, the CHANGE ENGINE OIL message must be reset. To reset the message, do the following:

1. Turn the key to the “ON” position without starting the engine.
2. Press the INFO button on the Driver Information Center (DIC) until ENGINE OIL LIFE is displayed.
3. Press and hold the INFO RESET button until 100% ENGINE OIL LIFE is displayed. This resets the oil life indicator.

The percentage of oil life remaining may be checked at any time by pressing the INFO button until ENGINE OIL LIFE is displayed on the DIC. For more information on the oil life indicator, see *Oil Life Indicator on page 3-77*.

What to Do with Used Oil

Used engine oil contains certain elements that may be unhealthy for your skin and could even cause cancer. Don't let used oil stay on your skin for very long. Clean your skin and nails with soap and water, or a good hand cleaner. Wash or properly dispose of clothing or rags containing used engine oil. See the manufacturer's warnings about the use and disposal of oil products.

Used oil can be a threat to the environment. If you change your own oil, be sure to drain all the oil from the filter before disposal. Never dispose of oil by putting it in the trash, pouring it on the ground, into sewers, or into streams or bodies of water. Instead, recycle it by taking it to a place that collects used oil. If you have a problem properly disposing of your used oil, ask your dealer, a service station or a local recycling center for help.

Engine Air Cleaner/Filter

See *Engine Compartment Overview* on page 5-12 for location of the engine air cleaner/filter.



When to Inspect the Engine Air Cleaner/Filter

Inspect the air cleaner/filter every 15,000 miles (25 000 km) and replace every 30,000 (50 000 km). If you are driving in dusty/dirty conditions, inspect the filter at each engine oil change.

How to Inspect the Engine Air Cleaner/Filter

To inspect the air cleaner/filter, remove the filter from the vehicle and lightly shake the filter to release loose dust and dirt. If the filter remains caked with dirt, a new filter is required.

To inspect or replace the filter, do the following:



1. Loosen the air duct clamp, which is located at the mass airflow sensor end of the air duct.

2. Disconnect the air duct from the mass airflow sensor.



3. Unhook both of the engine air cleaner/filter cover latches.
4. Move the cover out of the way.



5. Take out the engine air cleaner/filter and remove any loose debris that may be found lying in the base.
6. Install a new air filter element. See *Normal Maintenance Replacement Parts* on page 5-101 for the proper type.

Follow these steps to reinstall the engine air cleaner/filter assembly:

1. Slide the cover into the slots in the bottom of the base.
2. Close the cover and make sure that both latches are secure and fully engaged.
3. Reinstall the clean air duct over the mass airflow sensor. Make sure that the duct is secure around the entire outer edge of the sensor.
4. Tighten the air duct clamp.

 **CAUTION:**

Operating the engine with the air cleaner/filter off can cause you or others to be burned. The air cleaner not only cleans the air, it helps to stop flame if the engine backfires. If it is not there and the engine backfires, you could be burned. Do not drive with it off, and be careful working on the engine with the air cleaner/filter off.

Notice: If the air cleaner/filter is off, a backfire can cause a damaging engine fire. And, dirt can easily get into your engine, which will damage it. Always have the air cleaner/filter in place when you're driving.

Automatic Transaxle Fluid

When to Check and Change

A good time to check your automatic transaxle fluid level is when the engine oil is changed.

Change both the fluid and filter every 50,000 miles (83 000 km) if the vehicle is mainly driven under one or more of these conditions:

- In heavy city traffic where the outside temperature regularly reaches 90° F (32° C) or higher.
- In hilly or mountainous terrain.
- When doing frequent trailer towing.
- Uses such as found in taxi, police or delivery service.

If you do not use your vehicle under any of these conditions, the fluid and filter do not require change until the message CHANGE TRANS FLUID appears on the Driver Information Center.

See *Part A: Scheduled Maintenance Services on page 6-4.*

How to Check

Because this operation can be a little difficult, you may choose to have this done at the dealership service department.

If you do it yourself, be sure to follow all the instructions here, or you could get a false reading on the dipstick.

Notice: Too much or too little fluid can damage your transaxle. Too much can mean that some of the fluid could come out and fall on hot engine or exhaust system parts, starting a fire. Too little fluid could cause the transaxle to overheat. Be sure to get an accurate reading if you check your transaxle fluid.

Wait at least 30 minutes before checking the transaxle fluid level if you have been driving:

- When outside temperatures are above 90°F (32°C).
- At high speed for quite a while.
- In heavy traffic – especially in hot weather.
- While pulling a trailer.

To get the right reading, the fluid should be at normal operating temperature, which is 180° F to 200° F (82° C to 93° C).

Get the vehicle warmed up by driving about 15 miles (24 km) when outside temperatures are above 50° F (10° C). If it's colder than 50°F (10°C), you may have to drive longer.

Checking the Fluid Level

Prepare your vehicle as follows:

- Park your vehicle on a level place. Keep the engine running.
- With the parking brake applied, place the shift lever in PARK (P).
- With your foot on the brake pedal, move the shift lever through each gear range, pausing for about three seconds in each range. Then, position the shift lever in PARK (P).
- Let the engine run at idle for three to five minutes.

Then, without shutting off the engine, follow these steps:



The transaxle fluid cap is located next to the radiator hose and below the engine air cleaner/filter assembly in the engine compartment on the driver's side of the vehicle. See *Engine Compartment Overview on page 5-12* for more information on location.

1. After removing the engine air cleaner/filter assembly to reach the transaxle fluid cap, turn the cap counterclockwise to remove. Pull out the dipstick and wipe it with a clean rag or paper towel.
2. Push it back in all the way, wait three seconds and then pull it back out again.



3. Check both sides of the dipstick, and read the lower level. The fluid level must be in the cross-hatched area.
4. If the fluid level is in the acceptable range, push the dipstick back in all the way and turn the handle clockwise. Reinstall the engine air cleaner/filter assembly.

How to Add Fluid

Refer to the Maintenance Schedule to determine what kind of transaxle fluid to use. See *Part D: Recommended Fluids and Lubricants on page 6-15*.

If the fluid level is low, add only enough of the proper fluid to bring the level into the cross-hatched area on the dipstick.

1. Pull out the dipstick.
2. Using a long-neck funnel, add enough fluid at the dipstick hole to bring it to the proper level.

It doesn't take much fluid, generally less than one pint (0.5 L). Don't overfill.

Notice: We recommend you use only fluid labeled DEXRON[®]-III, because fluid with that label is made especially for your automatic transaxle. Damage caused by fluid other than DEXRON[®]-III is not covered by your new vehicle warranty.

3. After adding fluid, recheck the fluid level as described under *How to Check*.
4. When the correct fluid level is obtained, push the dipstick back in all the way and turn the handle clockwise. Reinstall the engine air cleaner/filter assembly.

How to Reset the Transaxle Fluid Change Indicator

Once the transaxle fluid has been changed, the transaxle fluid change indicator must be reset. Use the following steps to reset the indicator:

1. Press the INFO button on the Driver Information Center (DIC) until TRANS FLUID LIFE is displayed.
2. Press and hold the INFO RESET button until 100% is displayed.

The indicator is now reset. The percentage of transaxle fluid life remaining may be checked at any time by pressing the INFO button several times until the TRANS FLUID LIFE message appears.

Engine Coolant

The cooling system in your vehicle is filled with DEX-COOL[®] engine coolant. This coolant is designed to remain in your vehicle for 5 years or 150,000 miles (240 000 km), whichever occurs first, if you add only DEX-COOL[®] extended life coolant.

The following explains your cooling system and how to add coolant when it is low. If you have a problem with engine overheating, see *Engine Overheating on page 5-28*.

A 50/50 mixture of clean, drinkable water and DEX-COOL[®] coolant will:

- Give freezing protection down to -34° F (-37° C).
- Give boiling protection up to 265° F (129° C).
- Protect against rust and corrosion.
- Help keep the proper engine temperature.
- Let the warning lights and gages work as they should.

Notice: When adding coolant, it is important that you use only DEX-COOL[®] (silicate-free) coolant. If coolant other than DEX-COOL[®] is added to the system, premature engine, heater core or radiator corrosion may result. In addition, the engine coolant will require change sooner -- at 30,000 miles (50,000 km) or 24 months, whichever occurs first. Damage caused by the use of coolant other than DEX-COOL[®] is not covered by your new vehicle warranty.

What to Use

Use a mixture of one-half *clean, drinkable water* and one-half DEX-COOL[®] coolant which won't damage aluminum parts. If you use this coolant mixture, you don't need to add anything else.

CAUTION:

Adding only plain water to your cooling system can be dangerous. Plain water, or some other liquid such as alcohol, can boil before the proper coolant mixture will. Your vehicle's coolant warning system is set for the proper coolant mixture. With plain water or the wrong mixture, your engine could get too hot but you would not get the overheat warning. Your engine could catch fire and you or others could be burned. Use a 50/50 mixture of clean, drinkable water and DEX-COOL[®] coolant.

Notice: If you use an improper coolant mixture, your engine could overheat and be badly damaged. The repair cost wouldn't be covered by your warranty. Too much water in the mixture can freeze and crack the engine, radiator, heater core and other parts.

If you have to add coolant more than four times a year, have your dealer check your cooling system.

Notice: If you use the proper coolant, you don't have to add extra inhibitors or additives which claim to improve the system. These can be harmful.

Checking Coolant



The engine coolant surge tank is located in the engine compartment on the driver's side of the vehicle. See *Engine Compartment Overview* on page 5-12 for more information on location.

CAUTION:

Turning the surge tank pressure cap when the engine and radiator are hot can allow steam and scalding liquids to blow out and burn you badly. Never turn the surge tank pressure cap — even a little — when the engine and radiator are hot.

The vehicle must be on a level surface. When your engine is cold, the coolant level should be at the FULL COLD mark, which is at or above the fill mark at the forward edge of the surge tank.

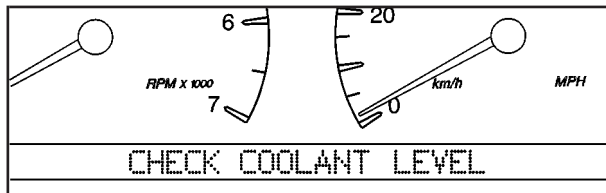

If the CHECK COOLANT LEVEL message comes on and stays on, it means you're low on engine coolant.

Adding Coolant

If you need more coolant, add the proper DEX-COOL[®] coolant mixture *at the surge tank*, but only when the engine is cool.

CAUTION:

You can be burned if you spill coolant on hot engine parts. Coolant contains ethylene glycol, and it will burn if the engine parts are hot enough. Don't spill coolant on a hot engine.

When replacing the pressure cap, make sure it is hand-tight.

Coolant Surge Tank Pressure Cap

Notice: Your coolant surge tank pressure cap is a pressure-type cap and must be tightly installed to prevent coolant loss and possible engine damage from overheating. Two and one-half turns are required to seal the cap. See “Engine Compartment Overview” in the Index for more information on location.

Engine Overheating

You will find an ENGINE COOLANT HOT, IDLE ENGINE message or an ENGINE OVERHEATED, STOP ENGINE message displayed in the Driver Information Center (DIC). You will also hear a chime. There is also an engine temperature warning light and/or gage on the instrument panel cluster. See *Engine Coolant Temperature Warning Light on page 3-46* and *Engine Coolant Temperature Gage on page 3-46*.

Overheated Engine Protection Operating Mode

If an overheated engine condition exists and the message ENGINE OVERHEATED, STOP ENGINE is displayed, an overheat protection mode which alternates firing groups of cylinders helps prevent engine damage. In this mode, you will notice a loss in power and engine performance. This operating mode allows your vehicle to be driven to a safe place in an emergency; you may drive up to 50 miles (80 km). Driving extended miles (km) and/or towing a trailer in the overheat protection mode should be avoided.

Notice: After driving in the overheated engine protection operating mode, to avoid engine damage, allow the engine to cool before attempting any repair. The engine oil will be severely degraded. Repair the cause of coolant loss, change the oil and reset the oil life system. See “Engine Oil” in the Index.

If Steam Is Coming From Your Engine



CAUTION:

Steam from an overheated engine can burn you badly, even if you just open the hood. Stay away from the engine if you see or hear steam coming from it. Just turn it off and get everyone away from the vehicle until it cools down. Wait until there is no sign of steam or coolant before you open the hood.

If you keep driving when your engine is overheated, the liquids in it can catch fire. You or others could be badly burned. Stop your engine if it overheats, and get out of the vehicle until the engine is cool.

See “Overheated Engine Protection Operating Mode” in the Index for information on driving to a safe place in an emergency.

Notice: If your engine catches fire because you keep driving with no coolant, your vehicle can be badly damaged. The costly repairs would not be covered by your warranty. See “Overheated Engine Protection Operating Mode” in the Index for information on driving to a safe place in an emergency.

If No Steam Is Coming From Your Engine

An overheat warning, along with a low coolant message, can indicate a serious problem. See *DIC Warnings and Messages on page 3-56*.

If you get an engine overheat warning with no low coolant message, but see or hear no steam, the problem may not be too serious. Sometimes the engine can get a little too hot when you:

- Climb a long hill on a hot day.
- Stop after high-speed driving.
- Idle for long periods in traffic.
- Tow a trailer.

If you get the overheat warning with no sign of steam, try this for a minute or so:

1. In heavy traffic, let the engine idle in NEUTRAL (N) while stopped. If it safe to do so, pull off the road, shift to PARK (P) or NEUTRAL (N) and let the engine idle.
2. Set the temperature control to the highest heat setting and open the windows, as necessary.

If you no longer have the overheat warning, you can drive. Just to be safe, drive slower for about 10 minutes. If the warning doesn't come back on, you can drive normally.

If the warning continues, pull over, stop, and park your vehicle right away.

If there's still no sign of steam, idle the engine for three minutes while you're parked. If you still have the warning, *turn off the engine and get everyone out of the vehicle* until it cools down. Also, see "Overheated Engine Protection Operating Mode" listed previously in this section.

You may decide not to lift the hood but to get service help right away.

Cooling System

When you decide it's safe to lift the hood, here's what you'll see:

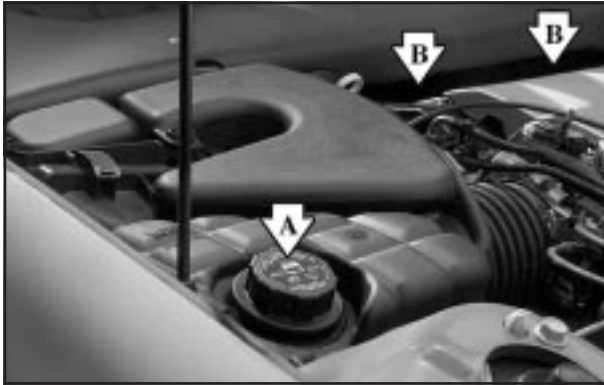

- A. Coolant Surge Tank with Pressure Cap
- B. Electric Engine Cooling Fans

CAUTION:

An electric engine cooling fan under the hood can start up even when the engine is not running and can injure you. Keep hands, clothing and tools away from any underhood electric fan.

If the coolant inside the coolant surge tank is boiling, don't do anything else until it cools down. The vehicle should be parked on a level surface.



A low coolant level should be indicated by a CHECK COOLANT LEVEL message on the Driver Information Center. If it is, you may have a leak at the pressure cap or in the radiator hoses, heater hoses, radiator, water pump or somewhere else in the cooling system.

⚠ CAUTION:

Heater and radiator hoses, and other engine parts, can be very hot. Do not touch them. If you do, you can be burned.

Do not run the engine if there is a leak. If you run the engine, it could lose all coolant. That could cause an engine fire, and you could be burned. Get any leak fixed before you drive the vehicle.

If there seems to be no leak, with the engine on, check to see if the electric engine cooling fans are running. If the engine is overheating, both fans should be running. If they aren't, your vehicle needs service.

Notice: Engine damage from running your engine without coolant isn't covered by your warranty. See "Overheated Engine Protection Operating Mode" in the Index for information on driving to a safe place in an emergency.

Notice: When adding coolant, it is important that you use only DEX-COOL[®] (silicate-free) coolant. If coolant other than DEX-COOL[®] is added to the system, premature engine, heater core or radiator corrosion may result. In addition, the engine coolant will require change sooner — at 30,000 miles (50 000 km) or 24 months, whichever occurs first. Damage caused by the use of coolant other than DEX-COOL[®] is not covered by your new vehicle warranty.

How to Add Coolant to the Coolant Surge Tank

If you haven't found a problem yet, check to see if coolant is visible in the surge tank. If coolant is visible but the coolant level isn't at or above the fill mark at the forward edge of the surge tank, add a 50/50 mixture of *clean, drinkable water* and DEX-COOL[®] coolant at the coolant surge tank, but be sure the cooling system, including the coolant surge tank pressure cap, is cool before you do it. See *Engine Coolant on page 5-25* for more information.

If no coolant is visible in the surge tank, add coolant as follows:

⚠ CAUTION:

Steam and scalding liquids from a hot cooling system can blow out and burn you badly. They are under pressure, and if you turn the coolant surge tank pressure cap — even a little — they can come out at high speed. Never turn the cap when the cooling system, including the coolant surge tank pressure cap, is hot. Wait for the cooling system and coolant surge tank pressure cap to cool if you ever have to turn the pressure cap.



 **CAUTION:**

Adding only plain water to your cooling system can be dangerous. Plain water, or some other liquid such as alcohol, can boil before the proper coolant mixture will. Your vehicle's coolant warning system is set for the proper coolant mixture. With plain water or the wrong mixture, your engine could get too hot but you would not get the overheat warning. Your engine could catch fire and you or others could be burned. Use a 50/50 mixture of clean, drinkable water and DEX-COOL[®] coolant.

Notice: In cold weather, water can freeze and crack the engine, radiator, heater core and other parts. Use the recommended coolant and the proper coolant mixture.

 **CAUTION:**

You can be burned if you spill coolant on hot engine parts. Coolant contains ethylene glycol and it will burn if the engine parts are hot enough. Do not spill coolant on a hot engine.



1. Park the vehicle on a level surface. You can remove the coolant surge tank pressure cap when the cooling system, including the coolant surge tank pressure cap and upper radiator hose, is no longer hot. Turn the pressure cap slowly counterclockwise (left) until it first stops. Don't press down while turning the pressure cap.
If you hear a hiss, wait for that to stop. A hiss means there is still some pressure left.
2. Press down on the pressure cap and keep turning it slowly. Remove the cap.

3. Then fill the coolant surge tank with the proper mixture, to or above the fill mark at the forward edge of the surge tank.



4. With the coolant surge tank pressure cap off, start the engine and let it run until you can feel the upper radiator hose getting hot. Watch out for the engine cooling fans.

By this time, the coolant level inside the coolant surge tank may be lower. If the level is lower, add more of the proper mixture to the coolant surge tank until the level reaches at or above the fill mark at the forward edge of the surge tank.



5. Then replace the pressure cap. Be sure the pressure cap is hand-tight and fully seated.

Start the engine and allow it to warm up. If the CHECK COOLANT LEVEL message does not appear on the Driver Information Center, coolant is at the proper fill level. If a CHECK COOLANT LEVEL message does appear, repeat Steps 1 to 3 and reinstall the pressure cap or see your dealer.

Power Steering Fluid

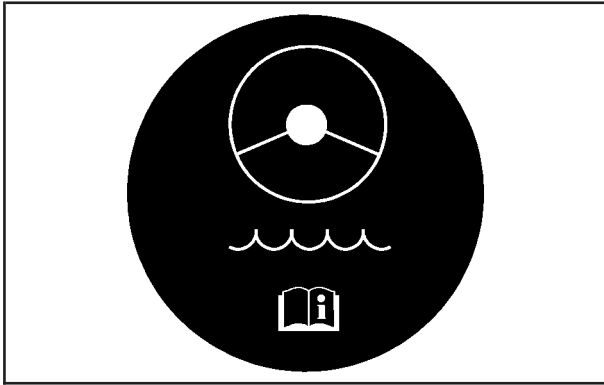

The power steering fluid reservoir is located next to the underhood fuse block on the passenger's side of the vehicle. See *Engine Compartment Overview on page 5-12* for more information on location.

When to Check Power Steering Fluid

It is not necessary to regularly check power steering fluid unless you suspect there is a leak in the system or you hear an unusual noise. A fluid loss in this system could indicate a problem. Have the system inspected and repaired.

How to Check Power Steering Fluid

Turn the key off, let the engine compartment cool down, wipe the cap and the top of the reservoir clean, then unscrew the cap and wipe the dipstick with a clean rag. Replace the cap and completely tighten it. Then remove the cap again and look at the fluid level on the dipstick.

The level should be at the FULL COLD mark. If necessary, add only enough fluid to bring the level up to the mark.

What to Use

To determine what kind of fluid to use, see *Part D: Recommended Fluids and Lubricants on page 6-15*. Always use the proper fluid. Failure to use the proper fluid can cause leaks and damage hoses and seals.

Windshield Washer Fluid

What to Use

When you need windshield washer fluid, be sure to read the manufacturer's instructions before use. If you will be operating your vehicle in an area where the temperature may fall below freezing, use a fluid that has sufficient protection against freezing.

Adding Washer Fluid

When your vehicle's windshield washer fluid level becomes low, a CHECK WASHER FLUID message will appear on the Driver Information Center (DIC). You will need to add fluid soon.

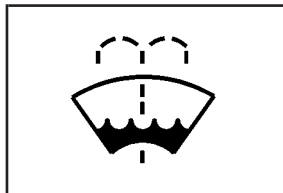

The windshield washer fluid reservoir is located next to the underhood fuse block on the passenger's side of the vehicle.

See *Engine Compartment Overview* on page 5-12 for reservoir location.

Open the cap with the washer symbol on it. Add washer fluid until the tank is full.

Notice:

- **When using concentrated washer fluid, follow the manufacturer's instructions for adding water.**
- **Don't mix water with ready-to-use washer fluid. Water can cause the solution to freeze and damage your washer fluid tank and other parts of the washer system. Also, water doesn't clean as well as washer fluid.**
- **Fill your washer fluid tank only three-quarters full when it's very cold. This allows for expansion if freezing occurs, which could damage the tank if it is completely full.**
- **Don't use engine coolant (antifreeze) in your windshield washer. It can damage your washer system and paint.**

Brakes

Brake Fluid



Your brake master cylinder reservoir is filled with DOT-3 brake fluid. See *Engine Compartment Overview on page 5-12* for the location of the reservoir.

There are only two reasons why the brake fluid level in the reservoir might go down. The first is that the brake fluid goes down to an acceptable level during normal brake lining wear. When new linings are put in, the fluid level goes back up. The other reason is

that fluid is leaking out of the brake system. If it is, you should have your brake system fixed, since a leak means that sooner or later your brakes will not work well, or will not work at all.

So, it is not a good idea to “top off” your brake fluid. Adding brake fluid will not correct a leak. If you add fluid when your linings are worn, then you will have too much fluid when you get new brake linings. You should add (or remove) brake fluid, as necessary, only when work is done on the brake hydraulic system.

CAUTION:

If you have too much brake fluid, it can spill on the engine. The fluid will burn if the engine is hot enough. You or others could be burned, and your vehicle could be damaged. Add brake fluid only when work is done on the brake hydraulic system.

If the ignition is in ON and the brake fluid is low, the CHECK BRAKE FLUID message will be displayed in the DIC. See *DIC Warnings and Messages on page 3-56*.

What to Add

When you do need brake fluid, use only DOT-3 brake fluid. Use new brake fluid from a sealed container only. See *Part D: Recommended Fluids and Lubricants* on page 6-15.

Always clean the brake fluid reservoir cap and the area around the cap before removing it. This will help keep dirt from entering the reservoir.

CAUTION:

With the wrong kind of fluid in your brake system, your brakes may not work well, or they may not even work at all. This could cause a crash. Always use the proper brake fluid.

Notice:

- **Using the wrong fluid can badly damage brake system parts. For example, just a few drops of mineral-based oil, such as engine oil, in your brake system can damage brake system parts so badly that they will have to be replaced. Do not let someone put in the wrong kind of fluid.**
- **If you spill brake fluid on your vehicle's painted surfaces, the paint finish can be damaged. Be careful not to spill brake fluid on your vehicle. If you do, wash it off immediately. See *Appearance Care* on page 5-83.**

Brake Wear

Your vehicle has four-wheel disc brakes.

Disc brake pads have built-in wear indicators that make a high-pitched warning sound when the brake pads are worn and new pads are needed. The sound may come and go or be heard all the time your vehicle is moving (except when you are pushing on the brake pedal firmly).

CAUTION:

The brake wear warning sound means that soon your brakes will not work well. That could lead to an accident. When you hear the brake wear warning sound, have your vehicle serviced.

Notice: Continuing to drive with worn-out brake pads could result in costly brake repair.

Some driving conditions or climates may cause a brake squeal when the brakes are first applied or lightly applied. This does not mean something is wrong with your brakes.

Properly torqued wheel nuts are necessary to help prevent brake pulsation. When tires are rotated, inspect brake pads for wear and evenly tighten wheel nuts in the proper sequence to GM torque specifications.

Brake linings should always be replaced as complete axle sets.

See *Brake System Inspection* on page 6-14.

Brake Pedal Travel

See your dealer if the brake pedal does not return to normal height, or if there is a rapid increase in pedal travel. This could be a sign of brake trouble.

Brake Adjustment

Every time you apply the brakes, with or without the vehicle moving, your brakes adjust for wear.

Replacing Brake System Parts

The braking system on a vehicle is complex. Its many parts have to be of top quality and work well together if the vehicle is to have really good braking. Your vehicle was designed and tested with top-quality GM brake parts. When you replace parts of your braking system — for example, when your brake linings wear down and you need new ones put in — be sure you get new approved replacement parts. If you do not, your brakes may no longer work properly. For example, if someone puts in brake linings that are wrong for your vehicle, the balance between your front and rear brakes can change — for the worse. The braking performance you have come to expect can change in many other ways if someone puts in the wrong replacement brake parts.

Battery

Your new vehicle comes with a maintenance free ACDelco® battery. When it's time for a new battery, get one that has the replacement number shown on the original battery's label. We recommend an ACDelco® battery.

Warning: Battery posts, terminals and related accessories contain lead and lead compounds, chemicals known to the State of California to cause cancer and reproductive harm. Wash hands after handling.

The battery is located under the rear seat cushion. To access the battery, see “Removing the Rear Seat Cushion”. You don't need to access the battery to jump start your vehicle. See *Jump Starting on page 5-45*.

CAUTION:

A battery that isn't properly vented can let sulfuric acid fumes into the area under the rear seat cushion. These fumes can damage your rear seat safety belt systems. You may not be able to see this damage, and the safety belts might not provide the protection needed in a crash. If a replacement battery is ever needed, it must be vented in the same manner as the original battery. Always make sure that the vent hose is properly reattached before reinstalling the seat cushion.

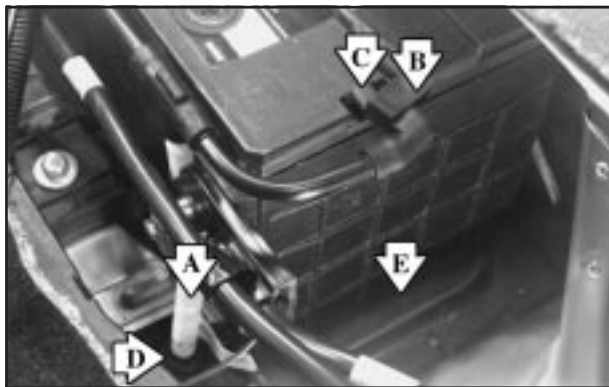

To be sure the vent hose (A) is properly attached, the vent hose connectors (B) must be securely reattached to the vent outlets (C) on each side of the battery, and the vent assembly grommet (D) must be secured to the floor pan (E).

Vehicle Storage

If you're not going to drive your vehicle for 25 days or more, remove the black, negative (-) cable from the battery. This will help keep your battery from running down.

CAUTION:

Batteries have acid that can burn you and gas that can explode. You can be badly hurt if you are not careful. See *Jump Starting on page 5-45 for tips on working around a battery without getting hurt.*

Contact your dealer to learn how to prepare your vehicle for longer storage periods.

Also, for your audio system, see *Theft-Deterrent Feature on page 3-102.*

To re-program the power windows, see *Power Windows on page 2-16.*

Jump Starting

If your battery has run down, you may want to use another vehicle and some jumper cables to start your vehicle. Be sure to follow the steps below to do it safely.

CAUTION:

Batteries can hurt you. They can be dangerous because:

- They contain acid that can burn you.
- They contain gas that can explode or ignite.
- They contain enough electricity to burn you.

If you do not follow these steps exactly, some or all of these things can hurt you.

Notice: Ignoring these steps could result in costly damage to your vehicle that wouldn't be covered by your warranty.

Trying to start your vehicle by pushing or pulling it won't work, and it could damage your vehicle.

1. Check the other vehicle. It must have a 12-volt battery with a negative ground system.

Notice: If the other system isn't a 12-volt system with a negative ground, both vehicles can be damaged.

2. Get the vehicles close enough so the jumper cables can reach, but be sure the vehicles aren't touching each other. If they are, it could cause a ground connection you don't want. You wouldn't be able to start your vehicle and the bad grounding could damage the electrical systems.

To avoid the possibility of the vehicles rolling, set the parking brake firmly on both vehicles involved in the jump start procedure. Put an automatic transaxle in PARK (P) or a manual transaxle in NEUTRAL before setting the parking brake.

Notice: If you leave your radio on, it could be badly damaged. The repairs wouldn't be covered by your warranty.

3. Turn off the ignition on both vehicles. Unplug unnecessary accessories plugged into the cigarette lighter or in the accessory power outlets. Turn off the radio and all lamps that aren't needed. This will avoid sparks and help save both batteries. And it could save your radio!

4. Open the hoods and locate the positive (+) and negative (-) terminal locations on the other vehicle. Your vehicle has a remote (+) jump starting terminal and a remote negative (-) jump starting terminal. You should always use these remote terminals instead of the terminals on the battery.



The remote positive (+) terminal is located in the engine compartment on the passenger's side of the vehicle. A second remote positive (+) terminal is located on the rear underseat fuse block. Lift the red plastic cap to access the terminal.

The remote negative (-) terminal is located near the power steering fluid reservoir. It is marked "GND (-)." See *Engine Compartment Overview* on page 5-12 for more information on location.

You will not see the battery of your vehicle under the hood. It is located under the rear passenger's seat. You will not need to access the battery for jump starting. The remote positive (+) terminal is for that purpose.

⚠ CAUTION:

An electric fan can start up even when the engine is not running and can injure you. Keep hands, clothing and tools away from any underhood electric fan.

 **CAUTION:**

Using a match near a battery can cause battery gas to explode. People have been hurt doing this, and some have been blinded. Use a flashlight if you need more light.

Be sure the battery has enough water. You do not need to add water to the ACDelco® battery installed in your new vehicle. But if a battery has filler caps, be sure the right amount of fluid is there. If it is low, add water to take care of that first. If you do not, explosive gas could be present.

Battery fluid contains acid that can burn you. Do not get it on you. If you accidentally get it in your eyes or on your skin, flush the place with water and get medical help immediately.

 **CAUTION:**

Fans or other moving engine parts can injure you badly. Keep your hands away from moving parts once the engine is running.

5. Check that the jumper cables don't have loose or missing insulation. If they do, you could get a shock. The vehicles could also be damaged, too. Before you connect the cables, here are some basic things you should know. Positive (+) will go to positive (+) or to a remote positive (+) terminal if the vehicle has one. Negative (-) will go to a heavy, unpainted metal engine part or to a remote negative (-) terminal if the vehicle has one. Don't connect positive (+) to the negative (-) or you will get a short that would damage the battery and maybe other parts, too. And don't connect the negative (-) cable to negative (-) terminal on the dead battery because this can cause sparks.



6. Connect the red positive (+) cable to the remote positive (+) terminal location on the vehicle with the dead battery. Use a remote positive (+) terminal if the vehicle has one.



8. Now connect the black negative (-) cable to the negative (-) terminal location of the vehicle with the good battery. Use a remote negative (-) terminal if the vehicle has one.



7. Don't let the other end of the cable touch metal. Connect it to the positive (+) terminal location of the vehicle with the good battery. Use a remote positive (+) terminal if the vehicle has one.

Don't let the other end of the cable touch anything until the next step. The other end of the negative (-) cable *doesn't* go to the dead battery. It goes to a heavy, unpainted metal engine part or to a remote negative (-) terminal on the vehicle with the dead battery.



9. Connect the other end of the negative (-) cable to the negative (-) terminal location on the vehicle with the dead battery. Your vehicle has a remote negative (-) terminal marked GND (-).

11. Try to start the vehicle with the dead battery. If it won't start after a few tries, it probably needs service.

Notice: Damage to your vehicle may result from electrical shorting if jumper cables are removed incorrectly. To prevent electrical shorting, take care that the cables don't touch each other or any other metal. The repairs wouldn't be covered by your warranty.

10. Now start the vehicle with the good battery and run the engine for a while.

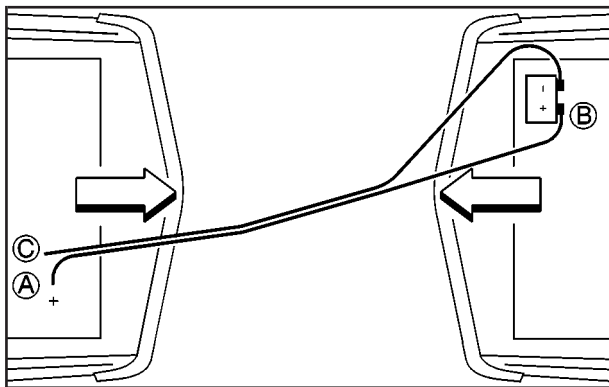

Jumper Cable Removal

- A. Dead Battery or Remote Positive (+) Terminal
- B. Good Battery or Remote Positive (+) and Remote Negative (-) Terminals
- C. Heavy, Unpainted Metal Engine Part or Remote Negative (-) Terminal (GND)

To disconnect the jumper cables from both vehicles, do the following:

1. Disconnect the black negative (-) cable from the vehicle that had the dead battery.
2. Disconnect the black negative (-) cable from the vehicle with the good battery.
3. Disconnect the red positive (+) cable from the vehicle with the good battery.
4. Disconnect the red positive (+) cable from the other vehicle.
5. Return the remote positive (+) terminal cover to its original position.

Headlamp Aiming

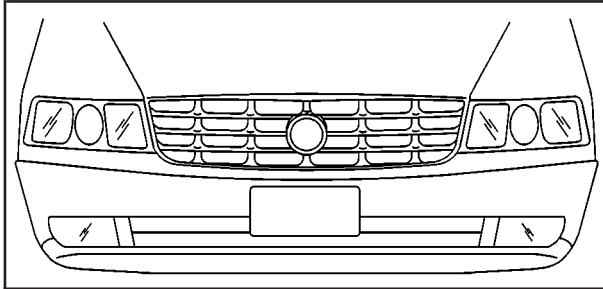

Your vehicle has a visual optical headlamp aiming system equipped with horizontal aim indicators. The aim has been preset at the factory and should need no further adjustment. This is true even though your horizontal aim indicators may not fall exactly on the “0” (zero) marks on their scales.

If your vehicle is damaged in an accident, the headlamp aim may be affected. Aim adjustment to the low beam may be necessary if it is difficult to see lane markers (for horizontal aim), or if oncoming drivers flash their high beams at you (for vertical aim). If you believe your headlamps need to be re-aimed, we recommend that you take your vehicle to your dealer for service. However, it is possible for you to re-aim your headlamps as described in the following procedure.

Notice: To make sure your headlamps are aimed properly, read all the instructions before beginning. Failure to follow these instructions could cause damage to headlamp parts.

The vehicle should be properly prepared as follows:

- The vehicle should be placed so the headlamps are 25 ft. (7.6 m) from a light colored wall or other flat surface.
- The vehicle must have all four tires on a perfectly level surface which is level all the way to the wall or other flat surface.
- The vehicle should be placed so it is perpendicular to the wall or other flat surface.
- The vehicle should not have any snow, ice or mud attached to it.
- The vehicle should be fully assembled and all other work stopped while headlamp aiming is being done.
- The vehicle should be normally loaded with a full tank of fuel and one person or 160 lbs (75 kg) on the driver's seat.
- Tires should be properly inflated.
- Start the vehicle and rock it to level the suspension.

Headlamp aiming is done with the vehicle low beam lamps. The high beam lamps will be correctly aimed if the low beam lamps are aimed properly.

The headlamp aiming devices are under the hood near the headlamps.

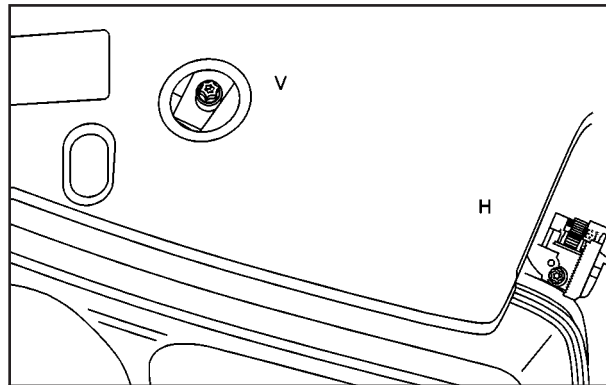

If you believe your headlamps need horizontal (left/right) adjustment, follow the horizontal aiming procedure. If you believe your headlamps need only vertical (up/down) adjustment, follow only the vertical aiming procedure.

Adjustment screws can be turned with an E8 Torx[®] socket or T15 Torx screwdriver.

Headlamp Horizontal Aiming

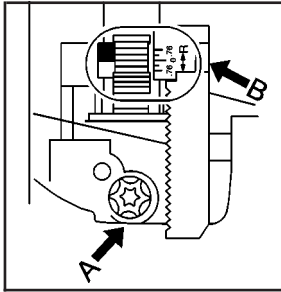

Turn the horizontal aiming screw (A) until the indicator (B) is lined up with zero.

Once the horizontal aim is adjusted, then adjust the vertical aim.

Headlamp Vertical Aiming

Notice: Horizontal aiming must be performed before making any adjustments to the vertical aim. Adjusting the vertical aim first will result in an incorrect headlamp aim.

1. Find the aim dot on the lens of the low beam lamps.

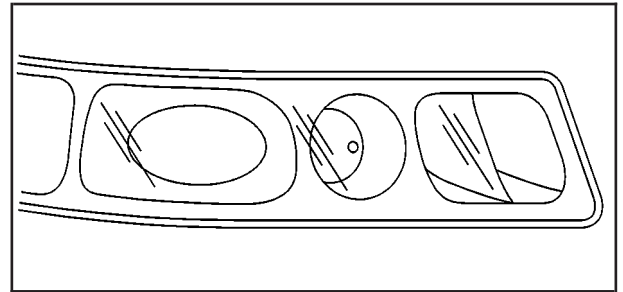

2. Measure the distance from the ground to the aim dot on each low beam lamp. Record this distance.

3. At the wall or other flat surface, measure from the ground upward the recorded distance from Step 2 and draw or tape a horizontal line the width of the vehicle.

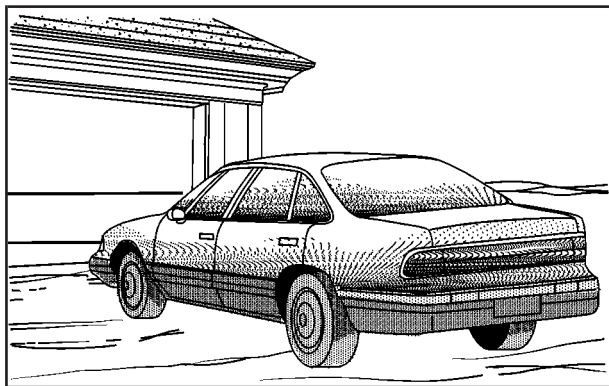

Notice: Do not cover a headlamp to improve beam cut-off when aiming. Covering a headlamp may cause excessive heat build-up which may cause damage to the headlamp.

4. Turn on the low-beam headlamps and place a piece of cardboard or equivalent in front of the headlamp not being aimed. This should allow only the beam of light from the headlamp being aimed to be seen on the flat surface.

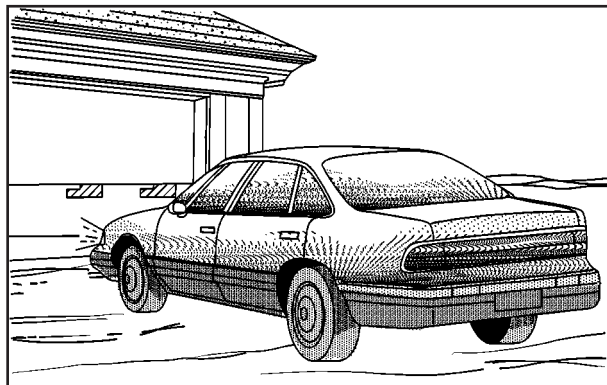

- Turn the vertical aiming screw (C) until the headlamp beam is aimed to the horizontal tape line. The top edge of the cut-off should be positioned at the bottom edge of the horizontal tape line.

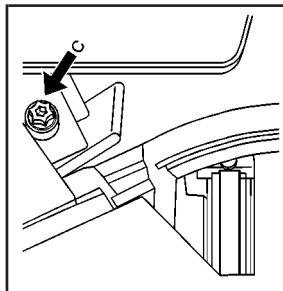

- Repeat Steps 4 and 5 for the opposite headlamp.

Bulb Replacement

For the proper type of replacement bulb, see *Replacement Bulbs on page 5-61*.

For any bulb changing procedure not listed in this section, contact your dealer.

High Intensity Discharge (HID) Lighting

CAUTION:

The low beam high intensity discharge lighting system operates at a very high voltage. If you try to service any of the system components, you could be seriously injured. Have your dealer or a qualified technician service them.

Your vehicle may have HID headlamps. After your vehicle's HID headlamp bulb has been replaced, you may notice that the beam is a slightly different shade than it was originally. This is normal.

Halogen Bulbs

CAUTION:

Halogen bulbs have pressurized gas inside and can burst if you drop or scratch the bulb. You or others could be injured. Be sure to read and follow the instructions on the bulb package.

Headlamps

1. Open the hood.
2. Remove the upper filler panel by loosening all the screws and then removing the grommets.

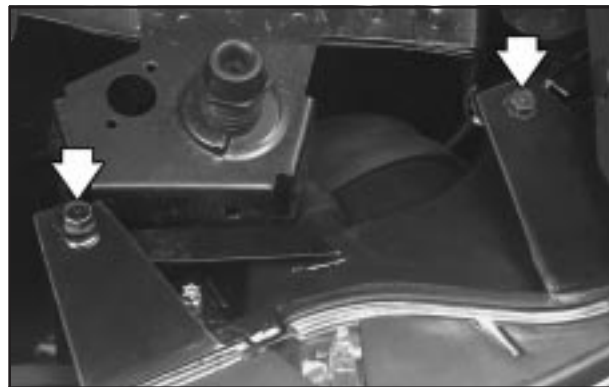

3. Remove the two bolts fastening the headlamp to the headlamp mounting bracket.
4. Pull the headlamp straight forward to disengage the locator pin at the outboard edge of the headlamp.



5. To replace the low-beam bulb, first remove the rubber housing cover on the rear of the lamp.



6. Then, turn the bulb socket counterclockwise to unlock the socket from the lamp housing.



7. Remove the headlamp bulb socket.



8. After removing the wiring harness connector from the headlamp bulb socket, replace the bulb assembly. Reconnect it to the wiring harness and reinstall the headlamp bulb assembly back into the headlamp housing.

9. After reinstalling the bulb and socket, reinstall the rubber cover. Make sure it fully covers the headlamp socket.
10. To replace the high-beam bulb, turn the bulb socket counterclockwise to unlock the socket from the lamp housing. Follow the instructions in Step 6 through 8 to install the new bulb.
11. Reinstall the upper filler panel by inserting the grommets, along with the screws, back into the holes.

Front Turn Signal Lamps

1. The turn signal lamps are located on the outboard side of the headlamps. To access, remove the headlamp. See Steps 1, 2, 3, and 10 under *Headlamps on page 5-56*.



2. Press the bulb socket tab and turn the bulb socket counterclockwise to unlock the socket from the lamp housing.
3. To remove the old bulb, grasp the socket firmly and pull the bulb out.
4. Install the new bulb and reverse the steps to reinstall the lamp housing.

Center High-Mounted Stoplamp (CHMSL)

It is recommended that this component be replaced as a unit. See your dealer.

Taillamps and Turn Signal Lamps

1. Open the trunk to gain access to the lamp housing.



2. Remove the rear compartment sill plate by removing the upper convenience net retainers, located at each end, as shown.

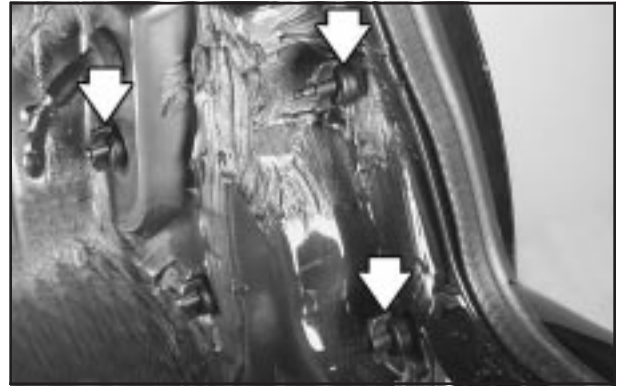

5. Remove the three wing nuts that fasten the taillamp to the body.
6. Gently remove the taillamp from the body. The taillamp is on the bottom of the housing and the rear turn signal lamp is on the upper part of the housing.

3. Move the spare tire cover out of the way.
4. Pull the trunk trim away to access the wing nuts.



7. Press the bulb socket tab and turn the socket counterclockwise to remove it. To remove the bulb, grasp the socket firmly and pull the bulb out.

Once you have replaced the burned-out bulb, reverse the steps to reassemble the lamp assembly.

Replacement Bulbs

For any bulb not listed here contact your dealer.

| Exterior Lamp | Bulb Number |
|-----------------------------|-------------|
| Front Turn Signal | 2357NA |
| Headlamps, Composite | |
| High Beam | 9005HB3 |
| Low Beam | 9006HB4 |
| Rear Turn Signal | 3057 |
| Stop/Taillamp | 3057 |

Windshield Wiper Blade Replacement

Windshield wiper blades should be inspected at least twice a year for wear or cracking. See *Wiper Blade Check* under *At Least Twice a Year on page 6-10* for more information.

It's a good idea to clean or replace the wiper blade assembly on a regular basis or when worn. For proper windshield wiper blade length and type, see *Normal Maintenance Replacement Parts on page 5-101*.

To replace the wiper blade assembly do the following:

1. Lift the wiper up from the windshield and set into the vertically-locked position.

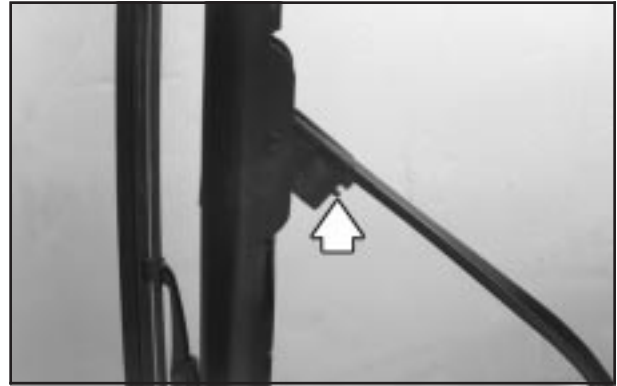

2. Press the tab that holds the wiper blade to the arm.
3. Slide the blade down and off the arm.
4. Slide in the new blade and snap into place.

Tires

Your new vehicle comes with high-quality tires made by a leading tire manufacturer. If you ever have questions about your tire warranty and where to obtain service, see your Cadillac Warranty booklet for details.

CAUTION:

- Poorly maintained and improperly used tires are dangerous.
- Overloading your tires can cause overheating as a result of too much friction. You could have an air-out and a serious accident. See “Loading Your Vehicle” in the Index.

CAUTION: (Continued)

CAUTION: (Continued)

- Underinflated tires pose the same danger as overloaded tires. The resulting accident could cause serious injury. Check all tires frequently to maintain the recommended pressure. Tire pressure should be checked when your tires are cold.
- Overinflated tires are more likely to be cut, punctured or broken by a sudden impact— such as when you hit a pothole. Keep tires at the recommended pressure.
- Worn, old tires can cause accidents. If your tread is badly worn, or if your tires have been damaged, replace them. See “Inflation – Tire Pressure” in this section for inflation pressure adjustment for higher speed driving.

Inflation -- Tire Pressure

The Tire-Loading Information label, which is located on the rear edge of the driver's side rear door, shows the correct inflation pressures for your tires when they're cold. "Cold" means your vehicle has been sitting for at least three hours or driven no more than 1 mile (1.6 km).

If you'll be driving at high speeds (e.g., speeds of 100 mph (160 km/h) or higher), where it is legal, set the cold inflation pressure to the maximum inflation pressure shown on the tire sidewall, or to 38 psi (265 kPa), whichever is lower. See the example below. When you end this high-speed driving, return to the cold inflation pressure shown on the Tire-Loading Information label.

Example:

You'll find maximum load and inflation pressure molded on the tire's sidewall, in small letters, near the rim flange. It will read something like this: Maximum load 690 kg (1521 lbs) 300 kPa (44 psi) Max. Press.

For this example, you would set the inflation pressure for high-speed driving at 38 psi (265 kPa).

Notice: Don't let anyone tell you that underinflation or overinflation is all right. It's not. If your tires don't have enough air (underinflation), you can get the following:

- Too much flexing
- Too much heat
- Tire overloading
- Bad wear
- Bad handling
- Bad fuel economy

If your tires have too much air (overinflation), you can get the following:

- Unusual wear
- Bad handling
- Rough ride
- Needless damage from road hazards

When to Check

Check your tires once a month or more.

Don't forget your compact spare tire. It should be at 60 psi (420 kPa).

How to Check

Use a good quality pocket-type gage to check tire pressure. You can't tell if your tires are properly inflated simply by looking at them. Radial tires may look properly inflated even when they're underinflated.

Be sure to put the valve caps back on the valve stems. They help prevent leaks by keeping out dirt and moisture.

Tire Pressure Monitor System

Your vehicle may have a Tire Pressure Monitor System (TPM). The TPM system uses radio and sensor technology to check tire pressure levels. Sensors, mounted on each road wheel, transmit tire pressure readings to a receiver located in the trunk. Tire pressure status and tire pressure warnings are shown on the Driver Information Center (DIC) display. See *Driver Information Center (DIC)* on page 3-53, for details regarding DIC controls and displays.

The system operates on a radio frequency subject to Federal Communications Commission (FCC) Rules and with Industry and Science Canada.

This device complies with Part 15 of the FCC Rules. Operation is subject to the following two conditions: (1) this device may not cause harmful interference, and (2) this device must accept any interference received, including interference that may cause undesired operation.

This device complies with RSS-210 of Industry and Science Canada. Operation is subject to the following two conditions: (1) this device may not cause interference, and (2) this device must accept any interference received, including interference that may cause undesired operation of the device.

Changes or modifications to this system by anyone other than an authorized service facility could void authorization to use this equipment.

If the TPM system detects low tire pressure, below 25 psi (172 kPa), or high tire pressure, above 38 psi (262 kPa), a message, CHECK TIRE PRESSURE, will appear on the Driver Information Center (DIC) display. By pressing the INFO button, the DIC screen will show which tire(s) has the low or high pressure condition. See *Inflation -- Tire Pressure on page 5-64* for information regarding correct tire inflation. If a tire is low, you should stop as soon as possible and check all your tires for damage. If a tire is flat, see *If a Tire Goes Flat on page 5-73*.

Notice: Do not use a tire sealant if your vehicle is equipped with Tire Pressure Monitors. The liquid sealant can damage the tire pressure monitor sensors.

Once a low or high tire pressure condition is detected, the TPM system will display the CHECK TIRE MESSAGE each time the engine is started, until the tire(s) are set to the correct inflation pressure.

The Tire-Loading Information Label, which is located on the rear edge of the driver's door, shows the correct inflation pressure for the tires on your vehicle.

The TPM system also allows the driver to check the air pressure status of each road tire using the Driver Information Center (DIC). Each tire's air pressure will be

listed individually, in the following order: LF (left front or driver's side front tire), RF (right front or passenger's side front tire), RR (right rear or passenger's side rear tire) and LR (left rear or driver's side rear tire). See *Inflation -- Tire Pressure on page 5-64* for information regarding correct tire inflation. Also, see *Driver Information Center (DIC) on page 3-53* for information on the DIC controls and displays.

If the DIC display doesn't show tire pressures or the SERVICE TPM SYSTEM message appears, see your dealer for service. The TPM system may not work properly while the compact spare tire is installed.

Anytime you replace one or more tires or rotate your tires, the TPM system will need to be reset. A special tool is needed to reset the sensor identification codes. See your dealer for service.

Your vehicle was delivered from the factory with aluminum valve stem caps. If you ever have to replace the valve stem caps on your vehicle, you should replace them with aluminum or plastic caps.

The TPM system can alert you about a low or high tire pressure condition, but it doesn't replace normal tire maintenance. See *Tires on page 5-63*.

Tire Inspection and Rotation

Tires should be rotated every 7,500 miles (12 500 km).

Any time you notice unusual wear, rotate your tires as soon as possible and check wheel alignment. Also check for damaged tires or wheels. See *When It Is Time for New Tires* on page 5-68 and *Wheel Replacement* on page 5-71 for more information.

The purpose of regular rotation is to achieve more uniform wear for all tires on the vehicle. The first rotation is the most important. See *Part A: Scheduled Maintenance Services* on page 6-4 for scheduled rotation intervals.

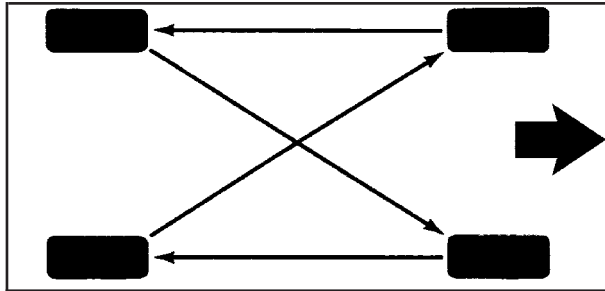

When rotating your tires, always use the correct rotation pattern shown here.

Don't include the compact spare tire in your tire rotation.

After the tires have been rotated, adjust the front and rear inflation pressures as shown on the Tire-Loading Information label.

Vehicles equipped with the Tire Pressure Monitor (TPM) system will need to have the sensors reset after a tire rotation is performed. A special tool is needed to reset the sensor identification codes. See your dealer for service.

Make certain that all wheel nuts are properly tightened. See "Wheel Nut Torque" under *Capacities and Specifications* on page 5-100.

CAUTION:

Rust or dirt on a wheel, or on the parts to which it is fastened, can make wheel nuts become loose after a time. The wheel could come off and cause an accident. When you change a wheel, remove any rust or dirt from places where the wheel attaches to the vehicle. In an emergency, you can use a cloth or a paper towel to do this; but be sure to use a scraper or wire brush later, if you need to, to get all the rust or dirt off. See "Changing a Flat Tire" in the Index.

When It Is Time for New Tires

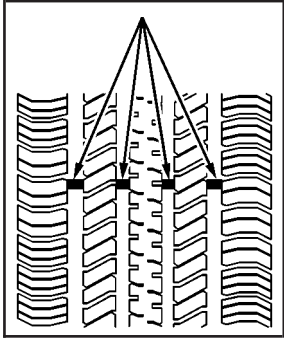

One way to tell when it's time for new tires is to check the treadwear indicators, which will appear when your tires have only 1/16 inch (1.6 mm) or less of tread remaining.

You need a new tire if any of the following statements are true:

- You can see the indicators at three or more places around the tire.
- You can see cord or fabric showing through the tire's rubber.
- The tread or sidewall is cracked, cut or snagged deep enough to show cord or fabric.
- The tire has a bump, bulge or split.
- The tire has a puncture, cut or other damage that can't be repaired well because of the size or location of the damage.

Buying New Tires

To find out what kind and size of tires you need, look at the Tire-Loading Information label.

The tires installed on your vehicle when it was new had a Tire Performance Criteria Specification (TPC Spec) number on each tire's sidewall. When you get new tires, get ones with that same TPC Spec number. That way your vehicle will continue to have tires that are designed to give proper endurance, handling, speed rating, traction, ride and other things during normal service on your vehicle. If your tires have an all-season tread design, the TPC number will be followed by an "MS" (for mud and snow).

If you ever replace your tires with those not having a TPC Spec number, make sure they are the same size, load range, speed rating and construction type (bias, bias-belted or radial) as your original tires.

 **CAUTION:**

Mixing tires could cause you to lose control while driving. If you mix tires of different sizes or types (radial and bias-belted tires), the vehicle may not handle properly, and you could have a crash. Using tires of different sizes may also cause damage to your vehicle. Be sure to use the same size and type tires on all wheels. It's all right to drive with your compact spare temporarily, it was developed for use on your vehicle. See "Compact Spare Tire" in the index.

 **CAUTION:**

If you use bias-ply tires on your vehicle, the wheel rim flanges could develop cracks after many miles of driving. A tire and/or wheel could fail suddenly, causing a crash. Use only radial-ply tires with the wheels on your vehicle.

Uniform Tire Quality Grading

Quality grades can be found where applicable on the tire sidewall between tread shoulder and maximum section width. For example:

Treadwear 200 Traction AA Temperature A

The following information relates to the system developed by the United States National Highway Traffic Safety Administration, which grades tires by treadwear, traction and temperature performance. (This applies only to vehicles sold in the United States.) The grades are molded on the sidewalls of most passenger car tires. The Uniform Tire Quality Grading system does not apply to deep tread, winter-type snow tires, space-saver or temporary use spare tires, tires with nominal rim diameters of 10 to 12 inches (25 to 30 cm), or to some limited-production tires.

While the tires available on General Motors passenger cars and light trucks may vary with respect to these grades, they must also conform to federal safety requirements and additional General Motors Tire Performance Criteria (TPC) standards.

Treadwear

The treadwear grade is a comparative rating based on the wear rate of the tire when tested under controlled conditions on a specified government test course. For example, a tire graded 150 would wear one and a half (1.5) times as well on the government course as a tire graded 100. The relative performance of tires depends upon the actual conditions of their use, however, and may depart significantly from the norm due to variations in driving habits, service practices and differences in road characteristics and climate.

Traction – AA, A, B, C

The traction grades, from highest to lowest, are AA, A, B, and C. Those grades represent the tire's ability to stop on wet pavement as measured under controlled conditions on specified government test surfaces of asphalt and concrete. A tire marked C may have poor traction performance. Warning: The traction grade assigned to this tire is based on straight-ahead braking traction tests, and does not include acceleration, cornering, hydroplaning, or peak traction characteristics.

Temperature – A, B, C

The temperature grades are A (the highest), B, and C, representing the tire's resistance to the generation of heat and its ability to dissipate heat when tested under controlled conditions on a specified indoor laboratory test wheel. Sustained high temperature can cause the material of the tire to degenerate and reduce tire life, and excessive temperature can lead to sudden tire failure. The grade C corresponds to a level of performance which all passenger car tires must meet under the Federal Motor Vehicle Safety Standard No. 109. Grades B and A represent higher levels of performance on the laboratory test wheel than the minimum required by law.

Warning: The temperature grade for this tire is established for a tire that is properly inflated and not overloaded. Excessive speed, underinflation, or excessive loading, either separately or in combination, can cause heat buildup and possible tire failure.

Wheel Alignment and Tire Balance

The wheels on your vehicle were aligned and balanced carefully at the factory to give you the longest tire life and best overall performance.

Scheduled wheel alignment and wheel balancing are not needed. However, if you notice unusual tire wear or your vehicle pulling one way or the other, the alignment may need to be reset. If you notice your vehicle vibrating when driving on a smooth road, your wheels may need to be rebalanced.

Wheel Replacement

Replace any wheel that is bent, cracked or badly rusted or corroded. If wheel nuts keep coming loose, the wheel, wheel bolts and wheel nuts should be replaced. If the wheel leaks air, replace it (except some aluminum wheels, which can sometimes be repaired). See your dealer if any of these conditions exist.

Your dealer will know the kind of wheel you need.

Each new wheel should have the same load-carrying capacity, diameter, width, offset and be mounted the same way as the one it replaces.

If you need to replace any of your wheels, wheel bolts or wheel nuts, replace them only with new GM original equipment parts. This way, you will be sure to have the right wheel, wheel bolts and wheel nuts for your vehicle.

CAUTION:

Using the wrong replacement wheels, wheel bolts or wheel nuts on your vehicle can be dangerous. It could affect the braking and handling of your vehicle, make your tires lose air and make you lose control. You could have a collision in which you or others could be injured. Always use the correct wheel, wheel bolts and wheel nuts for replacement.

Notice: The wrong wheel can also cause problems with bearing life, brake cooling, speedometer or odometer calibration, headlamp aim, bumper height, vehicle ground clearance and tire or tire chain clearance to the body and chassis.

See *Changing a Flat Tire* on page 5-74 for more information.

Used Replacement Wheels

CAUTION:

Putting a used wheel on your vehicle is dangerous. You can't know how it's been used or how far it's been driven. It could fail suddenly and cause a crash. If you have to replace a wheel, use a new GM original equipment wheel.

Tire Chains

CAUTION:

If your vehicle has P235/55R17 size tires, don't use tire chains, there's not enough clearance.

Tire chains used on a vehicle without the proper amount of clearance can cause damage to the brakes, suspension or other vehicle parts. The area damaged by the tire chains could cause you to lose control of your vehicle and you or others may be injured in a crash.

Use another type of traction device only if its manufacturer recommends it for use on your vehicle and tire size combination and road conditions. Follow that manufacturer's instructions. To help avoid damage to your vehicle, drive slowly, readjust or remove the device if it's contacting your vehicle, and don't spin your wheels.

If you do find traction devices that will fit, install them on the front tires.

Notice: If your vehicle has a tire size other than P235/55R17 size tires, use tire chains only where legal and only when you must. Use only SAE Class “S” type chains that are the proper size for your tires. Install them on the front tires and tighten them as tightly as possible with the ends securely fastened. Drive slowly and follow the chain manufacturer’s instructions. If you can hear the chains contacting your vehicle, stop and retighten them. If the contact continues, slow down until it stops. Driving too fast or spinning the wheels with chains on will damage your vehicle.

If a Tire Goes Flat

It’s unusual for a tire to “blowout” while you’re driving, especially if you maintain your tires properly. If air goes out of a tire, it’s much more likely to leak out slowly. But if you should ever have a “blowout,” here are a few tips about what to expect and what to do:

If a front tire fails, the flat tire will create a drag that pulls the vehicle toward that side. Take your foot off the accelerator pedal and grip the steering wheel firmly. Steer to maintain lane position, and then gently brake to a stop well out of the traffic lane.

A rear blowout, particularly on a curve, acts much like a skid and may require the same correction you’d use in a skid. In any rear blowout, remove your foot from the accelerator pedal. Get the vehicle under control by steering the way you want the vehicle to go. It may be very bumpy and noisy, but you can still steer. Gently brake to a stop, well off the road if possible.

CAUTION:

Lifting a vehicle and getting under it to do maintenance or repairs is dangerous without the appropriate safety equipment and training. The jack provided with your vehicle is designed only for changing a flat tire. If it is used for anything else, you or others could be badly injured or killed if the vehicle slips off the jack. Use the jack provided with your vehicle only for changing a flat tire.

If a tire goes flat, the next part shows how to use your jacking equipment to change a flat tire safely.

Changing a Flat Tire

If a tire goes flat, avoid further tire and wheel damage by driving slowly to a level place. Turn on your hazard warning flashers.

CAUTION:

Changing a tire can cause an injury. The vehicle can slip off the jack and roll over you or other people. You and they could be badly injured. Find a level place to change your tire. To help prevent the vehicle from moving:

1. Put the shift lever in PARK (P).
2. Set the parking brake firmly.
3. Turn off the engine.

To be even more certain the vehicle won't move, you can put blocks at the front and rear of the tire farthest away from the one being changed. That would be the tire on the other side of the vehicle, at the opposite end.

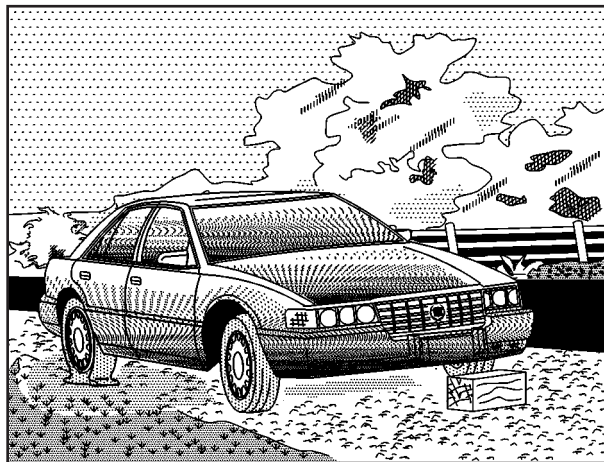

The following steps will tell you how to use the jack and change a tire.

Removing the Spare Tire and Tools

The equipment you'll need is in the trunk.

Instructions for changing your tires are on the inside of the tire cover located in your trunk.

To gain access to the instructions, spare tire and jacking equipment, do the following:



1. Press the area at the front of the handle located on the cover so that the back edge raises.



2. Grab the handle and remove the cover.



3. Unscrew the wing nuts to remove the container that holds the wrench and jack.

4. Remove the wheel wrench, jack and compact spare tire from the trunk. See *Compact Spare Tire* on page 5-83 for more information about the compact spare tire.



The tools you'll be using include the jack (A) and the wheel wrench (B).

Removing the Flat Tire and Installing the Spare Tire



1. Using the wheel wrench, loosen all the wheel nuts. Don't remove them yet.

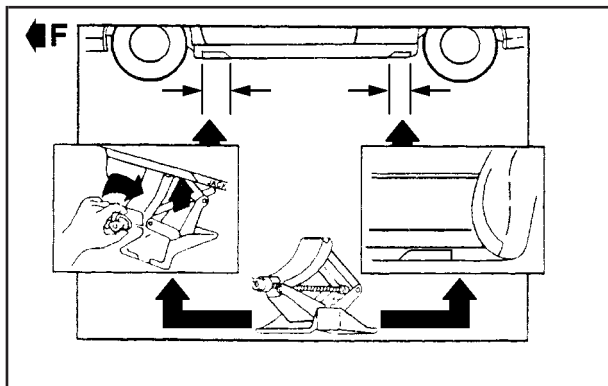

- Find the jacking location from the diagram above and corresponding hoisting notches located in the plastic molding. The front location is 9.0 inches (23 cm) from the rear edge of the front wheel well, and the rear location is 2.5 inches (7 cm) from the front edge of the rear wheel well.

⚠ CAUTION:

Getting under a vehicle when it is jacked up is dangerous. If the vehicle slips off the jack you could be badly injured or killed. Never get under a vehicle when it is supported only by a jack.

⚠ CAUTION:

Raising your vehicle with the jack improperly positioned can damage the vehicle and even make the vehicle fall. To help avoid personal injury and vehicle damage, be sure to fit the jack lift head into the proper location before raising the vehicle.

- Turn the jack handle counterclockwise to lower the jack lift head until the jack fits under the vehicle.
- Raise the jack until the metal flange fits firmly into the channel of the jack head.

5. Put the compact spare tire near you.



6. Raise the vehicle by turning the jack handle clockwise. Raise the vehicle far enough off the ground for the compact spare tire to fit under the vehicle.
7. Remove all wheel nuts and take off the flat tire.

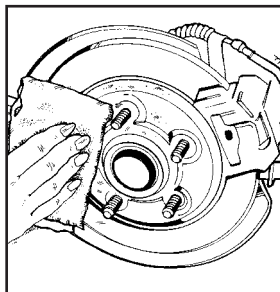

8. Remove any rust or dirt from the wheel bolts, mounting surfaces and spare wheel.

⚠ CAUTION:

Rust or dirt on the wheel, or on the parts to which it is fastened, can make the wheel nuts become loose after a time. The wheel could come off and cause an accident. When you change a wheel, remove any rust or dirt from the places where the wheel attaches to the vehicle. In an emergency, you can use a cloth or a paper towel to do this; but be sure to use a scraper or wire brush later, if you need to, to get all the rust or dirt off.

⚠ CAUTION:

Never use oil or grease on studs or nuts. If you do, the nuts might come loose. Your wheel could fall off, causing a serious accident.



9. Place the compact spare tire on the wheel-mounting surface.



10. Reinstall the wheel nuts with the rounded end of the nuts toward the wheel. Tighten each nut by hand until the wheel is held against the hub.



11. Lower the vehicle by turning the jack handle counterclockwise. Lower the jack completely.

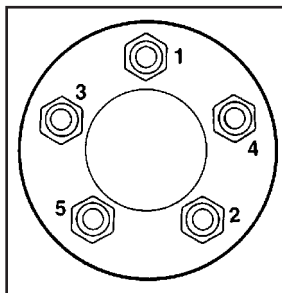

12. Tighten the wheel nuts firmly in a crisscross sequence as shown.

Screw on the wheel nut covers with your fingers, then tighten one-quarter turn with the wheel wrench.

⚠ CAUTION:

Incorrect wheel nuts or improperly tightened wheel nuts can cause the wheel to come loose and even come off. This could lead to an accident. Be sure to use the correct wheel nuts. If you have to replace them, be sure to get new GM original equipment wheel nuts.

CAUTION: (Continued)

CAUTION: (Continued)

Stop somewhere as soon as you can and have the nuts tightened with a torque wrench to the proper torque specification. See “Capacities and Specifications” in the Index for wheel nut torque specification.

Notice: Improperly tightened wheel nuts can lead to brake pulsation and rotor damage. To avoid expensive brake repairs, evenly tighten the wheel nuts in the proper sequence and to the proper torque specification. See “Capacities and Specifications” in the index for the wheel nut torque specification.

Don't try to put a wheel cover on your compact spare tire. It won't fit. Store the wheel cover and lug nut caps in the trunk until you have the flat tire repaired or replaced.

Notice: Wheel covers won't fit on your compact spare. If you try to put a wheel cover on your compact spare, you could damage the cover or the spare.

Storing the Flat Tire and Tools

CAUTION:

Storing a jack, a tire, or other equipment in the passenger compartment of the vehicle could cause injury. In a sudden stop or collision, loose equipment could strike someone. Store all these in the proper place.

After you've put the compact spare tire on your vehicle, you'll need to store the flat tire in your trunk.

Store the flat tire as far forward in the trunk as possible. Store the jack and wheel wrench in their compartment in the trunk. For storage, the jack must be raised until the screw end is flush with the edge of the jack.

Storing the Spare Tire and Tools

CAUTION:

Storing a jack, a tire, or other equipment in the passenger compartment of the vehicle could cause injury. In a sudden stop or collision, loose equipment could strike someone. Store all these in the proper place.

The compact spare is for temporary use only. Replace the compact spare tire with a full-size tire as soon as you can. See the storage instructions label to replace your compact spare into your trunk properly.

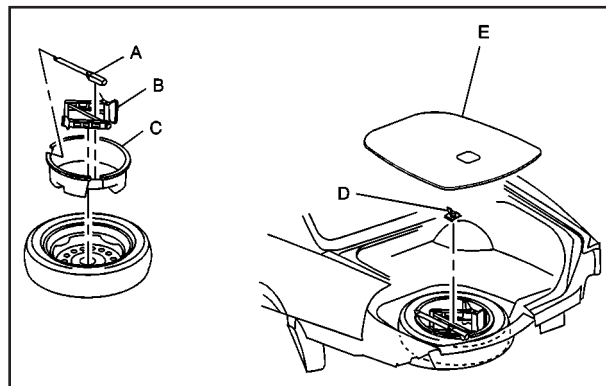

A. Wrench
B. Jack
C. Jack Container

D. Retainer
E. Spare Tire Cover

Compact Spare Tire

Although the compact spare tire was fully inflated when your vehicle was new, it can lose air after a time. Check the inflation pressure regularly. It should be 60 psi (420 kPa).

After installing the compact spare on your vehicle, you should stop as soon as possible and make sure your spare tire is correctly inflated. The compact spare is made to perform well at speeds up to 65 mph (105 km/h) for distances up to 3,000 miles (5 000 km), so you can finish your trip and have your full-size tire repaired or replaced where you want. Of course, it's best to replace your spare with a full-size tire as soon as you can. Your spare will last longer and be in good shape in case you need it again.

Notice: When the compact spare is installed, don't take your vehicle through an automatic car wash with guide rails. The compact spare can get caught on the rails. That can damage the tire and wheel, and maybe other parts of your vehicle.

Don't use your compact spare on other vehicles. And don't mix your compact spare tire or wheel with other wheels or tires. They won't fit. Keep your spare tire and its wheel together.

Notice: Tire chains won't fit your compact spare. Using them can damage your vehicle and can damage the chains too. Don't use tire chains on your compact spare.

Appearance Care

Remember, cleaning products can be hazardous. Some are toxic. Others can burst into flames if you strike a match or get them on a hot part of the vehicle. Some are dangerous if you breathe their fumes in a closed space. When you use anything from a container to clean your vehicle, be sure to follow the manufacturer's warnings and instructions. And always open your doors or windows when you are cleaning the inside.

Never use these to clean your vehicle:

- Gasoline
- Benzene
- Naphtha
- Carbon Tetrachloride
- Acetone
- Paint Thinner
- Turpentine
- Lacquer Thinner
- Nail Polish Remover

They can all be hazardous — some more than others — and they can all damage your vehicle, too.

Do not use any of these unless this manual says you can. In many uses, these will damage your vehicle:

- Alcohol
- Laundry Soap
- Bleach
- Reducing Agents

Cleaning the Inside of Your Vehicle

Use a vacuum cleaner often to get rid of dust and loose dirt. Wipe vinyl, leather, plastic and painted surfaces with a clean, damp cloth.

Cleaning Fabric/Carpet

Your dealer has cleaners for the cleaning of fabric and carpet. They will clean normal spots and stains very well.

You can get GM-approved cleaning products from your dealer. See *Vehicle Care/Appearance Materials* on page 5-90.

Here are some cleaning tips:

- Always read the instructions on the cleaner label.
- Clean up stains as soon as you can — before they set.
- Carefully scrape off any excess stain.
- Use a clean cloth or sponge, and change to a clean area often. A soft brush may be used if stains are stubborn.
- If a ring forms on fabric after spot cleaning, clean the entire area immediately or it will set.

Cleaning Vinyl

Use warm water and a clean cloth.

- Rub with a clean, damp cloth to remove dirt. You may have to do this more than once.
- Things like tar, asphalt and shoe polish will stain if you don't get them off quickly. Use a clean cloth and vinyl cleaner. See your dealer for this product.

Cleaning Leather

Use a soft cloth with lukewarm water and a mild soap or saddle soap and wipe dry with a soft cloth. Then, let the leather dry naturally. Do not use heat to dry.

- For stubborn stains, use a leather cleaner.
- *Never* use oils, varnishes, solvent-based or abrasive cleaners, furniture polish or shoe polish on leather.
- Soiled or stained leather should be cleaned immediately. If dirt is allowed to work into the finish, it can harm the leather.

Cleaning the Top of the Instrument Panel

Use only mild soap and water to clean the top surfaces of the instrument panel. Sprays containing silicones or waxes may cause annoying reflections in the windshield and even make it difficult to see through the windshield under certain conditions.

Cleaning Interior Plastic Components

Use on a mild soap and water solution on a soft cloth or sponge. Commercial cleaners may affect the surface finish.

Cleaning Wood Panels

Use a clean cloth moistened in warm, soapy water (use mild dish washing soap). Dry the wood immediately with a clean cloth.

Cleaning the Speaker Covers

Vacuum around a speaker cover gently, so that the speaker won't be damaged. Clean spots with just water and mild soap.

Cleaning Glass Surfaces

Glass should be cleaned often. GM Glass Cleaner or a liquid household glass cleaner will remove normal tobacco smoke and dust films on interior glass. See *Vehicle Care/Appearance Materials on page 5-90*.

Notice: Don't use abrasive cleaners on glass, because they may cause scratches. Avoid placing decals on the inside rear window, since they may have to be scraped off later. If abrasive cleaners are used on the inside of the rear window, an electric defogger element may be damaged. Any temporary license should not be attached across the defogger grid.

Care of Safety Belts

Keep belts clean and dry.

CAUTION:

Do not bleach or dye safety belts. If you do, it may severely weaken them. In a crash, they might not be able to provide adequate protection. Clean safety belts only with mild soap and lukewarm water.

Weatherstrips

Silicone grease on weatherstrips will make them last longer, seal better, and not stick or squeak. Apply silicone grease with a clean cloth at least every six months. During very cold, damp weather more frequent application may be required. See *Part D: Recommended Fluids and Lubricants on page 6-15*.

Cleaning the Outside of Your Vehicle

The paint finish on your vehicle provides beauty, depth of color, gloss retention and durability.

Washing Your Vehicle

The best way to preserve your vehicle's finish is to keep it clean by washing it often with lukewarm or cold water.

Don't wash your vehicle in the direct rays of the sun. Use a car washing soap. Don't use strong soaps or chemical detergents. Be sure to rinse the vehicle well, removing all soap residue completely. You can get GM-approved cleaning products from your dealer. See *Vehicle Care/Appearance Materials on page 5-90*. Don't use cleaning agents that are petroleum based, or that contain acid or abrasives. All cleaning agents should be flushed promptly and not allowed to dry on the surface, or they could stain. Dry the finish with a soft, clean chamois or an all-cotton towel to avoid surface scratches and water spotting.

High pressure car washes may cause water to enter your vehicle.

Cleaning Exterior Lamps/Lenses

Use only lukewarm or cold water, a soft cloth and a car washing soap to clean exterior lamps and lenses. Follow instructions under “Washing Your Vehicle.”

Finish Care

Occasional waxing or mild polishing of your vehicle by hand may be necessary to remove residue from the paint finish. You can get GM-approved cleaning products from your dealer. See *Vehicle Care/Appearance Materials* on page 5-90.

If your vehicle has a “basecoat/clearcoat” paint finish. The clearcoat gives more depth and gloss to the colored basecoat. Always use waxes and polishes that are non-abrasive and made for a basecoat/clearcoat paint finish.

Notice: Machine compounding or aggressive polishing on a basecoat/clearcoat paint finish may dull the finish or leave swirl marks.

Foreign materials such as calcium chloride and other salts, ice melting agents, road oil and tar, tree sap, bird droppings, chemicals from industrial chimneys, etc., can damage your vehicle’s finish if they remain on painted surfaces. Wash the vehicle as soon as possible. If necessary, use non-abrasive cleaners that are marked safe for painted surfaces to remove foreign matter.

Exterior painted surfaces are subject to aging, weather and chemical fallout that can take their toll over a period of years. You can help to keep the paint finish looking new by keeping your vehicle garaged or covered whenever possible.

Cleaning Windshield and Wiper Blades

If the windshield is not clear after using the windshield washer, or if the wiper blade chatters when running, wax, sap or other material may be on the blade or windshield.

Clean the outside of the windshield with a full-strength glass cleaning liquid. The windshield is clean if beads do not form when you rinse it with water.

Grime from the windshield will stick to the wiper blades and affect their performance. Clean the blade by wiping vigorously with a cloth soaked in full-strength windshield washer solvent. Then rinse the blade with water.

Check the wiper blades and clean them as necessary; replace blades that look worn.

Cleaning Aluminum or Chrome-Plated Wheels

Your vehicle may be equipped with either aluminum or chrome-plated wheels.

Keep your wheels clean using a soft clean cloth with mild soap and water. Rinse with clean water. After rinsing thoroughly, dry with a soft clean towel. A wax may then be applied.

The surface of these wheels is similar to the painted surface of your vehicle. Don't use strong soaps, chemicals, abrasive polishes, abrasive cleaners, cleaners with acid, or abrasive cleaning brushes on them because you could damage the surface. Do not use chrome polish on aluminum wheels.

Use chrome polish only on chrome-plated wheels, but avoid any painted surface of the wheel, and buff off immediately after application.

Don't take your vehicle through an automatic car wash that has silicone carbide tire cleaning brushes. These brushes can also damage the surface of these wheels.

Cleaning Tires

To clean your tires, use a stiff brush with tire cleaner.

Notice: When applying a tire dressing, always take care to wipe off any overspray or splash from all painted surfaces on the body or wheels of the vehicle. Petroleum-based products may damage the paint finish and tires.

Sheet Metal Damage

If your vehicle is damaged and requires sheet metal repair or replacement, make sure the body repair shop applies anti-corrosion material to parts repaired or replaced to restore corrosion protection.

Original manufacturer replacement parts will provide the corrosion protection while maintaining the warranty.

Finish Damage

Any stone chips, fractures or deep scratches in the finish should be repaired right away. Bare metal will corrode quickly and may develop into major repair expense.

Minor chips and scratches can be repaired with touch-up materials available from your dealer. Larger areas of finish damage can be corrected in your dealer's body and paint shop.

Underbody Maintenance

Chemicals used for ice and snow removal and dust control can collect on the underbody. If these are not removed, corrosion and rust can develop on the underbody parts such as fuel lines, frame, floor pan and exhaust system even though they have corrosion protection.

At least every spring, flush these materials from the underbody with plain water. Clean any areas where mud and debris can collect. Dirt packed in close areas of the frame should be loosened before being flushed. Your dealer or an underbody car washing system can do this for you.

Chemical Paint Spotting

Some weather and atmospheric conditions can create a chemical fallout. Airborne pollutants can fall upon and attack painted surfaces on your vehicle. This damage can take two forms: blotchy, ring-shaped discolorations, and small, irregular dark spots etched into the paint surface.

Although no defect in the paint job causes this, GM will repair, at no charge to the owner, the surfaces of new vehicles damaged by this fallout condition within 12 months or 12,000 miles (20 000 km) of purchase, whichever occurs first.

Vehicle Care/Appearance Materials

See your GM dealer for more information on purchasing the following products.

Vehicle Care/Appearance Materials

| Description | Usage |
|--------------------------------|-----------------------------------------------------------|
| Polishing Cloth Wax-Treated | Interior and exterior polishing cloth. |
| Tar and Road Oil Remover | Removes tar, road oil and asphalt. |
| Chrome Cleaner and Polish | Use on chrome or stainless steel. |
| White Sidewall Tire Cleaner | Removes soil and black marks from whitewalls. |
| Vinyl Cleaner | Cleans vinyl tops, upholstery and convertible tops. |
| Glass Cleaner | Removes dirt, grime, smoke and fingerprints. |

Vehicle Care/Appearance Materials (cont'd)

| Description | Usage |
|----------------------------------|-------------------------------------------------------------------------------------|
| Chrome and Wire Wheel Cleaner | Removes dirt and grime from chrome wheels and wire wheel covers. |
| Finish Enhancer | Removes dust, fingerprints, and surface contaminants. Spray on wipe off. |
| Swirl Remover Polish | Removes swirl marks, fine scratches and other light surface contamination. |
| Cleaner Wax | Removes light scratches and protects finish. |
| Foaming Tire Shine Low Gloss | Cleans, shines and protects in one easy step, no wiping necessary. |

Vehicle Care/Appearance Materials (cont'd)

| Description | Usage |
|---------------------------------------------------------------------------------------------------------------------------------|---------------------------------------------------------------------------------------|
| Wash Wax Concentrate | Medium foaming shampoo. Cleans and lightly waxes. Biodegradable and phosphate free. |
| Spot Lifter | Quickly and easily removes spots and stains from carpets, vinyl and cloth upholstery. |
| Odor Eliminator | Odorless spray odor eliminator used on fabrics, vinyl, leather and carpet. |
| See your General Motors parts department for these products. See <i>Part D: Recommended Fluids and Lubricants</i> on page 6-15. | |

Vehicle Identification

Vehicle Identification Number (VIN)



This is the legal identifier for your vehicle. It appears on a plate in the front corner of the instrument panel, on the driver's side. You can see it if you look through the windshield from outside your vehicle. The VIN also appears on the Vehicle Certification and Service Parts labels and the certificates of title and registration.

Engine Identification

The 8th character in your VIN is the engine code. This code will help you identify your engine, specifications and replacement parts.

Service Parts Identification Label

You'll find this label on the under side of the spare tire cover in the trunk. It's very helpful if you ever need to order parts. On this label is:

- your VIN,
- the model designation,
- paint information and
- a list of all production option and special equipment.

Be sure that this label is not removed from the vehicle.

Electrical System

Add-On Electrical Equipment

Notice: Don't add anything electrical to your vehicle unless you check with your dealer first. Some electrical equipment can damage your vehicle and the damage wouldn't be covered by your warranty. Some add-on electrical equipment can keep other components from working as they should.

Your vehicle has an air bag system. Before attempting to add anything electrical to your vehicle, see *Servicing Your Air Bag-Equipped Vehicle on page 1-52.*

Headlamp Wiring

The headlamp wiring has an individual fuse. An electrical overload will cause the lamps to go on and off, or in some cases to remain off. If this happens, have the headlamp wiring checked right away.

Windshield Wiper Fuses

The windshield wiper motor is protected by an internal circuit breaker. If the wiper motor overheats due to heavy snow, the wipers will stop until the motor cools and will then restart.

A fuse powers the wiper motor. If the fuse blows, there is an electrical problem. Be sure to have it fixed.

Power Windows and Other Power Options

Circuit breakers protect the power windows and power seats. When the current load is too heavy, the circuit breaker opens and closes, protecting the circuit until the problem is fixed or goes away.

Fuses and Circuit Breakers

The wiring circuits in your vehicle are protected from short circuits by a combination of fuses and circuit breakers. This greatly reduces the chance of fires caused by electrical problems.

Look at the silver-colored band inside the fuse. If the band is broken or melted, replace the fuse. Be sure you replace a bad fuse with a new one of the identical size and rating. If a fuse should blow, see your dealer for service immediately.

If you ever have a problem on the road and don't have a spare fuse, you can "borrow" one that has the same amperage. Pick some feature of your vehicle that you can get along without – like the radio or cigarette lighter – and use its fuse, if it is the correct amperage. Replace it as soon as you can.

The fuses are located in two fuse blocks, one located near the engine compartment on the passenger's side and the other under the rear seat on the driver's side. If a fuse should blow, have your vehicle serviced by your dealer immediately.

Underhood Fuse Block



The underhood fuse block is located in the front of the engine compartment between the windshield washer fluid reservoir and the power steering fluid reservoir on the passenger's side of the vehicle. See *Engine Compartment Overview on page 5-12* for more information on location.

To access the fuses, push in the two tabs located at each end of the fuse block cover. Then, lift the cover off.

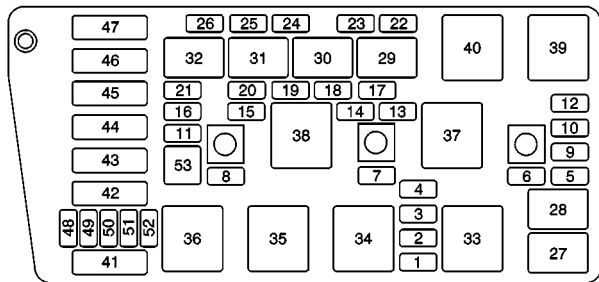

| Fuses | Usage |
|-------|------------------------------------|
| 10 | Headlamp High Beam Left |
| 11 | Ignition 1 |
| 12 | Fog Lamps |
| 13 | Transmission |
| 14 | Cruise Control |
| 15 | Coil MDL |
| 16 | Injector Bank #2 |
| 17 | Not Used |
| 18 | Not Used |
| 19 | Powertrain Control Module Ignition |
| 20 | Oxygen Sensor |
| 21 | Injector Bank #1 |
| 22 | Auxiliary Power, (Cltr2) |
| 23 | Cigar Lighter |
| 24 | Daytime Running Lamps |
| 25 | Horn |
| 26 | Air Conditioner Clutch |

| Fuses | Usage |
|-------|-----------------------------------|
| 1 | ALDL |
| 2 | Accessory |
| 3 | Windshield Wipers |
| 4 | Not Used |
| 5 | Headlamp Low Beam Left |
| 6 | Headlamp Low Beam Right |
| 7 | Instrument Panel |
| 8 | Powertrain Control Module Battery |
| 9 | Headlamp High Beam Right |

| Relays | Usage |
|---------------|-----------------------------|
| 27 | Headlamp High Beam |
| 28 | Headlamp Low Beam |
| 29 | Fog Lamps |
| 30 | Daytime Running Lamps |
| 31 | Horn |
| 32 | Air Conditioner Clutch |
| 33 | Not Used |
| 34 | Accessory |
| 35 | Not Used |
| 36 | Starter 1 |
| 37 | Cooling Fan 1 |
| 38 | Ignition 1 |
| 39 | Cooling Fan Series/Parallel |
| 40 | Cooling Fan 2 |

| Circuit Breakers | Usage |
|-------------------------|--------------|
| 41 | Starter |
| 42 | Export Use |

| Fuses | Usage |
|--------------|-----------------------|
| 43 | Not Used |
| 44 | Antilock Brake System |
| 45 | Air Pump |
| 46 | Cooling Fan 1 |
| 47 | Cooling Fan 2 |

The spare fuses are located in numbers 48 through 52.
The fuse puller is located in number 53.

Removing the Rear Seat Cushion

Notice: The battery and main fuse blocks are located under the rear seat cushion. The battery's ground terminal and some relay wires are exposed. To help avoid damage to the battery and wires, be careful when removing or reinstalling the seat cushion. Do not remove covers from covered parts. Do not store anything under the seat, as objects could touch exposed wires and cause a short.

To remove the rear seat cushion, do the following:

1. Pull up on the front of the cushion to release the front hooks.
2. Pull the cushion up and out toward the front of the vehicle.

To reinstall the rear seat cushion, do the following:



CAUTION:

A safety belt that isn't properly routed through the seat cushion or is twisted won't provide the protection needed in a crash. If the safety

CAUTION: (Continued)

CAUTION: (Continued)

belt hasn't been routed through the seat cushion at all, it won't be there to work for the next passenger. The person sitting in that position could be badly injured. After reinstalling the seat cushion, always check to be sure that the safety belts are properly routed and are not twisted.

1. Buckle the center passenger position safety belt, then route the safety belts through the proper slots in the seat cushion. Don't let the safety belts get twisted.
2. Slide the rear of the cushion up and under the seatback so the rear-locating guides hook into the wire loops on the back frame.
3. With the seat cushion lowered, push rearward and then press down on the seat cushion until the spring locks on both ends engage.
4. Check to make sure the safety belts are properly routed and that no portion of any safety belt is trapped under the seat. Also make sure the seat cushion is secured.

Rear Underseat Fuse Block

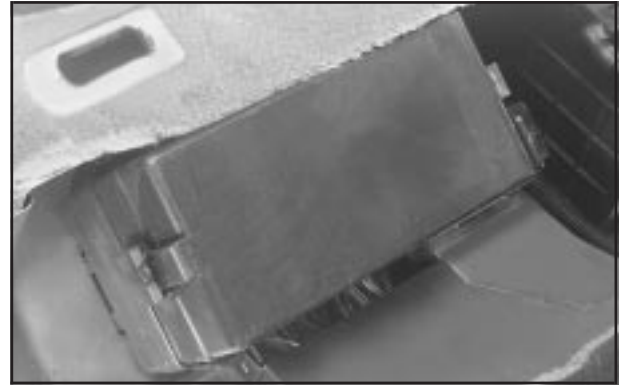

This fuse block is located under the rear seat on the driver's side of the vehicle. The rear seat cushion must be removed to access the fuse block. See *Removing the Rear Seat Cushion* listed previously in this section. To access the fuses, push in the two tabs located at each end of the fuse block cover. Then, lift the cover off.

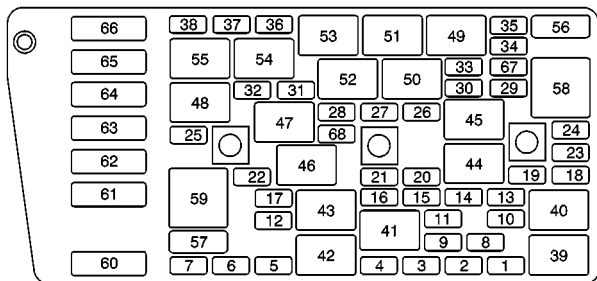

| Fuses | Usage |
|-------|----------------------------------------|
| 12 | Ignition 1 |
| 13 | Lamps, Parking Left |
| 14 | Interior Lamp Dimmer Module |
| 15 | Navigation |
| 16 | Heated Seat Left Front |
| 17 | Export Lighting |
| 18 | Rear Door Modules |
| 19 | Stoplamps |
| 20 | Neutral Safety Back-up |
| 21 | Audio |
| 22 | Retained Accessory Power for Sunroof |
| 23 | Not Used |
| 24 | Not Used |
| 25 | Passenger Door Module |
| 26 | Fuel Door/Trunk Release (Body) |
| 27 | Interior Lamps |
| 28 | Rear HVAC Blower |
| 29 | Ignition Switch |
| 30 | Not Used |
| 31 | Heated Seat Right Front |
| 32 | Magnetic Ride Control |
| 33 | Heating, Ventilation, Air Conditioning |
| 34 | Ignition 3 Rear |

| Fuses | Usage |
|-------|---------------------------------------------|
| 1 | Fuel Pump |
| 2 | Heater, Ventilation, Air Conditioner Blower |
| 3 | Memory Seat, Tilt and Telescoping Steering |
| 4 | SDAR (XM™ Satellite Radio) |
| 5 | Driver Door Module |
| 6 | Heated Seat Left Rear |
| 7 | Power Tilt and Telescoping Steering |
| 8 | Supplemental Inflation Restraint |
| 9 | Not Used |
| 10 | Lamps Park Right |
| 11 | Fuel Tank Ventilation Solenoid |

| Fuses | Usage |
|-------|-------------------------|
| 35 | Antilock Braking System |
| 36 | Turn Signal/Hazard |
| 37 | Heated Seat Right Rear |
| 38 | Dash Integration Module |

| Relays | Usage |
|--------|--------------------------------------|
| 39 | Fuel Pump |
| 40 | Parking Lamps |
| 41 | Ignition 1 |
| 42 | Park Brake A |
| 43 | Park Brake B |
| 44 | Park Shift Interlock |
| 45 | Reverse Lamps |
| 46 | Retained Accessory Power for Sunroof |
| 47 | Rear HVAC Blower |
| 48 | Not Used |
| 49 | Ignition 3 |
| 50 | Fuel Tank Door Release |
| 51 | Interior Lamps |
| 52 | Trunk Release |
| 53 | Front Courtesy Lamps |

| Relays | Usage |
|--------|------------------------------------|
| 54 | Rear Courtesy Lamps |
| 55 | Automatic Level Control Compressor |

| Circuit Breakers | Usage |
|------------------|---------------|
| 56 | Power Seats |
| 57 | Power Windows |

| Relays | Usage |
|--------|-------------------|
| 58 | Cigarette Lighter |
| 59 | Rear Defog |

| Fuses | Usage |
|-------|------------------------|
| 60 | Park Brake |
| 61 | Rear Defog |
| 62 | Export Brake |
| 63 | Audio Amplifier |
| 64 | ELC Compressor/Exhaust |
| 65 | Cigar Lighter |
| 66 | Not Used |

The spare fuses and fuse puller are located in the underhood fuse block. See *Underhood Fuse Block* listed previously for more information.

Capacities and Specifications

The following approximate capacities are given in English and metric conversions. Please refer to *Part D: Recommended Fluids and Lubricants on page 6-15* for more information.

Engine Specifications

| Engine | VIN Code | Transaxle | Spark Plug Gap | Displacement | Firing Order |
|---------------|----------|-----------|--------------------------|--------------------------------|-----------------|
| 4.6 L DOHC V8 | Y SLS | 4T80 – E | 0.050 inches (1.3 mm) | 279 cubic inches (4 565 cc) | 1-2-7-3-4-5-6-8 |
| 4.6 L DOHC V8 | 9 STS | 4T80 – E | 0.050 inches (1.3 mm) | 279 cubic inches (4 565 cc) | 1-2-7-3-4-5-6-8 |

Capacities and Specifications

| Application | Capacities | |
|-------------------------------------------------------------------------------------------------------------------------------------------------------------|--------------|---------|
| | English | Metric |
| Air Conditioning Refrigerant R134a Use Refrigerant Oil, R134a Systems | 2.2 lbs. | 1.0 kg |
| Cooling System | 13.0 quarts | 12.3 L |
| Engine Oil with Filter | 7.5 quarts | 7.1 L |
| Fuel Tank | 18.5 gallons | 70.0 L |
| Transaxle | 15.0 quarts | 14.2 L |
| Wheel Nut Torque | 100 lb-ft | 140 N•m |
| All capacities are approximate. When adding, be sure to fill to the approximate level as recommended in this manual. Recheck the fluid level after filling. | | |

Normal Maintenance Replacement Parts

| Part | Number |
|------------------------------------|-------------------------------|
| Engine Air Cleaner/Filter Element | A1208C* |
| Engine Oil Filter | PF58* |
| Fuel Filter Element | GF-627* |
| Spark Plugs | 41-987* (GM Part 12571535) |
| Windshield Wiper Blade (Hook Type) | 22 inches (56.5 cm) |
| *AC Delco® part number | |

Section 6 Maintenance Schedule

| | | | |
|----------------------------------------------|------|------------------------------------------------|------|
| Maintenance Schedule | 6-2 | At Least Once a Year | 6-10 |
| Introduction | 6-2 | Part C: Periodic Maintenance Inspections | 6-13 |
| Your Vehicle and the Environment | 6-2 | Steering, Suspension and Front Drive Axle | |
| Maintenance Requirements | 6-2 | Boot and Seal Inspection | 6-13 |
| How This Section is Organized | 6-3 | Exhaust System Inspection | 6-13 |
| Part A: Scheduled Maintenance Services | 6-4 | Fuel System Inspection | 6-13 |
| Using Your Maintenance Schedule | 6-4 | Engine Cooling System Inspection | 6-14 |
| Scheduled Maintenance | 6-4 | Throttle System Inspection | 6-14 |
| Part B: Owner Checks and Services | 6-9 | Brake System Inspection | 6-14 |
| At Each Fuel Fill | 6-9 | Part D: Recommended Fluids and Lubricants | 6-15 |
| At Least Once a Month | 6-9 | Part E: Maintenance Record | 6-16 |
| At Least Twice a Year | 6-10 | | |

Maintenance Schedule

Introduction

Important: Keep engine oil at the proper level and change as recommended.



Have you purchased the GM Protection Plan? The Plan supplements your new vehicle warranties. See your Warranty and Owner Assistance booklet or your dealer for details.

Your Vehicle and the Environment

Proper vehicle maintenance not only helps to keep your vehicle in good working condition, but also helps the environment. Improper vehicle maintenance can even affect the quality of the air we breathe. Improper fluid levels or the wrong tire inflation can increase the level of emissions from your vehicle. To help protect our environment, and to keep your vehicle in good condition, be sure to maintain your vehicle properly.

Maintenance Requirements

Maintenance intervals, checks, inspections and recommended fluids and lubricants as prescribed in this manual are necessary to keep your vehicle in good working condition. Any damage caused by failure to follow scheduled maintenance may not be covered by warranty.

How This Section is Organized

This maintenance schedule is divided into five parts:

“Part A: Scheduled Maintenance Services” explains what to have done and how often. Some of these services can be complex, so unless you are technically qualified and have the necessary equipment, you should let your GM dealer’s service department do these jobs.

Your GM dealer has GM-trained and supported service people that will perform the work using genuine GM parts.

CAUTION:

Performing maintenance work on a vehicle can be dangerous. In trying to do some jobs, you can be seriously injured. Do your own maintenance work only if you have the required know-how and the proper tools and equipment for the job. If you have any doubt, have a qualified technician do the work.

If you want to get the service information, see *Service Publications Ordering Information* on page 7-10.

“Part B: Owner Checks and Services” tells you what should be checked and when. It also explains what you can easily do to help keep your vehicle in good condition.

“Part C: Periodic Maintenance Inspections” explains important inspections that your dealer’s service department can perform for you.

“Part D: Recommended Fluids and Lubricants” lists some recommended products necessary to help keep your vehicle properly maintained. These products, or their equivalents, should be used whether you do the work yourself or have it done.

“Part E: Maintenance Record” is a place for you to record and keep track of the maintenance performed on your vehicle. Keep your maintenance receipts. They may be needed to qualify your vehicle for warranty repairs.

Part A: Scheduled Maintenance Services

This part contains engine oil scheduled maintenance which explains the engine oil life system and how it indicates when to change the engine oil and filter. Also, listed are scheduled maintenance services which are to be performed at the mileage intervals specified.

Using Your Maintenance Schedule

We at General Motors want to keep your vehicle in good working condition. But we don't know exactly how you'll drive it. You may drive short distances only a few times a week. Or you may drive long distances all the time in very hot, dusty weather. You may use your vehicle in making deliveries. Or you may drive it to work, to do errands or in many other ways.

Because of the different ways people use their vehicles, maintenance needs may vary. You may need more frequent checks and replacements. So please read the following and note how you drive. If you have questions on how to keep your vehicle in good condition, see your dealer.

This part tells you the maintenance services you should have done and when to schedule them.

When you go to your dealer for your service needs, you'll know that GM-trained and supported service people will perform the work using genuine GM parts.

The proper fluids and lubricants to use are listed in Part D. Make sure whoever services your vehicle uses these. All parts should be replaced and all necessary repairs done before you or anyone else drives the vehicle.

This schedule is for vehicles that:

- carry passengers and cargo within recommended limits. You will find these on your vehicle's Tire-Loading Information label. See *Loading Your Vehicle on page 4-33*.
- are driven on reasonable road surfaces within legal driving limits.
- use the recommended fuel. See *Gasoline Octane on page 5-4*.

Scheduled Maintenance

The services shown in this schedule up to 100,000 miles (166 000 km) should be repeated after 100,000 miles (166 000 km) at the same intervals for the life of this vehicle. The services shown at 150,000 miles (240 000 km) should be repeated at the same interval after 150,000 miles (240 000 km) for the life of this vehicle.

See *Part B: Owner Checks and Services on page 6-9* and *Part C: Periodic Maintenance Inspections on page 6-13*.

Footnotes

† *The U.S. Environmental Protection Agency or the California Air Resources Board has determined that the failure to perform this maintenance item will not nullify the emission warranty or limit recall liability prior to the completion of the vehicle's useful life. We, however, urge that all recommended maintenance services be performed at the indicated intervals and the maintenance be recorded.*

+ *A good time to check your brakes is during tire rotation. See Brake System Inspection on page 6-14.*

Engine Oil Scheduled Maintenance

Change engine oil and filter as indicated by the GM Oil Life System (or every 12 months, whichever occurs first). Reset the system.

Your vehicle has a computer system that lets you know when to change the engine oil and filter. This is based on engine revolutions and engine temperature, and not on mileage. Based on driving conditions, the mileage at which an oil change will be indicated can vary considerably. For the oil life system to work properly, you must reset the system every time the oil is changed.

When the system has calculated that oil life has been diminished, it will indicate that an oil change is necessary. A CHANGE ENGINE OIL message in the Driver Information Center (DIC) will come on. Change your oil as soon as possible within the next two times you stop for fuel. It is possible that, if you are driving under the best conditions, the oil life system may not indicate that an oil change is necessary for over a year. However, your engine oil and filter must be changed at least once a year and at this time the system must be reset. Your dealer has GM-trained service people who will perform this work using genuine GM parts and reset the system.

It is also important to check your oil regularly and keep it at the proper level.

If the system is ever reset accidentally, you must change your oil at 3,000 miles (5 000 km) since your last oil change. Remember to reset the oil life system whenever the oil is changed. See *Engine Oil on page 5-13* for information on resetting the system.

An Emission Control Service.

See the mileage intervals following for additional services that may be performed with an engine oil change. After the services are performed, record the date, odometer reading and who performed the service on the maintenance record pages in Part E of this schedule.

7,500 Miles (12 500 km)

- ❑ Rotate tires. See *Tire Inspection and Rotation* on page 5-67 for proper rotation pattern and additional information. (See footnote +.)

15,000 Miles (25 000 km)

- ❑ Inspect engine air cleaner filter. If necessary, replace the filter. If vehicle is driven in dusty/dirty conditions, inspect filter at every engine oil change. See *Engine Air Cleaner/Filter* on page 5-19 for more information. *An Emission Control Service.* (See footnote †.)
- ❑ Replace passenger compartment air filter. If you drive regularly under dusty conditions, the filter may require replacement more often.
- ❑ Rotate tires. See *Tire Inspection and Rotation* on page 5-67 for proper rotation pattern and additional information. (See footnote +.)

22,500 Miles (37 500 km)

- ❑ Rotate tires. See *Tire Inspection and Rotation* on page 5-67 for proper rotation pattern and additional information. (See footnote +.)

30,000 Miles (50 000 km)

- ❑ Replace passenger compartment air filter. If you drive regularly under dusty conditions, the filter may require replacement more often.

- ❑ Inspect throttle body bore and valve plates for deposits, open the throttle valve and inspect all surfaces. Clean as required. *An Emission Control Service.* (See footnote †.)
- ❑ Rotate tires. See *Tire Inspection and Rotation* on page 5-67 for proper rotation pattern and additional information. (See footnote +.)
- ❑ Replace engine air cleaner filter. See *Engine Air Cleaner/Filter* on page 5-19 for more information. *An Emission Control Service.*

37,500 Miles (62 000 km)

- ❑ Rotate tires. See *Tire Inspection and Rotation* on page 5-67 for proper rotation pattern and additional information. (See footnote +.)

45,000 Miles (75 000 km)

- ❑ Inspect engine air cleaner filter. If necessary, replace the filter. If vehicle is driven in dusty/dirty conditions, inspect filter at every engine oil change. See *Engine Air Cleaner/Filter* on page 5-19 for more information. *An Emission Control Service.* (See footnote †.)
- ❑ Replace passenger compartment air filter. If you drive regularly under dusty conditions, the filter may require replacement more often.
- ❑ Rotate tires. See *Tire Inspection and Rotation* on page 5-67 for proper rotation pattern and additional information. (See footnote +.)

50,000 Miles (83 000 km)

- ❑ Change automatic transaxle fluid and filter if the vehicle is mainly driven under one or more of these conditions:
 - In heavy city traffic where the outside temperature regularly reaches 90°F (32°C) or higher.
 - In hilly or mountainous terrain.
 - When doing frequent trailer towing.
 - Uses such as high performance operation.

If you do not use your vehicle under any of these conditions, the fluid and filter do not require change until the message CHANGE TRANS FLUID appears on the Driver Information Center.

52,500 Miles (87 500 km)

- ❑ Rotate tires. See *Tire Inspection and Rotation on page 5-67* for proper rotation pattern and additional information. (See footnote +.)

60,000 Miles (100 000 km)

- ❑ Replace passenger compartment air filter. If you drive regularly under dusty conditions, the filter may require replacement more often.
- ❑ Inspect throttle body bore and valve plates for deposits, open the throttle valve and inspect all surfaces. Clean as required. *An Emission Control Service.* (See footnote †.)

- ❑ Rotate tires. See *Tire Inspection and Rotation on page 5-67* for proper rotation pattern and additional information. (See footnote +.)
- ❑ Replace engine air cleaner filter. See *Engine Air Cleaner/Filter on page 5-19* for more information. *An Emission Control Service.*

67,500 Miles (112 500 km)

- ❑ Rotate tires. See *Tire Inspection and Rotation on page 5-67* for proper rotation pattern and additional information. (See footnote +.)

75,000 Miles (125 000 km)

- ❑ Inspect engine air cleaner filter. If necessary, replace the filter. If vehicle is driven in dusty/dirty conditions, inspect filter at every engine oil change. See *Engine Air Cleaner/Filter on page 5-19* for more information. *An Emission Control Service.* (See footnote †.)
- ❑ Replace passenger compartment air filter. If you drive regularly under dusty conditions, the filter may require replacement more often.
- ❑ Rotate tires. See *Tire Inspection and Rotation on page 5-67* for proper rotation pattern and additional information. (See footnote +.)

82,500 Miles (137 500 km)

- ❑ Rotate tires. See *Tire Inspection and Rotation on page 5-67* for proper rotation pattern and additional information. (See footnote +.)

90,000 Miles (150 000 km)

- ❑ Replace passenger compartment air filter. If you drive regularly under dusty conditions, the filter may require replacement more often.
- ❑ Inspect throttle body bore and valve plates for deposits, open the throttle valve and inspect all surfaces. Clean as required. *An Emission Control Service.* (See footnote †.)
- ❑ Replace engine air cleaner filter. See *Engine Air Cleaner/Filter* on page 5-19 for more information. *An Emission Control Service.*
- ❑ Rotate tires. See *Tire Inspection and Rotation* on page 5-67 for proper rotation pattern and additional information. (See footnote +.)

97,500 Miles (162 500 km)

- ❑ Rotate tires. See *Tire Inspection and Rotation* on page 5-67 for proper rotation pattern and additional information. (See footnote +.)

100,000 Miles (166 000 km)

- ❑ Replace spark plugs. *An Emission Control Service.*

- ❑ Change automatic transaxle fluid and filter if the vehicle is mainly driven under one or more of these conditions:
 - In heavy city traffic where the outside temperature regularly reaches 90°F (32°C) or higher.
 - In hilly or mountainous terrain.
 - When doing frequent trailer towing.
 - Uses such as high performance operation.

If you do not use your vehicle under any of these conditions, the fluid and filter do not require change until the message CHANGE TRANS FLUID appears on the Driver Information Center.

150,000 Miles (240 000 km)

- ❑ Drain, flush and refill cooling system (or every 60 months since last service, whichever occurs first). See *Engine Coolant* on page 5-25 for what to use. Inspect hoses. Clean radiator, condenser, pressure cap and neck. Pressure test the cooling system and pressure cap. *An Emission Control Service.*
- ❑ Inspect engine accessory drive belt. *An Emission Control Service.*

Part B: Owner Checks and Services

Listed in this part are owner checks and services which should be performed at the intervals specified to help ensure the safety, dependability and emission control performance of your vehicle.

Be sure any necessary repairs are completed at once. Whenever any fluids or lubricants are added to your vehicle, make sure they are the proper ones, as shown in Part D.

At Each Fuel Fill

It is important for you or a service station attendant to perform these underhood checks at each fuel fill.

Engine Oil Level Check

Check the engine oil level and add the proper oil if necessary. See *Engine Oil* on page 5-13 for further details.

Engine Coolant Level Check

Check the engine coolant level and add DEX-COOL[®] coolant mixture if necessary. See *Engine Coolant* on page 5-25 for further details.

Windshield Washer Fluid Level Check

Check the windshield washer fluid level in the windshield washer tank and add the proper fluid if necessary. See *Windshield Washer Fluid* on page 5-39 for further details.

At Least Once a Month

Tire Inflation Check

Visually inspect your tires and make sure tires are inflated to the correct pressures. Don't forget to check your spare tire. See *Tires* on page 5-63 for further details.

Cassette Tape Player Service

Clean cassette tape player. Cleaning should be done every 50 hours of tape play. See *Audio System(s)* on page 3-78 for further details.

At Least Twice a Year

Restraint System Check

Make sure the safety belt reminder light and all your belts, buckles, latch plates, retractors and anchorages are working properly. Look for any other loose or damaged safety belt system parts. If you see anything that might keep a safety belt system from doing its job, have it repaired. Have any torn or frayed safety belts replaced.

Also look for any opened or broken air bag coverings, and have them repaired or replaced. (The air bag system does not need regular maintenance.)

Wiper Blade Check

Inspect wiper blades for wear or cracking. Replace blade inserts that appear worn or damaged or that streak or miss areas of the windshield. Also see “Windshield Wiper and Wiper Blades” under *Cleaning the Outside of Your Vehicle* on page 5-86.

Weatherstrip Lubrication

Silicone grease on weatherstrips will make them last longer, seal better, and not stick or squeak. Apply silicone grease with a clean cloth. During very cold, damp weather more frequent application may be required. See *Part D: Recommended Fluids and Lubricants* on page 6-15.

Automatic Transaxle Check

Check the transaxle fluid level; add if needed. See *Automatic Transaxle Fluid* on page 5-21. A fluid loss may indicate a problem. Check the system and repair if needed.

At Least Once a Year

Key Lock Cylinders Service

Lubricate the key lock cylinders with the lubricant specified in Part D.

Body Lubrication Service

Lubricate all hinges and latches, including those for the hood, rear compartment, interior glove box and console doors. Part D tells you what to use. More frequent lubrication may be required when exposed to a corrosive environment.

Starter Switch Check

CAUTION:

When you are doing this check, the vehicle could move suddenly. If it does, you or others could be injured. Follow the steps below.

1. Before you start, be sure you have enough room around the vehicle.
2. Firmly apply both the parking brake and the regular brake. See *Parking Brake on page 2-31* if necessary.
Do not use the accelerator pedal, and be ready to turn off the engine immediately if it starts.
3. Try to start the engine in each gear. The starter should work only in PARK (P) or NEUTRAL (N). If the starter works in any other position, your vehicle needs service.

Automatic Transaxle Shift Lock Control System Check

CAUTION:

When you are doing this check, the vehicle could move suddenly. If it does, you or others could be injured. Follow the steps below.

1. Before you start, be sure you have enough room around the vehicle. It should be parked on a level surface.
2. Firmly apply the parking brake. See *Parking Brake on page 2-31* if necessary.
Be ready to apply the regular brake immediately if the vehicle begins to move.
3. With the engine off, turn the key to the ON position, but don't start the engine. Without applying the regular brake, try to move the shift lever out of PARK (P) with normal effort. If the shift lever moves out of PARK (P), your vehicle needs service.

Ignition Transaxle Lock Check

While parked, and with the parking brake set, try to turn the ignition key to OFF in each shift lever position.

- The key should turn to OFF only when the shift lever is in PARK (P).
- The key should come out only in OFF.

Parking Brake and Automatic Transaxle Park (P) Mechanism Check

CAUTION:

When you are doing this check, your vehicle could begin to move. You or others could be injured and property could be damaged. Make sure there is room in front of your vehicle in case it begins to roll. Be ready to apply the regular brake at once should the vehicle begin to move.

Park on a fairly steep hill, with the vehicle facing downhill. Keeping your foot on the regular brake, set the parking brake.

- To check the parking brake's holding ability: With the engine running and transaxle in NEUTRAL (N), slowly remove foot pressure from the regular brake pedal. Do this until the vehicle is held by the parking brake only.
- To check the PARK (P) mechanism's holding ability: With the engine running, shift to PARK (P). Then release the parking brake followed by the regular brake.

Underbody Flushing Service

At least every spring, use plain water to flush any corrosive materials from the underbody. Take care to clean thoroughly any areas where mud and other debris can collect.

Part C: Periodic Maintenance Inspections

Listed in this part are inspections and services which should be performed at least twice a year (for instance, each spring and fall). *You should let your dealer's service department do these jobs. Make sure any necessary repairs are completed at once.*

Proper procedures to perform these services may be found in a service manual. See *Service Publications Ordering Information on page 7-10.*

Steering, Suspension and Front Drive Axle Boot and Seal Inspection

Inspect the front and rear suspension and steering system for damaged, loose or missing parts, signs of wear or lack of lubrication. Inspect the power steering lines and hoses for proper hook-up, binding, leaks, cracks, chafing, etc. Clean and then inspect the drive axle boot seals for damage, tears or leakage. Replace seals if necessary.

Exhaust System Inspection

Inspect the complete exhaust system. Inspect the body near the exhaust system. Look for broken, damaged, missing or out-of-position parts as well as open seams, holes, loose connections or other conditions which could cause a heat build-up in the floor pan or could let exhaust fumes into the vehicle. See *Engine Exhaust on page 2-35.*

Fuel System Inspection

Inspect the complete fuel system for damage or leaks.

Engine Cooling System Inspection

Inspect the hoses and have them replaced if they are cracked, swollen or deteriorated. Inspect all pipes, fittings and clamps; replace as needed. Clean the outside of the radiator and air conditioning condenser. To help ensure proper operation, a pressure test of the cooling system and pressure cap is recommended at least once a year.

Throttle System Inspection

Inspect the throttle system for interference or binding, and for damaged or missing parts. Replace parts as needed. Replace any components that have high effort or excessive wear. Do not lubricate accelerator and cruise control cables.

Brake System Inspection

Inspect the complete system. Inspect brake lines and hoses for proper hook-up, binding, leaks, cracks, chafing, etc. Inspect disc brake pads for wear and rotors for surface condition. Inspect other brake parts, including calipers, parking brake, etc. You may need to have your brakes inspected more often if your driving habits or conditions result in frequent braking.

Part D: Recommended Fluids and Lubricants

Fluids and lubricants identified below by name, part number or specification may be obtained from your dealer.

| Usage | Fluid/Lubricant |
|----------------------------|--------------------------------------------------------------------------------------------------------------------------------------------------------------------------------------------------------------------------------|
| Engine Oil | Engine oil with the American Petroleum Institute Certified for Gasoline Engines starburst symbol of the proper viscosity. To determine the preferred viscosity for your vehicle's engine, see <i>Engine Oil on page 5-13</i> . |
| Engine Coolant | 50/50 mixture of clean, drinkable water and use only DEX-COOL [®] Coolant. See <i>Engine Coolant on page 5-25</i> . |
| Hydraulic Brake System | Delco Supreme 11 Brake Fluid or equivalent DOT-3 brake fluid. |
| Windshield Washer Solvent | GM Optikleen [®] Washer Solvent or equivalent. |
| Parking Brake Cable Guides | Chassis Lubricant (GM Part No. U.S. 12377985, in Canada 88901242, or equivalent) or lubricant meeting requirements of NLGI #2, Category LB or GC-LB. |

| Usage | Fluid/Lubricant |
|------------------------------------------------------------------------------|---------------------------------------------------------------------------------------------------------------------------------------------------------------|
| Power Steering System | GM Power Steering Fluid (GM Part No. U.S. 1052884, in Canada 993294, or equivalent). |
| Automatic Transaxle | DEXRON [®] -III Automatic Transmission Fluid. |
| Key Lock Cylinders | Multi-Purpose Lubricant, Superlube (GM Part No. U.S. 12346241, in Canada 10953474, or equivalent). |
| Hood Latch Assembly, Secondary Latch, Pivots, Spring Anchor and Release Pawl | Lubriplate Lubricant Aerosol (GM Part No. U.S. 12346293, in Canada 992723, or equivalent) or lubricant meeting requirements of NLGI #2, Category LB or GC-LB. |
| Hood and Door Hinges | Multi-Purpose Lubricant, Superlube (GM Part No. U.S. 12346241, in Canada 10953474, or equivalent). |
| Weatherstrip Conditioning | Dielectric Silicone Grease (GM Part No. U.S. 12345579, in Canada 10953014, or equivalent). |

Part E: Maintenance Record

After the scheduled services are performed, record the date, odometer reading and who performed the service and any additional information from "Owner Checks and Services" or "Periodic Maintenance" on the following record pages. Also, you should retain all maintenance receipts.

Maintenance Record

| Date | Odometer Reading | Serviced By | Maintenance Record |
|------|------------------|-------------|--------------------|
| | | | |
| | | | |
| | | | |
| | | | |
| | | | |
| | | | |
| | | | |
| | | | |
| | | | |

Maintenance Record (cont'd)

| Date | Odometer Reading | Serviced By | Maintenance Record |
|------|------------------|-------------|--------------------|
| | | | |
| | | | |
| | | | |
| | | | |
| | | | |
| | | | |
| | | | |
| | | | |
| | | | |
| | | | |
| | | | |
| | | | |
| | | | |
| | | | |
| | | | |

Maintenance Record (cont'd)

| Date | Odometer Reading | Serviced By | Maintenance Record |
|-------------|-------------------------|--------------------|---------------------------|
| | | | |
| | | | |
| | | | |
| | | | |
| | | | |
| | | | |
| | | | |
| | | | |
| | | | |
| | | | |
| | | | |
| | | | |
| | | | |
| | | | |
| | | | |

Section 7 Customer Assistance Information

| | | | |
|----------------------------------------------|-----|-------------------------------------------------|------|
| Customer Assistance Information | 7-2 | Reporting Safety Defects | 7-9 |
| Customer Satisfaction Procedure | 7-2 | Reporting Safety Defects to the United States | |
| Online Owner Center | 7-3 | Government | 7-9 |
| Customer Assistance for Text Telephone | | Reporting Safety Defects to the Canadian | |
| (TTY) Users | 7-4 | Government | 7-10 |
| Customer Assistance Offices | 7-4 | Reporting Safety Defects to | |
| GM Mobility Program for Persons with | | General Motors | 7-10 |
| Disabilities | 7-5 | Service Publications Ordering Information | 7-10 |
| Roadside Service | 7-6 | | |
| Courtesy Transportation | 7-7 | | |

Customer Assistance Information

Customer Satisfaction Procedure

Your satisfaction and goodwill are important to your dealer and to Cadillac. Normally, any concerns with the sales transaction or the operation of your vehicle will be resolved by your dealer's sales or service departments. Sometimes, however, despite the best intentions of all concerned, misunderstandings can occur. If your concern has not been resolved to your satisfaction, the following steps should be taken:

STEP ONE: Discuss your concern with a member of dealership management. Normally, concerns can be quickly resolved at that level. If the matter has already been reviewed with the sales, service or parts manager, contact the owner of the dealership or the general manager.

STEP TWO: If after contacting a member of dealership management, it appears your concern cannot be resolved by the dealership without further help, contact the Cadillac Customer Assistance Center, 24 hours a day, by calling 1-800-458-8006. In Canada, contact GM of Canada Customer Communication Centre in Oshawa by calling 1-800-263-3777 (English) or 1-800-263-7854 (French).

We encourage you to call the toll-free number in order to give your inquiry prompt attention. Please have the following information available to give the Customer Assistance Representative:

- Vehicle Identification Number (This is available from the vehicle registration or title, or the plate at the top left of the instrument panel and visible through the windshield.)
- Dealership name and location
- Vehicle delivery date and present mileage

When contacting Cadillac, please remember that your concern will likely be resolved at a dealer's facility. That is why we suggest you follow Step One first if you have a concern.

STEP THREE: Both General Motors and your dealer are committed to making sure you are completely satisfied with your new vehicle. However, if you continue to remain unsatisfied after following the procedure outlined in Steps One and Two, you should file with the GM/BBB Auto Line Program to enforce any additional rights you may have. Canadian owners refer to your Warranty and Owner Assistance Information booklet for information on the Canadian Motor Vehicle Arbitration Plan (CAMVAP).

The BBB Auto Line Program is an out of court program administered by the Council of Better Business Bureaus to settle automotive disputes regarding vehicle repairs or the interpretation of the New Vehicle Limited Warranty. Although you may be required to resort to this informal dispute resolution program prior to filing a court action, use of the program is free of charge and your case will generally be heard within 40 days. If you do not agree with the decision given in your case, you may reject it and proceed with any other venue for relief available to you.

You may contact the BBB using the toll-free telephone number or write them at the following address:

BBB Auto Line
Council of Better Business Bureaus, Inc.
4200 Wilson Boulevard
Suite 800
Arlington, VA 22203-1804
Telephone: 1-800-955-5100

This program is available in all 50 states and the District of Columbia. Eligibility is limited by vehicle age, mileage and other factors. General Motors reserves the right to change eligibility limitations and/or discontinue its participation in this program.

Online Owner Center

The Owner Center is a resource for your GM ownership needs. You can find your specific vehicle information all in one place.

The Owner Center allows you to:

- Get e-mail service reminders.
- Access information about your specific vehicle, including tips and videos and an electronic version of this owner's manual. (United States only)
- Keep track of your vehicle's service history and maintenance schedule.
- Find GM dealers for service nationwide.
- Receive special promotions and privileges only available to members. (United States only)

Refer to the web for updated information.

To register your vehicle, visit www.MyGMLink.com. (United States) or My GM Canada within www.gmcanada.com (Canada).

Customer Assistance for Text Telephone (TTY) Users

To assist customers who are deaf, hard of hearing, or speech-impaired and who use Text Telephones (TTYs), Cadillac has TTY equipment available at its Customer Assistance Center. Any TTY user can communicate with Cadillac by dialing: 1-800-833-CMCC (2622). (TTY users in Canada can dial 1-800-263-3830.)

Customer Assistance Offices

Cadillac encourages customers to call the toll-free number for assistance. If a U.S. customer wishes to write to Cadillac, the letter should be addressed to Cadillac's Customer Assistance Center.

United States – Customer Assistance

Cadillac Customer Assistance Center
Cadillac Motor Car Division
P.O. Box 33169
Detroit, MI 48232-5169

1-800-458-8006
1-800-833-2622 (For Text Telephone devices (TTYs))
Roadside Assistance: 1-800-882-1112
Fax Number: 313-381-0022

From Puerto Rico:

1-800-496-9992 (English)
1-800-496-9993 (Spanish)
Fax Number: 313-381-0022

From U.S. Virgin Islands:

1-800-496-9994
Fax Number: 313-381-0022

Canada – Customer Assistance

General Motors of Canada Limited
Customer Communication Centre, 163-005
1908 Colonel Sam Drive
Oshawa, Ontario L1H 8P7

1-800-263-3777 (English)
1-800-263-7854 (French)
1-800-263-3830 (For Text Telephone devices (TTYs))
Roadside Assistance: 1-800-882-1112

Overseas – Customer Assistance

Please contact the local General Motors Business Unit.

Mexico, Central America and Caribbean Islands/Countries (Except Puerto Rico and U.S. Virgin Islands) – Customer Assistance

General Motors de Mexico, S. de R.L. de C.V.
Customer Assistance Center
Paseo de la Reforma # 2740
Col. Lomas de Bezares
C.P. 11910, Mexico, D.F.
01-800-508-0000
Long Distance: 011-52-53 29 0 800

GM Mobility Program for Persons with Disabilities

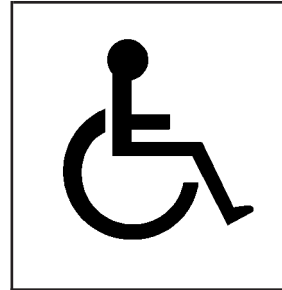

This program, available to qualified applicants, can reimburse you up to \$1,000 toward aftermarket driver or passenger adaptive equipment you may require for your vehicle (hand controls, wheelchair/scooter lifts, etc.).

This program can also provide you with free resource information, such as area driver assessment centers and mobility equipment installers. The program is available for a limited period of time from the date of vehicle purchase/lease. See your dealer for more details or call the GM Mobility Assistance Center at 1-800-323-9935. Text telephone (TTY) users, call 1-800-833-9935.

GM of Canada also has a Mobility Program. Call 1-800-GM-DRIVE (463-7483) for details. All TTY users call 1-800-263-3830.

Roadside Service

Cadillac's exceptional Roadside Service is more than an auto club or towing service. It provides every Cadillac owner with the advantage of contacting a Cadillac advisor and, where available, a Cadillac trained dealer technician who can provide on-site service.

Each technician travels with a specially equipped service vehicle complete with the necessary Cadillac parts and tools required to handle most roadside repairs.

Cadillac Roadside Service® can be reached by dialing 1-800-882-1112, 24 hours a day, 365 days a year. This service is provided at no charge for any warranty-covered situation and for a nominal charge if the Cadillac is no longer under warranty. Roadside Service is available only in the United States and Canada.

Cadillac Owner Privileges™

Roadside Service provides several Cadillac Owner Privileges™ at "no charge," throughout your *Cadillac Warranty Period – 48 months/50,000 miles (80 000 km)*.

Emergency Road Service is performed on site for the following situations:

- Towing Service
- Battery Jump Starting
- Lock Out Assistance
- Fuel Delivery
- Flat Tire Change (Covers change only)
- Trip Interruption – If your trip is interrupted due to a warranty failure, incidental expenses may be reimbursed during the 48 months/50,000 miles (80 000 km) warranty period. Items covered are hotel, meals and rental car.

Roadside Service Availability

Wherever you drive in the United States or Canada, an advisor is available to assist you over the phone. A dealer technician, if available, can travel to your location within a 30 mile (50 km) radius of a participating Cadillac dealership. If beyond this radius, we will arrange to have your car towed to the nearest Cadillac dealership.

Reaching Roadside Service

Dial the toll-free Roadside Service number: 1-800-882-1112. An experienced Roadside Service Advisor will assist you and request the following information:

- A description of the problem
- Name, home address, home telephone number
- Location of your Cadillac and number you are calling from
- The model year, Vehicle Identification Number (VIN), mileage and date of delivery

Roadside Service for the Hearing or Speech Impaired

Roadside Service is prepared to assist owners who have hearing difficulties or are speech impaired. Cadillac has installed special telecommunication devices called Text Telephone (TTY) in the Roadside Service Center.

Any customer who has access to a (TTY) or a conventional teletypewriter can communicate with Cadillac by dialing from the United States or Canada 1-888-889-2438 – daily, 24 hours.

Courtesy Transportation

Cadillac has always exemplified quality and value in its offering of motor vehicles. To enhance your ownership experience, we and our participating dealers are proud to offer Courtesy Transportation, a customer support program for new vehicles.

The Courtesy Transportation program is offered to retail purchase/lease customers in conjunction with the Bumper-to-Bumper coverage provided by the New Vehicle Limited Warranty. Several transportation options are available when warranty repairs are required. This will reduce your inconvenience during warranty repairs.

Plan Ahead When Possible

When your vehicle requires warranty service, you should contact your dealer and request an appointment. By scheduling a service appointment and advising your service consultant of your transportation needs, your dealer can help minimize your inconvenience.

If your vehicle cannot be scheduled into the service department immediately, keep driving it until it can be scheduled for service, unless, of course, the problem is safety-related. If it is, please call your dealership, let them know this, and ask for instructions.

If the dealer requests that you simply drop the vehicle off for service, you are urged to do so as early in the work day as possible to allow for same day repair.

Transportation Options

Warranty service can generally be completed while you wait. However, if you are unable to wait Cadillac helps minimize your inconvenience by providing several transportation options. Depending on the circumstances, your dealer can offer you one of the following:

Shuttle Service

Participating dealers can provide you with shuttle service to get you to your destination with minimal interruption of your daily schedule. This includes a one way shuttle ride to a destination up to 10 miles from the dealership.

Public Transportation or Fuel Reimbursement

If your vehicle requires overnight warranty repairs, reimbursement up to \$30 per day (five days maximum) may be available for the use of public transportation such as taxi or bus. In addition, should you arrange transportation through a friend or relative, reimbursement for reasonable fuel expenses up to \$10 per day (five day maximum) may be available. Claim amounts should reflect actual costs and be supported by original receipts.

Courtesy Rental Vehicle

When your vehicle is unavailable due to overnight warranty repairs, your dealer may arrange to provide you with a courtesy rental vehicle or reimburse you for a rental vehicle you obtained, at actual cost, up to a maximum of \$37.00 per day supported by receipts. This requires that you sign and complete a rental agreement and meet state, local and rental vehicle provider requirements. Requirements vary and may include minimum age requirements, insurance coverage, credit card, etc. You are responsible for fuel usage charges and may also be responsible for taxes, levies, usage fees, excessive mileage or rental usage beyond the completion of the repair.

Generally it is not possible to provide a like-vehicle as a courtesy rental.

Additional Program Information

Courtesy Transportation is available during the Bumper-to-Bumper warranty coverage period, but it *is not* part of the New Vehicle Limited Warranty. A separate booklet entitled *Warranty and Owner Assistance Information* furnished with each new vehicle provides detailed warranty coverage information.

Courtesy Transportation is available only at participating dealers and all program options, such as shuttle service, may not be available at every dealer. Please contact your dealer for specific information about availability. All Courtesy Transportation arrangements will be administered by appropriate dealer personnel.

Canadian Vehicles: For warranty repairs during the Complete Vehicle Coverage period of the General Motors of Canada New Vehicle Limited Warranty, alternative transportation may be available under the Courtesy Transportation Program. Please consult your dealer for details.

General Motors reserves the right to unilaterally modify, change or discontinue Courtesy Transportation at any time and to resolve all questions of claim eligibility pursuant to the terms and conditions described herein at its sole discretion.

Reporting Safety Defects

Reporting Safety Defects to the United States Government

If you believe that your vehicle has a defect which could cause a crash or could cause injury or death, you should immediately inform the National Highway Traffic Safety Administration (NHTSA), in addition to notifying General Motors.

If NHTSA receives similar complaints, it may open an investigation, and if it finds that a safety defect exists in a group of vehicles, it may order a recall and remedy campaign. However, NHTSA cannot become involved in individual problems between you, your dealer or General Motors.

To contact NHTSA, you may either call the Auto Safety Hotline toll-free at 1-800-424-9393 (or 366-0123 in the Washington, D.C. area) or write to:

NHTSA, U.S. Department of Transportation
Washington, D.C. 20590

You can also obtain other information about motor vehicle safety from the hotline.

Reporting Safety Defects to the Canadian Government

If you live in Canada, and you believe that your vehicle has a safety defect, you should immediately notify Transport Canada, in addition to notifying General Motors of Canada Limited. You may write to:

Transport Canada
330 Sparks Street
Tower C
Ottawa, Ontario K1A 0N5

Reporting Safety Defects to General Motors

In addition to notifying NHTSA (or Transport Canada) in a situation like this, we certainly hope you'll notify us. Please call us at 1-800-458-8006, or write:

Cadillac Customer Assistance Center
Cadillac Motor Car Division
P.O. Box 33169
Detroit, MI 48232-5169

In Canada, please call us at 1-800-263-3777 (English) or 1-800-263-7854 (French). Or, write:

Customer Communication Centre, 163-005
General Motors of Canada Limited
1908 Colonel Sam Drive
Oshawa, Ontario L1H 8P7

Service Publications Ordering Information

Service Manuals

Service Manuals have the diagnosis and repair information on engines, transmission, axle, suspension, brakes, electrical, steering, body, etc.

RETAIL SELL PRICE: \$120.00

Transmission, Transaxle, Transfer Case Unit Repair Manual

This manual provides information on unit repair service procedures, adjustments and specifications for GM transmissions, transaxles and transfer cases.

RETAIL SELL PRICE: \$50.00

Service Bulletins

Service Bulletins give technical service information needed to knowledgeably service General Motors cars and trucks. Each bulletin contains instructions to assist in the diagnosis and service of your vehicle.

In Canada, information pertaining to Product Service Bulletins can be obtained by contacting your General Motors dealer or by calling 1-800-GM-DRIVE (1-800-463-7483).

Owner's Information

Owner publications are written specifically for owners and intended to provide basic operational information about the vehicle. The owner's manual will include the Maintenance Schedule for all models.

Owner's Manual

RETAIL SELL PRICE: \$25.00

Current and Past Model Order Forms

Service Publications are available for current and past model GM vehicles. To request an order form, please specify year and model name of the vehicle.

ORDER TOLL FREE: 1-800-551-4123
Monday-Friday 8:00 AM - 6:00 PM
Eastern Time

For Credit Card Orders Only
(VISA-MasterCard-Discover), visit Helm, Inc. on the
World Wide Web at: www.helminc.com

Or you can write to:

Helm, Incorporated
P. O. Box 07130
Detroit, MI 48207

Prices are subject to change without notice and without incurring obligation. Allow ample time for delivery.

Note to Canadian Customers: All listed prices are quoted in U.S. funds. Canadian residents are to make checks payable in U.S. funds.

A

| | |
|------------------------------------------------------------------|------------|
| Accessory Power Outlets | 3-26 |
| Adding Washer Fluid | 5-39 |
| Additional Program Information | 7-9 |
| Additives, Fuel | 5-6 |
| Add-On Electrical Equipment | 5-92 |
| Adjusting the Speakers (Balance/Fade) | 3-81, 3-90 |
| Air Bag System, Supplemental Inflatable Restraint (SIR) | 1-44 |
| Air Bag | 3-42 |
| Readiness Light | 3-42 |
| Air Cleaner/Filter, Engine | 5-19 |
| AM | 3-103 |
| Antenna, Diversity Antenna System | 3-106 |
| Antenna, XM™ Satellite Radio Antenna System | 3-106 |
| Anti-lock Brake System (ABS) | 4-7 |
| Anti-Lock Brake, System Warning Light | 3-44 |
| Anti-Pinch Feature | 2-17 |
| Appearance Care | 5-83 |
| Care of Safety Belts | 5-86 |
| Chemical Paint Spotting | 5-89 |
| Cleaning the Inside of Your Vehicle | 5-84 |
| Cleaning the Outside of Your Vehicle | 5-86 |
| Finish Damage | 5-89 |
| Sheet Metal Damage | 5-88 |
| Underbody Maintenance | 5-89 |

| | |
|-----------------------------------------------------------------------|------------|
| Appearance Care (cont.) Vehicle Care/Appearance Materials | 5-90 |
| Weatherstrips | 5-86 |
| Ashtrays | 3-27 |
| Assist Handles | 2-49 |
| Audio System(s) | 3-78 |
| Audio Steering Wheel Controls | 3-103 |
| Care of Your Cassette Tape Player | 3-104 |
| Care of Your CD Player | 3-105 |
| Care of Your CDs | 3-105 |
| Console-Mounted CD Changer | 3-99 |
| Diversity Antenna System | 3-106 |
| Navigation/Radio System | 3-98 |
| Radio Personalization with Home and Away Feature | 3-102 |
| Radio with Cassette and CD | 3-79, 3-87 |
| Setting the Time for Radios with Radio Data Systems (RDS) | 3-78 |
| Setting the Time for Radios without Radio Data Systems (RDS) | 3-78 |
| Theft-Deterrent Feature | 3-102 |
| Understanding Radio Reception | 3-103 |
| XM™ Satellite Radio Antenna System | 3-106 |
| Auto Exit Seat | 3-66 |
| Auto Exit Steering Wheel | 3-67 |
| Automatic Level Control | 4-34 |
| Automatic Transaxle Check | 6-10 |
| Automatic Transaxle Shift Lock Control System Check | 6-11 |

| | |
|---------------------------|------|
| Automatic Transaxle | 5-21 |
| Fluid | 5-21 |
| Operation | 2-28 |

B

| | |
|-----------------------------------------------------------|------|
| Backing Up | 4-40 |
| Battery Load Management | 3-23 |
| Battery Replacement | 2-8 |
| Battery | 5-43 |
| Before Leaving on a Long Trip | 4-23 |
| Body Lubrication Service | 6-10 |
| Brake Adjustment | 5-42 |
| Brake Fluid | 5-40 |
| Brake Pedal Travel | 5-42 |
| Brake Wear | 5-42 |
| Brake | 2-31 |
| Parking | 2-31 |
| System Inspection | 6-14 |
| System Warning and Parking Brake Indicator Light | 3-43 |
| Brakes | 5-40 |
| Braking in Emergencies | 4-9 |
| Braking | 4-6 |
| Break-In, New Vehicle | 2-23 |
| Bulb Replacement | 5-55 |
| Center High-Mounted Stoplamp (CHMSL) | 5-60 |
| Front Turn Signal Lamps | 5-59 |
| Halogen Bulbs | 5-56 |

| | |
|-----------------------------------------------|------|
| Bulb Replacement (cont.) | |
| Headlamp Aiming | 5-51 |
| Headlamps | 5-56 |
| High Intensity Discharge (HID) Lighting | 5-55 |
| Replacement Bulbs | 5-61 |
| Taillamps and Turn Signal Lamps | 5-60 |
| Buying New Tires | 5-68 |

C

| | |
|--------------------------------------------|------------------------|
| Cadillac Owner Privileges™ | 7-6 |
| California Fuel | 5-5 |
| Canada – Customer Assistance | 7-4 |
| Canadian Owners | ii |
| Capacities and Specifications | 5-100 |
| Carbon Monoxide | 4-26, 4-35, 2-12, 2-35 |
| Care of | 5-86 |
| Safety Belts | 5-86 |
| Your Cassette Tape Player | 3-104 |
| Your CD Player | 3-105 |
| Your CDs | 3-105 |
| Cassette Tape Messages | 3-85, 3-96 |
| Cassette Tape Player Service | 6-9 |
| CD Changer, Console-Mounted | 3-99 |
| Cellular Phone Usage | 3-104 |
| Cellular Telephone, Storage Area | 2-48 |
| Center Console Storage Area | 2-49 |
| Center High-Mounted Stoplamp (CHMSL) | 5-60 |
| Chains, Tires | 5-72 |

| | | | |
|-----------------------------------------------------------------------|------|------------------------------------------------|------------|
| Charging System Light | 3-43 | Cleaning the Mirror | 2-37, 2-40 |
| Checking Coolant | 5-27 | Cleaning the Speaker Covers | 5-85 |
| Checking Engine Oil | 5-14 | Cleaning the Top of the Instrument Panel | 5-85 |
| Checking Things Under the Hood | 5-10 | Cleaning Tires | 5-88 |
| Checking Your Restraint Systems | 1-52 | Cleaning Vinyl | 5-84 |
| Check | 3-47 | Cleaning Windshield and Wiper Blades | 5-87 |
| Engine Light | 3-47 | Cleaning Wood Panels | 5-85 |
| Chemical Paint Spotting | 5-89 | Cleaning | 5-84 |
| Child Restraints | 1-30 | Inside of Your Vehicle | 5-84 |
| Child Restraint Systems | 1-30 | Outside of Your Vehicle | 5-86 |
| Infants and Young Children | 1-26 | Underbody Maintenance | 5-89 |
| Lower Anchorages and Top Tethers for Children (LATCH System) | 1-36 | Weatherstrips | 5-86 |
| Older Children | 1-24 | Climate Control System | 3-35 |
| Securing a Child Restraint Designed for the LATCH System | 1-38 | Air Filter, Passenger Compartment | 3-35 |
| Securing a Child Restraint in a Rear Seat Position | 1-38 | Climate Controls Personalization | 3-36 |
| Securing a Child Restraint in the Right Front Seat Position | 1-41 | Dual | 3-28 |
| Top Strap Anchor Location | 1-35 | Outlet Adjustment | 3-33 |
| Top Strap | 1-33 | Rear | 3-34 |
| Where to Put the Restraint | 1-33 | Steering Wheel Controls | 3-35 |
| Cigarette Lighter | 3-27 | Comfort Controls, DIC Personalization | 3-63 |
| Cleaning Aluminum or Chrome-Plated Wheels | 5-88 | Compact Disc Changer Errors | 3-101 |
| Cleaning Exterior Lamps/Lenses | 5-87 | Compact Disc Messages | 3-86, 3-98 |
| Cleaning Fabric/Carpet | 5-84 | Compact Spare Tire | 5-83 |
| Cleaning Glass Surfaces | 5-85 | Compass Calibration | 2-38 |
| Cleaning Interior Plastic Components | 5-85 | Compass Operation | 2-38 |
| Cleaning Leather | 5-85 | Compass Variance | 2-39 |
| | | Control of a Vehicle | 4-6 |
| | | Convenience Net | 2-49 |
| | | Coolant | 3-46 |
| | | Engine Temperature Gage | 3-46 |

| | |
|-------------------------------------------------------------------|------|
| Coolant (cont.) | |
| Engine Temperature Warning Light | 3-46 |
| Heater, Engine | 2-26 |
| Surge Tank Pressure Cap | 5-28 |
| Cooling System | 5-31 |
| Cornering Lamps | 3-19 |
| Cruise Control Light | 3-51 |
| Cruise Control | 3-13 |
| Current and Past Model Order Forms | 7-11 |
| Customer Assistance Information | 7-7 |
| Courtesy Transportation | 7-7 |
| Customer Assistance for Text Telephone (TTY) Users | 7-4 |
| Customer Assistance Offices | 7-4 |
| Customer Satisfaction Procedure | 7-2 |
| GM Mobility Program for Persons with Disabilities | 7-5 |
| Reporting Safety Defects to General Motors | 7-10 |
| Reporting Safety Defects to the Canadian Government | 7-10 |
| Reporting Safety Defects to the United States Government | 7-9 |
| Roadside Service | 7-6 |
| Service Publications Ordering Information | 7-10 |

D

| | |
|-----------------------------|------|
| Daytime Running Lamps | 3-17 |
| Defensive Driving | 4-2 |

| | |
|------------------------------------------------------------|-------|
| Defogging and Defrosting | 3-32 |
| Dinghy Towing | 4-32 |
| Display Mode | 3-40 |
| Diversity Antenna System | 3-106 |
| Doing Your Own Service Work | 5-3 |
| Dolly Towing | 4-32 |
| Door | 2-10 |
| Central Door Unlocking System | 2-10 |
| Locks | 2-9 |
| Power Door Locks | 2-10 |
| Programmable Automatic Door Locks | 2-10 |
| Rear Door Security Locks | 2-11 |
| Doors Lock in Gear | 3-71 |
| Doors Unlock in PARK (P) | 3-73 |
| Doors Unlock Key Off | 3-74 |
| Driver Information Center (DIC) | 3-53 |
| Climate Controls and Radio System Personalization | 3-63 |
| DIC Controls and Displays | 3-53 |
| DIC Vehicle Personalization | 3-64 |
| DIC Warnings and Messages | 3-56 |
| Driver Unlock in PARK (P) | 3-71 |
| Driver Unlock Key Off | 3-72 |
| Driver | 1-12 |
| Position, Safety Belt | 1-12 |
| Driver's Name Set/Recall | 3-76 |
| Driving on Grades | 4-41 |
| Driving on Snow or Ice | 4-27 |
| Driving Through Deep Standing Water | 4-20 |
| Driving Through Flowing Water | 4-20 |

| | |
|-----------------------------------|------|
| Driving with a Trailer | 4-39 |
| Driving | 4-17 |
| At Night | 4-17 |
| City | 4-21 |
| Defensive | 4-2 |
| Drunken | 4-3 |
| Freeway | 4-22 |
| Hill and Mountain Roads | 4-24 |
| In Rain and on Wet Roads | 4-18 |
| Winter | 4-26 |
| Dual Climate Control System | 3-28 |

E

| | |
|--------------------------------------------------------|------|
| Electrical System | 5-92 |
| Add-On Equipment | 5-92 |
| Fuses and Circuit Breakers | 5-93 |
| Headlamp Wiring | 5-92 |
| Power Windows and Other Power Options | 5-92 |
| Removing the Rear Seat Cushion | 5-96 |
| Windshield Wiper Fuses | 5-92 |
| Emergency Trunk Release Handle | 2-14 |
| Emissions Inspection and Maintenance Programs | 3-49 |
| Engine Coolant Level Check | 6-9 |
| Engine Cooling When Trailer Towing | 4-42 |
| Engine Oil Additives | 5-17 |

| | |
|-------------------------------------------|------|
| Engine Oil Level Check | 6-9 |
| Engine Oil Scheduled Maintenance | 6-5 |
| Engine Speed Limiter | 3-41 |
| Engine | 5-19 |
| Air Cleaner/Filter | 5-19 |
| Battery | 5-43 |
| Check and Service Engine Soon Light | 3-47 |
| Compartment Overview | 5-12 |
| Coolant Heater | 2-26 |
| Coolant Temperature Gage | 3-46 |
| Coolant Temperature Warning Light | 3-46 |
| Coolant | 5-25 |
| Cooling System Inspection | 6-14 |
| Exhaust | 2-35 |
| Oil | 5-13 |
| Overheating | 5-28 |
| Starting | 2-25 |
| English Metric Display | 3-40 |
| Entering Feature Programming | 3-64 |
| Entry Lighting | 3-22 |
| Erasing HomeLink® Buttons | 2-47 |
| Exiting Feature Programming | 3-76 |
| Express-Down Window | 2-16 |
| Express-Up Window | 2-16 |
| Extender, Safety Belt | 1-23 |
| Exterior Lamps | 3-16 |
| Exterior Lighting Battery Saver | 3-20 |
| Exterior Lights at Unlock | 3-70 |

F

| | |
|-------------------------------------------|------------|
| Filter | 5-19 |
| Engine Air Cleaner | 5-19 |
| Finding a PTY Station (RDS and XM™) | 3-92 |
| Finding a PTY Station (XM™ Only) | 3-81 |
| Finding a Station | 3-80, 3-89 |
| Finish Care | 5-87 |
| Finish Damage | 5-89 |
| Flat Tire, Changing | 5-74 |
| Flat Tire | 5-73 |
| Floor Mats | 2-49 |
| Fluid | 5-21 |
| Automatic Transaxle | 5-21 |
| Power Steering | 5-38 |
| Windshield Washer | 5-39 |
| FM Stereo | 3-103 |
| Fog Lamp Light | 3-51 |
| Fog Lamps | 3-18 |
| Following Distance | 4-39 |
| Footnotes | 6-5 |
| Front Ashtray | 3-27 |
| Fuel | 5-4 |
| Additives | 5-6 |
| California Fuel | 5-5 |
| Filling a Portable Fuel Container | 5-10 |
| Filling Your Tank | 5-6 |
| Fuels in Foreign Countries | 5-6 |
| Gage | 3-52 |
| Gasoline Octane | 5-4 |

| | |
|----------------------------------|------|
| Fuel (cont.) | |
| Gasoline Specifications | 5-5 |
| System Inspection | 6-13 |
| Fuses | 5-93 |
| Fuses and Circuit Breakers | 5-93 |
| Windshield Wiper | 5-92 |

G

| | |
|------------------------------------------------------------|------|
| Gage | 3-46 |
| Engine Coolant Temperature | 3-46 |
| Fuel | 3-52 |
| Speedometer | 3-39 |
| Tachometer | 3-41 |
| Garage Door Opener | 2-44 |
| Garment Hooks | 2-49 |
| Gasoline | 5-4 |
| Octane | 5-4 |
| Specifications | 5-5 |
| Gate Operator and Canadian Programming | 2-47 |
| Glove Box | 2-48 |
| GM Mobility Program for Persons with Disabilities | 7-5 |

H

| | |
|--------------------------------------|------|
| Hazard Warning Flashers | 3-6 |
| Head Restraints | 1-5 |
| Headlamp High/Low-Beam Changer | 3-10 |

| | |
|------------------------------|------|
| Instrument Panel | 3-38 |
| Cluster | 3-38 |
| Overview | 3-4 |
| Interior Lamps Control | 3-21 |
| Interior Lamps | 3-21 |

J

| | |
|---------------------|------|
| Jump Starting | 5-45 |
|---------------------|------|

K

| | |
|----------------------------------|------|
| Key in Recall Memory | 3-65 |
| Key Lock Cylinders Service | 6-10 |
| Keyless Entry System | 2-5 |
| Keys | 2-3 |

L

| | |
|-------------------------|------------|
| Lamps On Reminder | 3-17 |
| Lamps | 3-16 |
| Exterior | 3-16 |
| Interior | 3-21 |
| Lap-Shoulder Belt | 1-12, 1-20 |
| LATCH System | 1-36 |
| Child Restraints | 1-36 |

| | |
|----------------------------------------------------------------|------|
| LATCH System (cont.) | |
| Securing a Child Restraint Designed for the LATCH System | 1-38 |
| Leaving Your Vehicle With the Engine Running ... | 2-33 |
| Leaving Your Vehicle | 2-11 |
| Lighted Visor Vanity Mirrors | 2-18 |
| Light | 3-42 |
| Air Bag Readiness | 3-42 |
| Anti-Lock Brake System Warning | 3-44 |
| Brake System Warning and Parking Brake Indicator | 3-43 |
| Charging System | 3-43 |
| Cruise Control | 3-51 |
| Engine Coolant Temperature Warning | 3-46 |
| Fog Lamp | 3-51 |
| Lights On Reminder | 3-51 |
| Malfunction Indicator | 3-47 |
| Oil Pressure | 3-50 |
| Safety Belt Reminder | 3-41 |
| Security | 3-51 |
| TCS Warning Light | 3-45 |
| Traction Control System (TCS) Warning | 3-45 |
| Lights Flash at Lock | 3-68 |
| Lights Flash at Unlock | 3-68 |
| Loading Your Vehicle | 4-33 |
| Lockout Protection | 2-11 |
| Locks | 2-10 |
| Central Door Unlocking System | 2-10 |
| Door | 2-9 |

| | |
|-----------------------------------------|------|
| Locks (cont.) | |
| Leaving Your Vehicle | 2-11 |
| Lockout Protection | 2-11 |
| Power Door | 2-10 |
| Programmable Automatic Door Locks | 2-10 |
| Rear Door Security Locks | 2-11 |
| Loss of Control | 4-16 |
| Lumbar | 1-2 |
| Power Controls | 1-2 |

M

| | |
|-----------------------------------------------|-------|
| Magnetic Ride Control | 4-11 |
| Magnetic Speed Variable Assist Steering | 4-11 |
| Maintenance, Normal Replacement Parts | 5-101 |
| Maintenance Schedule | 6-9 |
| At Each Fuel Fill | 6-9 |
| At Least Once a Month | 6-9 |
| At Least Once a Year | 6-10 |
| At Least Twice a Year | 6-10 |
| Brake System Inspection | 6-14 |
| Engine Cooling System Inspection | 6-14 |
| Exhaust System Inspection | 6-13 |
| Fuel System Inspection | 6-13 |
| How This Section is Organized | 6-3 |
| Introduction | 6-2 |
| Maintenance Requirements | 6-2 |
| Part A - Scheduled Maintenance Services | 6-4 |
| Part B - Owner Checks and Services | 6-9 |

| | |
|-----------------------------------------------------------------------------------------------------------------------------------------|------------|
| Maintenance Schedule (cont.) | |
| Part C - Periodic Maintenance Inspections | 6-13 |
| Part D - Recommended Fluids and Lubricants | 6-15 |
| Part E - Maintenance Record | 6-16 |
| Scheduled Maintenance | 6-4 |
| Steering, Suspension and Front Drive Axle | |
| Boot and Seal Inspection | 6-13 |
| Throttle System Inspection | 6-14 |
| Using Your | 6-4 |
| Your Vehicle and the Environment | 6-2 |
| Maintenance When Trailer Towing | 4-42 |
| Making Turns | 4-40 |
| Malfunction Indicator Light | 3-47 |
| Map Pocket | 2-49 |
| Matching Transmitter(s) to Your Vehicle | 2-7 |
| Memory Mirrors | 2-51 |
| Memory Seat | 2-51 |
| Memory Steering Wheel Controls | 2-51 |
| Message | 3-56 |
| DIC Warnings and Messages | 3-56 |
| Mexico, Central America and Caribbean Islands/ Countries (Except Puerto Rico and U.S. Virgin Islands) – Customer Assistance | 7-5 |
| Mirror Operation | 2-37, 2-38 |
| Mirror to Curb In Reverse | 3-74 |
| Mirrors | 2-38 |
| Automatic Dimming Rearview with OnStar [®] and Compass | 2-38 |
| Automatic Dimming Rearview with OnStar [®] | 2-37 |

| | |
|----------------------------------|------|
| Mirrors (cont.) | |
| Memory | 2-51 |
| Outside Automatic Dimming Mirror | 2-41 |
| Outside Convex Mirror | 2-41 |
| Outside Curb View Assist Mirror | 2-41 |
| Outside Heated Mirrors | 2-41 |
| Outside Power Mirrors | 2-40 |
| MyGMLink.com | 7-3 |

N

| | |
|--------------------------------------|-------|
| Navigation/Radio System | 3-98 |
| New Vehicle Break-In | 2-23 |
| Normal Maintenance Replacement Parts | 5-101 |

O

| | |
|---------------------------------------------|------|
| Odometer | 3-39 |
| Off-Road Recovery | 4-14 |
| Oil | 5-13 |
| Engine | 5-13 |
| Life Indicator | 3-77 |
| Pressure Light | 3-50 |
| Older Children, Restraints | 1-24 |
| Online Owner Center | 7-3 |
| OnStar [®] Personal Calling | 2-43 |
| OnStar [®] Services | 2-42 |
| OnStar [®] Steering Wheel Controls | 2-43 |
| OnStar [®] System | 2-42 |

| | |
|-------------------------------------|------|
| OnStar [®] Virtual Advisor | 2-43 |
| Other Warning Devices | 3-7 |
| Outlet Adjustment | 3-33 |
| Outside | 2-41 |
| Automatic Dimming Mirror | 2-41 |
| Convex Mirror | 2-41 |
| Curb View Assist Mirror | 2-41 |
| Heated Mirrors | 2-41 |
| Power Mirrors | 2-40 |
| Overheated Engine Protection | |
| Operating Mode | 5-28 |
| Overseas – Customer Assistance | 7-5 |
| Owners, Canadian | ii |
| Owner's Information | 7-11 |

P

| | |
|------------------------------------------------|------|
| Parade Dimming | 3-22 |
| Park Aid | 3-24 |
| Park (P) | 2-32 |
| Shifting Into | 2-32 |
| Shifting Out of | 2-34 |
| Parking Brake and Automatic Transaxle Park (P) | |
| Mechanism Check | 6-12 |
| Parking on Hills | 4-41 |
| Parking | 3-24 |
| Assist | 3-24 |
| Brake Indicator Light | 3-43 |

| | |
|-------------------------------------------------|------------|
| Parking (cont.) | |
| Brake | 2-31 |
| Over Things That Burn | 2-35 |
| Part A - Scheduled Maintenance Services | 6-4 |
| Part B - Owner Checks and Services | 6-9 |
| Part C - Periodic Maintenance Inspections | 6-13 |
| Part D - Recommended Fluids and Lubricants | 6-15 |
| Part E - Maintenance Record | 6-16 |
| Passenger Compartment Air Filter | 3-35 |
| Passing | 4-14, 4-39 |
| PASS-Key [®] III Operation | 2-21 |
| PASS-Key [®] III | 2-21 |
| ii | |
| Performance Shift Display (STS Only) | 2-30 |
| Personalization, Climate Controls | 3-36 |
| Plan Ahead When Possible | 7-8 |
| Playing a Cassette Tape | 3-84, 3-95 |
| Playing a Compact Disc | 3-85, 3-96 |
| Playing the Radio | 3-79, 3-88 |
| Power Steering | 4-11 |
| Power Tilt Wheel and Telescopic Steering | |
| Column | 3-8 |
| Power | 3-26 |
| Accessory Outlets | 3-26 |
| Door Locks | 2-10 |
| Electrical System | 5-92 |
| Lumbar Controls | 1-2 |
| Seat | 1-2 |

| | |
|--------------------------------------------|------|
| Power (cont.) | |
| Steering Fluid | 5-38 |
| Windows | 2-16 |
| Pretensioners, Safety Belt | 1-23 |
| Programmable Automatic Door Locks | 2-10 |
| Programming the HomeLink Transmitter | 2-45 |
| Programming the Power Windows | 2-17 |

Q

| | |
|------------------------------------------------|------|
| Questions and Answers About Safety Belts | 1-10 |
|------------------------------------------------|------|

R

| | |
|-----------------------------------------|------------|
| Radio Data System (RDS) | 3-87 |
| Radios | 3-78 |
| Care of Your Cassette Tape Player | 3-104 |
| Care of Your CD Player | 3-105 |
| Care of Your CDs | 3-105 |
| Console-Mounted CD Changer | 3-99 |
| DIC Personalization | 3-63 |
| Navigation/Radio System | 3-98 |
| Radio Personalization with Home and | |
| Away Feature | 3-102 |
| Radio with Cassette and CD | 3-79, 3-87 |
| Setting the Time for Radios with Radio | |
| Data Systems (RDS) | 3-78 |

| | |
|-----------------------------------------------------------------------|-------|
| Radios (cont.) | |
| Setting the Time for Radios without Radio Data Systems (RDS) | 3-78 |
| Theft-Deterrent | 3-102 |
| Understanding Reception | 3-103 |
| Rainsense™ II Wipers | 3-11 |
| RDS Messages | 3-91 |
| Reaching Roadside Service | 7-7 |
| Reading Lamps | 3-22 |
| Rear Ashtray | 3-27 |
| Rear Climate Control System | 3-34 |
| Rear Door Security Locks | 2-11 |
| Rear Seat Passenger Positions | 1-19 |
| Rear Seat Passengers, Safety Belts | 1-19 |
| Rear Seat Pass-Through Door | 2-14 |
| Rear Underseat Fuse Block | 5-97 |
| Rear Window Defogger | 3-32 |
| Rearview Mirror, Automatic Dimming with OnStar® and Compass | 2-38 |
| Rearview Mirror, Automatic Dimming with OnStar® | 2-37 |
| Reclining Seatbacks | 1-3 |
| Recreational Vehicle Towing | 4-31 |
| Remote Keyless Entry System, Operation | 2-6 |
| Remote Keyless Entry System | 2-5 |
| Remote Recall Memory | 3-65 |
| Removing the Flat Tire and Installing the Spare Tire | 5-76 |
| Removing the Spare Tire and Tools | 5-75 |
| Replacement Bulbs | 5-61 |
| Replacing Brake System Parts | 5-43 |
| Replacing Restraint System Parts After a Crash | 1-53 |
| Reporting Safety Defects | 7-10 |
| Canadian Government | 7-10 |
| General Motors | 7-10 |
| United States Government | 7-9 |
| Reprogramming a Single HomeLink® Button | 2-48 |
| Resetting Defaults | 2-48 |
| Restraint System Check | 6-10 |
| Checking Your Restraint Systems | 1-52 |
| Replacing Restraint System Parts After a Crash | 1-53 |
| Restraint Systems | 1-52 |
| Checking | 1-52 |
| Replacing Parts | 1-53 |
| Retained Accessory Power (RAP) | 2-25 |
| Right Front Passenger Position, Safety Belts | 1-19 |
| Roadside Service Availability | 7-7 |
| Roadside Service for the Hearing or Speech Impaired | 7-7 |
| Roadside | 7-6 |
| Service | 7-6 |
| Rocking Your Vehicle To Get It Out | 4-30 |
| Running Your Engine While You Are Parked | 2-36 |
| S | |
| Safety Belt | 1-23 |
| Pretensioners | 1-23 |

| | | | |
|------------------------------------------|------|-----------------------------------------------------------------------------------|------------|
| Safety Belt (cont.) | | Service Engine Soon Light in the United States or Check Engine Light in Canada | 3-47 |
| Reminder Light | 3-41 | Service Manuals | 7-10 |
| Safety Belts | 5-86 | Service | 5-3 |
| Care of | 5-86 | Adding Equipment to the Outside of Your Vehicle | 5-4 |
| Driver Position | 1-12 | Doing Your Own Work | 5-3 |
| How to Wear Safety Belts Properly | 1-11 | Engine Soon Light | 3-47 |
| Questions and Answers About Safety Belts | 1-10 | Publications Ordering Information | 7-10 |
| Rear Seat Passengers | 1-19 | Setting Preset Stations | 3-80, 3-89 |
| Right Front Passenger Position | 1-19 | Setting the Time | 3-78 |
| Safety Belt Extender | 1-23 | Radios with Radio Data Systems (RDS) | 3-78 |
| Safety Belt Use During Pregnancy | 1-18 | Radios without Radio Data Systems (RDS) | 3-78 |
| Safety Belts Are for Everyone | 1-6 | Setting the Tone (Bass/Treble) | 3-81, 3-90 |
| Safety Chains | 4-38 | Sheet Metal Damage | 5-88 |
| Safety Warnings and Symbols | iii | Shifting Into Park (P) | 2-32 |
| Scheduled Maintenance | 6-4 | Shifting Out of Park (P) | 2-34 |
| Seat | 1-5 | Shoulder Belt Height Adjuster | 1-13 |
| Head Restraints | 1-5 | Skidding | 4-16 |
| Seats | 1-3 | Some Other Rainy Weather Tips | 4-20 |
| Heated Seats | 1-3 | Specifications, Capacities | 5-100 |
| Memory | 2-51 | Speedometer | 3-39 |
| Power Lumbar | 1-2 | Starter Switch Check | 6-11 |
| Power Seats | 1-2 | Starting Your Engine | 2-25 |
| Reclining Seatbacks | 1-3 | Steering in Emergencies | 4-13 |
| Securing a Child Restraint | 1-38 | Steering, Suspension and Front Drive Axle Boot and Seal Inspection | 6-13 |
| Designed for the LATCH System | 1-38 | Steering Tips | 4-11 |
| Rear Seat Position | 1-38 | Steering Wheel Climate Controls | 3-35 |
| Right Front Seat Position | 1-41 | Steering Wheel Controls, Audio | 3-103 |
| Security Light | 3-51 | | |
| Sensors | 3-31 | | |
| Service Bulletins | 7-10 | | |

| | |
|---------------------------------------------------|------|
| Steering Wheel Controls, Memory | 2-51 |
| Steering | 4-11 |
| Storage Areas | 2-48 |
| Cellular Telephone | 2-48 |
| Center Console Storage Area | 2-49 |
| Convenience Net | 2-49 |
| Glove Box | 2-48 |
| Map Pocket | 2-49 |
| Umbrella Holder | 2-49 |
| Storage | 2-49 |
| Garment Hooks | 2-49 |
| Storing the Flat Tire and Tools | 5-81 |
| Storing the Spare Tire and Tools | 5-82 |
| Stuck in Sand, Mud, Ice or Snow | 4-30 |
| Sun Visors | 2-18 |
| Sunroof | 2-50 |
| Supplemental Inflatable Restraints (SIR) | 1-44 |
| How Does an Air Bag Restrain? | 1-50 |
| Servicing Your Air Bag-Equipped Vehicle | 1-52 |
| What Makes an Air Bag Inflate? | 1-49 |
| What Will You See After an Air Bag Inflates? | 1-50 |
| When Should an Air Bag Inflate? | 1-49 |
| Where Are the Air Bags? | 1-46 |

T

| | |
|-------------------------|------|
| Tachometer | 3-41 |
| Taillamps | 5-60 |
| Turn Signal Lamps | 5-60 |

| | |
|--------------------------------------------|-------|
| Taillamps (cont.) | |
| TCS Warning Light | 3-45 |
| Testing the Alarm | 2-20 |
| Theft-Deterrent, Radio | 3-102 |
| Theft-Deterrent Systems | 2-19 |
| PASS-Key [®] III Operation | 2-21 |
| PASS-Key [®] III | 2-21 |
| Throttle System Inspection | 6-14 |
| Tilt Wheel | 3-7 |
| Tire Inflation Check | 6-9 |
| Tire Pressure Display | 3-75 |
| Tires | 5-63 |
| Buying New Tires | 5-68 |
| Chains | 5-72 |
| Changing a Flat Tire | 5-74 |
| Compact Spare Tire | 5-83 |
| If a Tire Goes Flat | 5-73 |
| Inflation -- Tire Pressure | 5-64 |
| Inspection and Rotation | 5-67 |
| Pressure Monitor System | 5-65 |
| Uniform Tire Quality Grading | 5-69 |
| Wheel Alignment and Tire Balance | 5-71 |
| Wheel Replacement | 5-71 |
| When It Is Time for New Tires | 5-68 |
| To Use the Engine Coolant Heater | 2-27 |
| Top Strap Anchor Location | 1-35 |
| Top Strap | 1-33 |
| Torque Lock | 2-34 |
| Total Weight on Your Vehicle's Tires | 4-38 |

| | |
|---------------------------------------------|------|
| Towing | 4-31 |
| Recreational Vehicle | 4-31 |
| Towing a Trailer | 4-35 |
| Your Vehicle | 4-31 |
| Traction | 4-9 |
| Control System (TCS) | 4-9 |
| Control System Warning Light | 3-45 |
| Magnetic Ride Control | 4-11 |
| Trailer Brakes | 4-39 |
| Transaxle Operation, Automatic | 2-28 |
| Transaxle | 5-21 |
| Fluid, Automatic | 5-21 |
| Transmission, Transaxle, Transfer Case Unit | |
| Repair Manual | 7-10 |
| Transportation Options | 7-8 |
| Trip Computer | 3-77 |
| Oil Life Indicator | 3-77 |
| Trip Odometers | 3-39 |
| Trunk Lid Tie Down | 2-13 |
| Trunk Lock Release | 2-12 |
| Trunk | 2-12 |
| Turn and Lane-Change Signals | 3-9 |
| Turn Signal/Multifunction Lever | 3-9 |
| Turn Signals When Towing a Trailer | 4-40 |
| Twilight Sentinel® | 3-19 |

U

| | |
|---------------------------------------------|------|
| Ultrasonic Rear Parking Assist (URPA) | 3-24 |
| Umbrella Holder | 2-49 |

| | |
|---------------------------------------------|-------|
| Underbody Flushing Service | 6-12 |
| Underhood Fuse Block | 5-93 |
| Understanding Radio Reception | 3-103 |
| Uniform Tire Quality Grading | 5-69 |
| United States – Customer Assistance | 7-4 |
| Used Replacement Wheels | 5-72 |
| Using Digital Signal Processing (DSP) | 3-90 |
| Using HomeLink® | 2-47 |

V

| | |
|-----------------------------------------------|------|
| Valet Lockout Switch | 2-20 |
| Vehicle Identification | 5-91 |
| Number (VIN) | 5-91 |
| Service Parts Identification Label | 5-92 |
| Vehicle Personalization | 3-64 |
| DIC | 3-64 |
| Memory Seat, Mirrors and Steering Wheel | 2-51 |
| Vehicle Speed Limiter | 3-41 |
| Vehicle Storage | 5-44 |
| Vehicle | 4-6 |
| Control | 4-6 |
| Damage Warnings | iv |
| Loading | 4-33 |
| Symbols | iv |
| Ventilation Adjustment | 3-33 |
| Visors | 2-18 |

W

| | |
|---------------------------------------------------------------|------------------|
| Warning Lights, Gages and Indicators | 3-37 |
| Warnings | 3-56 |
| DIC Warnings and Messages | 3-56 |
| Hazard Warning Flashers | 3-6 |
| Other Warning Devices | 3-7 |
| Safety and Symbols | iii |
| Vehicle Damage | iv |
| Washing Your Vehicle | 5-86 |
| Weather Band | 3-104 |
| Weatherstrip Lubrication | 6-10 |
| Weight of the Trailer Tongue | 4-37 |
| Weight of the Trailer | 4-36 |
| What Kind of Engine Oil to Use | 5-16 |
| What to Do with Used Oil | 5-18 |
| What to Use | 5-26, 5-38, 5-39 |
| Wheels | 5-71 |
| Alignment and Tire Balance | 5-71 |
| Replacement | 5-71 |
| When to Add Engine Oil | 5-15 |
| When to Change Engine Oil (GM Oil Life System) | 5-17 |
| When to Check and Change | 5-21 |
| When to Check Power Steering Fluid | 5-38 |
| When to Check | 5-65 |
| When You Are Ready to Leave After Parking on a Hill: | 4-42 |

| | |
|-------------------------------------------|------|
| Where to Put the Restraint | 1-33 |
| Why Safety Belts Work | 1-7 |
| Window Lockout | 2-18 |
| Windows | 2-15 |
| Power | 2-16 |
| Windshield Washer Fluid Level Check | 6-9 |
| Windshield Washer | 3-12 |
| Fluid | 5-39 |
| Windshield Wiper | 5-62 |
| Blade Replacement | 5-62 |
| Fuses | 5-92 |
| Windshield Wipers | 3-10 |
| Winter Driving | 4-26 |
| Wiper Blade Check | 6-10 |
| Wiper-Activated Headlamps | 3-17 |

X

| | |
|-------------------------------------------------|------------|
| XM™ Radio Satellite Service (USA Only) | 3-79, 3-88 |
| XM™ Satellite Radio Antenna System | 3-106 |
| XM™ Satellite Radio Service (USA Only) | 3-103 |

Y

| | |
|----------------------------------------|-----|
| Your Vehicle and the Environment | 6-2 |
|----------------------------------------|-----|