

2004 Chevrolet Aveo Owner Manual

Seats and Restraint Systems	1-1	Driving Your Vehicle	4-1
Front Seats	1-2	Your Driving, the Road, and Your Vehicle	4-2
Rear Seats	1-6	Towing	4-29
Safety Belts	1-10	Service and Appearance Care	5-1
Child Restraints	1-28	Service	5-3
Air Bag Systems	1-50	Fuel	5-5
Restraint System Check	1-58	Checking Things Under the Hood	5-11
Features and Controls	2-1	Headlamp Aiming	5-45
Keys	2-2	Bulb Replacement	5-45
Doors and Locks	2-7	Windshield Wiper Blade Replacement	5-50
Windows	2-13	Tires	5-51
Theft-Deterrent Systems	2-15	Appearance Care	5-76
Starting and Operating Your Vehicle	2-18	Vehicle Identification	5-83
Mirrors	2-34	Electrical System	5-84
Storage Areas	2-36	Capacities and Specifications	5-91
Sunroof	2-37	Maintenance Schedule	6-1
Instrument Panel	3-1	Maintenance Schedule	6-2
Instrument Panel Overview	3-2	Customer Assistance and Information	7-1
Climate Controls	3-12	Customer Assistance and Information	7-2
Warning Lights, Gages, and Indicators	3-17	Reporting Safety Defects	7-10
Secondary Information Center (SIC)	3-24	Index	1
Audio System(s)	3-34		



GENERAL MOTORS, GM, the GM Emblem, CHEVROLET, and the CHEVROLET Emblem are registered trademarks of General Motors Corporation. The name AVEO is a trademark of General Motors Corporation.

This manual includes the latest information at the time it was printed. We reserve the right to make changes after that time without further notice. For vehicles first sold in Canada, substitute the name "General Motors of Canada Limited" for Chevrolet Motor Division whenever it appears in this manual.

Please keep this manual in your vehicle, so it will be there if you ever need it when you're on the road. If you sell the vehicle, please leave this manual in it so the new owner can use it.

Canadian Owners

You can obtain a French language copy of this manual from your dealer or from:

Helm, Incorporated
P.O. Box 07130
Detroit, MI 48207

How to Use This Manual

Many people read their owner's manual from beginning to end when they first receive their new vehicle. If you do this, it will help you learn about the features and controls for your vehicle. In this manual, you will find that pictures and words work together to explain things.

Index

A good place to look for what you need is the Index in back of the manual. It is an alphabetical list of what is in the manual, and the page number where you will find it.

Safety Warnings and Symbols

You will find a number of safety cautions in this book. We use a box and the word CAUTION to tell you about things that could hurt you if you were to ignore the warning.

 **CAUTION:**

These mean there is something that could hurt you or other people.

In the caution area, we tell you what the hazard is. Then we tell you what to do to help avoid or reduce the hazard. Please read these cautions. If you don't, you or others could be hurt.

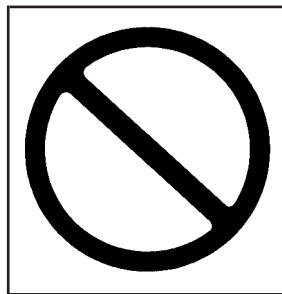

You will also find a circle with a slash through it in this book. This safety symbol means “Don’t,” “Don’t do this” or “Don’t let this happen.”

Vehicle Damage Warnings

Also, in this book you will find these notices:

Notice: These mean there is something that could damage your vehicle.

A notice will tell you about something that can damage your vehicle. Many times, this damage would not be covered by your warranty, and it could be costly. But the notice will tell you what to do to help avoid the damage.

When you read other manuals, you might see CAUTION and NOTICE warnings in different colors or in different words.

You'll also see warning labels on your vehicle. They use the same words, CAUTION or NOTICE.

































Vehicle Symbols

Your vehicle has components and labels that use symbols instead of text. Symbols, used on your vehicle, are shown along with the text describing the operation or information relating to a specific component, control, message, gage or indicator.

If you need help figuring out a specific name of a component, gage or indicator, reference the following topics:

- Seats and Restraint Systems in Section 1
- Features and Controls in Section 2
- Instrument Panel Overview in Section 3
- Climate Controls in Section 3
- Warning Lights, Gages and Indicators in Section 3
- Audio System(s) in Section 3
- Engine Compartment Overview in Section 5

These are some examples of symbols you may find on your vehicle:

<p>CAUTION POSSIBLE INJURY </p>	<p>LATCH BOTH LAP AND SHOULDER BELTS TO PROTECT OCCUPANT DO NOT TWIST SAFETY BELT WHEN ATTACHING  </p>	<p>MASTER LIGHTING SWITCH </p>	<p>ENGINE COOLANT TEMP </p>	<p>FUSE BOX ACCESS </p>	
<p>PROTECT EYES BY SHIELDING </p>	<p>FASTEN SEAT BELTS </p>	<p>AIR BAG </p>	<p>TURN SIGNALS </p>	<p>BATTERY CHARGING SYSTEM </p>	<p>ENGINE COOLANT FAN </p>
<p>CAUSTIC BATTERY ACID COULD CAUSE BURNS </p>	<p>MOVE SEAT FULLY REARWARD SECURE CHILD SEAT </p>	<p>DO NOT INSTALL A REAR-FACING CHILD RESTRAINT IN THIS SEATING POSITION </p>	<p>PARKING LAMPS </p>	<p>BRAKE </p>	<p>FUEL </p>
<p>AVOID SPARKS OR FLAMES </p>	<p>PULL BELT OUT COMPLETELY THEN SECURE CHILD SEAT </p>	<p>DO NOT INSTALL A FORWARD-FACING CHILD RESTRAINT IN THIS SEATING POSITION </p>	<p>HAZARD WARNING FLASHER </p>	<p>COOLANT </p>	<p>OWNER'S MANUAL </p>
<p>SPARK OR FLAME COULD EXPLODE BATTERY </p>	<p>POWER WINDOW </p>	<p>DOOR LOCK UNLOCK </p>	<p>DAYTIME RUNNING LAMPS </p>	<p>ENGINE OIL PRESSURE </p>	<p>SERVICE </p>
			<p>FOG LAMPS </p>	<p>ANTI-LOCK BRAKES (ABS) </p>	<p>SERVICE MANUAL </p>



NOTES

Section 1 Seats and Restraint Systems

Front Seats	1-2	Top Strap	1-38
Manual Seats	1-2	Top Strap Anchor Location	1-40
Driver Seat Height Adjuster	1-3	Lower Anchorages and Top Tethers for Children (LATCH System)	1-41
Reclining Seatbacks	1-3	Securing a Child Restraint Designed for the LATCH System	1-44
Head Restraints	1-5	Securing a Child Restraint in a Rear Seat Position	1-44
Rear Seats	1-6	Securing a Child Restraint in the Right Front Seat Position	1-46
Rear Seat Operation (Hatchback)	1-6	Air Bag Systems	1-50
Rear Seat Operation (Sedan)	1-8	Where Are the Air Bags?	1-53
Safety Belts	1-10	When Should an Air Bag Inflate?	1-55
Safety Belts: They Are for Everyone	1-10	What Makes an Air Bag Inflate?	1-55
Questions and Answers About Safety Belts	1-14	How Does an Air Bag Restrain?	1-56
How to Wear Safety Belts Properly	1-15	What Will You See After an Air Bag Inflates?	1-56
Driver Position	1-15	Servicing Your Air Bag-Equipped Vehicle	1-58
Safety Belt Use During Pregnancy	1-22	Restraint System Check	1-58
Right Front Passenger Position	1-23	Checking Your Restraint Systems	1-58
Rear Seat Passengers	1-23	Replacing Restraint System Parts After a Crash	1-59
Center Rear Passenger Position	1-26		
Safety Belt Pretensioners	1-27		
Child Restraints	1-28		
Older Children	1-28		
Infants and Young Children	1-30		
Child Restraint Systems	1-34		
Where to Put the Restraint	1-37		

Front Seats

Manual Seats

CAUTION:

You can lose control of the vehicle if you try to adjust a manual driver's seat while the vehicle is moving. The sudden movement could startle and confuse you, or make you push a pedal when you don't want to. Adjust the driver's seat only when the vehicle is not moving.



Pull up and hold the bar located under the front of the seat to unlock it.

Slide the seat to where you want it and release the bar. Then try to move the seat with your body, to make sure the seat is locked into place.

Driver Seat Height Adjuster

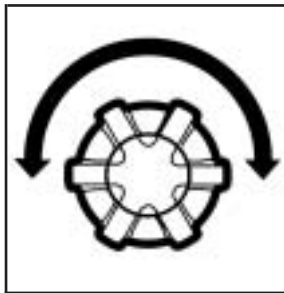

To adjust the height of the driver's seat cushion, turn the knob located on the outboard side of the seat cushion.

Turn the knob forward to raise the height of the seat cushion and rearward to lower it.

Reclining Seatbacks

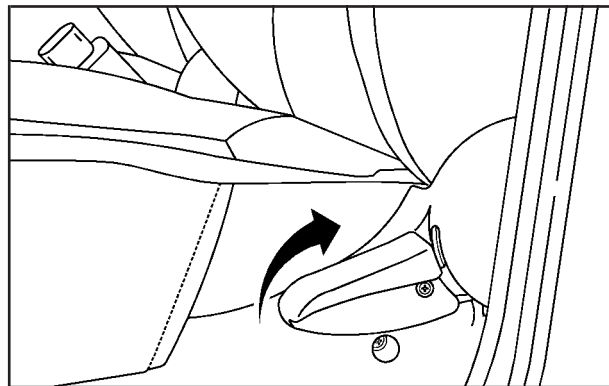

To adjust the seatback, pull up the lever located on the outboard side of the seat and move the seatback to where you want it.

Release the lever and push rearward on the seatback to make sure it is locked.



But do not have a seatback reclined if your vehicle is moving.

⚠ CAUTION:

Sitting in a reclined position when your vehicle is in motion can be dangerous. Even if you buckle up, your safety belts can't do their job when you're reclined like this.

The shoulder belt can't do its job because it won't be against your body. Instead, it will be in front of you. In a crash you could go into it, receiving neck or other injuries.

The lap belt can't do its job either. In a crash the belt could go up over your abdomen. The belt forces would be there, not at your pelvic bones. This could cause serious internal injuries.

For proper protection when the vehicle is in motion, have the seatback upright. Then sit well back in the seat and wear your safety belt properly.

Head Restraints



Adjust your head restraint so that the top of the restraint is closest to the top of your head. This position reduces the chances of a neck injury in a crash.

Pull up the head restraint in order to adjust the position upward.

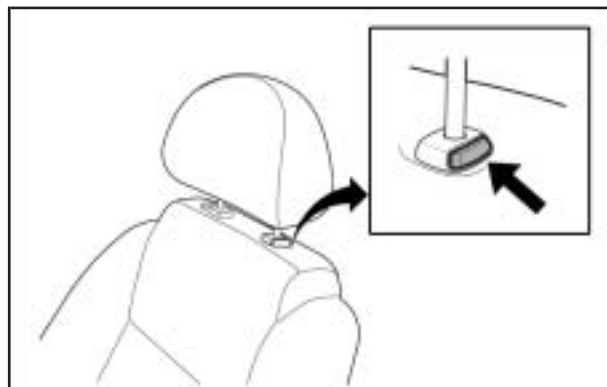

Push in the release button and press down on the head restraint in order to adjust the position downward.

To remove the head restraint, pull the head restraint all the way up. Then push in the release button and lift the head restraint from the guide sleeve.

Replace the head restraint and reset it in the original position before driving.

Your vehicle may have adjustable rear seat head restraints. Push in the release button and move the head restraint to the desired position.

Rear Seats

Rear Seat Operation (Hatchback)

Folding the Seatback

The rear seatbacks can be folded down to increase cargo space.

To fold down the seatback, do the following:

1. If your vehicle has adjustable head restraints, push the head restraints down all the way.

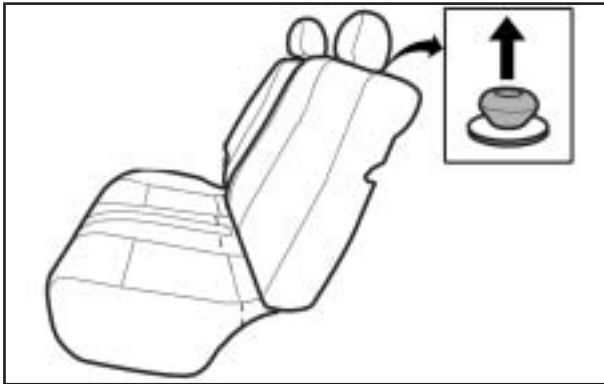

2. Pull up the release knob located on top of the rear seatback.

3. Fold the rear seatback forward and down.
4. Move the safety belts and safety belt buckles out of the space between the seatback and the seatback cushion.

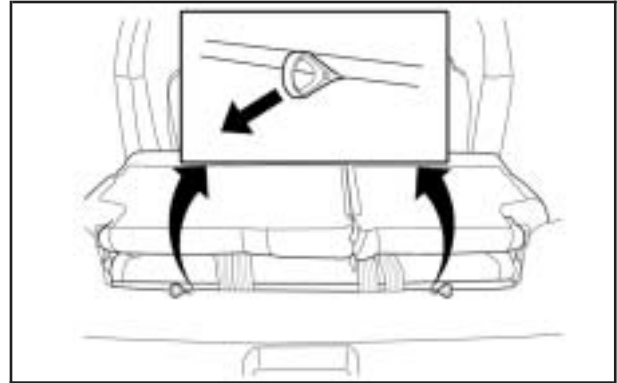

5. Pull the release handles on the rear side of the seat cushion to unlock the rear seat cushion.
6. Lift and fold up the seat.

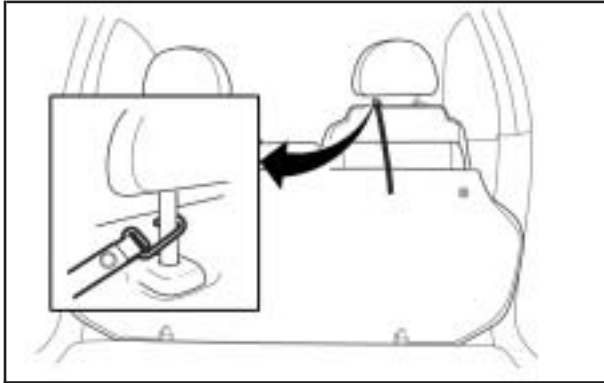

7. Clip the hook to the head restraint of the front seat to keep the rear seat secure.
8. Store the rear safety belts and buckles in the storage area under the floor mat.

⚠ CAUTION:

If the seatback isn't locked, it could move forward in a sudden stop or crash. That could cause injury to the person sitting there. Always press rearward on the seatback to be sure it is locked.

⚠ CAUTION:

A safety belt that is improperly routed, not properly attached, or twisted won't provide the protection needed in a crash. The person wearing the belt could be seriously injured. After raising the rear seatback, always check to be sure that the safety belts are properly routed and attached, and are not twisted.

To return the seatback to the upright position, do the following:

1. Remove the safety belts and buckles from the storage area.
2. Unclip the hook from the head restraint of the front seat.
3. Push the rear seat cushion downward to its original position until it latches securely.
4. Lift up the seatback and push it to its original position. Ensure that the safety belts are not twisted or caught under the seatback.
5. Push down firmly on the top of the seatback until it latches securely in the fully upright position.
6. Place the rear safety belts and buckles in their original position between the rear seatback and the seat cushion.

Rear Seat Operation (Sedan)

Folding the Seatback

The rear seatbacks can be folded down to increase cargo space.

To fold down the seatback, do the following:

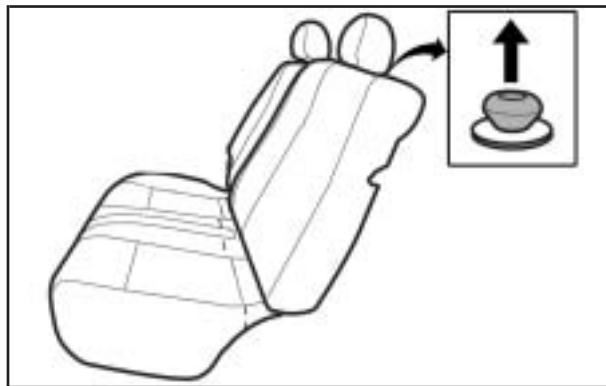

1. Pull up the release knob located on top of the rear seatback.
2. Fold the rear seatback forward and down.

 **CAUTION:**

If the seatback isn't locked, it could move forward in a sudden stop or crash. That could cause injury to the person sitting there. Always press rearward on the seatback to be sure it is locked.

 **CAUTION:**

A safety belt that is improperly routed, not properly attached, or twisted won't provide the protection needed in a crash. The person wearing the belt could be seriously injured. After raising the rear seatback, always check to be sure that the safety belts are properly routed and attached, and are not twisted.

To return the seatback to the upright position, do the following:

1. Lift up the seatback and push it to its original position. Ensure that the safety belts are not twisted or caught under the seatback.
2. Push down firmly on the top of the seatback until it latches securely in the fully upright position.

Safety Belts

Safety Belts: They Are for Everyone

This part of the manual tells you how to use safety belts properly. It also tells you some things you should not do with safety belts.

CAUTION:

Don't let anyone ride where he or she can't wear a safety belt properly. If you are in a crash and you're not wearing a safety belt, your injuries can be much worse. You can hit things inside the vehicle or be ejected from it. You can be seriously injured or killed. In the same crash, you might not be, if you are buckled up. Always fasten your safety belt, and check that your passengers' belts are fastened properly too.

CAUTION:

It is extremely dangerous to ride in a cargo area, inside or outside of a vehicle. In a collision, people riding in these areas are more likely to be seriously injured or killed. Do not allow people to ride in any area of your vehicle that is not equipped with seats and safety belts. Be sure everyone in your vehicle is in a seat and using a safety belt properly.



Your vehicle has a light that comes on as a reminder to buckle up. See *Safety Belt Reminder Light* on page 3-25.

In most states and in all Canadian provinces, the law says to wear safety belts. Here's why: *They work.*

You never know if you'll be in a crash. If you do have a crash, you don't know if it will be a bad one.

A few crashes are mild, and some crashes can be so serious that even buckled up, a person wouldn't survive. But most crashes are in between. In many of them, people who buckle up can survive and sometimes walk away. Without belts they could have been badly hurt or killed.

After more than 30 years of safety belts in vehicles, the facts are clear. In most crashes buckling up does matter... a lot!

Why Safety Belts Work

When you ride in or on anything, you go as fast as it goes.

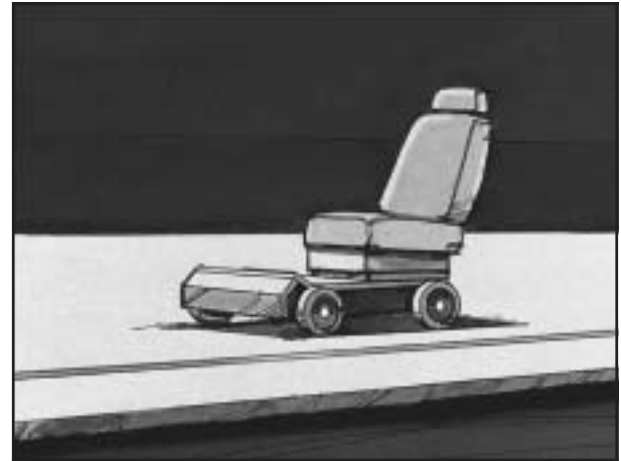

Take the simplest vehicle. Suppose it's just a seat on wheels.

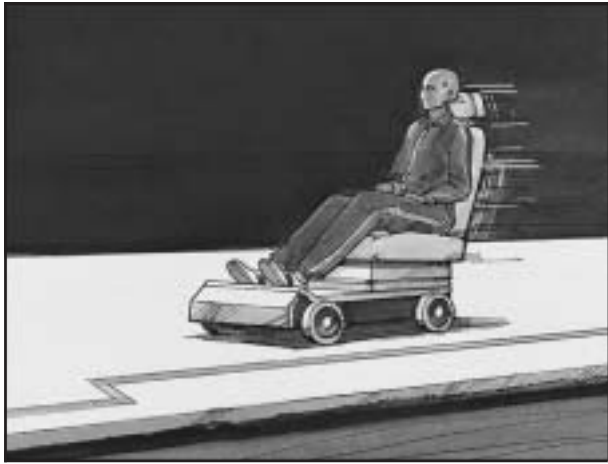

Put someone on it.

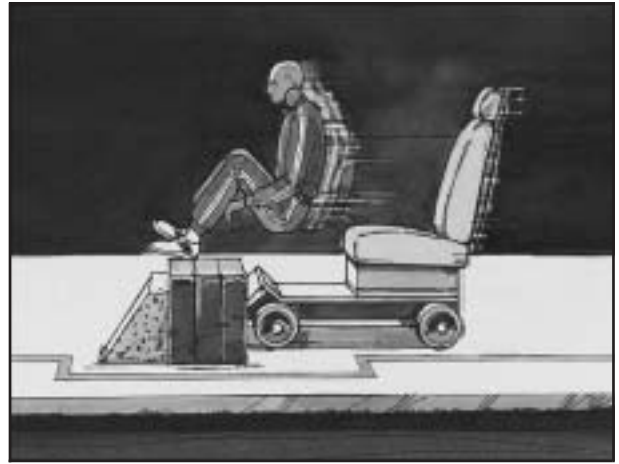

Get it up to speed. Then stop the vehicle. The rider doesn't stop.



The person keeps going until stopped by something.
In a real vehicle, it could be the windshield...

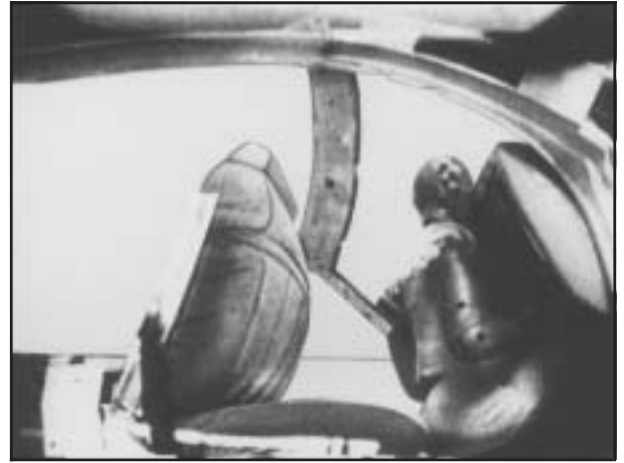

or the instrument panel...



or the safety belts!

With safety belts, you slow down as the vehicle does. You get more time to stop. You stop over more distance, and your strongest bones take the forces. That's why safety belts make such good sense.

Questions and Answers About Safety Belts

Q: Won't I be trapped in the vehicle after an accident if I'm wearing a safety belt?

A: You *could* be – whether you're wearing a safety belt or not. But you can unbuckle a safety belt, even if you're upside down. And your chance of being conscious during and after an accident, so you *can* unbuckle and get out, is *much* greater if you are belted.

Q: If my vehicle has air bags, why should I have to wear safety belts?

A: Air bags are in many vehicles today and will be in most of them in the future. But they are supplemental systems only; so they work *with* safety belts – not instead of them. Every air bag system ever offered for sale has required the use of safety belts. Even if you're in a vehicle that has air bags, you still have to buckle up to get the most protection. That's true not only in frontal collisions, but especially in side and other collisions.

Q: If I'm a good driver, and I never drive far from home, why should I wear safety belts?

A: You may be an excellent driver, but if you're in an accident – even one that isn't your fault – you and your passengers can be hurt. Being a good driver doesn't protect you from things beyond your control, such as bad drivers.

Most accidents occur within 25 miles (40 km) of home. And the greatest number of serious injuries and deaths occur at speeds of less than 40 mph (65 km/h).

Safety belts are for everyone.

How to Wear Safety Belts Properly

This part is only for people of adult size.

Be aware that there are special things to know about safety belts and children. And there are different rules for smaller children and babies. If a child will be riding in your vehicle, see *Older Children on page 1-28* or *Infants and Young Children on page 1-30*. Follow those rules for everyone's protection.

First, you'll want to know which restraint systems your vehicle has.

We'll start with the driver position.

Driver Position

This part describes the driver's restraint system.

Lap-Shoulder Belt

The driver has a lap-shoulder belt. Here is how to wear it properly.

1. Close and lock the door.
2. Adjust the seat so you can sit up straight. To see how, see "Seats" in the Index.



3. Pick up the latch plate and pull the belt across you. Do not let it get twisted.

The shoulder belt may lock if you pull the belt across you very quickly. If this happens, let the belt go back slightly to unlock it. Then pull the belt across you more slowly.

4. Push the latch plate into the buckle until it clicks. Pull up on the latch plate to make sure it is secure. Make sure the release button on the buckle is positioned so you would be able to unbuckle the safety belt quickly if you ever had to.



5. To make the lap part tight, pull down on the buckle end of the belt as you pull up on the shoulder belt.

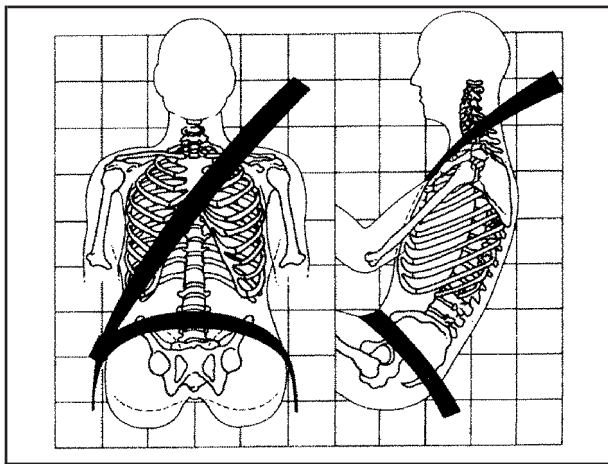

The lap part of the belt should be worn low and snug on the hips, just touching the thighs. In a crash, this applies force to the strong pelvic bones. And you would be less likely to slide under the lap belt. If you slid under it, the belt would apply force at your abdomen. This could cause serious or even fatal injuries. The shoulder belt should go over the shoulder and across the chest. These parts of the body are best able to take belt restraining forces.

The safety belt locks if there is a sudden stop or crash, or if you pull the belt very quickly out of the retractor.

Shoulder Belt Height Adjuster

Before you begin to drive, move the shoulder belt height adjuster to the height that is right for you. Adjust the height so that the shoulder portion of the belt is centered on your shoulder. The belt should be away from your face and neck, but not falling off your shoulder.

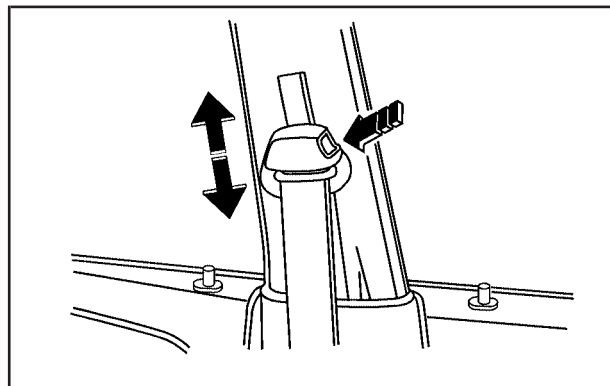

To move the shoulder belt height adjuster down, squeeze the release button and move the height adjuster to the desired position. You can move the height adjuster up just by pushing up on the shoulder belt guide. After you move the adjuster to where you want it, try to move it down without squeezing the release button to make sure it has locked into position.

Q: What's wrong with this?

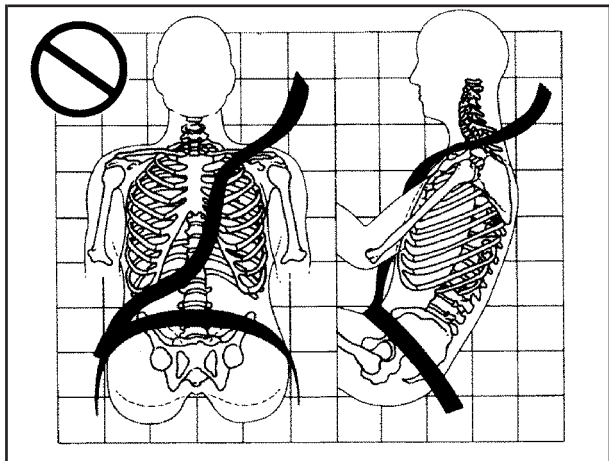

A: The shoulder belt is too loose. It will not give nearly as much protection this way.

⚠ CAUTION:

You can be seriously hurt if your shoulder belt is too loose. In a crash, you would move forward too much, which could increase injury. The shoulder belt should fit against your body.

Q: What's wrong with this?

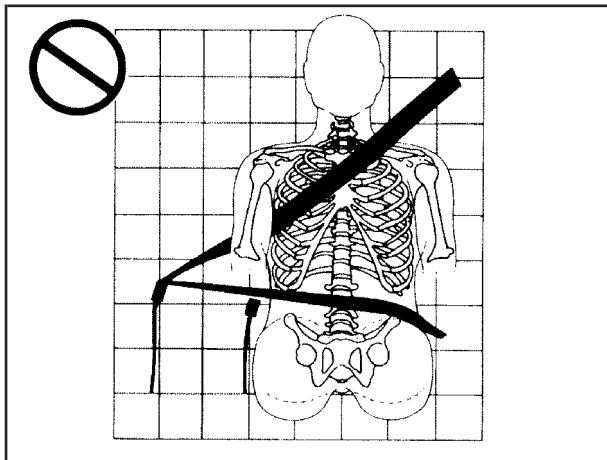

A: The belt is buckled in the wrong place.

⚠ CAUTION:

You can be seriously injured if your belt is buckled in the wrong place like this. In a crash, the belt would go up over your abdomen. The belt forces would be there, not at the pelvic bones. This could cause serious internal injuries. Always buckle your belt into the buckle nearest you.

Q: What's wrong with this?

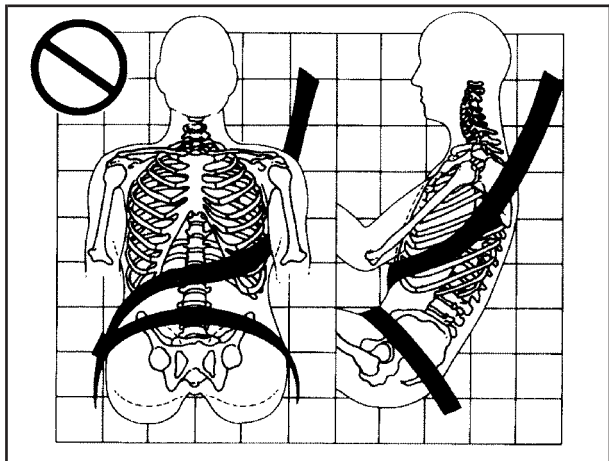

A: The shoulder belt is worn under the arm. It should be worn over the shoulder at all times.

⚠ CAUTION:

You can be seriously injured if you wear the shoulder belt under your arm. In a crash, your body would move too far forward, which would increase the chance of head and neck injury. Also, the belt would apply too much force to the ribs, which aren't as strong as shoulder bones. You could also severely injure internal organs like your liver or spleen.

Q: What's wrong with this?

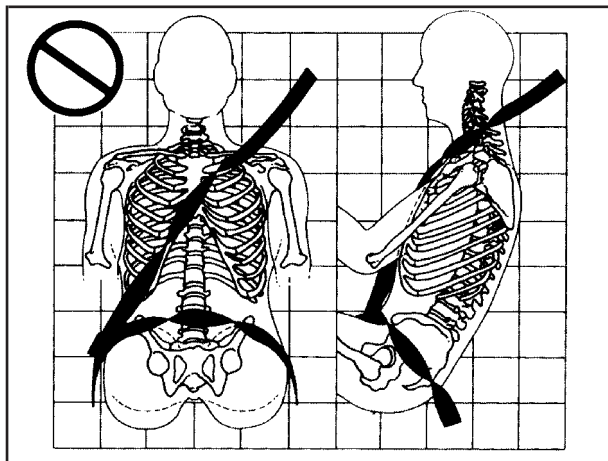

A: The belt is twisted across the body.

⚠ CAUTION:

You can be seriously injured by a twisted belt. In a crash, you wouldn't have the full width of the belt to spread impact forces. If a belt is twisted, make it straight so it can work properly, or ask your dealer to fix it.



To unlatch the belt, just push the button on the buckle. The belt should go back out of the way.

Before you close the door, be sure the belt is out of the way. If you slam the door on it, you can damage both the belt and your vehicle.

Safety Belt Use During Pregnancy

Safety belts work for everyone, including pregnant women. Like all occupants, they are more likely to be seriously injured if they don't wear safety belts.

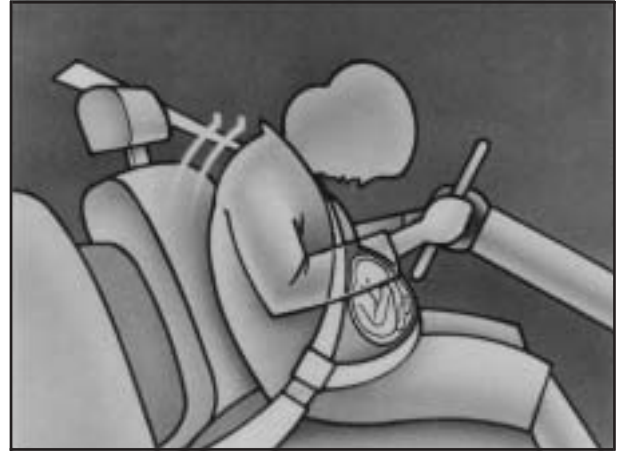

A pregnant woman should wear a lap-shoulder belt, and the lap portion should be worn as low as possible, below the rounding, throughout the pregnancy.

The best way to protect the fetus is to protect the mother. When a safety belt is worn properly, it's more likely that the fetus won't be hurt in a crash. For pregnant women, as for anyone, the key to making safety belts effective is wearing them properly.

Right Front Passenger Position

To learn how to wear the right front passenger's safety belt properly see, *Driver Position on page 1-15*.

The right front passenger's safety belt works the same way as the driver's safety belt.

Rear Seat Passengers

It is very important for rear seat passengers to buckle up! Accident statistics show that unbelted people in the rear seat are hurt more often in crashes than those who are wearing safety belts.

Rear passengers who are not safety belted can be thrown out of the vehicle in a crash. And they can strike others in the vehicle who are wearing safety belts.

Rear Seat Outside Positions

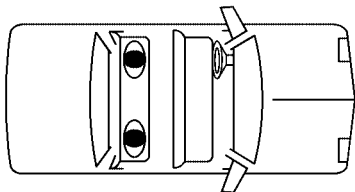

Lap-Shoulder Belt

All rear seating positions have lap-shoulder belts. Here is how to wear a lap-shoulder belt properly.



1. Pick up the latch plate and pull the belt across you. Do not let it get twisted.

The shoulder belt may lock if you pull the belt across you very quickly. If this happens, let the belt go back slightly to unlock it. Then pull the belt across you more slowly.

2. Push the latch plate into the buckle until it clicks. Be sure you are using the correct buckle and that the latch plate clicks when inserted into the buckle.



If the belt stops before it reaches the buckle, tilt the latch plate and keep pulling until you can buckle it. Pull up on the latch plate to make sure it is secure. Make sure the release button on the buckle is positioned so you would be able to unbuckle the safety belt quickly if you ever had to.



3. To make the lap part tight, pull down on the buckle end of the belt as you pull up on the shoulder part.

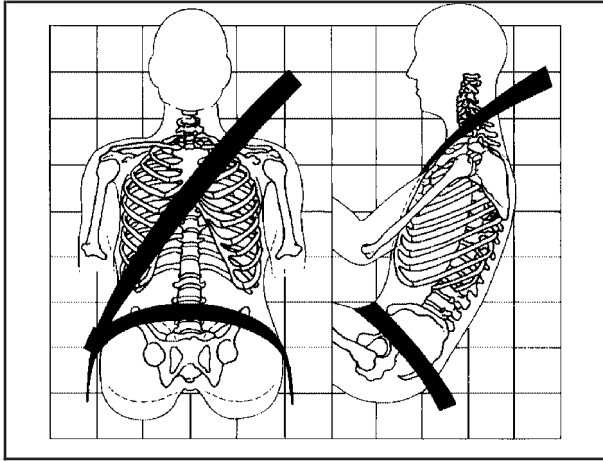

The lap part of the belt should be worn low and snug on the hips, just touching the thighs. In a crash this applies force to the strong pelvic bones. And you would be less likely to slide under the lap belt. If you slid under it, the belt would apply force at your abdomen. This could cause serious or even fatal injuries. The shoulder belt should go over the shoulder and across the chest. These parts of the body are best able to take belt restraining forces.

The safety belt locks if there is a sudden stop or a crash, or if you pull the belt very quickly out of the retractor.

⚠ CAUTION:

You can be seriously hurt if your shoulder belt is too loose. In a crash, you would move forward too much, which could increase injury. The shoulder belt should fit against your body.



To unlatch the belt, just push the button on the buckle.

Center Rear Passenger Position

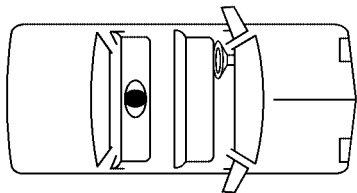

Your vehicle has a removable safety belt in the center rear seating position.

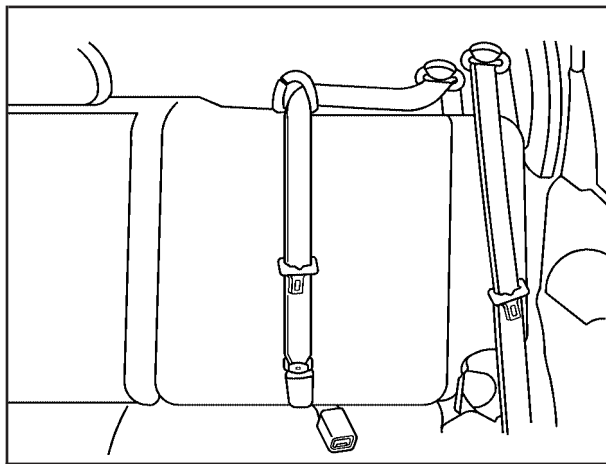

To install the center rear safety belt, use the following instructions.

1. Pull the center rear safety belt from the retractor.
2. Push the latch plate at the end of the safety belt strap into the buckle with the black release button until the mechanism clicks. Make sure the strap is not twisted. The sliding latch plate will face the front of the vehicle.

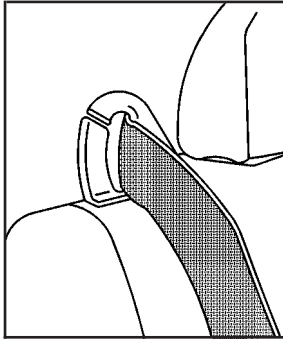

3. Insert the upper part of the safety belt into the safety belt guide. Make sure the safety belt is not twisted.

To learn how to use the safety belt once it is installed, see “Lap-Shoulder Belt” under *Rear Seat Passengers* on page 1-23. The installed safety belt works the same way as the safety belt in the rear outside seat positions.

Safety Belt Pretensioners

Your vehicle has safety belt pretensioners for the driver and right front passenger. They help the safety belts reduce a person's forward movement in a moderate to severe crash in which the front of the vehicle hits something.

Pretensioners work only once. If they activate in a crash, you'll need to get new ones, and probably other new parts for your safety belt system. See *Replacing Restraint System Parts After a Crash* on page 1-59.

Child Restraints

Older Children



Older children who have outgrown booster seats should wear the vehicle's safety belts.

Q: What is the proper way to wear safety belts?

A: If possible, an older child should wear a lap-shoulder belt and get the additional restraint a shoulder belt can provide. The shoulder belt should not cross the face or neck. The lap belt should fit snugly below the hips, just touching the top of the thighs. It should never be worn over the abdomen, which could cause severe or even fatal internal injuries in a crash.

Accident statistics show that children are safer if they are restrained in the rear seat.

In a crash, children who are not buckled up can strike other people who are buckled up, or can be thrown out of the vehicle. Older children need to use safety belts properly.



Q: What if a child is wearing a lap-shoulder belt, but the child is so small that the shoulder belt is very close to the child's face or neck?

A: If the child is sitting in a seat next to a window, move the child toward the center of the vehicle. If the child is sitting in the center rear seat passenger position, move the child toward the safety belt buckle. In either case, be sure that the shoulder belt still is on the child's shoulder, so that in a crash the child's upper body would have the restraint that belts provide.

⚠ CAUTION:

Never do this.

Here two children are wearing the same belt. The belt can't properly spread the impact forces. In a crash, the two children can be crushed together and seriously injured. A belt must be used by only one person at a time.



⚠ CAUTION:

Never do this.

Here a child is sitting in a seat that has a lap-shoulder belt, but the shoulder part is behind the child. If the child wears the belt in

CAUTION: (Continued)

CAUTION: (Continued)

this way, in a crash the child might slide under the belt. The belt's force would then be applied right on the child's abdomen. That could cause serious or fatal injuries.

The lap portion of the belt should be worn low and snug on the hips, just touching the child's thighs. This applies belt force to the child's pelvic bones in a crash.

Infants and Young Children

Everyone in a vehicle needs protection! This includes infants and all other children. Neither the distance traveled nor the age and size of the traveler changes the need, for everyone, to use safety restraints. In fact, the law in every state in the United States and in every Canadian province says children up to some age must be restrained while in a vehicle.

Every time infants and young children ride in vehicles, they should have the protection provided by appropriate restraints. Young children should not use the vehicle's adult safety belts alone, unless there is no other choice. Instead, they need to use a child restraint.



⚠ CAUTION:

People should never hold a baby in their arms while riding in a vehicle. A baby doesn't weigh much — until a crash. During a crash a baby will become so heavy it is not possible to hold it.

CAUTION: (Continued)

CAUTION: (Continued)

For example, in a crash at only 25 mph (40 km/h), a 12-lb. (5.5 kg) baby will suddenly become a 240-lb. (110 kg) force on a person's arms. A baby should be secured in an appropriate restraint.



 **CAUTION:**

Children who are up against, or very close to, any air bag when it inflates can be seriously injured or killed. Air bags plus lap-shoulder belts offer outstanding protection for adults and older children, but not for young children and infants. Neither the vehicle's safety belt system nor its air bag system is designed for them. Young children and infants need the protection that a child restraint system can provide.

Q: What are the different types of add-on child restraints?

A: Add-on child restraints, which are purchased by the vehicle's owner, are available in four basic types. Selection of a particular restraint should take into consideration not only the child's weight, height and age but also whether or not the restraint will be compatible with the motor vehicle in which it will be used.

For most basic types of child restraints, there are many different models available. When purchasing a child restraint, be sure it is designed to be used in a motor vehicle. If it is, the restraint will have a label saying that it meets federal motor vehicle safety standards.

The restraint manufacturer's instructions that come with the restraint, state the weight and height limitations for a particular child restraint. In addition, there are many kinds of restraints available for children with special needs.

 **CAUTION:**

Newborn infants need complete support, including support for the head and neck. This is necessary because a newborn infant's neck is weak and its head weighs so much compared with the rest of its body. In a crash, an infant in a rear-facing seat settles into the restraint, so the crash forces can be distributed across the strongest part of an infant's body, the back and shoulders. Infants always should be secured in appropriate infant restraints.

 **CAUTION:**

The body structure of a young child is quite unlike that of an adult or older child, for whom the safety belts are designed. A young child's hip bones are still so small that the vehicle's regular safety belt may not remain low on the hip bones, as it should. Instead, it may settle up around the child's abdomen. In a crash, the belt would apply force on a body area that's unprotected by any bony structure. This alone could cause serious or fatal injuries. Young children always should be secured in appropriate child restraints.

Child Restraint Systems

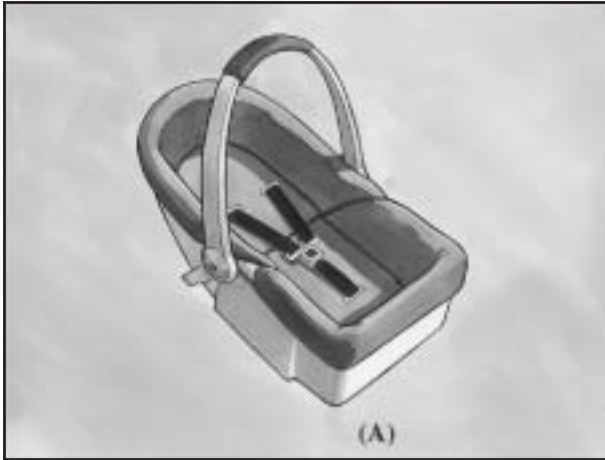

An infant car bed (A), a special bed made for use in a motor vehicle, is an infant restraint system designed to restrain or position a child on a continuous flat surface. Make sure that the infant's head rests toward the center of the vehicle.

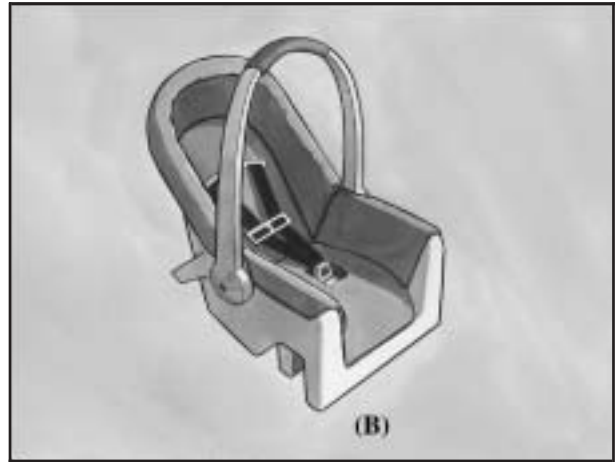

A rear-facing infant seat (B) provides restraint with the seating surface against the back of the infant. The harness system holds the infant in place and, in a crash, acts to keep the infant positioned in the restraint.

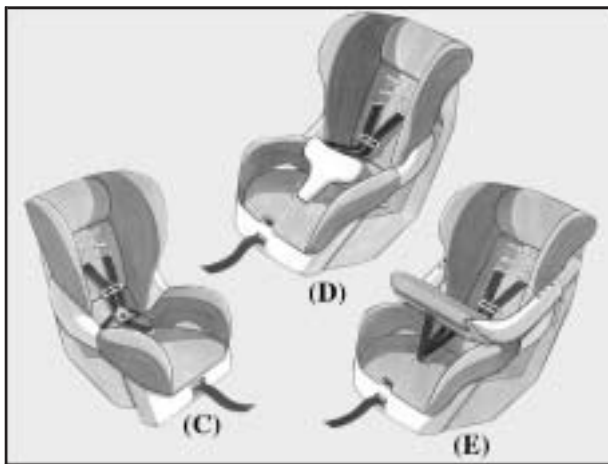

A forward-facing child seat (C-E) provides restraint for the child's body with the harness and also sometimes with surfaces such as T-shaped or shelf-like shields.

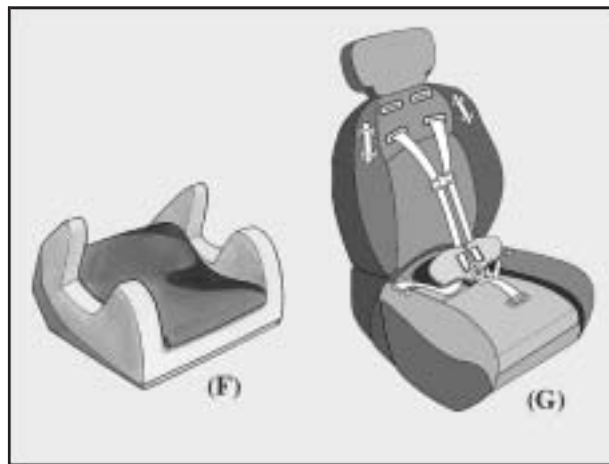

A booster seat (F-G) is a child restraint designed to improve the fit of the vehicle's safety belt system. Some booster seats have a shoulder belt positioner, and some high-back booster seats have a five-point harness. A booster seat can also help a child to see out the window.

Q: How do child restraints work?

A: A child restraint system is any device designed for use in a motor vehicle to restrain, seat, or position children. A built-in child restraint system is a permanent part of the motor vehicle. An add-on child restraint system is a portable one, which is purchased by the vehicle's owner.

For many years, add-on child restraints have used the adult belt system in the vehicle. To help reduce the chance of injury, the child also has to be secured within the restraint. The vehicle's belt system secures the add-on child restraint in the vehicle, and the add-on child restraint's harness system holds the child in place within the restraint.

One system, the three-point harness, has straps that come down over each of the infant's shoulders and buckle together at the crotch. The five-point harness system has two shoulder straps, two hip straps and a crotch strap. A shield may take the place of hip straps. A T-shaped shield has shoulder straps that are attached to a flat pad which rests low against the child's body. A shelf- or armrest-type shield has straps that are attached to a wide, shelf-like shield that swings up or to the side.

When choosing a child restraint, be sure the child restraint is designed to be used in a vehicle. If it is, it will have a label saying that it meets federal motor vehicle safety standards.

Then follow the instructions for the restraint. You may find these instructions on the restraint itself or in a booklet, or both. These restraints use the belt system or the LATCH system in your vehicle, but the child also has to be secured within the restraint to help reduce the chance of personal injury. When securing an add-on child restraint, refer to the instructions that come with the restraint which may be on the restraint itself or in a booklet, or both, and to this manual. The child restraint instructions are important, so if they are not available, obtain a replacement copy from the manufacturer.

Where to Put the Restraint

Accident statistics show that children are safer if they are restrained in the rear rather than the front seat. We, therefore, recommend that child restraints be secured in a rear seat, including an infant riding in a rear-facing infant seat, a child riding in a forward-facing child seat and an older child riding in a booster seat. *Never* put a rear-facing child restraint in the front passenger seat. Here's why:

CAUTION:

A child in a rear-facing child restraint can be seriously injured or killed if the right front passenger's air bag inflates. This is because the back of the rear-facing child restraint would be very close to the inflating air bag. Always secure a rear-facing child restraint in a rear seat.

CAUTION: (Continued)

CAUTION: (Continued)

If you secure a forward-facing child restraint in the right front seat, always move the front passenger seat as far back as it will go. It is better to secure the child restraint in a rear seat.

Wherever you install it, be sure to secure the child restraint properly.

Keep in mind that an unsecured child restraint can move around in a collision or sudden stop and injure people in the vehicle. Be sure to properly secure any child restraint in your vehicle – even when no child is in it.

Top Strap

Some child restraints have a top strap, or “top tether.” It can help restrain the child restraint during a collision. For it to work, a top strap must be properly anchored to the vehicle. Some top strap-equipped child restraints are designed for use with or without the top strap being anchored. Others require the top strap always to be anchored. Be sure to read and follow the instructions for your child restraint. If yours requires that the top strap be anchored, don’t use the restraint unless it is anchored properly.

If the child restraint does not have a top strap, one can be obtained, in kit form, for many child restraints. Ask the child restraint manufacturer whether or not a kit is available.

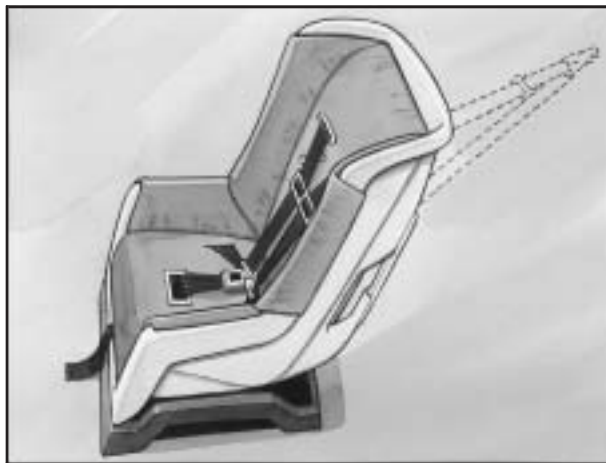

In Canada, the law requires that forward-facing child restraints have a top strap, and that the strap be anchored. In the United States, some child restraints also have a top strap. If your child restraint has a top strap, it should be anchored.

Anchor the top strap to an anchor point specified in *Top Strap Anchor Location on page 1-40*. Be sure to use an anchor point located on the same side of the vehicle as the seating position where the child restraint will be placed.

 **CAUTION:**

Each top tether bracket is designed to anchor only one child restraint. Attaching more than one child restraint to a single bracket could cause the anchor to come loose or even break during a crash. A child or others could be injured if this happens. To help prevent injury to people and damage to your vehicle, attach only one child restraint per bracket.

Once you have the top strap anchored, you'll be ready to secure the child restraint itself. Tighten the top strap when and as the child restraint manufacturer's instructions say.

Top Strap Anchor Location

Top strap anchors are already installed in your vehicle for the rear seating positions.

Do not use a child restraint with a top strap in the right front passenger's position because there is no place to anchor the top strap.

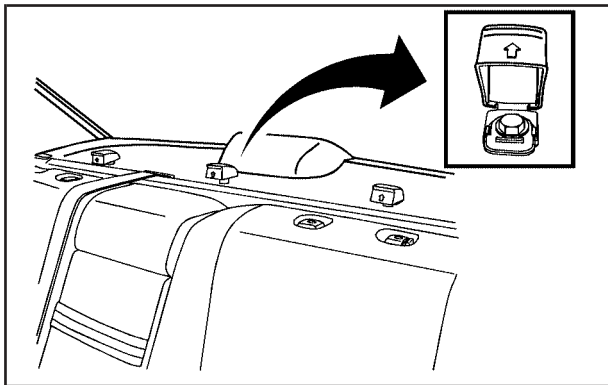

Sedan shown, Hatchback similar

You will find the anchors on your sedan behind the rear seat on the filler panel.

You will find the anchors on your hatchback in the rear cargo area.



Pull the front part of the plastic cover upward to access the top strap anchors.

Lower Anchorages and Top Tethers for Children (LATCH System)

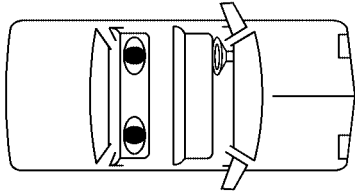

Your vehicle has the LATCH system. You will find anchors (A) for the rear outside seating positions.

This system, designed to make installation of child restraints easier, does not use the vehicle's safety belts. Instead, it uses vehicle anchors (A, B) and child restraint attachments to secure the restraints. Some restraints also use another vehicle anchor to secure a top tether strap (C).

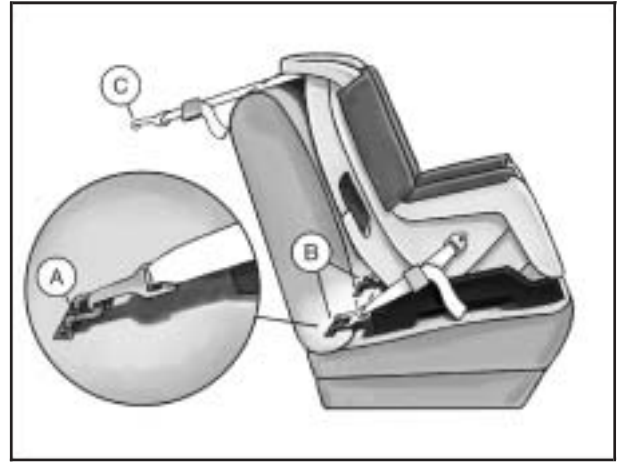

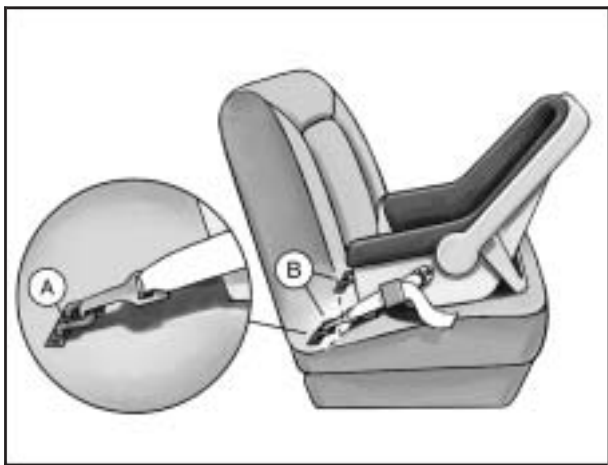

In order to use the LATCH system in your vehicle, you need a child restraint designed for that system.



A

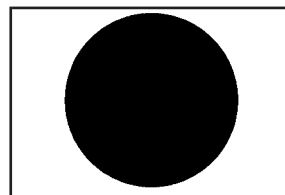

B

To assist you in locating the lower anchors for this child restraint system, each seating position with the LATCH system has either label A or B on the seatback.

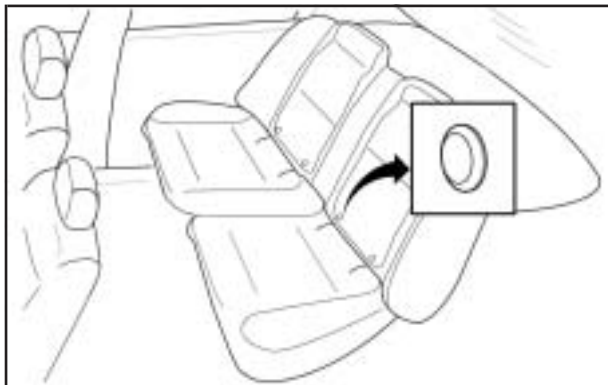

These labels are located at each lower anchor position, near the base of the seat.

Child restraints and booster cushions that can be used with the LATCH system are identified with label A.

Your vehicle may have zippers over the latch areas. If so, unzip the seat cover below the labels to access each latch.

CAUTION:

If a LATCH-type child restraint is not attached to its anchorage points, the restraint will not be able to protect the child correctly. In a crash, the child could be seriously injured or killed. Make sure that a LATCH-type child restraint is properly installed using the anchorage points, or use the vehicle's safety belts to secure the restraint, following the instructions that came with that restraint, and also the instructions in this manual.

Securing a Child Restraint Designed for the LATCH System

1. Find the LATCH anchorages for the seating position you want to use, where the bottom of the seatback meets the back of the seat cushion. See *Lower Anchorages and Top Tethers for Children (LATCH System)* on page 1-41.
2. Put the child restraint on the seat.
3. Attach and tighten the LATCH attachments on the child restraint to the LATCH anchorages in the vehicle. The child restraint instructions will show you how.
4. If the child restraint is forward-facing, attach and tighten the top tether to the top tether anchorage. The child restraint instructions will show you how. Also see *Top Strap* on page 1-38.
5. Push and pull the child restraint in different directions to be sure it is secure.

To remove the child restraint, simply unhook the top tether from the top tether anchorage and then disconnect the LATCH attachments from the LATCH anchorages.

Securing a Child Restraint in a Rear Seat Position

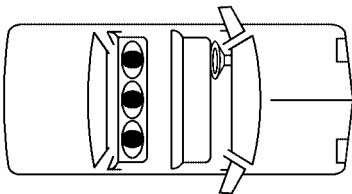

If your child restraint is equipped with the LATCH system, see *Lower Anchorages and Top Tethers for Children (LATCH System)* on page 1-41. See *Top Strap* on page 1-38 if the child restraint has one.

If your child restraint does not have the LATCH system, you will be using the lap-shoulder belt to secure the child restraint. Be sure to follow the instructions that came with the child restraint. Secure the child in the child restraint when and as the instructions say.

1. Put the child restraint on the seat.
2. Pick up the latch plate, and run the lap and shoulder portions of the vehicle's safety belt through or around the restraint. The child restraint instructions will show you how.



3. Buckle the belt. Be sure the latch plate clicks when you put it into the buckle. This means you are using the correct buckle. Also, make sure the release button is positioned so you would be able to unbuckle the safety belt quickly if you ever had to.



4. Pull the rest of the shoulder belt all the way out of the retractor to set the lock.



To remove the child restraint, just unbuckle the vehicle's safety belt and let it go back all the way. The safety belt will move freely again and be ready to work for an adult or larger child passenger.

Securing a Child Restraint in the Right Front Seat Position

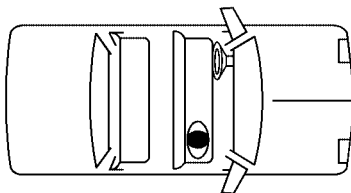

If your child restraint is equipped with the LATCH system, see *Lower Anchorages and Top Tethers for Children (LATCH System)* on page 1-41. See *Top Strap* on page 1-38 if the child restraint has one.

5. To tighten the belt, push down on the child restraint, pull the shoulder portion of the belt to tighten the lap portion of the belt and feed the shoulder belt back into the retractor. If you are using a forward-facing child restraint, you may find it helpful to use your knee to push down on the child restraint as you tighten the belt.
6. Push and pull the child restraint in different directions to be sure it is secure.

Your vehicle has a right front passenger air bag. Never put a rear-facing child restraint in this seat. Here is why:

 **CAUTION:**

A child in a rear-facing child restraint can be seriously injured or killed if the right front passenger's air bag inflates. This is because the back of the rear-facing child restraint would be very close to the inflating air bag. Always secure a rear-facing child restraint in a rear seat.

A rear seat is a safer place to secure a forward-facing child restraint. If you need to secure a forward-facing child restraint in the right front seat, you will be using the lap-shoulder belt to secure the child restraint. Be sure to follow the instructions that came with the child restraint. Secure the child in the child restraint when and as the instructions say.

1. Because your vehicle has a right front passenger air bag, always move the seat as far back as it will go before securing a forward-facing child restraint. See *Manual Seats on page 1-2*.
2. Put the child restraint on the seat.
3. Pick up the latch plate, and run the lap and shoulder portions of the vehicle's safety belt through or around the restraint. The child restraint instructions will show you how.



4. Buckle the belt. Make sure the release button is positioned so you would be able to unbuckle the safety belt quickly if you ever had to.



5. Pull the rest of the shoulder belt all the way out of the retractor to set the lock.



6. To tighten the belt, push down on the child restraint, pull the shoulder portion of the belt to tighten the lap portion of the belt and feed the shoulder belt back into the retractor. You may find it helpful to use your knee to push down on the child restraint as you tighten the belt.
7. Push and pull the child restraint in different directions to be sure it is secure.

To remove the child restraint, just unbuckle the vehicle's safety belt and let it go back all the way. The safety belt will move freely again and be ready to work for an adult or larger child passenger.

Air Bag Systems

This part explains the frontal and side impact air bag systems.

Your vehicle has air bags – a frontal air bag for the driver and another frontal air bag for the right front passenger. Your vehicle may also have a side impact air bag for the driver.



If your vehicle has a side impact air bag for the driver it will say AIR BAG on the air bag covering on the side of the driver's seatback closest to the door.

Frontal air bags are designed to help reduce the risk of injury from the force of an inflating frontal air bag. But these air bags must inflate very quickly to do their job and comply with federal regulations.

Here are the most important things to know about the air bag systems:

CAUTION:

You can be severely injured or killed in a crash if you aren't wearing your safety belt, even if you have air bags. Wearing your safety belt during a crash helps reduce your chance of hitting things inside the vehicle or being ejected from it. Air bags are designed to work with safety belts but don't replace them.

Frontal air bags for the driver and right front passenger are designed to deploy only in moderate to severe frontal and near frontal crashes. They aren't designed to inflate at all in rollover, rear or low-speed frontal crashes, or in many side crashes.

CAUTION: (Continued)

CAUTION: (Continued)

And, for some unrestrained occupants, frontal air bags may provide less protection in frontal crashes than more forceful air bags have provided in the past.

The side impact air bag for the driver is designed to inflate only in moderate to severe crashes where something hits the driver's side of your vehicle. It isn't designed to inflate in frontal, in rollover or in rear crashes.

Everyone in your vehicle should wear a safety belt properly, whether or not there's an air bag for that person.

 **CAUTION:**

Both frontal and side impact air bags inflate with great force, faster than the blink of an eye. If you're too close to an inflating air bag, as you would be if you were leaning forward, it could seriously injure you. Safety belts help keep you in position for air bag inflation before and during a crash. Always wear your safety belt, even with frontal air bags. The driver should sit as far back as possible while still maintaining control of the vehicle, and should not lean on the door.

⚠ CAUTION:

Anyone who is up against, or very close to, any air bag when it inflates can be seriously injured or killed. Air bags plus lap-shoulder belts offer the best protection for adults, but not for young children and infants. Neither the vehicle's safety belt system nor its air bag system is designed for them. Young children and infants need the protection that a child restraint system can provide. Always secure children properly in your vehicle. To read how, see the part of this manual called "Older Children" or "Infants and Young Children."

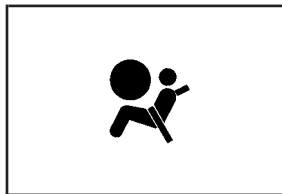

There is an air bag readiness light on the secondary information center, which shows the air bag symbol.

The system checks the air bag electrical system for malfunctions. The light tells you if there is an electrical problem. See *Air Bag Readiness Light* on page 3-26 for more information.

Where Are the Air Bags?



The driver's air bag is in the middle of the steering wheel.



The right front passenger's air bag is in the instrument panel on the passenger's side.



If your vehicle has one, the driver's side impact air bag is in the side of the driver's seatback closest to the door.

⚠ CAUTION:

If something is between an occupant and an air bag, the bag might not inflate properly or it might force the object into that person causing severe injury or even death. The path of an inflating air bag must be kept clear. Don't put anything between an occupant and an air bag, and don't attach or put anything on the steering wheel hub or on or near any other air bag covering. Don't let seat covers block the inflation path of a side impact air bag.

When Should an Air Bag Inflate?

The driver's and right front passenger's frontal air bags are designed to inflate in moderate to severe frontal or near-frontal crashes. But they are designed to inflate only if the impact speed is above the system's designed "threshold level."

If the front of your vehicle goes straight into a wall that doesn't move or deform, the threshold level is about 9 to 14 mph (14.5 to 23 km/h). The threshold level can vary, however, with specific vehicle design, so that it can be somewhat above or below this range.

If your vehicle strikes something that will move or deform, such as a parked car, the threshold level will be higher. The driver's and right front passenger's frontal air bags are not designed to inflate in rollovers, rear impacts, or in many side impacts because inflation would not help the occupant.

Your vehicle may or may not have a side impact air bag. See "Air Bag Systems" in the Index. A driver's side impact air bag is designed to inflate in moderate to severe side crashes involving the driver's door. A side impact air bag will inflate if the crash severity is above the system's designed "threshold level." The threshold level can vary with specific vehicle design. A driver's side impact air bag is not designed to inflate in frontal or near-frontal impacts, rollovers or rear impacts, because inflation would not help the occupant.

In any particular crash, no one can say whether an air bag should have inflated simply because of the damage to a vehicle or because of what the repair costs were. For frontal air bags, inflation is determined by the angle of the impact and how quickly the vehicle slows down in frontal and near-frontal impacts. For side impact air bags, inflation is determined by the location and severity of the impact.

What Makes an Air Bag Inflate?

In an impact of sufficient severity, the air bag sensing system detects that the vehicle is in a crash. For both the frontal and side impact air bags, the sensing system triggers a release of gas from the inflator, which inflates the air bag. The inflator, air bag and related hardware are all part of the air bag modules. Frontal air bag modules are located inside the steering wheel and instrument panel. For vehicles with a driver's side impact air bag, the air bag modules are located in the seatback closest to the driver's door.

How Does an Air Bag Restrain?

In moderate to severe frontal or near frontal collisions, even belted occupants can contact the steering wheel or the instrument panel. In moderate to severe side collisions, even belted occupants can contact the inside of the vehicle. The air bag supplements the protection provided by safety belts. Air bags distribute the force of the impact more evenly over the occupant's upper body, stopping the occupant more gradually. But the frontal air bags would not help you in many types of collisions, including rollovers, rear impacts, and many side impacts, primarily because an occupant's motion is not toward the air bag. A side impact air bag would not help you in many types of collisions, including frontal or near frontal collisions, rollovers, and rear impacts, primarily because an occupant's motion is not toward that air bag. Air bags should never be regarded as anything more than a supplement to safety belts, and then only in moderate to severe frontal or near-frontal collisions for the driver's and right front passenger's frontal air bags, and only in moderate to severe side collisions for vehicles with a driver's side impact air bag.

What Will You See After an Air Bag Inflates?

After the air bag inflates, it quickly deflates, so quickly that some people may not even realize the air bag inflated. Some components of the air bag module will be hot for a short time. These components include the steering wheel hub for the driver's frontal air bag and the instrument panel for the right front passenger's frontal air bag. For vehicles with a side impact air bag, the side of the seatback closest to the driver's door will be hot. The parts of the bag that come into contact with you may be warm, but not too hot to touch. There will be some smoke and dust coming from the vents in the deflated air bags. Air bag inflation doesn't prevent the driver from seeing or being able to steer the vehicle, nor does it stop people from leaving the vehicle.

 **CAUTION:**

When an air bag inflates, there is dust in the air. This dust could cause breathing problems for people with a history of asthma or other breathing trouble. To avoid this, everyone in the vehicle should get out as soon as it is safe to do so. If you have breathing problems but can't get out of the vehicle after an air bag inflates, then get fresh air by opening a window or a door. If you experience breathing problems following an air bag deployment, you should seek medical attention.

In many crashes severe enough to inflate an air bag, windshields are broken by vehicle deformation. Additional windshield breakage may also occur from the right front passenger air bag.

- Air bags are designed to inflate only once. After an air bag inflates, you'll need some new parts for your air bag system. If you don't get them, the air bag system won't be there to help protect you in another crash. A new system will include air bag modules and possibly other parts. The service manual for your vehicle covers the need to replace other parts.
- Your vehicle is equipped with a crash sensing and diagnostic module, which records information about the air bag system. The module records information about the readiness of the system, when the system commands air bag inflation and driver's safety belt usage at deployment.
- Let only qualified technicians work on your air bag system. Improper service can mean that your air bag system won't work properly. See your dealer for service.

Notice: If you damage the covering for the driver's or the right front passenger's air bag, or the air bag covering on the driver's seatback, the bag may not work properly. You may have to replace the air bag module in the steering wheel, both the air bag module and the instrument panel for the right front passenger's air bag, or the air bag module and seatback for the driver's side impact air bag. Do not open or break the air bag coverings.

Servicing Your Air Bag-Equipped Vehicle

Air bags affect how your vehicle should be serviced. There are parts of the air bag systems in several places around your vehicle. Your dealer and the service manual have information about servicing your vehicle and the air bag systems. To purchase a service manual, see *Service Publications Ordering Information on page 7-11*.

CAUTION:

For up to 10 seconds after the ignition key is turned off and the battery is disconnected, an air bag can still inflate during improper service. You can be injured if you are close to an air bag when it inflates. Avoid yellow connectors. They are probably part of the air bag system. Be sure to follow proper service procedures, and make sure the person performing work for you is qualified to do so.

The air bag systems do not need regular maintenance.

Restraint System Check

Checking Your Restraint Systems

Now and then, make sure the safety belt reminder light and all your belts, buckles, latch plates, retractors and anchorages are working properly. Look for any other loose or damaged safety belt system parts. If you see anything that might keep a safety belt system from doing its job, have it repaired.

Torn or frayed safety belts may not protect you in a crash. They can rip apart under impact forces. If a belt is torn or frayed, get a new one right away.

Also look for any opened or broken air bag covers, and have them repaired or replaced. (The air bag system does not need regular maintenance.)

Replacing Restraint System Parts After a Crash

CAUTION:

A crash can damage the restraint systems in your vehicle. A damaged restraint system may not properly protect the person using it, resulting in serious injury or even death in a crash. To help make sure your restraint systems are working properly after a crash, have them inspected and any necessary replacements made as soon as possible.

If you've had a crash, do you need new or LATCH system parts?

After a very minor collision, nothing may be necessary. But if the belts were stretched, as they would be if worn during a more severe crash, then you need new parts.

If the LATCH system was being used during a more severe crash, you may need new LATCH system parts.

If belts are cut or damaged, replace them. Collision damage also may mean you will need to have LATCH system, safety belt or seat parts repaired or replaced. New parts and repairs may be necessary even if the belt or LATCH system wasn't being used at the time of the collision.

If the frontal air bags inflate, you will also need to replace the driver's and right front passenger's safety belt pretensioners and safety belt. Be sure to do so. Then the new pretensioner and safety belt will be there to help protect you in a collision.

After a crash you may need to replace the driver and right front passenger's safety belt retractor assemblies, even if the frontal air bags have not deployed. The driver and right front passenger's safety belt retractor assemblies contain the safety belt pretensioners. Have your safety belt pretensioners checked if your vehicle has been in a collision, or if your air bag readiness light stays on after you start your vehicle or while you are driving. See.

If your vehicle is equipped with side air bags, the driver's seat assembly must be replaced after the side air bag has been deployed.

If an air bag inflates, you'll need to replace air bag system parts. See *Air Bag Systems on page 1-50*.

 **NOTES**

Section 2 Features and Controls

Keys	2-2	Engine Coolant Heater (Canada Only)	2-21
Remote Keyless Entry System	2-4	Automatic Transaxle Operation	2-22
Remote Keyless Entry System Operation	2-5	Manual Transaxle Operation	2-26
Doors and Locks	2-7	Parking Brake	2-28
Door Locks	2-7	Shifting Into Park (P) (Automatic Transaxle)	2-29
Central Door Unlocking System	2-8	Shifting Out of Park (P) (Automatic Transaxle)	2-30
Door Ajar Reminder	2-8	Parking Your Vehicle (Manual Transaxle)	2-31
Rear Door Security Locks	2-9	Parking Over Things That Burn	2-32
Lockout Protection	2-10	Engine Exhaust	2-32
Leaving Your Vehicle	2-10	Running Your Engine While You Are Parked	2-33
Trunk (Sedan)	2-10	Mirrors	2-34
Liftgate (Hatchback)	2-12	Manual Rearview Mirror	2-34
Windows	2-13	Outside Manual Mirrors	2-34
Manual Windows	2-14	Outside Power Mirror	2-35
Power Windows	2-14	Outside Convex Mirror	2-35
Sun Visors	2-14	Outside Heated Mirrors	2-35
Theft-Deterrent Systems	2-15	Storage Areas	2-36
Theft-Deterrent System	2-15	Glove Box	2-36
Immobilizer	2-17	Cupholder(s)	2-36
Immobilizer Operation	2-17	Sunglasses Storage Compartment	2-37
Starting and Operating Your Vehicle	2-18	Sunroof	2-37
New Vehicle Break-In	2-18		
Ignition Positions	2-19		
Starting Your Engine	2-20		

Keys

CAUTION:

Leaving children in a vehicle with the ignition key is dangerous for many reasons. They could operate the power windows or other controls or even make the vehicle move. The children or others could be badly injured or even killed. Do not leave the keys in a vehicle with children.



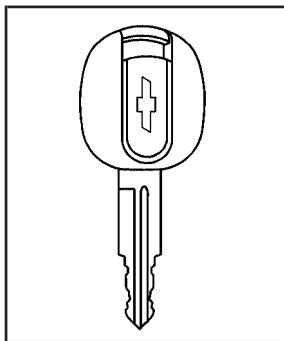

One key is used for the ignition, the door and all other locks.

When a new vehicle is delivered, the dealer removes the key tag and gives it to the first owner. The tag has a code on it that tells your dealer how to make extra keys. For vehicle security, keep the key tag in a safe place and also record the key number somewhere other than inside of the vehicle. If you lose your key, you will be able to have a new one made easily using the tag.

Your vehicle may have an electronic immobilizer designed to protect your car against theft. If so, only keys with the correct electronic code can be used to start the vehicle. Even if a key has the same profile, it will not start the engine if the electronic code is incorrect. If you need a new key, contact your dealer who can obtain the correct key code. See *Roadside Assistance Program* on page 7-6 for more information.

Notice: If you ever lock your keys in your vehicle, you may have to damage the vehicle to get in. Be sure you have spare keys.

Remote Keyless Entry System

If equipped, the keyless entry system operates on a radio frequency subject to Federal Communications Commission (FCC) Rules and with Industry Canada.

This device complies with Part 15 of the FCC Rules. Operation is subject to the following two conditions:

1. This device may not cause interference, and
2. This device must accept any interference received, including interference that may cause undesired operation of the device.

This device complies with RSS-210 of Industry Canada. Operation is subject to the following two conditions:

1. This device may not cause interference, and
2. This device must accept any interference received, including interference that may cause undesired operation of the device.

Changes or modifications to this system by other than an authorized service facility could void authorization to use this equipment.

At times you may notice a decrease in range. This is normal for any remote keyless entry system. If the transmitter does not work or if you have to stand closer to your vehicle for the transmitter to work, try this:

- Check the distance. You may be too far from your vehicle. You may need to stand closer during rainy or snowy weather.
- Check the location. Other vehicles or objects may be blocking the signal. Take a few steps to the left or right, hold the transmitter higher, and try again.
- Check to determine if battery replacement is necessary. See “Battery Replacement” under *Remote Keyless Entry System Operation on page 2-5*.
- If you are still having trouble, see your dealer or a qualified technician for service.

Remote Keyless Entry System Operation

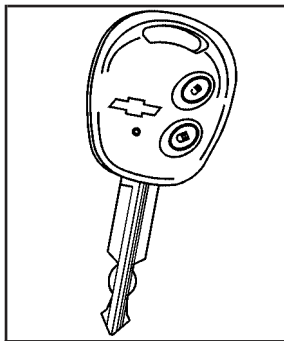

The following functions are available if your vehicle has the remote keyless entry system:

🔒 (Lock): Press this button to lock all of the doors. If all of the doors and the trunk or liftgate are closed, the hazard lamps will flash once and the horn will chirp to indicate that locking has occurred and that the theft-deterrent system is active.

🔓 (Unlock): Press this button to unlock all of the doors. The hazard lamps will flash twice to indicate that unlocking has occurred and that the theft-deterrent system is deactivated.

You can lock and unlock your doors from about 20 ft (6 m) away using the remote keyless entry transmitter.

The LED on the transmitter will flash when the buttons on the transmitter are pressed.

The lock and unlock buttons will not operate and the theft-deterrent system will not activate while the key is in the ignition.

Matching Transmitter(s) to Your Vehicle

Each remote keyless entry transmitter is coded to prevent another transmitter from unlocking your vehicle. If a transmitter is lost or stolen, a replacement can be purchased through your dealer. Remember to bring any remaining transmitters with you when you go to your dealer. When the dealer matches the replacement transmitter to your vehicle, any remaining transmitters must also be matched. Once your dealer has coded the new transmitter, the lost transmitter will not unlock your vehicle. Each vehicle can have a maximum of five transmitters matched to it.

Battery Replacement

Under normal use, the battery in your remote keyless entry transmitter should last about two years.

You can tell the battery is weak if the LED fails to illuminate or if the transmitter will not work at the normal range in any location. If you have to get close to your vehicle before the transmitter works, it is probably time to change the battery.

Notice: When replacing the battery, use care not to touch any of the circuitry. Static from your body transferred to these surfaces may damage the transmitter.

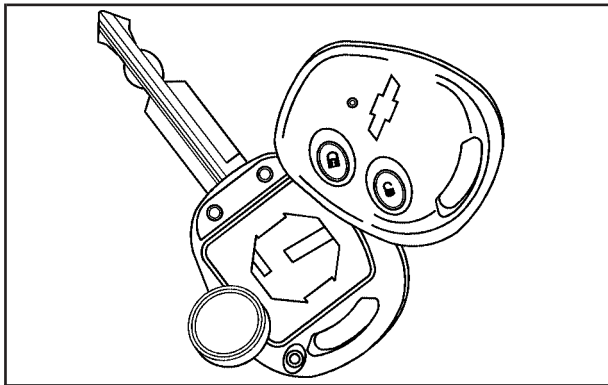

To replace the battery in the remote keyless entry transmitter, do the following:

1. Remove the screw from the back of the cover and open the cover of the transmitter.
2. Pull the transmitter out of the cover and carefully detach the sticker from the unit. Keep the sticker clean.
3. Remove the battery and replace it with the new one. Make sure the positive side of the battery faces up. Use one three-volt, CR1620, or equivalent, type battery.
4. Attach the sticker and put the transmitter unit in the cover.
5. Put the two halves back together and replace the screw. Make sure the cover is on tightly, so water will not get in.
6. Test the transmitter operation.

Doors and Locks

Door Locks

CAUTION:

Unlocked doors can be dangerous.

- Passengers — especially children — can easily open the doors and fall out of a moving vehicle. When a door is locked, the handle will not open it. You increase the chance of being thrown out of the vehicle in a crash if the doors are not locked. So, wear safety belts properly and lock the doors whenever you drive.

CAUTION: (Continued)

CAUTION: (Continued)

- Young children who get into unlocked vehicles may be unable to get out. A child can be overcome by extreme heat and can suffer permanent injuries or even death from heat stroke. Always lock your vehicle whenever you leave it.
- Outsiders can easily enter through an unlocked door when you slow down or stop your vehicle. Locking your doors can help prevent this from happening.

There are several ways to lock and unlock your vehicle.

From the outside, use your key or the optional remote keyless entry transmitter. See *Remote Keyless Entry System Operation* on page 2-5.

To manually unlock the doors from the outside, insert the key and turn it toward the front of the vehicle.

To manually lock the doors from the outside, insert the key and turn it toward the rear of the vehicle.

All doors, except for the driver's door, can be locked from the outside by pushing down the manual door lock and then closing the door. The driver's door lock can not be pushed in while the door is open. Upon leaving the vehicle, the driver's door can only be locked from the outside by using the key or the optional remote keyless entry transmitter.

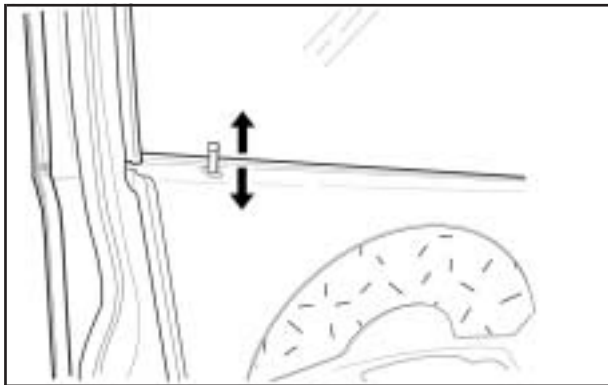

From the inside, you can lock and unlock all of the doors by pushing or pulling the manual door lock located on the window sill on each door.

Central Door Unlocking System

The central door unlocking system is activated from the driver's door.

From the outside, you can lock or unlock all of the doors on your vehicle from the driver's door by using either the key or the optional remote keyless entry transmitter. From the inside, you can lock or unlock all of the doors by using the driver's door lock.

Door Ajar Reminder



If one of the doors on your vehicle is not closed properly while the ignition is on, the door ajar light on the secondary information center will come on and stay on until the doors are closed.

Rear Door Security Locks

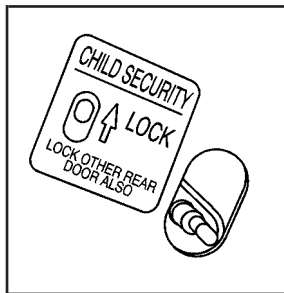

Your vehicle has rear door security locks on each rear door that help prevent passengers from opening the rear doors on your vehicle from the inside.

Using the Rear Door Security Lock

1. Move the lock upward to the lock position.
2. Close the door.
3. Do the same thing to the other rear door lock.

Notice: Pulling the inside door handle while the rear door security locks are engaged could damage your vehicle. Do not pull the inside door handle while the rear door security locks are engaged.

The rear doors on your vehicle cannot be opened from the inside while this feature is in use.

Opening a Rear Door When the Security Lock is On

1. Unlock the door from the inside.
2. Then open the door from the outside.

If you do not cancel the security lock feature, adults or older children who ride in the rear will not be able to open the rear door from the inside. You should let adults and older children know how to cancel the locks.

Canceling the Rear Door Security Lock

1. Unlock the door from the inside and open the door from the outside.
2. Move the lock downward to the unlock position.
3. Do the same for the other rear door.

The rear door locks will now work normally.

Lockout Protection

If your vehicle has remote keyless entry, you have lockout protection. This feature stops the driver's door lock from locking when the driver's door is open.

Leaving Your Vehicle

If you are leaving your vehicle, take your keys. All of the doors, except for the driver's door, can be locked from the outside by pushing down the door lock and then closing the door. The driver's door can only be locked from the outside by using the key or the optional remote keyless entry transmitter.

Trunk (Sedan)

CAUTION:

It can be dangerous to drive with the trunk lid open because carbon monoxide (CO) gas can come into your vehicle. You can not see or smell CO. It can cause unconsciousness and even death. If you must drive with the trunk lid open or if electrical wiring or other cable connections must pass through the seal between the body and the trunk lid:

- Make sure all other windows are shut.
- Turn the fan on your heating or cooling system to its highest speed and select the control setting that will force outside air into your vehicle. See Climate Control System in the Index.
- If you have air outlets on or under the instrument panel, open them all the way.

See *Engine Exhaust on page 2-32*.

To open the trunk on your sedan from outside of your vehicle, insert the key into the lock cylinder and turn the key clockwise.

Remote Trunk Release



Open the trunk on your sedan from inside your vehicle by pulling up the release lever located to the left side of the driver's seat.

When closing the trunk, close from the center to ensure it fully latches. Although you may use one hand to unlock the trunk, it is recommended that two hands on the upper surface be used to close the trunk.

Emergency Trunk Release Handle

Notice: Using the emergency trunk release handle as a tie-down or anchor point when securing items in the trunk may damage it. Use the emergency trunk release handle only to help you open the trunk lid.

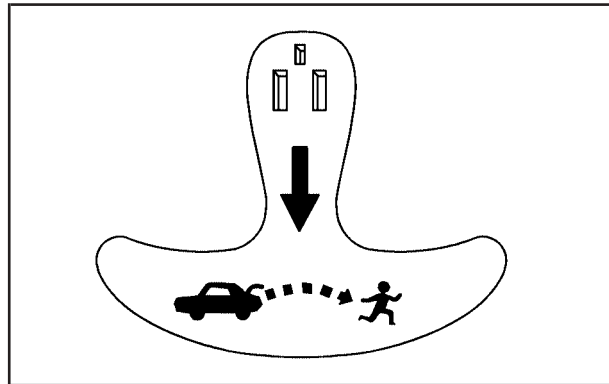

There is a glow-in-the-dark emergency trunk release handle located on the underside of the trunk. This handle will glow following exposure to light. Pull the release handle down to open the trunk from the inside.

Liftgate (Hatchback)

CAUTION:

It can be dangerous to drive with the liftgate open because carbon monoxide (CO) gas can come into your vehicle. You can't see or smell CO. It can cause unconsciousness and even death. If you must drive with the liftgate open or if electrical wiring or other cable connections must pass through the seal between the body and the liftgate:

- Make sure all other windows are shut.
- Turn the fan on your heating or cooling system to its highest speed and select the control setting that will force outside air into your vehicle. See *Climate Control System on page 3-12*.
- If you have air outlets on or under the instrument panel, open them all the way. See *Engine Exhaust on page 2-32*.

To open the liftgate on your hatchback from outside of the vehicle, insert the key into the lock cylinder and turn it counterclockwise. Then pull up the handle above the license plate to open the liftgate.

When closing the liftgate, close from the center to ensure it fully latches. Although you may use one hand to unlock the liftgate, it is recommended that two hands on the upper surface be used to close the liftgate.

To lock the liftgate, insert the key into the lock cylinder and turn it clockwise.

The liftgate can also be locked or unlocked by the central door unlocking system. See *Central Door Unlocking System on page 2-8*.

Windows

CAUTION:

Leaving children, helpless adults, or pets in a vehicle with the windows closed is dangerous. They can be overcome by the extreme heat and suffer permanent injuries or even death from heat stroke. Never leave a child, a helpless adult, or a pet alone in a vehicle, especially with the windows closed in warm or hot weather.



Manual Windows

On a vehicle with manual windows, use the window crank to open and close each window.

The rear windows do not open fully.

Power Windows

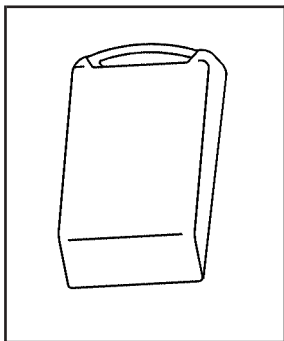

If your vehicle has power windows, the switches are located on the armrest on the driver's door. In addition, each passenger door has a switch for its own window.

The ignition must be turned to ON to use the power windows. To lower the window, press and hold the switch. To raise the window, lift up on the switch. Release the switch when the window reaches the desired position.

Window Lockout

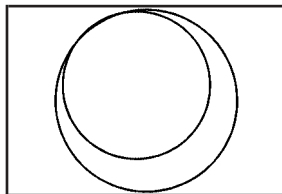

The driver's power window controls also include a lockout button.

Press the lockout button to stop the front and rear passengers from using their window switches. The driver can still operate all the windows with the lock on. Press the lockout button again to return to normal window operation.

Sun Visors

To block out glare you can swing down the visors. You can also remove them from the center mount and swing them to the side.

Visor Vanity Mirror

Your vehicle has vanity mirrors located on the back of the sun visors. Swing down the sun visor to expose the vanity mirror.

Theft-Deterrent Systems

Vehicle theft is big business, especially in some cities. Although your vehicle has a number of theft-deterrent features, we know that nothing we put on it can make it impossible to steal.

Theft-Deterrent System

Your vehicle may have a theft-deterrent system.

The theft-deterrent system will not arm when you lock the doors using the key or the manual door lock. It arms only when you use the remote keyless entry transmitter.

Arming the System

To arm the system, do the following:

1. Close the doors, the windows, the hood, and the trunk or liftgate.

Ensure that the windows are closed, as the system can be armed even if the windows are open.

2. Turn the key to LOCK and remove the key from the ignition.

If the key is inserted in the ignition, the transmitter will not arm the theft-deterrent system.

3. Lock the doors by pressing the lock button on the remote keyless entry transmitter.

- The LED on the transmitter will flash once.
- All of the doors will lock.
- The hazard warning lamps will flash once and the horn will chirp.
- The theft-deterrent mode will arm.

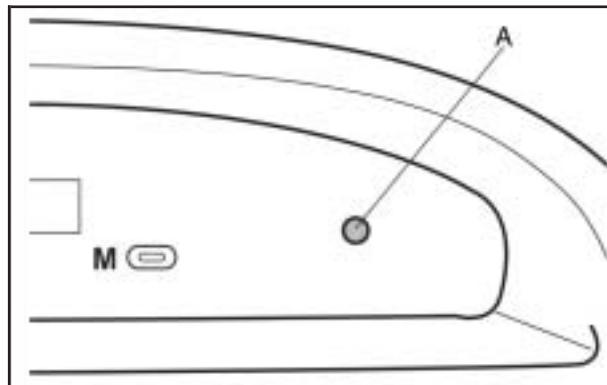

- The security light (A) will flash once every second to indicate that the theft-deterrent system is armed. The security light is located on the secondary information center (SIC) on the center of the instrument panel.

To avoid activating the alarm by accident, do one of the following:

- Unlock the driver's or passenger's front door using the key.
- Press the unlock button on the remote keyless entry transmitter.

Unlocking a door any other way will activate the alarm when a door or the trunk or liftgate is opened.

If you do not want to arm the theft-deterrent system, lock the vehicle using the key or the manual door locks.

Disarming the System

To disarm the system, do one of the following:

- Unlock the driver's or passenger's front door using the key.
- Press the unlock button on the remote keyless entry transmitter.
 - The LED on the transmitter will flash once.
 - All of the doors will unlock.
 - The hazard warning lamps will flash twice.
 - The theft-deterrent mode will disarm.

If the door is not opened or if the engine is not started within 30 seconds after disarming the system using the transmitter, all of the doors will automatically lock and the theft-deterrent mode will rearm.

How the System Alarm is Activated

If a door or the trunk or liftgate is opened without using the key or the remote keyless entry transmitter, the horn will sound and the lamps will flash for up to 30 seconds.

How to Turn Off the System Alarm

If the system alarm is active, it can be deactivated using one of the following methods:

- Press the lock or unlock buttons on the remote keyless entry transmitter.
- Unlock the driver's or passenger's front door using the key.

Otherwise, the alarm will automatically stop after 30 seconds. The system will then lock the doors and rearm the theft-deterrent system.

How to Detect a Tamper Condition

If the hazard warning lamps flash once when you press the lock or unlock buttons on the remote keyless entry transmitter, the theft-deterrent system alarm was activated while you were away.

Immobilizer

This device complies with Part 15 of the FCC Rules. Operation is subject to the following two conditions:

1. this device may not cause interference, and
2. this device must accept any interference received, including interference that may cause undesired operation.

This device complies with RSS-210 of Industry Canada. Operation is subject to the following two conditions:

1. this device may not cause interference, and
2. this device must accept any interference received, including interference that may cause undesired operation of the device.

Changes or modifications to this system by other than an authorized service facility could void authorization to use this equipment.

Immobilizer Operation

Your vehicle may have a passive theft-deterrent system. The immobilizer system prevents your vehicle from being started by unauthorized persons.

If your vehicle has an immobilizer system, your vehicle has a special key that works with the theft-deterrent system. There is a transponder in the key head that is electronically coded. The correct key will start the vehicle. An invalid key immobilizes the engine.

The immobilizer system isolates the power supply to the ignition system, the fuel pump and the fuel injectors.

The engine immobilizer is activated after the key is turned to LOCK and removed from the ignition. The security light located on the top center of the instrument panel in the secondary information center will flash when the immobilizer is active. If the light does not flash after removing the key, have the system checked by your dealer.

The immobilizer system works when you turn the key to START. If the immobilizer system does not recognize the electronic code, the engine will not start and the security indicator will continue blinking. If your key is ever damaged, you may not be able to start your vehicle.

When trying to start the vehicle, if the engine does not start and the security light continues flashing, the key may have a damaged transponder. Turn the ignition off and try again.

If the engine still does not start, and the key appears to be undamaged, try another key. At this time, you may also want to check the fuse. See *Fuses and Circuit Breakers* on page 5-85. If the engine still does not start with the other key, your vehicle needs service.

If your vehicle does start, the first key may be faulty. See your dealer who can have a new key made.

Up to five keys may be programmed for the vehicle. If you lose or damage your keys, only a GM dealer can have new keys made.

If you are ever driving and the security light comes on and stays on, you will be able to restart your engine if you turn it off. The theft-deterrent system, however, is not working properly and must be serviced by your dealer. Your vehicle is not protected by the theft-deterrent system at this time.

In an emergency, contact Chevrolet Roadside Assistance. See *Roadside Assistance Program* on page 7-6.

Starting and Operating Your Vehicle

New Vehicle Break-In

Notice: Your vehicle does not need an elaborate “break-in.” But it will perform better in the long run if you follow these guidelines:

- Do not drive at any one speed — fast or slow — for the first 500 miles (805 km). Do not make full-throttle starts.
- Avoid making hard stops for the first 200 miles (322 km) or so. During this time your new brake linings are not yet broken in. Hard stops with new linings can mean premature wear and earlier replacement. Follow this breaking-in guideline every time you get new brake linings.
- Do not tow a trailer during break-in. See *Towing a Trailer* on page 4-37 for more information.

Ignition Positions

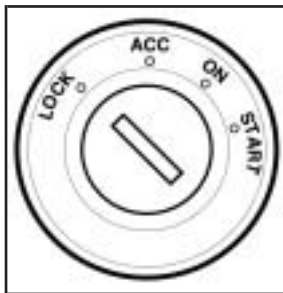

With the key in the ignition switch, you can turn the key to four different positions.

CAUTION:

On manual transaxle vehicles, turning the key to LOCK and removing it will lock the steering column and result in a loss of ability to steer the vehicle. This could cause a collision. If you need to turn the engine off while the vehicle is moving, turn the key only to ACC. Do not push the key in while the vehicle is moving.

Notice: If your key seems stuck in LOCK and you can not turn it, be sure you are using the correct key; if so, is it all the way in? If it is, then turn the steering wheel left and right while you turn the key hard. Turn the key only with your hand. Using a tool to force it could break the key or the ignition switch. If none of these works, then your vehicle needs service.

LOCK: This position locks your steering wheel, ignition, shift lever and transaxle. This is the only position in which you can insert or remove the key. For easier key operation when unlocking the steering wheel, move the steering wheel from right to left and turn the key to ACC.

ACC (ACCESSORY): This position operates some of your electrical accessories, such as the radio, but not the ventilation fan.

ON: This is the position to which the switch returns after you start your engine and release the key. The switch stays in ON when the engine is running. But even when the engine is not running, you can use ON to operate your electrical accessories, and to display some instrument panel warning lights.

START: This position starts the engine. When the engine starts, release the key. The switch will return to ON for normal driving. Do not turn the key to START if the engine is running.

Even if the engine is not running, ACC and ON allow you to operate electrical accessories, such as the radio.

Starting Your Engine

Automatic Transaxle

Move your shift lever to PARK (P) or NEUTRAL (N). Your engine will not start in any other position — that is a safety feature. To restart when you are already moving, use NEUTRAL (N) only.

Notice: Shifting into PARK (P) with the vehicle moving could damage the transaxle. Shift into PARK (P) only when your vehicle is stopped.

Manual Transaxle

The shift lever should be in NEUTRAL and the parking brake engaged. Hold the clutch pedal to the floor and start the engine. Your vehicle will not start if the clutch pedal is not all the way down — that is a safety feature.

Starting Your Engine

1. With your foot off the accelerator pedal, turn your ignition key to START. When the engine starts, let go of the key. The idle speed will go down as your engine gets warm.

Notice: Holding your key in START for longer than 15 seconds at a time will cause your battery to be drained much sooner. And the excessive heat can damage your starter motor. Wait about 15 seconds between each try to help avoid draining your battery or damaging your starter.

2. If it does not start, wait about 15 seconds and try again to start the engine by turning the ignition key to START. Wait about 15 seconds between each try.

When your engine has run about 10 seconds to warm up, your vehicle is ready to be driven. Do not race your engine when it is cold.

If the weather is below freezing (32°F or 0°C), let the engine run for a few minutes to warm up.

3. If your engine still will not start or starts but then stops, it could be flooded with too much gasoline. Try pushing your accelerator pedal all the way to the floor and holding it there as you hold the key in START for about three seconds. If the vehicle starts briefly but then stops again, do the same thing, but this time keep the pedal down for five or six seconds. This clears the extra gasoline from the engine.

Notice: Your engine is designed to work with the electronics in your vehicle. If you add electrical parts or accessories, you could change the way the engine operates. Before adding electrical equipment, check with your dealer. If you do not, your engine might not perform properly.

Engine Coolant Heater (Canada Only)

Your vehicle may have an engine coolant heater. In very cold weather 0°F (-18°C) or colder, the engine coolant heater can help. You will get easier starting and better fuel economy during engine warm-up. Usually, the coolant heater should be plugged in a minimum of four hours prior to starting your vehicle. At temperatures above 32°F (0°C), use of the coolant heater is not required.

To Use the Engine Coolant Heater

1. Turn off the engine.
2. Open the hood and unwrap the electrical cord. The electrical cord is located near the battery.
3. Plug the cord into a normal, grounded 110-volt AC outlet.

CAUTION:

Plugging the cord into an ungrounded outlet could cause an electrical shock. Also, the wrong kind of extension cord could overheat

CAUTION: (Continued)

CAUTION: (Continued)

and cause a fire. You could be seriously injured. Plug the cord into a properly grounded three-prong 110-volt AC outlet. If the cord will not reach, use a heavy-duty three-prong extension cord rated for at least 15 amps.

4. Before starting the engine, be sure to unplug and store the cord as it was before to keep it away from moving engine parts. If you do not, it could be damaged.

How long should you keep the coolant heater plugged in? The answer depends on the outside temperature, the kind of oil you have, and some other things. Instead of trying to list everything here, we ask that you contact your dealer in the area where you will be parking your vehicle. The dealer can give you the best advice for that particular area.

Automatic Transaxle Operation



If your vehicle has an automatic transaxle, the shift lever is located on the console between the seats.

Movement between certain positions requires pushing the shift lever toward the passenger side while shifting. This prevents you from changing positions unexpectedly by blocking the straight movement of the shift lever while the vehicle is moving.

PARK (P): This position locks your front wheels. It is the best position to use when you start your engine because your vehicle cannot move easily.

CAUTION:

It is dangerous to get out of your vehicle if the shift lever is not fully in PARK (P) with the parking brake firmly set. Your vehicle can roll.

Do not leave your vehicle when the engine is running unless you have to. If you have left the engine running, the vehicle can move suddenly. You or others could be injured. To be sure your vehicle will not move, even when you are on fairly level ground, always set your parking brake and move the shift lever to PARK (P). See *Shifting Into Park (P) (Automatic Transaxle)* on page 2-29.

Ensure that the shift lever is fully in PARK (P) before starting the engine. Your vehicle has an automatic transaxle shift lock control system. You have to apply your regular brakes before you can shift from PARK (P) when the key is in ON. If you cannot shift out of PARK (P) while holding the brake pedal down, see *Shifting Out of Park (P) (Automatic Transaxle)* on page 2-30.

REVERSE (R): Use this gear to back up.

When shifting from NEUTRAL (N) to REVERSE (R), you need to apply the regular brake and push the shift lever toward the passenger side of the vehicle and then forward.

Notice: Shifting to REVERSE (R) while your vehicle is moving forward could damage the transaxle. The repairs would not be covered by your warranty. Shift to REVERSE (R) only after your vehicle is stopped.

To rock your vehicle back and forth to get out of snow, ice or sand without damaging your transaxle, see *If You Are Stuck: In Sand, Mud, Ice or Snow* on page 4-28.

NEUTRAL (N): In this position, your engine does not connect with the wheels. To restart while you are already moving, use NEUTRAL (N) only. Also, use NEUTRAL (N) when your vehicle is being towed.

 **CAUTION:**

Shifting into a drive gear while your engine is running at high speed is dangerous. Unless your foot is firmly on the brake pedal, your vehicle could move very rapidly. You could lose control and hit people or objects. Do not shift into a drive gear while your engine is running at high speed.

Notice: Shifting out of PARK (P) or NEUTRAL (N) with the engine racing may damage the transaxle. The repairs would not be covered by your warranty. Be sure the engine is not racing when shifting your vehicle.

AUTOMATIC OVERDRIVE (D4): This position is for normal driving.

Notice: Driving your vehicle if you notice that it is moving slowly or not shifting gears as you increase speed may damage the transaxle. Have your vehicle serviced right away. You can drive in **SECOND (2)** when you are driving less than 35 mph (55 km/h) and **AUTOMATIC OVERDRIVE (D4)** for higher speeds until then.

SECOND (2): This position gives you more power but lower fuel economy. You can use **SECOND (2)** on hills. It can help control your speed as you go down steep mountain roads, but then you would also want to use your brakes off and on.

Notice: Do not drive in **SECOND (2)** at speeds over 65 mph (105 km/h), or you can damage the transaxle. Use **AUTOMATIC OVERDRIVE (D4)** as much as possible. Do not shift into **SECOND (2)** unless you are going slower than 65 mph (105 km/h) or you can damage your engine.

FIRST (1): This position gives you even more power but lower fuel economy than **SECOND (2)**. You can use it on very steep hills, or in deep snow or mud. If the shift lever is put in **FIRST (1)**, the transaxle will not shift into first gear until the vehicle is going slowly enough.

Notice: Spinning the tires or holding the vehicle in one place on a hill using only the accelerator pedal may damage the transaxle. If you are stuck, do not spin the tires. When stopping on a hill, use the brakes to hold the vehicle in place.

If there is a malfunction with the automatic transaxle, the malfunction indicator lamp (MIL) or the **HOLD** indicator light will turn on or flash. See *Malfunction Indicator Lamp on page 3-28* or *Hold Mode Light on page 3-28*.

Have your vehicle fixed as soon as possible.

Hold Mode

If your vehicle's transaxle has hold mode, you can select this mode to drive with some characteristics of a manual transaxle. With hold mode turned on, the automatic transaxle will stay in a specific gear range.



Press the HOLD button on the shift lever console to turn on hold mode. Press the button again to turn off hold mode, and return to normal automatic transaxle operation.

While on, the HOLD indicator light on the secondary information center will light up. See *Hold Mode Light* on page 3-28.

When hold mode is activated, the transaxle is fixed in the gear selected.

Hold Mode Features

Winter Function

Select hold mode while in AUTOMATIC OVERDRIVE (D4) to help the vehicle maintain traction on slippery road surfaces, such as snow, mud, or ice.

Manually Controlling Shift

Select hold mode to use your automatic transaxle like a three-speed manual transaxle.

Manual Transaxle Operation

Five-Speed

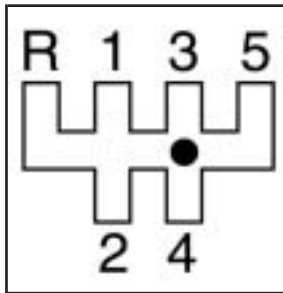

This is your shift pattern.

Here is how to operate your manual transaxle:

FIRST (1): Press the clutch pedal and shift into FIRST (1). Then, slowly let up on the clutch pedal as you press the accelerator pedal.

You can shift into FIRST (1) when you are going less than 20 mph (32 km/h). If you have come to a complete stop and it is hard to shift into FIRST (1), put the shift lever in NEUTRAL and let up on the clutch. Press the clutch pedal back down. Then shift into FIRST (1).

SECOND (2): Press the clutch pedal as you let up on the accelerator pedal and shift into SECOND (2). Then, slowly let up on the clutch pedal as you press the accelerator pedal.

THIRD (3), FOURTH (4) and FIFTH (5): Shift into THIRD (3), FOURTH (4) and FIFTH (5), the same way you do for SECOND (2). Slowly let up on the clutch pedal as you press the accelerator pedal.

To stop, let up on the accelerator pedal and press the brake pedal. Just before the vehicle stops, press the clutch pedal and the brake pedal, and shift to NEUTRAL.

NEUTRAL: Use this position when you start or idle your engine.

REVERSE (R): To back up, press down the clutch pedal, lift up the ring on the shift lever and shift into REVERSE (R). Let up on the clutch pedal slowly while pressing the accelerator pedal.

Notice: Shifting to REVERSE (R) while your vehicle is moving forward could damage the transaxle. The repairs would not be covered by your warranty. Shift to REVERSE (R) only after your vehicle is stopped.

Also, use REVERSE (R), along with the parking brake, for parking your vehicle.

Shift Speeds

CAUTION:

If you skip a gear when you downshift, you could lose control of your vehicle. You could injure yourself or others. Don't shift down more than one gear at a time when you downshift.

Parking Brake

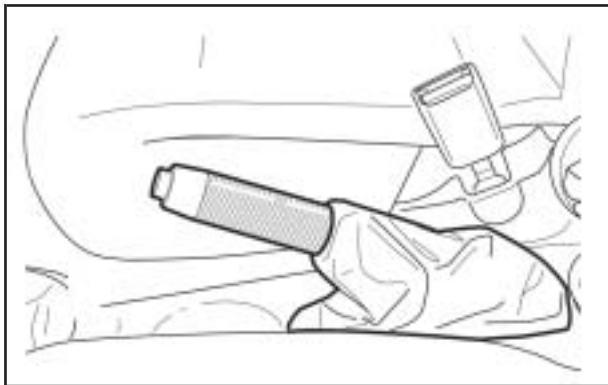

The parking brake lever is located between the bucket seats.

To set the parking brake, hold the brake pedal down and pull up on the parking brake lever. If the ignition is on, the brake system warning light will come on. See *Brake System Warning Light* on page 3-20.

To release the parking brake, hold the brake pedal down. Pull the parking brake lever up until you can press the release button. Hold the release button in as you move the brake lever all the way down.

Notice: Driving with the parking brake on can overheat the brake system and cause premature wear or damage to brake system parts. Verify that the parking brake is fully released and the brake warning light is off before driving.

Shifting Into Park (P) (Automatic Transaxle)

CAUTION:

It can be dangerous to get out of your vehicle if the shift lever is not fully in PARK (P) with the parking brake firmly set. Your vehicle can roll. If you have left the engine running, the vehicle can move suddenly. You or others could be injured. To be sure your vehicle will not move, even when you are on fairly level ground, use the steps that follow.

1. Hold the brake pedal down and set the parking brake.
2. Move the shift lever into the PARK (P) position by pushing the lever toward the passenger side of the vehicle and then up.
3. Turn the ignition key to LOCK.
4. Remove the key and take it with you. If you can leave your vehicle with the ignition key in your hand, your vehicle is in PARK (P).

Leaving Your Vehicle With the Engine Running

CAUTION:

It can be dangerous to leave your vehicle with the engine running. Your vehicle could move suddenly if the shift lever is not fully in PARK (P) with the parking brake firmly set. And, if you leave the vehicle with the engine running, it could overheat and even catch fire. You or others could be injured. Do not leave your vehicle with the engine running.

If you have to leave your vehicle with the engine running, be sure your vehicle is in PARK (P) and your parking brake is firmly set before you leave it. After you have moved the shift lever into PARK (P), hold the regular brake pedal down. Then, see if you can move the shift lever away from PARK (P). If you can, it means that the shift lever was not fully locked into PARK (P).

Torque Lock

If you are parking on a hill and you do not shift your transaxle into PARK (P) properly, the weight of the vehicle may put too much force on the parking pawl in the transaxle. You may find it difficult to pull the shift lever out of PARK (P). This is called “torque lock.” To prevent torque lock, set the parking brake and then shift into PARK (P) properly before you leave the driver’s seat. To find out how, see *Shifting Into Park (P) (Automatic Transaxle)* on page 2-29.

When you are ready to drive, move the shift lever out of PARK (P) *before* you release the parking brake.

If torque lock does occur, you may need to have another vehicle push yours a little uphill to take some of the pressure from the parking pawl in the transaxle, so you can pull the shift lever out of PARK (P).

Shifting Out of Park (P) (Automatic Transaxle)

Your automatic transaxle vehicle has an automatic transaxle shift lock control system. You have to fully apply your regular brakes before you can shift from PARK (P) when the ignition is turned to ON. See *Automatic Transaxle Operation* on page 2-22.

If you cannot shift out of PARK (P) while holding the brake pedal down, try this:

1. Set the parking brake.
2. Turn the ignition off and remove the key.
3. Remove the cover over the shift-lock release slot by prying it off using a small, flat object, like a screwdriver. The shift-lock release slot is located at the top of the shift lever.

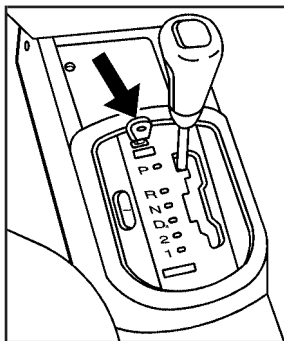

4. Insert the key into the shift-lock release slot and press and hold the key.

5. Shift to NEUTRAL (N).
6. Remove the key from the shift-lock release slot, insert the key into the ignition and start the engine.
7. Replace the shift-lock release slot cover.
8. Apply and hold the regular brake fully and release the parking brake.
9. Shift to the gear you want.
10. Have the system fixed as soon as you can.

Parking Your Vehicle (Manual Transaxle)

Before leaving your vehicle, do the following:

1. Hold the brake pedal down and firmly apply the parking brake.
2. Fully press in the clutch pedal and place the shift lever into the appropriate position as stated below:
 - When parking on level ground, place the shift lever into NEUTRAL.
 - When parking downhill, place the shift lever in REVERSE (R).
 - When parking uphill, place the shift lever in FIRST (1).
3. After shifting to the appropriate position, turn the ignition key to LOCK, remove the key and release the clutch.

Parking Over Things That Burn

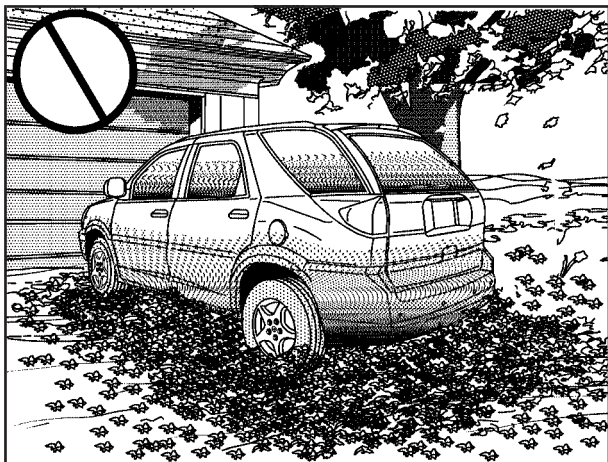

CAUTION:

Things that can burn could touch hot exhaust parts under your vehicle and ignite. Do not park over papers, leaves, dry grass or other things that can burn.

Engine Exhaust

CAUTION:

Engine exhaust can kill. It contains the gas carbon monoxide (CO), which you can not see or smell. It can cause unconsciousness and death.

You might have exhaust coming in if:

- Your exhaust system sounds strange or different.
- Your vehicle gets rusty underneath.
- Your vehicle was damaged in a collision.
- Your vehicle was damaged when driving over high points on the road or over road debris.
- Repairs were not done correctly.
- Your vehicle or exhaust system had been modified improperly.

If you ever suspect exhaust is coming into your vehicle:

- Drive it only with all the windows down to blow out any CO; and
- Have your vehicle fixed immediately.

Running Your Engine While You Are Parked

It is better not to park with the engine running. But if you ever have to, here are some things to know.

CAUTION:

Idling the engine with the climate control system off could allow dangerous exhaust into your vehicle. See the earlier Caution under *Engine Exhaust on page 2-32*.

Also, idling in a closed-in place can let deadly carbon monoxide (CO) into your vehicle even if the climate control fan is at the highest setting. One place this can happen is a garage. Exhaust — with CO — can come in easily. NEVER park in a garage with the engine running.

Another closed-in place can be a blizzard. See *Winter Driving on page 4-24*.

CAUTION:

It can be dangerous to get out of your vehicle if the shift lever is not fully in PARK (P) with the parking brake firmly set. Your vehicle can roll. Do not leave your vehicle when the engine is running unless you have to. If you have left the engine running, the vehicle can move suddenly. You or others could be injured. To be sure your vehicle will not move, even when you are on fairly level ground, always set your parking brake and move the shift lever to PARK (P).

Follow the proper steps to be sure your vehicle will not move. See *Shifting Into Park (P) (Automatic Transaxle) on page 2-29*.

If you are parking on a hill and if you are pulling a trailer, also see *Towing a Trailer on page 4-37*.

Mirrors

Manual Rearview Mirror

When you are sitting in a comfortable driving position, adjust the mirror so you can see clearly behind your vehicle. Grip the mirror in the center to move it up or down and side to side. The day/night adjustment allows you to adjust the mirror to avoid glare from any headlamps behind you. Push the tab away from you for daytime use; pull it toward you for night use.

Outside Manual Mirrors

The outside rearview mirrors should be adjusted so you can see a little of the side of your vehicle when you are sitting in a comfortable driving position.

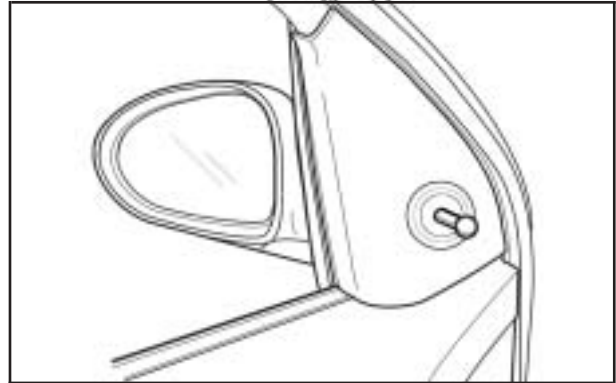

Adjust the outside manual mirrors using the control lever located next to the mirror.

The outside rearview mirrors can be folded flat against the side of the vehicle by pushing them toward the vehicle.

Outside Power Mirror

Your vehicle may have an outside power mirror control that adjusts the passenger's side mirror.

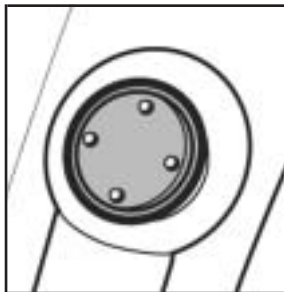

The control for the power mirror is located on the driver's door panel, above the power window buttons.

To adjust the passenger's side mirror, press the corresponding edges located on the four-way control pad to move the mirror in the direction that you want it to go. The ignition must be turned to ON to adjust the mirrors.

The outside rearview mirrors can be folded flat against the side of the vehicle by pushing them toward the vehicle.

Outside Convex Mirror

Your passenger's side mirror is convex. A convex mirror's surface is curved so you can see more from the driver's seat.

CAUTION:

A convex mirror can make things (like other vehicles) look farther away than they really are. If you cut too sharply into the right lane, you could hit a vehicle on your right. Check your inside mirror or glance over your shoulder before changing lanes.

Outside Heated Mirrors

If your vehicle has this feature, when you operate the rear window defogger, the heated driver's and passenger's outside power mirrors are warmed to help clear them of ice and snow. See "Rear Window and Outside Mirror Defogger" under *Climate Control System* on page 3-12 for more information.

Storage Areas

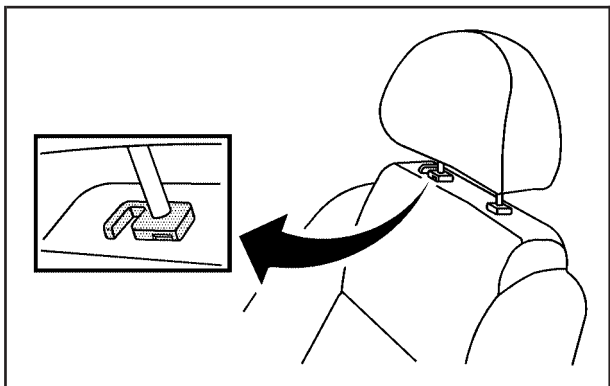

Your vehicle has shopping hooks on each front seatback for your convenience.

Glove Box

Open the glove box by pulling the bottom of the handle upward. Close the glove box with a firm push.

Cupholder(s)

The cupholders are located in the center instrument panel, below the climate control system. To use the cupholder, push in on its outer edge. Then pull out the cupholder. After use, push in the cupholder until it latches.

There is also a cupholder located in the rear part of the center console, behind the parking brake.

Sunglasses Storage Compartment

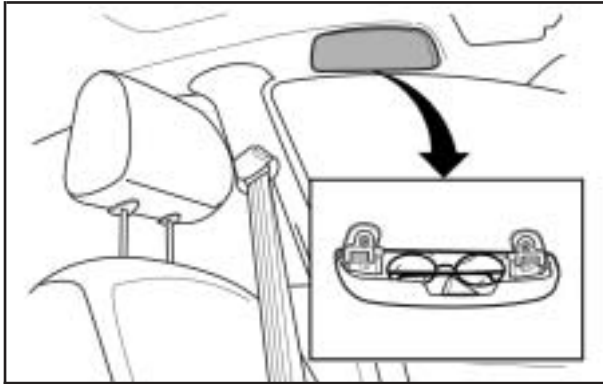

If your vehicle has this feature, the sunglasses storage compartment is located above the driver's door. To open the sunglasses storage compartment, pull down and hold the upper part of the cover. To close the compartment, let go of the cover and the compartment will automatically close.

Sunroof

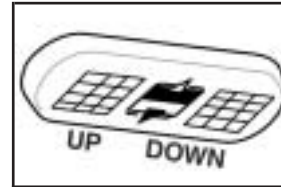

If your vehicle has this feature, the switch is located on the headliner between the sun visors.

The sunroof will only operate when the ignition is turned to ON. The sunroof can be opened to a vent position or it can be opened all of the way.

You must manually open and close the sunroof cover.

To open the sunroof to the vent position, open the sunroof cover. Then press and hold the UP switch. To return the sunroof to its original position, press the DOWN switch and hold it until the sunroof reaches the desired position.

To fully open the sunroof, open the sunroof cover. Then press and hold the DOWN switch. To close the sunroof, press the UP switch and hold it until the sunroof is closed.

The sunroof will stop if the switch is released during operation.

In both the vent and fully open positions, the air flow can be adjusted for driving comfort by pushing and holding the switch until the sunroof moves to the desired position.

The sunroof glass panel cannot be opened or closed if your vehicle has an electrical failure.



NOTES

Section 3 Instrument Panel

Instrument Panel Overview	3-2	Highbeam On Light	3-22
Hazard Warning Flashers	3-3	Fuel Gage	3-22
Other Warning Devices	3-4	Low Fuel Warning Light	3-23
Horn	3-4	Secondary Information Center (SIC)	3-24
Tilt Wheel	3-4	Clock	3-25
Turn Signal/Multifunction Lever	3-5	Safety Belt Reminder Light	3-25
Windshield Wiper Lever	3-6	Air Bag Readiness Light	3-26
Exterior Lamps	3-8	Charging System Light	3-27
Interior Lamps	3-10	Anti-Lock Brake System Warning Light	3-27
Accessory Power Outlets	3-11	Hold Mode Light	3-28
Ashtrays and Cigarette Lighter	3-12	Malfunction Indicator Lamp	3-28
Climate Controls	3-12	Oil Pressure Light	3-32
Climate Control System	3-12	Fog Lamp Light	3-32
Outlet Adjustment	3-15	Daytime Running Lamps Indicator Light	3-33
Passenger Compartment Air Filter	3-16	Door Ajar Light	3-33
Warning Lights, Gages, and Indicators	3-17	Audio System(s)	3-34
Instrument Panel Cluster	3-18	AM-FM Radio	3-34
Speedometer and Odometer	3-19	Radio with CD	3-36
Tachometer	3-19	Theft-Deterrent Feature	3-43
Safety Belt Reminder Tone	3-20	Radio Reception	3-43
Brake System Warning Light	3-20	Care of Your CDs	3-44
Engine Coolant Temperature Gage	3-21	Care of Your CD Player	3-44
		Backglass Antenna	3-44

Instrument Panel Overview

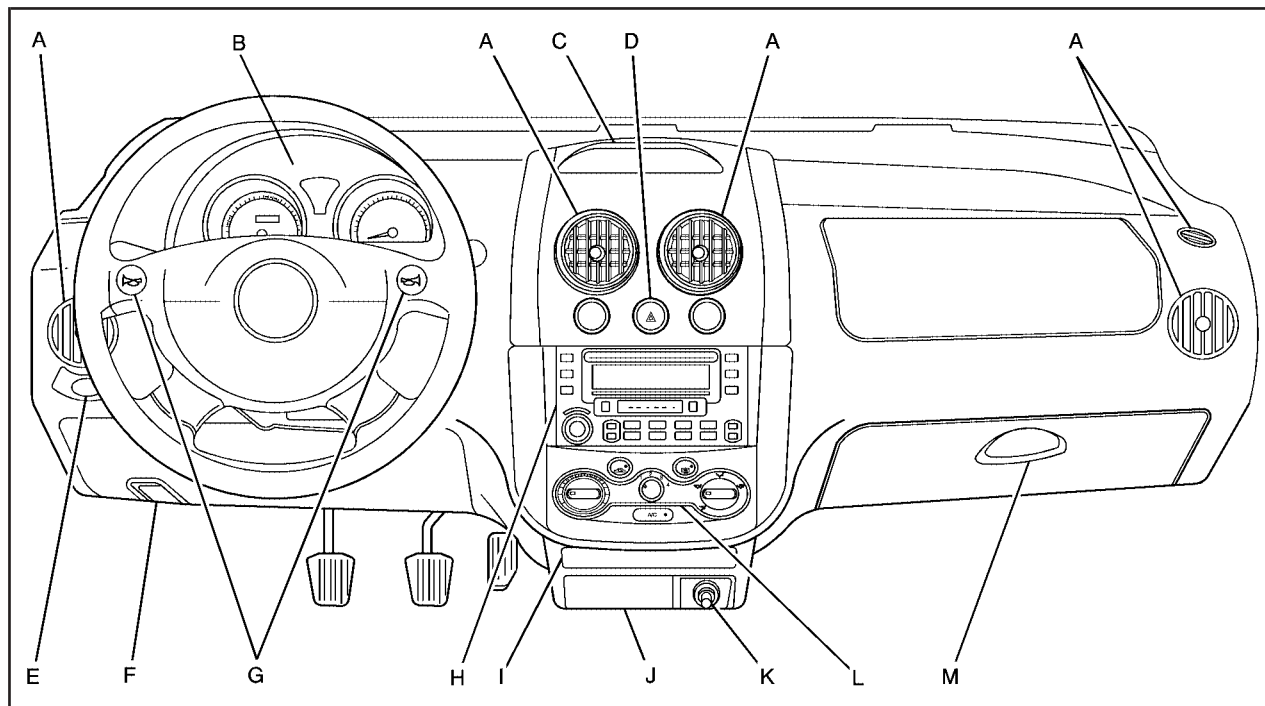

The main components of your instrument panel are the following:

- A. Air Outlet. See *Outlet Adjustment on page 3-15*.
- B. Instrument Panel Cluster. See *Instrument Panel Cluster on page 3-18*.
- C. Digital Clock and Secondary Information Center. See *Clock on page 3-25* and *Secondary Information Center (SIC) on page 3-24*.
- D. Hazard Warning Flashers Button. See *Hazard Warning Flashers on page 3-3*.
- E. Instrument Panel Brightness Control. See "Instrument Panel Brightness" under *Interior Lamps on page 3-10*.
- F. Hood Release. See *Hood Release on page 5-11*.
- G. Horn. See *Horn on page 3-4*.
- H. Audio System. See *Audio System(s) on page 3-34*.
- I. Cupholder. See *Cupholder(s) on page 2-36*.
- J. Ashtray. See *Ashtrays and Cigarette Lighter on page 3-12*.
- K. Cigarette Lighter. See *Ashtrays and Cigarette Lighter on page 3-12*.
- L. Climate Control System. See *Climate Control System on page 3-12*.
- M. Glove Box. See *Glove Box on page 2-36*.

Hazard Warning Flashers

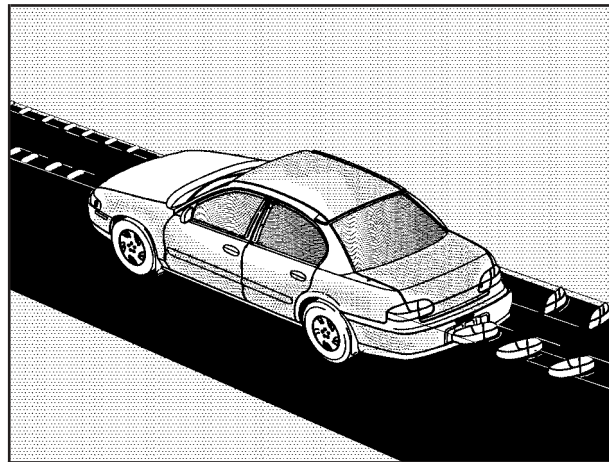

Your hazard warning flashers let you warn others. They also let police know you have a problem. Your front and rear turn signal lamps will flash on and off.

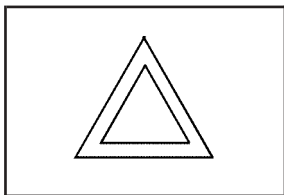

The hazard warning flasher button is located on the center of the instrument panel.

Your hazard warning flashers work no matter what position your key is in, and even if the key is not in.

Press the button to make the front and rear turn signal lamps flash on and off. Press the button again to turn the flashers off.

When the hazard warning flashers are on, your turn signals will not work.

Other Warning Devices

If you carry reflective triangles, you can set one up at the side of the road about 300 feet (100 m) behind your vehicle.

Horn

Press the horn symbols on your steering wheel pad to sound the horn.

Tilt Wheel

Your vehicle has a tilt wheel which allows you to adjust the steering wheel before you drive. You can raise it to the highest level to give your legs more room when you exit and enter the vehicle.

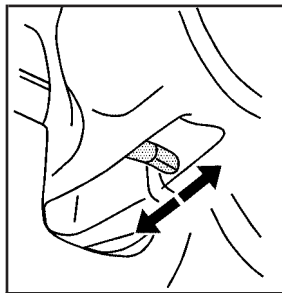

The tilt wheel lever is located underneath the steering column slightly to the left.

To tilt the steering wheel, hold the wheel and push the lever down. Then, move the wheel to a comfortable position and pull the lever up to lock the wheel in place.

Turn Signal/Multifunction Lever

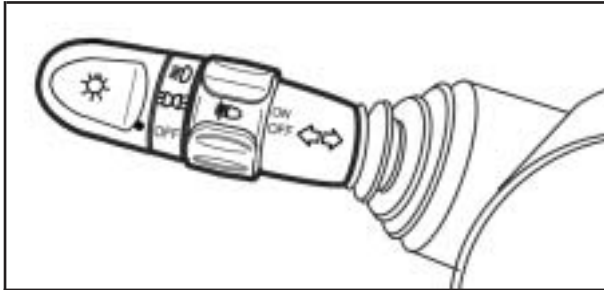

Uplevel shown, Base similar

The lever on the left side of the steering column includes the following:

- Turn and Lane-Change Signals
- Headlamp High/Low-Beam Changer
- Flash-to-Pass
- Fog Lamps, if equipped

For information on the exterior lamps, see *Exterior Lamps* on page 3-8.

Turn and Lane-Change Signals

The turn signal has two upward (for right) and two downward (for left) positions. These positions allow you to signal a turn or a lane change.

To signal a turn, move the lever all the way up or down. When the turn is finished, the lever will return automatically.

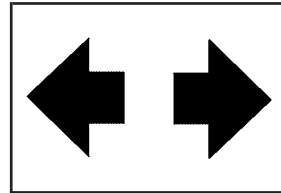

An arrow on the instrument panel cluster will flash in the direction of the turn or lane change.

To signal a lane change, just raise or lower the lever until the arrow starts to flash. Hold it there until you complete your lane change. The lever will return by itself when you release it.

As you signal a turn or a lane change, if the arrows flash rapidly, a signal bulb may be burned out and other drivers will not see your turn signal.

If a bulb is burned out, replace it to help avoid an accident. If the arrows do not go on at all when you signal a turn, check for burned-out bulbs and then check the fuse. See *Fuses and Circuit Breakers* on page 5-85.

Headlamp High/Low-Beam Changer

To change the headlamps from low beam to high beam, push the turn signal/multifunction lever away from you.

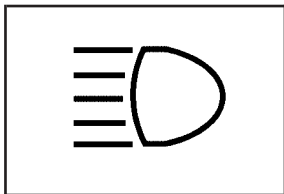

When the high beams are on, this light on the instrument panel cluster also will be on if the ignition is turned to ON.

To change the headlamps from high beam to low beam, pull the turn signal lever toward you.

Flash-to-Pass Feature

This feature lets you use your high-beam headlamps to signal a driver in front of you that you want to pass.

To use it, pull the turn signal/multifunction lever toward you until the high-beam headlamps come on, then release the lever to turn them off.

Fog Lamps

If your vehicle has this feature, use your fog lamps for better visibility in foggy or misty conditions.

See “Fog Lamps” under *Exterior Lamps on page 3-8* for further information.

Windshield Wiper Lever

Windshield Wipers

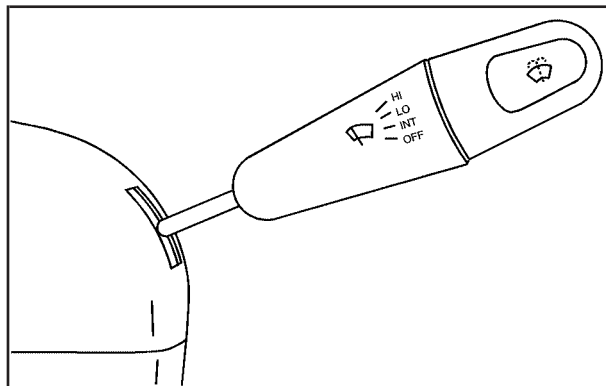

Sedan shown, Hatchback similar

Use this lever located on the right side of the steering wheel to operate the windshield wipers. The ignition must be turned to ON to operate the windshield wipers.

HI (High Speed): Move the lever to this position for wiping at high speed.

LO (Low Speed): Move the lever to this position for steady wiping at low speed.

INT (Intermittent): Move the lever to this position to choose a delayed wiping cycle.

OFF: Move the lever to this position to turn off the windshield wipers.

Misting Function

Move the lever toward the INT position for a single wiping cycle. Hold it there until the windshield wipers start; then let go. The windshield wipers will stop after one wipe. If you want more wipes, hold the band toward INT longer.

Remember that damaged wiper blades may prevent you from seeing well enough to drive safely. To avoid damage, be sure to clear ice and snow from the wiper blades before using them.

If they are frozen to the windshield, carefully loosen or thaw them. If your blades do become damaged, get new blades or blade inserts.

Heavy snow or ice can overload your wiper motor. A circuit breaker will stop the motor until it cools. Clear away snow or ice to prevent an overload.

Windshield Washer

To wash your windshield, pull the windshield wiper/washer lever toward you with the ignition turned to ON.

CAUTION:

In freezing weather, do not use your washer until the windshield is warmed. Otherwise the washer fluid can form ice on the windshield, blocking your vision.

When you release the lever, the washers will stop, but the wipers will continue to wipe for several cycles and will either stop or will resume at the speed you were using before.

Rear Window Washer/Wiper

Your vehicle may have a rear window washer/wiper. Operate the rear window washer/wiper system by pushing the windshield wiper/washer lever away from you. The wiper operates continuously when the lever is in the first position. Washer fluid sprays onto the rear window and the wiper operates continuously when the lever is pushed to the second position.

Exterior Lamps

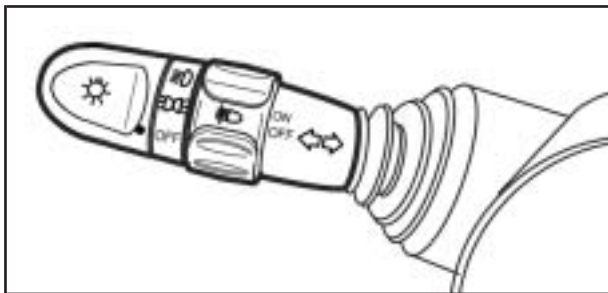

Uplevel shown, Base similar

The lever on the left side of the steering column operates the exterior lamps.

The exterior lamp band has three positions:

 **(Headlamps):** Turn the band to this position to turn on the headlamps, together with the following:

- Taillamps
- License Plate Lamp
- Instrument Panel Lights

 **(Parking Lamps):** Turn the band to this position to turn on the parking lamps, together with the previously listed lamps and lights.

OFF: Turn the band to this position to turn all lamps off, except the Daytime Running Lamps (DRL).

Lamps On Reminder

If you open the driver's door with the ignition turned to LOCK or ACC while leaving the lamps on, you will hear a warning chime.

Daytime Running Lamps (DRL)

Daytime Running Lamps (DRL) can make it easier for others to see the front of your vehicle during the day. DRL can be helpful in many different driving conditions, but they can be especially helpful in the short periods after dawn and before sunset. Fully functional daytime running lamps are required on all vehicles first sold in Canada.

The DRL system will make your low-beam headlamps come on when the following conditions are met:

- The ignition is on.
- The exterior lamp band is in OFF or in the parking lamp position.
- The parking brake is released.

An indicator light on the secondary information center will come on when the DRL system is on. See *Daytime Running Lamps Indicator Light on page 3-33*.

When the DRL system is on, the taillamps, sidemarker lamps, parking lamps and instrument panel lights will not be illuminated unless you have turned the exterior lamps control to the parking lamp or headlamp position.

The DRL system will turn off when one of the following conditions are met:

- The ignition is off.
- The parking brake is on.
- The high-beam headlamps are on.
- The low-beam headlamps are on.
- The flash-to-pass feature is used.

As with any vehicle, you should turn on the regular headlamp system when you need it.

Fog Lamps

If your vehicle has this feature, the control for the fog lamps is a band located on the middle of the turn signal/multifunction lever.

While using the fog lamps, the ignition must be turned to ON and the low-beam headlamps or parking lamps must be on.

Turn the band to ON to turn the fog lamps on. An indicator light on the secondary information center will come on when the fog lamps are on. See *Fog Lamp Light on page 3-32*.

Turn the band to OFF to turn the fog lamps off. The fog lamps will also turn off when the high-beam headlamps are turned on. When the high-beam headlamps are turned off, the fog lamps will turn on again.

Interior Lamps

Instrument Panel Brightness

This feature controls the brightness of the instrument panel lights.

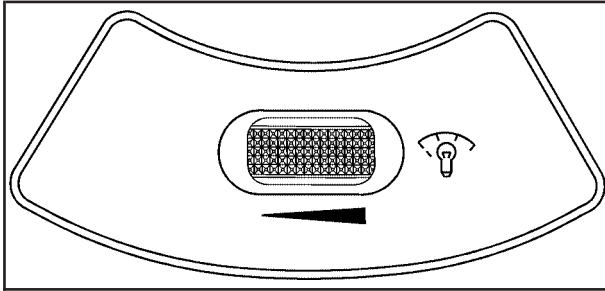

The thumbwheel for this feature is located on the instrument panel to the left of the steering column. Turn the thumbwheel to the right to brighten the lights or to the left to dim them.

Dome Lamp

Your vehicle will have one of the following dome lamp switches.

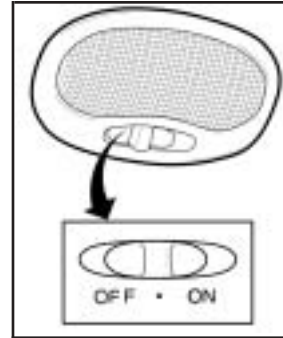

Without Sunroof

You will have this version if your vehicle does not have a sunroof.



With Sunroof

You will have this version if your vehicle has a sunroof.

The switches have three positions.

ON: The light comes on and stays on regardless of whether a door is open or closed.

● **(Door):** The light comes on when a door is opened. The light turns off when all the doors are shut.

OFF: The light remains off even when a door is opened.

Accessory Power Outlets

With the accessory power outlet, you can plug in auxiliary electrical equipment such as a cellular telephone or CB radio.

The accessory power outlet is located next to the parking brake on the center console.

To use the outlet, remove the protective cap. When not in use, always cover the outlet with the protective cap. The accessory power outlet is operational when the ignition is turned to ACC or ON.

Notice: Leaving electrical equipment on for extended periods will drain the battery. Always turn off electrical equipment when not in use and do not plug in equipment that exceeds the maximum amperage rating.

Certain electrical accessories may not be compatible with the accessory power outlet and could result in blown vehicle or adapter fuses. If you experience a problem, see your dealer for additional information on accessory power outlets.

Notice: Adding any electrical equipment to your vehicle may damage it or keep other components from working as they should. The repairs would not be covered by your warranty. Check with your dealer before adding electrical equipment.

When adding electrical equipment, be sure to follow the proper installation instructions included with the equipment.

Notice: Improper use of the power outlet can cause damage not covered by your warranty. Do not hang any type of accessory or accessory bracket from the plug because the power outlets are designed for accessory power plugs only.

Ashtrays and Cigarette Lighter

The ashtray is located at the lower part of the center instrument panel. To remove the front ashtray for cleaning, open the ashtray fully, press in the retaining tab and pull the bin out.

Notice: If you put papers or other flammable items in the ashtray, hot cigarettes or other smoking materials could ignite them and possibly damage your vehicle. Never put flammable items in the ashtray.

The cigarette lighter is located to the right of the front ashtray. To use it, turn the ignition to ACC or ON, push the cigarette lighter in all the way and let go. When it is ready, it will pop back out by itself.

Notice: Holding a cigarette lighter in while it is heating will not allow the lighter to back away from the heating element when it is hot. Damage from overheating may occur to the lighter or heating element. Do not hold a cigarette lighter in while it is heating.

Climate Controls

Climate Control System

With this system you can control the heating, cooling and ventilation for your vehicle.

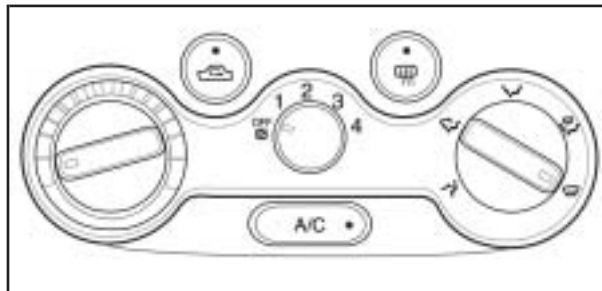



Uplevel shown, Base similar

Temperature Control: Turn the left knob clockwise or counterclockwise to manually increase or decrease the temperature inside your vehicle. Turn the knob to the blue area for cool air and to the red area for warm air.

Fan: Turn the middle knob clockwise or counterclockwise to increase or decrease the fan speed. In any setting other than off, the fan will run continuously with the ignition on. The fan must be on in order for the air conditioning compressor to run.

To change the current mode, select one of the following from the right knob:

 **(Vent):** This mode directs air to the instrument panel outlets.

 **(Bi-Level):** This mode directs about half of the air to the instrument panel outlets, and then directs the remaining air to the floor outlets.

 **(Floor):** This mode directs most of the air to the floor outlets. Some of the air will also be directed to the rear outlets. Be sure to keep the area under the front seats clear to allow the flow of air to the rear compartment.

The right knob can also be used to select the defog and defrost modes. Information on defogging and defrosting can be found later in this section.

 **(Recirculation):** This mode keeps outside air from coming into the vehicle. It can be used to prevent outside air and odors from entering your vehicle or to help heat or cool the air inside your vehicle more quickly.

If your vehicle has a recirculation button (uplevel model), press the button to turn the recirculation mode on. When the button is pressed, an indicator light in the button will come on. Press the button again to return to outside air mode.

If your vehicle has an air intake lever (base model), move the lever to choose the recirculation mode.

Using the recirculation mode for extended periods may cause your windows to fog. If this happens, select the defrost mode.

 **(Outside Air):** This mode brings outside air into the vehicle.

If your vehicle has a recirculation button (uplevel model), press the button until the recirculation mode is turned off. Your vehicle will then return to outside air mode.

If your vehicle has an air intake lever (base model), move the lever to choose the outside air mode.

A/C (Air Conditioning): If your vehicle has air conditioning, follow these steps to use the system. Start the engine and set the fan control knob to the desired speed. The air conditioning compressor does not operate when the fan control knob is in the off position. Press the A/C button to turn the air conditioning compressor on and off. When the A/C button is pressed, an indicator light in the button will come on to let you know that air conditioning is activated.

On hot days, open the windows to let hot inside air escape; then close them. This helps to reduce the time it takes for your vehicle to cool down. It also helps the system to operate more efficiently.

For quick cool down on hot days, do the following:

1. Select the vent mode.
2. Select the highest fan speed.
3. Press the A/C button.
4. Select the recirculation mode.
5. Select the coolest temperature.

Using these settings together for long periods of time may cause the air inside of your vehicle to become too dry. To prevent this from happening, after the air in your vehicle has cooled, turn the recirculation mode off.

The air conditioning system removes moisture from the air, so you may sometimes notice a small amount of water dripping underneath your vehicle while idling or after turning off the engine. This is normal.

Defogging and Defrosting

Fog on the inside of windows is a result of high humidity or moisture condensing on the cool window glass.

This can be minimized if the climate control system is used properly. There are two modes to clear fog or frost from your windshield. Use the defog mode to clear the windows of fog or moisture and warm the passengers. Use the defrost mode to remove fog or frost from the windshield more quickly.

For best results, clear all snow and ice from the windshield before defrosting.

Select one of these available modes from the right knob.

 **(Defog):** This mode directs most of the air to the windshield and the floor outlets. A small amount of air is also directed to the outboard outlets for the side windows.

To help clear the side windows quickly, do the following:

1. Select the bi-level mode.
2. Select the highest fan speed.
3. Select A/C.
4. Select the temperature.

 **(Defrost):** This mode directs the air to the windshield and the outboard outlets for the side windows.

To help clear the windshield quickly, do the following:

1. Select the defrost mode.
2. Select the highest temperature.
3. Select the highest fan speed.

Do not drive the vehicle until all windows are clear.

Rear Window and Outside Mirror Defogger

Your vehicle may have a rear window and outside mirror defogger. This feature will only work when the ignition is turned to ON.

The rear window defogger uses a warming grid to remove fog or frost from the rear window. Before using this feature, clear as much snow from the rear window as possible.

 **(Rear):** Press this button to turn the rear window and outside mirror defogger on or off. An indicator light in the button will come on to let you know that the feature is activated.

Notice: Don't use anything sharp on the inside of the rear window. If you do, you could cut or damage the warming grid, and the repairs wouldn't be covered by your warranty. Do not attach a temporary vehicle license, tape, a decal or anything similar to the defogger grid.

Outlet Adjustment

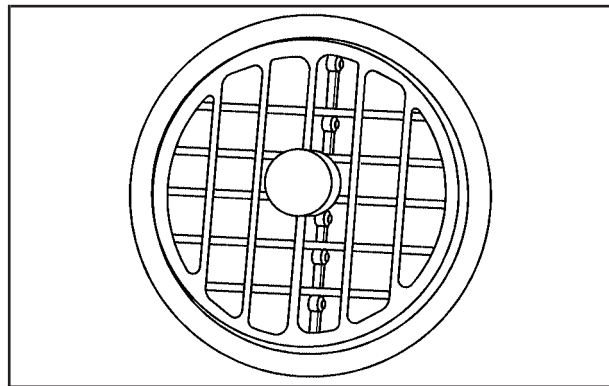

Use the knob located in the center of each outlet to change the direction of the airflow.

Operation Tips

- Clear away any ice, snow or leaves from the air inlets at the base of the windshield that may block the flow of air into your vehicle.
- Use of non-GM approved hood deflectors may adversely affect the performance of the system.
- Keep the path under the front seats clear of objects to help circulate the air inside of your vehicle more effectively.

Passenger Compartment Air Filter

Your vehicle may have a passenger compartment air filter. It is located behind the glove box and can be accessed after removing the glove box from its housing.

The filter traps most of the pollen from air entering the module. Like your engine's air cleaner/filter, it may need to be changed periodically.

To change the passenger compartment air filter, use the following steps:

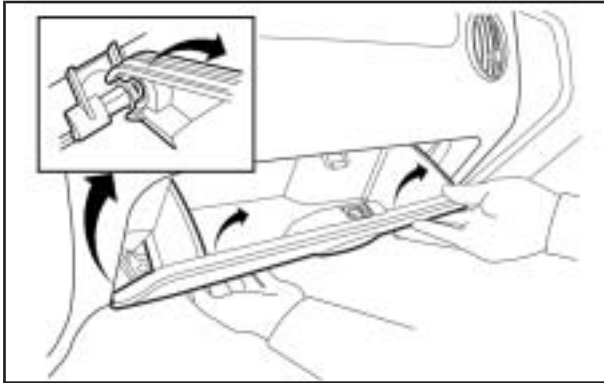

1. Open the glove box halfway down.
2. Grip the glove box by both the upper and lower sides and pull it out of its housing.

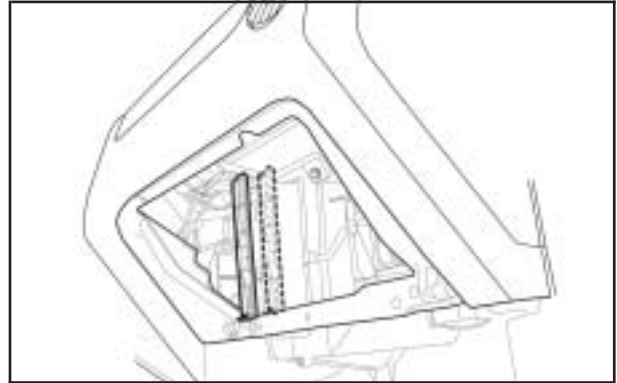

3. Remove the filter cover by pressing in on the bottom retaining tab and pulling the cover down.
 4. Remove the old passenger compartment air filter.
 5. Then reverse the steps to install the new air filter and replace the glove box.
- Ensure that the new filter is inserted to the correct air flow.

Warning Lights, Gages, and Indicators

This part describes the warning lights and gages that may be on your vehicle. The pictures will help you locate them.

Warning lights and gages can signal that something is wrong before it becomes serious enough to cause an expensive repair or replacement. Paying attention to your warning lights and gages could also save you or others from injury.

Warning lights come on when there may be or is a problem with one of your vehicle's functions. As you will see in the details on the next few pages, some warning lights come on briefly when you start the engine just to let you know they're working. If you are familiar with this section, you should not be alarmed when this happens.

Gages can indicate when there may be or is a problem with one of your vehicle's functions. Often gages and warning lights work together to let you know when there's a problem with your vehicle.

When one of the warning lights comes on and stays on when you are driving, or when one of the gages shows there may be a problem, check the section that tells you what to do about it. Please follow this manual's advice. Waiting to do repairs can be costly — and even dangerous. So please get to know your warning lights and gages. They're a big help.

Instrument Panel Cluster

Your instrument panel cluster is designed to let you know at a glance how your vehicle is running. You will know how fast you are going, how much fuel you are using, and many other things you will need to drive safely and economically.

Your vehicle's instrument panel cluster includes indicator warning lights and gages that are explained on the following pages.

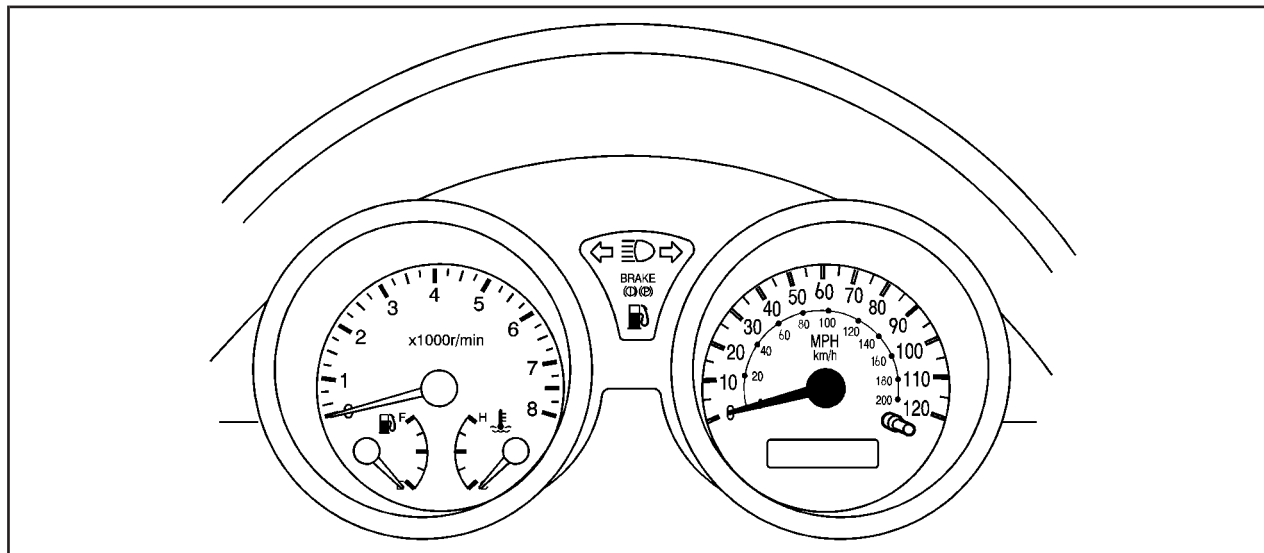

United States shown, Canada similar

Speedometer and Odometer

Your speedometer lets you see your speed in both miles per hour (mph) and kilometers per hour (km/h). Your odometer shows how far your vehicle has been driven in either miles, used in the United States, or kilometers, used in Canada.

Trip Odometer

The trip odometer can record the number of miles, used in the United States, or kilometers, used in Canada, traveled for up to two trips.

You can cycle between the odometer and trip odometers A and B by pressing the reset button located in the lower right area of the speedometer. By pressing the reset button, you can tell how many miles or kilometers have been recorded on either Trip A or Trip B since you last set the trip odometer back to zero.

To reset each trip odometer to zero, press and hold the reset button. The reset button resets only the trip odometer that is being displayed. Each trip odometer must be reset individually.

Tachometer

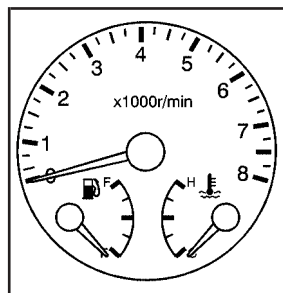

United States shown,
Canada similar

The tachometer displays your engine speed in revolutions per minute (rpm).

Notice: If you operate the engine with the tachometer in the shaded warning area, your vehicle could be damaged, and the damages would not be covered by your warranty. Do not operate the engine with the tachometer in the shaded warning area.

Safety Belt Reminder Tone

If your vehicle has this feature, a tone will sound for several seconds when the ignition is turned to ON to remind people to fasten their safety belts. The tone will not sound if the driver's safety belt is already buckled.

Brake System Warning Light

Your vehicle's hydraulic brake system is divided into two parts. If one part is not working, the other part can still work and stop you. For good braking, though, you need both parts working well.

If the warning light comes on, there is a brake problem. Have your brake system inspected right away.

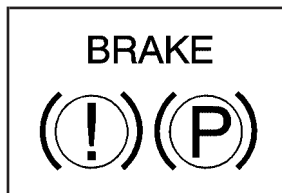

This light should come on briefly when you turn the ignition to ON. If it does not come on then, have it fixed so it will be ready to warn you if there is a problem.

When the ignition is on, the brake system warning light will also come on when you set your parking brake. The light will stay on if your parking brake does not fully release. If it stays on after your parking brake is fully released, it means you have a brake problem.

If the light comes on while you are driving, pull off the road and stop carefully. You may notice that the pedal is harder to push. Or, the pedal may go closer to the floor. It may take longer to stop. If the light is still on, have the vehicle towed for service. See *Towing Your Vehicle* on page 4-29.

⚠ CAUTION:

Your brake system may not be working properly if the brake system warning light is on. Driving with the brake system warning light on can lead to an accident. If the light is still on after you have pulled off the road and stopped carefully, have the vehicle towed for service.

Engine Coolant Temperature Gage

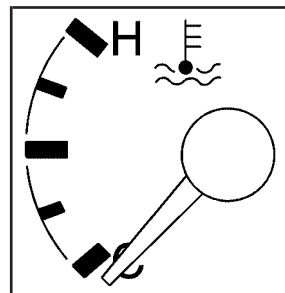

United States

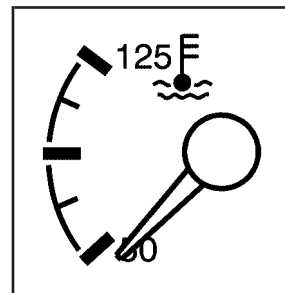

Canada

Your vehicle has an engine coolant temperature gage. With the ignition turned to ON, this gage shows the engine coolant temperature.

If the gage pointer moves into the red area, your engine is too hot. It means that your engine coolant has overheated.

If you have been operating your vehicle under normal driving conditions, you should pull off the road, stop your vehicle and turn off the engine as soon as possible.

See *Engine Overheating* on page 5-25.

Highbeam On Light

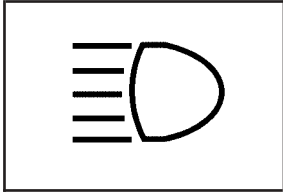

This light comes on whenever the high-beam headlamps are on.

See “Headlamp High/Low-Beam Changer” under *Turn Signal/Multifunction Lever* on page 3-5 for additional information.

Fuel Gage

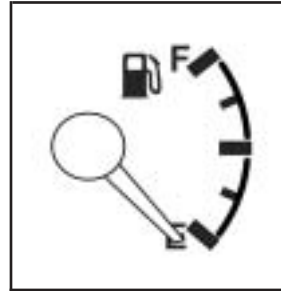

United States

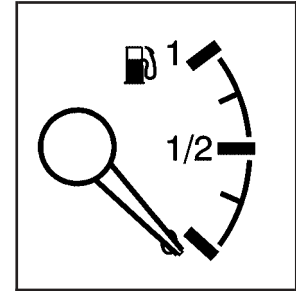

Canada

Your fuel gage tells you about how much fuel you have left when the ignition is turned to ON.

When the tank nears empty, the low fuel warning light will come on. You still have a little fuel left, but you should get more soon. See *Low Fuel Warning Light* on page 3-23 for more information.

Here are four things that some owners ask about. None of these show a problem with your fuel gage:

- At the service station, the gas pump shuts off before the gage reads full.
- It takes a little more or less fuel to fill up than the gage indicated. For example, the gage may have indicated the tank was half full, but it actually took a little more or less than half the tank's capacity to fill the tank.
- The indicator moves a little when you turn a corner or speed up.
- The gage goes back to empty when you turn off the ignition.

Low Fuel Warning Light



This light comes on when the fuel tank is low on fuel.

The low fuel warning light comes on when there is approximately 1.7 gallons (6.0 liters) of fuel remaining in the tank.

To turn the light off, add fuel to the fuel tank. See *Filling Your Tank* on page 5-8.

Secondary Information Center (SIC)

The secondary information center (SIC) displays some of the warning lights and indicators. The SIC is located in the center of the instrument panel, above the center air outlets. The digital clock is also located on the center of the SIC. See *Instrument Panel Overview* on page 3-2 for further information on location.

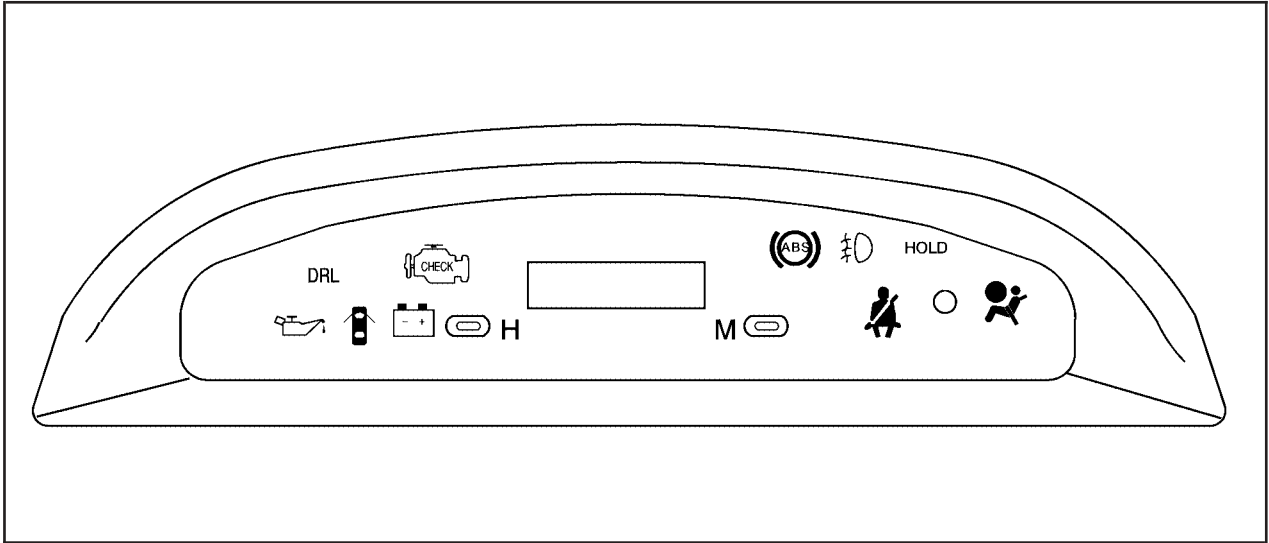

Clock

Your vehicle has a digital clock. The clock is located in the secondary instrument cluster on the center of the instrument panel, above the center air outlets. When the ignition is turned to ACC or ON, the time is displayed in the digital clock. There are two adjusting buttons for the digital clock:

H (Hour): To go forward one hour, press the H button once. To go forward more than one hour, press and hold the button until the correct hour is reached.

M (Minute): To go forward one minute, press the M button once. To go forward more than one minute, press and hold the button until the correct minute is reached.

After disconnecting the battery or replacing the fuse, reset the clock.

Safety Belt Reminder Light



The safety belt light will come on and stay on until the driver's safety belt is buckled.

If the driver's belt is already buckled, the light will not come on.

Air Bag Readiness Light

There is an air bag readiness light on the secondary information center (SIC), which shows the air bag symbol. The system checks the air bag's electrical system for malfunctions. The light tells you if there is an electrical problem. The system check includes the air bag sensor, the air bag modules, the wiring and the crash sensing and diagnostic module. For more information on the air bag system, see *Air Bag Systems* on page 1-50.

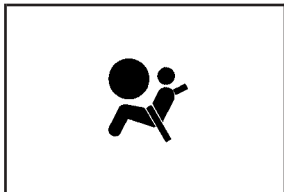

This light will come on when you start your vehicle, and it will flash for a few seconds. Then the light should go out. This means the system is ready.

If the air bag readiness light stays on after you start the vehicle or comes on or flashes when you are driving, your air bag system may not work properly. Have your vehicle serviced right away.

CAUTION:

If the air bag readiness light stays on after you start your vehicle, it means the air bag system may not be working properly. The air bags in your vehicle may not inflate in a crash, or they could even inflate without a crash. To help avoid injury to yourself or others, have your vehicle serviced right away if the air bag readiness light stays on after you start your vehicle.

The air bag readiness light should flash for a few seconds when you turn the ignition to ON. If the light does not come on then, have it fixed so it will be ready to warn you if there is a problem.

Charging System Light

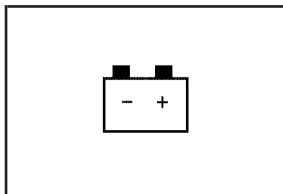

The charging system light will come on briefly when you turn on the ignition, and the engine is not running, as a check to show you it is working.

Then it should go out when the engine is started.

If it stays on, or comes on while you are driving, you may have a problem with the electrical charging system. It could indicate that you have a loose generator drive belt, or another electrical problem. Have it checked right away. Driving while this light is on could drain your battery.

If you must drive a short distance with the light on, be certain to turn off all your accessories, such as the radio and air conditioner.

Anti-Lock Brake System Warning Light

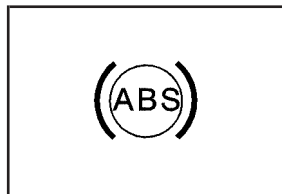

If your vehicle has an anti-lock brake system, this light will come on when the ignition is turned to ON and may stay on for several seconds. That is normal.

If the light stays on, turn the ignition to LOCK. Or, if the light comes on, stop as soon as possible and turn the ignition off. Then start the engine again to reset the system. If the light still stays on, or comes on again while you are driving, your vehicle needs service. If the regular brake system warning light is not on, you still have brakes, but you do not have anti-lock brakes. If the regular brake system warning light is also on, you do not have anti-lock brakes and there is a problem with your regular brakes. See *Brake System Warning Light* on page 3-20.

The anti-lock brake system warning light will come on briefly when you turn the ignition key to ON. This is normal. If the light does not come on then, have it fixed so it will be ready to warn you if there is a problem.

Hold Mode Light



If your vehicle has this feature, this light will come on when the hold mode is active.

If the HOLD mode light flashes, have your vehicle checked. See "Hold Mode" under *Automatic Transaxle Operation on page 2-22* for additional information on this feature.

Malfunction Indicator Lamp

Check Engine Light

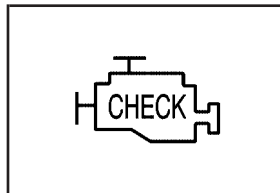

Your vehicle is equipped with a computer which monitors operation of the fuel, ignition and emission control systems.

This system is called OBD II (On-Board Diagnostics-Second Generation) and is intended to assure that emissions are at acceptable levels for the life of the vehicle, helping to produce a cleaner environment. The Check Engine light comes on to indicate that there is a problem and service is required. Malfunctions often will be indicated by the system before any problem is apparent. This may prevent more serious damage to your vehicle. This system is also designed to assist your service technician in correctly diagnosing any malfunction.

Notice: If you keep driving your vehicle with this light on, after a while, your emission controls may not work as well, your fuel economy may not be as good and your engine may not run as smoothly. This could lead to costly repairs that may not be covered by your warranty.

Notice: Modifications made to the engine, transaxle, exhaust, intake or fuel system of your vehicle or replacement tires that do not match your vehicle's original tires can affect your vehicle's emission controls and may cause this light to come on. Modifications to these systems could lead to costly repairs not covered by your warranty. This may also result in a failure to pass a required Emission Inspection/Maintenance test.

When the ignition is on, this light should come on and should go out after a few seconds as a check to show you it is working. If the light does not come on, have it repaired.

This light will also come on during a malfunction in one of two ways:

- **Light Flashing** — A misfire condition has been detected. A misfire increases vehicle emissions and may damage the emission control system on your vehicle. Diagnosis and service may be required.
- **Light On Steady** — An emission control system malfunction has been detected on your vehicle. Diagnosis and service may be required.

If the Light Is Flashing

The following may prevent more serious damage to your vehicle:

- Reducing vehicle speed.
- Avoiding hard accelerations.
- Avoiding steep uphill grades.

If the light stops flashing and remains on steady, see “If the Light Is On Steady” following.

If the light continues to flash, when it is safe to do so, *stop the vehicle*. Find a safe place to park your vehicle. Turn the key off, wait at least 10 seconds and restart the engine. If the light remains on steady, see “If the Light Is On Steady” following. If the light is still flashing, follow the previous steps, and see your dealer for service as soon as possible.

If the Light Is On Steady

You also may be able to correct the emission system malfunction by considering the following:

Did you recently put fuel into your vehicle?

If so, reinstall the fuel cap, making sure to fully install the cap. See *Filling Your Tank on page 5-8*. The diagnostic system can determine if the fuel cap has been left off or improperly installed. A loose or missing fuel cap will allow fuel to evaporate into the atmosphere. A few driving trips with the cap properly installed should turn the light off.

Did you just drive through a deep puddle of water?

If so, your electrical system may be wet. The condition will usually be corrected when the electrical system dries out. A few driving trips should turn the light off.

Have you recently changed brands of fuel?

If so, be sure to fuel your vehicle with quality fuel. See *Gasoline Octane on page 5-5*. Poor fuel quality will cause your engine not to run as efficiently as designed. You may notice this as stalling after start-up, stalling when you put the vehicle into gear, misfiring, hesitation on acceleration or stumbling on acceleration. (These conditions may go away once the engine is warmed up.) This will be detected by the system and cause the light to turn on.

If you experience one or more of these conditions, change the fuel brand you use. It will require at least one full tank of the proper fuel to turn the light off.

If none of the above steps have made the light turn off, your dealer can check the vehicle. Your dealer has the proper test equipment and diagnostic tools to fix any mechanical or electrical problems that may have developed.

Emissions Inspection and Maintenance Programs

Some state/provincial and local governments have or may begin programs to inspect the emission control equipment on your vehicle. Failure to pass this inspection could prevent you from getting a vehicle registration.

Here are some things you need to know to help your vehicle pass an inspection:

Your vehicle will not pass this inspection if the Check Engine light is on or not working properly.

Your vehicle will not pass this inspection if the OBD (on-board diagnostic) system determines that critical emission control systems have not been completely diagnosed by the system. The vehicle would be considered not ready for inspection. This can happen if you have recently replaced your battery or if your battery has run down. The diagnostic system is designed to evaluate critical emission control systems during normal driving. This may take several days of routine driving. If you have done this and your vehicle still does not pass the inspection for lack of OBD system readiness, your GM dealer can prepare the vehicle for inspection.

Oil Pressure Light

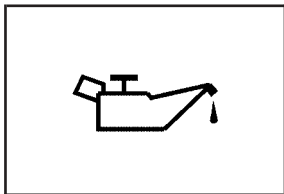

If you have a low engine oil pressure problem, this light will stay on after you start your engine, or come on when you are driving. This indicates that your engine is not receiving enough oil.

The engine could be low on oil, or could have some other oil problem. Have it fixed immediately.

The oil light could also come on in three other situations:

- When the ignition is on but the engine is not running, the light will come on as a test to show you it is working. The light will go out when you turn the ignition on. If it does not come on with the ignition on, you may have a problem with the fuse or bulb. Have it fixed right away.
- If you are idling at a stop sign, the light may blink on and then off.
- If you make a hard stop, the light may come on for a moment. This is normal.

CAUTION:

Do not keep driving if the oil pressure is low. If you do, your engine can become so hot that it catches fire. You or others could be burned. Check your oil as soon as possible and have your vehicle serviced.

Notice: Lack of proper engine oil maintenance may damage the engine. The repairs would not be covered by your warranty. Always follow the maintenance schedule in this manual for changing engine oil.

Fog Lamp Light



If your vehicle has this feature, the fog lamps light will come on when the fog lamps are in use.

The light will go out when the fog lamps are turned off. See "Fog Lamps" under *Exterior Lamps* on page 3-8 for more information.

Daytime Running Lamps Indicator Light



This light will come on when the Daytime Running Lamps (DRL) are on.

A flashing DRL light indicates a possible burned out headlamp, or that the vehicle may need service to repair a defective DRL relay.

See "Daytime Running Lamps (DRL)" under *Exterior Lamps on page 3-8* for further information on the DRL system.

Door Ajar Light



When the ignition is on, this light will stay on until all doors are closed and completely latched.

If the key is in the ignition while the driver's door is open, you will also hear a warning chime.

Audio System(s)

Notice: Before you add any sound equipment to your vehicle – like a tape player, CB radio, mobile telephone or two-way radio – be sure you can add what you want. If you can, it's very important to do it properly. Added sound equipment may interfere with the operation of your vehicle's engine, radio or other systems, and even damage them. Your vehicle's systems may interfere with the operation of sound equipment that has been added improperly.

So, before adding sound equipment, check with your dealer and be sure to check federal rules covering mobile radio and telephone units.

Your audio system has been designed to operate easily and to give years of listening pleasure. You will get the most enjoyment out of it if you acquaint yourself with it first. Figure out which radio you have in your vehicle, find out what your audio system can do, and how to operate all of its controls to be sure you are getting the most out of the advanced engineering that went into it.

AM-FM Radio

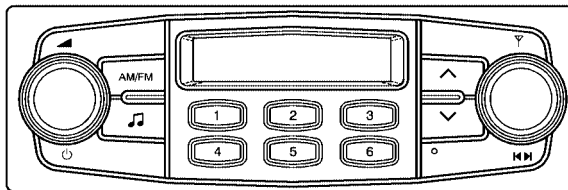

Playing the Radio

⏻ (Power): Press this knob to turn the system on and off.

◀ (Volume): Turn this knob to increase or to decrease volume. VOL will appear on the display.

Finding a Station

AM/FM: Press this button to switch between FM1, FM2, or AM. The display will show your selection.

📡 (Tune): Turn this knob to select radio stations.

◀ ▶ **(Scan):** Press this knob until SCAN flashes on the display, then press either the up or the down arrow buttons to determine the direction for the radio to scan the stations. The radio will go to a station, play for a few seconds, then go on to the next station. Press either arrow button again to stop scanning.

The radio will scan only to stations that are in the selected band and only to those with a strong signal.

Setting Preset Stations

The six numbered pushbuttons let you return to your favorite stations. You can set up to 18 stations (six FM1, six FM2, and six AM), by performing the following steps:

1. Turn the radio on.
2. Press AM/FM to select FM1, FM2, or AM.
3. Tune in the desired station.
4. Press and hold one of the six numbered pushbuttons for longer than two seconds. Ch will appear on the display when the station has been set. Whenever you press that numbered pushbutton, the station you set will return.
5. Repeat the steps for each pushbutton.

Setting the Tone (Bass/Treble)

🎵 **(Bass/Treble):** Press this button until BAS appears on the display. Then turn the volume knob to increase or to decrease the bass. The display will show the bass level.

Press this button until TRE appears on the display. Then turn the volume knob to increase or to decrease the treble. The display will show the treble level. If a station is weak or noisy, you may want to decrease the treble.

Adjusting the Speakers (Balance/Fade)

🎵 **(Balance/Fade):** To adjust the balance between the right and the left speakers, press this button until BAL appears on the display. Then turn the volume knob to increase or to decrease the balance between the right and the left speakers. The display will show the balance level.

To adjust the fade between the front and the rear speakers, press this button until FAD appears on the display. Then turn the volume knob to increase or to decrease the fade between the front and the rear speakers. The display will show the fade level.

Radio with CD

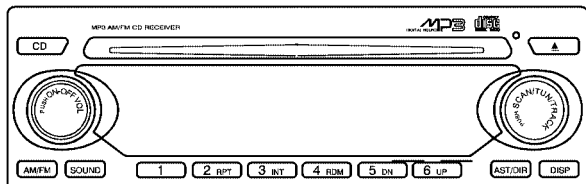

Playing the Radio

ON/OFF: Press this knob to turn the system on and off.

VOL (Volume): Turn this knob to increase or to decrease volume.

Finding a Station

AM/FM: Press this button to switch between FM1, FM2, or AM. The display will show your selection.

TUN (Tune): Turn this knob to select radio stations.

SCAN: Push and release this knob to scan radio stations. The radio will go to a station, play for a few seconds, then go on to the next station. Push this knob again to stop scanning.

The radio will scan only to stations that are in the selected band and only to those with a strong signal.

Setting Preset Stations

The six numbered pushbuttons let you return to your favorite stations. You can set up to 18 stations (six FM1, six FM2, and six AM), by performing the following steps:

1. Turn the radio on.
2. Press AM/FM to select FM1, FM2, or AM.
3. Tune in the desired station.
4. Press and hold one of the six numbered pushbuttons for longer than two seconds. The pushbutton number will flash on the display when the station has been set. Whenever you press that numbered pushbutton, the station you set will return.
5. Repeat the steps for each pushbutton.

Automatic Store

You can also automatically store six FM1 preset stations with the strongest reception in the region. Press the AST button for longer than one second. Once the stations are stored, the radio will switch to FM1 and the first preset station will begin to play. FM-A will appear on the display when listening to the automatic stored stations. Press the AM-FM button to cancel automatic store.

Setting the Tone (Bass/Treble)

SOUND (Bass/Treble): Press this button until BAS appears on the display. Then turn the volume knob to increase or to decrease the bass. The display will show the bass level. When finished making your selection, press this button to select the bass level.

Press this button until TRE appears on the display. Then turn the volume knob to increase or to decrease the treble. The display will show the treble level. When finished making your selection, press this button to select the treble level. If a station is weak or noisy, you may want to decrease the treble.

SOUND (Equalization): Press this button until EQ OFF appears on the display to select customized equalization settings designed for classic, pop, rock, jazz, and voice. Then turn the volume knob until the desired equalization setting appears on the display. When finished making your selection, press the SOUND button to select the equalization setting.

To cancel an equalization setting, press the SOUND button until EQ OFF appears on the display, turn the volume knob until OFF appears on the display, then press the SOUND button again to select the equalization setting.

Adjusting the Speakers (Balance/Fade)

SOUND (Balance/Fade): To adjust the balance between the right and the left speakers, press this button until BAL appears on the display. Then turn the volume knob to increase or to decrease the balance between the right and the left speakers. The display will show the balance level. When finished making your selection, press this button to select the balance level.

To adjust the fade between the front and the rear speakers, press this button until FAD appears on the display. Then turn the volume knob to increase or to decrease the fade between the front and the rear speakers. The display will show the fade level. When finished making your selection, press this button to select the fade level.

Playing a CD

Insert a CD partway into the slot, label side up. The player will pull it in and the CD should begin playing. You can insert a CD with the ignition off.

When the CD is inserted, CDP will appear on the display. As the CD is loading Filecheck will appear on the display. As each new track starts to play, Track and the track number will appear on the display.

If you turn off the ignition or radio with a CD in the player, it will stay in the player. When you turn on the ignition or radio, the CD will start playing where it stopped, if it was the last selected audio source.

The CD player can play the smaller 8 cm single CDs with an adapter ring. Full-size CDs and the smaller CDs are loaded in the same manner.

If playing a CD-R the sound quality may be reduced due to CD-R quality, the method of recording, the quality of the music that has been recorded, and the way the CD-R has been handled. You may experience an increase in skipping, difficulty in finding tracks, and/or difficulty in loading and ejecting. If these problems occur try a known good CD.

Do not add paper labels to CDs, they could get caught in the CD player.

Do not play 3 inch CDs without a standard adapter CD.

If an error appears on the display, see “CD Messages” later in this section.

2 RPT (Repeat): Press this pushbutton to repeat the current track. RPT will appear on the display. Press this pushbutton again to turn off repeat play.

3 INT (SCAN): Press this button to listen to the first few seconds of each track on each CD inserted. INTRO will appear on the display. To stop scanning press this button again. The current track will begin to play.

4 RDM (Random): Press this pushbutton to hear the tracks in random, rather than sequential, order. RDM will appear on the display. Press this pushbutton again to turn off random play.

TRACK (Previous/Next Track): Turn this knob one notch to go to the start of the current track or to go to the next track. The track number will appear on the display. The player will continue moving backward or forward through the CD with each turn of the knob.

TUN (Forward/Reverse): Push and hold this knob to fast forward or to reverse through the current track.

AM/FM: Press this button to listen to the radio when a CD is playing. The inactive CD will remain safely inside the radio for future listening.

CD: Press this button to play a CD when listening to the radio. CDP will appear on the display when the CD player has been selected.

Press this button while a CD is playing to pause the CD. Track and the track number will flash on the display. Press this button again to start playing the CD.

▲ (Eject): Press this button to eject a CD. Eject may be activated with either the ignition or radio off.

Using an MP3 CD

MP3 Format

If this radio has MP3 capabilities, this MP3 player will accept MP3 files that were recorded on an up to 700 MB CD-R CD. The files can be recorded with the following fixed bit rates: 32 kbps, 40 kbps, 56 kbps, 64 kbps, 80 kbps, 96 kbps, 112 kbps, 128 kbps, 160 kbps, 192 kbps, 224 kbps, 256 kbps, and 320 kbps or a variable bit rate. Song title, artist name, and album will be available when recorded using ID3 tags versions 1 and 2.

The player will be able to read and play a maximum of 50 folders, 50 playlists, 10 sessions, and 255 files. Long file, folder, or playlist names or a combination of a large number of files and folders or playlists may cause the player to be unable to play up to the maximum number of files, folders, playlists, or sessions. If you wish to play large numbers of files, folders, playlists or sessions minimize the length of the file, folder or playlist name. You can also play an MP3 CD that was recorded using no file folders. The system can support up to 11 folders in depth, though, keep the depth of the folders to a minimum in order to keep down the complexity and confusion in trying to locate a particular folder during playback. If a CD contains more than the maximum of 50 folders, 50 playlists, 10 sessions, and 255 files the player will let you access and navigate up to the maximum, but all items over the maximum will be ignored.

Root Directory

The root directory will be treated as a folder. If the root directory has compressed audio files, the directory will be displayed as F1 ROOT. All files contained directly under the root directory will be accessed prior to any root directory folders. However, playlists (Px) will always be accessed before root folders or files.

Empty Directory or Folder

If a root directory or a folder exists somewhere in the file structure that contains only folders/subfolders and no compressed files directly beneath them, the player will advance to the next folder in the file structure that contains compressed audio files and the empty folder will not be displayed or numbered.

No Folder

When the CD contains only compressed files, the files will be located under the root folder. The next and previous folder functions will have no function on a CD that was recorded without folders or playlists. When displaying the name of the folder the radio will display ROOT.

When the CD contains only playlists and compressed audio files, but no folders, all files will be located under the root folder. The folder down and the folder up buttons will search playlists (Px) first and then go to the root folder. When the radio displays the name of the folder the radio will display ROOT.

Order of Play

Tracks will be played in the following order:

- Play will begin from the first track in the first playlist and will continue sequentially through all tracks in each playlist. When the last track of the last playlist has been played, play will continue from the first track of the first playlist.
- If the CD does not contain any playlists, then play will begin from the first track under the root directory. When all tracks from the root directory have been played, play will continue from files according to their numerical listing. After playing the last track from the last folder, play will begin again at the first track of the first folder or root directory.

When play enters a new folder, the display will not automatically show the new folder name unless you have chosen the folder mode as the default display, see DISPL later in this section. The new track name will be displayed.

File System and Naming

The song name that will be displayed will be the song name that is contained in the ID3 tag. If the song name is not present in the ID3 tag, then the radio will display the file name without the extension (such as .mp3) as the track name.

Track names longer than 32 characters or 4 pages will be shortened. The display will not show parts of words on the last page of text and the extension of the filename will not be displayed.

Preprogrammed Playlists

You can access preprogrammed playlists which were created by WinAmp™, MusicMatch™, or Real Jukebox™ software, however, you will not have editing capability. These playlists will be treated as special folders containing compressed audio song files.

Playing an MP3

With the ignition on, insert a CD partway into the slot, label side up. The player will pull it in, Loading, then Filecheck, then MP3 will appear on the display. The CD should begin playing. You can insert a CD with the ignition off.

As each new track starts to play, F001, the track number, and the song name will appear on the display.

If you turn off the ignition or radio with a CD in the player, it will stay in the player. When you turn on the ignition or radio, the CD will start playing where it stopped, if it was the last selected audio source.

The CD player can play the smaller 8cm single CDs with an adapter ring. Full-size CDs and the smaller CDs are loaded in the same manner.

If playing a CD-R the sound quality may be reduced due to CD-R quality, the method of recording, the quality of the music that has been recorded, and the way the CD-R has been handled. You may experience an increase in skipping, difficulty in finding tracks and/or difficulty in loading and ejecting. If these problems occur try a known good CD.

Do not add paper labels to CDs, they could get caught in the CD player.

Do not play 3 inch CDs without a standard adapter CD.

If an error appears on the display, see “CD Messages” later in this section.

All of the CD functions work the same while playing an MP3, except for those listed here. See “Playing a CD” earlier for more information.

5 DN (Down): Press this pushbutton to go to the previous directory.

6 UP: Press this pushbutton to go to the next directory.

TRACK (Previous/Next File): Turn this knob one notch to go to the first track in the previous or to go to the next folder. The player will continue moving backward or forward through the CD with each turn of the knob.

DIR (Directory): Press and release this button to repeat the tracks in the current directory. DIR will appear on the display.

Press and release this button twice to repeat the tracks in all of the directories. ALL will appear on the display.

Press and release this button again to turn off repeat play.

CD Messages

CHECK CD: If this message appears on the display and the CD comes out, it could be for one of the following reasons:

- It is very hot. When the temperature returns to normal, the CD should play.
- You are driving on a very rough road. When the road becomes smooth, the CD should play.
- The CD is dirty, scratched, wet, or upside down.
- The air is very humid. If so, wait about an hour and try again.
- The format of the CD may not be compatible. See “MP3 Format” earlier in this section.
- There may have been a problem while burning the CD.
- The label may be caught in the CD player.

If the CD is not playing correctly, for any other reason, try a known good CD.

If any error occurs repeatedly or if an error cannot be corrected, contact your dealer. If the radio displays an error message, write it down and provide it to your dealer when reporting the problem.

Theft-Deterrent Feature

The theft-deterrent system is designed to discourage theft of your radio. When the radio and vehicle are turned off, your radio has a blinking red light to indicate that the theft-deterrent system is activated.

The theft-deterrent system also activates when the audio system has been disconnected from the battery. When this occurs, the AF code and security code will have to be entered in order to operate your radio. An identification card stamped with the AF code and security code will be provided with the vehicle. Keep it in a safe place, not in the vehicle.

To enter the security code do the following:

1. Turn the ignition to ACC or ON.
2. Turn the radio on. AF or COdE will flash on the display. If AF flashes on the display, go to Step 2. If COdE flashes on the display, go to Step 4.
3. Enter the AF code by using the preset pushbuttons. COdE will flash on the display.
4. Enter the security code by using the preset pushbuttons. When the complete security code is entered, the code will flash three times.

If the security code is not entered correctly, Err will appear on the display for a few seconds. When COdE appears back on the display, repeat Step 4.

If the incorrect AF code is entered, an incorrect frequency level may be chosen and the radio reception may be affected. If this occurs, reset the audio system by removing and re-installing the AUDIO fuse. See "Instrument Panel Fuse Block" under *Fuses and Circuit Breakers* on page 5-85 for more information. Then repeat Steps 1 through 4.

Radio Reception

AM

The range for most AM stations is greater than for FM, especially at night. The longer range, however, can cause stations to interfere with each other. AM can pick up noise from things like storms and power lines. Try reducing the treble to reduce this noise.

FM

FM stereo will give you the best sound, but FM signals will reach only about 10 to 40 miles (16 to 65 km). Tall buildings or hills can interfere with FM signals, causing the sound to come and go.

Care of Your CDs

Handle CDs carefully. Store them in their original cases or other protective cases and away from direct sunlight and dust. If the surface of a CD is soiled, dampen a clean, soft cloth in a mild, neutral detergent solution and clean it, wiping from the center to the edge.

Be sure never to touch the side without writing when handling CDs. Pick up CDs by grasping the outer edges or the edge of the hole and the outer edge.

Care of Your CD Player

The use of CD lens cleaners for CD players is not advised, due to the risk of contaminating the lens of the CD optics with lubricants internal to the CD mechanism.

Backglass Antenna

The AM-FM antenna is integrated with the rear window defogger, located in the rear window. Be sure that the inside surface of the rear window is not scratched and that the lines on the glass are not damaged. If the inside surface is damaged, it could interfere with radio reception. Also, for proper radio reception, the antenna connector at the top-center of the rear window needs to be properly attached to the post on the glass.

Notice: Using a razor blade or sharp object to clear the inside rear window may damage the rear window antenna and/or the rear window defogger. Repairs would not be covered by your warranty. Do not clear the inside rear window with sharp objects.

Notice: Do not apply aftermarket glass tinting with metallic film. The metallic film in some tinting materials will interfere with or distort the incoming radio reception. Any damage caused to your backglass antenna due to metallic tinting materials will not be covered by your warranty.

Because this antenna is built into your rear window, there is a reduced risk of damage caused by car washes and vandals.

If you choose to add a cellular telephone to your vehicle, and the antenna needs to be attached to the glass, be sure that you do not damage the grid lines for the AM-FM antenna. There is enough space between the lines to attach a cellular telephone antenna without interfering with radio reception.

Do not apply aftermarket glass tinting to the back glass. The metallic film in some tinting materials will interfere with or distort the incoming radio reception. Care must be taken when cleaning the rear window because it breaks in the resistive material heating element and will adversely affect radio and defogger performance. See your dealer for details.

Section 4 Driving Your Vehicle

Your Driving, the Road, and Your Vehicle	4-2	Freeway Driving	4-20
Defensive Driving	4-2	Before Leaving on a Long Trip	4-21
Drunken Driving	4-3	Highway Hypnosis	4-22
Control of a Vehicle	4-6	Hill and Mountain Roads	4-22
Braking	4-6	Winter Driving	4-24
Steering	4-10	If You Are Stuck: In Sand, Mud, Ice or Snow	4-28
Off-Road Recovery	4-12	Towing	4-29
Passing	4-12	Towing Your Vehicle	4-29
Loss of Control	4-14	Recreational Vehicle Towing	4-29
Driving at Night	4-15	Loading Your Vehicle	4-32
Driving in Rain and on Wet Roads	4-16	Towing a Trailer	4-37
City Driving	4-19		

Your Driving, the Road, and Your Vehicle

Defensive Driving

The best advice anyone can give about driving is: Drive defensively.

Please start with a very important safety device in your vehicle: Buckle up. See *Safety Belts: They Are for Everyone* on page 1-10.

Defensive driving really means “be ready for anything.” On city streets, rural roads or freeways, it means “always expect the unexpected.”

Assume that pedestrians or other drivers are going to be careless and make mistakes. Anticipate what they might do. Be ready for their mistakes.

Rear-end collisions are about the most preventable of accidents. Yet they are common. Allow enough following distance. It is the best defensive driving maneuver, in both city and rural driving. You never know when the vehicle in front of you is going to brake or turn suddenly.

Defensive driving requires that a driver concentrate on the driving task. Anything that distracts from the driving task — such as concentrating on a cellular telephone call, reading, or reaching for something on the floor — makes proper defensive driving more difficult and can even cause a collision, with resulting injury. Ask a passenger to help do things like this, or pull off the road in a safe place to do them yourself. These simple defensive driving techniques could save your life.

Drunken Driving

Death and injury associated with drinking and driving is a national tragedy. It is the number one contributor to the highway death toll, claiming thousands of victims every year.

Alcohol affects four things that anyone needs to drive a vehicle:

- Judgment
- Muscular Coordination
- Vision
- Attentiveness.

Police records show that almost half of all motor vehicle-related deaths involve alcohol. In most cases, these deaths are the result of someone who was drinking and driving. In recent years, more than 16,000 annual motor vehicle-related deaths have been associated with the use of alcohol, with more than 300,000 people injured.

Many adults — by some estimates, nearly half the adult population — choose never to drink alcohol, so they never drive after drinking. For persons under 21, it is against the law in every U.S. state to drink alcohol. There are good medical, psychological and developmental reasons for these laws.

The obvious way to eliminate the leading highway safety problem is for people never to drink alcohol and then drive. But what if people do? How much is “too much” if someone plans to drive? It is a lot less than many might think. Although it depends on each person and situation, here is some general information on the problem.

The Blood Alcohol Concentration (BAC) of someone who is drinking depends upon four things:

- The amount of alcohol consumed
- The drinker's body weight
- The amount of food that is consumed before and during drinking
- The length of time it has taken the drinker to consume the alcohol.

According to the American Medical Association, a 180 lb (82 kg) person who drinks three 12 ounce (355 ml) bottles of beer in an hour will end up with a BAC of about 0.06 percent. The person would reach the same BAC by drinking three 4 ounce (120 ml) glasses of wine or three mixed drinks if each had 1-1/2 ounces (45 ml) of liquors like whiskey, gin or vodka.



It is the amount of alcohol that counts. For example, if the same person drank three double martinis (3 ounces or 90 ml of liquor each) within an hour, the person's BAC would be close to 0.12 percent. A person who consumes food just before or during drinking will have a somewhat lower BAC level.

There is a gender difference, too. Women generally have a lower relative percentage of body water than men. Since alcohol is carried in body water, this means that a woman generally will reach a higher BAC level than a man of her same body weight will when each has the same number of drinks.

The law in an increasing number of U.S. states, and throughout Canada, sets the legal limit at 0.08 percent. In some other countries, the limit is even lower. For example, it is 0.05 percent in both France and Germany. The BAC limit for all commercial drivers in the United States is 0.04 percent.

The BAC will be over 0.10 percent after three to six drinks (in one hour). Of course, as we have seen, it depends on how much alcohol is in the drinks, and how quickly the person drinks them.

But the ability to drive is affected well below a BAC of 0.10 percent. Research shows that the driving skills of many people are impaired at a BAC approaching 0.05 percent, and that the effects are worse at night. All drivers are impaired at BAC levels above 0.05 percent. Statistics show that the chance of being in a collision increases sharply for drivers who have a BAC of 0.05 percent or above. A driver with a BAC level of 0.06 percent has doubled his or her chance of having a collision. At a BAC level of 0.10 percent, the chance of this driver having a collision is 12 times greater; at a level of 0.15 percent, the chance is 25 times greater!

The body takes about an hour to rid itself of the alcohol in one drink. No amount of coffee or number of cold showers will speed that up. "I will be careful" is not the right answer. What if there is an emergency, a need to take sudden action, as when a child darts into the street? A person with even a moderate BAC might not be able to react quickly enough to avoid the collision.

There is something else about drinking and driving that many people do not know. Medical research shows that alcohol in a person's system can make crash injuries worse, especially injuries to the brain, spinal cord or heart. This means that when anyone who has been drinking — driver or passenger — is in a crash, that person's chance of being killed or permanently disabled is higher than if the person had not been drinking.

 **CAUTION:**

Drinking and then driving is very dangerous. Your reflexes, perceptions, attentiveness and judgment can be affected by even a small amount of alcohol. You can have a serious — or even fatal — collision if you drive after drinking. Please do not drink and drive or ride with a driver who has been drinking. Ride home in a cab; or if you are with a group, designate a driver who will not drink.

Control of a Vehicle

You have three systems that make your vehicle go where you want it to go. They are the brakes, the steering and the accelerator. All three systems have to do their work at the places where the tires meet the road.

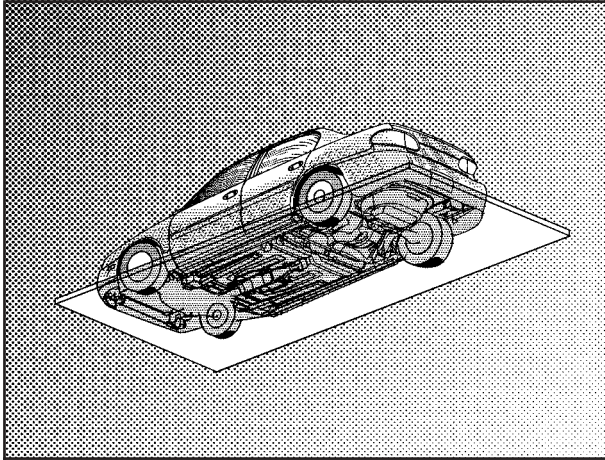

Sometimes, as when you are driving on snow or ice, it is easy to ask more of those control systems than the tires and road can provide. That means you can lose control of your vehicle.

Braking

Braking action involves *perception time* and *reaction time*.

First, you have to decide to push on the brake pedal. That is *perception time*. Then you have to bring up your foot and do it. That is *reaction time*.

Average *reaction time* is about 3/4 of a second. But that is only an average. It might be less with one driver and as long as two or three seconds or more with another. Age, physical condition, alertness, coordination and eyesight all play a part. So do alcohol, drugs and frustration. But even in 3/4 of a second, a vehicle moving at 60 mph (100 km/h) travels 66 feet (20 m). That could be a lot of distance in an emergency, so keeping enough space between your vehicle and others is important.

And, of course, actual stopping distances vary greatly with the surface of the road (whether it is pavement or gravel); the condition of the road (wet, dry, icy); tire tread; the condition of your brakes; the weight of the vehicle and the amount of brake force applied.

Avoid needless heavy braking. Some people drive in spurts – heavy acceleration followed by heavy braking — rather than keeping pace with traffic. This is a mistake. Your brakes may not have time to cool between hard stops. Your brakes will wear out much faster if you do a lot of heavy braking. If you keep pace with the traffic and allow realistic following distances, you will eliminate a lot of unnecessary braking. That means better braking and longer brake life.

If your engine ever stops while you are driving, brake normally but do not pump your brakes. If you do, the pedal may get harder to push down. If your engine stops, you will still have some power brake assist. But you will use it when you brake. Once the power assist is used up, it may take longer to stop and the brake pedal will be harder to push.

Anti-lock Brake System (ABS)

Your vehicle may have anti-lock brakes. ABS is an advanced electronic braking system that will help prevent a braking skid.

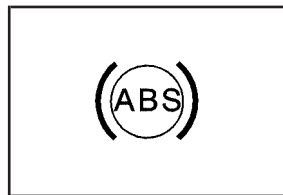

If your vehicle has anti-lock brakes, this warning light on the instrument panel will come on briefly when you start your vehicle.



Let us say the road is wet and you are driving safely. Suddenly, an animal jumps out in front of you. You slam on the brakes and continue braking. Here is what happens with ABS:

A computer senses that wheels are slowing down. If one of the wheels is about to stop rolling, the computer will separately work the brakes at each wheel.

The anti-lock system can change the brake pressure faster than any driver could. The computer is programmed to make the most of available tire and road conditions. This can help you steer around the obstacle while braking hard.



As you brake, your computer keeps receiving updates on wheel speed and controls braking pressure accordingly.

Remember: Anti-lock does not change the time you need to get your foot up to the brake pedal or always decrease stopping distance. If you get too close to the vehicle in front of you, you will not have time to apply your brakes if that vehicle suddenly slows or stops. Always leave enough room up ahead to stop, even though you have anti-lock brakes.

Using Anti-Lock

Do not pump the brakes. Just hold the brake pedal down firmly and let anti-lock work for you. You may feel a slight brake pedal pulsation or notice some noise, but this is normal.

Braking in Emergencies

At some time, nearly every driver gets into a situation that requires hard braking.

If you have anti-lock, you can steer and brake at the same time. However, if you do not have anti-lock, your first reaction — to hit the brake pedal hard and hold it down — may be the wrong thing to do. Your wheels

can stop rolling. Once they do, the vehicle can not respond to your steering. Momentum will carry it in whatever direction it was headed when the wheels stopped rolling. That could be off the road, into the very thing you were trying to avoid, or into traffic.

If you do not have anti-lock, use a “squeeze” braking technique. This will give you maximum braking while maintaining steering control. You can do this by pushing on the brake pedal with steadily increasing pressure.

In an emergency, you will probably want to squeeze the brakes hard without locking the wheels. If you hear or feel the wheels sliding, ease off the brake pedal.

This will help you retain steering control. If you *do* have anti-lock, it is different. See “Anti-Lock Brake System” in this section.

In many emergencies, steering can help you more than even the very best braking.

Steering

Power Steering

If you lose power steering assist because the engine stops or the system is not functioning, you can steer but it will take much more effort.

Steering Tips

Driving on Curves

It is important to take curves at a reasonable speed.

A lot of the “driver lost control” accidents mentioned on the news happen on curves.

Here is why:

Experienced driver or beginner, each of us is subject to the same laws of physics when driving on curves. The traction of the tires against the road surface makes it possible for the vehicle to change its path when you turn the front wheels. If there is no traction, inertia will keep the vehicle going in the same direction. If you have ever tried to steer a vehicle on wet ice, you will understand this.

The traction you can get in a curve depends on the condition of your tires and the road surface, the angle at which the curve is banked, and your speed. While you are in a curve, speed is the one factor you can control.

Suppose you are steering through a sharp curve. Then you suddenly apply the brakes. Both control systems — steering and braking — have to do their work where the tires meet the road. Unless you have four-wheel anti-lock brakes, adding the hard braking can demand too much of those places. You can lose control.

The same thing can happen if you are steering through a sharp curve and you suddenly accelerate. Those two control systems — steering and acceleration — can overwhelm those places where the tires meet the road and make you lose control.

What should you do if this ever happens? Ease up on the brake or accelerator pedal, steer the vehicle the way you want it to go, and slow down.

Speed limit signs near curves warn that you should adjust your speed. Of course, the posted speeds are based on good weather and road conditions. Under less favorable conditions you will want to go slower.

If you need to reduce your speed as you approach a curve, do it before you enter the curve, while your front wheels are straight ahead.

Try to adjust your speed so you can “drive” through the curve. Maintain a reasonable, steady speed. Wait to accelerate until you are out of the curve, and then accelerate gently into the straightaway.

Steering in Emergencies

There are times when steering can be more effective than braking. For example, you come over a hill and find a truck stopped in your lane, or a car suddenly pulls out from nowhere, or a child darts out from between parked cars and stops right in front of you. You can avoid these problems by braking — if you can stop in time. But sometimes you can not; there is not room. That is the time for evasive action — steering around the problem.

Your vehicle can perform very well in emergencies like these. First apply your brakes — but, unless you have anti-lock, not enough to lock your wheels.

See *Braking on page 4-6*. It is better to remove as much speed as you can from a possible collision. Then steer around the problem, to the left or right depending on the space available.

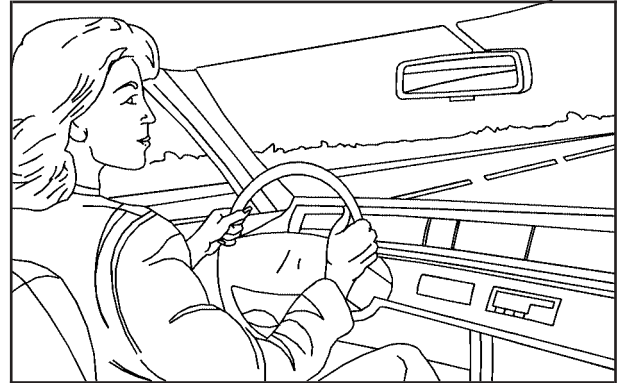

An emergency like this requires close attention and a quick decision. If you are holding the steering wheel at the recommended 9 and 3 o'clock positions, you can turn it a full 180 degrees very quickly without removing either hand. But you have to act fast, steer quickly, and just as quickly straighten the wheel once you have avoided the object.

The fact that such emergency situations are always possible is a good reason to practice defensive driving at all times and wear safety belts properly.

Off-Road Recovery

You may find that your right wheels have dropped off the edge of a road onto the shoulder while you're driving.

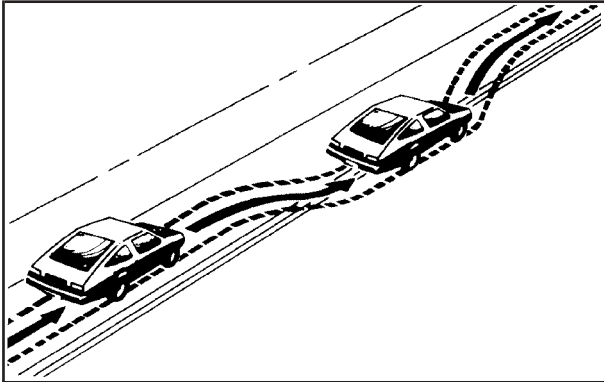

If the level of the shoulder is only slightly below the pavement, recovery should be fairly easy. Ease off the accelerator and then, if there is nothing in the way, steer so that your vehicle straddles the edge of the pavement. You can turn the steering wheel up to one-quarter turn until the right front tire contacts the pavement edge. Then turn your steering wheel to go straight down the roadway.

Passing

The driver of a vehicle about to pass another on a two-lane highway waits for just the right moment, accelerates, moves around the vehicle ahead, then goes back into the right lane again. A simple maneuver?

Not necessarily! Passing another vehicle on a two-lane highway is a potentially dangerous move, since the passing vehicle occupies the same lane as oncoming traffic for several seconds. A miscalculation, an error in judgment, or a brief surrender to frustration or anger can suddenly put the passing driver face to face with the worst of all traffic accidents — the head-on collision.

So here are some tips for passing:

- “Drive ahead.” Look down the road, to the sides and to crossroads for situations that might affect your passing patterns. If you have any doubt whatsoever about making a successful pass, wait for a better time.
- Watch for traffic signs, pavement markings and lines. If you can see a sign up ahead that might indicate a turn or an intersection, delay your pass. A broken center line usually indicates it is all right to pass (providing the road ahead is clear). Never cross a solid line on your side of the lane or a double solid line, even if the road seems empty of approaching traffic.

- Do not get too close to the vehicle you want to pass while you are awaiting an opportunity. For one thing, following too closely reduces your area of vision, especially if you are following a larger vehicle. Also, you will not have adequate space if the vehicle ahead suddenly slows or stops. Keep back a reasonable distance.
- When it looks like a chance to pass is coming up, start to accelerate but stay in the right lane and do not get too close. Time your move so you will be increasing speed as the time comes to move into the other lane. If the way is clear to pass, you will have a “running start” that more than makes up for the distance you would lose by dropping back. And if something happens to cause you to cancel your pass, you need only slow down and drop back again and wait for another opportunity.
- If other vehicles are lined up to pass a slow vehicle, wait your turn. But take care that someone is not trying to pass you as you pull out to pass the slow vehicle. Remember to glance over your shoulder and check the blind spot.
- Check your mirrors, glance over your shoulder, and start your left lane change signal before moving out of the right lane to pass. When you are far enough ahead of the passed vehicle to see its front in your inside mirror, activate your right lane change signal and move back into the right lane. (Remember that your right outside mirror is convex. The vehicle you just passed may seem to be farther away from you than it really is.)
- Try not to pass more than one vehicle at a time on two-lane roads. Reconsider before passing the next vehicle.
- Do not overtake a slowly moving vehicle too rapidly. Even though the brake lamps are not flashing, it may be slowing down or starting to turn.
- If you are being passed, make it easy for the following driver to get ahead of you. Perhaps you can ease a little to the right.

Loss of Control

Let us review what driving experts say about what happens when the three control systems (brakes, steering and acceleration) do not have enough friction where the tires meet the road to do what the driver has asked.

In any emergency, do not give up. Keep trying to steer and constantly seek an escape route or area of less danger.

Skidding

In a skid, a driver can lose control of the vehicle. Defensive drivers avoid most skids by taking reasonable care suited to existing conditions, and by not “overdriving” those conditions. But skids are always possible.

The three types of skids correspond to your vehicle’s three control systems. In the braking skid, your wheels are not rolling. In the steering or cornering skid, too much speed or steering in a curve causes tires to slip and lose cornering force. And in the acceleration skid, too much throttle causes the driving wheels to spin.

A cornering skid is best handled by easing your foot off the accelerator pedal

If your vehicle starts to slide, ease your foot off the accelerator pedal and quickly steer the way you want the vehicle to go. If you start steering quickly enough, your vehicle may straighten out. Always be ready for a second skid if it occurs.

Of course, traction is reduced when water, snow, ice, gravel or other material is on the road. For safety, you will want to slow down and adjust your driving to these conditions. It is important to slow down on slippery surfaces because stopping distance will be longer and vehicle control more limited.

While driving on a surface with reduced traction, try your best to avoid sudden steering, acceleration or braking (including engine braking by shifting to a lower gear). Any sudden changes could cause the tires to slide. You may not realize the surface is slippery until your vehicle is skidding. Learn to recognize warning clues — such as enough water, ice or packed snow on the road to make a “mirrored surface” — and slow down when you have any doubt.

If you have the anti-lock braking system, remember: It helps avoid only the braking skid. If you do not have anti-lock, then in a braking skid (where the wheels are no longer rolling), release enough pressure on the brakes to get the wheels rolling again. This restores steering control. Push the brake pedal down steadily when you have to stop suddenly. As long as the wheels are rolling, you will have steering control.

Driving at Night

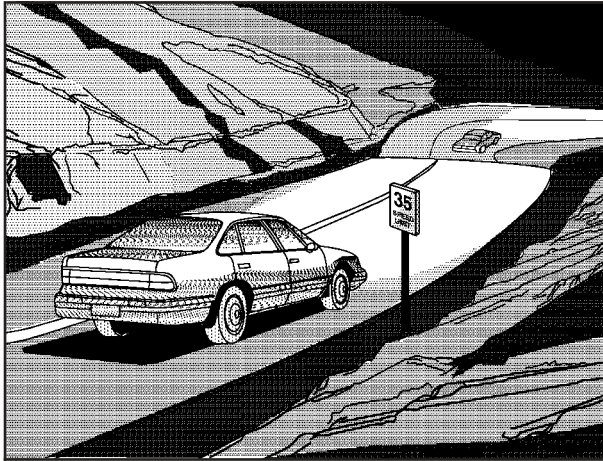

Night driving is more dangerous than day driving. One reason is that some drivers are likely to be impaired — by alcohol or drugs, with night vision problems, or by fatigue.

Here are some tips on night driving.

- Drive defensively.
- Do not drink and drive.
- Adjust your inside rearview mirror to reduce the glare from headlamps behind you.
- Since you can not see as well, you may need to slow down and keep more space between you and other vehicles.
- Slow down, especially on higher speed roads. Your headlamps can light up only so much road ahead.
- In remote areas, watch for animals.
- If you are tired, pull off the road in a safe place and rest.

No one can see as well at night as in the daytime. But as we get older these differences increase. A 50-year-old driver may require at least twice as much light to see the same thing at night as a 20-year-old.

What you do in the daytime can also affect your night vision. For example, if you spend the day in bright sunshine you are wise to wear sunglasses. Your eyes will have less trouble adjusting to night. But if you are driving, do not wear sunglasses at night. They may cut down on glare from headlamps, but they also make a lot of things invisible.

Driving in Rain and on Wet Roads

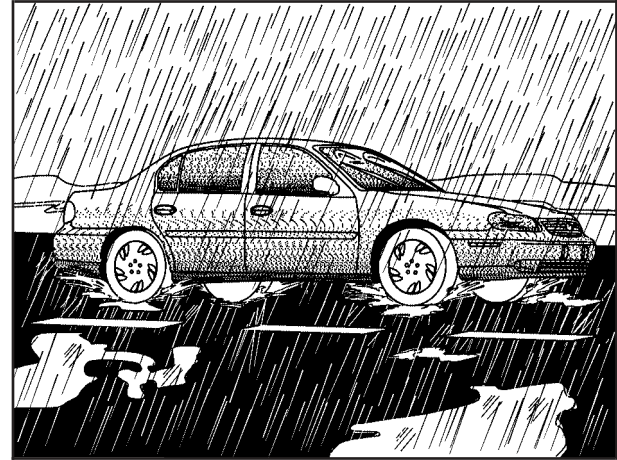

You can be temporarily blinded by approaching headlamps. It can take a second or two, or even several seconds, for your eyes to readjust to the dark. When you are faced with severe glare (as from a driver who does not lower the high beams, or a vehicle with misaimed headlamps), slow down a little. Avoid staring directly into the approaching headlamps.

Keep your windshield and all the glass on your vehicle clean — inside and out. Glare at night is made much worse by dirt on the glass. Even the inside of the glass can build up a film caused by dust. Dirty glass makes lights dazzle and flash more than clean glass would, making the pupils of your eyes contract repeatedly.

Remember that your headlamps light up far less of a roadway when you are in a turn or curve. Keep your eyes moving; that way, it is easier to pick out dimly lighted objects. Just as your headlamps should be checked regularly for proper aim, so should your eyes be examined regularly. Some drivers suffer from night blindness — the inability to see in dim light — and are not even aware of it.

Rain and wet roads can mean driving trouble. On a wet road, you can not stop, accelerate or turn as well because your tire-to-road traction is not as good as on dry roads. And, if your tires do not have much tread left, you will get even less traction. It is always wise to go slower and be cautious if rain starts to fall while you are driving. The surface may get wet suddenly when your reflexes are tuned for driving on dry pavement.

The heavier the rain, the harder it is to see. Even if your windshield wiper blades are in good shape, a heavy rain can make it harder to see road signs and traffic signals, pavement markings, the edge of the road and even people walking.

It is wise to keep your windshield wiping equipment in good shape and keep your windshield washer tank filled with washer fluid. Replace your windshield wiper inserts when they show signs of streaking or missing areas on the windshield, or when strips of rubber start to separate from the inserts.

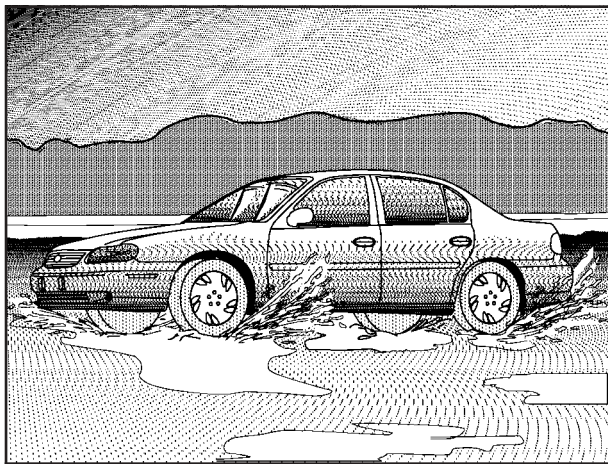

Driving too fast through large water puddles or even going through some car washes can cause problems, too. The water may affect your brakes. Try to avoid puddles. But if you can not, try to slow down before you hit them.

⚠ CAUTION:

Wet brakes can cause accidents. They will not work as well in a quick stop and may cause pulling to one side. You could lose control of the vehicle.

After driving through a large puddle of water or a car wash, apply your brake pedal lightly until your brakes work normally.

Hydroplaning

Hydroplaning is dangerous. So much water can build up under your tires that they can actually ride on the water. This can happen if the road is wet enough and you are going fast enough. When your vehicle is hydroplaning, it has little or no contact with the road.

Hydroplaning does not happen often. But it can if your tires do not have much tread or if the pressure in one or more is low. It can happen if a lot of water is standing on the road. If you can see reflections from trees, telephone poles or other vehicles, and raindrops “dimple” the water’s surface, there could be hydroplaning.

Hydroplaning usually happens at higher speeds. There just is not a hard and fast rule about hydroplaning. The best advice is to slow down when it is raining.

Driving Through Deep Standing Water

Notice: If you drive too quickly through deep puddles or standing water, water can come in through your engine’s air intake and badly damage your engine. Never drive through water that is slightly lower than the underbody of your vehicle. If you can not avoid deep puddles or standing water, drive through them very slowly.

Driving Through Flowing Water

CAUTION:

Flowing or rushing water creates strong forces. If you try to drive through flowing water, as you might at a low water crossing, your vehicle can be carried away. As little as six inches of flowing water can carry away a smaller vehicle. If this happens, you and other vehicle occupants could drown. Do not ignore police warning signs, and otherwise be very cautious about trying to drive through flowing water.

Some Other Rainy Weather Tips

- Besides slowing down, allow some extra following distance. And be especially careful when you pass another vehicle. Allow yourself more clear room ahead, and be prepared to have your view restricted by road spray.
- Have good tires with proper tread depth. See *Tires on page 5-51*.

City Driving



One of the biggest problems with city streets is the amount of traffic on them. You will want to watch out for what the other drivers are doing and pay attention to traffic signals.

Here are ways to increase your safety in city driving:

- Know the best way to get to where you are going. Get a city map and plan your trip into an unknown part of the city just as you would for a cross-country trip.
- Try to use the freeways that rim and crisscross most large cities. You will save time and energy. See *Freeway Driving on page 4-20*.
- Treat a green light as a warning signal. A traffic light is there because the corner is busy enough to need it. When a light turns green, and just before you start to move, check both ways for vehicles that have not cleared the intersection or may be running the red light.

Freeway Driving



Mile for mile, freeways (also called thruways, parkways, expressways, turnpikes or superhighways) are the safest of all roads. But they have their own special rules.

The most important advice on freeway driving is: Keep up with traffic and keep to the right. Drive at the same speed most of the other drivers are driving. Too-fast or too-slow driving breaks a smooth traffic flow. Treat the left lane on a freeway as a passing lane.

At the entrance, there is usually a ramp that leads to the freeway. If you have a clear view of the freeway as you drive along the entrance ramp, you should begin to check traffic. Try to determine where you expect to blend with the flow. Try to merge into the gap at close to the prevailing speed. Switch on your turn signal, check your mirrors and glance over your shoulder as often as necessary. Try to blend smoothly with the traffic flow.

Once you are on the freeway, adjust your speed to the posted limit or to the prevailing rate if it is slower. Stay in the right lane unless you want to pass.

Before changing lanes, check your mirrors. Then use your turn signal.

Just before you leave the lane, glance quickly over your shoulder to make sure there is not another vehicle in your “blind” spot.

Once you are moving on the freeway, make certain you allow a reasonable following distance.

Expect to move slightly slower at night.

When you want to leave the freeway, move to the proper lane well in advance. If you miss your exit, do not, under any circumstances, stop and back up. Drive on to the next exit.

The exit ramp can be curved, sometimes quite sharply. The exit speed is usually posted. Reduce your speed according to your speedometer, not to your sense of motion. After driving for any distance at higher speeds, you may tend to think you are going slower than you actually are.

Before Leaving on a Long Trip

Make sure you are ready. Try to be well rested. If you must start when you are not fresh — such as after a day's work — do not plan to make too many miles that first part of the journey. Wear comfortable clothing and shoes you can easily drive in.

Is your vehicle ready for a long trip? If you keep it serviced and maintained, it is ready to go. If it needs service, have it done before starting out. Of course, you will find experienced and able service experts in GM dealerships all across North America. They will be ready and willing to help if you need it.

Here are some things you can check before a trip:

- *Windshield Washer Fluid:* Is the reservoir full? Are all windows clean inside and outside?
- *Wiper Blades:* Are they in good shape?
- *Fuel, Engine Oil, Other Fluids:* Have you checked all levels?
- *Lamps:* Are they all working? Are the lenses clean?
- *Tires:* They are vitally important to a safe, trouble-free trip. Is the tread good enough for long-distance driving? Are the tires all inflated to the recommended pressure?
- *Weather Forecasts:* What is the weather outlook along your route? Should you delay your trip a short time to avoid a major storm system?
- *Maps:* Do you have up-to-date maps?

Highway Hypnosis

Is there actually such a condition as “highway hypnosis”? Or is it just plain falling asleep at the wheel? Call it highway hypnosis, lack of awareness, or whatever.

There is something about an easy stretch of road with the same scenery, along with the hum of the tires on the road, the drone of the engine, and the rush of the wind against the vehicle that can make you sleepy. Do not let it happen to you! If it does, your vehicle can leave the road in *less than a second*, and you could crash and be injured.

What can you do about highway hypnosis? First, be aware that it can happen.

Then here are some tips:

- Make sure your vehicle is well ventilated, with a comfortably cool interior.
- Keep your eyes moving. Scan the road ahead and to the sides. Check your rearview mirrors and your instruments frequently.
- If you get sleepy, pull off the road into a rest, service or parking area and take a nap, get some exercise, or both. For safety, treat drowsiness on the highway as an emergency.

Hill and Mountain Roads



Driving on steep hills or mountains is different from driving in flat or rolling terrain.

If you drive regularly in steep country, or if you are planning to visit there, here are some tips that can make your trips safer and more enjoyable.

- Keep your vehicle in good shape. Check all fluid levels and also the brakes, tires, cooling system and transaxle. These parts can work hard on mountain roads.
- Know how to go down hills. The most important thing to know is this: let your engine do some of the slowing down. Shift to a lower gear when you go down a steep or long hill.

 **CAUTION:**

If you do not shift down, your brakes could get so hot that they would not work well. You would then have poor braking or even none going down a hill. You could crash. Shift down to let your engine assist your brakes on a steep downhill slope.

 **CAUTION:**

Coasting downhill in NEUTRAL (N) or with the ignition off is dangerous. Your brakes will have to do all the work of slowing down. They could get so hot that they would not work well. You would then have poor braking or even none going down a hill. You could crash. Always have your engine running and your vehicle in gear when you go downhill.

- Know how to go uphill. Drive in the highest gear possible.
- Stay in your own lane when driving on two-lane roads in hills or mountains. Do not swing wide or cut across the center of the road. Drive at speeds that let you stay in your own lane.
- As you go over the top of a hill, be alert. There could be something in your lane, like a stalled car or an accident.
- You may see highway signs on mountains that warn of special problems. Examples are long grades, passing or no-passing zones, a falling rocks area or winding roads. Be alert to these and take appropriate action.

Winter Driving



Here are some tips for winter driving:

- Have your vehicle in good shape for winter.
- You may want to put winter emergency supplies in your trunk.

Also see *Tires* on page 5-51.



Include an ice scraper, a small brush or broom, a supply of windshield washer fluid, a rag, some winter outer clothing, a small shovel, a flashlight, a red cloth and a couple of reflective warning triangles. And, if you will be driving under severe conditions, include a small bag of sand, a piece of old carpet or a couple of burlap bags to help provide traction. Be sure you properly secure these items in your vehicle.

Driving on Snow or Ice

Most of the time, those places where your tires meet the road probably have good traction.

However, if there is snow or ice between your tires and the road, you can have a very slippery situation. You will have a lot less traction or “grip” and will need to be very careful.

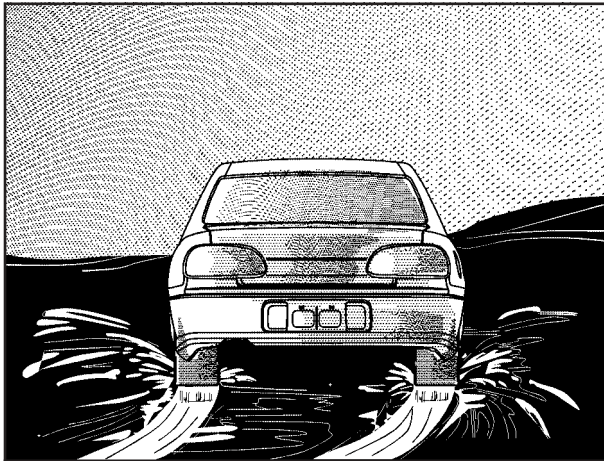

What is the worst time for this? “Wet ice.” Very cold snow or ice can be slick and hard to drive on. But wet ice can be even more trouble because it may offer the least traction of all. You can get wet ice when it is about freezing (32°F; 0°C) and freezing rain begins to fall. Try to avoid driving on wet ice until salt and sand crews can get there.

Whatever the condition — smooth ice, packed, blowing or loose snow — drive with caution.

Accelerate gently. Try not to break the fragile traction. If you accelerate too fast, the drive wheels will spin and polish the surface under the tires even more.

Unless you have the anti-lock braking system, you will want to brake very gently, too. (If you do have anti-lock, see *Braking on page 4-6*. This system improves your vehicle’s stability when you make a hard stop on a slippery road.) Whether you have the anti-lock braking system or not, you will want to begin stopping sooner than you would on dry pavement. Without anti-lock brakes, if you feel your vehicle begin to slide, let up on the brakes a little. Push the brake pedal down steadily to get the most traction you can.

Remember, unless you have anti-lock, if you brake so hard that your wheels stop rolling, you will just slide. Brake so your wheels always keep rolling and you can still steer.

- Whatever your braking system, allow greater following distance on any slippery road.
- Watch for slippery spots. The road might be fine until you hit a spot that is covered with ice. On an otherwise clear road, ice patches may appear in shaded areas where the sun can not reach: around clumps of trees, behind buildings or under bridges. Sometimes the surface of a curve or an overpass may remain icy when the surrounding roads are clear. If you see a patch of ice ahead of you, brake before you are on it. Try not to brake while you are actually on the ice, and avoid sudden steering maneuvers.

If You Are Caught in a Blizzard

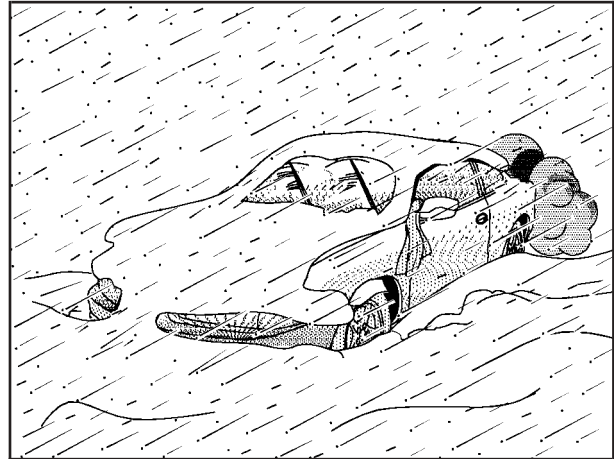

If you are stopped by heavy snow, you could be in a serious situation. You should probably stay with your vehicle unless you know for sure that you are near help and you can hike through the snow.

Here are some things to do to summon help and keep yourself and your passengers safe:

- Turn on your hazard flashers.
- Tie a red cloth to your vehicle to alert police that you have been stopped by the snow.
- Put on extra clothing or wrap a blanket around you. If you have no blankets or extra clothing, make body insulators from newspapers, burlap bags, rags, floor mats — anything you can wrap around yourself or tuck under your clothing to keep warm.

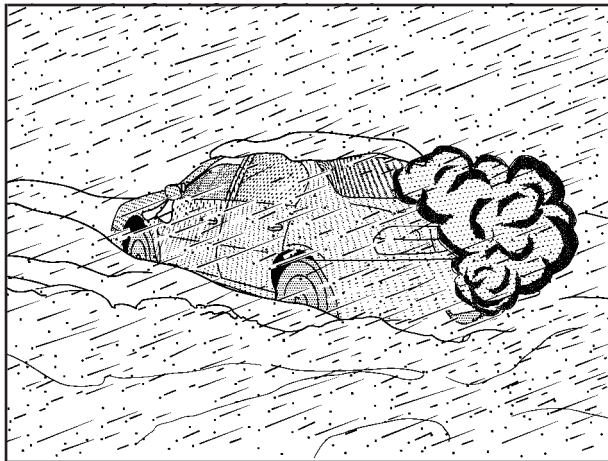

You can run the engine to keep warm, but be careful.

⚠ CAUTION:

Snow can trap exhaust gases under your vehicle. This can cause deadly CO (carbon monoxide) gas to get inside. CO could overcome you and kill you. You can not see it or smell it, so you might not know it is in your vehicle. Clear away snow from around the base of your vehicle, especially any that is blocking your exhaust pipe. And check around again from time to time to be sure snow does not collect there.

Open a window just a little on the side of the vehicle that is away from the wind. This will help keep CO out.

Run your engine only as long as you must. This saves fuel. When you run the engine, make it go a little faster than just idle. That is, push the accelerator slightly. This uses less fuel for the heat that you get and it keeps the battery charged. You will need a well-charged battery to restart the vehicle, and possibly for signaling later on with your headlamps. Let the heater run for a while.

Then, shut the engine off and close the window almost all the way to preserve the heat. Start the engine again and repeat this only when you feel really uncomfortable from the cold. But do it as little as possible. Preserve the fuel as long as you can. To help keep warm, you can get out of the vehicle and do some fairly vigorous exercises every half hour or so until help comes.

If You Are Stuck: In Sand, Mud, Ice or Snow

In order to free your vehicle when it is stuck, you will need to spin the wheels, but you do not want to spin your wheels too fast. The method known as “rocking” can help you get out when you are stuck, but you must use caution.

CAUTION:

If you let your tires spin at high speed, they can explode, and you or others could be injured. And, the transaxle or other parts of the vehicle can overheat. That could cause an engine compartment fire or other damage. When you are stuck, spin the wheels as little as possible. Do not spin the wheels above 35 mph (55 km/h) as shown on the speedometer.

Notice: Spinning your wheels can destroy parts of your vehicle as well as the tires. If you spin the wheels too fast while shifting your transaxle back and forth, you can destroy your transaxle. See “Rocking Your Vehicle To Get It Out.”

For information about using tire chains on your vehicle, see *Tire Chains* on page 5-66.

Rocking Your Vehicle To Get It Out

First, turn your steering wheel left and right. That will clear the area around your front wheels. Then shift back and forth between REVERSE (R) and a forward gear (or with a manual transaxle, between FIRST (1) or SECOND (2) and REVERSE (R)), spinning the wheels as little as possible. Release the accelerator pedal while you shift, and press lightly on the accelerator pedal when the transaxle is in gear. By slowly spinning your wheels in the forward and reverse directions, you will cause a rocking motion that may free your vehicle. If that does not get you out after a few tries, you may need to be towed out. If you do need to be towed out, see *Towing Your Vehicle* on page 4-29.

Towing

Towing Your Vehicle

Consult your dealer or a professional towing service if you need to have your disabled vehicle towed. See *Roadside Assistance Program* on page 7-6.

If you want to tow your vehicle behind another vehicle for recreational purposes (such as behind a motorhome), see “Recreational Vehicle Towing” following.

Recreational Vehicle Towing

Recreational vehicle towing means towing your vehicle behind another vehicle, such as behind a motorhome. The two most common types of recreational vehicle towing are known as “dinghy towing” (towing your vehicle with all four wheels on the ground) and “dolly towing” (towing your vehicle with two wheels on the ground and two wheels up on a device known as a “dolly”).

With the proper preparation and equipment, many vehicles can be towed in these ways. See “Dinghy Towing” and “Dolly Towing,” following.

Here are some important things to consider before you do recreational vehicle towing:

- What is the towing capacity of the towing vehicle? Be sure you read the tow vehicle manufacturer's recommendations.
- How far will you tow? Some vehicles have restrictions on how far and how long they can tow.
- Do you have the proper towing equipment? See your dealer or trailering professional for additional advice and equipment recommendations.
- Is your vehicle ready to be towed? Just as you would prepare your vehicle for a long trip, you will want to make sure your vehicle is prepared to be towed. See *Before Leaving on a Long Trip on page 4-21*.

Dinghy Towing

Notice: If you tow your vehicle with all four wheels on the ground, the drivetrain components could be damaged. The repairs would not be covered by your warranty. Do not tow your vehicle with all four wheels on the ground.

Your vehicle was not designed to be towed with all four wheels on the ground. If your vehicle must be towed, you should use a dolly. See "Dolly Towing" that follows for more information.

Dolly Towing

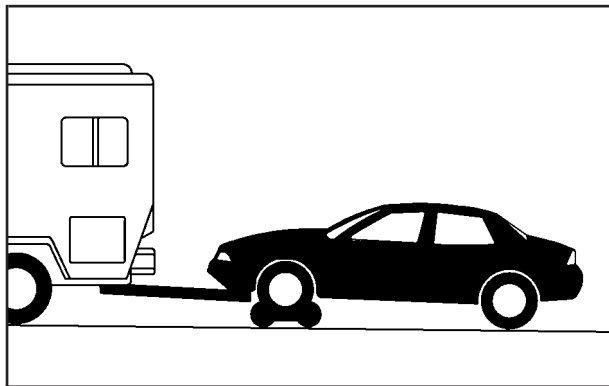

Notice: Towing your vehicle from the rear with the front wheels on the ground could cause transaxle damage. Do not tow the vehicle from the rear with the front wheels on the road.

Your vehicle can be towed using a dolly. To tow your vehicle using a dolly, follow these steps:

1. Put the front wheels on a dolly.
2. Turn the ignition to ACC.
3. Put the vehicle in NEUTRAL.
4. Set the parking brake and then remove the key.
5. Clamp the steering wheel in a straight-ahead position.
6. Release the parking brake.

Loading Your Vehicle

It is very important to know how much weight your vehicle can carry. This weight is called the vehicle capacity weight or maximum load amount and includes the weight of all occupants, cargo and all nonfactory-installed options. Two labels on your vehicle show how much weight it may properly carry, the Tire and Loading Information label and the Certification label.

CAUTION:

Do not load your vehicle any heavier than the GVWR, or either the maximum front or rear GAWR. If you do, parts on your vehicle can break, and it can change the way your vehicle handles. These could cause you to lose control and crash. Also, overloading can shorten the life of your vehicle.

Tire and Loading Information Label

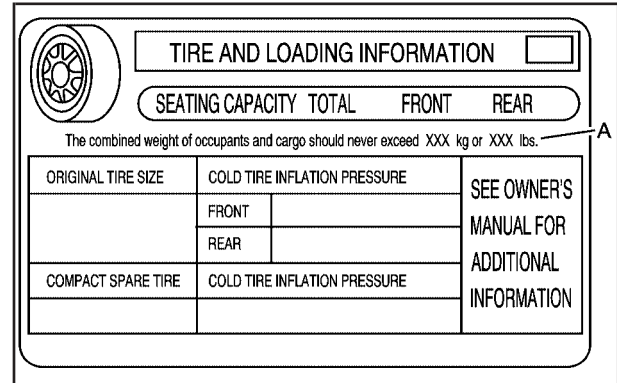

The diagram shows a rectangular label with rounded corners. On the left side, there is a circular icon of a tire. To the right of the tire icon is a box labeled "TIRE AND LOADING INFORMATION". Below this box is a row of three boxes labeled "SEATING CAPACITY TOTAL", "FRONT", and "REAR". Below these boxes is a line of text: "The combined weight of occupants and cargo should never exceed XXX kg or XXX lbs." with a small box labeled "A" pointing to it. Below the text is a table with two main columns: "ORIGINAL TIRE SIZE" and "COLD TIRE INFLATION PRESSURE". The "COLD TIRE INFLATION PRESSURE" column is further divided into "FRONT" and "REAR" sub-columns. Below the table is a row labeled "COMPACT SPARE TIRE" and "COLD TIRE INFLATION PRESSURE". To the right of the table is a vertical box labeled "SEE OWNER'S MANUAL FOR ADDITIONAL INFORMATION".

ORIGINAL TIRE SIZE	COLD TIRE INFLATION PRESSURE		SEE OWNER'S MANUAL FOR ADDITIONAL INFORMATION
	FRONT		
	REAR		
COMPACT SPARE TIRE	COLD TIRE INFLATION PRESSURE		

Example 1 - United States

A. Vehicle Capacity Weight

RECOMMENDED TIRE SIZE AND INFLATION PRESSURE (COLD) DIMENSIONS DES PNEUS et PRESSIONS DE CONFLAGE RECOMMANDÉES (à froid)				
MAXIMUM LOAD CARGE MAXIMALE	OCCUPANTS OCCUPANTS	DISTRIBUTION FRONT AVANT		RÉPARTITION REAR ARRIÈRE
				LUGGAGE BAGAGES
TOTAL LOAD - OCCUPANTS PLUS LUGGAGE		CHARGE GLOBALE - OCCUPANTS PLUS BAGAGES		
TIRE SIZE DIMENSIONS DES PNEUS		PRESSURE FRONT AVANT		PRESSION REAR ARRIÈRE
SEE OWNER'S MANUAL FOR ADDITIONAL INFORMATION VOIR MANUEL DE CONDUCTEUR POUR DES INFORMATIONS SUPPLÉMENTAIRES				

Example 2 - Canada

The Tire and Loading Information label shows your vehicle's seating capacity, the total weight it can properly carry and the original equipment tire size and the recommended cold tire inflation pressure for those tires. For more information on tires and inflation see *Tires on page 5-51* and *Inflation - Tire Pressure on page 5-59*.

If your vehicle was purchased in the United States, the Tire and Loading Information label, Example 1, is attached to the driver's side, center pillar, below the door latch. Vehicles purchased in Canada, will find the Tire and Loading Information label, Example 2, attached to the inside of the glove compartment.

There is also important loading information on the Certification label. It tells you the Gross Vehicle Weight Rating (GVWR) and the Gross Axle Weight Rating (GAWR) for the front and rear axle; see "Certification Label" later in this section.

Steps for Determining Correct Load Limit

1. If your vehicle has the Tire and Loading Information label, Example 1, locate the Vehicle Capacity Weight ". If your vehicle has the Tire and Loading Information label, Example 2, locate the "Maximum Load" amount.
2. Determine the combined weight of the driver and passengers that will be riding in your vehicle.
3. Subtract the combined weight of the driver and passengers from Vehicle Capacity Weight (Example 1-United States) or subtract the combined weight of the driver and passengers from Maximum Load (Example 2-Canada).
4. The resulting figure equals the available amount of cargo and luggage load capacity. For example, if the Vehicle Capacity Weight or the Maximum Load amount equals 1400 lbs. (635 kg) and there will be five 150 lb. (68 kg) passengers in your vehicle, the amount of available cargo and luggage load capacity is 650 lbs. (295 kg).
5. Determine the combined weight of luggage and cargo being loaded on the vehicle. That weight may not safely exceed the available cargo and luggage load capacity calculated in Step 4.

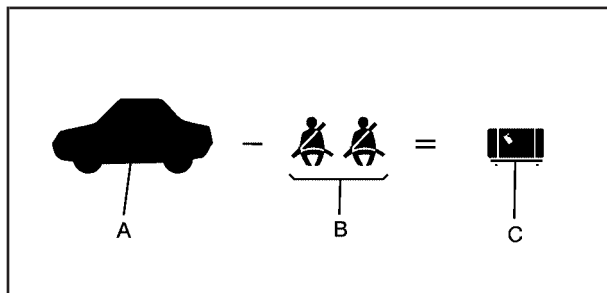

Example 1

Loading Your Vehicle

Item	Description	Total
A	Vehicle Capacity Weight or Maximum Load, for Example 1 =	1,000 lbs (453 kg)
B	Subtract Occupant Weight 150 lbs (68 kg) × 2 =	300 lbs (136 kg)
C	Available Occupant and Cargo Weight =	700 lbs (317 kg)

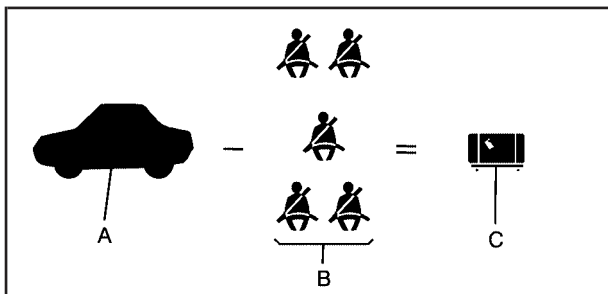

Example 2

Loading Your Vehicle

Item	Description	Total
A	Vehicle Capacity Weight or Maximum Load for Example 2 =	1,000 lbs (453 kg)
B	Subtract Occupant Weight 150 lbs (68 kg) × 5 =	750 lbs (340 kg)
C	Available Cargo Weight =	250 lbs (113 kg)

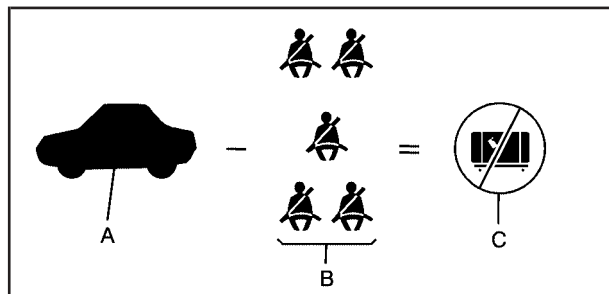

Example 3

Loading Your Vehicle

Item	Description	Total
A	Vehicle Capacity Weight or Maximum Load for Example 3 =	1,000 lbs (453 kg)
B	Subtract Occupant Weight 200 lbs (91 kg) × 5 =	1,000 lbs (453 kg)
C	Available Cargo Weight =	0 lbs (0 kg)

Refer to your vehicle's Tire and Loading Information label for specific information about your vehicle's capacity weight and seating positions. The combined weight of the driver, passengers, and cargo should never exceed your vehicle's capacity weight or maximum load weight.

Certification Label

MFD. BY GM DAEWOO Auto & Technology Company
REPUBLIC OF KOREA

DATE	GVWR	GAWR FRT	GAWR RR
------	------	----------	---------

THIS VEHICLE CONFORMS TO ALL APPLICABLE
FEDERAL MOTOR VEHICLE SAFETY, BUMPER,
AND THEFT PREVENTION STANDARDS IN EFFECT
ON THE DATE OF MANUFACTURE SHOWN ABOVE

United States

MFD. BY GM DAEWOO Auto & Technology Company, REPUBLIC OF KOREA
TYPE :

DATE	GVWR/PNBV	GAWR/PNBE FRT	GAWR/PNBE RR
------	-----------	---------------	--------------

THIS VEHICLE CONFORMS TO ALL APPLICABLE STANDARDS PRESCRIBED
UNDER THE CANADIAN MOTOR VEHICLE SAFETY REGULATIONS IN
EFFECT ON THE DATE OF MANUFACTURE - CE VÉHICULE EST
CONFORME À TOUTES LES NORMES QUI LUI SONT APPLICABLES EN
VERTU DU RÈGLEMENT SUR LA SÉCURITÉ DES VÉHICULES AUTOMOBILES
DU CANADA EN VIGUEUR À LA DATE DE SA FABRICATION

VIN NO:

Canada

The Certification label, found either on the center pillar, near the Tire and Loading Information label or on the end of the driver's door, tells you the gross weight capacity of your vehicle, called the Gross Vehicle Weight Rating (GVWR). The GVWR includes the weight of the vehicle, all occupants, fuel and cargo. Never exceed the GVWR for your vehicle, or the Gross Axle Weight Rating (GAWR) for either the front or rear axle.

And, if you do have a heavy load, you should spread it out. Do not carry more than 110 lbs (50 kg) in your trunk.

CAUTION:

Do not load your vehicle any heavier than the GVWR, or either the maximum front or rear GAWR. If you do, parts on your vehicle can break, and it can change the way your vehicle handles. These could cause you to lose control and crash. Also, overloading can shorten the life of your vehicle.

Notice: Overloading your vehicle may cause damage. Repairs would not be covered by your warranty. Do not overload your vehicle.

If you put things inside your vehicle — like suitcases, tools, packages, or anything else — they will go as fast as the vehicle goes. If you have to stop or turn quickly, or if there is a crash, they will keep going.

CAUTION:

Things you put inside your vehicle can strike and injure people in a sudden stop or turn, or in a crash.

- Put things in the cargo area of your vehicle. Try to spread the weight evenly.
- Never stack heavier things, like suitcases, inside the vehicle so that some of them are above the tops of the seats.
- Do not leave an unsecured child restraint in your vehicle.
- When you carry something inside the vehicle, secure it whenever you can.
- Do not leave a seat folded down unless you need to.

Towing a Trailer

Do not use your vehicle to tow a trailer. The vehicle is not designed or intended for such a use. Towing a trailer can adversely affect handling, durability and fuel economy.

Section 5 Service and Appearance Care

Service	5-3	Coolant Surge Tank Pressure Cap	5-25
Doing Your Own Service Work	5-4	Engine Overheating	5-25
Adding Equipment to the Outside of Your Vehicle	5-4	Cooling System	5-28
Fuel	5-5	Power Steering Fluid	5-34
Gasoline Octane	5-5	Windshield Washer Fluid	5-35
Gasoline Specifications	5-5	Brakes	5-36
California Fuel	5-6	Battery	5-39
Additives	5-6	Jump Starting	5-40
Fuels in Foreign Countries	5-7	Headlamp Aiming	5-45
Filling Your Tank	5-8	Bulb Replacement	5-45
Filling a Portable Fuel Container	5-10	Halogen Bulbs	5-45
Checking Things Under the Hood	5-11	Headlamps	5-46
Hood Release	5-11	Front Turn Signal and Parking Lamps	5-46
Engine Compartment Overview	5-14	Turn Signal Lamps (Side)	5-47
Engine Oil	5-15	Fog Lamps	5-48
Engine Air Cleaner/Filter	5-20	Sidemarker Lamps (Front)	5-48
Automatic Transaxle Fluid	5-21	Sidemarker Lamps (Rear)	5-49
Manual Transaxle Fluid	5-21	Taillamps, Turn Signal, Stoplamps and Back-up Lamps	5-49
Hydraulic Clutch	5-22	Windshield Wiper Blade Replacement	5-50
Engine Coolant	5-23		

Section 5 Service and Appearance Care

Tires	5-51	Sheet Metal Damage	5-81
Inflation - Tire Pressure	5-59	Finish Damage	5-81
Tire Inspection and Rotation	5-60	Underbody Maintenance	5-82
When It Is Time for New Tires	5-61	Chemical Paint Spotting	5-82
Buying New Tires	5-62	Vehicle Care/Appearance Materials	5-82
Uniform Tire Quality Grading	5-63	Vehicle Identification	5-83
Wheel Alignment and Tire Balance	5-64	Vehicle Identification Number (VIN)	5-83
Wheel Replacement	5-64	Service Parts Identification Label	5-84
Tire Chains	5-66	Electrical System	5-84
If a Tire Goes Flat	5-66	Add-On Electrical Equipment	5-84
Changing a Flat Tire	5-67	Headlamp Wiring	5-84
Compact Spare Tire	5-75	Windshield Wiper Fuses	5-84
Appearance Care	5-76	Power Windows and Other Power Options	5-84
Cleaning the Inside of Your Vehicle	5-76	Fuses and Circuit Breakers	5-85
Care of Safety Belts	5-79	Capacities and Specifications	5-91
Weatherstrips	5-79		
Cleaning the Outside of Your Vehicle	5-79		

Service

Your dealer knows your vehicle best and wants you to be happy with it. We hope you will go to your dealer for all your service needs. You will get genuine GM parts and GM-trained and supported service people.

We hope you will want to keep your GM vehicle all GM. Genuine GM parts have one of these marks:

ACDelco[®]

GM[®] **Parts**

GM[®]
Goodwrench

GM[®] **Accessories**

California Proposition 65 Warning

Most motor vehicles, including this one, contain and/or emit chemicals known to the State of California to cause cancer and birth defects or other reproductive harm. Engine exhaust, many parts and systems (including some inside the vehicle), many fluids, and some component wear by-products contain and/or emit these chemicals.

Doing Your Own Service Work

If you want to do some of your own service work, you will want to use the proper service manual. It tells you much more about how to service your vehicle than this manual can. To order the proper service manual, see *Service Publications Ordering Information on page 7-11*.

Your vehicle has an air bag system. Before attempting to do your own service work, see *Servicing Your Air Bag-Equipped Vehicle on page 1-58*.

You should keep a record with all parts receipts and list the mileage and the date of any service work you perform. See *Part E: Maintenance Record on page 6-28*.

CAUTION:

You can be injured and your vehicle could be damaged if you try to do service work on a vehicle without knowing enough about it.

CAUTION: (Continued)

CAUTION: (Continued)

- **Be sure you have sufficient knowledge, experience, the proper replacement parts and tools before you attempt any vehicle maintenance task.**
- **Be sure to use the proper nuts, bolts and other fasteners. “English” and “metric” fasteners can be easily confused. If you use the wrong fasteners, parts can later break or fall off. You could be hurt.**

Adding Equipment to the Outside of Your Vehicle

Things you might add to the outside of your vehicle can affect the airflow around it. This may cause wind noise and affect windshield washer performance. Check with your dealer before adding equipment to the outside of your vehicle.

Fuel

Use of the recommended fuel is an important part of the proper maintenance of your vehicle.

Gasoline Octane

Use regular unleaded gasoline with a posted octane of 87 or higher. If the octane is less than 87, you may get a heavy knocking noise when you drive. If this occurs, use a gasoline rated at 87 octane or higher as soon as possible. Otherwise, you might damage your engine. A little pinging noise when you accelerate or drive uphill is considered normal. This does not indicate a problem exists or that a higher-octane fuel is necessary. If you are using 87 octane or higher-octane fuel and hear heavy knocking, your engine needs service.

Gasoline Specifications

It is recommended that gasoline meet specifications which were developed by automobile manufacturers around the world and contained in the World-Wide Fuel Charter which is available from the Alliance of Automobile Manufacturers at www.autoalliance.org. Gasoline meeting these specifications could provide improved driveability and emission control system performance compared to other gasoline.



In Canada, look for the “Auto Makers’ Choice” label on the pump.

Canada Only

California Fuel

If your vehicle is certified to meet California Emission Standards (see the underhood emission control label), it is designed to operate on fuels that meet California specifications. If this fuel is not available in states adopting California emissions standards, your vehicle will operate satisfactorily on fuels meeting federal specifications, but emission control system performance may be affected. The malfunction indicator lamp may turn on (see *Malfunction Indicator Lamp on page 3-28*) and your vehicle may fail a smog-check test. If this occurs, return to your authorized GM dealer for diagnosis. If it is determined that the condition is caused by the type of fuel used, repairs may not be covered by your warranty.

Additives

To provide cleaner air, all gasolines in the United States are now required to contain additives that will help prevent engine and fuel system deposits from forming, allowing your emission control system to work properly. You should not have to add anything to your fuel. However, some gasolines contain only the minimum amount of additive required to meet U.S. Environmental Protection Agency regulations. General Motors recommends that you buy gasolines that are advertised to help keep fuel injectors and intake valves clean. If your vehicle experiences problems due to dirty injectors or valves, try a different brand of gasoline.

Gasolines containing oxygenates, such as ethers and ethanol, and reformulated gasolines may be available in your area to contribute to clean air. General Motors recommends that you use these gasolines, particularly if they comply with the specifications described earlier.

Notice: Your vehicle was not designed for fuel that contains methanol. Do not use fuel containing methanol. It can corrode metal parts in your fuel system and also damage the plastic and rubber parts. That damage would not be covered under your warranty.

Some gasolines that are not reformulated for low emissions may contain an octane-enhancing additive called methylcyclopentadienyl manganese tricarbonyl (MMT); ask the attendant where you buy gasoline whether the fuel contains MMT. General Motors does not recommend the use of such gasolines. Fuels containing MMT can reduce the life of spark plugs and the performance of the emission control system may be affected. The malfunction indicator lamp may turn on. If this occurs, return to your authorized GM dealer for service.

Fuels in Foreign Countries

If you plan on driving in another country outside the United States or Canada, the proper fuel may be hard to find. Never use leaded gasoline or any other fuel not recommended in the previous text on fuel. Costly repairs caused by use of improper fuel would not be covered by your warranty.

To check the fuel availability, ask an auto club, or contact a major oil company that does business in the country where you will be driving.

Filling Your Tank

CAUTION:

Fuel vapor burns violently and a fuel fire can cause bad injuries. To help avoid injuries to you and others, read and follow all the instructions on the pump island. Turn off your engine when you are refueling. Do not smoke if you are near fuel or refueling your vehicle. Keep sparks, flames and smoking materials away from fuel. Do not leave the fuel pump unattended when refueling your vehicle — this is against the law in some places. Keep children away from the fuel pump; never let children pump fuel.



To open the fuel filler door, pull up on the fuel filler door release lever located on the floor to the left of the driver's seat.

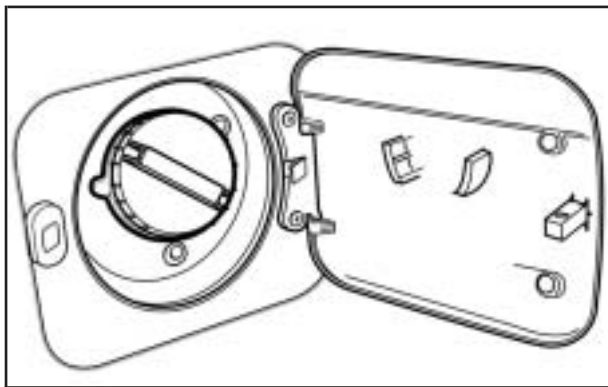

The tethered fuel cap is located behind a hinged door on the passenger's side of your vehicle.

To remove the fuel cap, turn it slowly to the left (counterclockwise). The fuel cap has a spring in it. If you let go of it too soon, it will spring back to the right.

⚠ CAUTION:

If you spill fuel and then something ignites it, you could be badly burned. Fuel can spray out on you if you open the fuel cap too quickly. This spray can happen if your tank is nearly full, and is more likely in hot weather. Open the fuel cap slowly and wait for any "hiss" noise to stop. Then unscrew the cap all the way.

Be careful not to spill fuel. Do not top off or overfill your tank, and wait a few seconds after you have finished pumping before you remove the nozzle. Clean fuel from painted surfaces as soon as possible. See *Cleaning the Outside of Your Vehicle* on page 5-79.

When you put the fuel cap back on, turn it to the right (clockwise) until you hear a clicking sound. Make sure you fully install the cap. The diagnostic system can determine if the fuel cap has been left off or improperly installed. This would allow fuel to evaporate into the atmosphere. See *Malfunction Indicator Lamp on page 3-28*.

 **CAUTION:**

If a fire starts while you are refueling, do not remove the nozzle. Shut off the flow of fuel by shutting off the pump or by notifying the station attendant. Leave the area immediately.

Notice: If you need a new fuel cap, be sure to get the right type. Your dealer can get one for you. If you get the wrong type, it may not fit properly. This may cause your malfunction indicator lamp to light and may damage your fuel tank and emissions system. See *Malfunction Indicator Lamp on page 3-28*.

Filling a Portable Fuel Container

 **CAUTION:**

Never fill a portable fuel container while it is in your vehicle. Static electricity discharge from the container can ignite the gasoline vapor. You can be badly burned and your vehicle damaged if this occurs. To help avoid injury to you and others:

- Dispense gasoline only into approved containers.
- Do not fill a container while it is inside a vehicle, in a vehicle's trunk, pickup bed or on any surface other than the ground.
- Bring the fill nozzle in contact with the inside of the fill opening before operating the nozzle. Contact should be maintained until the filling is complete.
- Do not smoke while pumping gasoline.

Checking Things Under the Hood

CAUTION:

An electric fan under the hood can start up and injure you even when the engine is not running. Keep hands, clothing and tools away from any underhood electric fan.

CAUTION:

Things that burn can get on hot engine parts and start a fire. These include liquids like fuel, oil, coolant, brake fluid, windshield washer and other fluids, and plastic or rubber. You or others could be burned. Be careful not to drop or spill things that will burn onto a hot engine.

Hood Release

To open the hood, do the following:

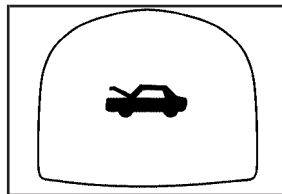

1. Pull the hood release handle inside the vehicle. It is located on the lower left side of the instrument panel.

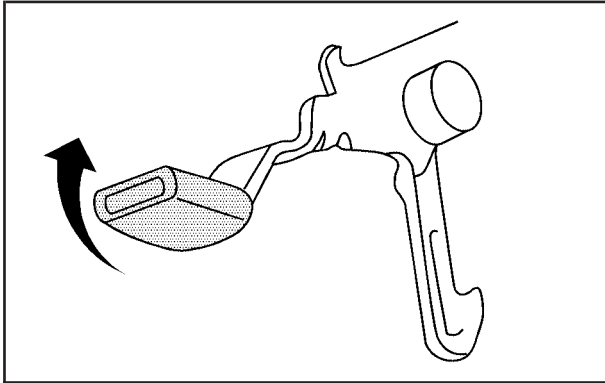

2. Then go to the front of the vehicle and push the secondary hood release lever up.

The secondary hood release lever is located under the front center of the hood.

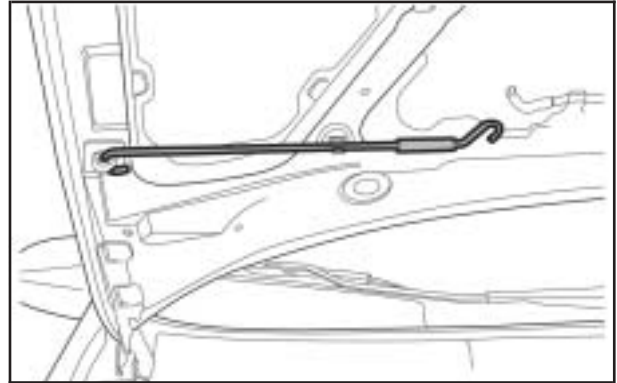

3. Lift the hood and release the hood prop from its retainer located on the underside of the hood.

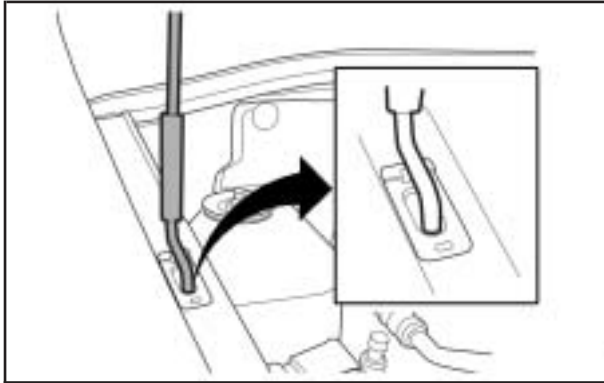

4. Place the hood prop into the slot on the inner fender.

Before closing the hood, be sure all the filler caps are on properly. Then lift the hood to relieve pressure on the hood prop. Remove the hood prop from the slot in the inner fender and return the prop to its retainer. Lower the hood 12 inches (30 cm) above the vehicle and release it to latch fully. Check to make sure the hood is closed and repeat the process if necessary.

Engine Compartment Overview

When you open the hood on the engine, you will see the following:

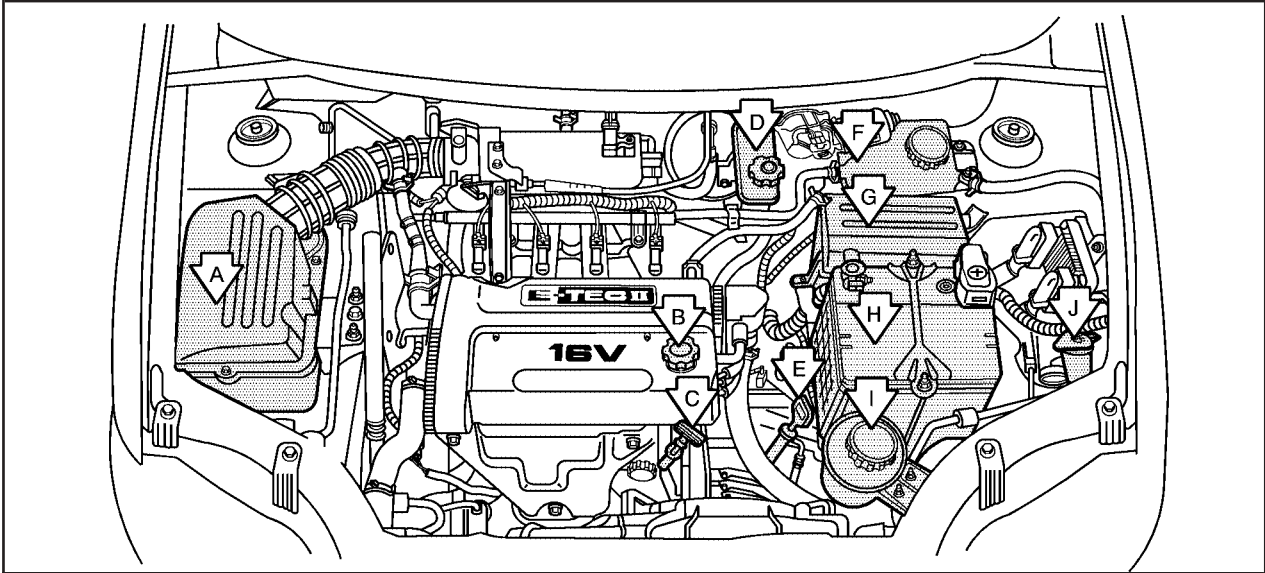

Automatic shown, Manual similar

- A. Engine Air Cleaner/Filter. See *Engine Air Cleaner/Filter on page 5-20*.
- B. Engine Oil Fill Cap. See “When to Add Engine Oil” under *Engine Oil on page 5-15*.
- C. Engine Oil Dipstick. See “Checking Engine Oil” under *Engine Oil on page 5-15*.
- D. Brake Fluid Reservoir. See “Brake Fluid” under *Brakes on page 5-36*.
- E. Automatic Transaxle Dipstick. See *Automatic Transaxle Fluid on page 5-21*.
- F. Engine Coolant Surge Tank. See *Cooling System on page 5-28*.
- G. Engine Compartment Fuse Block. See “Engine Compartment Fuse Block” under *Fuses and Circuit Breakers on page 5-85*.
- H. Battery. See *Battery on page 5-39*.
- I. Power Steering Fluid Reservoir. See *Power Steering Fluid on page 5-34*.
- J. Windshield Washer Fluid Reservoir. See *Windshield Washer Fluid on page 5-35*.

Engine Oil

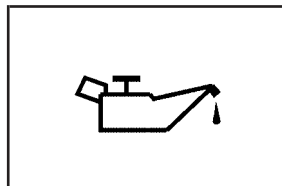

If the oil pressure light appears on the instrument cluster, it means you need to check your engine oil level right away.

For more information, see *Oil Pressure Light on page 3-32*.

You should check your engine oil level regularly; this is an added reminder.

Checking Engine Oil

It is a good idea to check your engine oil every time you get fuel. In order to get an accurate reading, the oil must be warm and the vehicle must be on level ground.

The engine oil dipstick handle is a yellow loop. See *Engine Compartment Overview on page 5-14* for the location of the engine oil dipstick.

Turn off the engine and give the oil several minutes to drain back into the oil pan. If you do not do this, the oil dipstick might not show the actual level.

Pull the dipstick and clean it with a paper towel or cloth, then push it back in all the way. Remove it again, keeping the tip oil down and check the level.

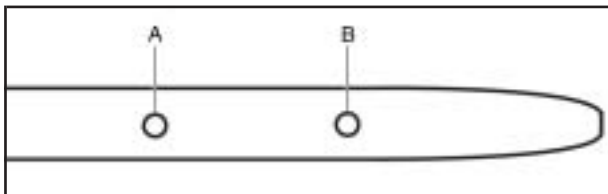

When to Add Engine Oil

If the oil is at or below the lower hole at the tip of the dipstick (B), then you will need to add at least one quart of oil. But you must use the right kind. This section explains what kind of oil to use. For engine oil crankcase capacity, see *Capacities and Specifications on page 5-91*.

Notice: Do not add too much oil. If your engine has so much oil that the oil level gets above the upper hole (A) that shows the proper operating range, your engine could be damaged.

See *Engine Compartment Overview on page 5-14* for the location of the engine oil fill cap.

Be sure to add enough oil to put the level somewhere in the proper operating range. Push the dipstick all the way back in when you are through.

What Kind of Engine Oil to Use

Look for two things:

- GM6094M

Your vehicle's engine requires oil meeting GM Standard GM6094M. You should look for and use only an oil that meets GM Standard GM6094M.

RECOMMENDED SAE VISCOSITY GRADE ENGINE OILS

HOT
WEATHER

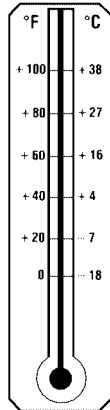

COLD
WEATHER

LOOK FOR
THIS SYMBOL
AND GM
STANDARD
GM 6094M



SAE 5W-30
RECOMMENDED

SAE 10W-30
ACCEPTABLE
IF 5W-30 IS NOT
AVAILABLE

DO NOT USE SAE 10W-40, SAE 20W-50 OR ANY OTHER
VISCOSITY GRADE OIL NOT RECOMMENDED

- SAE 5W-30

As shown in the viscosity chart, SAE 5W-30 is best for your vehicle. However, if it is going to be 0°F (-18°C) or above and SAE 5W-30 is not available, you may use SAE 10W-30.

These numbers on an oil container show its viscosity, or thickness. Do not use other viscosity oils such as SAE 20W-50.

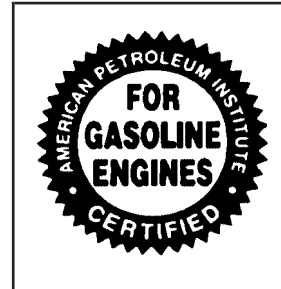

Oils meeting these requirements should also have the starburst symbol on the container. This symbol indicates that the oil has been certified by the American Petroleum Institute (API).

You should look for this information on the oil container, and use *only* those oils that are identified as meeting GM Standard GM6094M and have the starburst symbol on the front of the oil container.

Notice: Use only engine oil identified as meeting GM Standard GM6094M and showing the American Petroleum Institute Certified For Gasoline Engines starburst symbol. Failure to use the recommended oil can result in engine damage not covered by your warranty.

GM Goodwrench[®] oil meets all the requirements for your vehicle.

If you are in an area of extreme cold, where the temperature falls below -20°F (-29°C), it is recommended that you use either an SAE 5W-30 synthetic oil or an SAE 0W-30 oil. Both will provide easier cold starting and better protection for your engine at extremely low temperatures.

Engine Oil Additives

Do not add anything to your oil. The recommended oils with the starburst symbol that meet GM Standard GM6094M are all you will need for good performance and engine protection.

When to Change Engine Oil

If any one of these is true for you, use the short trip/city maintenance schedule:

- Most trips are less than 5 miles (8 km). This is particularly important when outside temperatures are below freezing.
- Most trips include extensive idling (such as frequent driving in stop-and-go traffic).
- You frequently tow a trailer or use a carrier on top of your vehicle.
- The vehicle is used for delivery service, police, taxi or other commercial application.

Driving under these conditions causes engine oil to break down sooner. If any one of these is true for your vehicle, then you need to change your oil and filter every 3,000 miles (5 000 km) or 3 months — whichever occurs first.

If none of them is true, use the long trip/highway maintenance schedule. Change oil and filter every 7,500 miles (12 500 km) or 12 months — whichever occurs first. Driving a vehicle with a fully warmed engine under highway conditions will cause engine oil to break down slower.

What to Do with Used Oil

Used engine oil contains certain elements that may be unhealthy for your skin and could even cause cancer. Do not let used oil stay on your skin for very long. Clean your skin and nails with soap and water, or a good hand cleaner. Wash or properly dispose of clothing or rags containing used engine oil. See the manufacturer's warnings about the use and disposal of oil products.

Used oil can be a threat to the environment. If you change your own oil, be sure to drain all the oil from the filter before disposal. Never dispose of oil by putting it in the trash, pouring it on the ground, into sewers, or into streams or bodies of water. Instead, recycle it by taking it to a place that collects used oil. If you have a problem properly disposing of your used oil, ask your dealer, a service station or a local recycling center for help.

Engine Air Cleaner/Filter

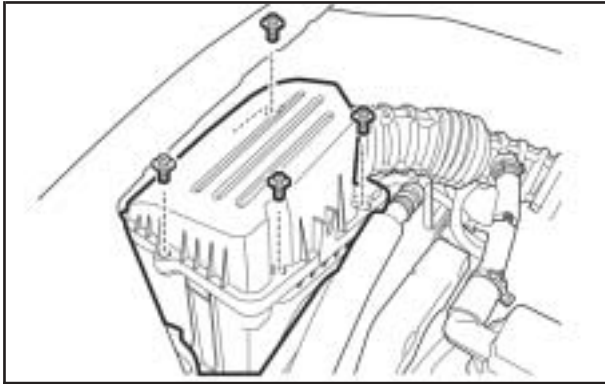

The engine air cleaner/filter is located in the engine compartment on the passenger's side of the vehicle. See *Engine Compartment Overview* on page 5-14 for more information on location.

When to Inspect the Engine Air Cleaner/Filter

Inspect the engine air cleaner/filter every 15,000 miles (25 000 km) and replace every 30,000 miles (50 000 km). If you are driving in dusty/dirty conditions, inspect the filter at each engine oil change.

How to Inspect the Engine Air Cleaner/Filter

To inspect the engine air cleaner/filter remove the filter from the vehicle and lightly shake the filter to release loose dust and dirt. If the filter remains caked with dirt, a new filter is required.

To inspect or replace the filter, do the following:

1. Remove the screws and lift off the cover.
2. Check or replace the engine air cleaner/filter.
3. Put the cover back on tightly and tighten the screws.

See *Using Your Maintenance Schedule* on page 6-4 for replacement intervals.

 **CAUTION:**

Operating the engine with the air cleaner/filter off can cause you or others to be burned. The air cleaner not only cleans the air, it helps to stop flame if the engine backfires. If it is not there and the engine backfires, you could be burned. Do not drive with it off, and be careful working on the engine with the air cleaner/filter off.

Notice: If the air cleaner/filter is off, a backfire can cause a damaging engine fire. And, dirt can easily get into your engine, which will damage it. Always have the air cleaner/filter in place when you are driving.

Automatic Transaxle Fluid

It is not necessary to check the transaxle fluid level. If a leak occurs, take the vehicle to the dealership service department and have it repaired as soon as possible. You may also have your fluid level checked by your dealer or service center when you have your oil changed.

Notice: Use of automatic transaxle fluid labeled other than ESSO LT71141 or TOTAL ATF H50235 may damage your vehicle, and the damages may not be covered by your warranty. Always use ESSO LT71141 or TOTAL ATF H50235 labeled automatic transaxle fluid.

Manual Transaxle Fluid

It is not necessary to check the transaxle fluid level. A transaxle fluid leak is the only reason for fluid loss. If a leak occurs, take the vehicle to the dealership service department and have it repaired as soon as possible. You may also have your fluid level checked by your dealer or service center when you have your oil changed. See *Part D: Recommended Fluids and Lubricants* on page 6-26 for the proper fluid to use.

Hydraulic Clutch

There is one reservoir for both the brake and the hydraulic clutch fluid. See *Brakes* on page 5-36 for more information.

The hydraulic clutch linkage in your vehicle is self-adjusting. The master cylinder reservoir is filled with hydraulic fluid.

A fluid loss in this system could indicate a problem. Have the system inspected and repaired.

When to Check and What to Use

Refer to the Maintenance Schedule to determine how often you should check the fluid level in your master cylinder reservoir and for the proper fluid. See *Part B: Owner Checks and Services* on page 6-19 and *Part D: Recommended Fluids and Lubricants* on page 6-26.

How to Check and Add Fluid

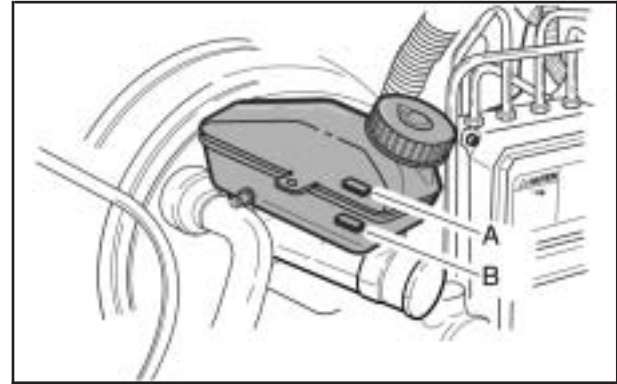

To check the fluid level, look on the side of the reservoir. If the fluid reaches the MAX (A) mark on the reservoir, the fluid level is correct. The reservoir is located near the back of the engine compartment on the driver's side of the vehicle. See *Engine Compartment Overview* on page 5-14 for more information on location.

Engine Coolant

The following explains your cooling system and how to add coolant when it is low. If you have a problem with engine overheating, see *Engine Overheating on page 5-25*.

A 50/50 mixture of clean, drinkable water and proper coolant will:

- Give freezing protection down to -22°F (-30°C).
- Give boiling protection up to 268°F (131°C)
- Protect against rust and corrosion.
- Help keep the proper engine temperature.
- Let the warning lights and gages work as they should.

What to Use

Use a 50/50 mixture of *clean, drinkable water* and coolant that meets GM Specification 1825M, which will not damage aluminum parts. You can also use a recycled coolant conforming to GM Specification 1825M with a complete coolant flush and refill. If you use this coolant mixture, you do not need to add anything else.

For protection in extremely cold weather conditions, use a 40/60 mixture of clean, drinkable water and proper coolant.

CAUTION:

Adding only plain water to your cooling system can be dangerous. Plain water, or some other liquid such as alcohol, can boil before the proper coolant mixture will. Your vehicle's coolant warning system is set for the proper coolant mixture. With plain water or the wrong mixture, your engine could get too hot but you would not get the overheat warning. Your engine could catch fire and you or others could be burned. Use a 50/50 mixture of clean, drinkable water and the proper coolant.

Notice: If you use an improper coolant mixture, your engine could overheat and be badly damaged. The repair cost would not be covered by your warranty. Too much water in the mixture can freeze and crack the engine, radiator, heater core and other parts.

If you have to add coolant more than four times a year, have your dealer check your cooling system.

Notice: If you use the proper coolant, you do not have to add extra inhibitors or additives which claim to improve the system. These can be harmful.

Checking Coolant

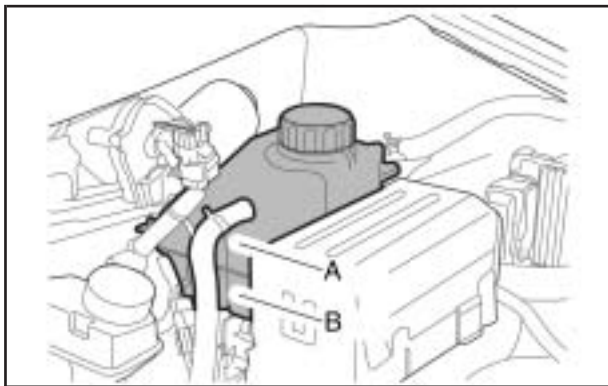

The engine coolant surge tank is located in the rear of the engine compartment on the driver's side. See *Engine Compartment Overview* on page 5-14 for more information on location.

CAUTION:

Turning the surge tank pressure cap when the engine and radiator are hot can allow steam and scalding liquids to blow out and burn you badly. Never turn the surge tank pressure cap — even a little — when the engine and radiator are hot.

The vehicle must be on a level surface. When your engine is cold, the coolant level should be between the MAX (A) and MIN (B) marks on the coolant surge tank. The level rises at engine operation temperature and drops again when the engine cools down.

Adding Coolant

If the level falls below the MIN (B) mark, add the proper coolant mixture *at the surge tank*, but only when the engine is cool. If the surge tank is empty, a special fill procedure is necessary. See *Cooling System on page 5-28* for instructions on “How to Add Coolant to the Coolant Surge Tank.”

CAUTION:

You can be burned if you spill coolant on hot engine parts. Coolant contains ethylene glycol, and it will burn if the engine parts are hot enough. Do not spill coolant on a hot engine.

When replacing the pressure cap, make sure it is hand-tight.

Coolant Surge Tank Pressure Cap

Notice: If the pressure cap is not tightly installed, coolant loss and possible engine damage may occur. Be sure the cap is properly and tightly secured.

Engine Overheating

You will find a coolant temperature gage on your vehicle's instrument panel cluster. See *Engine Coolant Temperature Gage on page 3-21*.

If Steam Is Coming From Your Engine



CAUTION:

Steam from an overheated engine can burn you badly, even if you just open the hood. Stay away from the engine if you see or hear steam coming from it. Just turn it off and get everyone away from the vehicle until it cools down. Wait until there is no sign of steam or coolant before you open the hood.

If you keep driving when your engine is overheated, the liquids in it can catch fire. You or others could be badly burned. Stop your engine if it overheats, and get out of the vehicle until the engine is cool.

Notice: If your engine catches fire because you keep driving with no coolant, your vehicle can be badly damaged. The costly repairs would not be covered by your warranty.

If No Steam Is Coming From Your Engine

If you get an engine overheat warning, but see or hear no steam, the problem may not be too serious. Sometimes the engine can get a little too hot when you:

- Climb a long hill on a hot day.
- Stop after high-speed driving.
- Idle for long periods in traffic.

If you get the overheat warning with no sign of steam, try this for a minute or so:

1. In heavy traffic, let the engine idle in NEUTRAL while stopped. If it is safe to do so, pull off the road, shift to PARK (P) or NEUTRAL and let the engine idle.
2. Turn on your heater to full hot at the highest fan speed and open the window as necessary.

If you no longer have the overheat warning, you can drive. Just to be safe, drive slower for about 10 minutes. If the warning does not come back on, you can drive normally.

If the warning continues and you have not stopped, pull over, stop, and park your vehicle right away.

If there is still no sign of steam, you can idle the engine for three minutes while you are parked. If you still have the warning, *turn off the engine and get everyone out of the vehicle* until it cools down.

You may decide not to lift the hood, but to get service help right away.

Cooling System

When you decide it is safe to lift the hood, here is what you will see:

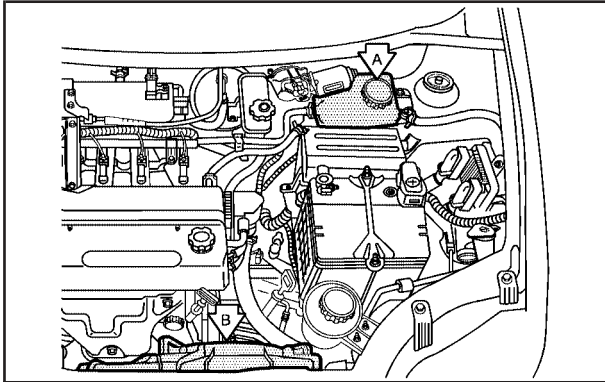

- A. Coolant Surge Tank with Pressure Cap
- B. Electric Engine Cooling Fan

CAUTION:

An electric engine cooling fan under the hood can start up even when the engine is not running and can injure you. Keep hands, clothing and tools away from any underhood electric fan.

If the coolant inside the coolant surge tank is boiling, do not do anything else until it cools down. The vehicle should be parked on a level surface. Make sure that the air conditioning is turned off.

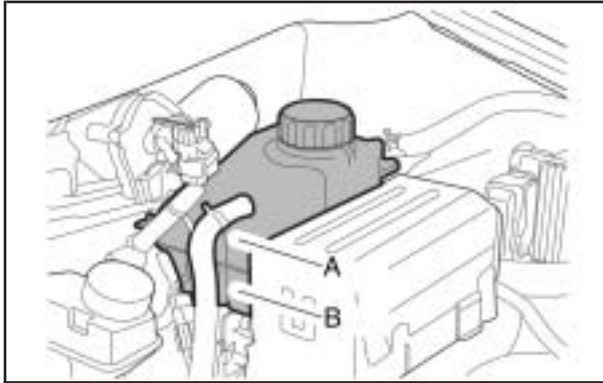

The coolant level should be between the MIN (B) and MAX (A) marks on the coolant surge tank when the engine is cool. If it is not, you may have a leak at the pressure cap or in the radiator hoses, heater hoses, radiator, water pump or somewhere else in the cooling system.

⚠ CAUTION:

Heater and radiator hoses, and other engine parts, can be very hot. Do not touch them. If you do, you can be burned.

Do not run the engine if there is a leak. If you run the engine, it could lose all coolant. That could cause an engine fire, and you could be burned. Get any leak fixed before you drive the vehicle.

If there seems to be no leak, with the engine on, check to see if the electric engine cooling fan is running. If the engine is overheating, the fan should be running. If it is not, your vehicle needs service.

Notice: Engine damage from running your engine without coolant is not covered by your warranty.

How to Add Coolant to the Coolant Surge Tank

Notice: This vehicle has a specific coolant fill procedure. Failure to follow this procedure could cause your engine to overheat and be severely damaged.

If you have not found a problem yet, check to see if coolant is visible in the surge tank. If coolant is visible but the coolant level is not between the MIN (B) and MAX (A) marks, add a 50/50 mixture of *clean, drinkable water* and proper coolant at the coolant surge tank, but be sure the cooling system, including the coolant surge tank pressure cap, is cool before you do it. See *Engine Coolant on page 5-23* for more information.

If no coolant is visible in the surge tank, add coolant as follows:

CAUTION:

Steam and scalding liquids from a hot cooling system can blow out and burn you badly. They are under pressure, and if you turn the coolant surge tank pressure cap — even a little — they can come out at high speed. Never turn the cap when the cooling system, including the coolant surge tank pressure cap, is hot. Wait for the cooling system and coolant surge tank pressure cap to cool if you ever have to turn the pressure cap.



⚠ CAUTION:

Adding only plain water to your cooling system can be dangerous. Plain water, or some other liquid such as alcohol, can boil before the proper coolant mixture will. Your vehicle's coolant warning system is set for the proper coolant mixture. With plain water or the wrong mixture, your engine could get too hot but you would not get the overheat warning. Your engine could catch fire and you or others could be burned. Use a 50/50 mixture of clean, drinkable water and a proper coolant.

Notice: In cold weather, water can freeze and crack the engine, radiator, heater core and other parts. Use the recommended coolant and the proper coolant mixture.

⚠ CAUTION:

You can be burned if you spill coolant on hot engine parts. Coolant contains ethylene glycol and it will burn if the engine parts are hot enough. Do not spill coolant on a hot engine.

1. Park the vehicle on a level surface.

You can remove the coolant surge tank pressure cap when the cooling system, including the coolant surge tank pressure cap and upper radiator hose, is no longer hot. Turn the pressure cap slowly counterclockwise (left) about two or two and one-half turns. If you hear a hiss, wait for that to stop. This will allow any pressure still left to be vented out the discharge hose.

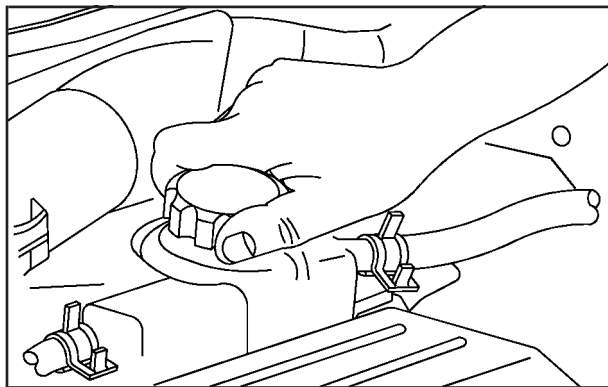

2. Then keep turning the pressure cap slowly, and remove it.

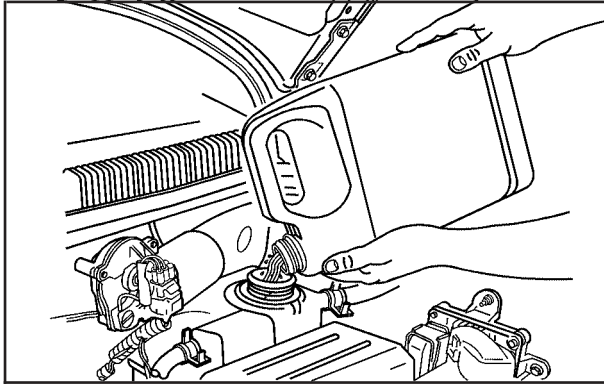

3. Fill the coolant surge tank with the proper mixture to the MAX (A) mark on the coolant surge tank. Wait about five minutes, then check to see if the level is below the MAX (A) mark. If the level is below the MAX (A) mark, add additional coolant to bring the level up to the MAX (A) mark. Repeat this procedure until the level remains constant at the MAX (A) mark for at least five minutes.

4. With the coolant surge tank pressure cap off, start the engine and let it run until you can feel the upper radiator hose getting hot. Watch out for the engine cooling fan.

By this time, the coolant level inside the coolant surge tank may be lower. If the level is lower than the MAX (A) mark, add more of the proper mixture to the coolant surge tank until the level reaches the MAX (A) mark.

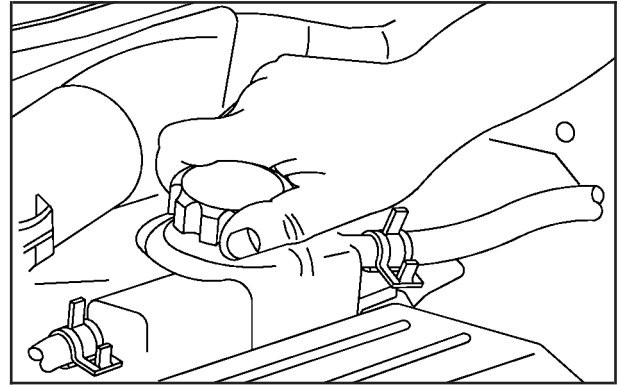

5. Then replace the pressure cap. Be sure the pressure cap is hand-tight and fully seated. See your dealer, if necessary.

Power Steering Fluid

When to Check Power Steering Fluid

The power steering fluid reservoir is located toward the front of the engine compartment on the driver's side of the vehicle. See *Engine Compartment Overview* on page 5-14 for reservoir location.

It is not necessary to regularly check power steering fluid unless you suspect there is a leak in the system or you hear an unusual noise. A fluid loss in this system could indicate a problem. Have the system inspected and repaired.

How to Check Power Steering Fluid

Turn the key off and let the engine compartment cool down.

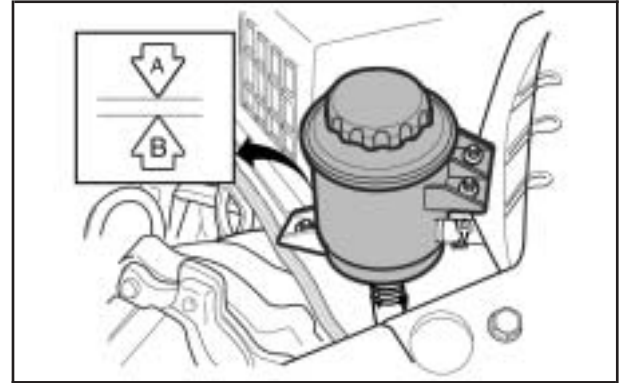

The level should be between the MIN (B) and MAX (A) marks on the reservoir. If the level drops below the MIN (B) mark, add the power steering fluid.

What to Use

To determine what kind of fluid to use, see *Part D: Recommended Fluids and Lubricants* on page 6-26. Always use the proper fluid. Failure to use the proper fluid can cause leaks and damage hoses and seals.

Windshield Washer Fluid

What to Use

When you need windshield washer fluid, be sure to read the manufacturer's instructions before use. If you will be operating your vehicle in an area where the temperature may fall below freezing, use a fluid that has sufficient protection against freezing.

Adding Washer Fluid

The windshield washer fluid reservoir is located in the front of the engine compartment on the driver's side of the vehicle. See *Engine Compartment Overview on page 5-14* for reservoir location.

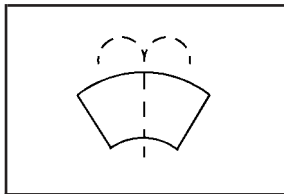

Open the cap with the washer symbol on it.

Add washer fluid until the tank is full.

Notice:

- **When using concentrated washer fluid, follow the manufacturer's instructions for adding water.**
- **Do not mix water with ready-to-use washer fluid. Water can cause the solution to freeze and damage your washer fluid tank and other parts of the washer system. Also, water does not clean as well as washer fluid.**
- **Fill your washer fluid tank only three-quarters full when it is very cold. This allows for expansion if freezing occurs, which could damage the tank if it is completely full.**
- **Do not use engine coolant (antifreeze) in your windshield washer. It can damage your washer system and paint.**

Brakes

Brake Fluid

Your vehicle has one reservoir for both the brake and clutch hydraulic systems. It is filled with DOT-3 brake fluid. See *Engine Compartment Overview on page 5-14* for the location of the reservoir.

There are only two reasons why the brake fluid level in the reservoir might go down. The first is that the brake fluid goes down to an acceptable level during normal brake lining wear. When new linings are put in, the fluid level goes back up. The other reason is that fluid is leaking out of the brake or clutch system. If it is, you should have your brake/clutch system fixed, since a leak means that sooner or later your brakes will not work well, or will not work at all.

So, it is not a good idea to “top off” your brake fluid. Adding brake fluid will not correct a leak. If you add fluid when your linings are worn, then you will have too much fluid when you get new brake linings. You should add or remove brake fluid, as necessary, only when work is done on the brake hydraulic system.

CAUTION:

If you have too much brake fluid, it can spill on the engine. The fluid will burn if the engine is hot enough. You or others could be burned, and your vehicle could be damaged. Add brake fluid only when work is done on the brake hydraulic system.

When your brake fluid falls to a low level, your brake warning light will come on. See *Brake System Warning Light on page 3-20*.

What to Add

When you do need brake fluid, use only DOT-3 brake fluid. Use new brake fluid from a sealed container only. See *Part D: Recommended Fluids and Lubricants on page 6-26*.

Always clean the brake fluid reservoir cap and the area around the cap before removing it. This will help keep dirt from entering the reservoir.

 **CAUTION:**

With the wrong kind of fluid in your brake system, your brakes may not work well, or they may not even work at all. This could cause a crash. Always use the proper brake fluid.

Notice:

- Using the wrong fluid can badly damage brake system parts. For example, just a few drops of mineral-based oil, such as engine oil, in your brake system can damage brake system parts so badly that they will have to be replaced. Do not let someone put in the wrong kind of fluid.
- If you spill brake fluid on your vehicle's painted surfaces, the paint finish can be damaged. Be careful not to spill brake fluid on your vehicle. If you do, wash it off immediately. See *Appearance Care on page 5-76*.

Brake Wear

Your vehicle has front disc brakes and rear drum brakes.

Disc brake pads have built-in wear indicators that make a high-pitched warning sound when the brake pads are worn and new pads are needed. The sound may come and go or be heard all the time your vehicle is moving, except when you are pushing on the brake pedal firmly.

 **CAUTION:**

The brake wear warning sound means that soon your brakes will not work well. That could lead to an accident. When you hear the brake wear warning sound, have your vehicle serviced.

Notice: Continuing to drive with worn-out brake pads could result in costly brake repair.

Some driving conditions or climates may cause a brake squeal when the brakes are first applied or lightly applied. This does not mean something is wrong with your brakes.

Properly torqued wheel nuts are necessary to help prevent brake pulsation. When tires are rotated, inspect brake pads for wear and evenly tighten wheel nuts in the proper sequence to GM torque specifications.

Your rear drum brakes do not have wear indicators, but if you ever hear a rear brake rubbing noise, have the rear brake linings inspected immediately. Also, the rear brake drums should be removed and inspected each time the tires are removed for rotation or changing. When you have the front brake pads replaced, have the rear brakes inspected, too.

Brake linings should always be replaced as complete axle sets.

See *Brake System Inspection on page 6-25*.

Brake Pedal Travel

See your dealer if the brake pedal does not return to normal height, or if there is a rapid increase in pedal travel. This could be a sign of brake trouble.

Brake Adjustment

Every time you make a moderate brake stop, your disc brakes adjust for wear. If you rarely make a moderate or heavier stop, then your brakes might not adjust correctly.

If you drive in that way, then – very carefully – make a few moderate brake stops about every 1,000 miles (1 600 km), so your brakes will adjust properly.

If your brake pedal goes down farther than normal, your rear drum brakes may need adjustment. Adjust them by backing up and firmly applying the brakes a few times.

Replacing Brake System Parts

The braking system on a vehicle is complex. Its many parts have to be of top quality and work well together if the vehicle is to have really good braking. Your vehicle was designed and tested with top-quality GM brake parts. When you replace parts of your braking system – for example, when your brake linings wear down and you need new ones put in – be sure you get new approved GM replacement parts. If you do not, your brakes may no longer work properly. For example, if someone puts in brake linings that are wrong for your vehicle, the balance between your front and rear brakes can change – for the worse. The braking performance you have come to expect can change in many other ways if someone puts in the wrong replacement brake parts.

Battery

Your new vehicle comes with a maintenance free battery. When it is time for a new battery, get one that has the replacement number shown on the original battery's label. See *Engine Compartment Overview on page 5-14* for battery location.

Warning: Battery posts, terminals and related accessories contain lead and lead compounds, chemicals known to the State of California to cause cancer and reproductive harm. Wash hands after handling.

Vehicle Storage

If you are not going to drive your vehicle for 25 days or more, remove the black, negative (-) cable from the battery. This will help keep your battery from running down.

CAUTION:

Batteries have acid that can burn you and gas that can explode. You can be badly hurt if you are not careful. See *Jump Starting on page 5-40* for tips on working around a battery without getting hurt.

Contact your dealer to learn how to prepare your vehicle for longer storage periods.

Jump Starting

If your battery has run down, you may want to use another vehicle and some jumper cables to start your vehicle. Be sure to follow the steps below to do it safely.

CAUTION:

Batteries can hurt you. They can be dangerous because:

- They contain acid that can burn you.
- They contain gas that can explode or ignite.
- They contain enough electricity to burn you.

If you do not follow these steps exactly, some or all of these things can hurt you.

Notice: Ignoring these steps could result in costly damage to your vehicle that would not be covered by your warranty.

Trying to start your vehicle by pushing or pulling it will not work, and it could damage your vehicle.

1. Check the other vehicle. It must have a 12-volt battery with a negative ground system.

Notice: If the other vehicle's system is not a 12-volt system with a negative ground, both vehicles can be damaged. Only use vehicles with 12-volt systems with negative grounds to jump start your vehicle.

2. Get the vehicles close enough so the jumper cables can reach, but be sure the vehicles are not touching each other. If they are, it could cause a ground connection you do not want. You would not be able to start your vehicle, and the bad grounding could damage the electrical systems.

To avoid the possibility of the vehicles rolling, set the parking brake firmly on both vehicles involved in the jump start procedure. Put an automatic transaxle in PARK (P) or a manual transaxle in NEUTRAL before setting the parking brake.

Notice: If you leave your radio or other accessories on during the jump starting procedure, they could be damaged. The repairs would not be covered by your warranty. Always turn off your radio and other accessories when jump starting your vehicle.

3. Turn off the ignition on both vehicles. Unplug unnecessary accessories plugged into the cigarette lighter or in the accessory power outlet. Turn off the radio and all lamps that are not needed. This will avoid sparks and help save both batteries. And it could save your radio!
4. Open the hoods and locate the batteries. Find the positive (+) and negative (-) terminal locations on each vehicle. Your vehicle's positive (+) terminal is located under a red tethered cap on the battery. See *Engine Compartment Overview on page 5-14* for more information on location.
Flip the cap up to access the positive (+) terminal.

 **CAUTION:**

An electric fan can start up even when the engine is not running and can injure you. Keep hands, clothing and tools away from any underhood electric fan.

 **CAUTION:**

Using a match near a battery can cause battery gas to explode. People have been hurt doing this, and some have been blinded. Use a flashlight if you need more light.

Be sure the battery has enough water. You do not need to add water to the battery installed in your new vehicle. But if a battery has filler caps, be sure the right amount of fluid is there. If it is low, add water to take care of that first. If you don't, explosive gas could be present.

Battery fluid contains acid that can burn you. Do not get it on you. If you accidentally get it in your eyes or on your skin, flush the place with water and get medical help immediately.

⚠ CAUTION:

Fans or other moving engine parts can injure you badly. Keep your hands away from moving parts once the engine is running.

5. Check that the jumper cables do not have loose or missing insulation. If they do, you could get a shock. The vehicles could be damaged, too.

Before you connect the cables, here are some things you should know. Positive (+) will go to positive (+) or to a remote positive (+) terminal if the vehicle has one. Negative (-) will go to a heavy, unpainted metal engine part or to a remote negative (-) terminal if the vehicle with the dead battery has one.

Do not connect positive (+) to negative (-) or you will get a short that would damage the battery and maybe other parts, too. And do not connect the negative (-) cable to the negative (-) terminal on the dead battery because this can cause sparks.

6. Connect the red positive (+) cable to the positive (+) terminal of the dead battery. Use a remote positive (+) terminal if the vehicle has one.



7. Do not let the other end touch metal. Connect it to the positive (+) terminal of the good battery. Use a remote positive (+) terminal if the vehicle has one.



8. Now connect the black negative (-) cable to the negative (-) terminal of the good battery. Use a remote negative (-) terminal if the vehicle has one.

Do not let the other end touch anything until the next step. The other end of the negative (-) cable does not go to the dead battery. It goes to a heavy, unpainted metal engine part or to a remote negative (-) terminal on the vehicle with the dead battery.

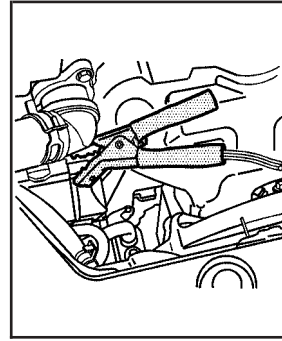

9. Connect the other end of the negative (-) cable at least 18 inches (45 cm) away from the dead battery, but not near engine parts that move. The electrical connection is just as good there, and the chance of sparks getting back to the battery is much less.

10. Now start the vehicle with the good battery and run the engine for a while.
11. Try to start the vehicle that had the dead battery. If it will not start after a few tries, it probably needs service.

Notice: If the jumper cables are removed in the wrong order, electrical shorting may occur and damage the vehicle. The repairs would not be covered by your warranty. Remove the jumper cables in the correct order, making sure that the cables do not touch each other or other metal.

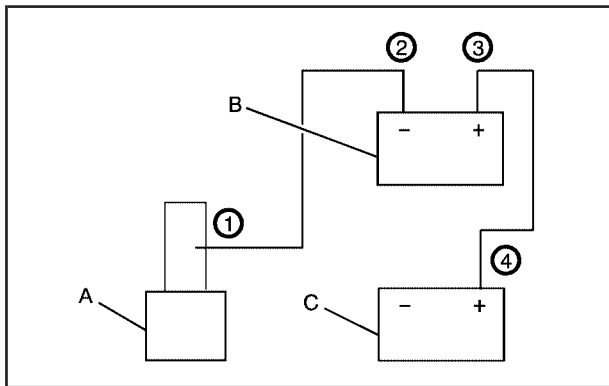

Jumper Cable Removal

- A. Heavy, Unpainted Metal Engine Part or Remote Negative (-) Terminal
- B. Good Battery or Remote Positive (+) and Remote Negative (-) Terminals
- C. Dead Battery or Remote Positive (+) Terminal

To disconnect the jumper cables from both vehicles, do the following:

1. Disconnect the black negative (-) cable from the vehicle that had the dead battery.
2. Disconnect the black negative (-) cable from the vehicle with the good battery.
3. Disconnect the red positive (+) cable from the vehicle with the good battery.
4. Disconnect the red positive (+) cable from the other vehicle.
5. Return the positive (+) terminal cap to its original position.

Headlamp Aiming

If your vehicle is damaged in an accident, the headlamp aim may be affected. Aim adjustment to the low beam may be necessary if it is difficult to see lane markers (for horizontal aim), or if oncoming drivers flash their high beams at you (for vertical aim). If you believe your headlamps need to be re-aimed, we recommend that you take your vehicle to the dealer for service. However, it is possible for you to re-aim your headlamps by following the procedure in the service manual for your vehicle.

Notice: To make sure your headlamps are aimed properly, read all the instructions before beginning. Failure to follow these instructions could cause damage to headlamp parts.

Bulb Replacement

For any bulb changing procedures not listed in this section, contact your dealer.

Halogen Bulbs



⚠ CAUTION:

Halogen bulbs have pressurized gas inside and can burst if you drop or scratch the bulb. You or others could be injured. Be sure to read and follow the instructions on the bulb package.

Headlamps

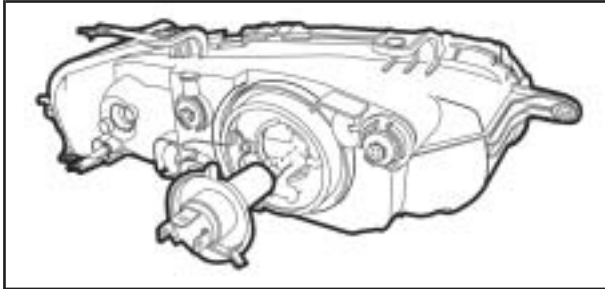

1. Open the hood.
2. Disconnect the wiring harness connector from the rear of the bulb.
3. Remove the headlamp cap.
4. Release the spring that retains the bulb.
5. Remove the old bulb.
6. Install the new bulb.
7. Install the bulb retaining spring.
8. Reverse Steps 1 through 3 to install the headlamp assembly. Then, check the lamps.

Front Turn Signal and Parking Lamps

1. Open the hood.
2. Remove the five screws and the radiator grille.
3. Remove the three bolts and the headlamp assembly.
4. Disconnect the wiring harness connector from the rear of the bulb.

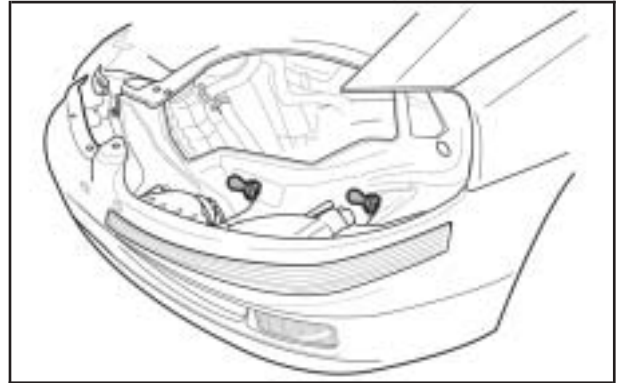

5. Turn the front turn signal bulb socket counterclockwise.

- Pull the front turn signal bulb socket out of the lamp housing.
- Press the bulb inward and turn it counterclockwise to remove it from the bulb socket.
- Install the new bulb into the socket by pressing it in and turning it clockwise.
- Install the socket into the lamp housing by turning it clockwise.
- Reverse Steps 1 through 4 to install the assembly. Then, check the lamps.

Turn Signal Lamps (Side)

- Remove the side turn signal lamp assembly by pulling it forward.
- Turn the bulb holder counterclockwise.

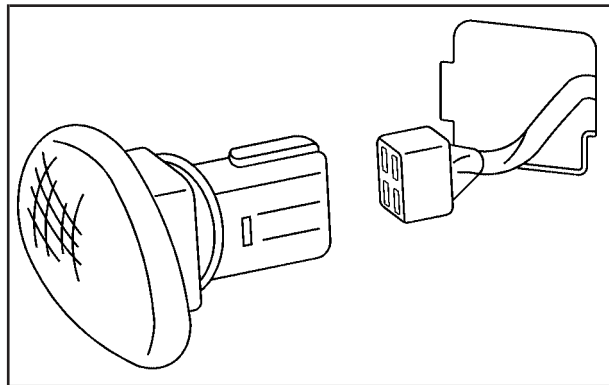

- Remove the bulb from the lamp housing by pulling the bulb straight out of the holder.
- Install the new bulb into the bulb holder by pushing it in and rotating the bulb holder clockwise.
- Push the side turn signal lamp assembly back into its original position.

Fog Lamps

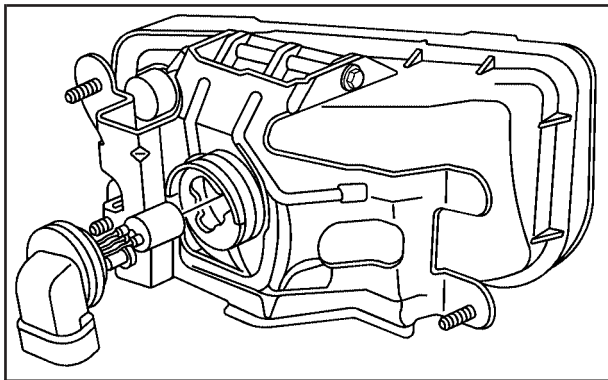

1. Disconnect the wiring harness connector from the front fog lamp bulb.
2. Turn the front fog lamp bulb counterclockwise and remove it.
3. Install the new bulb.
4. Connect the wiring harness connector to the front fog lamp bulb.

Sidemarker Lamps (Front)

1. Open the hood.
2. Remove the radiator grille and the headlamp assembly. See Steps 2 through 3 under *Front Turn Signal and Parking Lamps* on page 5-46.
3. Turn the front sidemarker bulb socket counterclockwise.

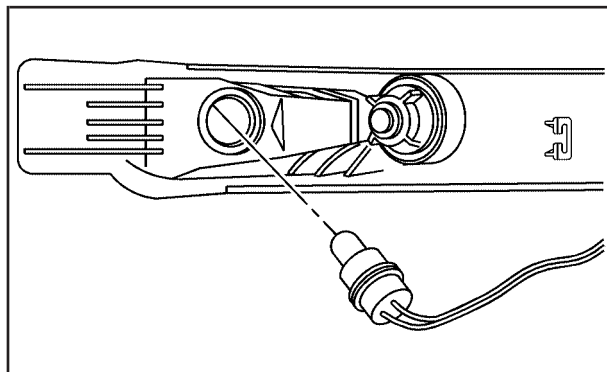

4. Pull the front sidemarker bulb socket out of the front bumper.
5. Pull the old bulb straight out from the bulb socket.
6. Install the new bulb by pressing it straight into the bulb socket.
7. Reverse Steps 1 through 4 to install the bulb socket and assembly.

Sidemarker Lamps (Rear)

1. Reach into the inside of the rear bumper and locate the rear sidemarker bulb socket.
2. Turn the socket counterclockwise.
3. Pull the socket out of the rear bumper.

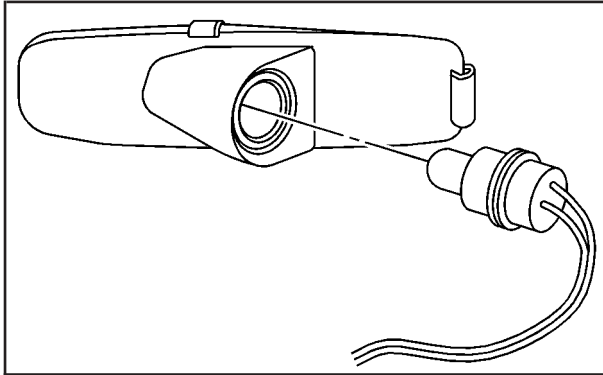

4. Pull the old bulb straight out of the socket.
5. Install the new bulb by pressing it straight into the socket.
6. Reverse Steps 1 through 3 to install the socket.

Taillamps, Turn Signal, Stoplamps and Back-up Lamps

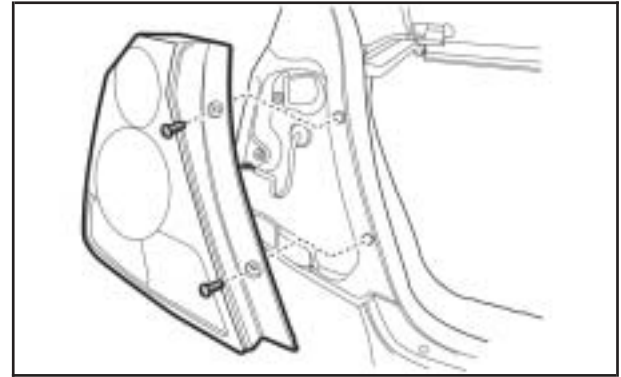

1. Open the trunk or liftgate.
2. Remove the two screws and the lamp assembly.
3. Remove the bulb socket by turning it counterclockwise.
4. Remove the bulb from the socket by pressing the bulb and turning it counterclockwise.
5. Install the appropriate bulb into the socket.
6. Replace the bulb socket into the lamp housing. Twist the bulb socket clockwise to secure.
7. Reverse Steps 1 through 2 to install the lamp housing.

Windshield Wiper Blade Replacement

Windshield wiper blades should be inspected at least twice a year for wear or cracking. See “Wiper Blade Check” under *Part B: Owner Checks and Services on page 6-19* for more information.

Replacement blades come in different types and are removed in different ways.

Here is how to remove the Shepherd's Hook type:

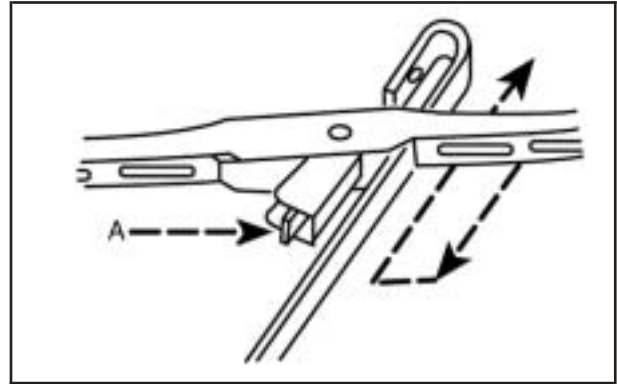

1. Pull the windshield wiper arm away from the windshield.
2. Press the retaining clip (A) and pull the wiper blade off the arm.
3. Install a new blade by reversing Steps 1 and 2.

Tires

Your new vehicle comes with high-quality tires made by a leading tire manufacturer. If you ever have questions about your tire warranty and where to obtain service, see your GM Warranty booklet for details. For additional information refer to the tire manufacturer's booklet included with your vehicle's Owner's Manual.

CAUTION:

Poorly maintained and improperly used tires are dangerous.

- **Overloading your tires can cause overheating as a result of too much friction. You could have an air-out and a serious accident. See “Loading Your Vehicle” in the Index.**

CAUTION: (Continued)

CAUTION: (Continued)

- **Underinflated tires pose the same danger as overloaded tires. The resulting accident could cause serious injury. Check all tires frequently to maintain the recommended pressure. Tire pressure should be checked when your tires are cold.**
- **Overinflated tires are more likely to be cut, punctured or broken by a sudden impact — such as when you hit a pothole. Keep tires at the recommended pressure.**
- **Worn, old tires can cause accidents. If your tread is badly worn, or if your tires have been damaged, replace them.**

Tire Sidewall Labeling

Useful information about a tire is molded into its sidewall. The examples below show a typical passenger car tire and a compact spare tire sidewall.

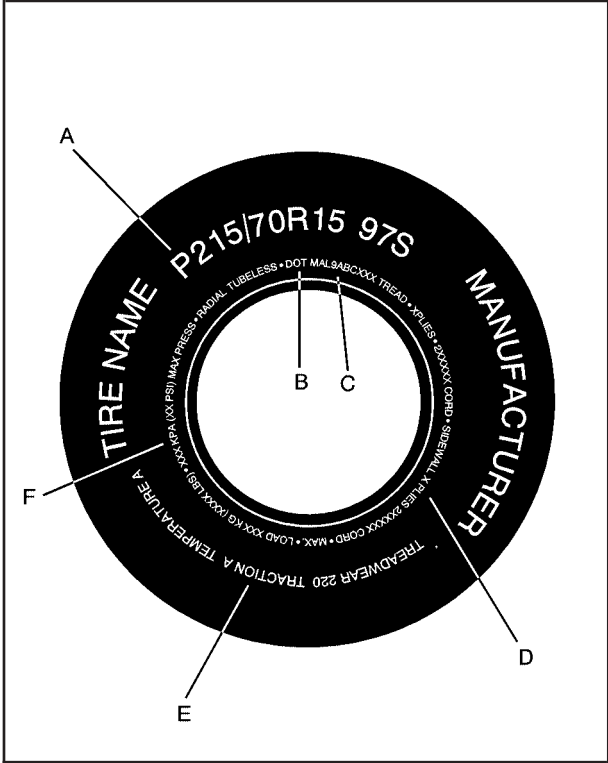

Passenger Car Tire Example

(A) Tire Size: The tire size is a combination of letters and numbers used to define a particular tire's width, height, aspect ratio, construction type and service description. See the "Tire Size" illustration later in this section for more detail.

(B) Department of Transportation (DOT): The Department of Transportation (DOT) code indicates that the tire is in compliance with the U.S. Department of Transportation Motor Vehicle Safety Standards.

(C) Tire Identification Number (TIN): The letters and numbers following DOT code are the Tire Identification Number (TIN). The TIN shows the manufacturer and plant code, tire size, and date the tire was manufactured. The TIN is molded onto both sides of the tire, although only one side may have the date of manufacture.

(D) Tire Ply Material: The type of cord and number of plies in the sidewall and under the tread.

(E) Uniform Tire Quality Grading (UTQG): Tire manufacturers are required to grade tires based on three performance factors: treadwear, traction and temperature resistance. For more information see *Uniform Tire Quality Grading on page 5-63*.

(F) Maximum Cold Inflation Load Limit: Maximum load that can be carried and the maximum pressure needed to support that load. For information on recommended tire pressure see *Inflation - Tire Pressure on page 5-59* and *Loading Your Vehicle on page 4-32*.

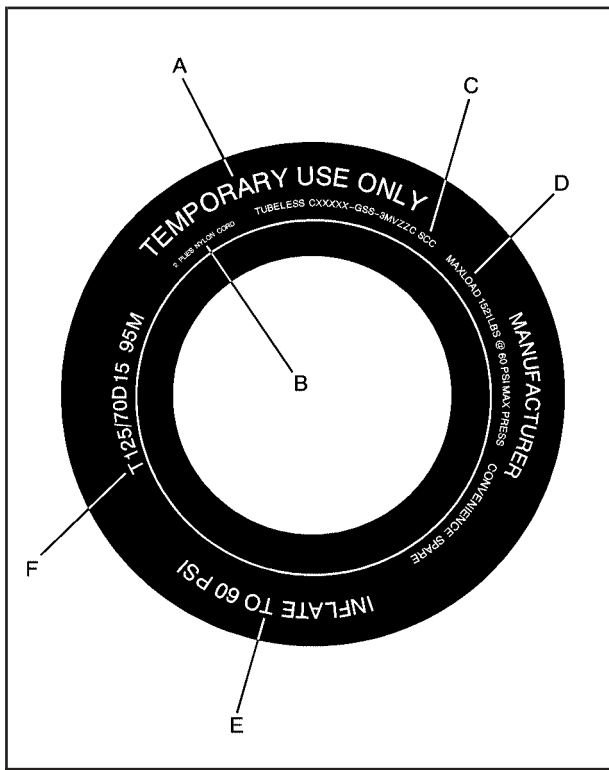

Compact Spare Tire Example

(A) Temporary Use Only: The compact spare tire or temporary use tire has a tread life of approximately 3,000 miles (5 000 km) and should not be driven at speeds over 65 mph (105 km/h). The compact spare tire is for emergency use when a regular road tire has lost air and gone flat. See *Compact Spare Tire on page 5-75* and *If a Tire Goes Flat on page 5-66*.

(B) Tire Ply Material: The type of cord and number of plies in the sidewall and under the tread.

(C) Tire Identification Number (TIN): The Tire Identification Number (TIN). The TIN shows the manufacturer and plant code, tire size, and date the tire was manufactured. The TIN is molded onto both sides of the tire, although only one side may have the date of manufacture.

(D) Maximum Cold Inflation Load Limit: Maximum load that can be carried and the maximum pressure needed to support that load. See *Compact Spare Tire on page 5-75* and *Loading Your Vehicle on page 4-32*.

(E) Tire Inflation: The temporary use tire or compact spare tire should be inflated to 60 psi (420 kPa). For more information on tire pressure and inflation see *Inflation - Tire Pressure on page 5-59*.

(F) Tire Size: A combination of letters and numbers define a tire's width, height, aspect ratio, construction type and service description. The letter "T" as the first character in the tire size means the tire is for temporary use only.

Tire Size

The following illustration shows an example of a typical passenger car tire size.

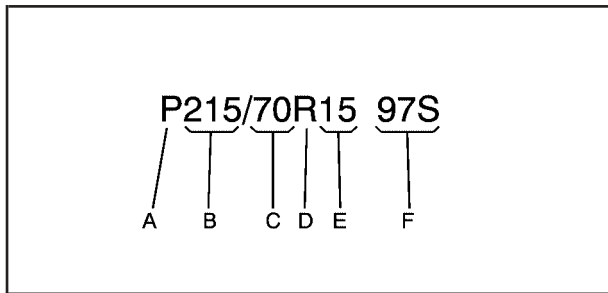

(A) Passenger (P-Metric) Tire: The United States version of a metric tire sizing system. The letter "P" as the first character in the tire size means a passenger vehicle tire engineered to standards set by the U. S. Tire and Rim Association.

(B) Tire Width: The three-digit number indicates the tire section width in millimeters from sidewall to sidewall.

(C) Aspect Ratio: A two-digit number that indicates the tire height-to-width measurements. For example, if the tire size aspect ratio is "70," as shown in item "C" of the illustration, it would mean that the tire's sidewall is 70% as high as it is wide.

(D) Construction Code: A letter code is used to indicate the type of ply construction in the tire. The letter "R" means radial ply construction; the letter "D" means diagonal or bias ply construction; and the letter "B" means belted-bias ply construction.

(E) Rim Diameter: Diameter of the wheel in inches.

(F) Service Description: These characters represent the load range and the speed rating of a tire. The load range represents the load carry capacity a tire is certified to carry. The speed rating is the maximum speed a tire is certified to carry a load. Speed ratings range from "A" to "Z".

Tire Terminology and Definitions

Air Pressure: The amount of air inside the tire pressing outward on each square inch of the tire. Air pressure is expressed in pounds per square inch (psi) or kilopascal (kPa).

Accessory Weight: This means the combined weight of optional accessories. Some examples of optional accessories are, automatic transmission, power steering, power brakes, power windows, power seats, and air conditioning.

Aspect Ratio: The relationship of a tire's height to its width.

Belt: A rubber coated layer of cords that is located between the plies and the tread. Cords may be made from steel or other reinforcing materials.

Bead: The tire bead contains steel wires that hold the tire onto the rim.

Bias Ply Tire: A pneumatic tire in which the plies are laid at alternate angles, less than 90 degrees to the centerline of the tread.

Cold Inflation Pressure: The amount of air pressure in a tire, measured in pounds per square inch (psi) or kilopascal (kPa), before a tire has built up heat from driving. See *Inflation - Tire Pressure on page 5-59*.

Curb Weight: This means the weight of a motor vehicle with standard and optional equipment including the maximum capacity of fuel, oil and coolant, but without passengers and cargo.

DOT Markings: A code molded into the sidewall of a tire signifying that the tire is in compliance with the U.S. Department of Transportation motor vehicle safety standards. The DOT code includes the Tire Identification Number (TIN), an alphanumeric designator which can also identify the tire manufacturer, production plant, brand and date of production.

GVWR: Gross Vehicle Weight Rating, see *Loading Your Vehicle on page 4-32*.

GAWR FRT: Gross Axle Weight Rating for the front axle, see *Loading Your Vehicle on page 4-32*.

GAWR RR: Gross Axle Weight Rating for the rear axle, see *Loading Your Vehicle on page 4-32*.

Intended Outboard Sidewall: The side of an asymmetrical tire that must always face outward when mounted on a vehicle.

Kilopascal (kPa): The metric unit for air pressure. There are 6.9 kPa's to one psi.

Light Truck (LT-Metric) Tire: A tire used on light duty trucks and some multipurpose passenger vehicles.

Load Index: An assigned number ranging from 1 to 279 that corresponds to the load carrying capacity of a tire.

Maximum Inflation Pressure: The maximum cold inflation pressure to which a tire may be inflated.

Maximum Load Rating: The load rating for a tire at the maximum permissible inflation pressure for that tire.

Maximum Loaded Vehicle Weight: The sum of curb weight; accessory weight; vehicle capacity weight; and production options weight.

Normal Occupant Weight: The number of occupants a vehicle is designed to seat multiplied by 150 pounds (68 kg). See *Loading Your Vehicle on page 4-32*.

Occupant Distribution: Designated seating positions.

Outward Facing Sidewall: The side of a asymmetrical tire that has a particular side that faces outward when mounted on a vehicle. The side of the tire that contains a whitewall, bears white lettering or bears manufacturer, brand and or model name molding that is higher or deeper than the same moldings on the other sidewall of the tire.

Passenger (P-Metric) Tire: A tire used on passenger cars and some light duty trucks and multipurpose vehicles.

Recommended Inflation Pressure: Vehicle manufacturer's recommended tire inflation pressure shown on the tire placard. See *Inflation - Tire Pressure on page 5-59* and *Loading Your Vehicle on page 4-32*.

Radial Ply tire: A pneumatic tire in which the ply cords that extend to the beads are laid at 90 degrees to the centerline of the tread.

Rim: A metal support for a tire and upon which the tire beads are seated.

Sidewall: The portion of a tire between the tread and the bead.

Speed Rating: An alphanumeric code assigned to a tire indicating the maximum speed at which a tire can operate.

Traction: The friction between the tire and the road surface. The amount of grip provided.

Tread: The portion of a tire that comes into contact with the road.

Treadwear Indicators: Narrow bands, sometimes called “wear bars,” that show across the tread of a tire when only 2/32 inch of tread remains. See *When It Is Time for New Tires on page 5-61*.

Tread Width: The width of the tire's tread.

UTQGS: Uniform Tire Quality Grading Standards, a tire information system that provides consumers with ratings for a tire's traction, temperature and treadwear. Ratings are determined by tire manufacturers using government testing procedures. The ratings are molded into the sidewall of the tire. See *Uniform Tire Quality Grading on page 5-63*.

Vehicle Capacity Weight: The number of designated seating positions multiplied by 150 pounds (68 kg) plus the rated cargo load. See *Loading Your Vehicle on page 4-32*.

Vehicle Maximum Load on the Tire: Load on an individual tire due to curb weight, accessory weight, occupant weight and cargo weight.

Vehicle Placard: A label permanently attached to a vehicle showing original equipment tire size and the recommended cold inflation pressure. See *Loading Your Vehicle on page 4-32*.

Inflation - Tire Pressure

The tire and loading information label, shows the correct inflation pressures for your tires when they're cold. "Cold" means your vehicle has been sitting for at least three hours or driven no more than 1 mile (1.6 km). See *Loading Your Vehicle on page 4-32*, for the location of your vehicle's tire and loading information label.

Notice: Don't let anyone tell you that underinflation or overinflation is all right. It's not. If your tires don't have enough air (underinflation), you can get the following:

- Too much flexing
- Too much heat
- Tire overloading
- Bad wear
- Bad handling
- Bad fuel economy

If your tires have too much air (overinflation), you can get the following:

- Unusual wear
- Bad handling
- Rough ride
- Needless damage from road hazards

When to Check

Check your tires once a month or more.

Don't forget your compact spare tire. It should be at 60 psi (420 kPa).

How to Check

Use a good quality pocket-type gage to check tire pressure. You can't tell if your tires are properly inflated simply by looking at them. Radial tires may look properly inflated even when they're underinflated. Check the tire's inflation pressure when the tires are cold. Cold means your vehicle has been sitting for at least three hours or driven no more than 1 mile (1.6 km).

Remove the valve cap from the tire valve stem. Press the tire gage firmly onto the valve to get a pressure measurement. If the cold tire inflation pressure matches the recommended pressure on the Tire and Loading Information label, no further adjustment is necessary. If the inflation pressure is low, add air until you reach the recommended amount.

If you overfill the tire, release air by pushing on the metal stem in the center of the tire valve. Recheck the tire pressure with the tire gage.

Be sure to put the valve caps back on the valve stems. They help prevent leaks by keeping out dirt and moisture.

Tire Inspection and Rotation

Tires should be rotated every 5,000 to 8,000 miles (8 000 to 13 000 km).

Any time you notice unusual wear, rotate your tires as soon as possible and check wheel alignment. Also check for damaged tires or wheels. See *When It Is Time for New Tires* on page 5-61 and *Wheel Replacement* on page 5-64 for more information.

The purpose of regular rotation is to achieve more uniform wear for all tires on the vehicle. The first rotation is the most important. See *Part A: Scheduled Maintenance Services* on page 6-4 for scheduled rotation intervals.

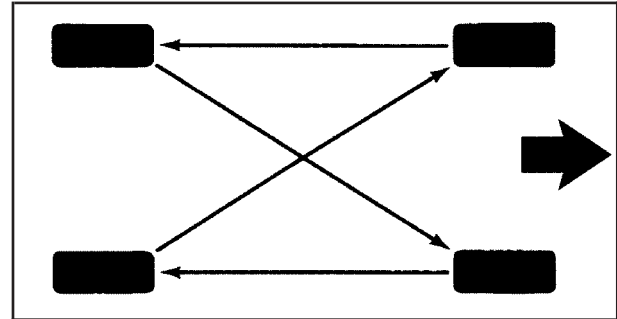

When rotating your tires, always use the correct rotation pattern shown here.

Don't include the compact spare tire in your tire rotation.

After the tires have been rotated, adjust the front and rear inflation pressures as shown on the tire and loading information label. Make certain that all wheel nuts are properly tightened. See “Wheel Nut Torque” under *Capacities and Specifications on page 5-91*.

⚠ CAUTION:

Rust or dirt on a wheel, or on the parts to which it is fastened, can make wheel nuts become loose after a time. The wheel could come off and cause an accident. When you change a wheel, remove any rust or dirt from places where the wheel attaches to the vehicle. In an emergency, you can use a cloth or a paper towel to do this; but be sure to use a scraper or wire brush later, if you need to, to get all the rust or dirt off. See “Changing a Flat Tire” in the Index.

When It Is Time for New Tires

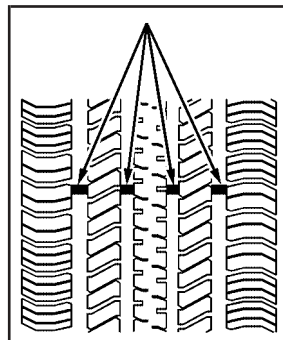

One way to tell when it's time for new tires is to check the treadwear indicators, which will appear when your tires have only 1/16 inch (1.6 mm) or less of tread remaining.

You need a new tire if any of the following statements are true:

- You can see the indicators at three or more places around the tire.
- You can see cord or fabric showing through the tire's rubber.
- The tread or sidewall is cracked, cut or snagged deep enough to show cord or fabric.
- The tire has a bump, bulge or split.
- The tire has a puncture, cut or other damage that can't be repaired well because of the size or location of the damage.

Buying New Tires

To find out what kind and size of tires you need, look at the Tire-Loading Information label.

Make sure the replacements are the same size, load range, speed rating and construction type (bias, bias-belted or radial) as your original tires.

CAUTION:

Mixing tires could cause you to lose control while driving. If you mix tires of different sizes or types (radial and bias-belted tires), the vehicle may not handle properly, and you could have a crash. Using tires of different sizes may also cause damage to your vehicle. Be sure to use the same size and type tires on all wheels. It's all right to drive with your compact spare temporarily, it was developed for use on your vehicle. See "Compact Spare Tire" in the Index.

CAUTION:

If you use bias-ply tires on your vehicle, the wheel rim flanges could develop cracks after many miles of driving. A tire and/or wheel could fail suddenly, causing a crash. Use only radial-ply tires with the wheels on your vehicle.

Uniform Tire Quality Grading

Quality grades can be found where applicable on the tire sidewall between tread shoulder and maximum section width. For example:

Treadwear 200 Traction AA Temperature A

The following information relates to the system developed by the United States National Highway Traffic Safety Administration, which grades tires by treadwear, traction and temperature performance. (This applies only to vehicles sold in the United States.)

The grades are molded on the sidewalls of most passenger car tires. The Uniform Tire Quality Grading system does not apply to deep tread, winter-type snow tires, space-saver or temporary use spare tires, tires with nominal rim diameters of 10 to 12 inches (25 to 30 cm), or to some limited-production tires.

While the tires available on General Motors passenger cars and light trucks may vary with respect to these grades, they must also conform to federal safety requirements and additional General Motors Tire Performance Criteria (TPC) standards.

Treadwear

The treadwear grade is a comparative rating based on the wear rate of the tire when tested under controlled conditions on a specified government test course. For example, a tire graded 150 would wear one and a half (1.5) times as well on the government course as a tire graded 100. The relative performance of tires depends upon the actual conditions of their use, however, and may depart significantly from the norm due to variations in driving habits, service practices and differences in road characteristics and climate.

Traction – AA, A, B, C

The traction grades, from highest to lowest, are AA, A, B, and C. Those grades represent the tire's ability to stop on wet pavement as measured under controlled conditions on specified government test surfaces of asphalt and concrete. A tire marked C may have poor traction performance. Warning: The traction grade assigned to this tire is based on straight-ahead braking traction tests, and does not include acceleration, cornering, hydroplaning, or peak traction characteristics.

Temperature – A, B, C

The temperature grades are A (the highest), B, and C, representing the tire's resistance to the generation of heat and its ability to dissipate heat when tested under controlled conditions on a specified indoor laboratory test wheel. Sustained high temperature can cause the material of the tire to degenerate and reduce tire life, and excessive temperature can lead to sudden tire failure. The grade C corresponds to a level of performance which all passenger car tires must meet under the Federal Motor Vehicle Safety Standard No. 109. Grades B and A represent higher levels of performance on the laboratory test wheel than the minimum required by law.

Warning: The temperature grade for this tire is established for a tire that is properly inflated and not overloaded. Excessive speed, underinflation, or excessive loading, either separately or in combination, can cause heat buildup and possible tire failure.

Wheel Alignment and Tire Balance

The wheels on your vehicle were aligned and balanced carefully at the factory to give you the longest tire life and best overall performance.

Scheduled wheel alignment and wheel balancing are not needed. However, if you notice unusual tire wear or your vehicle pulling one way or the other, the alignment may need to be reset. If you notice your vehicle vibrating when driving on a smooth road, your wheels may need to be rebalanced.

Wheel Replacement

Replace any wheel that is bent, cracked or badly rusted or corroded. If wheel nuts keep coming loose, the wheel, wheel bolts and wheel nuts should be replaced. If the wheel leaks air, replace it (except some aluminum wheels, which can sometimes be repaired). See your dealer if any of these conditions exist.

Your dealer will know the kind of wheel you need.

Each new wheel should have the same load-carrying capacity, diameter, width, offset and be mounted the same way as the one it replaces.

If you need to replace any of your wheels, wheel bolts or wheel nuts, replace them only with new GM original equipment parts. This way, you will be sure to have the right wheel, wheel bolts and wheel nuts for your vehicle.

 **CAUTION:**

Using the wrong replacement wheels, wheel bolts or wheel nuts on your vehicle can be dangerous. It could affect the braking and handling of your vehicle, make your tires lose air and make you lose control. You could have a collision in which you or others could be injured. Always use the correct wheel, wheel bolts and wheel nuts for replacement.

Notice: The wrong wheel can also cause problems with bearing life, brake cooling, speedometer or odometer calibration, headlamp aim, bumper height, vehicle ground clearance and tire or tire chain clearance to the body and chassis.

See *Changing a Flat Tire* on page 5-67 for more information.

Used Replacement Wheels

 **CAUTION:**

Putting a used wheel on your vehicle is dangerous. You can't know how it's been used or how far it's been driven. It could fail suddenly and cause a crash. If you have to replace a wheel, use a new GM original equipment wheel.

Tire Chains

Notice: Use tire chains only where legal and only when you must. Use only SAE Class “S” type chains that are the proper size for your tires. Install them on the front tires and tighten them as tightly as possible with the ends securely fastened. Drive slowly and follow the chain manufacturer’s instructions. If you can hear the chains contacting your vehicle, stop and retighten them. If the contact continues, slow down until it stops. Driving too fast or spinning the wheels with chains on will damage your vehicle.

If a Tire Goes Flat

It’s unusual for a tire to “blowout” while you’re driving, especially if you maintain your tires properly. If air goes out of a tire, it’s much more likely to leak out slowly. But if you should ever have a “blowout,” here are a few tips about what to expect and what to do:

If a front tire fails, the flat tire will create a drag that pulls the vehicle toward that side. Take your foot off the accelerator pedal and grip the steering wheel firmly. Steer to maintain lane position, and then gently brake to a stop well out of the traffic lane.

A rear blowout, particularly on a curve, acts much like a skid and may require the same correction you’d use in a skid. In any rear blowout, remove your foot from the accelerator pedal. Get the vehicle under control by steering the way you want the vehicle to go. It may be very bumpy and noisy, but you can still steer. Gently brake to a stop, well off the road if possible.

CAUTION:

Lifting a vehicle and getting under it to do maintenance or repairs is dangerous without the appropriate safety equipment and training. The jack provided with your vehicle is designed only for changing a flat tire. If it is used for anything else, you or others could be badly injured or killed if the vehicle slips off the jack. Use the jack provided with your vehicle only for changing a flat tire.

If a tire goes flat, the next part shows how to use your jacking equipment to change a flat tire safely.

Changing a Flat Tire

If a tire goes flat, avoid further tire and wheel damage by driving slowly to a level place. Turn on your hazard warning flashers.

CAUTION:

Changing a tire can be dangerous. The vehicle can slip off the jack and roll over or fall on you or other people. You and they could be badly injured or even killed. Find a level place to change your tire. To help prevent the vehicle from moving:

1. Set the parking brake firmly.
2. Put an automatic transaxle shift lever in PARK (P), or shift a manual transaxle to FIRST (1) or REVERSE (R).
3. Turn off the engine and do not restart while the vehicle is raised.
4. Do not allow passengers to remain in the vehicle.

CAUTION: (Continued)

CAUTION: (Continued)

To be even more certain the vehicle won't move, you should put blocks at the front and rear of the tire farthest away from the one being changed. That would be the tire on the other side, at the opposite end of the vehicle.

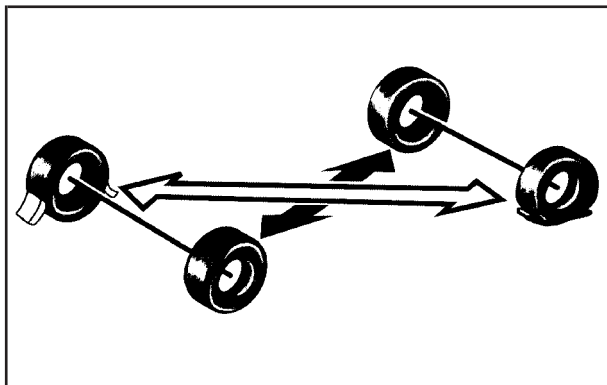

The following steps will tell you how to use the jack and change a tire.

Removing the Spare Tire and Tools

The compact spare tire and tools you will need are located in the cargo area.

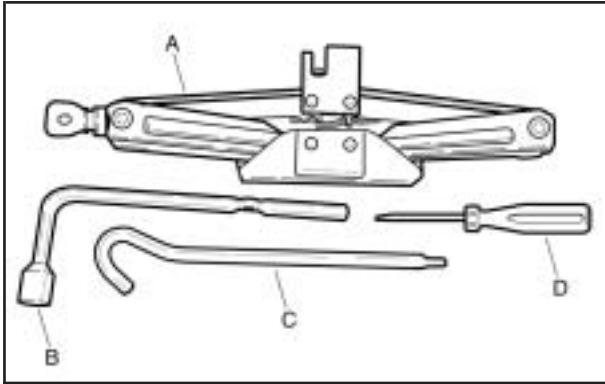

A. Jack

B. Wheel Wrench

C. Jack Handle

D. Screwdriver

1. Lift the trim cover.

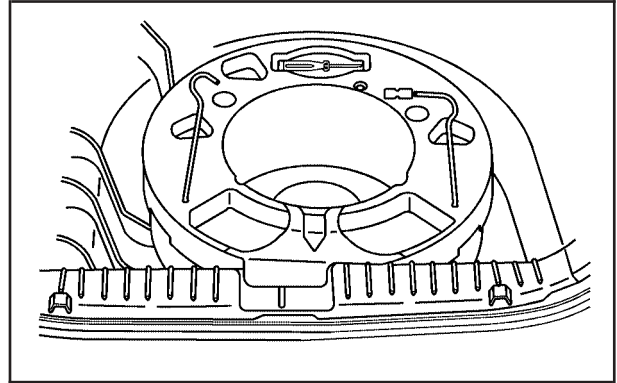

2. Remove the foam tray from the cargo area. Remove the jack, the jack handle and the wheel wrench from the foam tray. The jack is stored in the front center area of the foam tray.

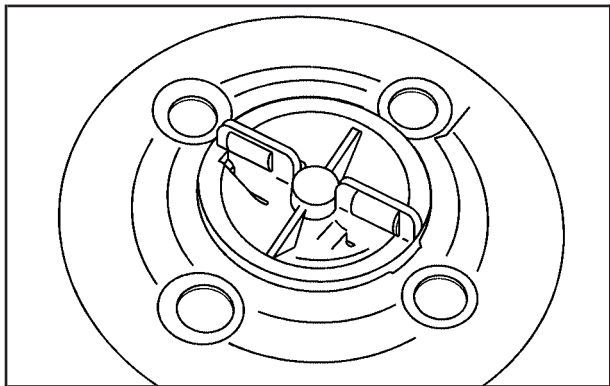

3. Turn the retainer on the compact spare tire counterclockwise and remove the retainer.
4. Remove the compact spare tire. See *Compact Spare Tire* on page 5-75 for more information.

Removing the Flat Tire and Installing the Spare Tire

1. If your vehicle has wheel covers, use the jack handle to begin loosening the wheel covers. Using the flat end of the jack handle or the screwdriver, pry along the edge of the wheel cover until it comes off.

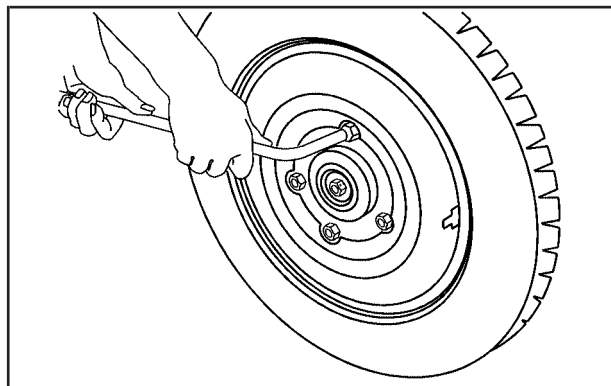

2. Use the wheel wrench to loosen all the wheel nuts. Do not remove them yet.

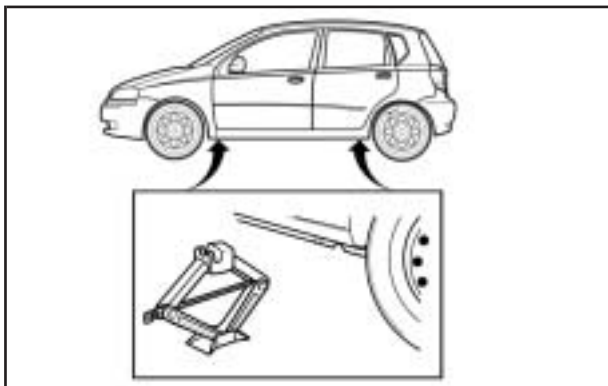

Hatchback shown, Sedan similar

3. Near each wheel is a notch in the frame which the jack head fits in.

Position the jack and raise the jack head until it fits firmly into the notch in the vehicle's frame nearest the flat tire. Put the compact spare tire near you.

⚠ CAUTION:

Getting under a vehicle when it is jacked up is dangerous. If the vehicle slips off the jack you could be badly injured or killed. Never get under a vehicle when it is supported only by a jack.

⚠ CAUTION:

Raising your vehicle with the jack improperly positioned can damage the vehicle and even make the vehicle fall. To help avoid personal injury and vehicle damage, be sure to fit the jack lift head into the proper location before raising the vehicle.

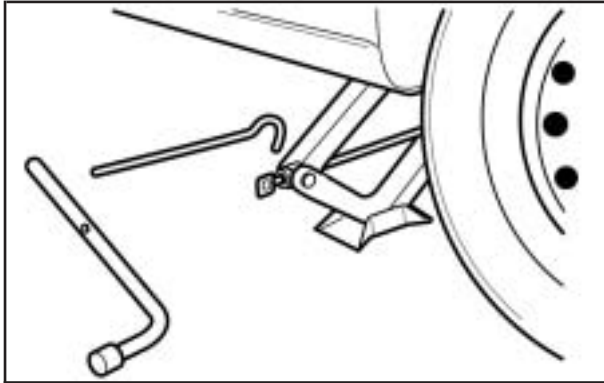

4. Insert the jack handle into the jack and the wheel wrench onto the end of the jack handle.

5. Raise the vehicle by turning the wheel wrench clockwise. Raise the vehicle far enough off the ground so there is enough room for the compact spare tire to fit underneath the wheel well.
6. Remove all of the wheel nuts by turning them counterclockwise.
7. Remove the flat tire.

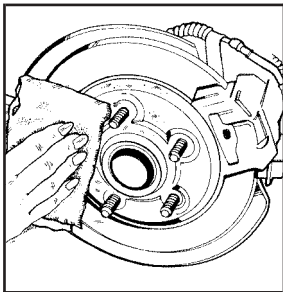

8. Remove any rust or dirt from the wheel bolts, mounting surfaces and spare wheel.

⚠ CAUTION:

Rust or dirt on the wheel, or on the parts to which it is fastened, can make the wheel nuts become loose after a time. The wheel could come off and cause an accident. When you change a wheel, remove any rust or dirt from the places where the wheel attaches to the vehicle. In an emergency, you can use a cloth or a paper towel to do this; but be sure to use a scraper or wire brush later, if you need to, to get all the rust or dirt off.

⚠ CAUTION:

Never use oil or grease on studs or nuts. If you do, the nuts might come loose. Your wheel could fall off, causing a serious accident.

9. Place the compact spare tire on the wheel-mounting surface.
10. Install the wheel nuts with the rounded end of the nuts toward the wheel. Tighten each nut by hand clockwise until the wheel is held against the hub.
11. Lower the vehicle by turning the wheel wrench counterclockwise. Lower the jack completely.

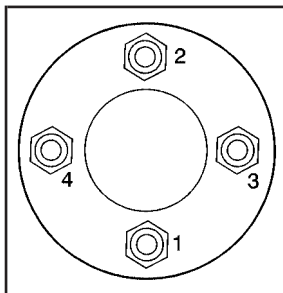

12. Tighten the wheel nuts firmly in a crisscross sequence, as shown.

Notice: Improperly tightened wheel nuts can lead to brake pulsation and rotor damage. To avoid expensive brake repairs, evenly tighten the wheel nuts in the proper sequence and to the proper torque specification. See “Capacities and Specifications” in the Index for the wheel nut torque specification.

Do not try to put a wheel cover on your compact spare tire. It will not fit. Store the wheel cover in the cargo area until you have the flat tire repaired or replaced.

Notice: Wheel covers will not fit on your compact spare. If you try to put a wheel cover on the compact spare, you could damage the cover or the spare.

⚠ CAUTION:

Incorrect wheel nuts or improperly tightened wheel nuts can cause the wheel to come loose and even come off. This could lead to an accident. Be sure to use the correct wheel nuts. If you have to replace them, be sure to get new GM original equipment wheel nuts. Stop somewhere as soon as you can and have the nuts tightened with a torque wrench to the proper torque specification. See “Capacities and Specifications” in the Index for wheel nut torque specification.

Storing the Flat Tire and Tools

CAUTION:

Storing a jack, a tire, or other equipment in the passenger compartment of the vehicle could cause injury. In a sudden stop or collision, loose equipment could strike someone. Store all these in the proper place.

Store the flat tire in the compact spare tire compartment. Place the tire in the compartment, then secure the retainer. Store the tools securely in the foam tray and place the tray back in the cargo area. Replace the trim cover.

Storing the Spare Tire and Tools

CAUTION:

Storing a jack, a tire, or other equipment in the passenger compartment of the vehicle could cause injury. In a sudden stop or collision, loose equipment could strike someone. Store all these in the proper place.

Store the compact spare tire in the compact spare tire compartment. Place the compact spare tire in the compartment, then secure the retainer. Store the tools securely in the foam tray and place the tray back in the cargo area. Replace the trim cover.

The compact spare tire is for temporary use only. Replace the compact spare tire with a full-size tire as soon as you can. See *Compact Spare Tire* on page 5-75.

Compact Spare Tire

Although the compact spare tire was fully inflated when your vehicle was new, it can lose air after a time. Check the inflation pressure regularly. It should be 60 psi (420 kPa).

After installing the compact spare on your vehicle, you should stop as soon as possible and make sure your spare tire is correctly inflated. The compact spare is made to perform well at speeds up to 50 mph (80 km/h), so you can finish your trip and have your full-size tire repaired or replaced where you want. Of course, it is best to replace your spare with a full-size tire as soon as you can. Your spare will last longer and be in good shape in case you need it again.

Notice: When the compact spare is installed, don't take your vehicle through an automatic car wash with guide rails. The compact spare can get caught on the rails. That can damage the tire and wheel, and maybe other parts of your vehicle.

Do not use your compact spare on other vehicles.

And do not mix your compact spare tire or wheel with other wheels or tires. They will not fit. Keep your spare tire and its wheel together.

Notice: Tire chains won't fit your compact spare. Using them can damage your vehicle and can damage the chains too. Don't use tire chains on your compact spare.

Appearance Care

Remember, cleaning products can be hazardous. Some are toxic. Others can burst into flames if you strike a match or get them on a hot part of the vehicle. Some are dangerous if you breathe their fumes in a closed space. When you use anything from a container to clean your vehicle, be sure to follow the manufacturer's warnings and instructions. And always open your doors or windows when you are cleaning the inside.

Never use these to clean your vehicle:

- Gasoline
- Benzene
- Naphtha
- Carbon Tetrachloride
- Acetone
- Paint Thinner
- Turpentine
- Lacquer Thinner
- Nail Polish Remover

They can all be hazardous — some more than others — and they can all damage your vehicle, too.

Do not use any of these unless this manual says you can. In many uses, these will damage your vehicle:

- Alcohol
- Laundry Soap
- Bleach
- Reducing Agents

Cleaning the Inside of Your Vehicle

Use a vacuum cleaner often to get rid of dust and loose dirt. Wipe vinyl, leather, plastic and painted surfaces with a clean, damp cloth.

Cleaning Fabric/Carpet

Your dealer has cleaners for the cleaning of fabric and carpet. They will clean normal spots and stains very well.

You can get GM-approved cleaning products from your dealer. See *Vehicle Care/Appearance Materials on page 5-82*.

Here are some cleaning tips:

- Always read the instructions on the cleaner label.
- Clean up stains as soon as you can — before they set.
- Carefully scrape off any excess stain.
- Use a clean cloth or sponge, and change to a clean area often. A soft brush may be used if stains are stubborn.
- If a ring forms on fabric after spot cleaning, clean the entire area immediately or it will set.

Using Cleaner on Fabric

1. Vacuum and brush the area to remove any loose dirt.
2. Always clean a whole trim panel or section. Mask surrounding trim along stitch or welt lines.
3. Follow the directions on the container label.
4. Apply cleaner with a clean sponge. Do not saturate the material and do not rub it roughly.
5. As soon as you have cleaned the section, use a sponge to remove any excess cleaner.
6. Wipe cleaned area with a clean, water-dampened towel or cloth.
7. Wipe with a clean cloth and let dry.

Special Fabric Cleaning Problems

Stains caused by such things as catsup, coffee (black), egg, fruit, fruit juice, milk, soft drinks, vomit, urine and blood can be removed as follows:

1. Carefully scrape off excess stain, then sponge the soiled area with cool water.
2. If a stain remains, follow the cleaning instructions described earlier.
3. If an odor lingers after cleaning vomit or urine, treat the area with a water and baking soda solution: 1 teaspoon (5 ml) of baking soda to 1 cup (250 ml) of lukewarm water.
4. Let dry.

Stains caused by candy, ice cream, mayonnaise, chili sauce and unknown stains can be removed as follows:

1. Carefully scrape off excess stain.
2. Clean with cool water and allow to dry completely.
3. If a stain remains, follow the cleaner instructions described earlier.

Cleaning Vinyl

Use warm water and a clean cloth.

- Rub with a clean, damp cloth to remove dirt. You may have to do this more than once.
- Things like tar, asphalt and shoe polish will stain if you do not get them off quickly. Use a clean cloth and vinyl cleaner. See your dealer for this product.

Cleaning Leather

Use a soft cloth with lukewarm water and a mild soap or saddle soap and wipe dry with a soft cloth. Then, let the leather dry naturally. Do not use heat to dry.

- For stubborn stains, use a leather cleaner.
- *Never* use oils, varnishes, solvent-based or abrasive cleaners, furniture polish or shoe polish on leather.
- Soiled or stained leather should be cleaned immediately. If dirt is allowed to work into the finish, it can harm the leather.

Cleaning the Top of the Instrument Panel

Use only mild soap and water to clean the top surfaces of the instrument panel. Sprays containing silicones or waxes may cause annoying reflections in the windshield and even make it difficult to see through the windshield under certain conditions.

Cleaning Interior Plastic Components

Use only a mild soap and water solution on a soft cloth or sponge. Commercial cleaners may affect the surface finish.

Cleaning Glass Surfaces

Glass should be cleaned often. GM Glass Cleaner or a liquid household glass cleaner will remove normal tobacco smoke and dust films on interior glass. See *Vehicle Care/Appearance Materials on page 5-82*.

Notice: If you use abrasive cleaners when cleaning glass surfaces on your vehicle, you could scratch the glass and/or cause damage to the rear window defogger and the integrated radio antenna. When cleaning the glass on your vehicle, use only a soft cloth and glass cleaner.

Care of Safety Belts

Keep belts clean and dry.

CAUTION:

Do not bleach or dye safety belts. If you do, it may severely weaken them. In a crash, they might not be able to provide adequate protection. Clean safety belts only with mild soap and lukewarm water.

Weatherstrips

Silicone grease on weatherstrips will make them last longer, seal better, and not stick or squeak. Apply silicone grease with a clean cloth at least every six months. During very cold, damp weather more frequent application may be required. See *Part D: Recommended Fluids and Lubricants on page 6-26*.

Cleaning the Outside of Your Vehicle

The paint finish on your vehicle provides beauty, depth of color, gloss retention and durability.

Washing Your Vehicle

The best way to preserve your vehicle's finish is to keep it clean by washing it often with lukewarm or cold water.

Do not wash your vehicle in the direct rays of the sun. Use a car washing soap. Do not use strong soaps or chemical detergents. Be sure to rinse the vehicle well, removing all soap residue completely. You can get GM-approved cleaning products from your dealer. See *Vehicle Care/Appearance Materials on page 5-82*.

Do not use cleaning agents that are petroleum based, or that contain acid or abrasives. All cleaning agents should be flushed promptly and not allowed to dry on the surface, or they could stain. Dry the finish with a soft, clean chamois or an all-cotton towel to avoid surface scratches and water spotting.

High pressure car washes may cause water to enter your vehicle.

Cleaning Exterior Lamps/Lenses

Use only lukewarm or cold water, a soft cloth and a car washing soap to clean exterior lamps and lenses. Follow instructions under “Washing Your Vehicle.”

Finish Care

Occasional waxing or mild polishing of your vehicle by hand may be necessary to remove residue from the paint finish. You can get GM-approved cleaning products from your dealer. See *Vehicle Care/Appearance Materials* on page 5-82.

Your vehicle has a “basecoat/clearcoat” paint finish. The clearcoat gives more depth and gloss to the colored basecoat. Always use waxes and polishes that are non-abrasive and made for a basecoat/clearcoat paint finish.

Notice: Machine compounding or aggressive polishing on a basecoat/clearcoat paint finish may damage it. Use only non-abrasive waxes and polishes that are made for a basecoat/clearcoat paint finish on your vehicle.

Foreign materials such as calcium chloride and other salts, ice melting agents, road oil and tar, tree sap, bird droppings, chemicals from industrial chimneys, etc., can damage your vehicle’s finish if they remain on

painted surfaces. Wash the vehicle as soon as possible. If necessary, use non-abrasive cleaners that are marked safe for painted surfaces to remove foreign matter.

Exterior painted surfaces are subject to aging, weather and chemical fallout that can take their toll over a period of years. You can help to keep the paint finish looking new by keeping your vehicle garaged or covered whenever possible.

Cleaning Windshield and Wiper Blades

If the windshield is not clear after using the windshield washer, or if the wiper blade chatters when running, wax, sap or other material may be on the blade or windshield.

Clean the outside of the windshield with a full-strength glass cleaning liquid. The windshield is clean if beads do not form when you rinse it with water.

Grime from the windshield will stick to the wiper blades and affect their performance. Clean the blade by wiping vigorously with a cloth soaked in full-strength windshield washer solvent. Then rinse the blade with water.

Check the wiper blades and clean them as necessary; replace blades that look worn.

Cleaning Aluminum Wheels

Keep your wheels clean using a soft clean cloth with mild soap and water. Rinse with clean water. After rinsing thoroughly, dry with a soft clean towel. A wax may then be applied.

The surface of these wheels is similar to the painted surface of your vehicle. Do not use strong soaps, chemicals, abrasive polishes, abrasive cleaners, cleaners with acid, or abrasive cleaning brushes on them because you could damage the surface. Do not use chrome polish on aluminum wheels.

Do not take your vehicle through an automatic car wash that has silicone carbide tire cleaning brushes. These brushes can also damage the surface of these wheels.

Cleaning Tires

To clean your tires, use a stiff brush with tire cleaner.

Notice: Using petroleum-based tire dressing products on your vehicle may damage the paint finish and/or tires. When applying a tire dressing, always wipe off any overspray from all painted surfaces on your vehicle.

Sheet Metal Damage

If your vehicle is damaged and requires sheet metal repair or replacement, make sure the body repair shop applies anti-corrosion material to parts repaired or replaced to restore corrosion protection.

Original manufacturer replacement parts will provide the corrosion protection while maintaining the warranty.

Finish Damage

Any stone chips, fractures or deep scratches in the finish should be repaired right away. Bare metal will corrode quickly and may develop into major repair expense.

Minor chips and scratches can be repaired with touch-up materials available from your dealer. Larger areas of finish damage can be corrected in your dealer's body and paint shop.

Underbody Maintenance

Chemicals used for ice and snow removal and dust control can collect on the underbody. If these are not removed, corrosion and rust can develop on the underbody parts such as fuel lines, frame, floor pan and exhaust system even though they have corrosion protection.

At least every spring, flush these materials from the underbody with plain water. Clean any areas where mud and debris can collect. Dirt packed in close areas of the frame should be loosened before being flushed. Your dealer or an underbody car washing system can do this for you.

Chemical Paint Spotting

Some weather and atmospheric conditions can create a chemical fallout. Airborne pollutants can fall upon and attack painted surfaces on your vehicle. This damage can take two forms: blotchy, ring-shaped discolorations, and small, irregular dark spots etched into the paint surface.

Although no defect in the paint job causes this, GM will repair, at no charge to the owner, the surfaces of new vehicles damaged by this fallout condition within 12 months or 12,000 miles (20 000 km) of purchase, whichever occurs first.

Vehicle Care/Appearance Materials

See your GM dealer for more information on purchasing the following products.

Vehicle Care/Appearance Materials

Description	Usage
Polishing Cloth Wax-Treated	Interior and exterior polishing cloth.
Tar and Road Oil Remover	Removes tar, road oil and asphalt.
Chrome Cleaner and Polish	Use on chrome or stainless steel.
White Sidewall Tire Cleaner	Removes soil and black marks from whitewalls.
Vinyl Cleaner	Cleans vinyl tops, upholstery and convertible tops.
Glass Cleaner	Removes dirt, grime, smoke and fingerprints.
Chrome and Wire Wheel Cleaner	Removes dirt and grime from chrome wheels and wire wheel covers.
Finish Enhancer	Removes dust, fingerprints, and surface contaminants. Spray on wipe off.

Vehicle Care/Appearance Materials (cont'd)

Description	Usage
Swirl Remover Polish	Removes swirl marks, fine scratches and other light surface contamination.
Cleaner Wax	Removes light scratches and protects finish.
Foaming Tire Shine Low Gloss	Cleans, shines and protects in one easy step, no wiping necessary.
Wash Wax Concentrate	Medium foaming shampoo. Cleans and lightly waxes. Biodegradable and phosphate free.
Spot Lifter	Quickly and easily removes spots and stains from carpets, vinyl and cloth upholstery.
Odor Eliminator	Odorless spray odor eliminator used on fabrics, vinyl, leather and carpet.
See your General Motors parts department for these products. See <i>Part D: Recommended Fluids and Lubricants on page 6-26.</i>	

Vehicle Identification

Vehicle Identification Number (VIN)



This is the legal identifier for your vehicle. It appears on a plate in the front corner of the instrument panel, on the driver's side. You can see it if you look through the windshield from outside your vehicle. The VIN also appears on the Vehicle Certification and Service Parts labels and the certificates of title and registration.

Engine Identification

The 8th character in your VIN is the engine code. This code will help you identify your engine, specifications and replacement parts.

Service Parts Identification Label

You will find this label inside of the glove box. It is very helpful if you ever need to order parts. On this label is:

- your VIN,
- the model designation,
- paint information and
- a list of all production options and special equipment.

Be sure that this label is not removed from the vehicle.

Electrical System

Add-On Electrical Equipment

Notice: Don't add anything electrical to your vehicle unless you check with your dealer first. Some electrical equipment can damage your vehicle and the damage wouldn't be covered by your warranty. Some add-on electrical equipment can keep other components from working as they should.

Your vehicle has an air bag system. Before attempting to add anything electrical to your vehicle, see *Servicing Your Air Bag-Equipped Vehicle* on page 1-58.

Headlamp Wiring

The headlamp wiring is protected by fuses, one for each headlamp, in the fuse block. An electrical overload will cause the lamps to turn off. If this happens, have your headlamp wiring checked right away.

Windshield Wiper Fuses

The windshield wiper motor is protected by an internal circuit breaker and a fuse. If the motor overheats due to heavy snow, etc., the wiper will stop until the motor cools. If the overload is caused by some electrical problem and not snow, etc., be sure to get it fixed.

Power Windows and Other Power Options

Circuit breakers in the fuse block protect the power windows and other power accessories. When the current load is too heavy, the circuit breaker opens and closes, protecting the circuit until the problem is fixed or goes away.

Fuses and Circuit Breakers

The wiring circuits in your vehicle are protected from short circuits by a combination of fuses, circuit breakers and fusible thermal links in the wiring itself.

Look at the silver-colored band inside the fuse. If the band is broken or melted, replace the fuse. Be sure you replace a bad fuse with a new one of the identical size and rating.

There are spare fuses provided in the engine compartment fuse block. If you ever have a problem on the road and do not have a spare fuse, you can borrow one that has the same amperage. Just pick a feature of your vehicle that you can get along without — like the radio or cigarette lighter — and use its fuse, if it is the correct amperage. Replace it as soon as you can.

There are two fuse blocks in your vehicle: the instrument panel fuse block and the engine compartment fuse block.

There is a fuse puller located on the engine compartment fuse block. It can be used to easily remove fuses from the fuse block.

Instrument Panel Fuse Block

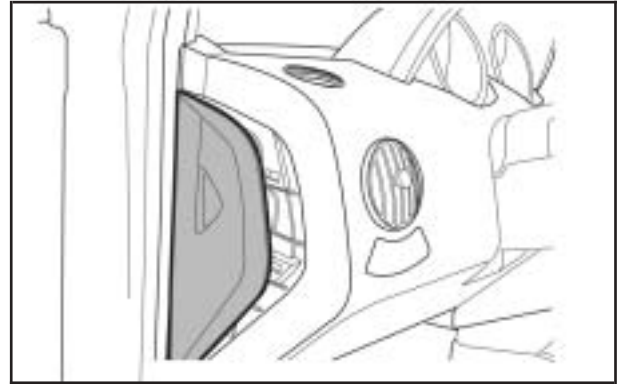

The instrument panel fuse block is located on the end of the instrument panel on the driver's side of the vehicle. To access the fuses, open the fuse panel door by pulling the door out.

To reinstall the door, first insert the rear edge of the fuse panel door, then push the front of the door into the end of the instrument panel to secure it.

	CIGAR JACK		HORN
	AUDIO, CLOCK		STOP LAMP
	T/SIG		METER, HAZARD
	METER, CLOCK		DOOR LOCK, RKE
	BACK UP LAMP		ECM, TCM
	ECM, TCM		WIPER, WASHER
	DIS, INJECTOR		ABS, ENG FUSE
	AIRBAG		HVAC BLOWER
	CLOCK, AUDIO		

Fuses	Usage
CIGAR JACK	Cigar Jack
HORN	Horn
AUDIO, CLOCK	Audio, Clock
STOP LAMP	Stop Lamp
T/SIG	Turn Signal
METER, HAZARD	Instrument Panel Cluster, Hazard Flasher
METER, CLOCK	Instrument Panel Cluster, Clock
DOOR LOCK, RKE	Door Lock, Remote Keyless Entry
BACK UP LAMP	Back Up Lamp
ECM, TCM	Engine Control Module, Transmission Control Module
ECM, TCM	Engine Control Module, Transmission Control Module
WIPER, WASHER	Wiper, Washer

Fuses	Usage
DIS, INJECTOR	Direct Ignition System, Injector
ABS, ENG FUSE	Antilock Brake System, Engine Fuse
AIRBAG	Air Bag
HVAC BLOWER	HVAC Blower
BLANK	Not Used
BLANK	Not Used
BLANK	Not Used
BLANK	Not Used
BLANK	Not Used
BLANK	Not Used
CLOCK, AUDIO	Clock, Audio

Engine Compartment Fuse Block

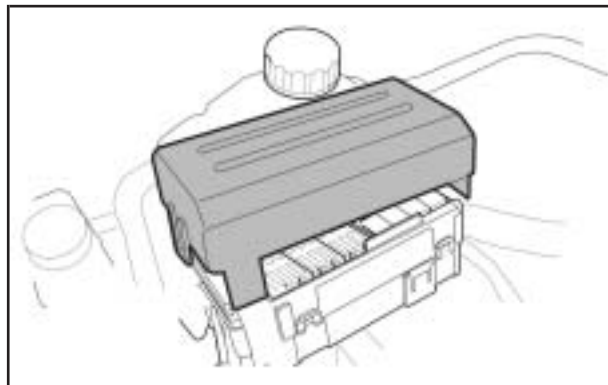

The engine compartment fuse block is located on the driver's side of the vehicle, near the battery. See *Engine Compartment Overview* on page 5-14 for more information on location. To access the fuses, pull out the top and bottom flaps to release the cover. To reinstall the cover, push the cover until it is secure.

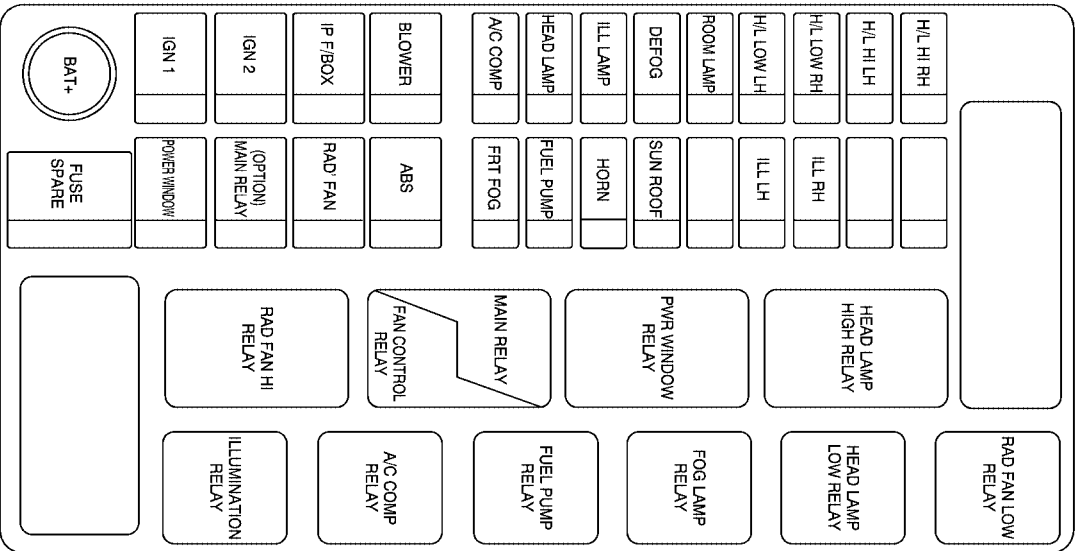

Fuses	Usage
H/L HI RH	Head Lamp High Right Side
BLANK	Not Used
H/L HI LH	Head Lamp High Left Side
BLANK	Not Used
H/L LOW RH	Head Lamp Low Right Side
ILL RH	Parking Lamp Right Side, Illumination Circuit
H/L LOW LH	Head Lamp Low Left Side
ILL LH	Parking Lamp Left Side, License Plate Lamp
ROOM LAMP	Room Lamp
BLANK	Not Used
DEFOG	Defogger
SUN ROOF	Sunroof
ILL LAMP	Illumination Relay

Fuses	Usage
HORN	Horn
HEAD LAMP	Headlamp
FUEL PUMP	Fuel Pump
A/C COMP	Air Conditioning Compressor
FRT FOG	Front Fog Lamp
BLOWER	Blower
ABS	Antilock Brake System
IP F/BOX	Instrument Panel Fuse Box
RAD' FAN	Radiator Fan
IGN 2	Ignition 2
IGN 1	Ignition 1
POWER WINDOW	Power Windows
FUSE SPARE	Spare Fuse

Relays	Usage
BLANK	Not Used
RAD FAN LOW RELAY	Radiator Fan Low Relay
HEAD LAMP HIGH RELAY	Head Lamp High Relay
HEAD LAMP LOW RELAY	Head Lamp Low Relay
PWR WINDOW RELAY	Power Window Relay
FOG LAMP RELAY	Fog Lamp Relay
MAIN RELAY/FAN CONTROL RELAY	Main Relay/Fan Control Relay

Relays	Usage
FUEL PUMP RELAY	Fuel Pump Relay
A/C COMP RELAY	Air Conditioning Relay
(OPTION) MAIN RELAY	Main Relay (Option)
RAD FAN HI RELAY	Radiator Fan High Relay
ILLUMINATION RELAY	Illumination Relay
BLANK	Not Used

Capacities and Specifications

The following approximate capacities are given in English and metric conversions. Please refer to *Part D: Recommended Fluids and Lubricants* on page 6-26 for more information.

Application	Capacities	
	English	Metric
Air Conditioning Refrigerant R134a	1.48 lbs	0.67 kg
Brake/Clutch Fluid	0.51 quarts	0.48 L
Cooling System	7.4 quarts	7.0 L
Engine Oil with Filter	3.96 quarts	3.75 L
Fuel Tank	11.9 gallons	45.0 L
Transaxle, Automatic		
Complete Overhaul	6.2 quarts	5.87 L
Transaxle, Manual		
Complete Drain and Refill	1.9 quarts	1.8 L
Wheel Nut Torque	81 lb ft	110 N•m
All capacities are approximate. When adding, be sure to fill to the appropriate level, as recommended in this manual.		

Engine Specifications

Engine	VIN Code	Transaxle	Spark Plug Gap
1.6L L4 (L91)	6	Automatic and Manual	0.039-0.043 inch (1.0-1.1 mm)



NOTES

Section 6 Maintenance Schedule

Maintenance Schedule	6-2	At Least Twice a Year	6-20
Introduction	6-2	At Least Once a Year	6-21
Maintenance Requirements	6-2	Part C: Periodic Maintenance Inspections	6-24
Your Vehicle and the Environment	6-2	Steering, Suspension and Front Drive Axle	
How This Section is Organized	6-3	Boot and Seal Inspection	6-24
Part A: Scheduled Maintenance Services	6-4	Exhaust System Inspection	6-24
Using Your Maintenance Schedule	6-4	Fuel System Inspection	6-25
Selecting the Right Schedule	6-5	Engine Cooling System Inspection	6-25
Short Trip/City Scheduled Maintenance	6-7	Throttle System Inspection	6-25
Long Trip/Highway Scheduled Maintenance	6-14	Brake System Inspection	6-25
Part B: Owner Checks and Services	6-19	Part D: Recommended Fluids	
At Each Fuel Fill	6-19	and Lubricants	6-26
At Least Once a Month	6-19	Part E: Maintenance Record	6-28

Maintenance Schedule

Introduction

Important: Keep engine oil at the proper level and change as recommended.



Have you purchased the GM Protection Plan? The Plan supplements your new vehicle warranties. See your Warranty and Owner Assistance booklet or your dealer for details.

Maintenance Requirements

Maintenance intervals, checks, inspections and recommended fluids and lubricants as prescribed in this manual are necessary to keep your vehicle in good working condition. Any damage caused by failure to follow scheduled maintenance may not be covered by warranty.

Your Vehicle and the Environment

Proper vehicle maintenance not only helps to keep your vehicle in good working condition, but also helps the environment. Improper vehicle maintenance can even affect the quality of the air we breathe. Improper fluid levels or the wrong tire inflation can increase the level of emissions from your vehicle. To help protect our environment, and to keep your vehicle in good condition, be sure to maintain your vehicle properly.

How This Section is Organized

This maintenance schedule is divided into five parts:

“Part A: Scheduled Maintenance Services” explains what to have done and how often. Some of these services can be complex, so unless you are technically qualified and have the necessary equipment, you should let your GM dealer’s service department do these jobs.

Your GM dealer has GM-trained and supported service people that will perform the work using genuine GM parts.

CAUTION:

Performing maintenance work on a vehicle can be dangerous. In trying to do some jobs, you can be seriously injured. Do your own maintenance work only if you have the required know-how and the proper tools and equipment for the job. If you have any doubt, have a qualified technician do the work.

If you want to get the service information, see *Service Publications Ordering Information* on page 7-11.

“Part B: Owner Checks and Services” tells you what should be checked and when. It also explains what you can easily do to help keep your vehicle in good condition.

“Part C: Periodic Maintenance Inspections” explains important inspections that your dealer’s service department can perform for you.

“Part D: Recommended Fluids and Lubricants” lists some recommended products necessary to help keep your vehicle properly maintained. These products, or their equivalents, should be used whether you do the work yourself or have it done.

“Part E: Maintenance Record” is a place for you to record and keep track of the maintenance performed on your vehicle. Keep your maintenance receipts. They may be needed to qualify your vehicle for warranty repairs.

Part A: Scheduled Maintenance Services

In this part are scheduled maintenance services which are to be performed at the mileage intervals specified.

Using Your Maintenance Schedule

We at General Motors want to keep your vehicle in good working condition. But we do not know exactly how you will drive it. You may drive short distances only a few times a week. Or you may drive long distances all the time in very hot, dusty weather. You may use your vehicle in making deliveries. Or you may drive it to work, to do errands or in many other ways.

Because of the different ways people use their vehicles, maintenance needs may vary. You may need more frequent checks and replacements. So please read the following and note how you drive. If you have questions on how to keep your vehicle in good condition, see your dealer.

This part tells you the maintenance services you should have done and when to schedule them.

When you go to your dealer for your service needs, you will know that GM-trained and supported service people will perform the work using genuine GM parts.

The proper fluids and lubricants to use are listed in Part D. Make sure whoever services your vehicle uses these. All parts should be replaced and all necessary repairs done before you or anyone else drives the vehicle.

These schedules are for vehicles that:

- carry passengers and cargo within recommended limits. You will find these on the tire and loading information label. See *Loading Your Vehicle on page 4-32*.
- are driven on reasonable road surfaces within legal driving limits.
- use the recommended fuel. See *Gasoline Octane on page 5-5*.

Selecting the Right Schedule

First you will need to decide which of the two schedules is right for your vehicle. Here is how to decide which schedule to follow:

Short Trip/City Definition

Follow the Short Trip/City Scheduled Maintenance if any one of these conditions is true for your vehicle:

- Most trips are less than 5 miles (8 km). This is particularly important when outside temperatures are below freezing.
- Most trips include extensive idling, such as frequent driving in stop-and-go traffic.
- If the vehicle is used for delivery service, police, taxi or other commercial application.

One of the reasons you should follow this schedule if you operate your vehicle under any of these conditions is that these conditions cause engine oil to break down sooner.

Short Trip/City Intervals

Every 3,000 Miles (5 000 km): Engine Oil and Filter Change (or 3 months, whichever occurs first).

Every 6,000 Miles (10 000 km): Tire Rotation.

Every 15,000 Miles (25 000 km): Engine Air Cleaner Filter Inspection. Passenger Compartment Air Filter Replacement. Drive Belts Inspection.

Every 30,000 Miles (50 000 km): Engine Air Cleaner Filter Replacement. Spark Plug Replacement. Cooling System Service. EVAP System Service. PCV System Service. Timing Belt Inspection. Brake/Clutch Fluid Change (or 24 months, whichever occurs first).

Every 60,000 Miles (100 000 km): Spark Plug Wire Replacement. Timing Belt Replacement.

Every 90,000 Miles (150 000 km): Fuel Filter Replacement.

These intervals only summarize maintenance services. Be sure to follow the complete scheduled maintenance on the following pages.

Long Trip/Highway Definition

Follow this scheduled maintenance *only* if none of the conditions from the Short Trip/City Scheduled Maintenance are true. Do not use this schedule if the vehicle is used for trailer towing, driven in a dusty area or used off paved roads. Use the Short Trip/City schedule for these conditions.

Driving a vehicle with a fully warmed engine under highway conditions will cause engine oil to break down slower.

Long Trip/Highway Intervals

Every 7,500 Miles (12 500 km): Engine Oil and Filter Change (or every 12 months, whichever occurs first). Tire Rotation.

Every 15,000 Miles (25 000 km): Engine Air Cleaner Filter Inspection. Passenger Compartment Air Filter Replacement. Drive Belts Inspection.

Every 30,000 Miles (50 000 km): Engine Air Cleaner Filter Replacement. Spark Plug Replacement. Cooling System Service. EVAP System Service. PCV System Service. Timing Belt Inspection. Brake/Clutch Fluid Change (or 24 months, whichever occurs first).

Every 60,000 Miles (100 000 km): Spark Plug Wire Replacement. Timing Belt Replacement.

Every 90,000 Miles (150 000 km): Fuel Filter Replacement.

These intervals only summarize maintenance services. Be sure to follow the complete scheduled maintenance on the following pages.

Short Trip/City Scheduled Maintenance

The services shown in this schedule up to 100,000 miles (166 000 km) should be repeated after 100,000 miles (166 000 km) at the same intervals for the life of this vehicle.

See *Part B: Owner Checks and Services on page 6-19* and *Part C: Periodic Maintenance Inspections on page 6-24*.

Footnotes

† *The U.S. Environmental Protection Agency or the California Air Resources Board has determined that the failure to perform this maintenance item will not nullify the emission warranty or limit recall liability prior to the completion of the vehicle's useful life. We, however, urge that all recommended maintenance services be performed at the indicated intervals and the maintenance be recorded.*

+ *A good time to check your brakes is during tire rotation. See *Brake System Inspection on page 6-25*.*

3,000 Miles (5 000 km)

- Change engine oil and filter (or every 3 months, whichever occurs first). *An Emission Control Service.*

6,000 Miles (10 000 km)

- Change engine oil and filter (or every 3 months, whichever occurs first). *An Emission Control Service.*
- Rotate tires. See *Tire Inspection and Rotation on page 5-60* for proper rotation pattern and additional information. (See footnote +.)

9,000 Miles (15 000 km)

- Change engine oil and filter (or every 3 months, whichever occurs first). *An Emission Control Service.*

12,000 Miles (20 000 km)

- Change engine oil and filter (or every 3 months, whichever occurs first). *An Emission Control Service.*
- Rotate tires. See *Tire Inspection and Rotation on page 5-60* for proper rotation pattern and additional information. (See footnote +.)

15,000 Miles (25 000 km)

- Change engine oil and filter (or every 3 months, whichever occurs first). *An Emission Control Service.*
- Replace passenger compartment air filter. If you drive regularly under dusty conditions, the filter may require replacement more often.
- Inspect engine air cleaner filter. If necessary, replace the filter. If vehicle is driven in dusty/dirty conditions, inspect filter at every engine oil change. See *Engine Air Cleaner/Filter on page 5-20* for more information. *An Emission Control Service. (See footnote †.)*
- Inspect drive belts.

18,000 Miles (30 000 km)

- Change engine oil and filter (or every 3 months, whichever occurs first). *An Emission Control Service.*
- Rotate tires. See *Tire Inspection and Rotation on page 5-60* for proper rotation pattern and additional information. *(See footnote +.)*

21,000 Miles (35 000 km)

- Change engine oil and filter (or every 3 months, whichever occurs first). *An Emission Control Service.*

24,000 Miles (40 000 km)

- Change engine oil and filter (or every 3 months, whichever occurs first). *An Emission Control Service.*
- Rotate tires. See *Tire Inspection and Rotation on page 5-60* for proper rotation pattern and additional information. *(See footnote +)*

27,000 Miles (45 000 km)

- Change engine oil and filter (or every 3 months, whichever occurs first). *An Emission Control Service.*

30,000 Miles (50 000 km)

- Change engine oil and filter (or every 3 months, whichever occurs first). *An Emission Control Service.*
- Replace passenger compartment air filter. If you drive regularly under dusty conditions, the filter may require replacement more often.
- Replace engine air cleaner filter. See *Engine Air Cleaner/Filter on page 5-20* for more information. *An Emission Control Service.*
- Rotate tires. See *Tire Inspection and Rotation on page 5-60* for proper rotation pattern and additional information. *(See footnote +.)*

- ❑ Replace spark plugs. *An Emission Control Service.*
- ❑ Inspect drive belts.
- ❑ Inspect timing belt.
- ❑ Drain, flush and refill cooling system. See *Engine Coolant on page 5-23* for what to use. Inspect hoses. Clean radiator, condenser, pressure cap and neck. Pressure test the cooling system and pressure cap. *An Emission Control Service.*
- ❑ Inspect EVAP canister, vapor lines and solenoid valve filter. *An Emission Control Service. (See footnote †.)*
- ❑ Inspect PCV system. *An Emission Control Service. (See footnote †.)*
- ❑ Change brake/clutch fluid (or every 24 months, whichever occurs first).

33,000 Miles (55 000 km)

- ❑ Change engine oil and filter (or every 3 months, whichever occurs first). *An Emission Control Service.*

36,000 Miles (60 000 km)

- ❑ Change engine oil and filter (or every 3 months, whichever occurs first). *An Emission Control Service.*
- ❑ Rotate tires. See *Tire Inspection and Rotation on page 5-60* for proper rotation pattern and additional information. *(See footnote +.)*

39,000 Miles (65 000 km)

- ❑ Change engine oil and filter (or every 3 months, whichever occurs first). *An Emission Control Service.*

42,000 Miles (70 000 km)

- ❑ Change engine oil and filter (or every 3 months, whichever occurs first). *An Emission Control Service.*
- ❑ Rotate tires. See *Tire Inspection and Rotation on page 5-60* for proper rotation pattern and additional information. *(See footnote +.)*

45,000 Miles (75 000 km)

- Change engine oil and filter (or every 3 months, whichever occurs first). *An Emission Control Service.*
- Replace passenger compartment air filter. If you drive regularly under dusty conditions, the filter may require replacement more often.
- Inspect engine air cleaner filter. If necessary, replace the filter. If vehicle is driven in dusty/dirty conditions, inspect filter at every engine oil change. See *Engine Air Cleaner/Filter on page 5-20* for more information. *An Emission Control Service. (See footnote †.)*
- Inspect drive belts.

48,000 Miles (80 000 km)

- Change engine oil and filter (or every 3 months, whichever occurs first). *An Emission Control Service.*
- Rotate tires. See *Tire Inspection and Rotation on page 5-60* for proper rotation pattern and additional information. *(See footnote +.)*

51,000 Miles (85 000 km)

- Change engine oil and filter (or every 3 months, whichever occurs first). *An Emission Control Service.*

54,000 Miles (90 000 km)

- Change engine oil and filter (or every 3 months, whichever occurs first). *An Emission Control Service.*
- Rotate tires. See *Tire Inspection and Rotation on page 5-60* for proper rotation pattern and additional information. *(See footnote +.)*

57,000 Miles (95 000 km)

- Change engine oil and filter (or every 3 months, whichever occurs first). *An Emission Control Service.*

60,000 Miles (100 000 km)

- Change engine oil and filter (or every 3 months, whichever occurs first). *An Emission Control Service.*
- Replace passenger compartment air filter. If you drive regularly under dusty conditions, the filter may require replacement more often.
- Replace engine air cleaner filter. See *Engine Air Cleaner/Filter on page 5-20* for more information. *An Emission Control Service.*
- Rotate tires. See *Tire Inspection and Rotation on page 5-60* for proper rotation pattern and additional information. *(See footnote +.)*

- ❑ Replace spark plugs. *An Emission Control Service.*
- ❑ Replace spark plug wires. *An Emission Control Service.*
- ❑ Inspect drive belts.
- ❑ Replace timing belt.
- ❑ Drain, flush and refill cooling system. See *Engine Coolant on page 5-23* for what to use. Inspect hoses. Clean radiator, condenser, pressure cap and neck. Pressure test the cooling system and pressure cap. *An Emission Control Service.*
- ❑ Inspect EVAP canister, vapor lines and solenoid valve filter. *An Emission Control Service. (See footnote †.)*
- ❑ Inspect PCV system. *An Emission Control Service. (See footnote †.)*
- ❑ Change brake/clutch fluid (or every 24 months, whichever occurs first).

63,000 Miles (105 000 km)

- ❑ Change engine oil and filter (or every 3 months, whichever occurs first). *An Emission Control Service.*

66,000 Miles (110 000 km)

- ❑ Change engine oil and filter (or every 3 months, whichever occurs first). *An Emission Control Service.*
- ❑ Rotate tires. See *Tire Inspection and Rotation on page 5-60* for proper rotation pattern and additional information. *(See footnote +.)*

69,000 Miles (115 000 km)

- ❑ Change engine oil and filter (or every 3 months, whichever occurs first). *An Emission Control Service.*

72,000 Miles (120 000 km)

- ❑ Change engine oil and filter (or every 3 months, whichever occurs first). *An Emission Control Service.*
- ❑ Rotate tires. See *Tire Inspection and Rotation on page 5-60* for proper rotation pattern and additional information. *(See footnote +.)*

75,000 Miles (125 000 km)

- Change engine oil and filter (or every 3 months, whichever occurs first). *An Emission Control Service.*
- Replace passenger compartment air filter. If you drive regularly under dusty conditions, the filter may require replacement more often.
- Inspect engine air cleaner filter. If necessary, replace the filter. If vehicle is driven in dusty/dirty conditions, inspect filter at every engine oil change. See *Engine Air Cleaner/Filter on page 5-20* for more information. *An Emission Control Service. (See footnote †.)*
- Inspect drive belts.

78,000 Miles (130 000 km)

- Change engine oil and filter (or every 3 months, whichever occurs first). *An Emission Control Service.*
- Rotate tires. See *Tire Inspection and Rotation on page 5-60* for proper rotation pattern and additional information. *(See footnote +.)*

81,000 Miles (135 000 km)

- Change engine oil and filter (or every 3 months, whichever occurs first). *An Emission Control Service.*

84,000 Miles (140 000 km)

- Change engine oil and filter (or every 3 months, whichever occurs first). *An Emission Control Service.*
- Rotate tires. See *Tire Inspection and Rotation on page 5-60* for proper rotation pattern and additional information. *(See footnote +.)*

87,000 Miles (145 000 km)

- Change engine oil and filter (or every 3 months, whichever occurs first). *An Emission Control Service.*

90,000 Miles (150 000 km)

- Change engine oil and filter (or every 3 months, whichever occurs first). *An Emission Control Service.*
- Replace passenger compartment air filter. If you drive regularly under dusty conditions, the filter may require replacement more often.
- Replace engine air cleaner filter. See *Engine Air Cleaner/Filter on page 5-20* for more information. *An Emission Control Service.*
- Rotate tires. See *Tire Inspection and Rotation on page 5-60* for proper rotation pattern and additional information. *(See footnote +.)*

- ❑ Replace spark plugs. *An Emission Control Service.*
- ❑ Replace fuel filter. *An Emission Control Service. (See footnote †.)*
- ❑ Inspect drive belts.
- ❑ Inspect timing belt.
- ❑ Drain, flush and refill cooling system. See *Engine Coolant on page 5-23* for what to use. Inspect hoses. Clean radiator, condenser, pressure cap and neck. Pressure test the cooling system and pressure cap. *An Emission Control Service.*
- ❑ Inspect EVAP canister, vapor lines and solenoid valve filter. *An Emission Control Service. (See footnote †.)*
- ❑ Inspect PCV system. *An Emission Control Service. (See footnote †.)*
- ❑ Change brake/clutch fluid (or every 24 months, whichever occurs first).

93,000 Miles (155 000 km)

- ❑ Change engine oil and filter (or every 3 months, whichever occurs first). *An Emission Control Service.*

96,000 Miles (160 000 km)

- ❑ Change engine oil and filter (or every 3 months, whichever occurs first). *An Emission Control Service.*
- ❑ Rotate tires. See *Tire Inspection and Rotation on page 5-60* for proper rotation pattern and additional information. *(See footnote +.)*

99,000 Miles (165 000 km)

- ❑ Change engine oil and filter (or every 3 months, whichever occurs first). *An Emission Control Service.*

Long Trip/Highway Scheduled Maintenance

The services shown in this schedule up to 100,000 miles (166 000 km) should be repeated after 100,000 miles (166 000 km) at the same intervals for the life of this vehicle.

See *Part B: Owner Checks and Services on page 6-19* and *Part C: Periodic Maintenance Inspections on page 6-24*.

Footnotes

† *The U.S. Environmental Protection Agency or the California Air Resources Board has determined that the failure to perform this maintenance item will not nullify the emission warranty or limit recall liability prior to the completion of the vehicle's useful life. We, however, urge that all recommended maintenance services be performed at the indicated intervals and the maintenance be recorded.*

+ *A good time to check your brakes is during tire rotation. See *Brake System Inspection on page 6-25*.*

7,500 Miles (12 500 km)

- Change engine oil and filter (or every 12 months, whichever occurs first). *An Emission Control Service.*
- Rotate tires. See *Tire Inspection and Rotation on page 5-60* for proper rotation pattern and additional information. (See footnote +.)

15,000 Miles (25 000 km)

- Change engine oil and filter (or every 12 months, whichever occurs first). *An Emission Control Service.*
- Replace passenger compartment air filter. If you drive regularly under dusty conditions, the filter may require replacement more often.
- Inspect engine air cleaner filter. See *Engine Air Cleaner/Filter on page 5-20* for more information. *An Emission Control Service.* (See footnote †.)
- Rotate tires. See *Tire Inspection and Rotation on page 5-60* for proper rotation pattern and additional information. (See footnote +.)
- Inspect drive belts.

22,500 Miles (37 500 km)

- Change engine oil and filter (or every 12 months, whichever occurs first). *An Emission Control Service.*
- Rotate tires. See *Tire Inspection and Rotation on page 5-60* for proper rotation pattern and additional information. (See footnote +.)

30,000 Miles (50 000 km)

- Change engine oil and filter (or every 12 months, whichever occurs first). *An Emission Control Service.*
- Replace passenger compartment air filter. If you drive regularly under dusty conditions, the filter may require replacement more often.
- Replace engine air cleaner filter. See *Engine Air Cleaner/Filter on page 5-20* for more information. *An Emission Control Service.*
- Rotate tires. See *Tire Inspection and Rotation on page 5-60* for proper rotation pattern and additional information. (See footnote +.)
- Replace spark plugs. *An Emission Control Service.*
- Inspect drive belts.

- Inspect timing belt.
- Drain, flush and refill cooling system. See *Engine Coolant on page 5-23* for what to use. Inspect hoses. Clean radiator, condenser, pressure cap and neck. Pressure test the cooling system and pressure cap. *An Emission Control Service.*
- Inspect EVAP canister, vapor lines and solenoid valve filter. *An Emission Control Service.* (See footnote †.)
- Inspect PCV system. *An Emission Control Service.* (See footnote †.)
- Change brake/clutch fluid (or every 24 months, whichever occurs first).

37,500 Miles (62 500 km)

- Change engine oil and filter (or every 12 months, whichever occurs first). *An Emission Control Service.*
- Rotate tires. See *Tire Inspection and Rotation on page 5-60* for proper rotation pattern and additional information. (See footnote +.)

45,000 Miles (75 000 km)

- Change engine oil and filter (or every 12 months, whichever occurs first). *An Emission Control Service.*
- Replace passenger compartment air filter. If you drive regularly under dusty conditions, the filter may require replacement more often.
- Inspect engine air cleaner filter. See *Engine Air Cleaner/Filter on page 5-20* for more information. *An Emission Control Service.* (See footnote †.)
- Rotate tires. See *Tire Inspection and Rotation on page 5-60* for proper rotation pattern and additional information. (See footnote +.)
- Inspect drive belts.

52,500 Miles (87 500 km)

- Change engine oil and filter (or every 12 months, whichever occurs first). *An Emission Control Service.*
- Rotate tires. See *Tire Inspection and Rotation on page 5-60* for proper rotation pattern and additional information. (See footnote +.)

60,000 Miles (100 000 km)

- Change engine oil and filter (or every 12 months, whichever occurs first). *An Emission Control Service.*
- Replace passenger compartment air filter. If you drive regularly under dusty conditions, the filter may require replacement more often.
- Replace engine air cleaner filter. See *Engine Air Cleaner/Filter on page 5-20* for more information. *An Emission Control Service.*
- Rotate tires. See *Tire Inspection and Rotation on page 5-60* for proper rotation pattern and additional information. (See footnote +.)
- Replace spark plugs. *An Emission Control Service.*
- Replace spark plug wires. *An Emission Control Service.*
- Inspect drive belts.
- Replace timing belt.

- ❑ Drain, flush and refill cooling system. See *Engine Coolant* on page 5-23 for what to use. Inspect hoses. Clean radiator, condenser, pressure cap and neck. Pressure test the cooling system and pressure cap. *An Emission Control Service.*
- ❑ Inspect EVAP canister, vapor lines and solenoid valve filter. *An Emission Control Service. (See footnote †.)*
- ❑ Inspect PCV system. *An Emission Control Service. (See footnote †.)*
- ❑ Change brake/clutch fluid (or every 24 months, whichever occurs first).

67,500 Miles (112 500 km)

- ❑ Change engine oil and filter (or every 12 months, whichever occurs first). *An Emission Control Service.*
- ❑ Rotate tires. See *Tire Inspection and Rotation* on page 5-60 for proper rotation pattern and additional information. *(See footnote +.)*

75,000 Miles (125 000 km)

- ❑ Change engine oil and filter (or every 12 months, whichever occurs first). *An Emission Control Service.*
- ❑ Replace passenger compartment air filter. If you drive regularly under dusty conditions, the filter may require replacement more often.
- ❑ Inspect engine air cleaner filter. See *Engine Air Cleaner/Filter* on page 5-20 for more information. *An Emission Control Service. (See footnote †.)*
- ❑ Rotate tires. See *Tire Inspection and Rotation* on page 5-60 for proper rotation pattern and additional information. *(See footnote +.)*
- ❑ Inspect drive belts.

82,500 Miles (137 500 km)

- ❑ Change engine oil and filter (or every 12 months, whichever occurs first). *An Emission Control Service.*
- ❑ Rotate tires. See *Tire Inspection and Rotation* on page 5-60 for proper rotation pattern and additional information. *(See footnote +.)*

90,000 Miles (150 000 km)

- Change engine oil and filter (or every 12 months, whichever occurs first). *An Emission Control Service.*
- Replace passenger compartment air filter. If you drive regularly under dusty conditions, the filter may require replacement more often.
- Replace engine air cleaner filter. See *Engine Air Cleaner/Filter* on page 5-20 for more information. *An Emission Control Service.*
- Rotate tires. See *Tire Inspection and Rotation* on page 5-60 for proper rotation pattern and additional information. (See footnote +.)
- Replace spark plugs. *An Emission Control Service.*
- Replace fuel filter. *An Emission Control Service.* (See footnote †.)
- Inspect drive belts.
- Inspect timing belt.

- Drain, flush and refill cooling system. See *Engine Coolant* on page 5-23 for what to use. Inspect hoses. Clean radiator, condenser, pressure cap and neck. Pressure test the cooling system and pressure cap. *An Emission Control Service.*
- Inspect EVAP canister, vapor lines and solenoid valve filter. *An Emission Control Service.* (See footnote †.)
- Inspect PCV system. *An Emission Control Service.* (See footnote †.)
- Change brake/clutch fluid (or every 24 months, whichever occurs first).

97,500 Miles (162 500 km)

- Change engine oil and filter (or every 12 months, whichever occurs first). *An Emission Control Service.*
- Rotate tires. See *Tire Inspection and Rotation* on page 5-60 for proper rotation pattern and additional information. (See footnote +.)

Part B: Owner Checks and Services

Listed in this part are owner checks and services which should be performed at the intervals specified to help ensure the safety, dependability and emission control performance of your vehicle.

Be sure any necessary repairs are completed at once. Whenever any fluids or lubricants are added to your vehicle, make sure they are the proper ones, as shown in Part D.

At Each Fuel Fill

It is important for you or a service station attendant to perform these underhood checks at each fuel fill.

Engine Oil Level Check

Check the engine oil level and add the proper oil if necessary. See *Engine Oil* on page 5-15 for further details.

Engine Coolant Level Check

Check the engine coolant level and add the proper coolant mixture if necessary. See *Engine Coolant* on page 5-23 for further details.

Windshield Washer Fluid Level Check

Check the windshield washer fluid level in the windshield washer tank and add the proper fluid if necessary. See *Windshield Washer Fluid* on page 5-35 for further details.

At Least Once a Month

Tire Inflation Check

Visually inspect your tires and make sure tires are inflated to the correct pressures. Do not forget to check your spare tire. See *Tires* on page 5-51 for further details.

Cassette Tape Player Service

Clean cassette tape player. Cleaning should be done every 50 hours of tape play. See *Audio System(s)* on page 3-34 for further details.

At Least Twice a Year

Restraint System Check

Make sure the safety belt reminder light and all your belts, buckles, latch plates, retractors and anchorages are working properly. Look for any other loose or damaged safety belt system parts. If you see anything that might keep a safety belt system from doing its job, have it repaired. Have any torn or frayed safety belts replaced.

Also look for any opened or broken air bag coverings, and have them repaired or replaced. (The air bag system does not need regular maintenance.)

Wiper Blade Check

Inspect wiper blades for wear or cracking. Replace blade inserts that appear worn or damaged or that streak or miss areas of the windshield. Also see *Cleaning the Outside of Your Vehicle on page 5-79*.

Weatherstrip Lubrication

Silicone grease on weatherstrips will make them last longer, seal better, and not stick or squeak. Apply silicone grease with a clean cloth. During very cold, damp weather more frequent application may be required. See *Part D: Recommended Fluids and Lubricants on page 6-26*.

Manual Transaxle Check

It is not necessary to check the transaxle fluid level. Check for leaks. A fluid leak is the only reason for fluid loss. Have the system inspected and repaired if needed.

Automatic Transaxle Inspection

It is not necessary to check the transaxle fluid level. A transaxle fluid leak is the only reason for fluid loss. Check for leaks. If a leak occurs, take the vehicle to your dealer and have it repaired as soon as possible.

Hydraulic Clutch System Check

Check the fluid level in the brake/clutch reservoir. See *Hydraulic Clutch on page 5-22*. A fluid loss in this system could indicate a problem. Have the system inspected and repaired at once.

At Least Once a Year

Key Lock Cylinders Service

Lubricate the key lock cylinders with the lubricant specified in Part D.

Body Lubrication Service

Lubricate all hood latch assemblies, secondary latch, pivots, spring anchor, release pawl, hood and body door hinges, rear compartment and any folding seat hardware. Part D tells you what to use. More frequent lubrication may be required when exposed to a corrosive environment.

Starter Switch Check

CAUTION:

When you are doing this inspection, the vehicle could move suddenly. If the vehicle moves, you or others could be injured.

1. Before you start, be sure you have enough room around the vehicle.
2. Firmly apply both the parking brake and the regular brake. See *Parking Brake on page 2-28* if necessary. Do not use the accelerator pedal, and be ready to turn off the engine immediately if it starts.
3. On automatic transaxle vehicles, try to start the engine in each gear. The starter should work only in PARK (P) or NEUTRAL (N). If the starter works in any other position, your vehicle needs service.
On manual transaxle vehicles, put the shift lever in NEUTRAL (N), push the clutch down halfway and try to start the engine. The starter should work only when the clutch is pushed down all the way to the floor. If the starter works when the clutch is not pushed all the way down, your vehicle needs service.

Automatic Transaxle Shift Lock Control System Check

CAUTION:

When you are doing this inspection, the vehicle could move suddenly. If the vehicle moves, you or others could be injured.

1. Before you start, be sure you have enough room around the vehicle. It should be parked on a level surface.
2. Firmly apply the parking brake. See *Parking Brake* on page 2-28 if necessary.
Be ready to apply the regular brake immediately if the vehicle begins to move.
3. With the engine off, turn the key to the RUN position, but do not start the engine. Without applying the regular brake, try to move the shift lever out of PARK (P) with normal effort. If the shift lever moves out of PARK (P), your vehicle needs service.

Ignition Transaxle Lock Check

While parked, and with the parking brake set, try to turn the ignition key to LOCK in each shift lever position.

- With an automatic transaxle, the key should turn to LOCK only when the shift lever is in PARK (P).
- With a manual transaxle, the key should turn to LOCK only when you press the key release button.

On all vehicles, the key should come out only in LOCK.

Turn the steering wheel to the left and to the right. It should only lock when turned to the right.

Parking Brake and Automatic Transaxle Park (P) Mechanism Check

CAUTION:

When you are doing this check, your vehicle could begin to move. You or others could be injured and property could be damaged. Make sure there is room in front of your vehicle in case it begins to roll. Be ready to apply the regular brake at once should the vehicle begin to move.

Park on a fairly steep hill, with the vehicle facing downhill. Keeping your foot on the regular brake, set the parking brake.

- To check the parking brake's holding ability: With the engine running and transaxle in NEUTRAL (N), slowly remove foot pressure from the regular brake pedal. Do this until the vehicle is held by the parking brake only.
- To check the PARK (P) mechanism's holding ability: With the engine running, shift to PARK (P). Then release the parking brake followed by the regular brake.

Underbody Flushing Service

At least every spring, use plain water to flush any corrosive materials from the underbody. Take care to clean thoroughly any areas where mud and other debris can collect.

Part C: Periodic Maintenance Inspections

Listed in this part are inspections and services which should be performed at least twice a year (for instance, each spring and fall). *You should let your dealer's service department do these jobs. Make sure any necessary repairs are completed at once.*

Proper procedures to perform these services may be found in a service manual. See *Service Publications Ordering Information on page 7-11.*

Steering, Suspension and Front Drive Axle Boot and Seal Inspection

Inspect the front and rear suspension and steering system for damaged, loose or missing parts, signs of wear or lack of lubrication. Inspect the power steering lines and hoses for proper hook-up, binding, leaks, cracks, chafing, etc. Clean and then inspect the drive axle boot seals for damage, tears or leakage. Replace seals if necessary.

Exhaust System Inspection

Inspect the complete exhaust system. Inspect the body near the exhaust system. Look for broken, damaged, missing or out-of-position parts as well as open seams, holes, loose connections or other conditions which could cause a heat build-up in the floor pan or could let exhaust fumes into the vehicle. See *Engine Exhaust on page 2-32.*

Fuel System Inspection

Inspect the complete fuel system for damage or leaks.

Engine Cooling System Inspection

Inspect the hoses and have them replaced if they are cracked, swollen or deteriorated. Inspect all pipes, fittings and clamps; replace as needed. Clean the outside of the radiator and air conditioning condenser. To help ensure proper operation, a pressure test of the cooling system and pressure cap is recommended at least once a year.

Throttle System Inspection

Inspect the throttle system for interference or binding, and for damaged or missing parts. Replace parts as needed. Replace any components that have high effort or excessive wear. Do not lubricate accelerator and cruise control cables.

Brake System Inspection

Inspect the complete system. Inspect brake lines and hoses for proper hook-up, binding, leaks, cracks, chafing, etc. Inspect disc brake pads for wear and rotors for surface condition. Also inspect drum brake linings for wear and cracks. Inspect other brake parts, including drums, wheel cylinders, calipers, parking brake, etc. Check parking brake adjustment. You may need to have your brakes inspected more often if your driving habits or conditions result in frequent braking.

Part D: Recommended Fluids and Lubricants

Fluids and lubricants identified below by name, part number or specification may be obtained from your dealer.

Usage	Fluid/Lubricant
Engine Oil	Engine oil which meets GM Standard GM6094M and displays the American Petroleum Institute Certified for Gasoline Engines starburst symbol. To determine the proper viscosity for your vehicle's engine, see <i>Engine Oil on page 5-15</i> .
Engine Coolant	50/50 mixture of clean, drinkable water (preferably distilled) and good quality Ethylene Glycol Base Coolant (GM Part No. U.S. 12378560, in Canada 993089) and conforming to GM Specification 1825M or recycled coolant conforming to GM Specification 1825M. See <i>Engine Coolant on page 5-23</i> .

Usage	Fluid/Lubricant
Hydraulic Brake System	Delco Supreme 11 Brake Fluid or equivalent DOT-3 brake fluid.
Windshield Washer Solvent	GM Optikleen® Washer Solvent.
Power Steering System	DEXRON®-III Automatic Transmission Fluid.
Automatic Transaxle	Automatic Transaxle Fluid ESSO LT 71141 or TOTAL ATF H50235.
Manual Transaxle	GM Goodwrench Synthetic Manual Transmission Fluid (GM Part No. U.S. 12346190, in Canada 10953477) or equivalent SAE 75W-85 GL-4 gear oil.
Key Lock Cylinders	Multi-Purpose Lubricant, Superlube (GM Part No. U.S. 12346241, in Canada 10953474).

Usage	Fluid/Lubricant
Manual Transaxle Shift Linkage	Chassis Lubricant (GM Part No. U.S. 12377985, in Canada 88901242) or lubricant meeting requirements of NLGI #2, Category LB or GC-LB.
Chassis Lubrication	Chassis Lubricant (GM Part No. U.S. 12377985, in Canada 88901242) or lubricant meeting requirements of NLGI #2, Category LB or GC-LB.

Usage	Fluid/Lubricant
Hood Latch Assembly, Secondary Latch, Pivots, Spring Anchor and Release Pawl	Lubriplate Lubricant Aerosol (GM Part No. U.S. 12346293, in Canada 992723) or lubricant meeting requirements of NLGI #2, Category LB or GC-LB.
Hood and Door Hinges	Multi-Purpose Lubricant, Superlube (GM Part No. U.S. 12346241, in Canada 10953474).
Weatherstrip Conditioning	Dielectric Silicone Grease (GM Part No. U.S. 12345579, in Canada 992887).

Part E: Maintenance Record

After the scheduled services are performed, record the date, odometer reading and who performed the service and any additional information from "Owner Checks and Services" or "Periodic Maintenance" on the following record pages. Also, you should retain all maintenance receipts.

Maintenance Record

Date	Odometer Reading	Serviced By	Maintenance Record

Maintenance Record (cont'd)

Date	Odometer Reading	Serviced By	Maintenance Record

Maintenance Record (cont'd)

Date	Odometer Reading	Serviced By	Maintenance Record

Section 7 Customer Assistance and Information

Customer Assistance and Information	7-2	Reporting Safety Defects	7-10
Customer Satisfaction Procedure	7-2	Reporting Safety Defects to the United States	
Online Owner Center	7-3	Government	7-10
Customer Assistance for Text Telephone		Reporting Safety Defects to the Canadian	
(TTY) Users	7-4	Government	7-11
Customer Assistance Offices	7-4	Reporting Safety Defects to	
GM Mobility Program for Persons with		General Motors	7-11
Disabilities	7-5	Service Publications Ordering Information	7-11
Roadside Assistance Program	7-6		
Courtesy Transportation	7-7		
Vehicle Data Collection and Event Data			
Recorders	7-9		

Customer Assistance and Information

Customer Satisfaction Procedure

Your satisfaction and goodwill are important to your dealer and to Chevrolet. Normally, any concerns with the sales transaction or the operation of your vehicle will be resolved by your dealer's sales or service departments. Sometimes, however, despite the best intentions of all concerned, misunderstandings can occur. If your concern has not been resolved to your satisfaction, the following steps should be taken:

STEP ONE: Discuss your concern with a member of dealership management. Normally, concerns can be quickly resolved at that level. If the matter has already been reviewed with the sales, service or parts manager, contact the owner of the dealership or the general manager.

STEP TWO: If after contacting a member of dealership management, it appears your concern cannot be resolved by the dealership without further help, contact the Chevrolet Customer Assistance Center by calling 1-800-222-1020. In Canada, contact GM of Canada Customer Communication Centre in Oshawa by calling 1-800-263-3777 (English) or 1-800-263-7854 (French).

We encourage you to call the toll-free number in order to give your inquiry prompt attention. Please have the following information available to give the Customer Assistance Representative:

- Vehicle Identification Number (This is available from the vehicle registration or title, or the plate at the top left of the instrument panel and visible through the windshield.)
- Dealership name and location
- Vehicle delivery date and present mileage

When contacting Chevrolet, please remember that your concern will likely be resolved at a dealer's facility. That is why we suggest you follow Step One first if you have a concern.

STEP THREE: Both General Motors and your dealer are committed to making sure you are completely satisfied with your new vehicle. However, if you continue to remain unsatisfied after following the procedure outlined in Steps One and Two, you should file with the GM/BBB Auto Line Program to enforce any additional rights you may have. Canadian owners refer to your Warranty and Owner Assistance Information booklet for information on the Canadian Motor Vehicle Arbitration Plan (CAMVAP).

The BBB Auto Line Program is an out of court program administered by the Council of Better Business Bureaus to settle automotive disputes regarding vehicle repairs or the interpretation of the New Vehicle Limited Warranty. Although you may be required to resort to this informal dispute resolution program prior to filing a court action, use of the program is free of charge and your case will generally be heard within 40 days. If you do not agree with the decision given in your case, you may reject it and proceed with any other venue for relief available to you.

You may contact the BBB using the toll-free telephone number or write them at the following address:

BBB Auto Line
Council of Better Business Bureaus, Inc.
4200 Wilson Boulevard
Suite 800
Arlington, VA 22203-1804
Telephone: 1-800-955-5100

This program is available in all 50 states and the District of Columbia. Eligibility is limited by vehicle age, mileage and other factors. General Motors reserves the right to change eligibility limitations and/or discontinue its participation in this program.

Online Owner Center

The Owner Center is a resource for your GM ownership needs. You can find your specific vehicle information all in one place.

The Owner Center allows you to:

- Get e-mail service reminders.
- Access information about your specific vehicle, including tips and videos and an electronic version of this owner's manual. (United States only)
- Keep track of your vehicle's service history and maintenance schedule.
- Find GM dealers for service nationwide.
- Receive special promotions and privileges only available to members. (United States only)

Refer to the web for updated information.

To register your vehicle, visit www.MyGMLink.com. (United States) or My GM Canada within www.gmcanada.com (Canada).

Customer Assistance for Text Telephone (TTY) Users

To assist customers who are deaf, hard of hearing, or speech-impaired and who use Text Telephones (TTYs), Chevrolet has TTY equipment available at its Customer Assistance Center. Any TTY user can communicate with Chevrolet by dialing: 1-800-833-CHEV (2438). (TTY users in Canada can dial 1-800-263-3830.)

Customer Assistance Offices

Chevrolet encourages customers to call the toll-free number for assistance. If a U.S. customer wishes to write to Chevrolet, the letter should be addressed to Chevrolet's Customer Assistance Center.

United States – Customer Assistance

Chevrolet Motor Division
Chevrolet Customer Assistance Center
P.O. Box 33170
Detroit, MI 48232-5170

1-800-222-1020
1-800-833-2438 (For Text Telephone devices (TTYs))
Roadside Assistance: 1-800-CHEV-USA® (243-8872)
Fax Number: 313-381-0022

From Puerto Rico:

1-800-496-9992 (English)
1-800-496-9993 (Spanish)
Fax Number: 313-381-0022

From U.S. Virgin Islands:

1-800-496-9994
Fax Number: 313-381-0022

Canada – Customer Assistance

General Motors of Canada Limited
Customer Communication Centre, 163-005
1908 Colonel Sam Drive
Oshawa, Ontario L1H 8P7

1-800-263-3777 (English)
1-800-263-7854 (French)
1-800-263-3830 (For Text Telephone devices (TTYs))
Roadside Assistance: 1-800-268-6800

Overseas – Customer Assistance

Please contact the local General Motors Business Unit.

Mexico, Central America and Caribbean Islands/Countries (Except Puerto Rico and U.S. Virgin Islands) – Customer Assistance

General Motors de Mexico, S. de R.L. de C.V.
Customer Assistance Center
Paseo de la Reforma # 2740
Col. Lomas de Bezares
C.P. 11910, Mexico, D.F.
01-800-508-0000
Long Distance: 011-52-53 29 0 800

GM Mobility Program for Persons with Disabilities

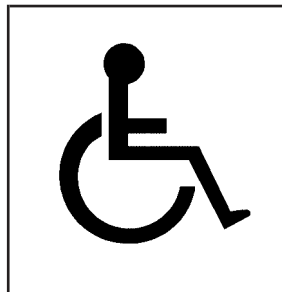

This program, available to qualified applicants, can reimburse you up to \$1,000 toward eligible aftermarket driver or passenger adaptive equipment you may require for your vehicle (hand controls, wheelchair/scooter lifts, etc.).

This program can also provide you with free resource information, such as area driver assessment centers and mobility equipment installers. The offer is available for a limited period of time from the date of vehicle purchase/lease. For more details, or to determine your vehicle's eligibility, see your GM dealer or call the GM Mobility Assistance Center at 1-800-323-9935. Text telephone (TTY) users, call 1-800-833-9935.

GM of Canada also has a Mobility Program. Call 1-800-GM-DRIVE (463-7483) for details. All TTY users call 1-800-263-3830.

Roadside Assistance Program

Security While You Travel

1-800-CHEV-USA (243-8872)

As the proud owner of a new Chevrolet vehicle, you are automatically enrolled in the Chevrolet Roadside Assistance program. This value-added service is intended to provide you with peace of mind as you drive in the city or travel the open road. Chevrolet's Roadside Assistance toll-free number is staffed by courteous and capable Roadside Assistance Representatives who are available 24 hours a day, 365 days a year.

We will provide the following services during the Bumper-to-Bumper warranty period, at no expense to you:

- **Fuel Delivery:** Delivery of enough fuel (\$5 maximum) for the customer to get to the nearest service station.
- **Lock-out Service (identification required):** Replacement keys or locksmith service will be covered at no charge if you are unable to gain entry into your vehicle. Delivery of the replacement key will be covered within 10 miles.
- **Emergency Tow:** Tow to the nearest dealership for warranty service or in the event of a vehicle-disabling accident. Assistance when the vehicle is mired in sand, mud or snow.

- **Flat Tire Change:** Installation of a spare tire will be covered at no charge. (The customer is responsible for the repair or replacement of the tire if not covered by a warrantable failure.)
- **Jump Start:** No-start occurrences which require a battery jump start will be covered at no charge.
- **Dealer Locator Service**

In many instances, mechanical failures are covered under Chevrolet's Bumper-to-Bumper warranty. However, when other services are utilized, our Roadside Assistance Representatives will explain any payment obligations you might incur.

For prompt and efficient assistance when calling, please provide the following to the Roadside Assistance Representative:

- Your name, home address, and home telephone number
- Telephone number of your location
- Location of the vehicle
- Model, year, color, and license plate number
- Mileage, Vehicle Identification Number and delivery date of the vehicle
- Description of the problem

While we hope you never have the occasion to use our service, it is added security while traveling for you and your family. Remember, we are only a phone call away. Chevrolet Roadside Assistance: 1-800-CHEV-USA (1-800-234-8872), text telephone (TTY) users, call 1-888-889-2438.

Chevrolet reserves the right to limit services or reimbursement to an owner or driver when, in Chevrolet's judgement, the claims become excessive in frequency or type of occurrence.

Roadside Assistance is not part of or included in the coverage provided by the New Vehicle Limited Warranty. Buick reserves the right to make any changes or discontinue the Roadside Assistance program at any time without notification.

Canadian Roadside Assistance

Vehicles purchased in Canada have an extensive roadside assistance program accessible from anywhere in Canada or the United States. Please refer to the Warranty and Owner Assistance Information book.

Courtesy Transportation

Chevrolet has always exemplified quality and value in its offering of motor vehicles. To enhance your ownership experience, we and our participating dealers are proud to offer Courtesy Transportation, a customer support program for new vehicles.

The Courtesy Transportation program is offered to retail purchase/lease customers in conjunction with the Bumper-to-Bumper coverage provided by the New Vehicle Limited Warranty. Several transportation options are available when warranty repairs are required. This will reduce your inconvenience during warranty repairs.

Plan Ahead When Possible

When your vehicle requires warranty service, you should contact your dealer and request an appointment. By scheduling a service appointment and advising your service consultant of your transportation needs, your dealer can help minimize your inconvenience.

If your vehicle cannot be scheduled into the service department immediately, keep driving it until it can be scheduled for service, unless, of course, the problem is safety-related. If it is, please call your dealership, let them know this, and ask for instructions.

If the dealer requests that you simply drop the vehicle off for service, you are urged to do so as early in the work day as possible to allow for same day repair.

Transportation Options

Warranty service can generally be completed while you wait. However, if you are unable to wait Chevrolet helps minimize your inconvenience by providing several transportation options. Depending on the circumstances, your dealer can offer you one of the following:

Shuttle Service

Participating dealers can provide you with shuttle service to get you to your destination with minimal interruption of your daily schedule. This includes a one way or round trip shuttle service to a destination up to 10 miles from the dealership.

Public Transportation or Fuel Reimbursement

If your vehicle requires overnight warranty repairs, reimbursement (five day maximum) may be available for the use of public transportation such as taxi or bus. In addition, should you arrange transportation through a friend or relative, reimbursement for reasonable fuel expenses (five day maximum) may be available. Claim amounts should reflect actual costs and be supported by original receipts.

Courtesy Rental Vehicle

Your dealer may arrange to provide you with a courtesy rental vehicle or reimburse you for a rental vehicle you obtained if your vehicle is kept for a warranty repair. Reimbursement will be limited to a maximum of \$30.00 a day and must be supported by receipts. This requires that you sign and complete a rental agreement and meet state, local and rental vehicle provider requirements. Requirements vary and may include minimum age requirements, insurance coverage, credit card, etc. You are responsible for fuel usage charges and may also be responsible for taxes, levies, usage fees, excessive mileage or rental usage beyond the completion of the repair.

Generally it is not possible to provide a like-vehicle as a courtesy rental.

Additional Program Information

Courtesy Transportation is available during the Bumper-to-Bumper warranty coverage period, but it *is not* part of the New Vehicle Limited Warranty. A separate booklet entitled “Warranty and Owner Assistance Information” furnished with each new vehicle provides detailed warranty coverage information.

Courtesy Transportation is available only at participating dealers and all program options, such as shuttle service, may not be available at every dealer. Please contact your dealer for specific information about availability. All Courtesy Transportation arrangements will be administered by appropriate dealer personnel.

Canadian Vehicles: For warranty repairs during the Complete Vehicle Coverage period of the General Motors of Canada New Vehicle Limited Warranty, alternative transportation may be available under the Courtesy Transportation Program. Please consult your dealer for details.

General Motors reserves the right to unilaterally modify, change or discontinue Courtesy Transportation at any time and to resolve all questions of claim eligibility pursuant to the terms and conditions described herein at its sole discretion.

Vehicle Data Collection and Event Data Recorders

Your vehicle, like other modern motor vehicles, has a number of sophisticated computer systems that monitor and control several aspects of the vehicle’s performance. Your vehicle uses on-board vehicle computers to monitor emission control components to optimize fuel economy, to monitor conditions for air bag deployment and, if so equipped, to provide anti-lock braking and to help the driver control the vehicle in difficult driving situations. Some information may be stored during regular operations to facilitate repair of detected malfunctions; other information is stored only in a crash or near crash event by computer systems commonly called event data recorders (EDR).

In a crash or near crash event, computer systems, such as the Air Bag Sensing and Diagnostic Module (SDM) in your vehicle may record information about the condition of the vehicle and how it was operated, such as engine speed, brake applications, throttle position, vehicle speed, safety belt usage, air bag readiness, air bag performance data, and the severity of a collision. This information has been used to improve vehicle crash performance and may be used to improve crash performance of future vehicles and driving safety. Unlike the data recorders on many airplanes, these on-board systems do not record sounds, such as conversation of vehicle occupants.

To read this information, special equipment is needed and access to the vehicle or the SDM is required. GM will not access information about a crash event or share it with others other than

- with the consent of the vehicle owner or, if the vehicle is leased, with the consent of the lessee,
- in response to an official request of police or similar government office,
- as part of GM's defense of litigation through the discovery process, or
- as required by law.

In addition, once GM collects or receives data, GM may

- use the data for GM research needs,
- make it available for research where appropriate confidentiality is to be maintained and need is shown, or
- share summary data which is not tied to a specific vehicle with non-GM organizations for research purposes.

Others, such as law enforcement, may have access to the special equipment that can read the information if they have access to the vehicle or SDM.

If your vehicle is equipped with OnStar[®], please check the OnStar[®] subscription service agreement or manual for information on its operations and data collection.

Reporting Safety Defects

Reporting Safety Defects to the United States Government

If you believe that your vehicle has a defect which could cause a crash or could cause injury or death, you should immediately inform the National Highway Traffic Safety Administration (NHTSA), in addition to notifying General Motors.

If NHTSA receives similar complaints, it may open an investigation, and if it finds that a safety defect exists in a group of vehicles, it may order a recall and remedy campaign. However, NHTSA cannot become involved in individual problems between you, your dealer or General Motors.

To contact NHTSA, you may either call the Auto Safety Hotline toll-free at 1-800-424-9393 (or 366-0123 in the Washington, D.C. area) or write to:

NHTSA, U.S. Department of Transportation
Washington, D.C. 20590

You can also obtain other information about motor vehicle safety from the hotline.

Reporting Safety Defects to the Canadian Government

If you live in Canada, and you believe that your vehicle has a safety defect, you should immediately notify Transport Canada, in addition to notifying General Motors of Canada Limited. You may write to:

Transport Canada
330 Sparks Street
Tower C
Ottawa, Ontario K1A 0N5

Reporting Safety Defects to General Motors

In addition to notifying NHTSA (or Transport Canada) in a situation like this, we certainly hope you'll notify us. Please call us at 1-800-222-1020, or write:

Chevrolet Motor Division
Chevrolet Customer Assistance Center
P.O. Box 33170
Detroit, MI 48232-5170

In Canada, please call us at 1-800-263-3777 (English) or 1-800-263-7854 (French). Or, write:

General Motors of Canada Limited
Customer Communication Centre, 163-005
1908 Colonel Sam Drive
Oshawa, Ontario L1H 8P7

Service Publications Ordering Information

Service Manuals

Service Manuals have the diagnosis and repair information on engines, transmission, axle, suspension, brakes, electrical, steering, body, etc.

RETAIL SELL PRICE: \$120.00

Transmission, Transaxle, Transfer Case Unit Repair Manual

This manual provides information on unit repair service procedures, adjustments, and specifications for GM transmissions, transaxles, and transfer cases.

RETAIL SELL PRICE: \$50.00

Service Bulletins

Service Bulletins give technical service information needed to knowledgeably service General Motors cars and trucks. Each bulletin contains instructions to assist in the diagnosis and service of your vehicle.

In Canada, information pertaining to Product Service Bulletins can be obtained by contacting your General Motors dealer or by calling 1-800-GM-DRIVE (1-800-463-7483).

Owner's Information

Owner publications are written specifically for owners and intended to provide basic operational information about the vehicle. The owner's manual will include the Maintenance Schedule for all models.

In-Portfolio: Includes a Portfolio, Owner's Manual, and Warranty Booklet.

RETAIL SELL PRICE: \$35.00

Without Portfolio: Owner's Manual only.

RETAIL SELL PRICE: \$25.00

Current and Past Model Order Forms

Service Publications are available for current and past model GM vehicles. To request an order form, please specify year and model name of the vehicle.

ORDER TOLL FREE: 1-800-551-4123 Monday-Friday 8:00 AM - 6:00 PM Eastern Time

For Credit Card Orders Only
(VISA-MasterCard-Discover), visit Helm, Inc. on the
World Wide Web at: www.helminc.com

Or you can write to:

Helm, Incorporated
P. O. Box 07130
Detroit, MI 48207

Prices are subject to change without notice and without incurring obligation. Allow ample time for delivery.

Note to Canadian Customers: All listed prices are quoted in U.S. funds. Canadian residents are to make checks payable in U.S. funds.

A

Accessory Power Outlets	3-11	Appearance Care	5-76
Adding Washer Fluid	5-35	Care of Safety Belts	5-79
Additional Program Information	7-9	Chemical Paint Spotting	5-82
Additives, Fuel	5-6	Cleaning the Inside of Your Vehicle	5-76
Add-On Electrical Equipment	5-84	Cleaning the Outside of Your Vehicle	5-79
Adjusting the Speakers (Balance/Fade)	3-35, 3-37	Finish Damage	5-81
Air Bag		Sheet Metal Damage	5-81
Readiness Light	3-26	Underbody Maintenance	5-82
Air Bag Systems	1-50	Vehicle Care/Appearance Materials	5-82
How Does an Air Bag Restrain?	1-56	Weatherstrips	5-79
Servicing Your Air Bag-Equipped Vehicle	1-58	Arming the System	2-15
What Makes an Air Bag Inflate?	1-55	Ashtrays	3-12
What Will You See After an		Audio System(s)	3-34
Air Bag Inflates?	1-56	AM-FM Radio	3-34
When Should an Air Bag Inflate?	1-55	Backglass Antenna	3-44
Where Are the Air Bags?	1-53	Care of Your CD Player	3-44
Air Cleaner/Filter, Engine	5-20	Care of Your CDs	3-44
Airbag Sensing and Diagnostic Module (SDM)	7-9	Radio with CD	3-36
AM	3-43	Theft-Deterrent Feature	3-43
AM-FM Radio	3-34	Understanding Radio Reception	3-43
Antenna, Backglass	3-44	Automatic Transaxle	2-20
Anti-lock Brake System (ABS)	4-7	Fluid	5-21
Anti-Lock Brake, System Warning Light	3-27	Operation	2-22
		Automatic Transaxle Inspection	6-20
		Automatic Transaxle Shift Lock Control	
		System Check	6-22

B

Backglass Antenna	3-44
Battery	5-39
Battery Replacement	2-6
Before Leaving on a Long Trip	4-21
Body Lubrication Service	6-21
Brake	
Parking	2-28
System Inspection	6-25
System Warning Light	3-20
Brake Fluid	5-36
Brake Wear	5-37
Brakes	5-36
Braking	4-6
Braking in Emergencies	4-9
Break-In, New Vehicle	2-18
Bulb Replacement	5-45
Fog Lamps	5-48
Front Turn Signal and Parking Lamps	5-46
Halogen Bulbs	5-45
Headlamp Aiming	5-45
Headlamps	5-46
Sidemarker Lamps	5-48, 5-49
Taillamps, Turn Signal, Stoplamps and Back-up Lamps	5-49
Turn Signal Lamps	5-47
Buying New Tires	5-62

C

California Fuel	5-6
Canada – Customer Assistance	7-4
Canadian Owners	ii
Canadian Roadside Assistance	7-7
Canceling the Rear Door Security Lock	2-9
Capacities and Specifications	5-91
Carbon Monoxide	4-24, 4-37, 2-10, 2-12, 2-32
Care of	
Safety Belts	5-79
Your CD Player	3-44
Your CDs	3-44
Cassette Tape Player Service	6-19
CD Messages	3-42
Center Rear Passenger Position, Safety Belts	1-26
Chains, Tires	5-66
Charging System Light	3-27
Check	
Engine Light	3-28
Check Engine Light	3-28
Checking Coolant	5-24
Checking Engine Oil	5-15
Checking Things Under the Hood	5-11
Checking Your Restraint Systems	1-58
Chemical Paint Spotting	5-82

Child Restraints		Cleaning the Top of the Instrument Panel	5-78
Child Restraint Systems	1-34	Cleaning Tires	5-81
Infants and Young Children	1-30	Cleaning Vinyl	5-78
Lower Anchorages and Top Tethers for		Cleaning Windshield and Wiper Blades	5-80
Children (LATCH System)	1-41	Climate Control System	3-12
Older Children	1-28	Air Filter, Passenger Compartment	3-16
Securing a Child Restraint Designed for		Outlet Adjustment	3-15
the LATCH System	1-44	Clock	3-25
Securing a Child Restraint in a Rear Seat		Clutch, Hydraulic	5-22
Position	1-44	Compact Spare Tire	5-75
Securing a Child Restraint in the Right Front		Control of a Vehicle	4-6
Seat Position	1-46	Coolant	
Top Strap	1-38	Engine Temperature Gage	3-21
Top Strap Anchor Location	1-40	Heater, Engine	2-21
Where to Put the Restraint	1-37	Surge Tank Pressure Cap	5-25
Cigarette Lighter	3-12	Cooling System	5-28
Cleaning		Cupholder(s)	2-36
Inside of Your Vehicle	5-76	Current and Past Model Order Forms	7-12
Outside of Your Vehicle	5-79	Customer Assistance Information	
Underbody Maintenance	5-82	Courtesy Transportation	7-7
Weatherstrips	5-79	Customer Assistance for Text	
Cleaning Aluminum Wheels	5-81	Telephone (TTY) Users	7-4
Cleaning Exterior Lamps/Lenses	5-80	Customer Assistance Offices	7-4
Cleaning Fabric/Carpet	5-76	Customer Satisfaction Procedure	7-2
Cleaning Glass Surfaces	5-78	GM Mobility Program for Persons with	
Cleaning Interior Plastic Components	5-78	Disabilities	7-5
Cleaning Leather	5-78	Reporting Safety Defects to General Motors	7-11

Customer Assistance Information (cont.)	
Reporting Safety Defects to the Canadian Government	7-11
Reporting Safety Defects to the United States Government	7-10
Roadside Assistance Program	7-6
Service Publications Ordering Information	7-11

D

Daytime Running Lamps (DRL)	3-8
Daytime Running Lamps Indicator Light	3-33
Defensive Driving	4-2
Defogging and Defrosting	3-14
Dinghy Towing	4-30
Disarming the System	2-16
Doing Your Own Service Work	5-4
Dolly Towing	4-31
Dome Lamp	3-10
Door	
Ajjar Light	3-33
Central Door Unlocking System	2-8
Door Ajjar Reminder	2-8
Locks	2-7
Rear Door Security Locks	2-9
Driver	
Position, Safety Belt	1-15
Seat Height Adjuster	1-3

Driving	
At Night	4-15
City	4-19
Defensive	4-2
Drunken	4-3
Freeway	4-20
Hill and Mountain Roads	4-22
In Rain and on Wet Roads	4-16
Winter	4-24
Driving on Snow or Ice	4-25
Driving Through Deep Standing Water	4-18
Driving Through Flowing Water	4-18

E

Electrical System	
Add-On Equipment	5-84
Fuses and Circuit Breakers	5-85
Headlamp Wiring	5-84
Power Windows and Other Power Options	5-84
Windshield Wiper Fuses	5-84
Emergency Trunk Release Handle	2-11
Emissions Inspection and Maintenance Programs	3-31
Engine	
Air Cleaner/Filter	5-20
Battery	5-39
Check and Service Engine Soon Light	3-28

Engine (cont.)	
Coolant	5-23
Coolant Heater	2-21
Coolant Temperature Gage	3-21
Cooling System Inspection	6-25
Engine Compartment Overview	5-14
Exhaust	2-32
Oil	5-15
Overheating	5-25
Starting	2-20
Engine Compartment Fuse Block	5-87
Engine Coolant Level Check	6-19
Engine Oil Additives	5-18
Engine Oil Level Check	6-19
Event Data Recorders (EDR)	7-9
Exterior Lamps	3-8

F

Filter	
Engine Air Cleaner	5-20
Finding a Station	3-34, 3-36
Finish Care	5-80
Finish Damage	5-81
Five-Speed	2-26
Flash-to-Pass Feature	3-6

Flat Tire	5-66
Flat Tire, Changing	5-67
Fluid	
Automatic Transaxle	5-21
Manual Transaxle	5-21
Power Steering	5-34
Windshield Washer	5-35
FM	3-43
Fog Lamp Light	3-32
Fog Lamps	3-6, 3-9
Folding the Seatback	1-6, 1-8
Footnotes	6-7, 6-14
Fuel	5-5
Additives	5-6
California Fuel	5-6
Filling a Portable Fuel Container	5-10
Filling Your Tank	5-8
Fuels in Foreign Countries	5-7
Gage	3-22
Gasoline Octane	5-5
Gasoline Specifications	5-5
Low Warning Light	3-23
System Inspection	6-25
Fuses	
Fuses and Circuit Breakers	5-85
Windshield Wiper	5-84

G

Gage	
Engine Coolant Temperature	3-21
Fuel	3-22
Speedometer	3-19
Tachometer	3-19
Gasoline	
Octane	5-5
Specifications	5-5
Glove Box	2-36
GM Mobility Program for Persons with Disabilities	7-5

H

Hazard Warning Flashers	3-3
Head Restraints	1-5
Headlamp	
Aiming	5-45
Headlamp High/Low-Beam Changer	3-6
Headlamp Wiring	5-84
Headlamps	5-46
Bulb Replacement	5-45
Front Turn Signal and Parking Lamps	5-46
Halogen Bulbs	5-45

Headlamps (cont.)	
Sidemarker Lamps	5-48, 5-49
Turn Signal Lamps	5-47
Height Adjuster, Driver Seat	1-3
Highbeam On Light	3-22
Highway Hypnosis	4-22
Hill and Mountain Roads	4-22
Hold Mode	2-25
Hold Mode Features	2-25
Hood	
Checking Things Under	5-11
Release	5-11
Horn	3-4
How the System Alarm is Activated	2-16
How to Add Coolant to the Coolant Surge Tank	5-30
How to Check	5-59
How to Check and Add Fluid	5-22
How to Check Power Steering Fluid	5-34
How to Detect a Tamper Condition	2-16
How to Inspect the Engine Air Cleaner/Filter	5-20
How to Turn Off the System Alarm	2-16
How to Use This Manual	ii
How to Wear Safety Belts Properly	1-15
Hydraulic Clutch	5-22
Hydraulic Clutch System Check	6-20
Hydroplaning	4-18

I

If No Steam Is Coming From Your Engine	5-27
If Steam Is Coming From Your Engine	5-26
If the Light Is Flashing	3-30
If the Light Is On Steady	3-30
If You Are Caught in a Blizzard	4-26
If You Are Stuck in Sand, Mud, Ice or Snow	4-28
Ignition Positions	2-19
Ignition Transaxle Lock Check	6-22
Immobilizer	2-17
Immobilizer Operation	2-17
Infants and Young Children, Restraints	1-30
Inflation - Tire Pressure	5-59
Inspection	
Brake System	6-25
Engine Cooling System	6-25
Exhaust System	6-24
Fuel System	6-25
Part C - Periodic Maintenance	6-24
Steering, Suspension and Front Drive Axle	
Boot and Seal	6-24
Throttle System	6-25
Instrument Panel	
Cluster	3-18
Overview	3-2
Instrument Panel Brightness	3-10
Instrument Panel Fuse Block	5-85
Interior Lamps	3-10

J

Jump Starting	5-40
---------------------	------

K

Key Lock Cylinders Service	6-21
Keyless Entry System	2-4
Keys	2-2

L

Lamps	
Exterior	3-8
Fog Lamps	5-48
Interior	3-10
Lamps On Reminder	3-8
Lap-Shoulder Belt	1-15, 1-23
LATCH System	
Child Restraints	1-41
Securing a Child Restraint Designed for the LATCH System	1-44
Leaving Your Vehicle	2-10
Leaving Your Vehicle With the Engine Running	2-29
Liftgate	2-12

Light

Air Bag Readiness	3-26
Anti-Lock Brake System Warning	3-27
Brake System Warning	3-20
Charging Systems	3-27
Daytime Running Lamps Indicator	3-33
Door Ajar	3-33
Fog Lamp	3-32
Highbeam On	3-22
Low Fuel Warning	3-23
Malfunction Indicator	3-28
Oil Pressure	3-32
Safety Belt Reminder	3-25
Safety Belt Reminder Tone	3-20
Loading Your Vehicle	4-32
Lockout Protection	2-10
Locks	
Central Door Unlocking System	2-8
Door	2-7
Leaving Your Vehicle	2-10
Lockout Protection	2-10
Rear Door Security Locks	2-9
Long Trip/Highway Definition	6-6
Long Trip/Highway Intervals	6-6
Long Trip/Highway Scheduled Maintenance	6-14
Loss of Control	4-14
Low Fuel Warning Light	3-23

M

Maintenance Schedule	
At Each Fuel Fill	6-19
At Least Once a Month	6-19
At Least Once a Year	6-21
At Least Twice a Year	6-20
Brake System Inspection	6-25
Engine Cooling System Inspection	6-25
Exhaust System Inspection	6-24
Fuel System Inspection	6-25
How This Section is Organized	6-3
Introduction	6-2
Long Trip/Highway Scheduled Maintenance	6-14
Maintenance Requirements	6-2
Part A - Scheduled Maintenance Services	6-4
Part B - Owner Checks and Services	6-19
Part C - Periodic Maintenance Inspections	6-24
Part D - Recommended Fluids and Lubricants	6-26
Part E - Maintenance Record	6-28
Selecting the Right Schedule	6-5
Short Trip/City Scheduled Maintenance	6-7
Steering, Suspension and Front Drive Axle	
Boot and Seal Inspection	6-24
Throttle System Inspection	6-25
Using Your	6-4
Your Vehicle and the Environment	6-2

Malfunction Indicator Light	3-28	Oil	
Manual Seats	1-2	Engine	5-15
Manual Transaxle	2-20	Pressure Light	3-32
Fluid	5-21	Older Children, Restraints	1-28
Operation	2-26	Online Owner Center	7-3
Manual Transaxle Check	6-20	Opening a Rear Door When the Security Lock	
Manual Windows	2-14	is On	2-9
Mexico, Central America and Caribbean Islands/ Countries (Except Puerto Rico and U.S. Virgin Islands) – Customer Assistance	7-5	Other Warning Devices	3-4
Mirrors		Outlet Adjustment	3-15
Manual Rearview Mirror	2-34	Outside	
Outside Convex Mirror	2-35	Convex Mirror	2-35
Outside Heated Mirrors	2-35	Heated Mirrors	2-35
Outside Manual Mirrors	2-34	Manual Mirrors	2-34
Outside Power Mirror	2-35	Power Mirror	2-35
MyGMLink.com	7-3	Overseas – Customer Assistance	7-5
		Owners, Canadian	ii
		Owner's Information	7-12

N

New Vehicle Break-In	2-18
----------------------------	------

O

Odometer	3-19
Off-Road Recovery	4-12

P

Park (P)	
Shifting Into	2-29
Shifting Out of	2-30
Parking	
Brake	2-28
Over Things That Burn	2-32

Parking Brake and Automatic Transaxle	
Park (P) Mechanism Check	6-23
Parking Your Vehicle	2-31
Part A - Scheduled Maintenance Services	6-4
Part B - Owner Checks and Services	6-19
Part C - Periodic Maintenance Inspections	6-24
Part D - Recommended Fluids and Lubricants	6-26
Part E - Maintenance Record	6-28
Passenger Compartment Air Filter	3-16
Passing	4-12
Plan Ahead When Possible	7-7
Playing a CD	3-38
Playing the Radio	3-34, 3-36
Power	
Accessory Outlets	3-11
Electrical System	5-84
Steering Fluid	5-34
Windows	2-14
Power Steering	4-10
Pretensioners, Safety Belt	1-27

Q

Questions and Answers About Safety Belts	1-14
--	------

R

Radios	3-34
AM-FM Radio	3-34
Care of Your CD Player	3-44
Care of Your CDs	3-44
Radio with CD	3-36
Theft-Deterrent	3-43
Understanding Reception	3-43
Rear Door Security Locks	2-9
Rear Seat Operation	1-6, 1-8
Rear Seat Outside Positions	1-23
Rear Seat Passengers, Safety Belts	1-23
Rear Window and Outside Mirror Defogger	3-15
Rear Window Washer/Wiper	3-7
Rearview Mirrors	2-34
Reclining Seatbacks	1-3
Recreational Vehicle Towing	4-29
Remote Keyless Entry System	2-4
Remote Keyless Entry System, Operation	2-5
Remote Trunk Release	2-11
Removing the Flat Tire and Installing the Spare Tire	5-69
Removing the Spare Tire and Tools	5-68
Replacing Brake System Parts	5-38
Replacing Restraint System Parts After a Crash	1-59

Reporting Safety Defects	
Canadian Government	7-11
General Motors	7-11
United States Government	7-10
Restraint System Check	6-20
Checking Your Restraint Systems	1-58
Replacing Restraint System Parts After a Crash	1-59
Restraint Systems	
Checking	1-58
Replacing Parts	1-59
Right Front Passenger Position, Safety Belts	1-23
Roadside	
Assistance Program	7-6
Rocking Your Vehicle To Get It Out	4-29
Running Your Engine While You Are Parked	2-33

S

Safety Belt	
Pretensioners	1-27
Reminder Light	3-25
Reminder Tone	3-20
Safety Belts	
Care of	5-79
Center Rear Passenger Position	1-26
Driver Position	1-15

Safety Belts (cont.)	
How to Wear Safety Belts Properly	1-15
Questions and Answers About Safety Belts	1-14
Rear Seat Passengers	1-23
Right Front Passenger Position	1-23
Safety Belt Use During Pregnancy	1-22
Safety Belts Are for Everyone	1-10
Safety Warnings and Symbols	iii
Seats	
Driver Seat Height Adjuster	1-3
Head Restraints	1-5
Manual	1-2
Rear Seat Operation	1-6, 1-8
Reclining Seatbacks	1-3
Secondary Information Center (SIC)	3-24
Securing a Child Restraint	
Designed for the LATCH System	1-44
Rear Seat Position	1-44
Right Front Seat Position	1-46
Security While You Travel	7-6
Selecting the Right Schedule, Maintenance	6-5
Service	5-3
Adding Equipment to the Outside of Your Vehicle	5-4
Doing Your Own Work	5-4
Engine Soon Light	3-28
Publications Ordering Information	7-11

Service Bulletins	7-11
Service Manuals	7-11
Setting Preset Stations	3-35, 3-36
Setting the Tone (Bass/Treble)	3-35, 3-37
Sheet Metal Damage	5-81
Shift Speeds	2-27
Shifting Into Park (P)	2-29
Shifting Out of Park (P)	2-30
Short Trip/City Definition	6-5
Short Trip/City Intervals	6-5
Short Trip/City Scheduled Maintenance	6-7
Shoulder Belt Height Adjuster	1-17
Skidding	4-14
Some Other Rainy Weather Tips	4-18
Special Fabric Cleaning Problems	5-77
Specifications, Capacities	5-91
Speedometer	3-19
Starter Switch Check	6-21
Starting Your Engine	2-20
Steering	4-10
Steering in Emergencies	4-11
Steering, Suspension and Front Drive Axle	
Boot and Seal Inspection	6-24
Steering Tips	4-10
Steering Wheel, Tilt Wheel	3-4
Storage Areas	2-36
Cupholder(s)	2-36
Glove Box	2-36
Sunglasses Storage Compartment	2-37

Storing the Flat Tire and Tools	5-74
Storing the Spare Tire and Tools	5-74
Stuck in Sand, Mud, Ice or Snow	4-28
Sun Visors	2-14
Sunglasses Storage Compartment	2-37
Sunroof	2-37

T

Tachometer	3-19
Taillamps	
Turn Signal, Stoplamps and Back-up Lamps	5-49
Theft-Deterrent, Radio	3-43
Theft-Deterrent System	2-15
Theft-Deterrent Systems	2-15
Immobilizer	2-17
Immobilizer Operation	2-17
Throttle System Inspection	6-25
Tilt Wheel	3-4
Tire Inflation Check	6-19
Tire Sidewall Labeling	5-52
Tire Size	5-55
Tire Terminology and Definitions	5-56
Tires	5-51
Buying New Tires	5-62
Chains	5-66
Changing a Flat Tire	5-67
Compact Spare Tire	5-75

Tires (cont.)	
If a Tire Goes Flat	5-66
Inflation - Tire Pressure	5-59
Inspection and Rotation	5-60
Uniform Tire Quality Grading	5-63
Wheel Alignment and Tire Balance	5-64
Wheel Replacement	5-64
When It Is Time for New Tires	5-61
Matching Transmitter(s) to Your Vehicle	2-5
To Use the Engine Coolant Heater	2-21
Top Strap	1-38
Top Strap Anchor Location	1-40
Torque Lock	2-30
Towing	
Recreational Vehicle	4-29
Towing a Trailer	4-37
Your Vehicle	4-29
Transaxle	
Fluid, Automatic	5-21
Fluid, Manual	5-21
Transaxle Operation, Automatic	2-22
Transaxle Operation, Manual	2-26
Transmission, Transaxle, Transfer Case Unit	
Repair Manual	7-11
Transportation Options	7-8
Trip Odometer	3-19
Trunk	2-10
Turn and Lane-Change Signals	3-5
Turn Signal/Multifunction Lever	3-5

U

Underbody Flushing Service	6-23
Understanding Radio Reception	3-43
Uniform Tire Quality Grading	5-63
United States – Customer Assistance	7-4
Used Replacement Wheels	5-65
Using an MP3 CD	3-39
Using Cleaner on Fabric	5-77
Using the Rear Door Security Lock	2-9

V

Vehicle	
Control	4-6
Damage Warnings	iv
Loading	4-32
Parking Your	2-31
Symbols	iv
Vehicle Data Collection and Event Data	
Recorders	7-9
Vehicle Identification	
Number (VIN)	5-83
Service Parts Identification Label	5-84
Vehicle Storage	5-39
Ventilation Adjustment	3-15
Visor Vanity Mirror	2-14
Visors	2-14

W

Warning Lights, Gages and Indicators	3-17
Warnings	
Hazard Warning Flashers	3-3
Other Warning Devices	3-4
Safety and Symbols	iii
Vehicle Damage	iv
Washing Your Vehicle	5-79
Weatherstrip Lubrication	6-20
What Kind of Engine Oil to Use	5-16
What to Do with Used Oil	5-19
What to Use	5-23, 5-34, 5-35
Wheels	
Alignment and Tire Balance	5-64
Replacement	5-64
When to Add Engine Oil	5-16
When to Change Engine Oil	5-18
When to Check	5-59
When to Check and What to Use	5-22
When to Check Power Steering Fluid	5-34
When to Inspect the Engine Air Cleaner/Filter	5-20

Where to Put the Restraint	1-37
Why Safety Belts Work	1-11
Window Lockout	2-14
Windows	2-13
Manual	2-14
Power	2-14
Windshield Washer	3-7
Fluid	5-35
Windshield Washer Fluid Level Check	6-19
Windshield Wiper	
Blade Replacement	5-50
Fuses	5-84
Windshield Wiper Lever	3-6
Windshield Wipers	3-6
Winter Driving	4-24
Wiper Blade Check	6-20

Y

Your Vehicle and the Environment	6-2
--	-----