

2004 KOUNTRY STAR

CLASS A / DIESEL PUSHER BY NEWMAR



2004 KOUNTRY STAR

CLASS A / DIESEL PUSHER BY NEWMAR

DESTINATION:

Fishing Trip, Grand Tetons



NEWMARCORP.COM

Now, this is my kind of country: bold, challenging.



If we at Newmar say we build a spirit of adventure into an RV, are we just being “poetic”? Not the way we build the Kountry Star Class A and Diesel Pusher. These motorhomes go anywhere by design. What’s more, they provide a standard of travel living that other, similarly priced motorhomes have not achieved. Go ahead: Compare. You’ll see Kountry Star’s superiority in its crisp, clean styling, inside and out...its exceptional details...and its broad range of luxurious, comfort-enhancing amenities. No matter how adventurous you are, Kountry Star’s clearly got the spirit for it.





DP3904/Venice Green



CA3560/Atlantis Blue

B

- A. Generous cabinets and countertop space, plus an open, airy layout, make this diesel pusher kitchen a model of convenience.
- B. A handy flip-up/flip-down Corian® countertop extension and a pullout cutting board increase the Kountry Star kitchen's utility.
- C. Further cabinet and countertop space is provided by this elegant dry bar, the overhead cabinets of which feature mirrored door panels.
- D. Since the Corian sink cover sits flush with the countertop, your food-prep surface area is significantly expanded.



CA3560/Atlantis Blue

C



CA3651/Chamois

D

AUGUST 29 ~

Day One: Headed out on Jackson Lake from Coulter Bay. Boy 3'olobok, Chuck and I had caught and released 3 trout @ once.



A



DP3705/Carbon



B

- A. The living room slideout opens up floor space while elegant window treatments, a plush sofa and a free-standing dinette lend cozy comfort.
- B. Ergonomic Flexsteel® captain's chairs and a well-designed dashboard put you in firm command of the road.
- C. Standard in the cockpit overhead is an advanced 19" Sony® flat-screen color TV.
- D. Supreme relaxation is a sure bet with this Flexsteel swivel recliner, next to which is a useful flip-up table.



C



D

DP3904/Venice Green

AUGUST 30 ~

*Day Two: Air is crisp, lots of sunshine, but great, billowing clouds in the sky.
Saw some ospreys and this really big blue heron at the water's edge.*



A



B

CA3651/Chamois



C

DP3904/Venice Green

- A. A good night's rest is yours in Kountry Star's soft yet supportive queen-size bed.
- B. Featured in this private bathroom with two entrances is an easy-to-clean, one-piece-fiberglass shower stall with an obscure glass door.
- C. Our new raised roof increases ceiling height to 6'6" while bedroom slideout windows expand your view, let in more light and aid ventilation.
- D. Is the bathroom in use? Never mind, this Kountry Star gives you the added convenience of a bedroom sink.
- E. Standard in the bedroom is this advanced 19" Philips Magnavox® color TV with its own built-in cabinet shelf.



D

DP3904/Venice Green



E

CA3560/Atlantis Blue

NEWMAR'S FREEDOM WARRANTY™

Your Kountry Star Class A or Diesel Pusher motorhome is built to take you as far as your road rolls on...for as long as you roll on with it. Because there's more than enough solid engineering here to ensure years of travel pleasure.

Kountry Star is assembled on the same production line, to the same exacting standards and with the same meticulous care, as all Newmar motorhomes. It also embodies Newmar's long history of product innovation and industry "firsts." For us, it's a matter of pride. And tradition. Of taking personal responsibility and building a product that each of us, ourselves, would want to own.

As proof of our commitment, we back every motorhome we make with a three-year/36,000-mile (Class A) or 50,000-mile (Diesel Pusher) bumper-to-bumper limited warranty: The Newmar Freedom Warranty. Ask your dealer for details. You're sure to find coverage this comprehensive a truly liberating experience.

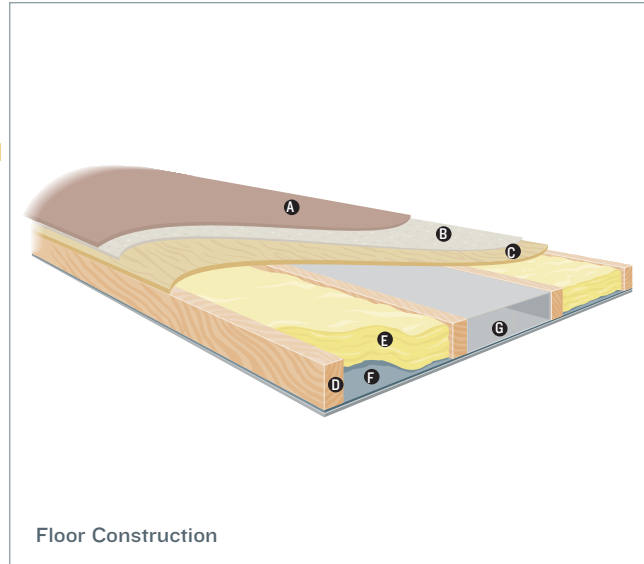

Floor Construction

- A. Plush carpet*
- B. Carpet padding
- C. 5/8" floor decking
- D. 2" x 3" wood stringer
- E. Fiberglass batten insulation
- F. Polyethylene moisture barrier
- G. In-floor heating ducts

*Ceramic tile, simulated floor and simulated tile options also available.

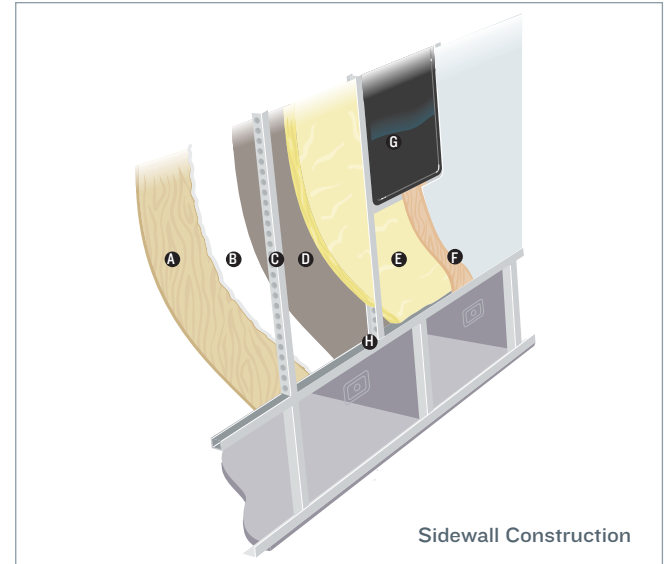

Sidewall Construction

- A. Plywood interior wallboard
- B. 5/8" bead foam
- C. 1.5" C-channel aluminum studs with punched holes
- D. Kraft paper vapor barrier
- E. Fiberglass insulation
- F. Composite one-piece gel coat exterior sidewall
- G. Framed windows
- H. Aluminum sidewall structure with 16" on-center framing

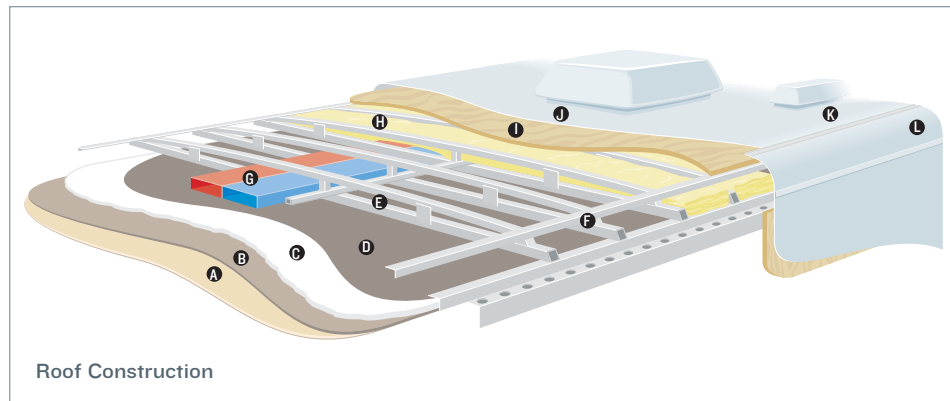

Roof Construction

- A. Soft touch vinyl
- B. 3/16" panel
- C. 5/8" bead foam
- D. Kraft paper vapor barrier
- E. 1" tubular aluminum truss rafter with full joint weld
- F. Welded aluminum crowned roof structure with 16" on-center framing
- G. True Central Air Conditioning—insulated ducted distribution and return
- H. Fiberglass batten insulation
- I. 7mm wood decking
- J. Brite-Tek or fiberglass roof
- K. One-piece fiberglass caps
- L. Aluminum or fiberglass wrap—additional aluminum reinforced extrusion connecting sidewall to roof for most slideouts

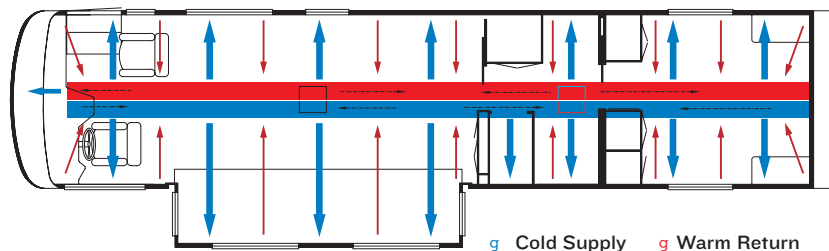

TRUE CENTRAL AIR: Newmar's True Central Air System—standard with every Newmar RV—is just like those found in most site-built homes. It's actually two separate, fully ducted systems: one to distribute incoming cool air, the other to quickly and effectively remove warm air from every living area.



g Cold Supply g Warm Return



A



B



C



D



E

EXTERIOR FEATURES

- A. Halogen headlamps
- B. Large, powered sideview mirrors
- C. Classic chrome finish wheels and lugnuts
- D. Accommodating storage compartments with hydraulic piston-supported doors
- E. Attractive fiberglass end cap

Day Three: Backpacker today. Came upon a small herd of bison — took care to keep our distance.



INTERIOR COLORS

A. Atlantis Blue
B. Carbon

C. Chamois
D. Venice Green

NEWMARCORP.COM

Here you'll discover the latest model specifications, floor plans and options, as well as information on who we are, how we work and what we believe in.

Real woods will have natural variations in grain and color. Natural wood products will darken over time.



A



B



C



D



E



F



G



H



I

EXTERIOR COLORS

- A. Venice Green (Class A)
- B. Atlantis Blue (Class A)
- C. Chamois (Class A)
- D. Crystal Blue (Diesel Pusher)
- E. Sandalwood (Diesel Pusher)
- F. Pale Green (Diesel Pusher)
- G. Sandrift (Diesel Pusher—Full Paint Option)
- H. Midnight Grey (Diesel Pusher—Full Paint Option)
- I. Espresso (Diesel Pusher—Full Paint Option)

FULL-PAINT MASTERPIECE FINISH™

The Full-Paint Masterpiece Finish from Newmar creates an exterior of stunning beauty and incredible endurance—a true work of art. Newmar is an industry leader in applying full body paint to its coaches. We are pleased to offer it as an option on your Kountry Star Class A or Diesel Pusher.



A NEW BREED.™
www.workhorse.com



THE LEADER AT EVERY TURN™
www.freightlinerchassis.com

Wonder where our next road will lead?

THE NEWMAR KOUNTRY KLUB

As a Newmar owner, you qualify for membership in the Newmar Kountry Klub. Join your local chapter, and just look at the perks you'll enjoy: friendship, fun and adventure with other Newmar owners • rallies and caravans • special RV show events • discounts on RV services • a free monthly Klub magazine • Klub merchandise. And that's just for starters.

Join today! Call 877-639-5582, toll-free, or visit the Klub section of newmarcorp.com.

THE NEWMAR FACTORY TOUR

We'd love to have you visit our state-of-the-art production facility in Nappanee, Indiana. For details, including tour days and times, please call 574-773-7791.

NEWMAR CORPORATION
355 N DELAWARE ST
PO BOX 30
NAPPANEE IN 46550-0030
574-773-7791 Fax 574-773-2895
www.newmarcorp.com

Official Newmar Dealer:



NEWMAR QUALITY: A WAY OF LIFE

Some features shown in our literature are optional. Colors and finishes are photographic representations: The actual materials may look different. Prices, specifications and floor plans are subject to change at Newmar's discretion without prior written notice or obligation. Please see your dealer for actual samples and specifications. © 2003 Newmar Corporation. Printed in the U.S.A. (05/03)

2004 KOUNTRY STAR
CLASS A / DIESEL PUSHER BY NEWMAR



2004 KOUNTRY STAR

CLASS A / DIESEL PUSHER BY NEWMAR

DESTINATION:

Fishing Trip, Grand Tetons



NEWMARCORP.COM

CLASS A SPECIFICATIONS

STANDARD FEATURES

MOTORIZED CHASSIS FEATURES

- Cruise Control
- Stainless Steel Wheel Simulators
- Tilt Steering Wheel
- Workhorse® W-22 Chassis

AIR CONDITIONING & HEATING

- 15,000-Btu Brisk® Central Air Conditioner
- LP Leak Detector
- Dash Heater and High-Output Air Conditioner
- LP Furnace with In-Floor Ducted Heat

APPLIANCES & ACCESSORIES

- Ten-Gal. Gas/Electric Water Heater with Direct-Spark Ignition
- Spacesaver Microwave
- Flat-Screen Color TV in Living Area
- Color TV in Bedroom
- Three-Burner Recessed Range with Glass Oven Door and Piezzo Ignition
- AM/FM Dash Radio with CD Player
- Dometic® 3862 Refrigerator (8 Cu. Ft.)
- Rearview Monitor Prep
- TV Antenna with Power Booster, One Exterior Jack and Two Interior Jacks
- VCR and TV Video Selector Switch
- Cable TV Connection with RG 6 Coax
- Satellite Prep (Phone, TV Jack and Recept)
- Trumpet Horn
- Speaker Switch System
- Range Cover of Matching Countertop Material

CABINETS & FURNITURE

- Flexsteel® Swivel and Recline Front Seats
- Flexsteel Swivel Rocker Recliner
- Flexsteel Sofa
- Drawers with Metal Guides
- Hidden-Leaf Dinette Table with Two Fixed Chairs and Two Folding Chairs
- Oak Hardwood Raised-Panel Cabinet Doors
- Corian® Countertop in Kitchen with Undermount Acrylic Sink and Flush Sink Covers
- One-Piece Molded Countertop in Bathroom with Integrated Bowl
- Lifts on Bed Top To Access Storage Area

ELECTRICAL FEATURES

- 55-amp Converter
- Battery Disconnect for House Batteries
- 5,500-watt Guardian® Generator with One Remote Switch and Automatic Changeover
- 5-watt Solar Panel to Charge Chassis Battery

- 50-amp Electrical Service with Flexible Cord
- Emergency Engine Start Switch
- Exterior Security Lights, One Installed on Each Side
- Lights in Exterior Storage Compartments
- Lights in Wardrobes
- ICC Light Flasher Switch
- Driving Lights
- Interior Courtesy Lights

EXTERIOR FEATURES

- BriteTek® Roof with 7mm Decking
- Convex Exterior Mirrors with Remote Control and Defrost
- Gel-Coated Fiberglass Exterior Sides
- Class 3, 5,000 lb. Hitch

INTERIOR FEATURES

- Day/Night Pleated Window Shades and Lambrequins
- Padded Vinyl Ceiling
- Vinyl Floor in Kitchen and Bathroom Areas
- Quilted Bedspread with Reverse Sham and Accent Pillows
- Hardwood/Fabric Fascia on Living Area Slideout

PLUMBING & BATH FEATURES

- Exterior Shower (Located on Off-Door Side)
- Monitor Panel
- Sewage Holding-Tank Rinse
- SeaLand® 500+ China Stool
- Fiberglass Tub/Shower with Glass Shower Door
- Water-Heater Bypass System
- Demand Water System with Shurflo Pump
- Sewage Hose Holder, Easy Access Flip-Down Tray

CONSTRUCTION FEATURES

- Aluminum-Frame Sidewalls and Roof Construction, 16" On Center
- Roof R-Value Rating: 16
- Sidewall R-Value Rating: 11
- Floor R-Value Rating: 11
- R7 Fiberglass Insulation in Sidewalls and Floor, R11 in Roof
- 5/8" Foam Insulation Laminated in Sidewalls and Ceiling

WINDOWS, AWNINGS & VENTS

- Tinted Safety-Glass Windows
- Automatic Double Entrance-Door Step
- Power Vent in Bathroom with Wall Switch
- Fan-Tastic® Vent with Rain Sensor in Kitchen Area
- Skylight in Bathroom

OPTIONAL FEATURES

MOTORIZED CHASSIS FEATURES

- Polished Aluminum Wheels

APPLIANCES & ACCESSORIES

- 30" Convection Microwave with Three-Burner Cooktop (13 lb.)
- Norcold® Four-Door Refrigerator (45 lb.)
- Dometic® 1062 Refrigerator, 10 Cu. Ft. (91 lb.)
- Washer/Dryer Prep for Compact Washer/Dryer (22 lb.)
- Compact Washer/Dryer (185 lb.)
- Two-Piece Washer/Dryer (232 lb.)
- External Entertainment Center (40 lb.)
- CB Radio (2 lb.)
- XM Satellite Radio Capability (2 lb.)
- U-Line Icemaker (57 lb.)

CABINETS & FURNITURE

- Washington Cherry Hardwood Cabinets
- Maple Cream Cabinets
- Summer Maple Hardwood Cabinets
- Oak Hardwood Cabinets
- Arnold Cherry Cabinets
- Six-Way Power Driver's Seat (16 lb.)
- Built-In Booth Dinette (23 lb.)
- Combination Desk/Dinette Table (50 lb.)

ELECTRICAL FEATURES

- 400-watt Inverter for Dash TV (10 lb.)
- 7,500-watt Guardian® Generator in Lieu of Standard
- 7,000-watt Onan® Generator in Lieu of Standard
- Recessed Docking Lights (4 lb.)
- Exterior Security Lights, Two Installed on Each Side

EXTERIOR FEATURES

- Rear Ladder (4 lb.)

INTERIOR FEATURES

- 12" Marble-Look Floor Tile in Kitchen and Main Bathroom Areas (20 lb.)
- Simulated Plank Floor in Kitchen and Main Bathroom Areas (71 lb.)

WINDOWS, AWNINGS & VENTS

- Driver's-Side Door with Power Window (50 lb.)
- Double-Pane Tinted Safety-Glass Windows (125 lb.)
- Fan-Tastic® Vent in Bathroom in Lieu of Standard

DIESEL PUSHER SPECIFICATIONS

STANDARD FEATURES

MOTORIZED CHASSIS FEATURES

- Cruise Control
- Anti-Lock Braking System
- Tilt and Telescope Steering Wheel
- Recessed Fuel Fills with Crossover To Fill from Either Side
- 300-HP Freightliner® Chassis, Std. on 3352, 3353, 3702 and 3705
- 330-HP Freightliner Chassis, Std. on 3905
- Stainless Steel Wheel Simulators

AIR CONDITIONING & HEATING

- 15,000-Btu Brisk® Central Air Conditioner
- LP Leak Detector
- Dash Heater and High-Output Air Conditioner

APPLIANCES & ACCESSORIES

- Ten-Gal. Gas/Electric Water Heater with Direct-Spark Ignition
- Spacesaver Microwave
- Flat-Screen Color TV in Living Area
- Color TV in Bedroom
- Three-Burner Recessed Range with Glass Oven Door and Piezzo Ignition
- AM/FM Dash Radio with CD Player
- Dometic® 3862 Refrigerator (8 Cu. Ft.)
- TV Antenna with Power Booster, One Exterior Jack and Two Interior Jacks
- VCR and TV Video Selector Switch
- Cable TV Connection with RG 6 Coax
- Satellite Prep (Phone, TV Jack and Recept)
- Trumpet Horn
- Speaker Switch System
- Range Cover of Matching Countertop Material
- Rearview Monitor Prep

CABINETS & FURNITURE

- Ultra Leather Front Seats with Six-Way Power, Power Lumbar and Ergo-Flex Arms
- Flexsteel® Swivel Rocker Recliner
- Flexsteel Sofa
- Drawers with Metal Guides
- Hidden-Leaf Dinette Table with Two Fixed Chairs and Two Folding Chairs
- Oak Hardwood Raised-Panel Cabinet Doors
- Corian® Countertop in Kitchen with Undermount Acrylic Sink and Flush Sink Covers
- One-Piece Molded Countertop in Bathroom with Integrated Bowl
- Lifts on Bed to Access Storage Area

ELECTRICAL FEATURES

- 55-amp Converter
- Battery Disconnect for House Batteries
- 7,500-watt Guardian® Diesel Generator with Automatic Changeover
- 5-watt Solar Panel to Charge Chassis Battery
- 50-amp Electrical Service with Flexible Cord
- Emergency Engine Start Switch
- Exterior Security Lights, One Installed on Each Side
- Lights in Exterior Storage Compartments
- Lights in Wardrobes
- ICC Light Flasher Switch
- Two 6 V House Batteries
- Midship Side Turn Signals
- Driving Lights
- Interior Courtesy Lights

EXTERIOR FEATURES

- BriteTek® Roof with 7mm Decking
- Convex Exterior Mirrors with Remote Control and Defrost
- Gel-Coated Fiberglass Exterior Sides
- Class 3, 6,000 lb. Hitch

INTERIOR FEATURES

- Day/Night Pleated Window Shades and Lambrequins
- Padded Vinyl Ceiling
- Quilted Bedspread with Reverse Sham and Accent Pillows
- Vinyl Floor in Kitchen and Bathroom Areas
- Hardwood/Fabric Fascia on Living Area Slideout

PLUMBING & BATH FEATURES

- Exterior Shower Located on Off-Door Side
- Monitor Panel
- Sewage Holding-Tank Rinse
- SeaLand® 500+ China Stool
- Fiberglass Tub/Shower with Glass Shower Door
- Water-Heater Bypass System
- Demand Water System with Shurflo Pump

CONSTRUCTION FEATURES

- Aluminum-Frame Sidewalls and Roof Construction, 16" On Center
- Roof R-Value Rating: 16
- Sidewall R-Value Rating: 11
- Floor R-Value Rating: 12
- R7 Fiberglass Insulation in Sidewalls and Floor, R11 in Roof
- 5/8" Foam Insulation Laminated in Sidewalls and Ceiling

WINDOWS, AWNINGS & VENTS

- Tinted Safety-Glass Windows
- Automatic Double Entrance-Door Step
- Fan-Tastic® Vent with Rain Sensor in Kitchen Area
- Power Vent in Bathroom with Wall Switch
- Skylight in Bathroom
- Front Entry Door with Power Flush Stepwell Cover

OPTIONAL FEATURES

GRAPHICS & DECOR CHOICES

- Exterior Full-Paint Graphics

MOTORIZED CHASSIS FEATURES

- 330-HP Freightliner Chassis, Available on 3702 and 3705

APPLIANCES & ACCESSORIES

- Norcold® Four-Door Refrigerator (45 lb.)
- Dometic® I062 Refrigerator, 10 Cu. Ft. (91 lb.)
- Dometic I292 Refrigerator, 12 Cu. Ft. (47 lb.)
- Washer/Dryer Prep (22 lb.)
- Compact Washer/Dryer (185 lb.)
- 30" Convection Microwave with Three-Burner Cooktop (13 lb.)
- Air Horns (5 lb.)
- Ceiling Fan in Bedroom (10 lb.)
- Remote IO-Disc CD Changer with Amplifier, Subwoofer and Dash Cassette Radio (10 lb.)
- CB Radio (2 lb.)
- Two-Piece Washer/Dryer (232 lb.)
- XM Satellite Radio Capability (2 lb.)

CABINETS & FURNITURE

- Washington Cherry Hardwood Cabinets
- Summer Maple Hardwood Cabinets
- Arnold Cherry Cabinets
- Maple Cream Cabinets
- Oak Hardwood Cabinets
- Built-In Booth Dinette (23 lb.)
- Combination Desk/Dinette Table (50 lb.)

ELECTRICAL FEATURES

- 8,000-watt PowerTech® Diesel Quiet Series Generator (-34 lb.)
- 400-watt Inverter for Dash TV (10 lb.)
- Recessed Docking Lights (4 lb.)
- Exterior Security Lights, Two Installed on Each Side
- 7,500-watt Onan® Diesel Quiet Series Generator (-80 lbs.)

EXTERIOR FEATURES

- Rear Ladder (4 lb.)

INTERIOR FEATURES

- 12" Marble-Look Floor Tile in Kitchen and Main Bathroom Areas (20 lb.)
- Simulated Plank Floor in Kitchen and Main Bathroom Areas (71 lb.)
- Simulated Ceramic Floor in Kitchen and Main Bathroom Areas (71 lb.)
- Front Entry Door Mat (8 lb.)
- Sun Shade on Front Side Windows (4 lb.)
- Simulated Ceramic Floor Tile Between Driver and Passenger Seats

WINDOWS, AWNINGS & VENTS

- Double-Pane Tinted Safety-Glass Windows (125 lb.)
- Fan-Tastic® Vent in Bathroom (11 lb.)

FLOOR PLANS

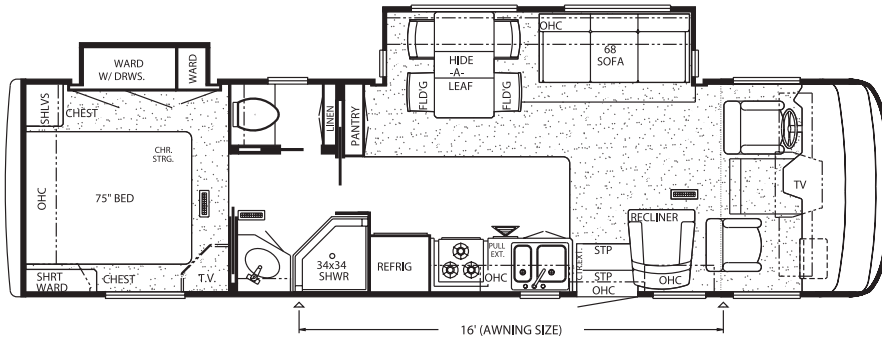

Model Shown: KSCA3301

Floor Plan Options: K125, K273

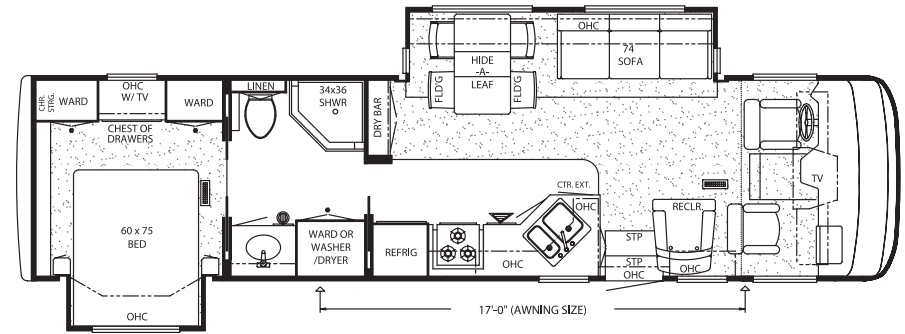

Model Shown: KSCA3560

Floor Plan Options: K125, K273, P300

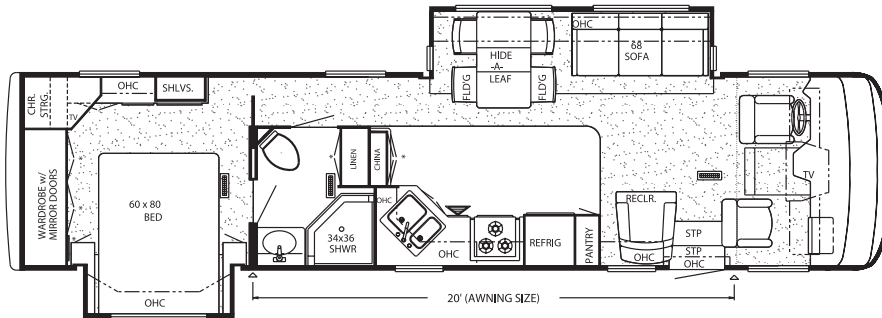

Model Shown: KSCA3651

Floor Plan Options: J780, K125, K273

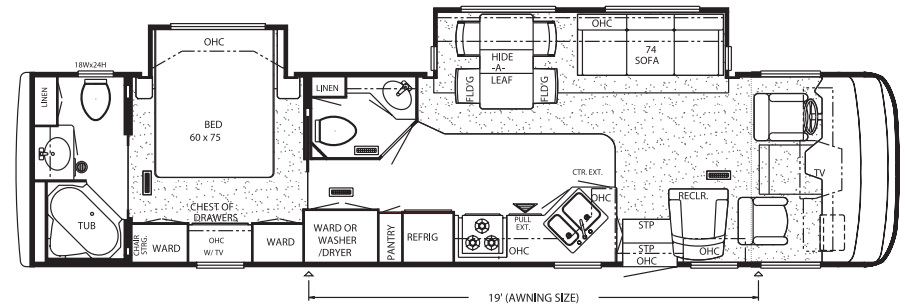

Model Shown: KSCA3740

Floor Plan Options: K125, K273, K860

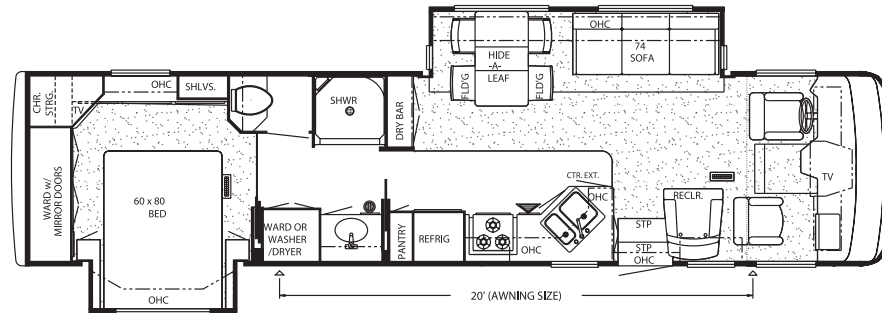

Model Shown: KSCA3778

Floorplan Options: K125, K273

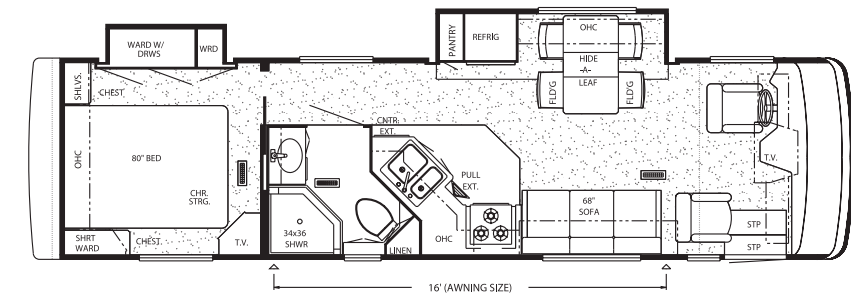

Model Shown: KSDP3352

Floor Plan Options: K326, K410

FLOOR PLANS

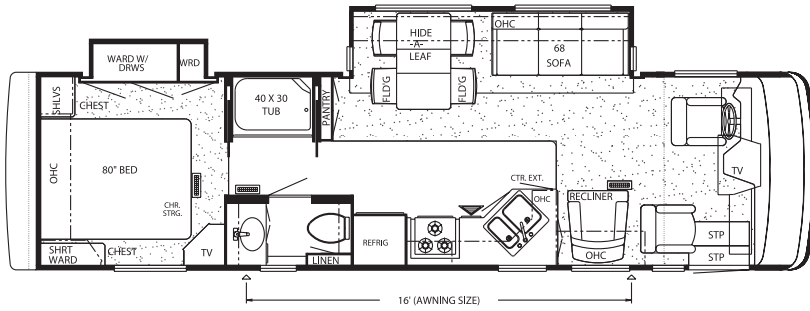

Model Shown: KSDP3353

Floor Plan Options: K125, K273

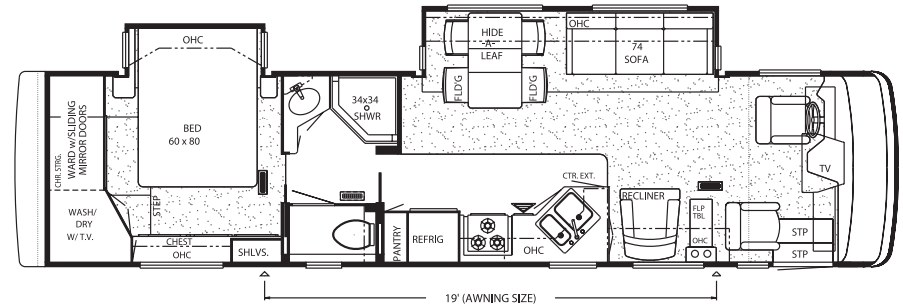

Model Shown: KSDP3702

Floor Plan Options: K125, K273, P090

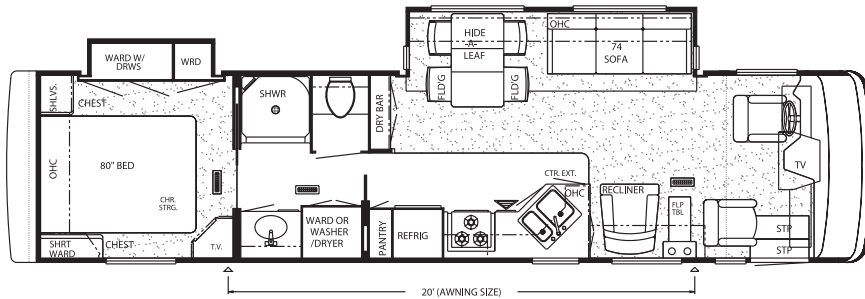

Model Shown: KSDP3705

Floor Plan Options: K125, K273

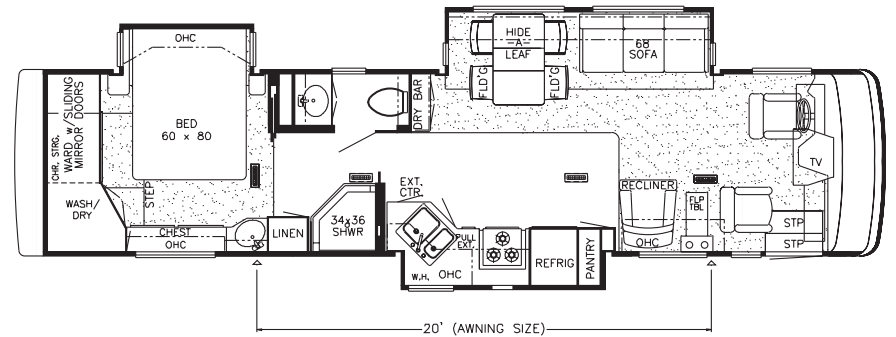

Model Shown: KSDP3904

Floor Plan Options: K125, K273

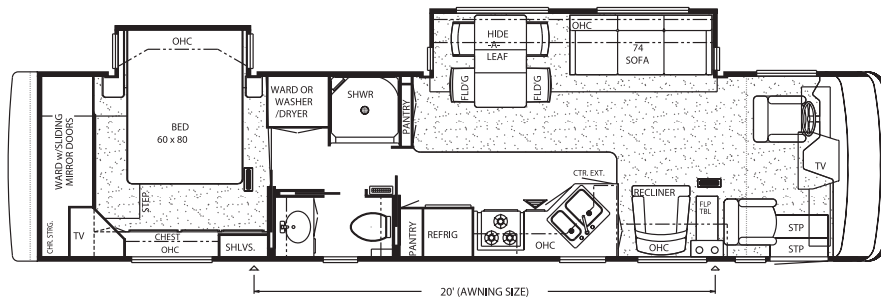

Model Shown: KSDP3905

Floor Plan Options: K125, K273

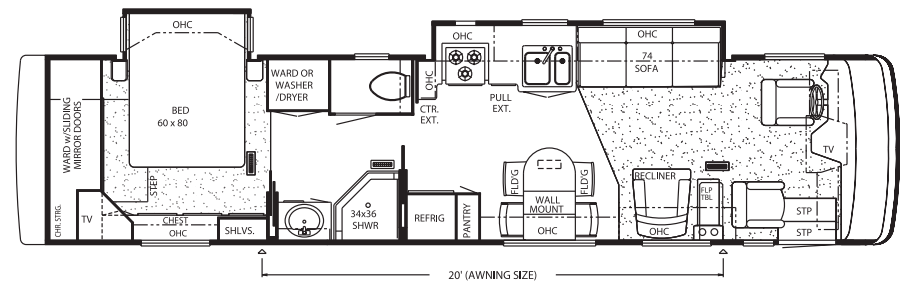

Model Shown: KSDP3906

Floor Plan Options: K125-2, K140, K276

FLOOR PLAN OPTIONS

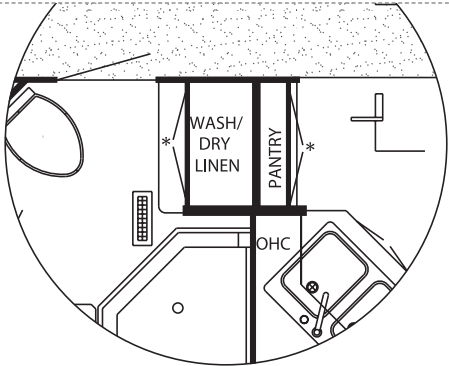

J780: WASHER/DRYER PREP IN LIEU OF CHINA/LINEN KSCA: 3651

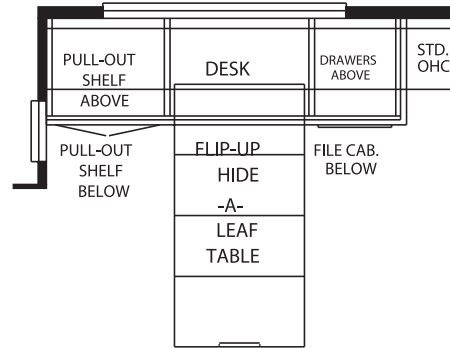

K125: COMBINATION DESK
KSCA: ALL KSDP: 3353, 3702, 3705, 3904, 3905

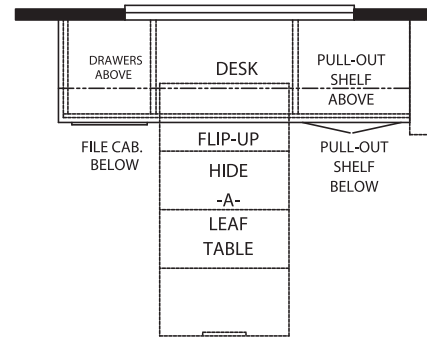

K125-2: COMBINATION DESK
KSDP: 3906

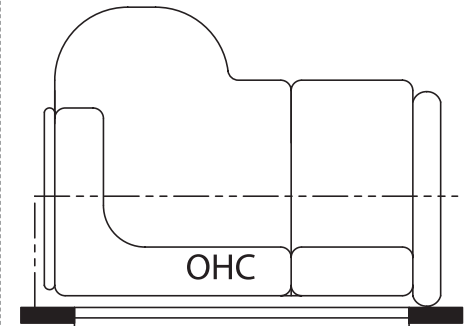

K140: 58" LEATHER L-SOFA
KSDP: 3906

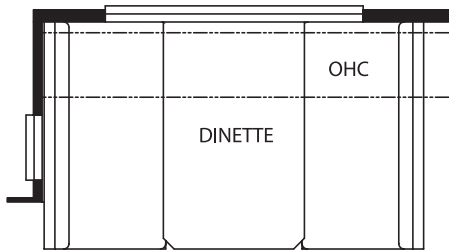

K273: BOOTH DINETTE
KSCA: ALL KSDP: 3353, 3702, 3705, 3904, 3905

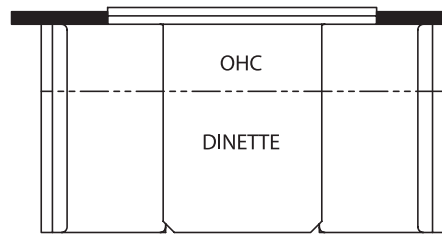

K276: BOOTH DINETTE WITH DRAWERS
KSDP: 3906

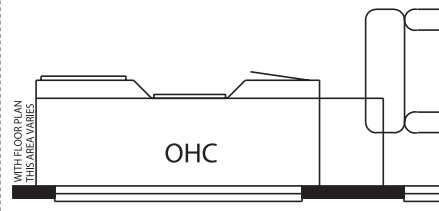

K326: 53" DESK
KSDP: 3352, 3906

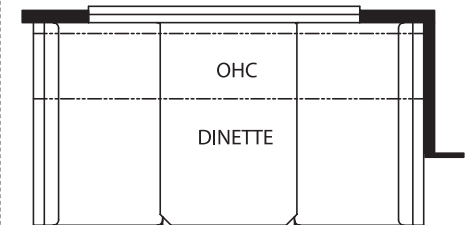

K410: BOOTH DINETTE
KSDP: 3352

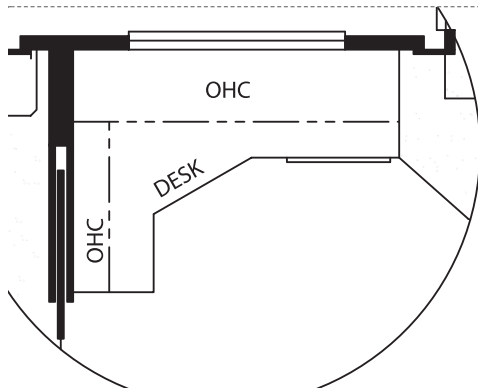

K860: DESK IN LIEU OF STOOL ROOM
KSCA: 3740

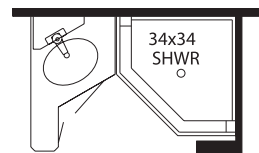

P090: UNENCLOSED BATHROOM
KSDP: 3702

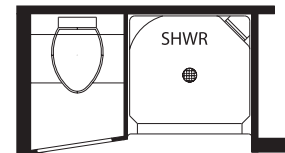

P300: ENCLOSED STOOL ROOM
KSCA: 3560



FLOOR PLAN SPECIFICATIONS

FLOOR PLAN	APP. OVERALL LENGTH	WIDTH	APP. OVERALL HEIGHT	INTERIOR WIDTH	INTERIOR HEIGHT	GREY	SEWAGE	WATER	LP	FURNACE	WATER HEATER
KSDP 3352	33' 11"	100"	12' 3"	94"	78"	65 gal.	45 gal.	105 gal.	32 gal.	35,000 Btu	10 gal.
KSDP 3353	33' 11"	100"	12' 3"	94"	78"	65 gal.	45 gal.	105 gal.	32 gal.	35,000 Btu	10 gal.
KSDP 3702	37' 5"	100"	12' 3"	94"	78"	65 gal.	45 gal.	105 gal.	32 gal.	42,000 Btu	10 gal.
KSDP 3705	37' 5"	100"	12' 3"	94"	78"	65 gal.	45 gal.	105 gal.	32 gal.	42,000 Btu	10 gal.
KSDP 3904	38' 7"	100"	12' 3"	94"	78"	65 gal.	45 gal.	105 gal.	32 gal.	42,000 Btu	10 gal.
KSDP 3905	38' 7"	100"	12' 3"	94"	78"	65 gal.	45 gal.	105 gal.	32 gal.	42,000 Btu	10 gal.
KSDP 3906	38' 7"	100"	12' 3"	94"	78"	65 gal.	45 gal.	105 gal.	32 gal.	42,000 Btu	10 gal.

KSCA 3301	33' 3"	100"	12'	94"	78"	50 gal.	50 gal.	75 gal.	25 gal.	35,000 Btu	10 gal.
KSCA 3560	35' 3"	100"	12'	94"	78"	50 gal.	50 gal.	75 gal.	25 gal.	35,000 Btu	10 gal.
KSCA 3651	36' 6"	100"	12'	94"	78"	50 gal.	50 gal.	75 gal.	25 gal.	42,000 Btu	10 gal.
KSCA 3740	37' 3"	100"	12'	94"	78"	50 gal.	50 gal.	75 gal.	25 gal.	42,000 Btu	10 gal.
KSCA 3778	37' 3"	100"	12'	94"	78"	50 gal.	50 gal.	75 gal.	25 gal.	42,000 Btu	10 gal.

CHASSIS SPECIFICATIONS

FREIGHTLINER CHASSIS INFORMATION

FLOOR PLAN	ENGINE HP	AXLE RATIO	FUEL CAP.	WHEEL BASE	*FRONT GAWR	*REAR GAWR	*GVWR	*GCWR	APP. UVW	APP. NCC
KSDP 3352	300	4.63	100 gal.	190"	10,500 lb.	17,500 lb.	28,000 lb.	38,000 lb.	21,356 lb.	6,644 lb.
KSDP 3353	300	4.63	100 gal.	190"	10,500 lb.	17,500 lb.	28,000 lb.	38,000 lb.	21,652 lb.	6,348 lb.
KSDP 3702	300	4.63	100 gal.	228"	12,000 lb.	17,500 lb.	29,500 lb.	39,500 lb.	23,054 lb.	6,446 lb.
KSDP 3705	300	4.63	100 gal.	228"	12,000 lb.	17,500 lb.	29,500 lb.	39,500 lb.	22,965 lb.	6,535 lb.
KSDP 3904	330	4.63	100 gal.	242"	12,000 lb.	17,500 lb.	29,500 lb.	39,500 lb.	24,129 lb.	5,371 lb.
KSDP 3905	330	4.63	100 gal.	242"	12,000 lb.	17,500 lb.	29,500 lb.	39,500 lb.	23,463 lb.	6,037 lb.
KSDP 3906	330	4.63	100 gal.	242"	12,000 lb.	17,500 lb.	29,500 lb.	39,500 lb.	23,473 lb.	6,027 lb.

WORKHORSE CHASSIS INFORMATION

FLOOR PLAN	ENGINE HP	AXLE RATIO	FUEL CAP.	WHEEL BASE	*FRONT GAWR	*REAR GAWR	*GVWR	*GCWR	APP. UVW	APP. NCC
KSCA 3301	340	5.38	75 gal.	208"	8,500 lb.	14,500 lb.	22,000 lb.	26,000 lb.	17,158 lb.	4,842 lb.
KSCA 3560	340	5.38	75 gal.	228"	8,500 lb.	14,500 lb.	22,000 lb.	26,000 lb.	17,683 lb.	4,317 lb.
KSCA 3651	340	5.38	75 gal.	242"	8,500 lb.	14,500 lb.	22,000 lb.	26,000 lb.	18,051 lb.	3,949 lb.
KSCA 3740	340	5.38	75 gal.	242"	8,500 lb.	14,500 lb.	22,000 lb.	26,000 lb.	18,370 lb.	3,630 lb.
KSCA 3778	340	5.38	75 gal.	242"	8,500 lb.	14,500 lb.	22,000 lb.	26,000 lb.	18,308 lb.	3,692 lb.

Lengths, Heights, Widths and Dry Weights are approximate. Weight will vary based on optional equipment added to the above base weight.

GAWR: Gross Axle Weight Rating is the maximum permissible weight for an axle.

GVWR: Gross Vehicle Weight Rating is the maximum permissible weight of a fully loaded motorhome.

GCWR: Gross Combination Weight Rating is the value specified by the manufacturer of the vehicle as the maximum allowable loaded weight of this motorhome and any towed trailer or towed vehicle.

UVW: Unloaded Vehicle Weight is the weight of this motorhome as built at the factory with full fuel, engine oil and coolants. The UVW does not include cargo, fresh water, LP gas or dealer-installed accessories.

NCC: Net Carrying Capacity is the maximum weight of all occupants, including the driver, personal belongings, food, fresh water, waste water, LP gas, tools, tongue weight of towed vehicle, dealer-installed accessories, etc., that can be carried by the motorhome.



A NEW BREED.™

www.workhorse.com



THE LEADER AT EVERY TURN

www.freightlinerchassis.com

Wonder where our next road will lead?

THE NEWMAR KOUNTRY KLUB

As a Newmar owner, you qualify for membership in the Newmar Kountry Klub. Join your local chapter, and just look at the perks you'll enjoy: friendship, fun and adventure with other Newmar owners • rallies and caravans • special RV show events • discounts on RV services • a free monthly Klub magazine • Klub merchandise. And that's just for starters.

Join today! Call 877-639-5582, toll-free, or visit the Klub section of newmarcorp.com.

THE NEWMAR FACTORY TOUR

We'd love to have you visit our state-of-the-art production facility in Nappanee, Indiana. For details, including tour days and times, please call 574-773-7791.

NEWMAR CORPORATION
355 N DELAWARE ST
PO BOX 30
NAPPANEE IN 46550-0030
574-773-7791 Fax 574-773-2895
www.newmarcorp.com

Official Newmar Dealer:



NEWMAR QUALITY: A WAY OF LIFE

Some features shown in our literature are optional. Colors and finishes are photographic representations: The actual materials may look different. Prices, specifications and floor plans are subject to change at Newmar's discretion without prior written notice or obligation. Please see your dealer for actual samples and specifications. © 2003 Newmar Corporation. Printed in the U.S.A. (05/03)