

# 2007 Cadillac Escalade/Escalade ESV and Escalade EXT Navigation System

---

<b>Overview</b> .....	3	<b>Voice Recognition</b> .....	89
Overview .....	4	Voice Recognition .....	90
<b>Features and Controls</b> .....	15	<b>Phone</b> .....	95
Features and Controls .....	16	Phone .....	96
<b>Navigation Audio System</b> .....	61	<b>Index</b> .....	97
Navigation Audio System .....	62		

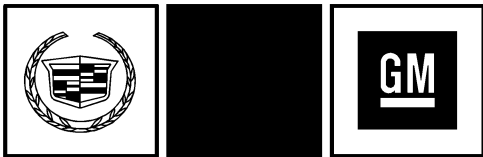

GENERAL MOTORS, GM, the GM Emblem, CADILLAC, the CADILLAC Crest & Wreath, the names Escalade, Escalade/ESV, and EXT are registered trademarks of General Motors Corporation.



Dolby® is manufactured under license from Dolby® Laboratories. Dolby® and the double-D symbol are trademarks of Dolby® Laboratories.

The information in this manual supplements the owner manual. This manual includes the latest information available at the time it was printed. We reserve the right to make changes in the product after that time without notice. For vehicles first sold in Canada, substitute the name General Motors of Canada Limited for Cadillac Motor Car Division whenever it appears in this manual.

Keep this manual with the owner manual in the vehicle, so it will be there if it is needed. If the vehicle is sold, leave this manual in the vehicle.

## Canadian Owners

For Canadian owners that would like to obtain a French language manual, see “Canadian Owners” in the Index of your vehicle’s owner manual.

Litho in U.S.A.  
Part No. 15810216 C Third Printing

©2007 General Motors Corporation. All Rights Reserved.

# Section 1 Overview

---







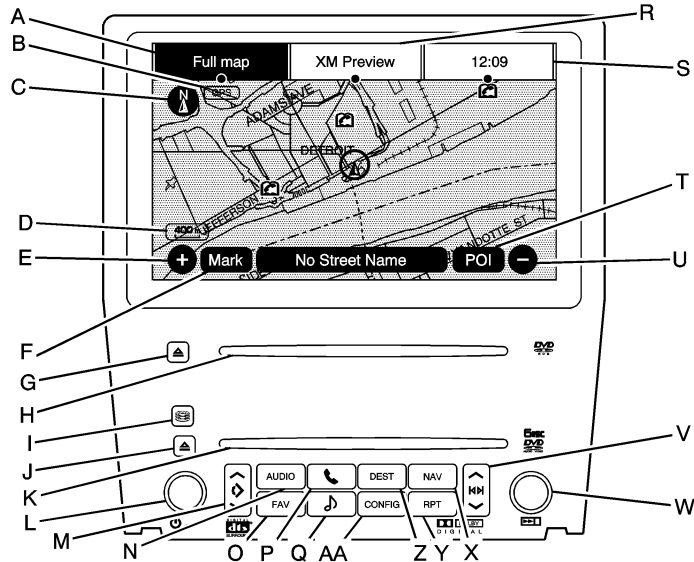

<b>Overview</b> .....	4	Getting Started .....	6
Navigation System Overview .....	4	Cleaning the Video Screen .....	14



# Overview

## Navigation System Overview



Screen shown with Map Disc Inserted

- A. FULL MAP Touch Screen Button. See “NAV” under “Hard Keys” under *Using the Navigation System on page 16* for more information.
- B. No GPS Symbol. See *Symbols on page 21* for more information.
- C. North Up/Heading Up Symbol. See *Symbols on page 21* for more information.
- D. Map Scale. See “Map Scales” under *Maps on page 18* for more information.
- E.  (Zoom In) Touch Screen Button. See “Map Scales” under *Maps on page 18* for more information.
- F. Mark Touch Screen Button. See “Adding Destinations to the Address Book” under *Destination on page 28* for more information.
- G.  (DVD Map Disc Eject) Key. See *Maps on page 18* for more information.
- H. Map DVD Slot. See “Installing the Map DVD” under *Maps on page 18* for information on how to install and eject a map DVD.
- I.  (Load) Key. See *CD Player on page 71* or *DVD Player on page 80* for more information.
- J.  (CD/DVD Video/Audio Eject) Key. See *CD Player on page 71* or *DVD Player on page 80* for more information.
- K. CD/DVD Video/Audio Slot. See *CD Player on page 71* or *DVD Player on page 80* for more information.
- L.  /  (Power/Volume) Knob. See *Navigation Audio System on page 62* for more information.
- M.  (Tilt) Key. See “Hard Keys” under *Using the Navigation System on page 16* for more information.
- N. AUDIO Key. See *Navigation Audio System on page 62* for more information.
- O. FAV (Favorite) Key. See “Storing Radio Station Presets” under *Navigation Audio System on page 62* for more information.
- P.  (Phone) Key. See *Phone on page 96* for more information.
- Q.  (Sound) Key. See “Sound Menu” under *Navigation Audio System on page 62* for more information.
- R. Source (AM, FM, XM, CD, etc.) Touch Screen Button. See *Navigation Audio System on page 62* for more information.

- S. Clock Touch Screen Button. See “Setting the Time” under *Configure Menu on page 44* for more information.
- T. POI (Point of Interest) Touch Screen Button. See “Displaying Points of Interest (POI) on the Map Screen” under *Symbols on page 21* for more information.
- U.  (Zoom Out) Touch Screen Button. See “Map Scales” under *Maps on page 18* for more information.
- V.  (Seek) Key (Previous/Next). See *Navigation Audio System on page 62* for more information.
- W.  (Tune) Knob. See *Navigation Audio System on page 62* for more information.
- X. NAV (Navigation) Key. See “Hard Keys” under *Using the Navigation System on page 16* for more information.
- Y. RPT (Repeat) Key. See “Hard Keys” under *Using the Navigation System on page 16* for more information.
- Z. DEST (Destination) Key. See *Destination on page 28* for more information.
- AA. CONFIG (Configure) Key. See *Configure Menu on page 44* for more information.

## Getting Started

Before you begin to operate the navigation system, read this manual thoroughly to become familiar with it and to understand how the system works.

Any route suggestions made by this navigation system may never override local traffic regulations, your own judgement, and/or knowledge of safe driving practices.

Disregard route suggestions made by the navigation system if such suggestions would; cause you to perform a hazardous or illegal maneuver, place you in a hazardous situation, or route you into an area you consider unsafe.

Keeping your mind on the drive is important for safe driving. See “Defensive Driving” in the Index of your vehicle’s owner manual for more information. Get familiar with your vehicle’s navigation system so you can use it with less effort and take full advantage of its features. Your navigation system includes not only navigation, but also audio functions. While your vehicle is parked:

- Familiarize yourself with all of its controls: hard keys on the faceplate and touch-sensitive screen buttons.
- Familiarize yourself with its operation.

- Set up your audio by presetting your favorite stations, setting the tone, and adjusting the speakers. Then, when driving conditions permit, you can tune to your favorite stations using the presets and steering wheel controls.
- Set up the navigation features that can only be done before you begin driving, such as entering an address or a preset destination.

Entering a destination or alphanumeric text requires many steps, so you can only perform these operations when the vehicle is in PARK (P). You will notice that touch-sensitive screen buttons leading to the alphanumeric keyboard are dimmed out while driving.

Other functions may also be locked out while driving and they too will appear grayed out on the screen — but all functions are available when parked. Some functions can be performed while driving, as long as you can do so without diverting too much of your attention from your driving.

 **CAUTION:**

**This system provides you with a far greater access to audio stations and song listings. Giving extended attention to entertainment tasks while driving can cause a crash and you or others can be injured or killed. Always keep your eyes on the road and your mind on the drive — avoid engaging in extended searching while driving.**

## CAUTION:

**Looking at the moving map on the navigation screen frequently or for too long while driving can cause a crash and you or others can be injured or killed. Keep your eyes and mind on the road and avoid looking too long or too often at the moving map on the navigation screen. Use the voice guidance directions whenever possible.**

The navigation system allows you to do the following:

- Plan a route with provided turn-by-turn route and map guidance with voice prompts.
- Select a destination using various methods and choices.
- Receive Radio Data System (RDS) broadcast announcements.

The information in the system may not always be complete. Road conditions, such as prohibited turns, detours, and construction zones, change frequently. It is important to consider whether you can follow the directions given by the system for the current conditions.

### CAUTION

Remember, if you are distracted while driving, you could cause a crash and you or others could be injured or killed.

Before using this system while driving, read the owner's manual and learn how the system operates.

Always concentrate on your driving first by keeping your eyes and mind on the road, and your hands on the wheel.

Some function of this system will not operate when the car is moving. See owner's manual for more information.

OK

Every fifty times the vehicle is started and the navigation system is turned on, the Caution screen will appear. If the Caution screen appears, touch OK to load the map DVD information. If OK is not selected, all hard keys except for NAV (Navigation) and DEST (Destination) can be accessed. Once the NAV or DEST hard keys are pressed, this Caution screen will appear and OK must be pressed to load the map DVD information from the map disc.



When getting started you may set the navigation system to your preference or delete information you may have entered using various options. To do so, reference the following topics.

## Language — English/Metric

To change the language of the navigation screens, see “Driver Information Center, DIC Vehicle Customization” in the Index of your vehicles owner manual.



To change the navigation screens from English or metric, see “Driver Information Center, DIC Operation and Displays” in the Index of your vehicles owner manual.

## Deleting Personal Information

This navigation system can record and store personal information such as names and addresses. At times, such as when you are disposing of your vehicle, you may want to delete this information. See “Edit Address Book — Edit/View” under *Configure Menu on page 44* for deleting information from the address book.

## Storing Radio Station Presets

To set preset radio stations, do the following:

1. Press the  (power) knob to turn the system on.
2. Press the AUDIO hard key and select the desired band (AM, FM1, FM2, XM1, or XM2 (if equipped)).
3. Use the  (tuning) knob or the SEEK arrows to tune to the desired station.
4. Press and hold one of the five preset screen buttons, at the bottom of the screen, until you hear a beep or see the station displayed on the selected preset button.
5. Repeat the steps for each preset.

See “Storing Radio Station Presets” under *Navigation Audio System on page 62* for more information.

## Setting the Time

The navigation system time and the analog clock are separate features. Changing the time through the navigation system will not change the time on the analog clock and vice versa. See “Analog Clock” in the Index of your vehicle’s owner manual to change the analog clock time.

To set the time for the navigation system, do the following:

1. Press the CONFIG key to enter the configure menu options, then press the CONFIG key repeatedly until the time is selected or touch the time screen button.
2. Press the Hours and Minutes – (minus) and + (plus) signs to decrease or to increase the time.



See “Setting the Time” under *Configure Menu on page 44* for more information.

## Entering an Address and Point of Interest, and Storing Preset

### Destinations

#### Entering an Address

To enter a destination by inputting the city name first, do the following:

1. If the radio is already on with a map disc inserted, skip to Step 5.
2. Press the  (power) knob to turn the system on.
3. Insert the DVD map disc. See “Installing the Map DVD” under *Maps on page 18* for more information.
4. A caution may appear. Touch the OK screen button to proceed.
5. Press the DEST hard key.
6. Press the  Address Entry screen button.

7. Select the state/province screen button, if needed, to change the current state or province. A list of all of the available states and provinces will appear. Select the state or province.

8. Once a state or province has been selected the City name category will automatically be selected for entry.

If five or less names are available, a list will display. If more than five are available, the List screen button will have a number in it, it represents the number of available cities. Select this button to view the list and select a city.

9. Once a city has been selected the Street name category will automatically be selected for entry.

If five or less streets are available for the selected city, the system will display the list of streets. If more than five streets are available the system will display the alpha keyboard.

Start entering the street name. If five or less names are available, a list will display. If more than five are available, the List screen button will have a number in it, it represents the number of available streets. Select this button to view the list and select a street.

10. Once a street has been selected, select the House # screen button to enter the house number. The system will display the house number range that is available for the street.

11. Select the Go screen button. A map screen, with the destination marked, will appear.



12. Select the route preference (Fastest, Shortest, or Other). The system will calculate and highlight the route.

13. Select the Start Guidance screen button. You are now ready to start your route.

See "Address Entry " under *Destination on page 28* for more information.

## Entering a Point of Interest (POI)

To set a destination by entering a Point of Interest (POI), do the following:

1. If the radio is already on with a map disc inserted, skip to Step 5.
2. Press the  (power) knob to turn the system on.
3. Insert the DVD map disc. See “Installing the Map DVD” under *Maps on page 18* for more information.
4. A caution may appear. Touch the OK screen button to proceed.
5. Press the DEST hard key.
6. Press the  Point of Interest screen button.
7. Select the state/province screen button, if needed, to change the current state or province. A list of all of the available states and provinces will appear. Select the state or province.
8. Enter the specific title of the POI in the POI name space (e.g. Washington Monument).  
If five or less names are available, a list will display. If more than five are available, the List screen button will have a number in it, it represents the number of available POIs. Select this button to view the list.
9. Select the Go screen button next to the POI. A map screen, with the destination marked, will appear.
10. Select the route preference (Fastest, Shortest, or Other). The system will calculate and highlight the route.
11. Select the Start Guidance screen button. You are now ready to start your route.

See “Point of Interest (POI)” under *Destination on page 28* for more information.

## Storing Preset Destinations

1. If the radio is already on with a map disc inserted, skip to Step 5.
2. Press the  (power) knob to turn the system on.
3. Insert the DVD map disc. See “Installing the Map DVD” under *Maps on page 18* for more information.
4. A caution may appear. Touch the OK screen button to proceed.
5. Press the DEST hard key.  
Enter a destination. See *Destination on page 28* for more information on how to enter a destination.
6. Press the DEST hard key, the Route screen will display. Press the Final Destination or Stopover screen button. The information screen will display for that location. Press the Add to Address Book screen button. The address book screen will appear.
7. Select the Name screen button. An alpha-keyboard will display. Enter the name. Select the Back screen button.

8. Press and hold one of the screen buttons at the bottom of the screen until the name appears in the screen button on the display. The name will appear in that preset destination screen button and is now available to select from the Destination Entry screen. See “Using Your Stored Preset Destinations” next in this section to select it as a destination. See “Adding or Changing Preset Destinations” under *Destination on page 28* for more information on how to add preset destinations.

## Using Your Stored Preset Destinations

These destinations are available for selection while driving.

1. If the radio is already on with a map disc inserted, skip to Step 5.
2. Press the  (power) knob to turn the system on.
3. Insert the DVD map disc. See “Installing the Map DVD” under *Maps on page 18* for more information.
4. A caution may appear. Touch the OK screen button to proceed.

5. Press the DEST hard key.
6. Select one of the available preset destination screen buttons. A map screen, with the destination marked, will appear.
7. Select the route preference (Fastest, Shortest, or Other). The system will calculate and highlight the route.
8. Select the Start Guidance screen button.  
You are now ready to start your route.

See “Preset Destination” under *Destination on page 28* for more information.

## Canceling Guidance

Guidance will be canceled once you arrive at your final destination. To cancel guidance prior to arrival at the final destination, do the following:

1. Press the DEST hard key.
2. Press the Cancel Guidance screen button.
3. Press OK to confirm.

## Guidance Volume

To adjust the volume of voice guidance prompts, do the following:

1. Press the CONFIG hard key to enter the menu options, then press the CONFIG key repeatedly until Nav is selected or touch the Nav screen button.
2. Press the Voice Prompt screen button.
3. Press the + (plus) or – (minus) screen buttons to increase or to decrease the volume of the voice prompts. The system will respond with the adjusted voice level.

See “Voice Prompt ” under *Configure Menu on page 44* for more information.

## Cleaning the Video Screen

When cleaning the video screen, use only a soft clean cotton cloth dampened with clean water.

## Section 2 Features and Controls

---

<b>Features and Controls</b> .....	16	Global Positioning System (GPS) .....	56
Using the Navigation System .....	16	Vehicle Positioning .....	57
Maps .....	18	Problems with Route Guidance .....	58
Symbols .....	21	If the System Needs Service .....	59
Destination .....	28	Ordering Map DVDs .....	59
Configure Menu .....	44	Database Coverage Explanations .....	59
Rear Vision Camera .....	51		

# Features and Controls

## Using the Navigation System

This section presents basic information needed to operate the navigation system.

Use the hard keys located on the navigation system along with the available touch-sensitive screen buttons on the navigation screen to operate the system. See *Navigation System Overview on page 4* for more information.

Once the vehicle is moving, various functions will be disabled to reduce driver distractions.

### Hard Keys

The following hard keys are located on the navigation system:

 **(Power/Volume):** Press this knob to turn the system on and off. Turn the knob to increase or decrease the volume to the audio system.

Press and hold this knob for more than two seconds to turn off the navigation system, the Rear Seat Entertainment (RSE), and Rear Seat Audio (RSA). If the vehicle has not been tuned off, the RSE and the RSA can be turned back on by pressing this knob and will continue play of the last active source.

 **(Tune):** Turn the tune knob to go to the next or previous radio station or disc track or chapter. See *Navigation Audio System on page 62*, *CD Player on page 71*, or *DVD Player on page 80* for more information.

 **(DVD Map Disc Eject):** Press the eject button, located next to the upper disc slot, to eject the DVD map disc. See *Maps on page 18* for more information.

 **(Load):** Press the load button to load CDs or audio/video DVDs. See *CD Player on page 71* or *DVD Player on page 80* for more information.

 **(CD/DVD Eject):** Press the eject button, located under the load button, to eject CDs or audio/video DVDs. See *CD Player on page 71* or *DVD Player on page 80* for more information.



◇ **(Tilt):** Press this key up or down to tilt the screen.

**AUDIO:** Press this key to access the full Audio screen to change AM, FM, XM™ Satellite Radio Service (if equipped), CD/DVD, and auxiliary input. See “Audio” under *Navigation Audio System on page 62* for more information.

**FAV (Favorite):** Press this key to access the preset stations. See “Storing Radio Station Presets” under *Navigation Audio System on page 62* for more information.

☎ **(Phone):** Press this key to access calling through OnStar®. See *Phone on page 96* for more information. See “OnStar® System” in the Index of your vehicle’s owner manual for more information.

🎵 **(Sound):** Press this key to access the Sound screen to adjust bass, midrange, treble, and Digital Signal Processing (DSP). See “Sound Menu” under *Navigation Audio System on page 62* for more information.

**DEST (Destination):** Press this key to access the Destination Entry screen to plan a destination. See *Destination on page 28* for more information.

**CONFIG (Configure Menu):** Press this key to adjust features for sound, radio, navigation, and the display. See *Configure Menu on page 44* for more information.

**NAV (Navigation):** Press this key to view your vehicle’s current position on the map screen. Each press of this key will cycle through Full Map and the tab that displays the current audio source (AM, FM, CD, etc.). Full Map displays the screen in full map view. Selecting the audio tab will split the screen between the map screen and the current audio source screen menu. See “Audio” under *Navigation Audio System on page 62* for more information.

**RPT (Navigation Repeat):** Press this key to repeat the last voice guidance prompt.

⏪ ⏩ √ **(Seek):** Press the seek arrows to seek and scan radio stations, to seek tracks on a CD, and to seek chapters on a DVD. See *Navigation Audio System on page 62*, *CD Player on page 71*, or *DVD Player on page 80* for more information.

## Touch-Sensitive Screen Buttons

Touch-sensitive screen buttons are located on the screen. When a screen button has been selected, a beep will sound. Screen buttons are highlighted when a feature is available.

### Alpha-Numeric Keyboard

Letters of the alphabet, symbols, punctuation, and numbers, when available, will display on the navigation screen as an alpha or numeric keyboard. The alpha keyboard will display when the system requires entry of a city or street name.

All characters are touch-sensitive screen buttons. Touch a character to select it.

**A-Y (Accent Alphabet):** Select this screen button to select letters with accent symbols. This button may toggle to A-Z.

**A-Z (Alphabet):** Select this screen button to select letters from the alphabet. This button may toggle to A-Y.

**0-9 (Numbers):** Select this screen button to select numbers.

 **(Space):** Select the space screen button to enter a space between characters or the words of a name.

**Backspace:** Select this screen button if an incorrect character has been selected.

To make name selections easier, the system will only highlight the characters that can follow the last one entered. For example, if a Z is entered, a T may not be available for selection.

If a name is not display after entry, it may need to be entered differently or the map DVD disc may not contain that information. See *Database Coverage Explanations on page 59* for more information.

## Maps

This section includes basic information that you need to know about the map database.

The maps are stored on a DVD. The United States, Canada, and Puerto Rico are contained on one disc.

## Detailed Areas

Road network attributes are contained in the map database for detailed areas. Attributes include information such as street names, street address, turn restrictions, etc. A detailed area will include all major highways, service roads, and residential roads. The detailed areas include points of interest (POI) such as: restaurants, airports, banks, hospitals, police stations, gas stations, tourist attractions, historical monuments, etc. The map database may not include data for newly constructed areas or map database corrections that are completed after the production of the disc. The navigation system will provide full route guidance in the detailed map areas.

## Limited Guidance Areas

Any area that is not classified as detailed is a limited guidance area. Limited guidance streets will be displayed on the map display but route guidance may not be given on these streets. Some POI categories, such as the city center POI category, and some street addresses are included in the limited guidance areas.

The navigation system will inform you by voice prompts when you are traveling into a limited guidance area where route guidance will not be available. The street maps and the directional arrow displayed on the navigation system can then be used to determine the remaining route to your destination.

## Installing the DVD Map Disc

Your dealer/retailer may have installed the map DVD. If the map DVD was not installed, do the following to load it:

1. Turn the ignition on.
2. Press the  (power) knob to turn the navigation system on.
3. Load the map DVD partway into the slot located just below the screen. The system will pull it in.
4. If the Caution screen appears, touch the OK screen button to agree.

## DVD Map Disc Messages

If Disc Read Error appears on the display and/or the map disc comes out, it could be for one of the following reasons:

- If the map disc was installed into the CD slot. See “Installing the DVD Map Disc” previously.
- It is very hot, when the temperature returns to normal, the map disc should play.
- You are driving on a very rough road. When the road becomes smoother, the map disc should play.
- The map disc is dirty, scratched, wet, or upside down.

If any error occurs repeatedly or if an error cannot be corrected, contact your dealer/retailer.

## Ejecting the DVD Map Disc

 **(DVD Map Disc Eject):** Press the eject button, located next to the upper disc slot, to eject the DVD map disc.

## Map Adjustments

The system allows you to adjust the scale of view on the map. Also, as you drive, the map will scroll automatically based on the direction of travel.

## Map Scales

**+ / – (Zoom In/Zoom Out):** Touch the zoom in or out screen buttons or the scale on the bar to change the level of map detail. The scale will appear on the screen once the zoom in or zoom out screen buttons are selected. The system will adjust the map accordingly. The scale of a map can range from 1/32 mi. (50 m) to 256 mi. (400 k). To change English or metric, see “Driver Information Center, DIC Operation and Displays” in the Index of your vehicle’s owner manual.

## Scrolling the Map

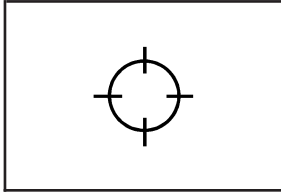

Touch anywhere on the map screen and the scroll symbol will appear. Use this feature to scroll across the map.

Move your finger in any direction on the map screen and the map will continue to scroll in that direction until you remove your finger.

If scrolling while your vehicle is in PARK (P), the system will scroll initially at a slower rate. It will increase if you continue touching the map screen.

If scrolling while your vehicle is in motion, you have one scroll speed and a limited distance to scroll. You have to keep touching the map screen to scroll for a longer distance.

If you have used the scroll feature to scroll the map and your vehicle icon becomes lost, press the NAV (Navigation) key to return to the current vehicle location on the map.

You can use the scroll feature on the map to set a destination. See “From Map” under *Destination on page 28* for more information.

When scrolling on the map without a planned route, press the GO screen button to calculate the route from your current position to the destination mark.

## Symbols

The following symbols are the most common symbols that will appear on a map screen.

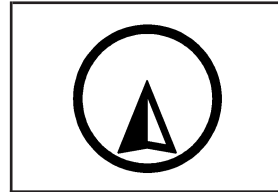

Your vehicle is shown as this symbol. It indicates the current position and the direction your vehicle is traveling on the map.

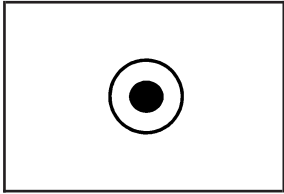

The destination symbol will appear on the map, after a route has been planned, marking the final destination.

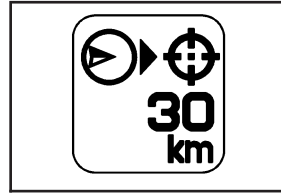

The distance to destination symbol indicates the distance to the final destination.

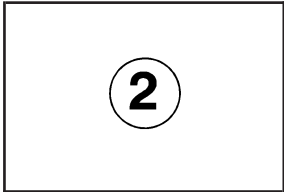

The stopover symbol will display on the map after a stopover has been added to the route.

This symbol only appears when the time to the destination is not available or while you are scrolling on the map.



The distance and time to destination symbol indicates the distance and the estimated time remaining to your final destination, depending on the option selected.

The stopover symbols are numbered one through three, depending on how many stopovers have been set.

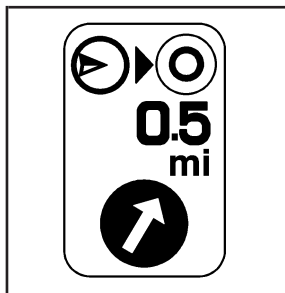

The straight line to distance symbol indicates the straight-line distance to your destination.

This symbol will appear before you start driving on the route or if you are on a road where navigation guidance cannot be given.

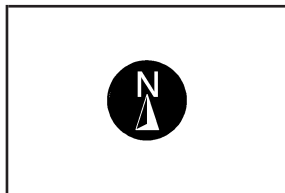

The north up symbol indicates the map with North Up, known as North Up mode.

While in North Up mode, the vehicle icon will follow the north direction on the map regardless of which direction the vehicle is traveling. Select this screen symbol to switch between North Up, Heading Up, and 3-D view modes.

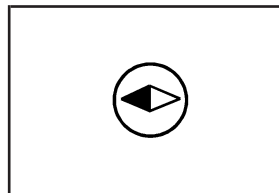

The heading up symbol indicates that the vehicle is traveling up on the map and is known as Heading Up mode.

The shaded triangle indicates the North direction. While in Heading Up mode the direction at the top of the screen and the way the vehicle icon is heading indicates the direction your vehicle is traveling. Select this screen symbol to switch between Heading Up, North Up, and 3-D view modes.

Three-dimensional (3-D) view mode will change the appearance of the map display to a road level view.



The No GPS symbol will appear when your vehicle is acquiring or not receiving a Global Positioning System (GPS) satellite signal.

See *Global Positioning System (GPS)* on page 56 for more information.



Select the Mark screen button to store the location on the screen in your address book.

The system will automatically store the point in the address book. See “Adding Destinations to the Address Book” under *Destination* on page 28 for more information.

## Displaying Points of Interest (POI) on the Map Screen

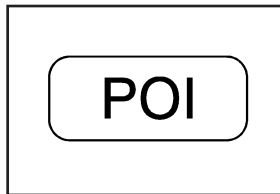

Select the POI screen button to display or delete POI icons from the map.

Displaying POI icons on the map lets you know where POIs (e.g. restaurants, gas stations, etc.) are located. This screen will appear after selecting the POI screen button.



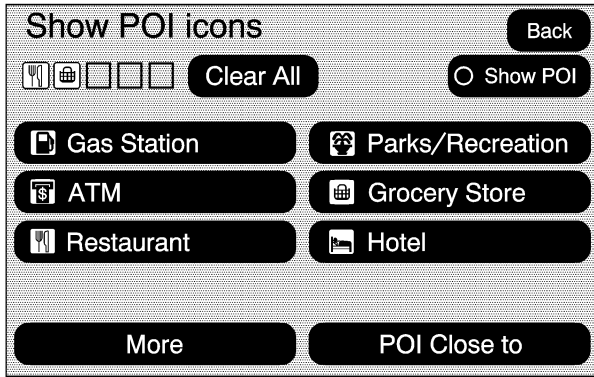

Select one of the POI categories to display or to delete POI icons from the map screen. Once a category has been selected the POI icon will display at the top of the screen. Five categories can be selected to display on the map screen. When a category is selected those POI icons will display on the map. Press the POI screen button again to add more POI icons.

**More:** Select this screen button to view more POI categories.

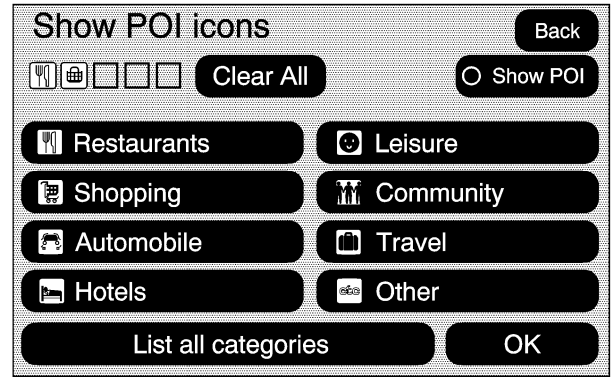

**POI Close to:** Once a category has been selected, select this screen button to display the list of available POIs for the selected POI categories. The list provides the POI icon, the name, the direction, and the distance to the POI from your vehicle's current position. Use the scroll arrows to move up and down the list. Use the sorting screen buttons: Dist (distance), Icon, Name, and on Route as desired.

**Go:** Select this screen button, next to the desired POI, to make this POI a destination or a stopover.

Select a POI name to receive information about the POI. From this screen you can select: Address Book, Go, or Map.

**Address Book:** Press this screen button to add this POI to the address book. See “Nav” under *Configure Menu on page 44* for information on editing address book entries.

**Go:** Select this screen button to make this POI a destination or a stopover.

**Map:** Select this screen button to display the map showing the location of the POI.

**OK:** Select this screen button to display the map screen.

**Show POI:** Select this screen button to display or remove the POI icons from the map screen.

**List all Categories:** Select this screen button to list all POIs sorted alphabetically.

**Delete:** To delete a specific POI category, select the category.

**Clear All:** Select this screen button to clear all selected POI categories.

## Driving on a Route

When a destination has been routed and you are driving on route, the map screen will automatically display the next maneuver.



The pop-up will display the next maneuver direction and how many miles or kilometers you are from it.

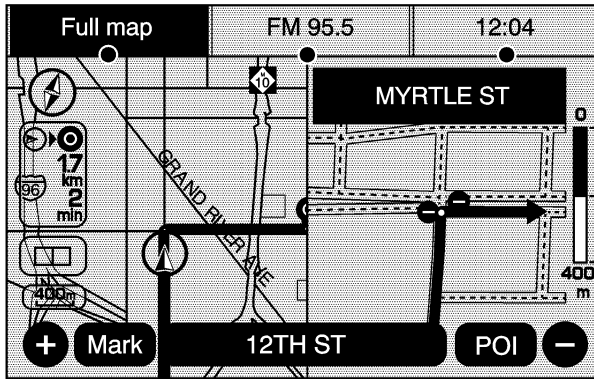

When you are approximately 1/4 mi (400 m) from the next maneuver, the screen will display the name and a detailed view of the next maneuver.

### 3-D Lane Guidance

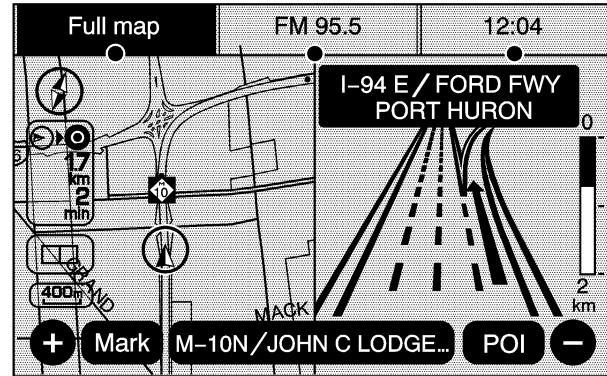

Some major metropolitan areas may include a 3-D lane guidance feature for highway exits and junctions. This feature gives you a more vivid representation of the exits and junctions on your route. Cities that include this feature are New York, Los Angeles, Chicago, Detroit, and San Francisco, and may also include Philadelphia, Washington D.C., and other major highway junctions.

## Dual Mode

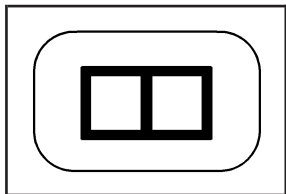

This dual screen symbol will display when the screen is in dual mode.

Dual mode displays the route on half of the screen and a maneuver or turn list on the other half. Press this button to switch between dual screen and full screen which displays the entire route.

## Auto Reroute

When your destination is set and you are off the planned route, the system will automatically plan a new route and begin to reroute. The new route will be highlighted on the screen.

## Destination

Press the DEST key to access the Destination Entry screen. From this screen, you can select from several options to plan a route by entering destination points.

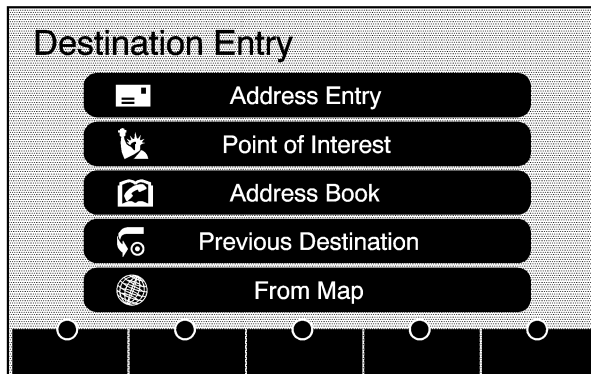

To enter a destination, choose from one of the following destination entry methods:

## Address Entry

 **Address Entry:** The address entry destination method allows you to enter an address by providing the system with a city name or a street name.

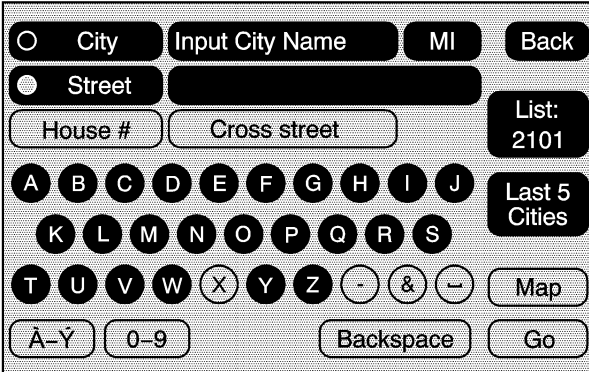

To enter a destination by inputting the city name first, do the following:

1. Press the DEST hard key.
2. Select the  Address Entry screen button.
3. Select the state/province screen button, if needed, to change the current state or province. A list of all of the available states and provinces will appear. Select the state or province.
4. Once a state or province has been selected the City name category will automatically be selected for entry.

Enter the City Name or touch the Last 5 Cities screen button.

The Last 5 Cities screen will display a list of the last five city names that had been entered. Select a city from the list and it will appear in the City name area.

If using the alpha keyboard, finish entering the city name. If five or less names are available, a list will display. If more than five are available, the List screen button will have a number in it, it represents the number of available cities. Select this button to view the list and select a city.

5. Once a city has been selected the Street name category will automatically be selected for entry.  
Start entering the street name. If five or less names are available, a list will display. If more than five are available, the List screen button will have a number in it, it represents the number of available streets. Select this button to view the list.
6. Once a street has been selected, press the House # screen button to enter the house number. The system will display the house number range that is available for the street.
7. Select the Go screen button. The map screen, with the destination marked, will display.
8. Select the route preference (Fastest, Shortest, or Other). The system will calculate and highlight the route.
9. Select the Start Guidance screen button. You are now ready to start your route.  
See “Getting Started on Your Route” later in this section for more information.

To enter a destination by entering the street name first, do the following:

1. Press the DEST hard key.
2. Select the  Address Entry screen button.
3. Select the state/province screen button, if needed, to change the current state or province. A list of all of the available states and provinces will appear. Select the state or province.
4. Select the Street screen button and start entering the street name or touch the Last 5 Streets screen button.

If the street name is common, the system may need input of the city name first.

The Last 5 Streets screen will display a list of the last five street names that had been entered. Select a street from the list and it will appear in the Street name area.

If using the alpha keyboard, finish entering the street name. If five or less names are available, a list will display. If more than five are available, the List screen button will have a number in it, it represents the number of available streets. Select this button to view the list and select a street.

5. Once a street has been selected, select the House # screen button to enter the house number. The system will display the house number range that is available for the street.
6. Once the house number is selected, the city name will automatically populate. If there is more than one city available for selection, a list of cities will display. Select the city.
7. Select the Go screen button. The map screen, with the destination marked, will display.
8. Select the route preference (Fastest, Shortest, or Other). The system will calculate and highlight the route.
9. Select the Start Guidance screen button. You are now ready to start your route.  
See “Getting Started on Your Route” later in this section for more information.

To enter a destination by entering a cross street, do the following:

1. Press the DEST hard key.
2. Select the  Address Entry screen button.

3. Select the state/province screen button, if needed, to change the current state or province. A list of all of the available states and provinces will appear. Select the state or province.
4. Select the Street screen button and start entering the street name or touch the Last 5 Streets screen button.

If the street name is common, the system may need input of the city name first.

The Last 5 Streets screen will display a list of the last five street names that had been entered. Select a street from the list and it will appear in the Street name area.

If using the alpha keyboard, finish entering the street name. If five or less names are available, a list will display. If more than five are available, the List screen button will have a number in it, it represents the number of available streets. Select this button to view the list and select a street.

5. Once a street has been selected, select the Cross Street screen button and start entering the cross street name. If five or less names are available, a list will display. If more than five are available, the List screen button will have a number in it, it represents the number of available streets. Select this button to view the list and select a street.
6. Select the Go screen button. The map screen, with the destination marked, will display.
7. Select the route preference (Fastest, Shortest, or Other). The system will calculate and highlight the route.
8. Select the Start Guidance screen button. You are now ready to start your route. See "Getting Started on Your Route" later in this section for more information.

## Point of Interest (POI)

The Point of Interest (POI) destination entry method allows you to select a destination from the POI list.

**Point of Interest:** Touch this screen button to access the POI (Point of Interest) screen. From this screen you have two options to select/enter a destination; enter the name using the alpha keyboard or select a category from the category list.



To use the point of interest destination entry method by inputting the name, do the following:

1. Press the DEST hard key.
2. Select the  Point of Interest screen button.
3. Select the state/province screen button, if needed, to change the current state or province. A list of all of the available states and provinces will appear. Select the state or province.
4. Enter the POI name.  
If five or less names are available, a list will display. If more than five are available, the List screen button will have a number in it, it represents the number of available POIs. Select this button to view the list.
5. Select the Go screen button next to the POI. The map screen, with the destination marked, will display.
6. Select the route preference (Fastest, Shortest, or Other). The system will calculate and highlight the route.
7. Select the Start Guidance screen button. You are now ready to start your route.  
See “Getting Started on Your Route” later in this section for more information.

To use the point of interest destination entry method by selecting a category, do the following:

1. Press the DEST hard key.
2. Select the  Point of Interest screen button.
3. Select the Browse POI Categories screen button to view the list of POI categories.
4. Select a category.  
The system will display available POI names in the selected category.
5. Select the Go screen button next to the POI. The map screen, with the destination marked, will display.
6. Select the route preference (Fastest, Shortest, or Other). The system will calculate and highlight the route.
7. Select the Start Guidance screen button. You are now ready to start your route.  
See “Getting Started on Your Route” later in this section for more information.

## Address Book

The address book entry method allows you to select a destination by selecting an address that has been stored in your address book.

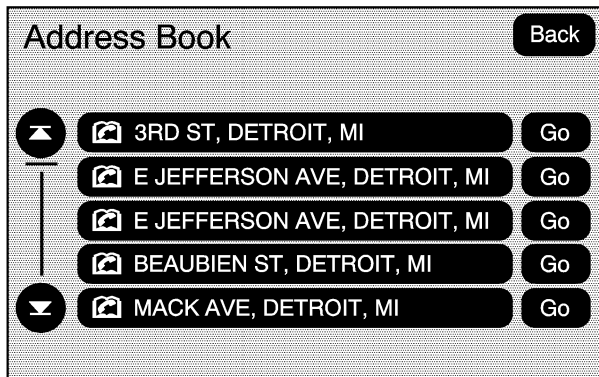

 **Address Book:** Touch this screen button to access the Address Book screen. From this screen you can select an address that already exists as the destination.

To use the address book entry method, do the following:

1. Press the DEST hard key.
2. Select the  Address Book screen button.  
A list of your address book addresses will display.
3. Select the Go screen button next to the destination. The map screen, with the destination marked, will display.
4. Select the route preference (Fastest, Shortest, or Other). The system will calculate and highlight the route.
5. Select the Start Guidance screen button. You are now ready to start your route.

See “Getting Started on Your Route” later in this section for more information.

See “Adding Destinations to the Address Book” later in this section.

## Previous Destination

The previous destination entry method allows you to select a destination from a list of previous destination points.



**Previous Destination:** Touch this screen button to access the Previous Destination screen. The system will store up to 100 points that have been previously entered. As new destinations are entered, the system will automatically delete the oldest destinations and add the new destinations.

To use the previous destination entry method, do the following:

1. Press the DEST hard key.
2. Select the  Previous Destination screen button.
3. Select a previous destination from the list. Use the arrow to the right of the destination to view the entire destination name as necessary. Use the scroll arrows to the left to scroll through the list.
4. Select the Go screen button next to the destination. The map screen, with the destination marked, will display.
5. Select the route preference (Fastest, Shortest, or Other). The system will calculate and highlight the route.
6. Select the Start Guidance screen button. You are now ready to start your route. See “Getting Started on Your Route” later in this section for more information.



## From Map

This destination entry method allows you to select a destination by scrolling on the map.



 **From Map:** Touch this screen button to enter the from map destination entry method.

To use this destination entry method, do the following:

1. Press the DEST hard key.
2. Select the  From Map screen button. A map screen will display with the scrolling symbol.
3. Use the  /  (zoom in/out) screen buttons and touch on the map to find the area that you would like to select as your destination. Pressing/holding and dragging your finger on the map will activate fast scrolling.
4. Press/touch once on the area that you would like to set as your destination.

The map screen will display the address information.

5. Select the Go screen button. The map screen, with the destination marked, will display.
6. Select the route preference (Fastest, Shortest, or Other). The system will calculate and highlight the route.
7. Select the Start Guidance screen button. You are now ready to start your route.

See “Getting Started on Your Route” later in this section for more information.

## Map Coordinates

The coordinates destination entry method allows you to select a destination by entering latitude and longitude coordinates.

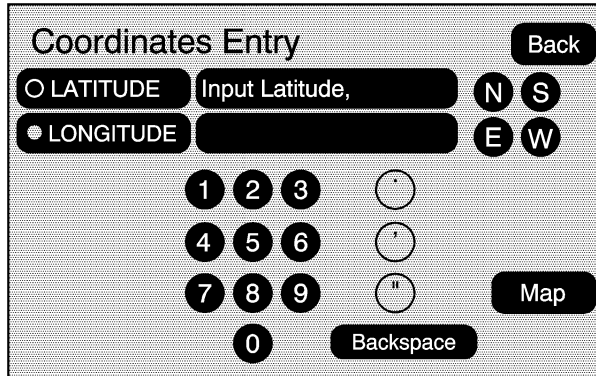

**Map Coordinates:** Touch this screen button to access the Coordinates Entry screen.

To use the coordinates destination entry method, do the following:

1. Press the DEST hard key.
2. Select the From Map screen button.
3. Select the Map Coordinates screen button.
4. Select Latitude and select either N (north) or S (south) to enter the direction of the latitude coordinate. Enter the numeric portion of the latitude coordinate.
5. Select Longitude and select either E (east) or W (west) next to enter the direction of the longitude coordinate. Enter the numeric portion of the longitude coordinate.
6. Once both coordinates are entered, select the Go screen button. The map screen, with the destination marked, will display.
7. Select the route preference (Fastest, Shortest, or Other). The system will calculate and highlight the route.
8. Select the Start Guidance screen button. You are now ready to start your route.  
See "Getting Started on Your Route" later in this section for more information.

## Preset Destination

The preset destination entry method allows you to set a destination by selecting from one of five previously stored destinations. Besides voice tagged destinations, these are the only destinations available to set while the vehicle is moving. If a destination is not set for one of the screen buttons, the button will be dimmed and not be available for use. See “Adding or Changing Preset Destinations” later in this section for information on how to add a preset destination.

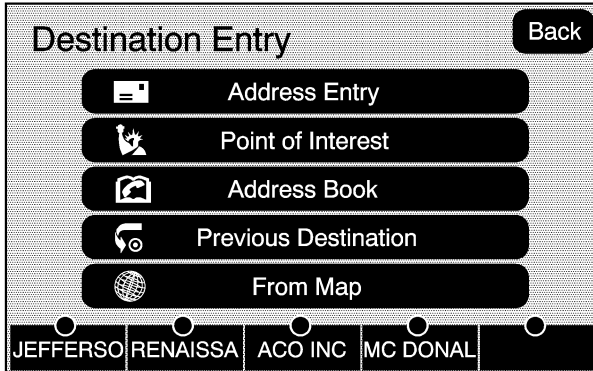

To use the preset destination entry method, do the following:

1. Press the DEST hard key.
2. Select the desired preset destination screen button. The screen buttons are labeled with the name that was selected for the destination when it was stored. The map screen, with the destination marked, will display.
3. Select the route preference (Fastest, Shortest, or Other). The system will calculate and highlight the route.
4. Select the Start Guidance screen button. You are now ready to start your route.

See “Getting Started on Your Route” later in this section for more information.

## Getting Started on Your Route

Once you have entered a destination there are several functions that can be performed. Press the DEST hard key to access the Route screen.

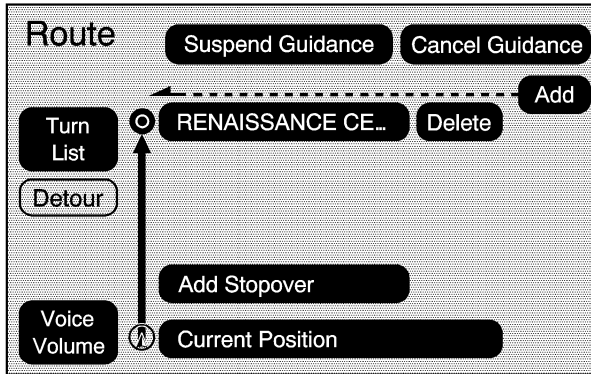

### Turn List

**Turn List:** Touch this screen button to view the list of turn maneuvers for the entire route and to avoid turns on the route.

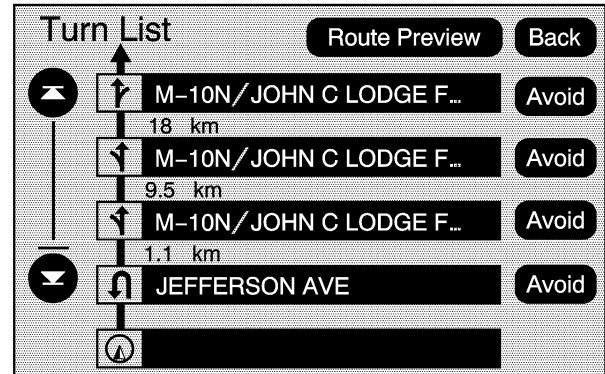

**▲ / ▼ (Scroll Arrows):** Touch the up and down arrow screen buttons to scroll through the list of maneuvers.

**Avoid:** Touch this screen button, next to the adjacent street name, to avoid the maneuver.

The map screen will display. The route will re-calculate without the selected avoided maneuver.

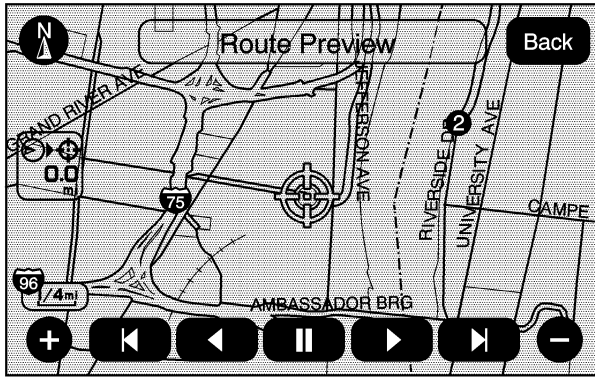

**Route Preview:** Select this screen button to preview the entire route in either direction.

◀ (Reverse Skip): Select this screen button to go back to the start point or previous stopover.

◀ / ◀◀ (Reverse Scroll): Select this screen button to scroll to the start point or previous stopover. The ◀ (reverse skip) button will change to a fast reverse screen button.

|| (Pause): Select this screen button to pause the route preview, while in reverse or fast forward scroll.

▶ / ▶▶ (Fast Forward Scroll): Select this screen button to scroll to the next stopover or to the final destination. The ▶ (fast forward skip) button will change to a fast speed fast forward.

▶ (Fast Forward Skip): Select this screen button to go to the next stopover or to the final destination.

### Detour

**Detour:** Select this screen button from the Route screen, then select to detour 1 mile, 3 miles, or 5 miles (1 km, 3 km, 5 km) around the current route. You may also select to detour the whole route if necessary. This option is only available while you are driving on your current planned route.

### Voice Volume

Select this screen button from the Route screen to turn voice guidance on or off and to change the volume of voice prompts. See “Nav” under *Configure Menu on page 44* for more information.



## Add Stopover

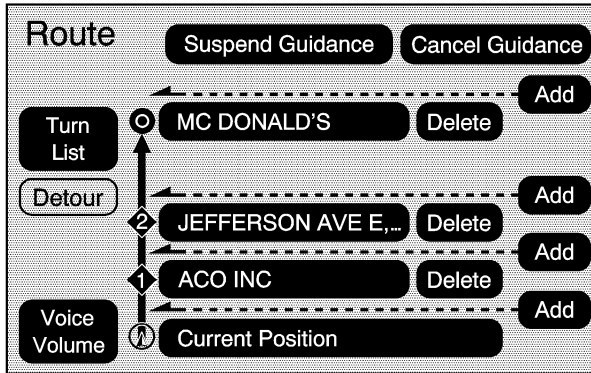

**Add Stopover:** Select this screen button from the Route screen. This feature allows you to add up to three stopovers to the current route, between your start point and final destination. Once a stopover has been added, the points can be edited or deleted.

To add a stopover:

1. Press the DEST hard key.
2. Select the Add Stopover screen button. This button will only appear if a route has been calculated.
3. Using the desired method of entering a destination, enter the stopover. See "Destination" previously for more information.
4. Select the route preference (Fastest, Shortest, or Other). The system will calculate and highlight the route.
5. Select the Start Guidance screen button. You are now ready to start your route.
6. To add the second and third stopovers, press the DEST hard key, then select the Add screen button, where you would like the next waypoint to fall on the route.
7. Select the route preference (Fastest, Shortest, or Other). The system will calculate and highlight the route.
8. Select the Start Guidance screen button. You are now ready to start your route.

To delete a stopover from your current route:

1. Press the DEST hard key.
2. Select the Delete screen button for the desired stopover to delete.
3. The system will display a pop-up confirmation message. Choose Yes to delete the stopover; touch No to cancel this operation.
4. Select the route preference (Fastest, Shortest, or Other). The system will calculate and highlight the route.
5. Select the Start Guidance screen button.  
You are now ready to start your route.

## **Suspend Guidance**

Press this screen button, from the Route screen, to put the current route on hold.

## **Resume Guidance**

Press this screen button, from the Route screen, to resume guidance on the current route.

## **Cancel Guidance**

Press this screen button, from the Route screen, to cancel the current route.

## **Adding Destinations to the Address Book**

There are two ways to add a destination to the address book:

- To add the current vehicle position to the address book, press the Mark screen button from the map screen. The system will automatically save the current vehicle information in the address book. When scrolling on the map the Mark screen button will automatically add the current scrolled position information in the address book.
- Press the Add to Address Book screen button when available on POI information screens, Destination Entry screens, or POI screens. The system will automatically save this information in the address book.

See “Nav” under *Configure Menu on page 44* for information on editing address book entries.

## Adding or Changing Preset Destinations

This feature allows you to add or change one of five preset destinations. When a destination has been added as a preset destination, it will be available to select from the Destination Entry screen. See “Preset Destination” previously for information on how to select a preset destination as a final destination.

To store the current vehicle position as a preset destination:

1. Select the Mark screen button from the map screen to add the current vehicle position to the address book. The Address Book screen will appear.
2. Select the Name screen button. An alpha-keyboard will display. Enter the name. Press the OK screen button then the Back screen button to return to the address book information screen.

3. Press and hold one of the buttons at the bottom of the screen until the name appears in that preset destination screen button. It is now available to select from the Destination Entry screen.

To store an address book entry as a preset destination:

1. Select the CONFIG hard key.
2. Select the Nav screen button or press the CONFIG key until Nav is selected or touch the Nav screen button.
3. Select the Edit/View screen button.
4. Select the address book entry that you would like to store as the preset destination. Select the Name screen button to add a name, if needed.
5. Press and hold one of the buttons at the bottom of the screen until the name appears in that preset destination screen button. It is now available to select from the Destination Entry screen.

## Configure Menu

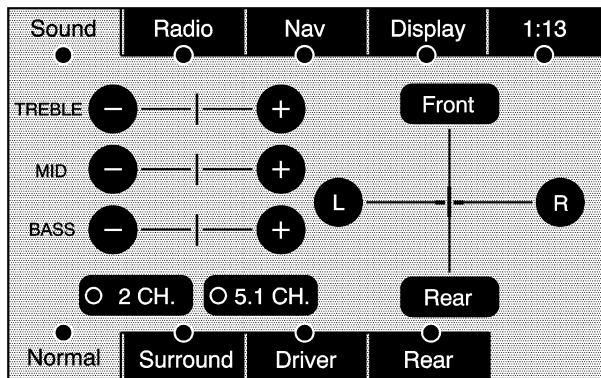

Press the CONFIG (Configure) hard key to adjust several of your system's features and preferences. The last selected CONFIG screen will be the screen that displays; Sound, Radio, Nav (navigation), Display, or Time.

## Sound

Press the CONFIG key to enter the configure menu options, then press the CONFIG key repeatedly until Sound is selected or touch the Sound screen button to make speaker and DSP (Digital Signal Processing) adjustments. See *Navigation Audio System on page 62* for more information.

## Radio

Press the CONFIG key to enter the configure menu options, then press the CONFIG key repeatedly until Radio is selected or touch the Radio screen button to make changes for radio information displayed, preset pages, XM™ categories, and Bose® AudioPilot®. See *Navigation Audio System on page 62* for more information.

## Nav (Navigation)

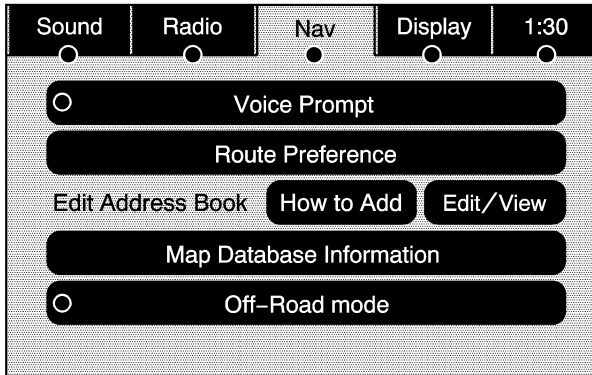

Press the CONFIG key to enter the configure menu options, then press the CONFIG key repeatedly until Nav is selected or touch the Nav screen button.

### Voice Prompt

**Voice Prompt:** Touch the Voice Prompt screen button to change the volume of the voice prompts or to turn voice guidance on and off.

**Volume:** Touch the + (plus) or – (minus) screen buttons to increase or to decrease the volume of the voice prompts. The system will respond with the adjusted voice level.

**Voice Guidance:** Touch the On or Off screen buttons to turn voice instructions on and off while traveling on a planned route.

### Route Preference

Touch the Route Preference screen button to change route options when the system calculates a route.

**Allow Major Roads:** This feature allows the system to use major roads when calculating a planned route.

**Allow toll road:** This feature allows the system to use toll roads when calculating a planned route.

**Allow ferry:** This feature allows the system to use ferries when calculating a planned route.

**Allow time and seasonal restricted road:** This feature allows the system to use time restricted and seasonal roads when calculating a planned route.

## Edit Address Book — How to Add

To add an address to the address book, see “Adding Destinations to the Address Book” under *Destination on page 28*.

## Edit Address Book — Edit/View

To edit the name of an address book:

1. Select the CONFIG hard key.
2. Select the NAV screen button.
3. Select the Edit/View Address Book screen button.
4. Select the Address book entry.

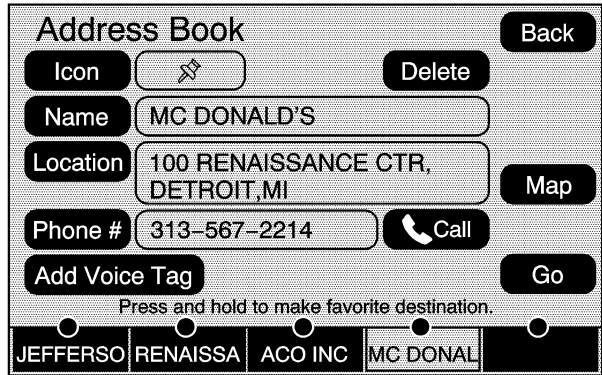

5. Touch the Name screen button and use the alpha keyboard to edit or add the name.
6. Touch the OK screen button to save your changes, then touch the Back screen button to return to the Address Book information screen.

To add or change the phone number of an address book entry:

1. Select the CONFIG hard key.
2. Select the NAV screen button.
3. Select the Edit/View Address Book screen button.
4. Select the address book entry to change.
5. Touch the Phone # screen button and use the numeric keyboard to input or change the phone number.
6. Touch the OK screen button to save your changes, then touch the Back screen button to return to the Address Book information screen.

To change the map icon of an address book entry:

1. Select the CONFIG hard key.
2. Select the NAV screen button.
3. Select the Edit/View Address Book screen button.
4. Select the address book entry to change.
5. Select the Icon screen button.
6. Select an icon from the list.

To add a voice tag to an address book entry:

1. Select the CONFIG hard key.
2. Select the NAV screen button.
3. Select the Edit/View Address Book screen button.
4. Select the Add Voice Tag screen button.
5. The system will ask for you to state the name. You will have four seconds to state the name. The system will respond back with the name and prompt you to repeat the name for confirmation.

To delete an address book entry:

1. Select the CONFIG hard key.
2. Select the NAV screen button.
3. Select the Edit/View Address Book screen button.
4. Select the address book entry to delete.
5. Press the Delete screen button to delete the address book entry.
6. A confirmation pop-up will display. Select Ok to delete; select Cancel to cancel the operation.

To delete the entire address book:

1. Select the CONFIG hard key.
2. Select the NAV screen button.
3. Select the Edit/View Address Book screen button.
4. A list of all the address book entries will display. Press and hold the Clear All screen button.
5. A confirmation pop-up will display. Select Ok to delete; select Cancel to cancel the operation.

**Call:** Press this screen button to make a phone call. See *Phone on page 96* for more information.

## Map Database Information

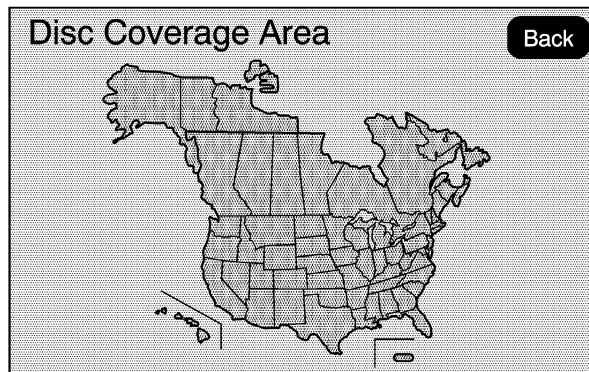

Touch the Map Database Information screen button to view the coverage areas of the map DVD.



## Off-Road Mode

To turn the Off-road mode on or off, do the following:

1. Press the CONFIG hard key.
2. Press the Nav screen button.
3. Press the Off-Road mode screen button. The button will be highlighted when the feature is on.

When the off-road mode is turned on, the navigation system will show the path being traveled by the vehicle when not on a marked road. This path will be a simulation since the map database coverage will not have these roads on the DVD. This path will be stored in the navigation system's memory, see "Previous Destination" under *Destination on page 28* for more information.

See "Off-Road Driving" in the Index of your vehicle's owner manual for more information about off-road driving.

## Display

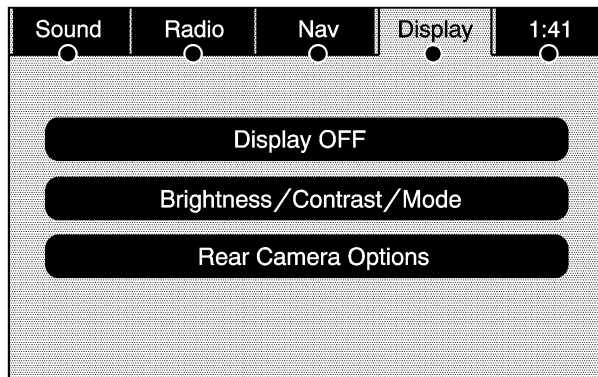

Press the CONFIG key to enter the configure menu options, then press the CONFIG key repeatedly until Display is selected or touch the Display screen button.

### Display Off

Touch this screen button to turn the display off. Press any hard key to view the display.

## Brightness/Contrast/Mode

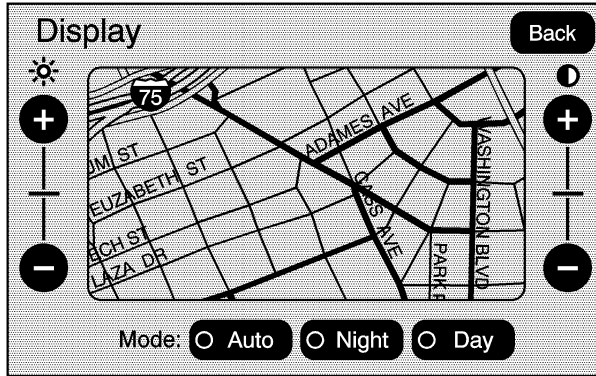

Touch this screen button to change the brightness, contrast, and mode of the display.

☀️ **(Brightness):** Touch the + (plus) or – (minus) screen buttons to increase or decrease the brightness of the screen.

● **(Contrast):** Touch the + (plus) or – (minus) screen buttons to increase or decrease the contrast of the screen.

**Auto (Automatic):** Touch this screen button for the system to automatically adjust the screen background depending on exterior lighting conditions.

**Night:** Touch this screen button and the system will make the map background darker.

**Day:** Touch this screen button and the system will make the map background brighter.

## Setting the Time

The navigation system time and the analog clock are separate features. Changing the time through the navigation system will not change the time on the analog clock and vice versa. See “Analog Clock” in the Index of your vehicle’s owner manual to change the analog clock time.

Press the CONFIG key to enter the configure menu options, then press the CONFIG key repeatedly until the time is selected or touch the time screen button.

**Hours:** Press the – (minus) or + (plus) signs to decrease or increase the hours.

**Minutes:** Press the – (minus) or + (plus) signs to decrease or increase the minutes.

**12/24 Format:** Select the 12 screen button for standard time; select the 24 screen button for military time.

## Rear Vision Camera

Your vehicle may be equipped with a rear vision camera system. Read this entire section before using the camera system.

The rear vision camera system is designed to help the driver when backing up by displaying a view, on the navigation screen, of the area behind the vehicle when the driver shifts the vehicle into REVERSE (R). Once the driver shifts out of REVERSE (R), the navigation screen will go back to the last screen that had been displayed, after a delay.

## Turning the Rear Vision Camera System On or Off

To turn the rear vision camera system on or off, do the following:

1. Shift into PARK (P).
2. Press the CONFIG hard key to enter the configure menu options, then press the CONFIG hard key to select Display or touch the Display screen button.
3. Select the Rear Camera Options screen button. The Rear Camera Options screen will display.

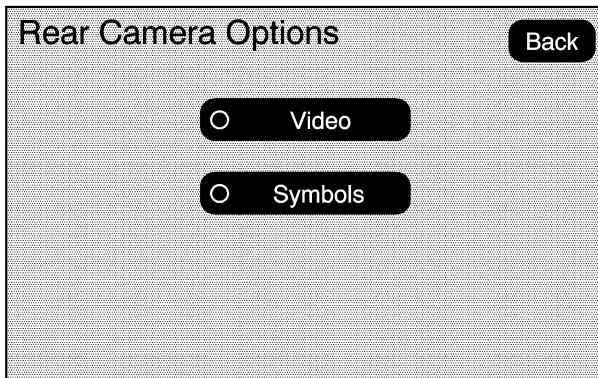

There is a message on the rear vision camera screen that states “Check Surroundings for Safety”.

**⚠ CAUTION:**

**The Rear Vision Camera (RVC) system does not replace driver vision. RVC does not:**

- **Detect objects that are outside the camera’s field of view, below the bumper, or underneath the vehicle.**
- **Detect children, pedestrians, bicyclists, or pets.**

**CAUTION: (Continued)**

4. Select the Video screen button. When the video button is highlighted, RVC system is on.

The delay that is received after shifting out of REVERSE (R) is approximately 10 seconds. The delay can be cancelled by performing one of the following:

- Pressing a hard key on the navigation system or touching the navigation screen.
- Shifting in to PARK (P).
- Reach a vehicle speed of 7 mph (11 km/h).

**CAUTION: (Continued)**

Do not back the vehicle by only looking at the rear vision camera screen, or use the screen during longer, higher speed backing maneuvers or where there could be cross-traffic. Your judged distances using the screen will differ from actual distances.

So if you do not use proper care before backing up, you could hit a vehicle, child, pedestrian, bicyclist, or pet, resulting in vehicle damage, injury, or death. Even though the vehicle has the RVC system, always check carefully before backing up by checking behind your vehicle.

**Rear Vision Camera Location**

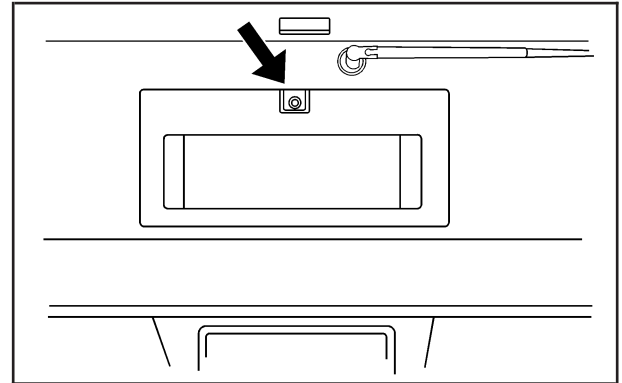

**Escalade, Escalade ESV shown; Escalade EXT similar**

The image is provided by the camera located above the license plate or under the endgate handle.

The camera uses a special lens. The distance of the image that appears on the screen differs from the actual distance. The area displayed by the camera is limited. The camera does not display objects which are close to either corner of the bumper or under the bumper. The area displayed on the screen may vary according to vehicle orientation or road conditions.

The following illustration shows the field of view that the camera provides.

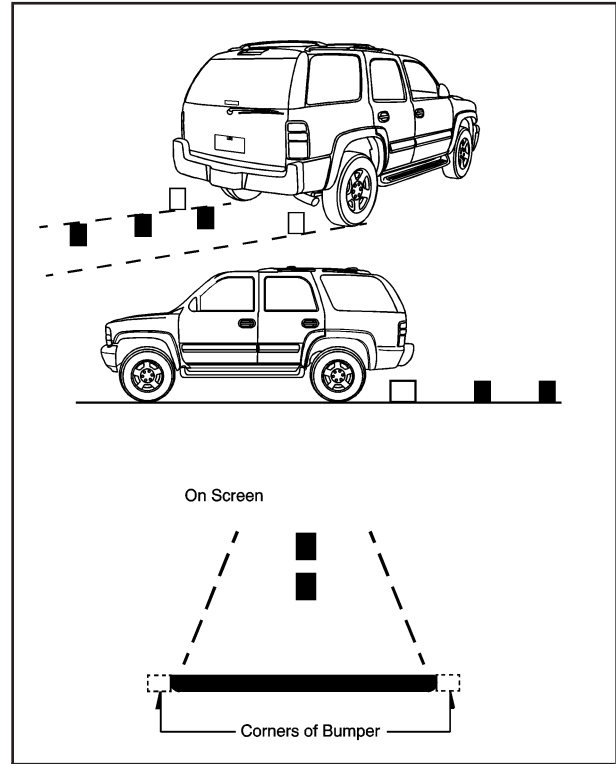

## Adjusting the Brightness and Contrast of the Screen

To adjust the brightness and contrast of the screen, press the CONFIG key while the rear vision camera image is on the display. Any adjustments made will only effect the rear vision camera screen.

☀️ **(Brightness):** Touch the + (plus) or – (minus) screen buttons to increase or decrease the brightness of the screen.

● **(Contrast):** Touch the + (plus) or – (minus) screen buttons to increase or decrease the contrast of the screen.

## Symbols

The navigation system may have a feature for you to view symbols on the navigation screen while using the rear vision camera. The Ultrasonic Rear Park Assist (URPA) system must not be disabled to use the caution symbols. If URPA has been disabled and the symbols have been turned on, an error message may display, Rear Parking Assist Symbols Unavailable.

The symbols will appear when an object has been detected by the URPA system. The symbol may cover the object when viewing the navigation screen.

To turn the symbols on or off, do the following:

1. Make sure that URPA has not been disabled.
2. Shift into PARK (P).
3. Press the CONFIG hard key to enter the configure menu options, then press the CONFIG hard key repeatedly until Display is selected or touch the Display screen button.
4. Select the Rear Camera Options screen button. The Rear Camera Options screen will display.
5. Touch the Symbols screen button. The screen button will be highlighted when on.

## When the System Does Not Seem To Work Properly

The rear vision camera system may not work properly or display a clear image in the following situations:

- The feature may be turned off. See “Turning the Rear Vision Camera System On or Off” earlier in this section.
- In the dark.
- When the sun or the beam of headlights is shining directly into the camera lens.
- If ice, snow, mud, or anything else builds up on the camera lens. Clean the lens, rinse it with water, and wipe it with a soft cloth.
- If the back of the vehicle is in an accident, the position and mounting angle of the camera may change or the camera may be affected. Be sure to have the camera and its position and mounting angle checked at your dealer/retailer.
- Extreme high or low temperatures or extreme temperature changes can affect the image displayed.

## Rear Vision Camera Error Messages

**Rear Vision Camera System Unavailable:** This message may display when the system is not receiving information it requires from other vehicle systems.

**Service Rear Vision Camera System:** This message may display when the system is not receiving video from the camera.

If any other problem occurs or if a problem persists, see your dealer/retailer.

## Global Positioning System (GPS)

The navigation system determines the position of your vehicle by using satellite signals, various vehicle signals, and map data.

At times, other interferences such as the satellite condition, road configuration, the condition of the vehicle and/or other circumstances can interfere with the navigation system’s ability to determine the accurate position of the vehicle.

The GPS shows the current position of your vehicle using signals sent by the GPS Satellites of the United States Department of Defense.



When your vehicle is not receiving signals from the satellites, a symbol will appear on the map screen. Refer to *Symbols on page 21*.

This system may not be available or interferences may occur if any of the following are true:

- Signals are obstructed by tall buildings, trees, large trucks, or a tunnel.
- Objects are located on the rear shelf.
- Satellites are being repaired or improved.
- After-market glass tinting has been applied to the vehicle's rear windshield.

**Notice: Do not apply after-market glass tinting to the vehicle's windows. Glass tinting will interfere with the system's ability to receive GPS signals and cause the system to malfunction. You might have to replace the window to correct the problem. This would not be covered by your warranty.**

For more information if you are experiencing a problem, see *If the System Needs Service on page 59* and *Problems with Route Guidance on page 58*.

## Vehicle Positioning

At times, the position of the vehicle on the map may be inaccurate due to one or more of the following reasons:

- The road system has changed.
- The vehicle is driving on slippery road surfaces such as in sand, gravel, and/or snow.
- The vehicle is traveling on winding roads.
- The vehicle is on a long straight road.
- The vehicle is approaching a tall building or a large vehicle.
- The surface streets run parallel to a freeway.
- The vehicle has just been transferred by a vehicle carrier or a ferry.
- The current position calibration is set incorrectly.
- The vehicle is traveling at high speed.
- The vehicle changes directions more than once, or when the vehicle is turning on a turn table in a parking lot.
- The vehicle is entering and/or exiting a parking lot, garage, or a lot with a roof.

- The GPS signal is not received.
- A roof carrier is installed on your vehicle.
- The vehicle is being driven with tire chains.
- The tires are replaced.
- The tire pressure for your tires is incorrect.
- The tires are worn.
- The first time the map DVD is inserted.
- The battery is disconnected for several days.
- The vehicle is driving in heavy traffic where driving is at low speeds, and the vehicle is stopped and started repeatedly.

If you experience problems with your system, see your dealer/retailer.

## Problems with Route Guidance

Inappropriate route guidance may occur under one or more of the following conditions:

- You have not turned onto the road indicated.
- Route guidance may not be available when using automatic rerouting for the next right or left turn.

- The route may not be changed when using automatic rerouting.
- There is no route guidance when turning at an intersection.
- Plural names of places may be announced occasionally.
- It may take a long time to operate automatic rerouting during high-speed driving.
- Automatic rerouting may display a route returning to the set stopover if you are heading for a destination without passing through a set stopover.
- The route prohibits the entry of a vehicle due to a regulation by time or season or any other regulation which may be given.
- Some routes may not be searched.
- The route to the destination may not be shown if there are new roads, if roads have recently changed, or if certain roads are not listed on the map DVD. See *Ordering Map DVDs on page 59*.

To recalibrate the vehicle's position on the map, see your dealer/retailer.

## If the System Needs Service

If your system needs service and you have followed the steps listed here and still are experiencing problems, see your dealer/retailer for assistance.

## Ordering Map DVDs

The map DVD in your vehicle is the most up-to-date information available when your vehicle was produced. The map DVD is updated periodically, provided that the map information has changed. To order a new map DVD, contact your dealer/retailer.

## Database Coverage Explanations

Coverage areas vary with respect to the level of map detail available for any given area. Some areas will feature greater levels of detail than others. If this happens, it does not mean there is a problem with the system. As the map DVD is updated, more detail may become available for areas which previously had limited detail. See *Ordering Map DVDs on page 59*.



## NOTES

---

---

---

---

---

---

---

---

---

---

---

---

---

---

---

---

---

---

---

---

---

---

## Section 3 Navigation Audio System

---

<b>Navigation Audio System</b> .....	62	DVD Player .....	80
CD Player .....	71	Auxiliary Devices .....	87

## Navigation Audio System

**Notice:** Before adding any sound equipment to your vehicle, such as an audio system, CD player, CB radio, mobile telephone, or two-way radio, make sure that it can be added by checking with your dealer/retailer. Also, check federal rules covering mobile radio and telephone units. If sound equipment can be added, it is very important to do it properly. Added sound equipment can interfere with the operation of your vehicle's engine, radio, or other systems, and even damage them. Your vehicle's systems can interfere with the operation of sound equipment that has been added.

**Notice:** The chime signals related to seat belts, parking brake, and other functions of your vehicle operate through the navigation system. If that equipment is replaced or additional equipment is added to your vehicle, the chimes may not work. Make sure that replacement or additional equipment is compatible with your vehicle before installing it. See "Accessories and Modifications" in the Index of your vehicle's owner manual.

## Playing the Radio

 **(Power/Volume):** Press this knob to turn the audio system on and off. Turn the knob to increase or to decrease the volume.

Press and hold this knob for more than two seconds to turn off the navigation system, the Rear Seat Entertainment (RSE) video screen, and Rear Seat Audio (RSA). If the vehicle has not been tuned off, the RSE and the RSA can be turned back on by pressing this knob and will continue play of the last active source.

 **(Tuning Knob):** Turn this knob to go to the next or previous frequency or disc track or chapter. See *CD Player on page 71* or *DVD Player on page 80* for more information.

**AUDIO:** Press this key to display the audio screen. Press the key to switch between AM, FM, or XM, if equipped, DISC, or AUX (Auxiliary), or touch the screen button. See *CD Player on page 71*, *DVD Player on page 80*, and *Auxiliary Devices on page 87* for more information.

## Finding a Station

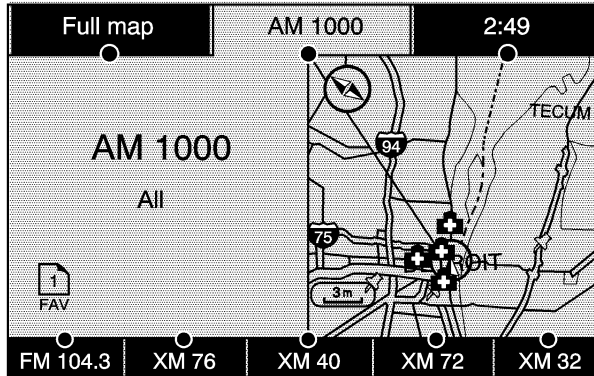

**AM source shown, other sources similar**

If viewing a map screen, touch the source screen (AM, FM, XM, CD, etc.) button. The display will split between the audio screen and the map screen. All station-changing functions can be performed from this screen.

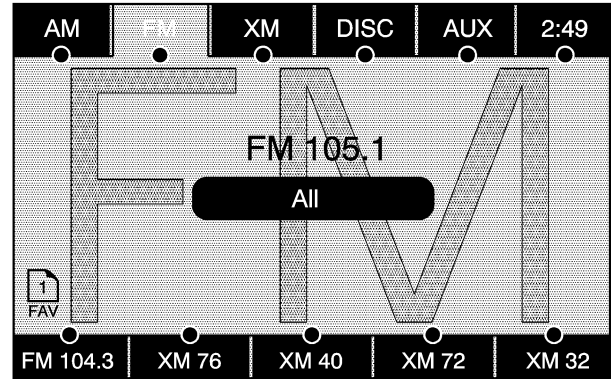

**FM source shown, other sources similar**

If you do not want to view a split screen or you are not on a map screen, press the AUDIO hard key.

**AM/FM/XM:** Touch the source (AM, FM, or XM, if equipped) screen button or press the AUDIO key repeatedly until the desired source is highlighted.

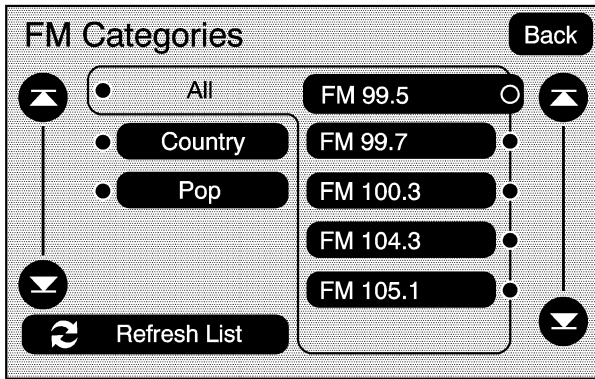

FM source shown, other sources similar

**Category:** Touch the screen button, located in the middle of the screen, to receive a list of all of the selected band stations in the area. Use the up and down arrow screen buttons to scroll the frequencies. Touch the desired frequency.

XM lists will also contain a category to select and the stations or channels that pertain to the category. For XM, touch the left and right arrow screen buttons to change categories. The station information will appear on the display.

See “Radio Menu” later in this section to add and remove XM categories from the category list. The categories, when removed, will not be enabled to select from the category list screen or when using the right and left arrow category screen buttons.

FM lists may also contain a category to select if stations in your area support Radio Data Systems (RDS).

**Refresh List:** Touch this screen button to refresh the list of AM or FM stations.

When viewing a map screen, the name of the station or channel will appear on the display.

**Seek:** To seek stations, press the up or down arrow keys to go to the next or previous station.

To scan stations, press and hold either arrow for more than two seconds. The radio will go to a station, play for a few seconds, then go on to the next station. To stop scanning, press either arrow again.





## Storing Radio Station Presets

This feature allows you to store up to 30 preset stations. You can mix AM, FM, and XM (if equipped). To store presets, do the following:

1. Press the  (power) knob to turn the system on.
2. If viewing a map screen, touch the source screen button, press the AUDIO key, or press the FAV (favorite) key.
3. Select the band.
4. Seek, scan, or tune to the desired station, to select the station.
5. Press and hold one of the preset screen buttons for more than two seconds or until you hear a beep.
6. Repeat the steps for each preset.

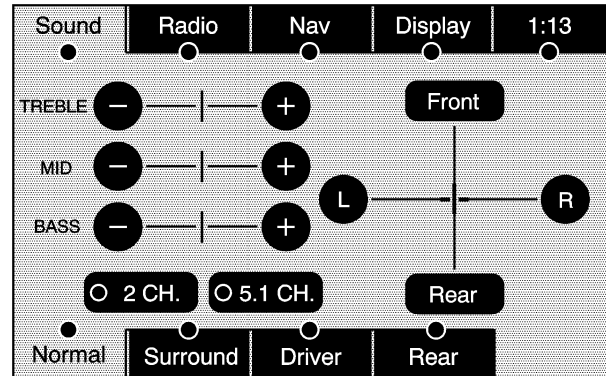
## Sound Menu



 **(Sound):** Press this key or press the CONFIG key to access the Sound menu to adjust the treble, midrange, bass, fade, balance, and Digital Signal Processing (DSP). The system automatically stores audio adjustment settings as changes are made for each audio source including AM, FM, XM (if equipped), CD, and AUX.

## Setting the Tone

**TREBLE:** Touch the plus (+) or minus (–) sign to increase or decrease the treble. If a station is weak or noisy, decrease the treble.

**MID (Midrange):** Touch the plus (+) or minus (–) sign to increase or decrease the midrange.

**BASS:** Touch the plus (+) or minus (–) sign to increase or decrease the bass.

## Adjusting the Speakers

**L/R (Left/Right) (Balance):** To adjust the balance between the left and the right speakers, touch and hold the L or R screen buttons.

**Front/Rear (Fade):** To adjust the fade between the front and the rear speakers, touch and hold the Front or Rear screen buttons.

## Digital Signal Processing (DSP)

The system has Digital Signal Processing (DSP). DSP is used to provide a choice of four different listening experiences. DSP can be used while listening to the audio system. Not all DSP modes are available for all source types. The type of DSP selected is displayed on the status line.

Select from the following DSP settings:

**Normal:** Select this screen button to adjust the audio to be in normal mode. DSP will be off.

**Surround:** Select this screen button to turn on surround sound listening for a CD, MP3, or a DVD stereo audio source.

**Driver:** Select this screen button to adjust the audio to give the driver the best possible sound quality.

**Rear:** Select this screen button to adjust the audio to give the rear seat occupants the best possible sound quality.

**2 CH. (Channel):** Select this screen button to enhance surround sound.

**5.1 CH. (Channel):** Select this screen button to give a full affect of surround sound listening. This button is only available when playing DVD video and DVD audio discs that support 5.1 audio and the RSA is off.

## Radio Menu

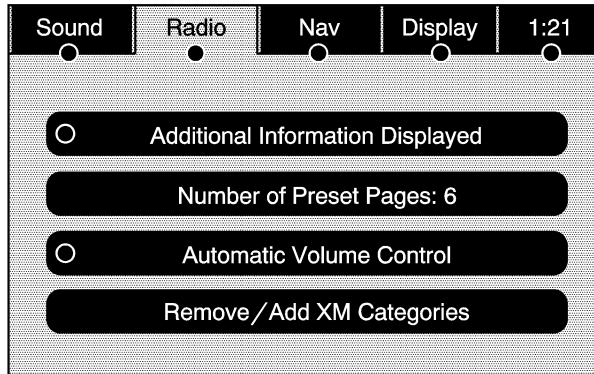

Press the CONFIG key to enter the configure menu screen, then press the CONFIG key repeatedly until Radio is selected or touch the Radio screen button to make changes for radio information displayed, number of preset pages, XM categories, and Bose® AudioPilot®.

## Additional Information Displayed

Touch the Additional Information Displayed screen button to turn station, channel, CD, and MP3 information on or off. The information will display when the screen button is highlighted.

When the screen button is highlighted the system will display, when it is available, for the following; FM: RDS category name and radio text, XM: Song Title and Artist Name, CD: CD text, MP3: tag information.

## Number of Preset Pages

Touch the Number of Preset Pages screen button to change the number of preset pages, 1 through 6. Each preset page can contain five preset stations. Touch the desired numbered screen button.

## **Bose AudioPilot®**

**AudioPilot®:** If the system has the Bose® sound system, it includes Bose AudioPilot® noise compensation technology.

To use AudioPilot®:

1. Press the CONFIG key to enter the menu screen, then press the CONFIG key repeatedly until Radio is selected or touch the Radio screen button
2. Press the Automatic Volume Control screen button to access the AudioPilot® menu.
3. Press the ON screen button.

To turn it off, touch the OFF screen button. When on, AudioPilot® continuously adjusts the audio system equalization, to compensate for background noise, so that your music always sounds the same at the set volume level.

This feature is most effective at lower volume settings where background noise can affect how well you hear the music being played through your vehicle's audio system. At higher volume settings, where the music is much louder than the background noise, there may be little or no adjustments by AudioPilot®. For more information on AudioPilot®, visit [www.bose.com/audiopilot](http://www.bose.com/audiopilot).

## **Remove/Add XM Categories**

Touch the Remove/Add XM Categories screen button to remove or add XM categories when selecting XM categories from the category list screen. The list of XM categories will appear on the screen. Use the up and down arrow screen buttons to scroll through the list. The categories to remove will be highlighted and the categories to add will be dark in color. Touch the category that you would like to add or remove. Touch the Restore All Categories screen button to add all categories that have been removed.

## Radio Data System (RDS)

The audio system has a Radio Data System (RDS). RDS features are available for use only on FM stations that broadcast RDS information. With RDS, the radio can do the following:

- Seek to stations broadcasting the selected type of programming
- Receive announcements concerning local and national emergencies
- Display messages from radio stations

This system relies on receiving specific information from these stations and will only work when the information is available. In rare cases, a radio station may broadcast incorrect information that will cause the radio features to work improperly. If this happens, contact the radio station.

The RDS system is always on. When information is broadcast from the FM station you are listening to, the station name or call letters will be displayed on the audio screen. RDS may provide a program type (PTY) for current programming and the name of the program being broadcasted.

## XM™ Satellite Radio Service

XM™ is a satellite radio service that is based in the 48 contiguous United States and Canada. XM™ offers a large variety of coast-to-coast channels including music, news, sports, talk, traffic/weather (U.S. subscribers), and children's programming. XM™ provides digital quality audio and text information that includes the channel name and number, song title, and artist name. A service fee is required in order to receive the XM™ service. For more information, contact XM™; In the U.S. at [www.xmradio.com](http://www.xmradio.com) or call 1-800-852-XXM (9696) or in Canada at [www.xmradio.ca](http://www.xmradio.ca) or call 1-877-GET-XMSR (438-9677).

When XM™ is active, the channel name and number, song title, and artist will display on the screen.

## **XM™ Radio Messages**

**XL (Explicit Language Channels):** XL on the radio display, after the channel name, indicates content with explicit language. These channels, or any others, can be blocked at a customer's request by calling 1-800-852-XXXM (9696).

**XM Updating:** The encryption code in the receiver is being updated and no action is required.

**No XM signal:** The vehicle is in a location that is blocking the XM™ signal. When the vehicle is moved into an open area, the signal should return.

**Loading XM:** The audio system is processing audio and text data received. No action is needed.

**Channel Off Air:** This channel is not currently in service.

**Channel Unavail:** This previously assigned channel is no longer assigned.

**No Artist Info:** No artist information is available. The system is working properly.

**No Title Info:** No song title information is available. The system is working properly.

**No CAT Info:** No category information is available. The system is working properly.

**Not Found:** There are no channels available for the selected category. The system is working properly.

**No Information:** No text or informational messages are available. The system is working properly.

**XM Theftlocked:** The XM™ receiver may have previously been in another vehicle. For security purposes, XM™ receivers cannot be swapped between vehicles. If this message is received after having your vehicle serviced, check with your dealer/retailer.

**XM Radio ID:** If tuned to channel 0, this message will alternate with the XM™ Radio eight digit radio ID label. This label is needed to activate the service.

**Unknown:** If this message is received when tuned to channel 0, there may be a receiver fault. Consult with your dealer/retailer.

**Check XM Receiver:** If this message does not clear within a short period of time, the receiver may have a fault. Consult with your dealer/retailer.

## CD Player

The player can be used for CD, MP3, DVD audio, and as a DVD video player. See *DVD Player* on page 80 for more information about DVD audio and video.

### Six-Disc CD Player

While playing a CD, the navigation system is available.

When you insert a CD, the CD tab will display. If you select a DSP setting for the CD, it will be activated each time you play a CD.

If you turn off the ignition or radio with a CD in the player, it will stay in the player. When you turn on the ignition or radio, the CD will start playing where it stopped, if it was the last selected audio source.

As each new track starts to play, the track number will appear on the display.

If playing a CD-R the sound quality may be reduced due to CD-R quality, the method of recording, the quality of the music that has been recorded, and the way the CD-R has been handled. There may be an increase in skipping,

difficulty in finding tracks, and/or difficulty in loading and ejecting. If these problems occur, check the bottom surface of the CD. If the surface of the CD is damaged, such as cracked, broken, or scratched, the CD will not play properly. If the surface of the CD is soiled, see “Care of Your CDs” in the Index of your vehicle’s owner manual.

If there is no apparent damage, try a known good CD.

**Notice:** If a label is added to a CD, or more than one CD is inserted into the slot at a time, or an attempt is made to play scratched or damaged CDs, the CD player could be damaged. While using the CD player, use only CDs in good condition without any label, load one CD at a time, and keep the CD player and the loading slot free of foreign materials, liquids, and debris.

Do not add any label to a CD, it could get caught in the CD player. If a CD is recorded on a personal computer and a description label is needed, label the top of the recorded CD with a soft marker.

If an error appears on the display, see “CD Messages” later in this section.

If viewing a map screen, touch the CD screen button. The display will split between the audio screen and the map screen. If you do not want to view a split screen or you are not on a map screen, press the AUDIO key then press the AUDIO key repeatedly until CD is selected or touch the CD screen button.

 **(Load):** To load one disc, do the following:

1. Press the load hard key and follow the screen message displayed.
2. When the system displays “Insert Disc (number)”, insert the disc partway into the slot, label side up. The system will pull it into the first available slot and start playing. The system will display the type of disc inserted.

To load multiple discs, do the following:

1. Press and hold the load hard key and follow the screen message displayed.
2. When the system displays “Insert Disc (number)”, insert the disc partway into the slot, label side up. The system will pull it in.

3. Once a disc is loaded, the system will display “Insert Disc (number)” again. Load the next disc. Repeat this procedure for each disc. The player takes up to six discs, do not try to load more than six. The system will not display the disc types when loading all, until the discs have been read by the system. Once all discs have been inserted, the system will start playing the last loaded disc.

 **(Eject):** To eject a disc, do the following:

1. Press the eject hard key.
2. The system will display “Ejecting Disc”.

Press the DISC screen button to display the Disc Changer screen. Select the disc to eject. If a selection is not made, the system will eject the disc from the current slot. If the disc is not removed from the slot, the system will pull it back in after 10 seconds and start playing it.

To eject all discs, press and hold the eject hard key. The system will display the disc number being ejected.



## Playing an Audio CD

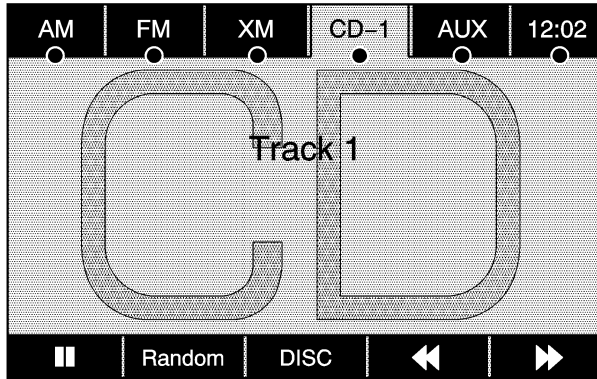

**|| / ▶ (Pause/Play):** Touch this button to pause the CD. This button will then change to the play button. Touch the play button to play the CD.

**Random:** Touch this button to hear the tracks in random, rather than sequential, order. Touch Random again to turn off random play.

**DISC:** Touch this screen button to view the list of loaded disc(s). Select the disc to play.

**◀◀ (Rewind):** Touch and hold this button to rewind quickly through a track selection.

You will hear sound at a reduced volume. Release this button to stop rewinding. The display will show the elapsed time of the track.

**▶▶ (Forward):** Touch and hold this button to fast forward quickly through a track selection. You will hear sound at a reduced volume. Release this button to stop fast forwarding. The display will show the elapsed time of the track.

**▲◀ ▶▼ (Seek):** To seek tracks, press the up arrow to go to the next track. Press the down arrow to go to the start of the current track, if more than eight seconds have played. If either arrow is pressed more than once, the player will continue moving backward or forward through the CD. The sound will mute while seeking.

**◀▶ □ (Tuning Knob):** Turn this knob counterclockwise one notch to go to the start of the current track, turn it again to go to the previous track. Turn this knob clockwise to go to the next track.

When playing an audio CD the rear seat operator can power on the RSE video screen and use the remote control to navigate through the tracks on the CD.

## Using an MP3 CD

### MP3 Format

There are guidelines that must be met, when creating an MP3 disc. If the guidelines are not met when recording a CD-R(W), the CD may not play. The guidelines are:

- Sampling rate: 16 kHz, 22.05 kHz, 24 kHz, 32 kHz, and 44.1 kHz.
- Bit rates supported: 32, 40, 48, 56, 64, 80, 96, 112, 128, 160, 192, 224, 256, and 320 kbps.
- ID3 tag information is displayed by the radio if it is available. The radio supports ID3 tag information v1.0, v1.1, or v2.0. The radio will display a filename, song name, artist name, album name, and directory name.
- Maximum 32 characters, including spaces, in a file or folder name.
- Maximum number of folders is 253 with a maximum hierarchy of eight folders.

- Create a folder structure that makes it easy to find songs while driving. Organize songs by albums using one folder for each album. Each folder or album should contain 18 songs or less.
- It is recommended that there is a maximum of 192 files on a disc.
- The files can be recorded on a CD-R or CD-RW with a maximum capacity of 700MB.
- DVD with MP3 are not playable on this system.

### Root Directory

The root directory will be treated as a folder. If the root directory has compressed audio files, the directory will be displayed as No Folder or ALL.

## **Empty Directory or Folder**

If a root directory or a folder exists somewhere in the file structure that contains only folders/subfolders and no compressed files directly beneath them, the player will advance to the next folder in the file structure that contains compressed audio files and the empty folder will not be displayed or numbered.

## **No Folder**

When the CD contains only compressed files, the files will be located under the root folder. The next and previous folder functions will have no function on a CD that was recorded without folders or playlists. When displaying the name of the folder the radio will display No Folder.

## **Order of Play**

Play will begin from the first track under the root directory. When all tracks from the root directory have been played, play will continue from files according to their numerical listing. After playing the last track from the last folder, play will begin again at the first track of the first folder or root directory.

When play enters a new folder, the display will not automatically show the new folder name. The new track name will appear on the display.

## **File System and Naming**

The song name that will display will be the song name that is contained in the ID3 tag. If the song name is not present in the ID3 tag, then the radio will display the file name without the extension (such as .mp3) as the track name.

Track names longer than 32 characters or four pages will be shortened. The display will not show parts of words on the last page of text and the extension of the filename will not display.

## Playing an MP3

While playing a CD, the navigation system is available.

When you insert a CD, the CD tab will display. If you select a DSP setting for the CD, it will be activated each time you play a CD.

If you turn off the ignition or radio with a CD in the player, it will stay in the player. When you turn on the ignition or radio, the CD will start playing where it stopped, if it was the last selected audio source.

As each new track starts to play, the track number will appear on the display.

If playing a CD-R the sound quality may be reduced due to CD-R quality, the method of recording, the quality of the music that has been recorded, and the way the CD-R has been handled. There may be an increase in skipping, difficulty in finding tracks, and/or difficulty in loading and ejecting. If these problems occur, check the bottom surface of the CD. If the surface of the CD is damaged, such as cracked, broken, or scratched, the CD will not play properly. If the surface of the CD is soiled, see "Care of Your CDs" in the Index of your vehicle's owner manual.

If there is no apparent damage, try a known good CD.

**Notice:** If a label is added to a CD, or more than one CD is inserted into the slot at a time, or an attempt is made to play scratched or damaged CDs, the CD player could be damaged. While using the CD player, use only CDs in good condition without any label, load one CD at a time, and keep the CD player and the loading slot free of foreign materials, liquids, and debris.

Do not add any label to a CD, it could get caught in the CD player. If a CD is recorded on a personal computer and a description label is needed, label the top of the recorded CD with a soft marker.

If an error appears on the display, see "CD Messages" later in this section.

If viewing a map screen, touch the CD screen button. The display will split between the audio screen and the map screen. If you do not want to view a split screen or you are not on a map screen, press the AUDIO key then press the AUDIO key repeatedly until CD is selected or touch the CD screen button.

 **(Load):** To load one disc, do the following:

1. Press the load hard key and follow the screen message displayed.
2. When the system displays “Insert Disc (number)”, insert the disc partway into the slot, label side up. The system will pull it into the first available slot and start playing. The system will display the type of disc inserted.

To load multiple discs, do the following:

1. Press and hold the load hard key and follow the screen message displayed.
2. When the system displays “Insert Disc (number)”, insert the disc partway into the slot, label side up. The system will pull it in.
3. Once a disc is loaded, the system will display “Insert Disc (number)” again. Load the next disc. Repeat this procedure for each disc.

The player takes up to six discs, do not try to load more than six. The system will not display the disc types when loading all, until the discs have been read by the system.

Once all discs have been inserted, the system will start playing the last loaded disc.

 **(Eject):** To eject a disc, do the following:

1. Press the eject hard key.
2. The system will display “Ejecting Disc”.

Press the DISC screen button to display the Disc Changer screen. Select the disc to eject. If a selection is not made, the system will eject the disc from the current slot. If the disc is not removed from the slot, the system will pull it back in after 10 seconds and start playing it.

To eject all discs at once, press and hold the eject hard key. The system will display the disc number being ejected.

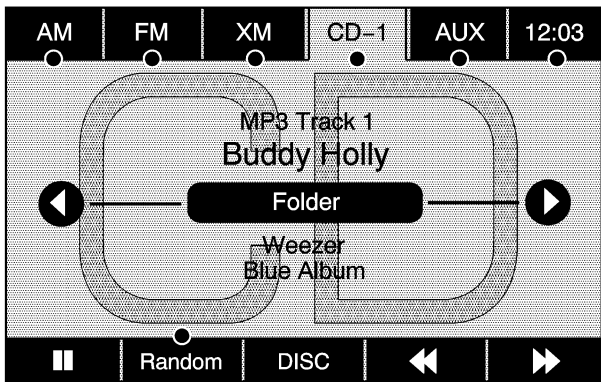

**|| / ▶ (Pause/Play):** Touch this button to pause the CD. This button will then change to the play button. Touch the play button to play the CD.

**Random:** Touch this button to hear the tracks in random, rather than sequential, order. Touch Random again to turn off random play.

**DISC:** Touch this screen button to view the list of loaded disc(s). Select the disc to play.

**◀ (Rewind):** Touch and hold this button to rewind quickly through a track selection. You will hear sound at a reduced volume. Release this button to stop rewinding. The display will show the elapsed time of the track.

**▶ (Forward):** Touch and hold this button to fast forward quickly through a track selection. You will hear sound at a reduced volume. Release this button to stop fast forwarding. The display will show the elapsed time of the track.

**◀▶ (Folder/Artist/Album):** Select the left or right arrow to go to the previous or next folder, artist, or album on the disc.

Press the middle screen button, with the folder, artist, or album name, to sort the MP3 by folder, artist, or album. It may take a few minutes for the system to sort the MP3.

**^ ◀ ▶ ∨ (Seek):** To seek tracks, press the up arrow to go to the next track. Press the down arrow to go to the start of the current track, if more than eight seconds have played. If either arrow is pressed more than once, the player will continue moving backward or forward through the CD. The sound will mute while seeking.

 **(Tuning Knob):** Turn this knob counterclockwise one notch to go to the start of the current track, turn it again to go to the previous track. Turn this knob clockwise to go to the next track.

When playing an MP3 the rear seat operator can power on the RSE video screen and use the remote control to navigate through the MP3.

## CD Messages

If Disc Read Error appears on the display and/or the CD comes out, it could be for one of the following reasons:

- If a disc was inserted with an invalid or unknown format.
- If the map DVD disc was installed into the CD slot. See “Installing the Map DVD” under *Maps on page 18* for more information.

- It is very hot. When the temperature returns to normal, the CD should play.
- You are driving on a very rough road. When the road becomes smoother, the CD should play.
- The CD is dirty, scratched, wet, or upside down.
- The air is very humid. If so, wait about an hour and try again.
- There may have been a problem while burning the CD.
- The label may be caught in the CD player.

If the CD is not playing correctly, for any other reason, try a known good CD.

If any error occurs repeatedly or if an error cannot be corrected, contact your dealer/retailer.

## DVD Player

The player can be used for CD, MP3, DVD audio, and as a DVD video player.

DVD video will not display on the navigation screen unless the vehicle is in PARK (P). It will operate on the rear seat entertainment screens while the vehicle is moving. The Rear Seat Entertainment (RSE) video screen will start play of the DVD when a DVD video has been inserted into the navigation system. The DVD player can be controlled by the buttons on the navigation system, the Rear Seat Audio (RSA) system, and the remote control. The DVD player can also be used for the rear seat passengers with the radio off. The rear seat passengers can power on the video screen and use the remote control to navigate the disc. See “Rear Seat Entertainment System” in the Index of your vehicle’s owner manual for more information.

The DVD player is only compatible with DVDs of the appropriate region code that is printed on the jacket of most DVDs.

The DVD slot is compatible with most audio CDs, CD-R, CD-RW, DVD-Video, DVD-Audio, DVD-R/RW, DVD+R/RW media along with MP3 and WMA formats.

If playing any compatible DVD-R the sound quality may be reduced due to disc quality, the method of recording, the quality of the video that has been recorded, and the way the disc has been handled. There may be an increase in skipping, difficulty in finding chapters, and/or difficulty in loading and ejecting. If these problems occur, check the bottom surface of the DVD. If the surface of the DVD is damaged, such as cracked, broken, or scratched, the DVD will not play properly.

If there is no apparent damage, try a known good DVD.

**Notice:** If you add any label to a DVD, insert more than one DVD into the slot at a time, or attempt to play scratched or damaged DVDs, you could damage the DVD player. When using the DVD player, use only DVDs in good condition without any label, load one DVD at a time, and keep the DVD player and the loading slot free of foreign materials, liquids, and debris.

Do not add any label to a DVD, it could get caught in the DVD player. If a DVD is recorded on a personal computer and a description label is needed, label the top of the recorded DVD with a soft marker.



If an error appears on the display, see “DVD Messages” later in this section.

 **(Load):** To load one disc, do the following:

1. Press the load hard key and follow the screen message displayed.
2. When the system displays “Insert Disc (number)”, insert the disc partway into the slot, label side up. The system will pull it into the first available slot and start playing. The system will display the type of disc inserted.

To load multiple discs, do the following:

1. Press and hold the load hard key and follow the screen message displayed.
2. When the system displays “Insert Disc (number)”, insert the disc partway into the slot, label side up. The system will pull it in.
3. Once a disc is loaded, the system will display “Insert Disc (number)” again. Load the next disc. Repeat this procedure for each disc.

The player takes up to six discs, do not try to load more than six. The system will not display the disc types when loading all, until the discs have been read by the system.

Once all discs have been inserted, the system will start playing the last loaded disc.

 **(Eject):** To eject a disc, do the following:

1. Press the eject hard key.
2. The system will display “Ejecting Disc”.

Press the DISC screen button to display the Disc Changer screen. Select the disc to eject. If a selection is not made, the system will eject the disc from the current slot. If the disc is not removed from the slot, the system will pull it back in after 10 seconds and start playing it.

To eject all discs at once, press and hold the eject hard key. The system will display the disc number being ejected.

## Playing a DVD

There are three ways to play a DVD:

- Once a DVD is inserted, the system will automatically start play of the DVD.
- If you are on a map screen, touch the DVD screen button.
- Press the AUDIO hard key, then touch the DVD screen button.

When a DVD is loaded, the rear seat passengers can power on the RSE video screen and use the remote control to navigate through the DVD.

 **(Power/Volume):** Press this knob to turn the system on and off. Turn the knob to increase or decrease the volume of the audio system.

Press and hold this knob for more than two seconds to turn off the navigation system, RSE video screen, and RSA. If the vehicle has not been tuned off, the RSE and the RSA can be turned back on by pressing this knob and will continue play of the last active source.

## DVD Menu Options

Once a DVD starts to play, the menu options and cursor screen buttons will automatically appear. To display the menu Options screen button while a DVD is playing, touch anywhere on the screen.

**Options:** Select this screen button to view the menu option screen buttons. Menu options are available when they are highlighted. Some menu options are only available when the DVD is not playing.

**Cursor:** Touch this button to access the cursor menu. The arrows and other cursor options allow you to navigate the DVD menu options. The cursor menu options are only available if a DVD has a menu. Use the cursor menu to start a DVD video from the disc main menu.

 **(Arrow Buttons):** Use these arrow buttons to move around the DVD menu.

**Enter:** Touch this button to select the highlighted option.

**Return:** Touch this button to go back to the previous DVD menu.

**Back:** Touch this button to go back to the main DVD display screen.

**Move:** Touch this button to move the cursor buttons back and forth from the bottom-right corner to the top-left corner of the screen.

**|| / ▶ (Pause/Play):** Touch this button to pause the DVD. This button will then change to the play button. Touch the play button to play the DVD. Touch this button in a DVD disc main menu to start the movie.

**■ (Stop):** Touch this button to stop play of the DVD. Press the play button to continue playing the DVD from where the DVD was stopped. Press this button twice to return to the beginning of the DVD.

**DISC:** Touch this screen button to view the list of loaded disc(s). Select the disc to play.

**◀◀ (Rewind):** Touch and release this button to rewind through the scene, chapters, and titles. Touch this button again to increase the rewinding speed. Touch the play button to stop rewinding. This button may not work when the DVD is playing the copyright information or the previews.

**▶▶ (Forward):** Touch and release this button to advance rapidly through the scene, chapters, and titles. Touch this button again to increase the fast forwarding speed. Touch the play button to stop fast forwarding. This button may not work when the DVD is playing the copyright information or the previews.

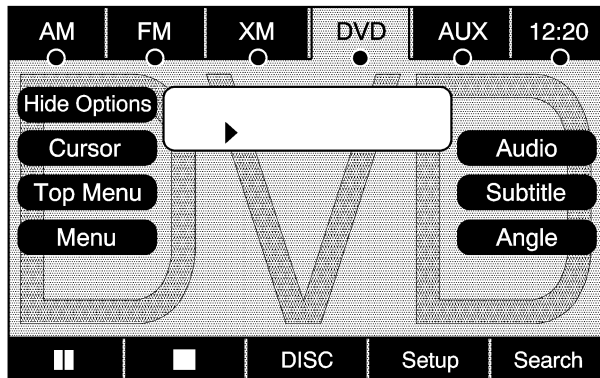

**Hide Options:** Press this screen button to remove all menu options from the display, except Options and Cursor.

**Top Menu:** Touch this button to display the first menu of the DVD. This is not available on all DVDs.

**Menu:** Touch this button to display the DVD menu of the current area of the DVD that is playing. This button is not available for DVD audio.

**Audio:** Press this button to display the audio options. Select the audio options that best improve sound quality. This is not available on all DVDs or when the DVD is stopped. This button is not available for DVD audio.

**Subtitle:** Touch this button to playback the video with subtitles. This is not available on all DVDs or when the DVD is stopped. This button is not available for DVD audio.

**Angle:** Touch this button to adjust the viewing angle of the DVD. Repeatedly press this button to toggle through the angles. This is not available on all DVDs or when the DVD is stopped. This button is not available for DVD audio.

◀ **(Previous Scene):** Press this button to go to the previous scene. This button does not work when the DVD is stopped. This button is not available for DVD video.

▶ **(Next Scene):** Press this button to go to the next scene. This button does not work when the DVD is stopped. This button is not available for DVD video.

**Search:** Touch this button to display the search screen. Select Title or Chapter Search for DVD video and Group or Track for DVD audio. The keyboard allows you to type in the title/chapter/group/track number that you would like to watch or listen to. This button does not work when the DVD is stopped.

**Setup:** Touch this button to display the DVD Setup screen. This button is only available when the DVD is not playing. The DVD Setup screen allows you to change the brightness, contrast, and mode, change the viewing on the monitor and to change the initial settings; language, parental level, and aspect.

☼ **(Brightness):** Touch the up or down screen arrows to increase or decrease the brightness of the navigation screen.

● **(Contrast):** Touch the up or down screen arrows to increase or decrease the contrast of the navigation screen.

**Auto (Automatic):** Touch this screen button for the system to automatically adjust the navigation screen background depending on exterior lighting conditions.

**Night:** Touch this screen button and the system will make the navigation screen background brighter.

**Day:** Touch this screen button and the system will make the navigation screen background darken.

**Monitor:** From the DVD Setup screen, touch this button to adjust the viewing angle of the DVD on the navigation screen. This is not available on all DVDs. This button is not available for DVD audio

Touch the  button to close the screen in from the left and right sides.

Touch the  button to fill the screen on the left and right sides.

Touch the  button to fill the screen on the top and bottom.

**Settings:** From the DVD Setup screen, touch this button to change the default audio, subtitle, and menu languages, parental level, audio, and to view the aspect of the DVD. These settings are not available on all DVDs. This button is not available for DVD audio.

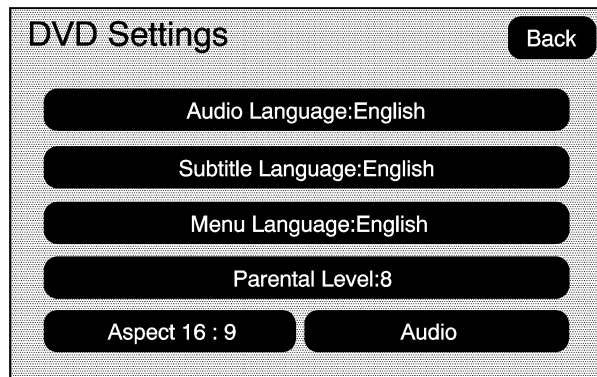

**Audio Language:** Touch English, Francais, Espanol, Italiano, or Deutsch to change the default language that the DVD player uses for each disc. The audio language must be available on the disc. The audio language may vary for each DVD.

**Subtitle Language:** Touch English, Francais, Espanol, Italiano, or Deutsch to change the default language of the subtitles that the DVD player uses for each disc. The subtitle language must be available on the disc. The subtitle language may vary for each DVD.

**Menu Language:** Touch English, Francais, Espanol, Italiano, or Deutsch to change the default language of the DVD video menus. The menu language must be available on the disc. The menu language may vary for each DVD.

**Parental Level:** Touch this button to change the rating level to only allow the play of DVDs with a certain rating. The rating selection is 1 through 8, with 1 Kids Safe being a G rating. If the 1 is selected, any DVD with a rating above G will not be able to be viewed without entering a password.

When the parental level is first entered a keyboard will appear on the display and a four-digit password will need to be created. Type in a password that you will be able to remember. Once the password is created, you can then select a rating level.

If you would like to change the rating level, press the Parental Level button, then press the Password button. Type in the password and then change the rating level.

If the password has been forgotten, contact your dealer/retailer.

This may not be available on all DVDs.

**Aspect:** Touch this button to change the aspect ratio of the DVD. This may not be available on all DVDs.

**^ (Next Track/Chapter):** Press this hard key to go to the next track or chapter. This button may not work when the DVD is playing the copyright information or the previews.

**∨ (Previous Track/Chapter):** Press this hard key to return to the start of the current track or chapter. Press this button again to go to the previous track or chapter. This button may not work when the DVD is playing the copyright information or the previews.

** (Tuning Knob):** Turn this knob counterclockwise one notch to go to the start of the current chapter/track, turn it again to go to the previous chapter/track. Turn this knob clockwise to go to the next chapter/track.

## DVD Messages

If Disc Read Error appears on the display and/or the DVD comes out, it could be for one of the following reasons:

- If a disc was inserted with an invalid or unknown format.
- If the disc is not from a correct region.
- If the map DVD disc was installed into the DVD audio/video slot. See “Installing the Map DVD” under *Maps on page 18* for more information.
- It is very hot. When the temperature returns to normal, the DVD should play.
- You are driving on a very rough road. When the road becomes smoother, the DVD should play.
- The DVD is dirty, scratched, wet, or upside down.
- The air is very humid. If so, wait about an hour and try again.

- There may have been a problem while burning the DVD.
- The label may be caught in the DVD player.

If the DVD is not playing correctly, for any other reason, try a known good DVD.

If any error occurs repeatedly or if an error cannot be corrected, contact your dealer/retailer.

## Auxiliary Devices

Your vehicle may have a rear entertainment system (RSE) with a second and third row screen. The RSE has audio adapters to allow you to connect auxiliary devices. The audio can be heard through the speakers or through the wireless or wired headphones. See “Audio/Video Jacks” under “Rear Seat Entertainment System” in the Index of your vehicle’s owner manual for more information.

Drivers are encouraged to set up any auxiliary device while the vehicle is in PARK (P). See “Defensive Driving” in the Index of your vehicle owner manual for more information on driver distraction.

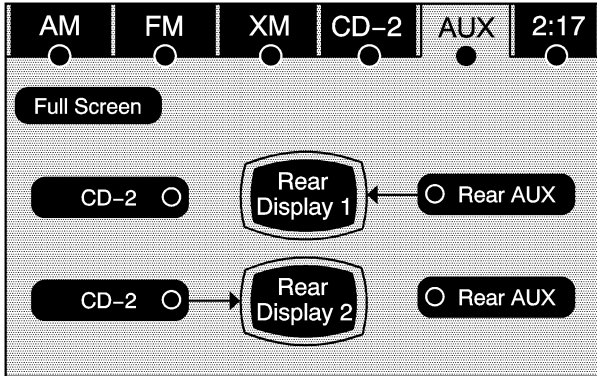

To switch the RSE system to use an auxiliary device, do the following:

1. Connect the auxiliary device to the RSE system, for the second or third row.
2. Press the AUDIO key then press the AUDIO key repeatedly until AUX (auxiliary) is selected or touch the AUX screen button. An auxiliary device must be connected for the AUX screen button to appear as an option to select.
3. For the second row display select the Rear AUX screen button next to Rear Display 1 and for the third row display select the Rear AUX screen button next to Rear Display 2. Each screen works independently of the other. The second row screen can watch a DVD while the third row screen can use the auxiliary device.

The rear seat passengers can also use the remote control to change the functions of the RSE. See “Rear Seat Entertainment System” in the Index of your vehicle’s owner manual for more information.



## Section 4 Voice Recognition

---

Voice Recognition ..... 90

# Voice Recognition

The navigation system's voice recognition allows for hands-free operation of the navigation system, audio system, and OnStar® features. The DVD map disc must be installed in the navigation system for voice recognition to work. See "Installing the DVD Map Disc" under *Maps on page 18*.

Voice recognition can be used when the ignition is on or when Retained Accessory Power (RAP) is active. See "Retained Accessory Power (RAP)" in the Index of your vehicle's owner manual for more information.

To use voice recognition, do the following:



1. Push and hold the talk symbol steering wheel control until you hear a beep. The audio system will mute.

2. Clearly state one of the commands listed on the following pages.

## Helpful Hints for Stating Commands

- When a multiple command is available, choose the command that works best for you.
- Words that are in brackets are optional. For example, for the command Radio [band] [select] FM, stating Radio FM or Radio select FM are both valid commands.
- When the system recognizes the command the system will do one of the following:
  - Perform the function.
  - Ask you to confirm your choice.
  - Issue an error message "Did not recognize. Voice Recognition Canceled."
- If the system is not yet ready, the system will display a message.
- To cancel a command or if the system response does not match your verbal command, press and hold the talk symbol button. The system will reply, "Voice Recognition Canceled".

- If you experience difficulty with the system recognizing a command, try saying it more softly, and wait for a few seconds after the beep, or you may just try saying it again.
- Background noise may cause voice commands to be misunderstood, including airflow noise from wind.
- To use the voice recognition system, the map DVD must be loaded and the navigation system must be on.

This system is able to recognize commands in three different languages. The system will only recognize commands based on the language selected from the Driver Information Center (DIC). See “Driver Information Center, DIC Vehicle Personalization” in the Index of your vehicles owner manual.

## Voice Recognition Commands

The following list shows all of the voice commands available for the navigation system with a brief description of each. The commands are listed with the optional words in brackets. To use the voice commands, refer to the instructions listed previously.

## Voice Tag Commands

The following are voice tag commands you can access by clearly stating the commands exactly as they are written. You may have up to 40 voice tag entries for destinations.

**Navigation go to [destination], navigation select:** These commands instruct the system to select a destination saved under the voice tag you have stored. The system will prompt you for a destination name then wait for you to state the name.

If you are not currently driving on a route, the system will automatically create the voice tag destination as the final destination. If you are currently driving on a route, the system will automatically create the voice tag destination as a stopover. Up to three stopovers can be created.

## Storing Voice Tags

From the address book entry information page, press the Add Voice tag screen button. The system will respond “Name Please?” and you will have four seconds to record a name. The system will ask for confirmation of the name before saving it as a voice tag.

## Navigation Help

**Navigation Help:** This command instructs the system to assist with navigation commands.

## Display Commands

Use the following display commands to set the display mode.

**Display [set] day [mode]:** Use this command to set the display to daytime mode.

**Display [set] night [mode]:** Use this command to set the display to night mode.

**Display [set] auto [mode]:** Use this command to set the display to automatic mode. The system will change between day and night mode automatically.

**System help:** This command instructs the system to assist with display commands.

## Radio Commands

The following are radio commands you can access by clearly stating the commands exactly as they are written.

**Radio [band] [select] AM, radio [band] [select] FM, radio [band] [select] XM, radio [band] [select] satellite:** These commands instruct the system to go to either the AM, FM, or XM (if equipped).

**Radio [select] (frequency) AM, radio [select] (frequency) FM:** These commands instruct the system to go to a specific frequency on either AM or FM.

**Radio [select] (channel) XM, radio [select] (channel) satellite:** These commands instruct the system to go to a specific channel on the XM™ band (if equipped).

**Radio help:** This command instructs the system to assist with radio commands.

## CD Commands

The following are CD, MP3, and DVD commands that can be accessed by clearly stating the commands exactly as they are written.

**CD, DVD, Disc:** Use this command to select a CD, DVD, or disc that is currently loaded.

**CD, DVD, Disc, [select] track (one, two, three, etc.):** This command instructs the system to select a specific track number.

**CD, DVD, Disc select next folder:** Use this command to select the next folder on the MP3 or audio DVD.

**CD, DVD, Disc select previous folder:** Use this command to select the previous folder on the MP3 or audio DVD.

**CD help, DVD help, Disc help:** This command instructs the system to assist with CD and DVD commands.

## Auxiliary Commands

The following auxiliary commands can be accessed by clearly stating the commands exactly as they are written. The commands are available when the auxiliary source is available.

**Aux, Auxiliary:** Use this command to select the auxiliary device, when a device is connected.

### OnStar<sup>®</sup> Command

**OnStar:** This command instructs the system to connect to OnStar<sup>®</sup>. You will enter the OnStar<sup>®</sup> voice recognition system. Refer to your OnStar<sup>®</sup> owner guide for more information.

### Voice Help

**Voice help:** This command will provide a description of help commands that can be used.

 **NOTES**

---

---

---

---

---

---

---

---

---

---

---

---

---

---

---

---

---

---

---

---

---

---

---

## Section 5 Phone

---

Phone ..... 96

# Phone

The navigation system has a calling feature if you have a subscription for OnStar® personal calling. See the OnStar® manual for more information. This feature allows you to call phone numbers that are listed in your personal address book that is on the navigation system. See “Nav” under *Configure Menu* on page 44 for more information on adding phone numbers to the address book.

To call a phone number, press the  (Phone) key. Use the numeric keyboard to input the phone number then press the Call screen button. The numeric keyboard is not available while the vehicle is moving. This function is only available when the vehicle is in PARK (P).

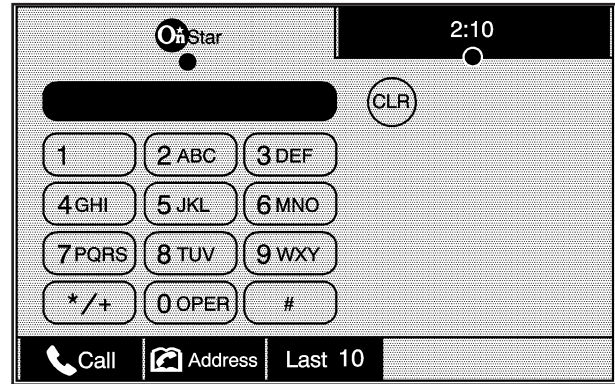

**Call:** Press this screen button to dial the phone to number.

**Address:** Press this screen button to add the phone number to the address book, or to look up the phone number that you would like to call.

**Last 10:** Press this screen button to view the list of the last 10 incoming and outgoing phone numbers.



## A

Adding Destinations to the Address Book .....	42
Adding or Changing Preset Destinations .....	43
Alpha-Numeric Keyboard .....	18
Audio System .....	62
Auto Reroute .....	28
Auxiliary Devices .....	87

## C

Canadian Owners .....	2
Canceling Guidance .....	14
CD	
Player .....	71
CD Messages .....	79
CD Player .....	71
Cleaning the Video Screen .....	14
Configure Menu .....	44

## D

Database Coverage Explanations .....	59
Deleting Personal Information .....	9
Destination .....	28
Detailed Areas .....	19
Display .....	49
Driving on a Route .....	26
DVD	
Player .....	80
DVD Map Disc Messages .....	20
DVD Menu Options .....	82
DVD Messages .....	87
DVD Player .....	80

## E

Ejecting the DVD Map Disc .....	20
Entering an Address and Point of Interest, and Storing Preset Destinations .....	10

## F

Finding a Station ..... 63

## G

Getting Started, Navigation ..... 6

Getting Started on Your Route ..... 39

Global Positioning System (GPS) ..... 56

Guidance Volume ..... 14

## H

Hard Keys ..... 16

## I

Installing the DVD Map Disc ..... 19

## L

Language — English/Metric ..... 9

Limited Guidance Areas ..... 19

## M

Map Adjustments ..... 20

Map Scales ..... 20

Maps ..... 18

Menu

    Configure ..... 44

## N

Nav (Navigation) ..... 45

Navigation

    Getting Started ..... 6

    System Overview ..... 4

    Using the System ..... 16

## O

Ordering	
Map DVDs .....	59
Overview, Navigation System .....	4
Owners, Canadian .....	2

## P

Park Aid .....	51
Phone .....	96
Playing a DVD .....	82
Playing the Radio .....	62
Problems with Route Guidance .....	58

## R

Radio .....	44, 62
Radio Data System (RDS) .....	69
Radio Menu .....	67
Rear Vision Camera .....	51

## S

Scrolling the Map .....	21
Setting the Time .....	10, 50
Six-Disc CD Player .....	71
Sound .....	44
Sound Menu .....	65
Storing Radio Station Presets .....	9, 65
Symbols .....	21
System Needs Service, If .....	59

## T

Touch-Sensitive Screen Buttons ..... 18

## U

Using an MP3 CD ..... 74

Using Your Stored Preset Destinations ..... 13

## V

Vehicle Positioning ..... 57

Video Screen, Cleaning ..... 14

Voice Recognition ..... 90

Voice Recognition Commands ..... 91

## X

XM™ Satellite Radio Service ..... 69