



## SERVICE BULLETIN

Classification: AT13-009a	Reference: NTB14-002a	Date: March 4, 2014
------------------------------	--------------------------	------------------------

### 2008-2012 ROGUE; REDUCED PERFORMANCE DUE TO CVT FLUID TEMPERATURE PROTECTION LOGIC

This bulletin has been amended. A parts order form has been added. To address this change, text has been added to ACTION and PARTS INFORMATION. Please discard all previous versions.

**APPLIED VEHICLE:** 2008-2012 Rogue (S35) 2WD/4WD without tow package kit

#### IF YOU CONFIRM:

The maximum vehicle speed is, or was, reduced by the CVT fail-safe logic after continuous operation under the following conditions:

- High RPM and/or high speed driving  
(RPM of 4000+ or speeds of 65 mph [104.6 km/h] for 1.0 – 1.5 hrs. or more)
- Driving in ambient temperature of 96 degrees or higher
- Climbing steep or extended hills for 6 miles (9.6 km) or more
- Whine or rattle type noise occurring during reduced engine performance (vehicle speed decrease)

**NOTE:** Before applying this bulletin, check and repair any DTCs first.

#### ACTION:

Install SERVICE KIT-COOLER ASSY (see **PARTS INFORMATION**).

**NOTE:** This kit is on part restriction. Use the order form at the end of this bulletin.

**IMPORTANT:** The purpose of **ACTION** (above) is to give you a quick idea of the work you will be performing. You **MUST** closely follow the entire **SERVICE PROCEDURE** as it contains information that is essential to successfully completing the repair.

Nissan Bulletins are intended for use by qualified technicians, not 'do-it-yourselfers'. Qualified technicians are properly trained individuals who have the equipment, tools, safety instruction, and know-how to do a job properly and safely. **NOTE:** If you believe that a described condition may apply to a particular vehicle, **DO NOT** assume that it does. See your Nissan dealer to determine if this applies to your vehicle.

## SERVICE PROCEDURE

### Install Oil Cooler (CVT mounted heat exchanger with 4 ports)

1. Place the vehicle on a lift and raise it as needed to perform the following procedure.
2. Remove the front Bumper Fascia Assembly, front Under Cover, left front Fender Protector and left Air Guide.
  - Refer to the appropriate section of the ESM for the procedures to remove the items in step 2.

**NOTE:** The Air Guide is connected to the Radiator core support with a J-hook and must be lifted up before being pulled forward to remove.

3. Remove the Air Inlet Duct from the Air Cleaner Case.

**WARNING:** Never remove the radiator cap when the engine is hot. Serious burns may occur from high-pressure engine coolant escaping from the radiator.

4. Relieve any residual cooling system pressure.
  - a. Wrap a thick cloth around the radiator cap. Slowly turn it a quarter of a turn to release the pressure.
  - b. Then turn it all the way.
5. Clamp both of the coolant hoses attached to the CVT Fluid Cooler to prevent coolant loss.

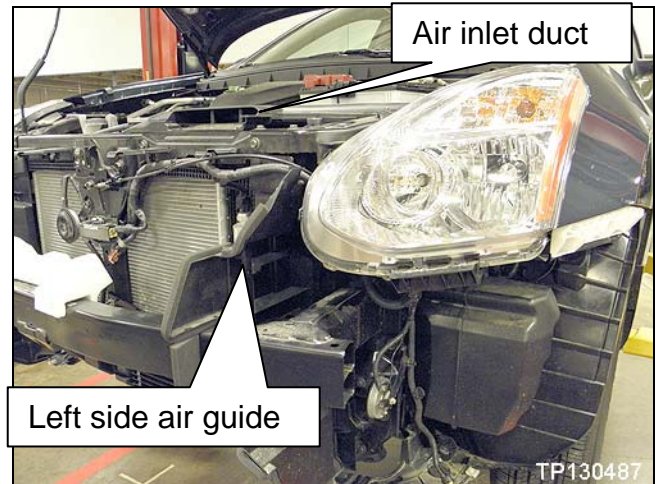

Figure 1

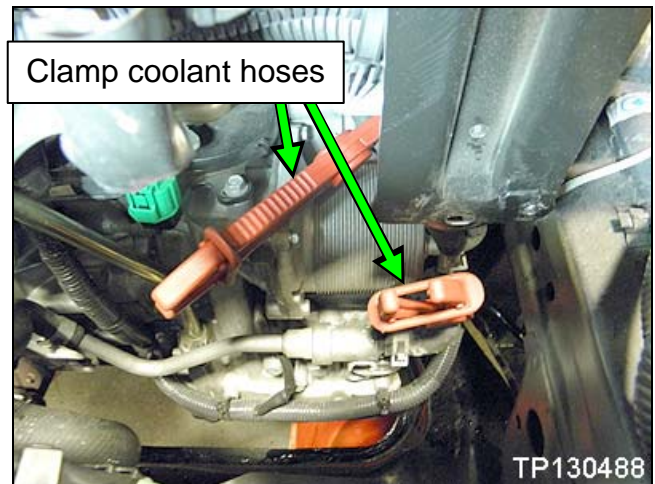

Figure 2

6. Remove "bolt A" and loosen "bolt B" for the Water Hose Bracket in Figure 3.

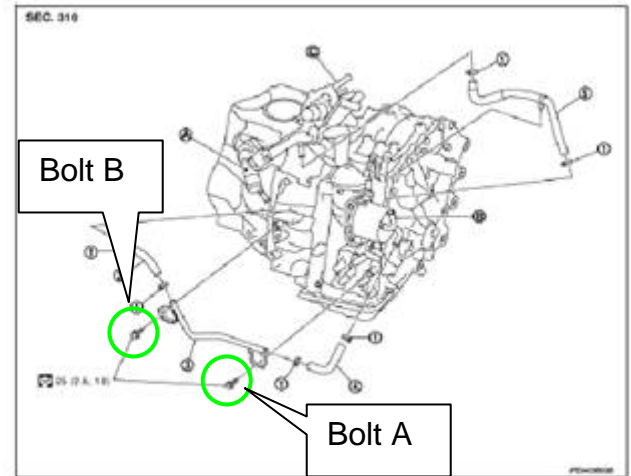

Figure 3

7. Remove the spring clamps from the CVT Fluid Cooler water hoses and then remove both hoses from the CVT Fluid Cooler.

**NOTE:** These spring clamps will be saved and reused for reassembly.

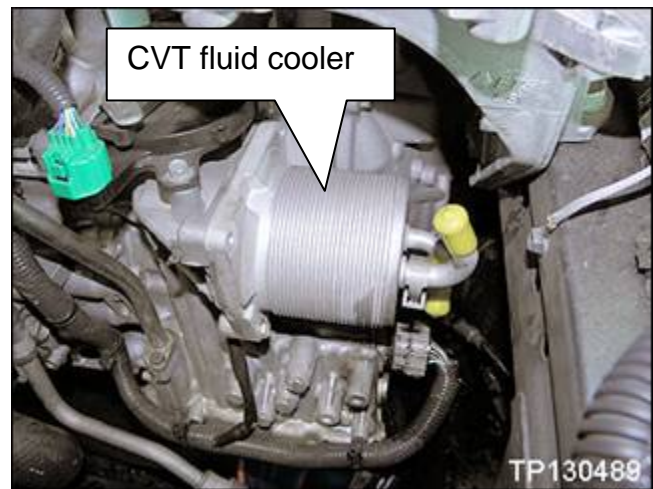

Figure 4

8. Remove the CVT Fluid Cooler mounting bolts and remove the CVT Fluid Cooler.
9. Clean any debris from the CVT Fluid Cooler mounting surface with brake cleaner and a lint free cloth.

**NOTE:** Use genuine Nissan Brake Cleaner or equivalent. Make sure the product that is used complies with local regulations.

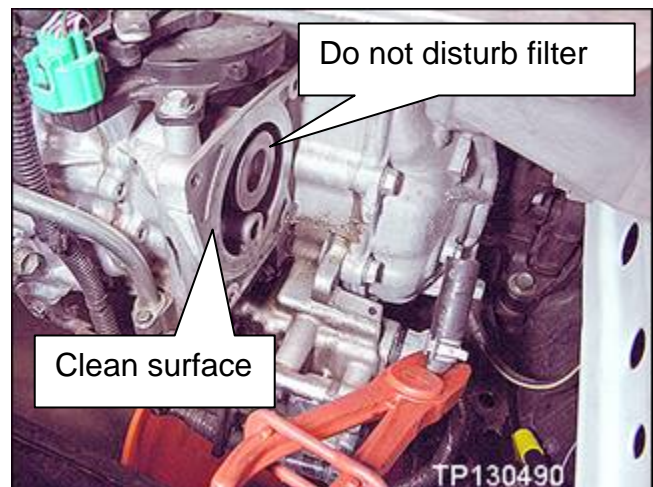

Figure 5

10. Coat the new O-ring on CVT Fluid Cooler using NS-2 CVT fluid before installing it onto the CVT Cooler mounting area.



Figure 6

11. Install the new CVT Fluid Cooler from the kit onto the CVT and tighten the mounting bolts to 3.63 N•m (0.37 kg-m, **32 in-lb**).

12. Remove any residual coolant from the inside of both of the coolant hoses before re-assembly of the hoses to the CVT fluid cooler.

**NOTE:** Use genuine Nissan Brake Cleaner or equivalent. Make sure the product that is used complies with local regulations.

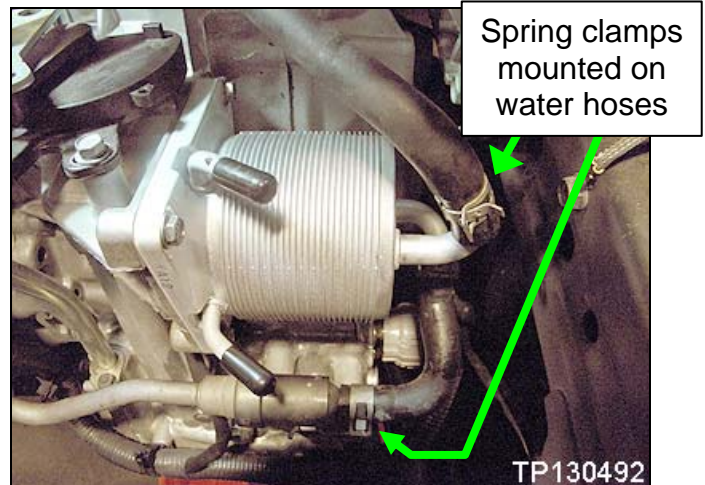

Figure 7

13. Re-install the water hoses onto the new CVT Fluid Cooler and then reinstall the spring clamps.

- Position the spring clamps as close to each fitting bulge as possible and then release them.

**NOTE:** Confirm that the clamps are not on top of each fitting bulge or on an angle.

14. Re-install the Water Hose Bracket and tighten bolt A and bolt B from step 6 to 4.2 N•m (0.43 kg-m, **37 in-lb**).



## Install the COOLER ASSY-AUTO TRANS (external air-to-ATF CVT cooler)

1. Remove the SEAL-LOWER and create a notch to clear new BRKT ASSY-O/COOLER, LWR, and then re-install the SEAL-LOWER.
  - a. See Figure 10 for reference to locate the pre-existing weld nuts in the lower radiator support that the BRKT ASSY-O/COOLER, LWR (No. 3), shown in Figure 11 and Figure 12, will be attached to.
  - b. Place the BRKT ASSY-O/COOLER, LWR from the kit over the SEAL-LOWER and mark "bracket width" where the material will be removed as shown in Figure 8 and Figure 10.
  - c. Remove only enough material (Figure 9 and Figure 10) to allow the BRKT ASSY-O/COOLER, LWR to be installed to the lower radiator support (approximately 127mm x 50.8mm [5" x 2"]).
    - o Remove gently to avoid cracking the material.

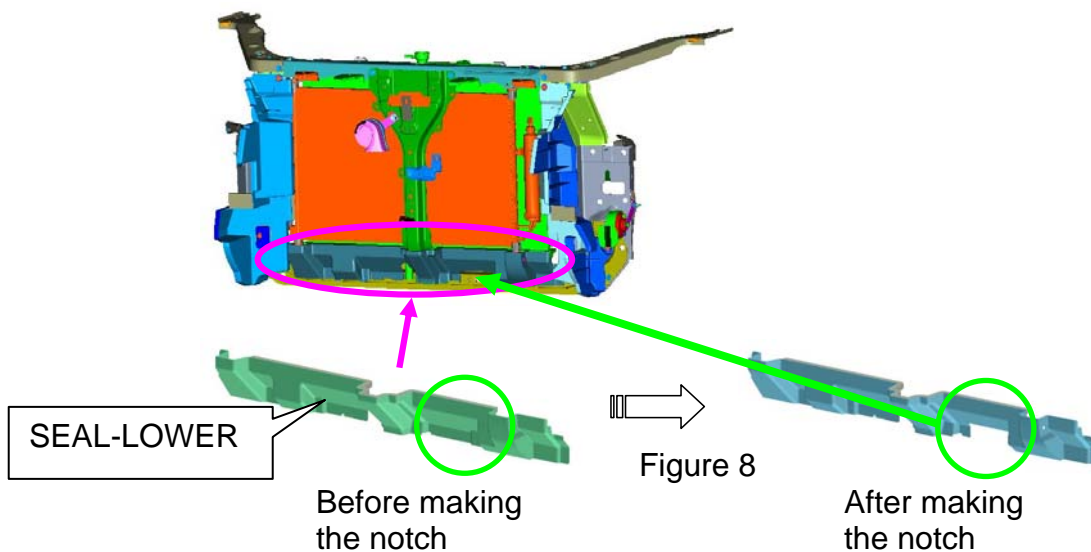

Figure 9

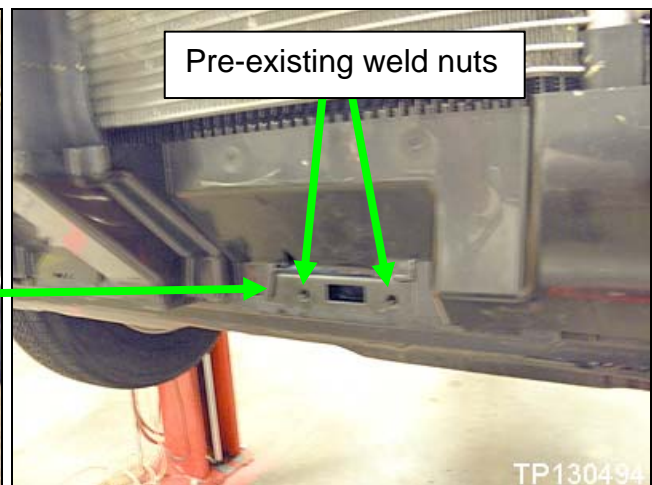

Figure 10

Figure 9 and Figure 10 illustrate the area to remove the material to allow clearance to install the BRKT ASSY-O/COOLER, LWR.

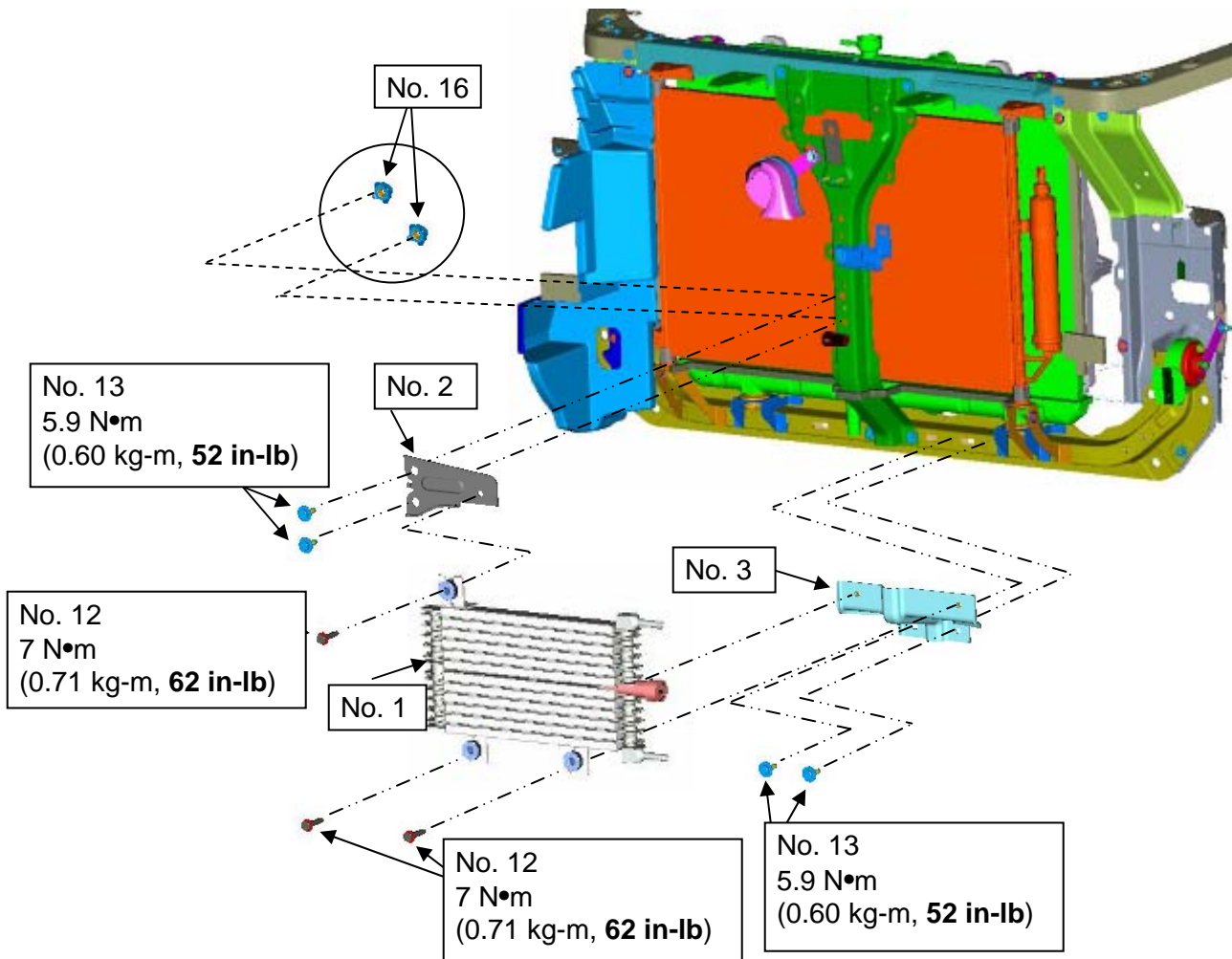

Figure 11

Figure 11 illustrates the COOLER ASSY-AUTO TRANS and attachment points to vehicle and is for reference when performing steps on page 7.

**NOTE:** Refer to Table A on page 13 for parts descriptions and quantities in the kit.

**NOTE:** Refer to Figure 11 on page 6 for steps 2-4 below.

2. Install BRKT ASSY-O/COOLER, LWR (No. 3) to the lower radiator support.

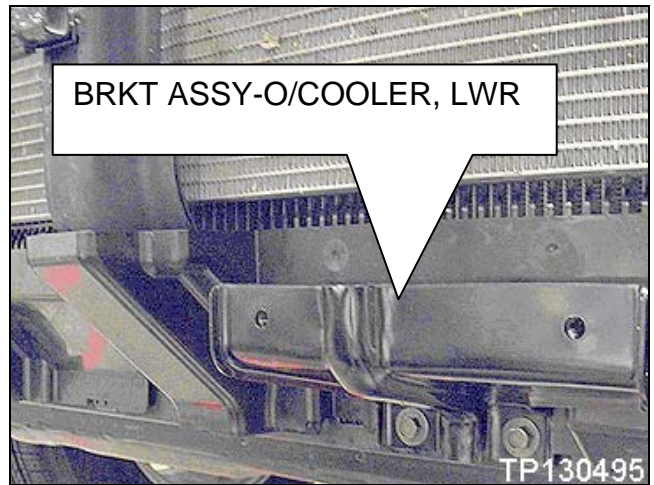

Figure 12

3. Install BRKT ASSY-O/COOLER, UPR (No. 2) to the center member.
  - Leave nuts loose at this time.

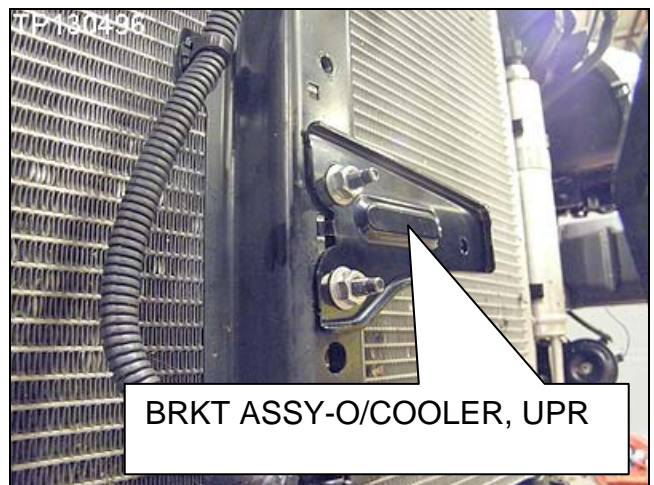

Figure 13

4. Install COOLER ASSY-AUTO TRANS, OIL (No. 1) and torque all bolts to specifications provided in Figure 11.

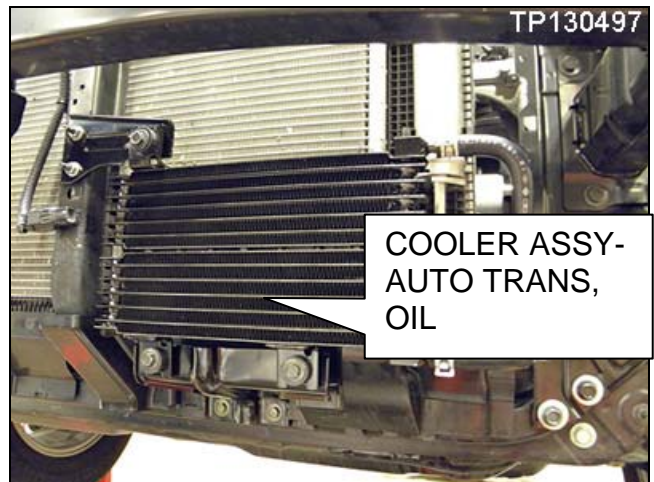

Figure 14

## Assemble the Hoses and Side Bracket

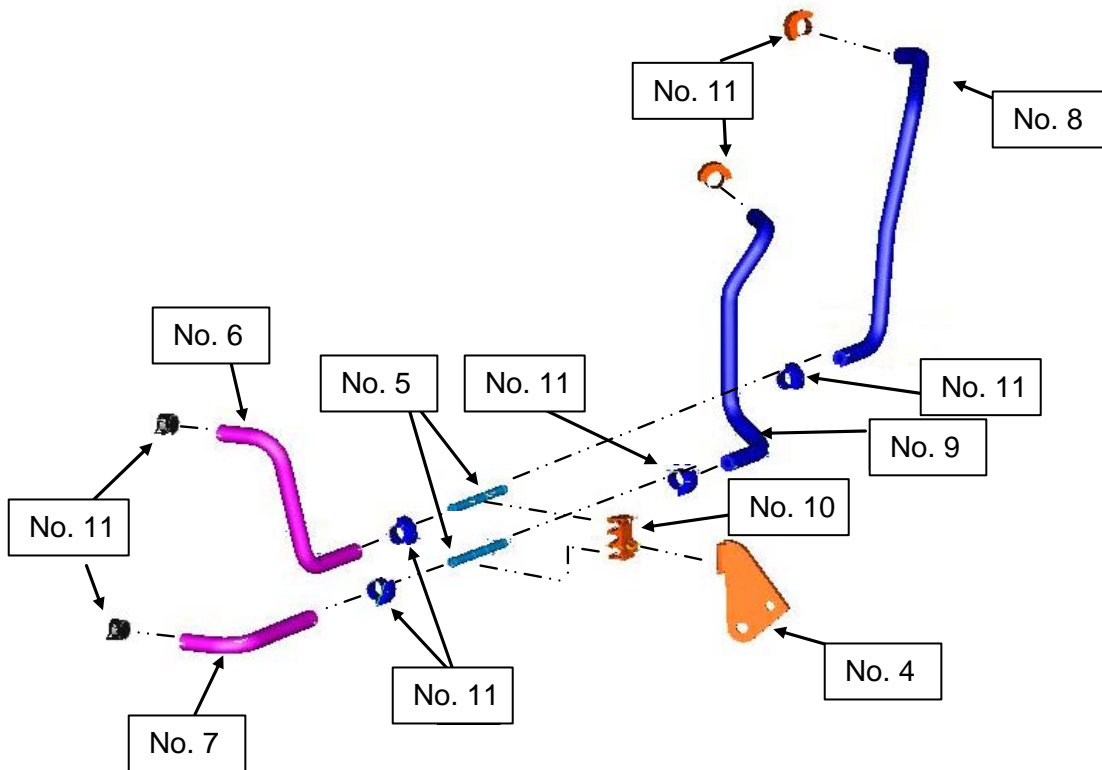

Figure 15

Figure 15 illustrates the COOLER ASSY-AUTO TRANS Hose Assembly referenced in steps 1-3 on page 9.

**NOTE:** Refer to Table A on page 13 for parts descriptions and quantities in the kit.



**NOTE:** Refer to Figure 15 on page 8 for steps 1-3 below.

1. Install hoses (No. 6/7/8/9) to TUBE-OIL COOLER (No. 5) with CLAMP-HOSE (spring clamp No. 11).

- Match the color marks on the hoses and rotate until the marks are aligned (Figure 16).
- Position the spring clamps as close to each fitting bulge as possible and then release them.

**NOTE:** Confirm that the clamps are not on top of a fitting bulge or on an angle.

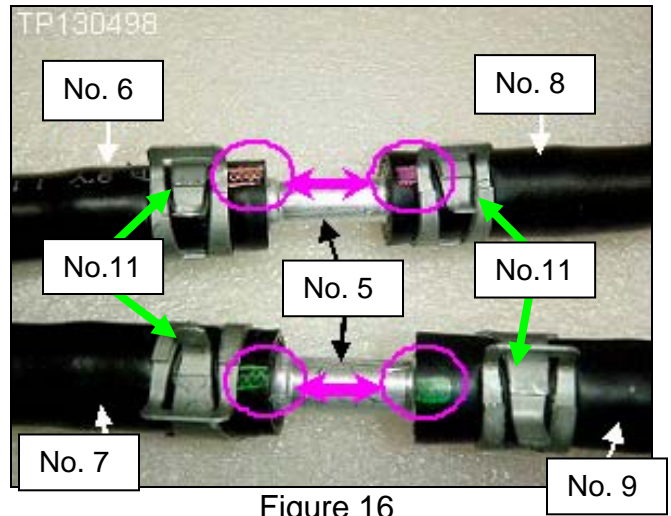

Figure 16

2. Install the CLIP-TUBE (No. 10) to the BRKT ASSY-O/COOLER, SIDE (No.4).

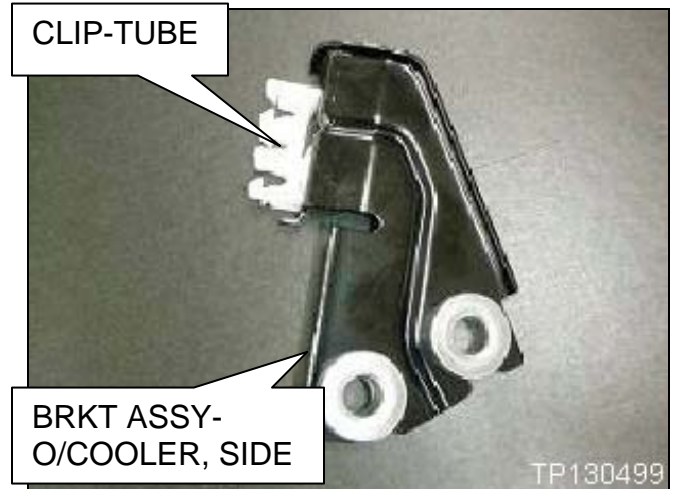

Figure 17

3. Assemble the Hoses to the Bracket.

- Install the pink color coded hose on the top and the green on the bottom of BRKT ASSY-O/COOLER, SIDE (No.4).

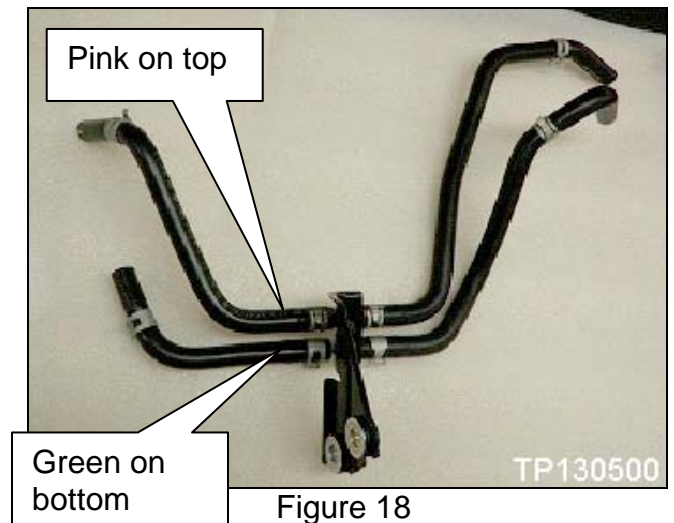

Figure 18

## Install Hose and Bracket assemblies

**NOTE:** Refer to Figure 15 on page 8 and Figure 19 below for steps 1-3 below.

1. Install the assembled HOSE and BRKT onto the vehicle:
  - a. Pass the hoses shown in blue (Figure 19) between the radiator and the bulkhead.
  - b. Install BRKT ASSY-O/COOLER, SIDE (No. 4) with two bolts (No. 14) to the pre-existing weld nuts and torque with the specification provided in Figure 19.

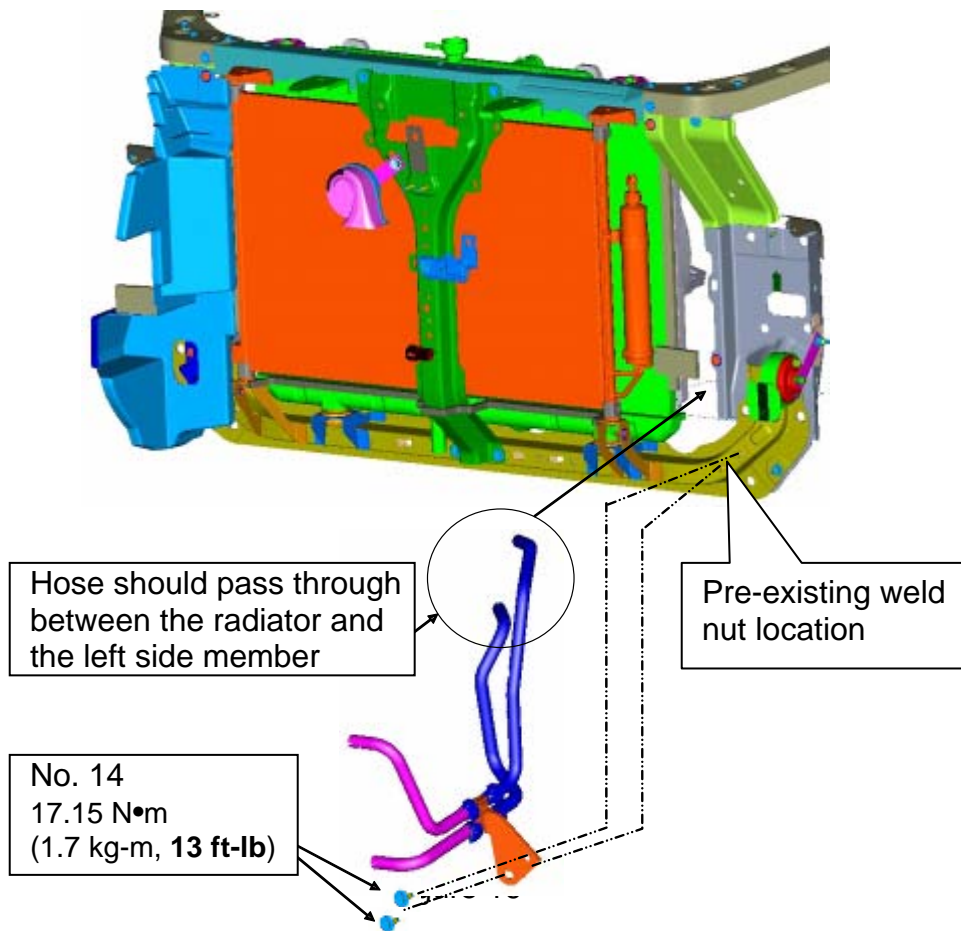

Figure 19

2. Place 2 new CLAMP-HOSE (spring clamp, No. 11) onto the hoses and install the HOSE (No. 6/7, Figure 15) onto COOLER ASSY-AUTO TRANS, OIL (No. 1) with the white paint marks facing toward front of the vehicle (Figure 20).
  - Position the spring clamps as close to each fitting bulge as possible and then release them.

**NOTE:** Confirm that the clamps are not on top of a fitting bulge or on an angle.

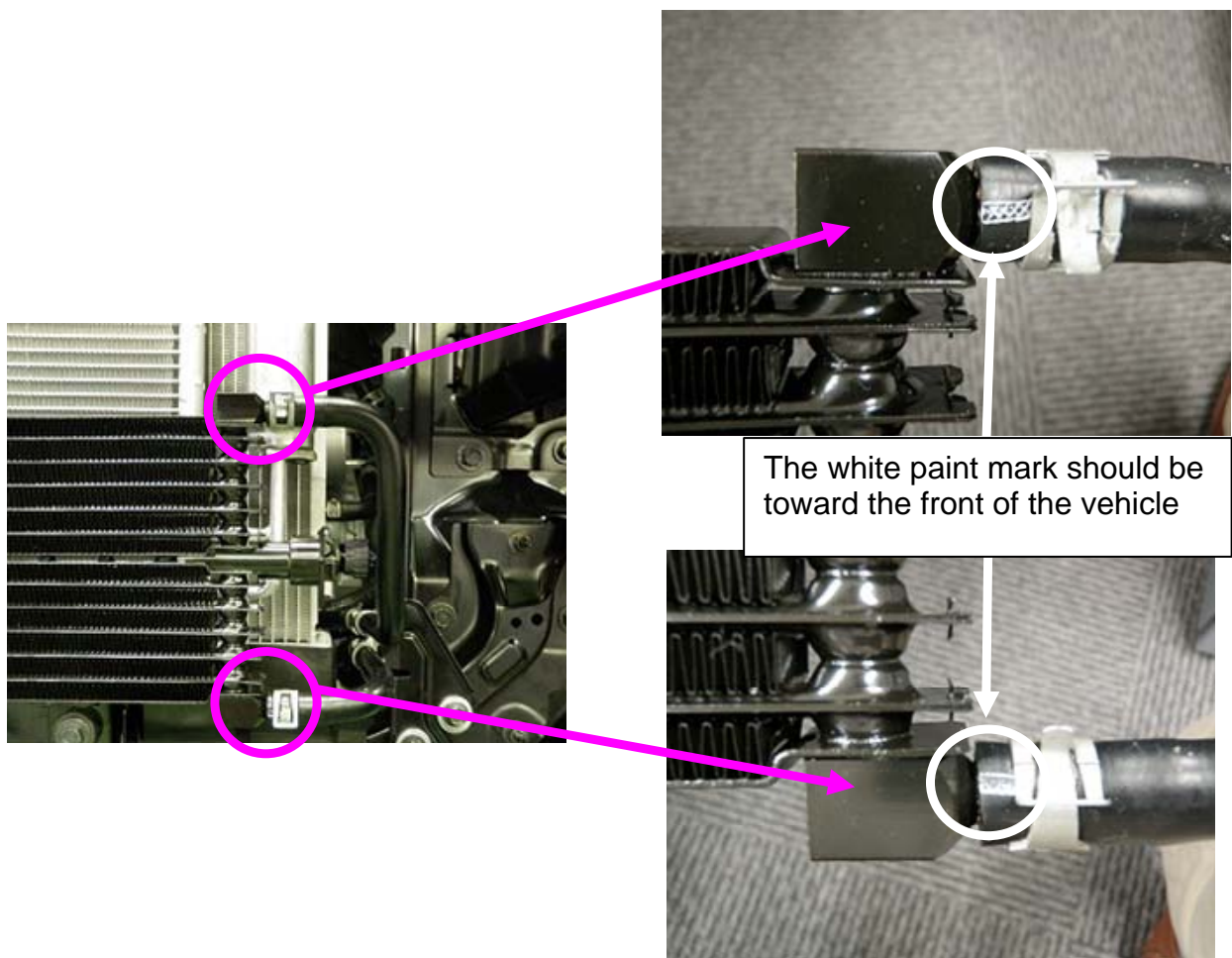

Figure 20

3. Place 2 new CLAMP-HOSE (spring clamp, No. 11) onto the hoses and install the cooler hoses (shown in blue, Figure 21) to the CVT Fluid Cooler.
  - Position the spring clamps as close to each fitting bulge as possible and then release them.

**NOTE:** Confirm that the clamps are not on top of a fitting bulge or on an angle.

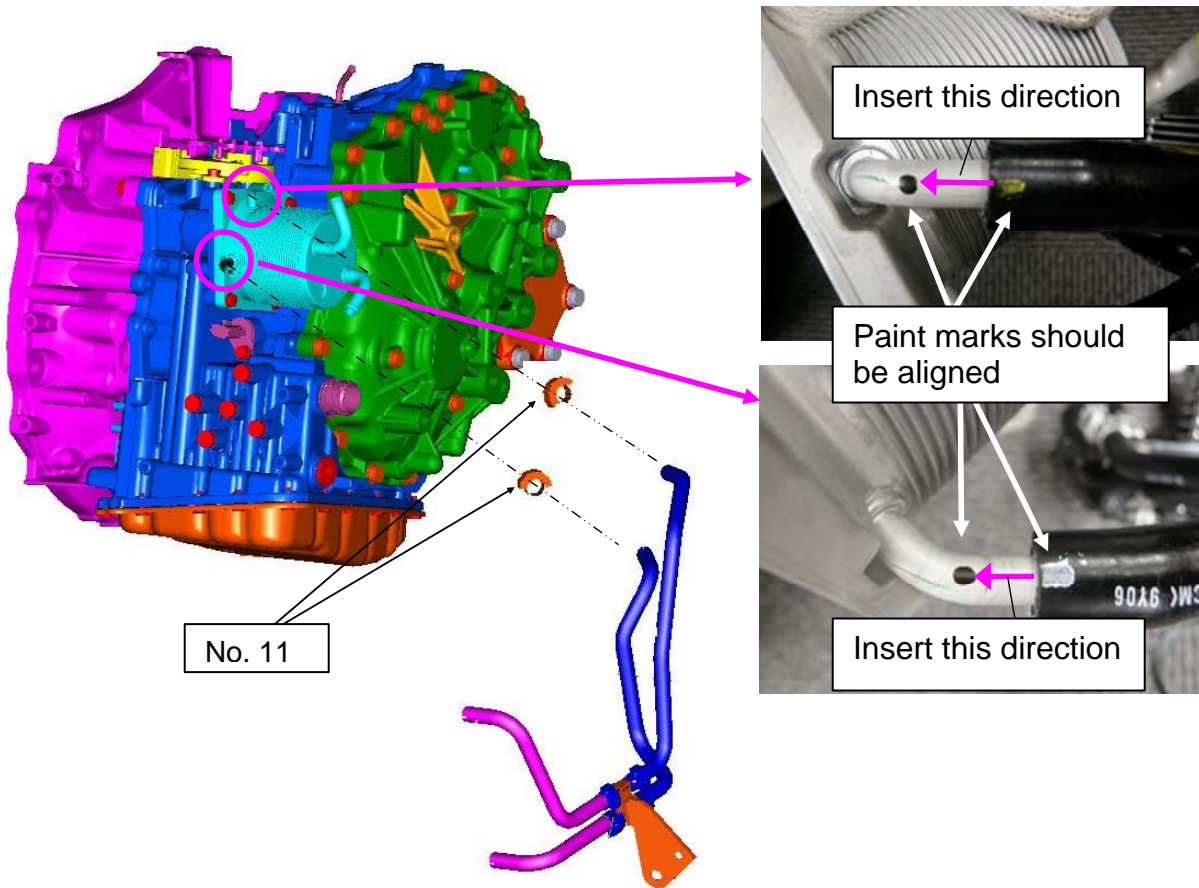

Figure 21

4. Re-install the front Bumper Fascia Assembly, front Under Cover, left front Fender Protector, left Air Guide, and the Air Inlet Duct in the reverse order.
5. Check the level of the coolant and add as needed.
  - Refer to ESM for correct coolant for the model year vehicle that is being worked on.
6. Check the level of the CVT NS-2 Fluid and add as needed.
  - Refer to ESM for correct method to check fluid level for the model year vehicle that is being worked on.



## PARTS INFORMATION

DESCRIPTION	PART #	QUANTITY
SERVICE KIT-COOLER ASSY	B1606-JM01A *	1
NS-2 CVT Fluid	999MP-NS200P **	As needed

\* **This kit is on part restriction.** Order this kit using the order form on the next page.

\*\* Order this item through the Nissan Maintenance Advantage program:  
 Phone: 877-NIS-NMA1 (877-647-6621). Website order via link on dealer portal  
[www.NNAnet.com](http://www.NNAnet.com) and click on the "Maintenance Advantage" link

**Table A**

INDEX	PART NAME	QTY PER KIT
1	COOLER ASSY-AUTO TRANS OIL (air-to-ATF cooler)	1
2	BRKT ASSY-O/COOLER, UPR	1
3	BRKT ASSY-O/COOLER, LWR	1
4	BRKT ASSY-O/COOLER, SIDE	1
5	TUBE-OIL COOLER	2
6	HOSE-AUTO TRANS, UPR	1
7	HOSE-AUTO TRANS, LWR	1
8	HOSE-AUTO TRANS, UPR (2)	1
9	HOSE-AUTO TRANS, LWR (2)	1
10	CLIP-TUBE (INSULATOR)	1
11	CLAMP-HOSE	8
12	BOLT-HEX,PP W/CON SPW	3
13	BOLT-HEX,PP W/CON SPW	4
14	BOLT-HEX,PP W/CON SPW	2
14a	NUT-HEX,PP W/CON SPW	2
16	NUT-HEX,PP W/CON SPW	2
18	OIL COOLER (CVT mounted heat exchanger with 4 ports)	1
19	OIL COOLER O-RING	1
20	Clip for lower seal	2

## CLAIMS INFORMATION

**Submit a Primary Part (PP) type line claim using the following claims coding:**

DESCRIPTION	PFP	OP CODE	SYM	DIA	FRT
Oil cooler kit installation	(1)	JX15AA	AE	32	1.5

(1) Refer to the electronic parts catalog (FAST) and use the Oil Cooler assembly part number (21606 -\*\*\*\*\*) as the Primary Failed Part (PFP).

**PARTS ORDER FORM**  
**For**  
**Rogue Oil Cooler Repair Kit**

---

---

**INCOMPLETE ORDER FORMS WILL NOT BE PROCESSED**

Dealer Code: \_\_\_\_\_ Order Date: \_\_\_\_\_

Dealership Email Address: \_\_\_\_\_

VIN: \_ \_ \_ \_ \_ \_ \_ \_ \_ \_ \_ \_ \_ \_ \_ \_

- PDC:**
- |                                          |                                                     |
|------------------------------------------|-----------------------------------------------------|
| <input type="checkbox"/> Sacramento PDC  | <input type="checkbox"/> Orlando PDC                |
| <input type="checkbox"/> Los Angeles PDC | <input type="checkbox"/> Chicago PDC                |
| <input type="checkbox"/> Dallas PDC      | <input type="checkbox"/> Greenville PDC             |
| <input type="checkbox"/> Baltimore PDC   | <input type="checkbox"/> Memphis – Olive Branch PDC |
| <input type="checkbox"/> New York PDC    |                                                     |

External Oil cooler kit	Quantity
B1606-JM01A	Per VIN only

Email the completed form to:

[campaign.parts@nissan-usa.com](mailto:campaign.parts@nissan-usa.com)

**NOTE:** This bulletin and Service Procedure is **not** a campaign. For convenience, the above email address is being used to fulfill and expedite this part request.