

# Jeep®

2008

OWNER'S MANUAL

# Wrangler



# TABLE OF CONTENTS

## SECTION

## PAGE

1	INTRODUCTION .....	3	1
2	THINGS TO KNOW BEFORE STARTING YOUR VEHICLE .....	9	2
3	UNDERSTANDING THE FEATURES OF YOUR VEHICLE .....	79	3
4	UNDERSTANDING YOUR INSTRUMENT PANEL .....	201	4
5	STARTING AND OPERATING .....	267	5
6	WHAT TO DO IN EMERGENCIES .....	363	6
7	MAINTAINING YOUR VEHICLE .....	375	7
8	MAINTENANCE SCHEDULES .....	427	8
9	IF YOU NEED CONSUMER ASSISTANCE .....	435	9
10	INDEX .....	445	10



# INTRODUCTION

## CONTENTS

---

■ Introduction . . . . .	4	■ Warnings And Cautions . . . . .	8
■ Rollover Warning . . . . .	5	■ Vehicle Identification Number . . . . .	8
■ How To Use This Manual . . . . .	6	■ Vehicle Modifications/Alterations . . . . .	8

### INTRODUCTION

This is a specialized utility vehicle designed for both on-road and off-road use. It can go places and perform tasks for which conventional two-wheel drive enclosed vehicles were not intended. It handles and maneuvers differently from many passenger cars both on-road and off-road, so take time to become familiar with your vehicle.

**The two-wheel drive utility vehicle was designed for on-road use only. It is not intended for off-road driving or use in other severe conditions suited for a four-wheel drive vehicle.**

Before you start to drive this vehicle, read the Owner's Manual. Be sure you are familiar with all vehicle controls, particularly those used for braking, steering, transmission, and transfer case shifting. Learn how your vehicle handles on different road surfaces. Your driving skills will improve with experience. When driving off-road or

working the vehicle, don't overload the vehicle or expect the vehicle to overcome the natural laws of physics. Always observe federal, state, provincial and local laws wherever you drive.

As with other vehicles of this type, failure to operate this vehicle correctly may result in loss of control or an accident. Refer to "On-Road/Off-Road Driving Tips" in Section 5 of this manual.

This manual has been prepared with the assistance of service and engineering specialists to acquaint you with the operation and maintenance of your vehicle. It is supplemented by a Warranty Information Booklet and various customer-oriented documents. You are urged to read these publications carefully. Following the instructions and recommendations in this manual will help assure safe and enjoyable operation of your vehicle.

**NOTE:** After you read the manual, it should be stored in the vehicle for convenient reference and remain with the vehicle when sold so that the new owner will be aware of all safety warnings.

When it comes to service, remember that your authorized dealer knows your vehicle best, has the factory-trained technicians and genuine MOPAR® parts, and is interested in your satisfaction.

## **ROLLOVER WARNING**

Utility vehicles have a significantly higher rollover rate than other types of vehicles. This vehicle has a higher ground clearance, higher center of gravity, and narrower track than many passenger cars. It is capable of performing better in a wide variety of off-road applications. Driven in an unsafe manner, all vehicles can be caused to go out of control. Because of the higher center of gravity and the narrower track, if this vehicle is out of control it may roll over when some other vehicles may not.



Operating this vehicle at excessive speeds or while intoxicated may result in loss of control, collision with other vehicles or objects, going off the road, or overturning, any of which may lead to serious injury or death. Also, **failure to use standard seat belts** subjects the driver and passengers to a greater risk of being thrown out of an open-body vehicle than out of a closed vehicle in an accident which can result in injury or death.

Although your vehicle may be equipped with a soft top or optional hard top to give the occupants protection from the weather, these tops do not offer structural protection in the event of an accident and do not change the open-body characteristic of the vehicle. Even though your vehicle has a sport bar and side bars for some extra protection, it is a truly open vehicle—there is no structural integrated top and it has low sides and a folding windshield. Many of these vehicles do not have fully enclosed hard doors.

## 6 INTRODUCTION

Do not attempt sharp turns or abrupt maneuvers or other unsafe driving actions that can cause loss of vehicle control. Failure to operate this vehicle safely may result in an accident, rollover of the vehicle and serious injury or death. Because of its open-body construction, your vehicle offers less protection than closed vehicles in the event of an accident.

**Failure to use driver and passenger seat belts** provided is a major cause of severe or fatal injury. In fact, the U.S. government notes that the universal use of existing seat belts could cut the highway death toll by 10,000 or more each year, and could reduce disabling injuries by two million annually. In a rollover crash, an unbelted person is significantly more likely to die than a person wearing a seat belt. Always buckle up.

 <b>WARNING</b>	<b>EVEN WITH ADVANCED AIR BAGS</b>
	<ul style="list-style-type: none"><li>• CHILDREN CAN BE KILLED OR SERIOUSLY INJURED BY THE AIR BAG.</li><li>• THE BACK SEAT IS THE SAFEST PLACE FOR CHILDREN.</li><li>• NEVER PUT A REAR-FACING CHILD SEAT IN THE FRONT.</li><li>• ALWAYS USE SEAT BELTS AND CHILD RESTRAINTS.</li><li>• SEE OWNER'S MANUAL FOR MORE INFORMATION ABOUT AIR BAGS.</li></ul>
<b>MISE EN GARDE</b>	<b>MÊME AVEC DES SACS GONFLABLES PERFECTIONNÉS</b>
<ul style="list-style-type: none"><li>• LES ENFANTS PEUVENT ÊTRE TUÉS OU GRAVEMENT BLESSÉS PAR UN SAC GONFLABLE.</li><li>• LA BANQUETTE ARRIÈRE EST LA PLACE LA PLUS SÉCURITAIRE POUR LES ENFANTS.</li><li>• NE JAMAIS PLACER UN SIÈGE POUR ENFANT ORIENTÉ VERS L'ARRIÈRE À L'AVANT DU VÉHICULE.</li><li>• UTILISEZ TOUJOURS LA CEINTURE DE SÉCURITÉ ET LE SYSTÈME DE RETENUE POUR ENFANT.</li><li>• CONSULTEZ LE GUIDE DE L'AUTOMOBILISTE POUR OBTENIR PLUS DE RENSEIGNEMENTS SUR LES SACS GONFLABLES.</li></ul>	
<b>ADVERTENCIA</b>	<b>AUN CON SISTEMAS AVANZADOS DE BOLSA DE AIRE</b>
<ul style="list-style-type: none"><li>• LA BOLSA DE AIRE PUEDE CAUSAR SERIOS DAÑOS O LA MUERTE A LOS NIÑOS.</li><li>• EL ASIENTO DE ATRÁS ES EL LUGAR MÁS SEGURO PARA LOS NIÑOS.</li><li>• NUNCA PONGA UN ASIENTO DE NIÑO CON LA CARA HACIA ATRÁS EN EL ASIENTO DELANTERO.</li><li>• SIEMPRE USE LOS CINTURONES DE SEGURIDAD Y SISTEMAS DE SEGURIDAD PARA NIÑOS.</li><li>• PARA MÁS INFORMACIÓN SOBRE BOLSA DE AIRE, CONSULTE EL MANUAL DEL PROPIETARIO.</li></ul>	

 <b>WARNING</b>	<b>HIGHER ROLLOVER RISK</b>
	<ul style="list-style-type: none"><li>• AVOID ABRUPT MANEUVERS AND EXCESSIVE SPEED.</li><li>• ALWAYS BUCKLE UP.</li><li>• SEE OWNER'S MANUAL FOR FURTHER INFORMATION.</li></ul>
 <b>MISE EN GARDE</b>	<b>PLUS GRAND RISQUE DE CAPOTAGE</b>
<ul style="list-style-type: none"><li>• ÉVITER LES MANŒUVRES ABRUPTES ET LA VITESSE EXCESSIVE.</li><li>• PORTER TOUJOURS LES CEINTURES DE SÉCURITÉ.</li><li>• CONSULTER LE GUIDE DE L'AUTOMOBILISTE POUR DE PLUS AMPLES RENSEIGNEMENTS.</li></ul>	
<b>ADVERTENCIA</b>	<b>ALTO RIESGO DE VOLCAMIENTO</b>
<ul style="list-style-type: none"><li>• EVITE MANIOBRAS ABRUPTAS Y VELOCIDAD EXCESIVA.</li><li>• USE SIEMPRE EL CINTURON DE SEGURIDAD.</li><li>• PARA MAYOR INFORMACION VER MANUAL DEL PROPIETARIO.</li></ul>	

819128e1





### Rollover Warning Label

## HOW TO USE THIS MANUAL

Consult the Table of Contents to determine which section contains the information you desire.

The detailed Index at the back of this manual contains a complete listing of all subjects.

Consult the following table for a description of the symbols that may be used on your vehicle or throughout this Owner's Manual.

											<b>ESP BAS</b> ELECTRONIC STABILITY PROGRAM / BRAKE ASSIST SYSTEM
											
										<b>AWD!</b>	
										<b>4WD!</b>	<b>BRAKE</b> BRAKE SYSTEM WARNING BRAKE
											<b>TOW/HAUL</b> TOW / HAUL
											<b>4 LOW</b> FOUR WHEEL DRIVE LOW
			<b>SRS AIRBAG</b> SUPPLEMENTAL RESTRAINT SYSTEM								

8191e970



## WARNINGS AND CAUTIONS

This Owner's Manual contains **WARNINGS** against operating procedures that could result in an accident or bodily injury. It also contains **CAUTIONS** against procedures that could result in damage to your vehicle. If you do not read this entire manual, you may miss important information. Observe all Warnings and Cautions.

## VEHICLE IDENTIFICATION NUMBER

The Vehicle Identification Number (VIN) is found on a stamped plate located on the left front corner of the instrument panel pad, visible from outside of the vehicle through the windshield. This number also appears on the Automobile Information Disclosure Label affixed to a window on your vehicle. Save this label for a convenient record of your vehicle identification number and optional equipment.

**NOTE:** It is illegal to remove the VIN plate.

## VEHICLE MODIFICATIONS/ALTERATIONS

### WARNING!

**Any modifications or alterations to this vehicle could seriously affect its roadworthiness and safety and may lead to an accident resulting in serious injury or death.**

# THINGS TO KNOW BEFORE STARTING YOUR VEHICLE

## CONTENTS

■ A Word About Your Keys . . . . .	12	□ General Information . . . . .	17
□ Ignition Key Removal . . . . .	12	■ Security Alarm System — If Equipped . . . . .	18
□ Key-In-Ignition Reminder . . . . .	14	□ To Set The Alarm . . . . .	18
■ Steering Wheel Lock . . . . .	14	□ To Disarm The System . . . . .	18
□ To Manually Lock The Steering Wheel . . . . .	14	■ Illuminated Entry . . . . .	19
□ To Release The Steering Wheel Lock . . . . .	14	■ Remote Keyless Entry — If Equipped . . . . .	19
■ Sentry Key® . . . . .	14	□ To Unlock The Doors And Swing Gate . . . . .	20
□ Replacement Keys . . . . .	16	□ To Lock The Doors And Swing Gate . . . . .	20
□ Customer Key Programming . . . . .	16	□ Using The Panic Alarm . . . . .	21

## 10 THINGS TO KNOW BEFORE STARTING YOUR VEHICLE

- To Turn Off “Flash Lights With Lock” . . . . .21
- Programming Additional Transmitters . . . . .22
- General Information . . . . .23
- Battery Replacement . . . . .24
- Remote Starting System — If Equipped . . . . .25
- Doors . . . . .26
  - Upper Half Door Window Removal (If Equipped) . . . . .27
  - Upper Half Door Window Installation (If Equipped) . . . . .27
  - Front Door Removal . . . . .28
  - Rear Door Removal (Four-Door Models) . . . . .29
- Door Locks . . . . .31
  - Manual Door Locks . . . . .32
  - Power Door Locks — If Equipped . . . . .33
  - Automatic Unlock Doors On Exit . . . . .34
  - Automatic Door Locks . . . . .35
- Windows . . . . .36
  - Power Windows — If Equipped . . . . .36
  - Rear Power Windows (Four-Door Models Only) . . . . .37
  - Wind Buffeting . . . . .38
- Rear Swing Gate . . . . .38
- Occupant Restraints . . . . .40
  - Lap/Shoulder Belts . . . . .41
  - Rear Center Lap/Shoulder Belt Retractor Lock-Out (Four-Door Models Only) . . . . .46
  - Adjustable Upper Shoulder Belt Anchorage . . . . .47

- Seat Belt Pretensioners . . . . .48
- Enhanced Seat Belt Use Reminder System (BeltAlert®) . . . . .49
- Seat Belts And Pregnant Women . . . . .50
- Seat Belt Extender . . . . .50
- Driver And Front Passenger Supplemental Restraint Systems (SRS) . . . . .51
- Child Restraint . . . . .62

- Engine Break-In Recommendations . . . . .75
- Safety Tips . . . . .75
  - Exhaust Gas . . . . .75
  - Safety Checks You Should Make Inside The Vehicle . . . . .76
  - Safety Checks You Should Make Outside The Vehicle . . . . .77

## A WORD ABOUT YOUR KEYS

The keys for your new vehicle are enclosed in a plastic bag with the key code number on it. If you received your keys without the bag, ask your authorized dealer to give you the number. The key code can also be obtained by your authorized dealer from your vehicle invoice.

### Ignition Key Removal

#### Manual Transmission — If Equipped

1. Turn the ignition switch to the ACCESSORY (ACC) position.

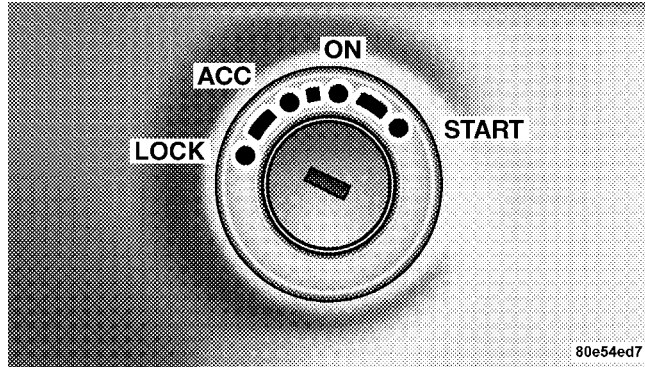

#### Ignition Key Positions

2. Push the ignition key inward.
3. Turn the ignition key to the LOCK position, and remove the key.

**Automatic Transmission — If Equipped**

1. Place the shift lever in the PARK position.
2. Turn the ignition switch to the ACC position.

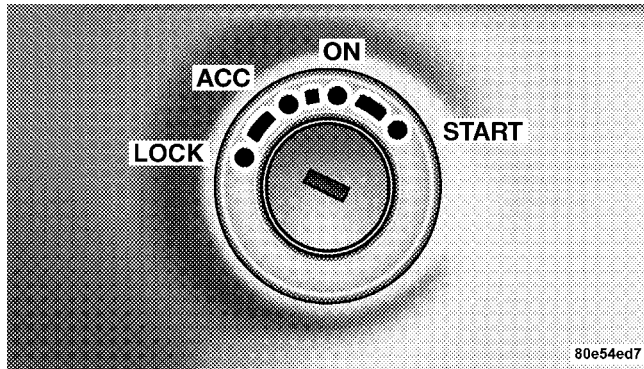

Ignition Key Positions

3. Push the ignition key inward.

4. Turn the ignition key to the LOCK position, and remove the key.

**WARNING!**

Leaving unattended children in a vehicle is dangerous for a number of reasons. A child or others could be injured. Children should be warned not to touch the parking brake, brake pedal, or the shift lever. Do not leave the key in the ignition. A child could operate power windows, other controls, or move the vehicle.

**CAUTION!**

An unlocked vehicle is an invitation to thieves. Always remove the key from the ignition, and lock all doors when leaving the vehicle unattended.

### **Key-In-Ignition Reminder**

Opening the driver's door when the key is in the ignition, sounds a signal to remind you to remove the key.

### **STEERING WHEEL LOCK**

Your vehicle is equipped with a passive steering wheel lock. This lock prevents steering the vehicle without the ignition key. If the steering wheel is moved a half turn in either direction, and the key is not in the ignition, the steering wheel will lock.

### **To Manually Lock the Steering Wheel**

With the engine running, rotate the steering wheel one-half revolution from the straight ahead position, turn off the engine, and remove the key. Rotate the steering wheel slightly in both directions until the lock engages.

### **To Release the Steering Wheel Lock**

Insert the key in the ignition, and turn the wheel slightly to the left or right, to disengage the lock.

**NOTE:** If you turned the wheel to the right to engage the lock, you must turn the wheel slightly to the right to disengage it. If you turned the wheel to the left to engage the lock, turn the wheel slightly to the left to disengage it.

### **SENTRY KEY®**

The Sentry Key® Immobilizer System prevents unauthorized vehicle operation by disabling the engine. The system does not need to be armed or activated. Operation is automatic, regardless of whether the vehicle is locked or unlocked.

The system uses ignition keys that have an embedded electronic chip (transponder) to prevent unauthorized vehicle operation. Therefore, only keys that are programmed to the vehicle can be used to start and operate

the vehicle. The system will shut the engine off in two seconds if someone uses an invalid key to try to start the engine.

**NOTE:** A key that has not been programmed is also considered an invalid key, even if it is cut to fit the ignition switch lock cylinder for that vehicle.

During normal operation, after turning on the ignition switch, the Vehicle Security Alarm Indicator Light will turn on for three seconds for a bulb check. If the light remains on after the bulb check, it indicates that there is a problem with the electronics. In addition, if the light begins to flash after the bulb check, it indicates that someone used an invalid key to try to start the engine. Either of these conditions will result in the engine being shut off after two seconds.

If the Vehicle Security Alarm Indicator Light turns on during normal vehicle operation (vehicle running for

longer than 10 seconds), it indicates that there is a fault in the electronics. Should this occur, have the vehicle serviced as soon as possible.

**NOTE:**

- The Sentry Key® Immobilizer System is not compatible with some aftermarket remote starting systems. Use of these systems may result in vehicle starting problems and loss of security protection.
- Exxon/Mobil Speedpass™, additional Sentry Keys®, or any other transponder-equipped components on the same key chain will **not** cause a key-related (transponder) fault unless the additional part is **physically held against the ignition key** being used when starting the vehicle. Cell phones, pagers, or other RF electronics will not cause interference with this system.

All of the keys provided with your new vehicle have been programmed to the vehicle electronics.



## Replacement Keys

**NOTE:** Only keys that are programmed to the vehicle electronics can be used to start and operate the vehicle. Once a Sentry Key® is programmed to a vehicle, it cannot be programmed to any other vehicle.

### CAUTION!

**Always remove the Sentry Keys® from the vehicle and lock all doors when leaving the vehicle unattended.**

At the time of purchase, the original owner is provided with a four-digit Personal Identification Number (PIN). Keep the PIN in a secure location. This number is required for authorized dealer replacement of keys. Duplication of keys may be performed at an authorized dealer or by following the customer key programming

procedure. This procedure consists of programming a blank key to the vehicle electronics. A blank key is one that has never been programmed.

**NOTE:** When having the Sentry Key® Immobilizer System serviced, bring all vehicle keys with you to an authorized dealer.

## Customer Key Programming

If you have two valid Sentry Keys®, you can program new Sentry Keys® to the system by performing the following procedure:

1. Cut the additional Sentry Key® Transponder blank(s) to match the ignition switch lock cylinder key code.
2. Insert the first valid key into the ignition switch. Turn the ignition switch to the ON position for at least three seconds, but no longer than 15 seconds. Then, turn the ignition switch to the LOCK position and remove the first key.

3. Insert the second valid key into the ignition switch. Turn the ignition switch to the ON position within 15 seconds. After 10 seconds, a chime will sound. In addition, the Vehicle Security Alarm Indicator Light will begin to flash. Turn the ignition switch to the LOCK position and remove the second key.

4. Insert a blank Sentry Key® into the ignition switch. Turn the ignition switch to the ON position within 60 seconds. After 10 seconds, a single chime will sound. In addition, the Vehicle Security Alarm Indicator Light will stop flashing. To indicate that programming is complete, the Vehicle Security Alarm Indicator Light will turn on again for three seconds and then turn off.

The new Sentry Key® is programmed. **The Remote Keyless Entry (RKE) transmitter will also be programmed during this procedure.**

Repeat this procedure to program up to eight keys. If you do not have a programmed Sentry Key®, contact your authorized dealer for details.

**NOTE:** If a programmed key is lost, see your authorized dealer to have all remaining keys erased from the system's memory. This will prevent the lost key from starting your vehicle. The remaining keys must then be reprogrammed. All vehicle keys must be taken to an authorized dealer at the time of service to be reprogrammed.

### General Information

The Sentry Key® system complies with FCC rules Part 15 and with RSS-210 of Industry Canada. Operation is subject to the following conditions:

- This device may not cause harmful interference.

- This device must accept any interference that may be received, including interference that may cause undesired operation.

### **SECURITY ALARM SYSTEM — IF EQUIPPED**

This system monitors the vehicle doors, swing gate, and ignition for unauthorized operation. When the alarm is activated, the system provides both audible and visible signals. The horn, headlights, and tail lights will sound/flash repeatedly for three minutes. If disturbance is still present (driver's door, passenger door, other doors, ignition) after three minutes, the headlights and tail lights will flash for an additional 15 minutes.

**NOTE:** The Panic and Security alarms are quite different. Please take a moment to activate the Panic and the Security modes to hear the differences in the horn. In case one should go off in the future, you will need to know which mode has been activated in order to deactivate it.

### **To Set the Alarm**

The alarm will set when you use the remote keyless entry (RKE) transmitter to lock the doors and swing gate, or when you use the power door lock switch while the door is open. After all the doors are locked and closed, the Sentry Key®/Security Alarm Indicator Light (located on the instrument cluster) will flash rapidly for about 16 seconds to signal that the system is arming. During this 16-second arming period, opening any door or the swing gate will cancel the arming. If the system successfully arms, the Sentry Key®/Security Alarm Indicator Light will flash at a slower rate to indicate the alarm is set.

### **To Disarm the System**

To disarm the system, you will need to press the UNLOCK button on the RKE transmitter, or turn the ignition key to the ON position. If something has triggered the system in your absence, the horn will sound three times when you unlock the doors. Check the vehicle for tampering.

The Security Alarm System is designed to protect your vehicle; however, you can create conditions where the system will arm unexpectedly. If you remain in the vehicle and lock the doors with the RKE transmitter, once the system is armed (after 16 seconds), when you pull the door handle to exit, the alarm will sound. If this occurs, press the UNLOCK button on the RKE transmitter to disarm the system. You may also accidentally disarm the system by unlocking the driver's door with the key and then locking it. The door will be locked but the Security Alarm will not arm.

### ILLUMINATED ENTRY

The interior lights will come on when you open any door.

The lights will remain on after all of the doors are closed, and then fade to off or they will immediately fade to off once the ignition switch is turned on.

### REMOTE KEYLESS ENTRY — IF EQUIPPED

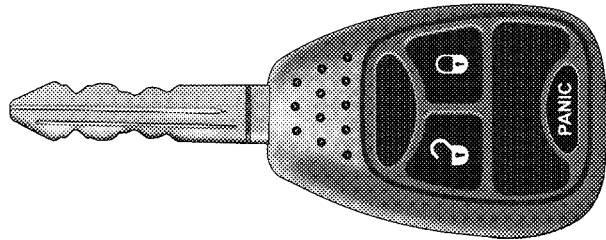

8163e6a8

#### Remote Keyless Entry (Key Fob)

This system allows you to lock or unlock the doors, swing gate, and activate the panic alarm from a maximum distance of 66 ft (20 m) using a hand-held radio transmitter (key fob). The RKE transmitter does not need to be pointed at the vehicle to activate the system.

**NOTE:** The line of transmission must not be blocked with metal objects.

### **To Unlock the Doors and Swing Gate**

Press and release the UNLOCK button once to unlock the driver's door only, or twice to unlock all the doors and swing gate. When the UNLOCK button is pressed, the illuminated entry will initiate and the parking lights will flash twice.

The system can be programmed to unlock all the doors upon the first UNLOCK button press, using the following procedure:

1. Press and hold the LOCK button on a programmed key fob.
2. Continue to hold the LOCK button for at least four seconds, but not longer than 10 seconds, then press and hold the UNLOCK button.
3. Release both buttons at the same time.

4. Test this feature while outside of the vehicle, by pressing the LOCK/UNLOCK button on the key fob.

**NOTE:** Pressing the LOCK button while you are inside of the vehicle will activate the Security Alarm. Opening a door with the Security Alarm activated will cause the alarm to sound. Press the UNLOCK button to deactivate the Security Alarm.

5. If the desired programming was not achieved or to reactivate this feature, repeat the above steps.

### **To Lock the Doors and Swing Gate**

Press and release the LOCK button on the key fob to lock all doors. The turn signals will flash and the horn will chirp once to acknowledge the lock signal. If desired, the "Sound Horn On Lock" feature can be turned on or off using the following steps:

1. Press the LOCK button for 4 to 10 seconds.

2. While the LOCK button is pressed (after four seconds), press the PANIC button. Release both buttons.

The “Sound Horn On Lock” feature can be reactivated by repeating this procedure.

### Using The Panic Alarm

To turn the panic alarm feature ON or OFF, press and hold the PANIC button on the key fob for at least one second and release. When the panic alarm is activated, the headlights and park lights will flash, the horn will pulse on and off and the interior lights will turn on.

The panic alarm will stay on for three minutes unless you turn it off by pressing the PANIC button a second time, or if the vehicle speed is 5 mph (8 km/h) or greater.

**NOTE:** When you turn off the panic alarm by pressing the PANIC button a second time, you may have to be closer to the vehicle due to the radio frequency noises of the system.

### To Turn Off “Flash Lights With Lock”

**NOTE:** The “Flash Lights With Lock” feature can be turned on or off using the following steps:

1. Press the UNLOCK button for 4 to 10 seconds.
2. While the UNLOCK button is pressed, (after four seconds) press the LOCK button. Release both buttons.
3. Test the “Flash Lights With Lock” feature outside of the vehicle, by pressing the LOCK button with the ignition in the LOCK position, and the key removed.

**NOTE:** Pressing the LOCK button, while you are in the vehicle, will activate the Security Alarm. Opening a door with the Security Alarm activated will cause the alarm to sound. Press the UNLOCK button to deactivate the Security Alarm.

The “Flash Lights With Lock” feature can be reactivated by repeating this procedure.

### Programming Additional Transmitters

Vehicles will be shipped from the assembly plants with two key fob transmitters programmed only for that vehicle. A total of eight key fobs can be programmed for your vehicle. Additional key fobs can be programmed to your vehicle through the use of a currently programmed fob.

**NOTE:** When entering the program mode using that key fob, all other programmed key fobs will be erased and you will have to reprogram them for your vehicle.

Use the following procedure to program additional key fobs if the vehicle is not equipped with a Sentry Key:

1. Enter the vehicle and close all of the doors.
2. Fasten your seat belt (Fastening the seat belt will cancel any chiming that may confuse you during this programming procedure).
3. Place the ignition key into the ignition.

4. Turn the ignition to the ON position. **Do not start the engine.**
5. Press and hold the UNLOCK button.
6. After holding the UNLOCK button for four seconds, also press the PANIC button within six seconds.
7. When a single chime is heard, release both buttons. The chime is an indication that you have successfully entered program mode. All key fobs that are to be programmed must be done so within 60 seconds of when the chime was heard.
8. Using the key fob to be programmed, press and release both the LOCK and UNLOCK buttons, simultaneously.
9. A single chime will be heard.
10. Within four seconds of hearing the chime, press and release the UNLOCK button.

11. A single chime will be heard.
12. Repeat steps 8 through 10 to program up to six additional key fobs.
13. Turn the ignition to the OFF position.
14. Your vehicle will remain in program mode up to 60 seconds from when the original chime was heard. After 60 seconds, all programmed key fobs function normally.

**NOTE:** If you do not have a programmed RKE key fob, contact your authorized dealer for details.

### General Information

This device complies with part 15 of FCC rules and with RS-210 of Industry Canada. Operation is subject to the following conditions:

1. This device may not cause harmful interference.

2. This device must accept any interference that may be received including interference that may cause undesired operation.

**NOTE:** Changes or modifications not expressly approved by the party responsible for compliance could void the user's authority to operate the equipment.

If your Remote Keyless Entry fails to operate from a normal distance, check for these two conditions.

1. Weak batteries in the RKE key fob. The expected life of batteries is five years.
2. Closeness to a radio transmitter such as a radio station tower, airport transmitter, military base, and some mobile or CB radios.



## Battery Replacement

The recommended replacement battery is CR2032.

**NOTE:** Perchlorate Material – special handling may apply; See [www.dtsc.ca.gov/hazardouswaste/perchlorate](http://www.dtsc.ca.gov/hazardouswaste/perchlorate).

1. If the key fob is equipped with a screw, remove the screw. With the key fob buttons facing down, use a flat blade (screwdriver) to pry the two halves of the transmitter apart. Use **extreme care** not to damage the seal or internal components.

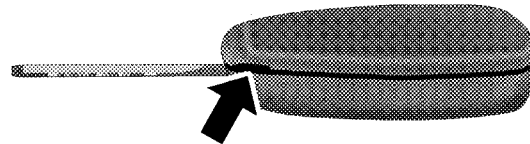

81182c72

### Separating RKE Key Fob Halves

2. Remove and replace the batteries. Avoid touching the new batteries with your fingers. Skin oils may cause battery deterioration. If you touch a battery, clean it with rubbing alcohol.
3. To reassemble the key fob case, snap the two halves together.

**NOTE:** If the key fob is equipped with a screw, reinstall and tighten the screw until snug.

### REMOTE STARTING SYSTEM — IF EQUIPPED

Your vehicle may be equipped with a remote starting system (automatic transmission models only), which will allow the vehicle to be started from distances up to approximately 300 ft (91 m) away from the vehicle using the remote keyless entry key fob which is part of your ignition key.

In order to remote start your vehicle, the hood, swing gate, and all the doors must be closed.

To remote start your vehicle, press the “Remote Start” button on the key fob twice within five seconds. To indicate that the vehicle is about to start, the park lights will flash and the horn will sound briefly (if programmed).

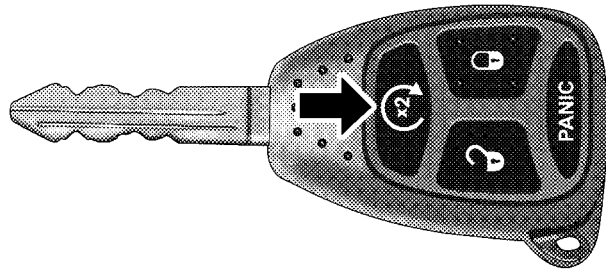

81931ecc

#### Remote Start Key Fob

Once the vehicle has started, the engine will run for 15 minutes. To cancel remote start, press the “Remote Start” button once.

2

The park lamps will remain illuminated to indicate that the vehicle has remote started and the engine is running. The lamps will turn off when the ignition is turned to RUN or the remote start is cancelled.

To enter the vehicle while the engine is running during a remote start, you must first unlock the vehicle using the UNLOCK button on the key fob. Then, prior to the end of the 15 minute cycle, insert the key into the ignition switch and turn the switch to the ON position, otherwise the engine will cancel remote start and automatically turn off.

Remote start will also cancel if any of the following occur:

- If the engine stalls or RPM exceeds 2500
- Any engine warning lamps come on
- The hood is opened
- The hazard switch is pressed

- The transmission is moved out of PARK

The vehicle can be started remotely up to a maximum of two times. The vehicle is also allowed a maximum of one failed start, where the remote start sequence was initiated but the engine stopped cranking without starting. After either of these conditions, or if the Security Alarm is alarming, or if the PANIC button was pressed, the vehicle must be reset by inserting a valid key into the ignition and moving it to the RUN position, then back to LOCK.

### DOORS

The vacuum fluorescent (VF) display located in the odometer area will display the word "door" as an indication of a door ajar or not completely closed. When the vehicle is not moving and the door is ajar or not completely closed, the VF display will show the word "door."

If any other active warnings including “gATE”, “gAS-CAP”, “noFUSE”, “CHANgE OIL”, or “ESPOFF” are present, they will be shown in the VF display and will also continue to cycle. If the vehicle is moving, three single chimes will occur, one chime for each complete display cycle (three cycles total). After this, the display will continue to cycle only (no chimes).

If the trip/reset button is pressed while the VF warnings are being displayed, the VF display will revert back to only displaying the odometer/trip odometer mileage.

### Upper Half Door Window Removal (If Equipped)

1. Grasp the half door window and pull up.

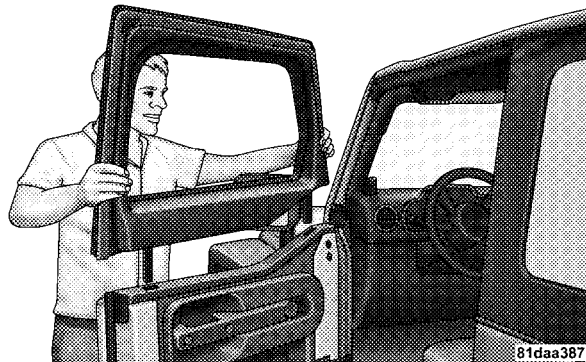

Upper Half Door Window

### Upper Half Door Window Installation (If Equipped)

1. Grasp the half door window and line up pins into pockets in lower door.

2. Push down to ensure the half door window is fully seated.

### Front Door Removal

1. Remove the hinge pin screws from the upper and lower outside hinges (using a #T50 Torx® head driver).

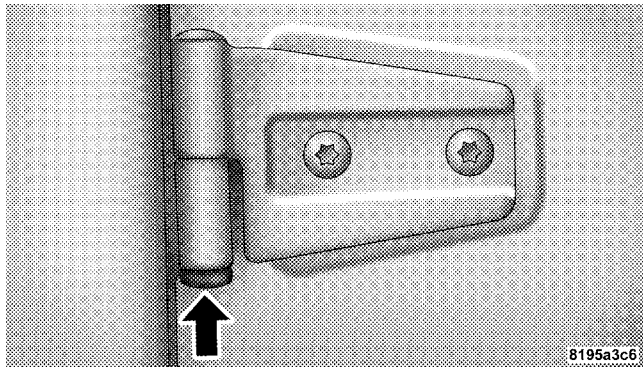

2. Unplug the wiring harness connector under instrument panel.

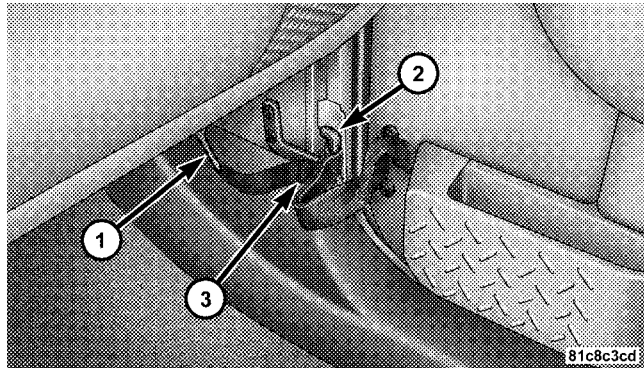

- 1 — Harness Connector
- 2 — Body Hook
- 3 — Door/Harness Strap

3. Unhook the door strap from the body hook. Be careful not to allow the door to swing fully open as the mirror may damage paint.

4. With the door open, lift the door to clear hinge pins from their hinges, and remove door.

To reinstall the door(s), perform the previous steps in the opposite order.

## Rear Door Removal (Four-Door Models)

1. Remove the hinge pin screws from the upper and lower outside hinges (using a #T50 Torx® head driver).

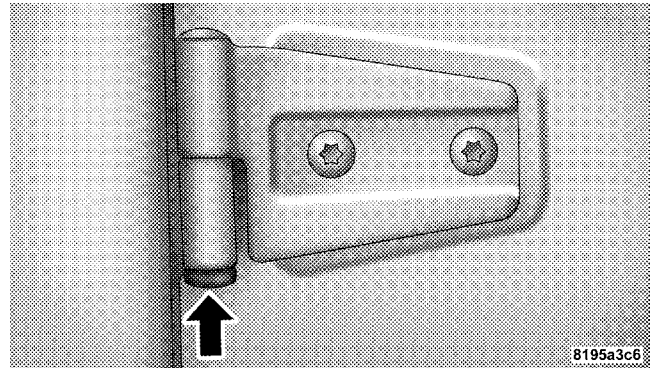

2. Slide the front seat(s) fully forward.

3. Remove the trim access door from the bottom of B-pillar.

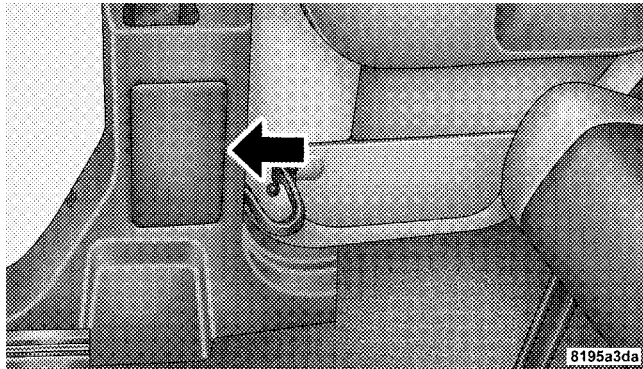

4. Unplug the wiring harness connector.

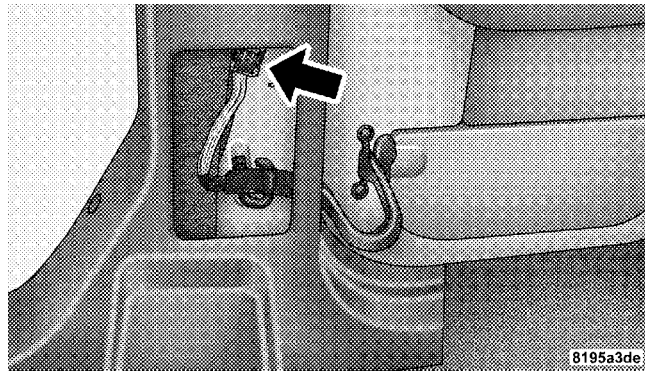

5. Unhook the door strap from the body hook.

6. With the door open, lift the door to clear hinge pins from their hinges, and remove door.

To reinstall the door(s), perform the previous steps in the opposite order.

## DOOR LOCKS

The vacuum fluorescent (VF) display located in the odometer area displays the word “door” as an indication of a door ajar or door not completely closed. When the vehicle is not moving and the door is ajar or not completely closed, the VF display will show the word “door.”

If any other active warnings including “gATE”, “gAS-CAP”, “noFUSE”, “CHANgE OIL”, or “ESPOFF” are present, they will be shown in the VF display and will also continue to cycle. If the vehicle is moving, three single chimes will occur, one chime for each complete display cycle (three cycles total). After this, the display will continue to cycle only (no chimes).

If the trip/reset button is pressed while the VF warnings are being displayed, the VF display will revert back to only displaying the odometer/trip odometer mileage.

**NOTE:** The ignition key that is used to start the vehicle is used to lock or unlock the doors, swing gate, and console storage.



## Manual Door Locks

The front (two-door models) and rear doors (four-door models) are equipped with a rocker-type interior door lock. To lock the door when leaving your vehicle, press the Lock position and close the door.

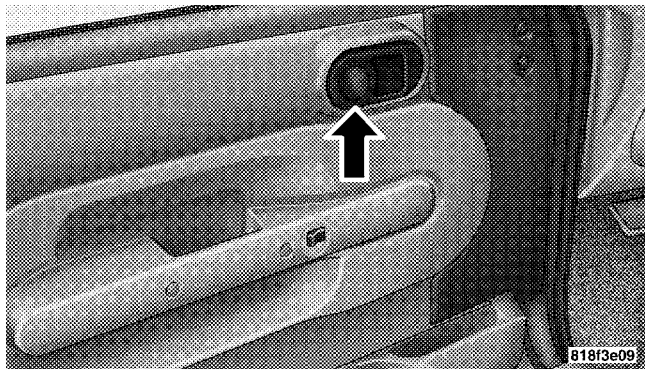

Manual Door Lock

### WARNING!

- For personal security reasons and safety in an accident, lock the vehicle doors when you drive, as well as when you park and leave the vehicle.
- Never leave children alone in a vehicle. Leaving unattended children in a vehicle is dangerous for a number of reasons. A child or others could be seriously or fatally injured. Do not leave the key in the ignition. A child could operate power windows, other controls, or move the vehicle.

### Power Door Locks — If Equipped

The door lock switch is located on each front door panel. Press the switch downward to lock the doors, and upward to unlock the doors.

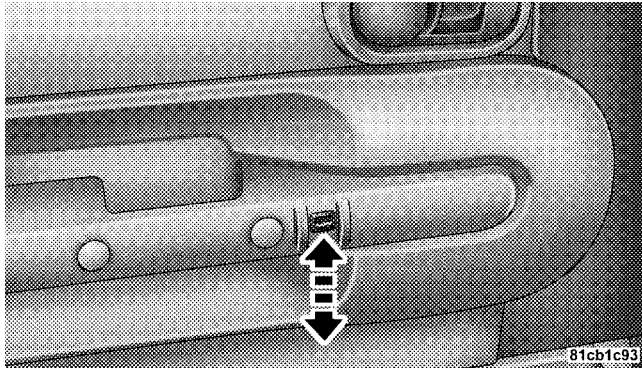

Power Door Lock Switch

### WARNING!

- For personal security reasons and safety in an accident, lock the vehicle doors when you drive, as well as when you park and leave the vehicle.
- Never leave children alone in a vehicle. Leaving unattended children in a vehicle is dangerous for a number of reasons. A child or others could be seriously or fatally injured. Do not leave the key in the ignition. A child could operate power windows, other controls, or move the vehicle.

2

### Automatic Unlock Doors On Exit

The doors will unlock automatically on vehicles with power door locks if:

1. The “Automatic Unlock Doors On Exit” feature is enabled
2. The transmission was in gear and the vehicle speed returned to 0 mph (0 km/h)
3. The transmission is in NEUTRAL or PARK
4. The driver door is opened
5. The doors were not previously unlocked
6. The vehicle speed is 0 mph (0 km/h).

### Automatic Unlock Doors on Exit Programming

The “Automatic Unlock Doors On Exit” feature can be enabled or disabled as follows:

1. Close all doors and place the key in the ignition.
2. Cycle the ignition switch between LOCK and ON and then back to LOCK four times ending up in the LOCK position.
3. Depress the power door unlock switch to unlock the doors.
4. A single chime will indicate the completion of the programming.
5. Repeat these steps if you want to return this feature to its previous setting.

**NOTE:** Use the “Automatic Unlock Doors On Exit” feature in accordance with local laws.

### Automatic Door Locks

The doors will lock automatically on vehicles with power door locks if all of the following conditions are met:

1. The “Automatic Door Locks” feature is enabled
2. The transmission is in gear
3. All doors are closed
4. The throttle is pressed
5. The vehicle speed is above 15 mph (24 km/h)
6. The doors were not previously locked using the power door lock switch or remote keyless entry transmitter.

### Automatic Door Locks Programming

The “Automatic Door Locks” feature can be enabled or disabled as follows:

1. Close all doors and place the key in the ignition.

2. Cycle the ignition switch between LOCK and ON and then back to LOCK four times ending up in the LOCK position.

3. Depress the power door lock switch to lock the doors.

4. A single chime will indicate the completion of the programming.

5. Repeat these steps if you want to return this feature to its previous setting.

**NOTE:** Use the “Automatic Door Locks” feature in accordance with local laws.

## WINDOWS

### Power Windows — If Equipped

The power window switches are located on the instrument panel center stack (below the radio). The top left switch controls the left front window and the top right switch controls the right front window. The lower left switch controls the left rear passenger window (four-door models), and the lower right switch controls the right rear passenger window (four-door models). The switches will continue to function for up to two minutes after the ignition key has been removed, or until a front door is opened.

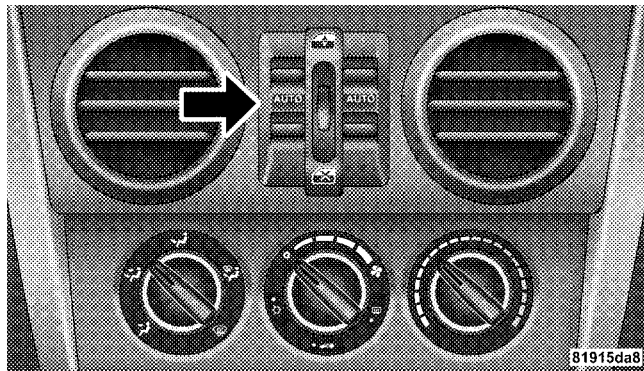

Power Window Switches

### Window Lockout Switch (Four-Door Models Only)

The window lockout switch (located between the window switches) allows you to disable the rear window switches that are located on the back of the center floor

console. To disable the window controls, press the window lockout button downward. To enable the window controls, press the window lockout button upward.

### Auto Down

Both the driver and front passenger window switches have an “Auto Down” feature. Press the window switch past the first detent, release, and the window will go down automatically. To cancel the “Auto Down” movement, operate the switch in either the up or down direction and release the switch.

To stop the window from going all the way down during the “auto down” operation, pull up on the switch briefly.

To open the window part way, press to the first detent and release it when you want the window to stop.

The power window switches remain active for two minutes after the ignition has been turned off. Opening either front door will cancel this feature.

### Rear Power Windows (Four-Door Models Only)

The rear passenger window switches are located on the back of the center floor console.

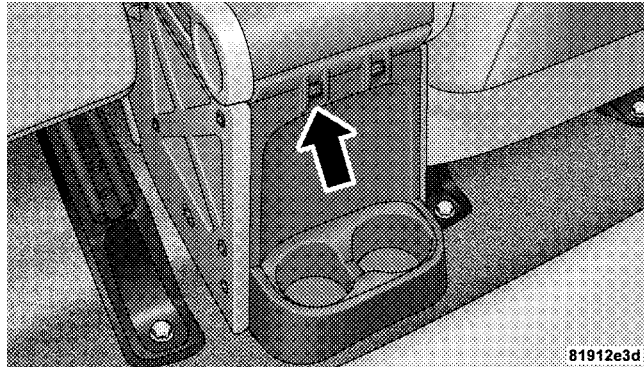

Rear Power Window Switches (Four-Door Models)

## Wind Buffeting

Wind buffeting can be described as the perception of pressure on the ears or a helicopter type sound in the ears. Your vehicle may exhibit wind buffeting with the windows down in certain open or partially open positions. This is a normal occurrence and can be minimized by adjusting window opening.

## REAR SWING GATE

The vacuum fluorescent (VF) display located in the odometer area displays the word "gATE" as an indication of when the swing gate is not completely closed. When the vehicle is not moving, and the swing gate is not completely closed, the VF display will show the word "gATE."

If any other active warnings are present, they will be shown in the VF display and will also continue to cycle. If the vehicle is moving, three single chimes will occur if the rear swing gate is open (one chime for each complete display cycle). After this, the VF display will continue to sequence only (no chimes).

If the trip/reset button is pressed while the VF warnings are being displayed, the VF display will revert back to only displaying the odometer/trip odometer mileage.

The swing gate can be unlocked by using the key, remote keyless entry (RKE) key fob, or by activating the power door lock switches located on the front doors.

To open the swing gate, press the button on the gate handle.

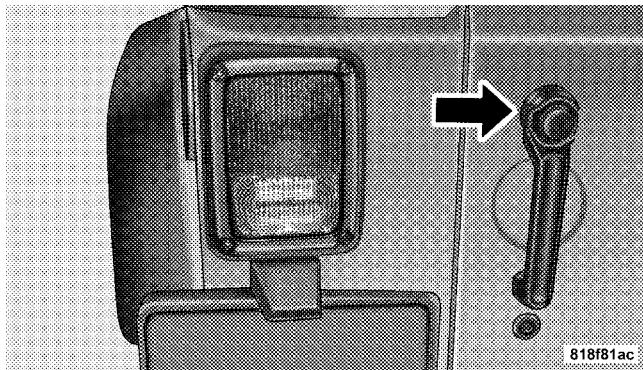

Gate Handle

**NOTE:** Close the rear flip-up window before attempting to close the swing gate (hard top models only).

### CAUTION!

Do not press on rear wiper blade when closing the rear flip-up window, as damage to the blade will result.

2

### WARNING!

Driving with the flip-up window open can allow poisonous exhaust gases into your vehicle. You and your passengers could be injured by these fumes. Keep the flip-up window closed when you are operating the vehicle.



## OCCUPANT RESTRAINTS

Some of the most important safety features in your vehicle are the restraint systems. These include the front and rear seat belts for the driver and all passengers, front airbags for both the driver and front passenger, and side airbags (if equipped) for both the driver and front passenger. If you will be carrying children too small for adult-size belts, your seat belts can also be used to hold infant and child restraint systems.

**NOTE:** The front airbags have a multistage inflator design. This allows the airbag to have different rates of inflation that are based on collision severity.

Please pay close attention to the information in this section. It tells you how to use your restraint system properly to keep you and your passengers as safe as possible.

### WARNING!

**In a collision, you and your passengers can suffer injuries, including fatalities, if you are not properly buckled up. You can strike the interior of your vehicle or other passengers, or you can be thrown out of the vehicle. Always be sure you and others in your vehicle are buckled up properly.**

Buckle up even though you are an excellent driver, even on short trips. Someone on the road may be a poor driver and cause a collision that includes you. This can happen far away from home or on your own street.

Research has shown that seat belts save lives, and that they can reduce the seriousness of injuries in a collision. Some of the worst injuries happen when people are thrown from the vehicle. Seat belts reduce the possibility of ejection and the risk of injury caused by striking the inside of the vehicle. **Everyone** in a motor vehicle should be belted at all times to reduce or prevent injuries.

### Lap/Shoulder Belts

All seating positions in your vehicle have combination lap/shoulder belts. The belt webbing retractor is designed to lock during very sudden stops or collisions. This feature allows the shoulder part of the belt to move freely with you under normal conditions. But in a collision, the belt will lock and reduce the risk of your striking the inside of the vehicle or being thrown out.

### WARNING!

- **It is extremely dangerous to ride in a cargo area, inside or outside of a vehicle. In a collision, people riding in these areas are more likely to be seriously injured or killed.**
- **Do not allow people to ride in any area of your vehicle that is not equipped with seats and seat belts.**
- **Be sure everyone in your vehicle is in a seat using a seat belt properly.**

**WARNING!**

- **Wearing a seat belt incorrectly is dangerous. Seat belts are designed to go around the large bones of your body. These are the strongest parts of your body and take the forces of a collision the best. Wearing your belt in the wrong place could make your injuries in a collision much worse. You might suffer internal injuries, or you could even slide out of part of the belt. Follow these instructions to wear your seat belt safely and to keep your passengers safe, too.**
- **Two people should never be belted into a single seat belt. People belted together can crash into one another in an accident, hurting one another badly. Never use a lap/shoulder belt or a lap belt for more than one person, no matter what their size.**

**Lap/Shoulder Belt Operating Instructions**

1. Enter the vehicle and close the door. Sit back and adjust the seat.
2. The seat belt latch plate is above the back of the front seat, next to your arm in the rear seat. Grasp the latch plate and pull out the belt. Slide the latch plate up the webbing as far as necessary to allow the belt to go around your lap.



3. When the belt is long enough to fit, insert the latch plate into the buckle until you hear a "click."

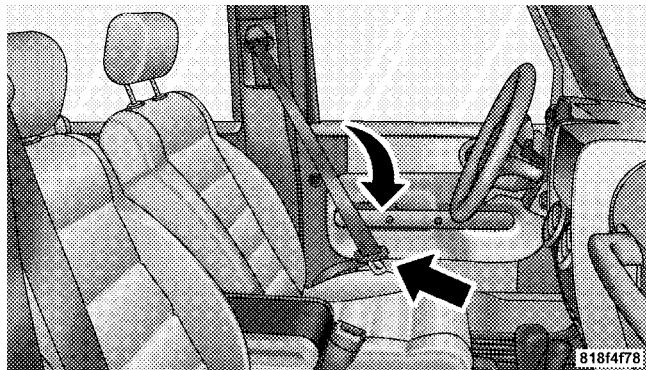

Latch Plate

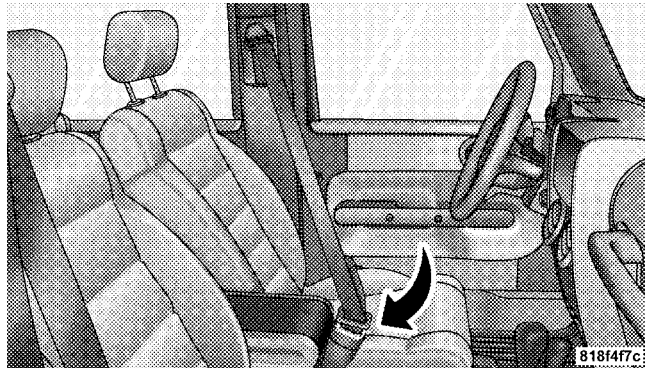

Latch Plate To Buckle

**WARNING!**

**A belt that is buckled into the wrong buckle will not protect you properly. The lap portion could ride too high on your body, possibly causing internal injuries. Always buckle your belt into the buckle nearest you.**

**A belt that is loose will not protect you as well. In a sudden stop you could move too far forward, increasing the possibility of injury. Wear your seat belt snugly.**

**A belt that is worn under your arm is very dangerous. Your body could strike the inside surfaces of the vehicle in a collision, increasing head and neck injury. A belt worn under the arm can cause internal injuries. Ribs aren't as strong as shoulder bones. Wear the belt over your shoulder so that the strongest bones will take the force in a collision.**

**A shoulder belt placed behind will not protect you from injury during a collision. You are more likely to hit your head in a collision if you do not wear your shoulder belt. The lap and shoulder belt are meant to be used together.**

4. Position the lap belt across your thighs, below your abdomen. To remove slack in the lap belt portion, pull up on the shoulder belt. To loosen the lap belt if it is too tight, tilt the latch plate and pull on the lap belt. A snug belt reduces the risk of sliding under the belt in a collision.

**NOTE:** The Seat Belt Indicator Light will remain on until the driver's seat belt is buckled.

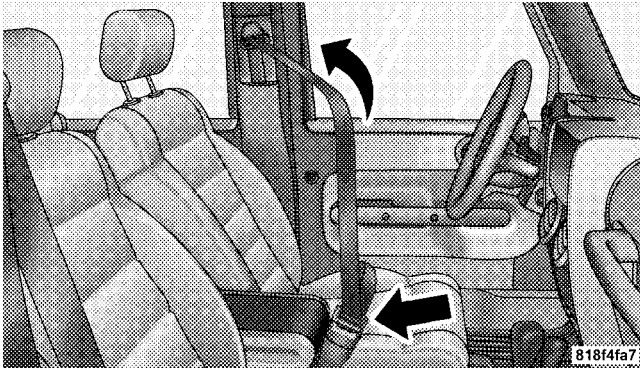

Removing Slack From Belt

### WARNING!

A lap belt worn too high can increase the risk of internal injury in a collision. The belt forces won't be at the strong hip and pelvic bones, but across your abdomen. Always wear the lap belt as low as possible and keep it snug.

A twisted belt cannot do its job as well. In a collision it could even cut into you. Be sure the belt is straight. If you cannot straighten a belt in your vehicle, take it to your authorized dealer and have it fixed.

2

5. Position the shoulder belt on your chest so that it is comfortable and not resting on your neck. The retractor will withdraw any slack in the belt.

6. To release the belt, push the red button on the buckle. The belt will automatically retract to its stowed position. If necessary, slide the latch plate down the webbing to allow the belt to retract fully.

### WARNING!

**A frayed or torn belt could rip apart in a collision and leave you with no protection. Inspect the belt system periodically, checking for cuts, frays, or loose parts. Damaged parts must be replaced immediately. Do not disassemble or modify the system. Seat belt assemblies must be replaced after a collision if they have been damaged (bent retractor, torn webbing, etc.).**

### Rear Center Lap/Shoulder Belt Retractor Lock-Out (Four-Door Models Only)

This feature is designed to lock the retractor whenever the 60% rear seatback is not fully latched. This prevents someone from wearing the rear center lap/shoulder belt when the rear seatback is not fully latched.

#### NOTE:

- If the rear center lap/shoulder belt cannot be pulled out, check that the rear seatback is fully latched.
- If the rear seatback is properly latched and the rear center lap/shoulder belt still cannot be pulled out, the Automatic-Locking Retractor (ALR) system may be activated. To reset this feature you must let all of the belt webbing return into the retractor. You will not be able to pull out more webbing until all of the webbing has been returned back into the retractor.

**WARNING!**

The rear center lap/shoulder belt is equipped with a lock-out feature to ensure that the rear seatback is in the fully upright and locked position when occupied. If the rear seatback is not fully upright and locked and the rear center lap/shoulder belt can be pulled out of the retractor, the vehicle should immediately be taken to your authorized dealer for service. Failure to follow this warning could result in serious or fatal injury.

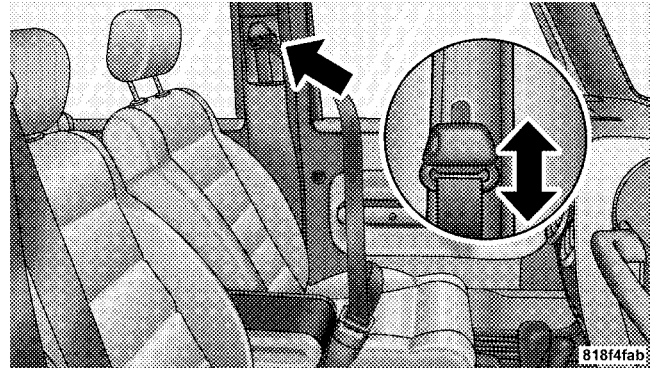

Adjusting Upper Shoulder Belt

**Adjustable Upper Shoulder Belt Anchorage**

In the front seat positions, the shoulder belt anchorage can be adjusted upward or downward to position the belt away from your neck. Push in on the anchorage near your outside shoulder and slide it up or down to reach the position that serves you best.



**WARNING!**

**Position the shoulder belt height adjusters so that the belt rests across the middle of your shoulder. Failure to adjust the safety belt properly could reduce the effectiveness of the seat belt and increase the risk of injury in a collision.**

As a guide, if you are shorter than average, you will prefer a lower position, and if you are taller than average, you'll prefer a higher position. When you release the anchorage, try to move it up or down to make sure that it is locked in position.

**Seat Belt Pretensioners**

The driver and front passenger seat belts are equipped with a pretensioning device that is designed to remove any slack from the seat belt systems in the event of a collision. This device improves the performance of the seat belt by assuring that the belt is tight around the occupant early in a collision. Pretensioners work for all size occupants, including those in child restraints.

**NOTE:** These devices are not a substitute for proper seat belt placement by the occupant. The seat belt must still be worn snugly and positioned properly.

The pretensioners are triggered by the Occupant Restraint Control (ORC) Module. Like the front airbags, the pretensioners are a single use item. After a collision that is severe enough to deploy the airbags and pretensioners, they must be replaced.

## Enhanced Seat Belt Use Reminder System (BeltAlert®)

If the driver's seat belt has not been buckled within 60 seconds of starting the vehicle and if the vehicle speed is greater than 5 mph (8 km/h), the Enhanced Warning System (BeltAlert®) will alert the driver to buckle the seat belt. The driver should also instruct all other occupants to buckle their seat belts. Once the warning is triggered, the Enhanced Warning System (BeltAlert®) will continue to chime and flash the Seat Belt Warning Light for 96 seconds or until the driver's seat belt is buckled.

The Enhanced Warning System (BeltAlert®) will be reactivated if the driver's seat belt is unbuckled for more than 10 seconds and the vehicle speed is greater than 5 mph (8 km/h).

The Enhanced Warning System (BeltAlert®) can be enabled or disabled by your authorized dealer or by following these steps:

**NOTE:** The following steps must occur within the first 60 seconds of the ignition switch being turned to the ON or START position. The manufacturer does not recommend deactivating the Enhanced Warning System (BeltAlert®).

1. Turn the ignition switch to the OFF position, and buckle the driver's seat belt.
2. Turn the ignition key to the ACC/RUN position (engine does not need to be running), and wait for the Seat Belt Warning Light to turn off.
3. Within 60 seconds of starting the vehicle, unbuckle and then re-buckle the driver's seat belt at least three times within 10 seconds, ending with the seat belt buckled.
4. Turn the ignition key to the OFF position. A single chime will sound to signify that you have successfully completed the programming.

The Enhanced Warning System (BeltAlert®) can be reactivated by repeating this procedure.

**NOTE:** Although the Enhanced Warning System (BeltAlert®) has been deactivated, the Seat Belt Warning Light will continue to illuminate while the driver's seat belt remains unfastened.

### **Seat Belts And Pregnant Women**

We recommend that pregnant women use seat belts throughout their pregnancy. Keeping the mother safe is the best way to keep the baby safe.

Pregnant women should wear the lap part of the belt across the thighs and as snug across the hips as possible. Keep the belt low so that it does not come across the abdomen. That way the strong bones of the hips will take the force if there is a collision.

### **Seat Belt Extender**

If a seat belt is too short, even when fully extended and when the adjustable upper shoulder belt anchorage (if equipped) is in its lowest position, your authorized dealer can provide you with a seat belt extender. This extender should be used only if the existing belt is not long enough. When it is not required, remove the extender and store it.

#### **WARNING!**

**Using a seat belt extender when not needed can increase the risk of injury in a collision. Only use when the seat belt is not long enough when it is worn low and snug, and in the recommended seating positions. Remove and stow the seat belt extender when not needed.**

## Driver And Front Passenger Supplemental Restraint Systems (SRS)

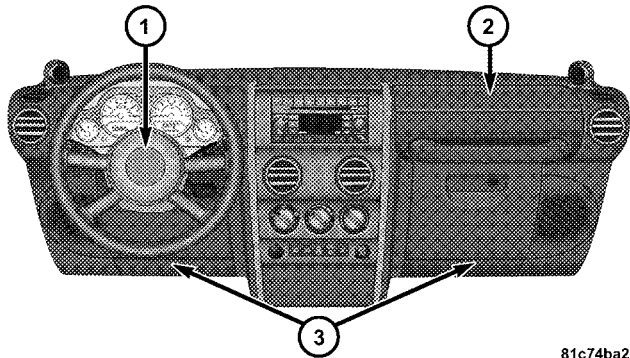

81c74ba2

- 1 — Driver Airbag
- 2 — Passenger Airbag
- 3 — Knee Bolster

This vehicle has airbags for both the driver and right front passenger as a supplement to the seat belt restraint systems. The driver's front airbag is mounted in the steering wheel. The front passenger airbag is mounted in the instrument panel, above the glove compartment. The letters SRS are embossed on the airbag covers.

**NOTE:** The front airbags are certified to the Federal regulations that allow less forceful deployment.

The front airbags have a multistage inflator design. This may allow the airbag to have different rates of inflation that are based on collision severity.

If the vehicle is equipped with side airbags, they are located inside the driver and front passenger seats, and their covers are also labeled SRS.

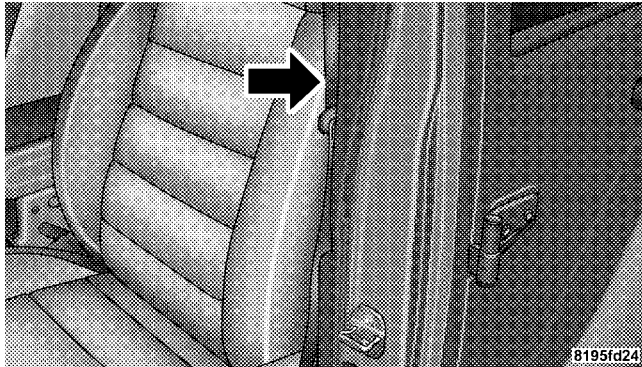

Side Airbag Location

**NOTE:** Airbag covers may not be obvious in the interior trim; but they will open to allow airbag deployment.

### WARNING!

- Do not put anything on or around the front airbag covers or attempt to manually open them. You may damage the airbags and you could be injured because the airbags are no longer functional. These protective covers for the airbag cushions are designed to open only when the airbags are inflating.
- If your vehicle is equipped with side airbags, do not use accessory seat covers or place objects between you and the side airbags; the performance could be adversely affected and/or objects could be pushed into you, causing serious injury.
- If your vehicle is equipped with side airbags, do not attach cup holders or any other objects on or around the door. The inflating side airbag could drive the objects into occupants, causing serious injury.
- Do not cover or place items on the airbag covers. These items may cause serious injury during inflation.
- Do not store or place items under the front seats. You may damage the airbag wiring harnesses.

The front airbags have a multistage inflator design. This allows the airbag to have different rates of inflation that are based on collision severity. Along with the seat belts, front airbags work with the instrument panel knee bolsters to provide improved protection for the driver and front passenger. Side airbags also work with seat belts to improve occupant protection.

The seat belts are designed to protect you in many types of collisions. The front airbags deploy in moderate to severe frontal collisions.

If your vehicle is so equipped, the side airbag on the crash side of the vehicle is triggered in moderate to severe side collisions. In certain types of collisions, both the front and side airbags may be triggered. But even in collisions where the airbags work, you need the seat belts to keep you in the right position for the airbags to protect you properly.

Here are some simple steps you can take to minimize the risk of harm from a deploying airbag.

1. Children 12 years and under should always ride buckled up in a rear seat.

2

Infants in rear facing child restraints should **NEVER** ride in the front seat of a vehicle with a passenger airbag. An airbag deployment could cause severe injury or death to infants in that position.

Children that are not big enough to properly wear the vehicle seat belt should be secured in the rear seat, in a child restraint or belt-positioning booster seat. Older children who do not use child restraints or belt-positioning booster seats should ride properly buckled up in the rear seat. Never allow children to slide the shoulder belt behind them or under their arm.

If a child from 1 to 12 years old must ride in the front passenger seat because the vehicle is crowded, move the

seat as far back as possible, and use the proper child restraint. Refer to “Child Restraint” in this section.

You should read the instructions provided with your child restraint to make sure that you are using it properly.

2. All occupants should use their lap and shoulder belts properly.

3. The driver and front passenger seats should be moved back as far as practical to allow the front airbags room to inflate.

4. If your vehicle has side airbags, do not lean against the door, airbags will inflate forcefully into the space between you and the door.

5. If the airbag system in this vehicle needs to be modified to accommodate a disabled person, contact the Customer Center. Phone numbers are provided under “If You Need Assistance” in Section 9 of this manual.

**WARNING!**

- **Relying on the airbags alone could lead to more severe injuries in a collision. The airbags work with your seat belt to restrain you properly. In some collisions the airbags won't deploy at all. Always wear your seat belts even though you have airbags.**
- **Being too close to the steering wheel or instrument panel during airbag deployment could cause serious injury. Airbags need room to inflate. Sit back, comfortably extending your arms to reach the steering wheel or instrument panel.**
- **If the vehicle has side airbags, they also need room to inflate. Do not lean against the door. Sit upright in the center of the seat.**

## Airbag System Components

The airbag system consists of the following:

- Occupant Restraint Control (ORC) Module
- Airbag Warning Light
- Driver Airbag
- Passenger Airbag
- Front Seat-Mounted Side Airbags (If Equipped)
- Steering Wheel and Column
- Instrument Panel
- Interconnecting Wiring
- Knee Impact Bolsters
- Front Acceleration Sensors
- Remote Side Impact Acceleration Sensors (If Equipped)

- Driver Seat Track Position Sensors
- Driver and Front Passenger Seat Belt Pretensioner

## How The Airbag System Works

- The **Occupant Restraint Control (ORC) Module** determines if a frontal or side collision is severe enough to require the front and/or side airbags to inflate. The front airbag inflators are designed to provide different rates of airbag inflation from direction provided by the ORC.

The ORC also monitors the readiness of the electronic parts of the system whenever the ignition switch is in the START or ON positions. These include all of the items listed above except the knee bolster, the instrument panel, and the steering wheel and column. If the key is in the LOCK position, in the ACC position, or not in the ignition, the airbags are not on and will not inflate.





Also, the ORC turns on the Airbag Warning Light for six to eight seconds for a self-check when the ignition is first turned on. After the self-check, the Airbag Warning Light will turn off. If the ORC detects a malfunction in any part of the system, it turns on the Airbag Warning Light either momentarily or continuously. A single chime will sound if the light comes on again after initial start up.

### WARNING!

**Ignoring the Airbag Warning Light in your instrument panel could mean you won't have the airbags to protect you in a collision. If the light does not come on, stays on after you start the vehicle, or if it comes on as you drive, have the airbag system checked immediately.**

- The **Driver and Passenger Airbag/Inflator Units** are located in the center of the steering wheel and the right side of the instrument panel. When the ORC detects a collision requiring the airbags, it signals the inflator units. A large quantity of nontoxic gas is generated to inflate the front airbags. Different airbag inflation rates are possible, based on collision severity. The steering wheel hub trim cover and the upper right side of the instrument panel separate and fold out of the way as the bags inflate to their full size. The bags fully inflate in about 50 to 70 milliseconds. This is about half of the time it takes to blink your eyes. The bags then quickly deflate while helping to restrain the driver and front passenger.

The driver front airbag gas is vented through the vent holes in the sides of the airbag. The passenger front airbag gas is vented through the vent holes in the sides of the airbag. In this way, the airbags do not interfere with your control of the vehicle.

- The **Side Impact (SRS) Seat-Mounted Side Airbags (If Equipped)** are designed to activate only in certain side collisions.

The ORC determines if a side collision is severe enough to require the side airbags to inflate.

The ORC monitors the readiness of the electronic parts of the system whenever the ignition switch is in the START or ON positions. These include all of the items previously mentioned.

In moderate to severe side collisions, the side airbag inflator on the crash side of the vehicle is triggered, releasing a quantity of nontoxic gas. The inflating side airbag exits through the seat seam into the space between the occupant and the door. The side airbag moves at a very high speed and with such a high force, that it could injure you if you are not seated properly, or if items are positioned in the area where the side airbag inflates. This especially applies to children.

- The **Knee Impact Bolsters** help protect the knees of the driver and the front passenger, and position everyone for the best interaction with the front airbag.

### If A Deployment Occurs

The airbag system is designed to deploy when the Occupant Restraint Control (ORC) Module detects a moderate-to-severe frontal collision, to help restrain the driver and front passenger, and then to immediately deflate.

**NOTE:** A frontal collision that is not severe enough to need airbag protection will not activate the system. This does not mean something is wrong with the airbag system.

If you do have a collision which deploys the airbags, any or all of the following may occur:

- The nylon airbag material may sometimes cause abrasions and/or skin reddening to the driver and front

passenger as the airbags deploy and unfold. The abrasions are similar to friction rope burns or those you might get sliding along a carpet or gymnasium floor. They are not caused by contact with chemicals. They are not permanent and normally heal quickly. However, if you haven't healed significantly within a few days, or if you have any blistering, see your doctor immediately.

- As the airbags deflate you may see some smoke-like particles. The particles are a normal by-product of the process that generates the nontoxic gas used for airbag inflation. These airborne particles may irritate the skin, eyes, nose, or throat. If you have skin or eye irritation, rinse the area with cool water. For nose or throat irritation, move to fresh air. If the irritation continues, see your doctor. If these particles settle on your clothing, follow the garment manufacturer's instructions for cleaning.

- It is not advisable to drive your vehicle after the airbags have deployed. If you are involved in another collision, the airbags will not be in place to protect you.

### **WARNING!**

**Deployed airbags and seat belt pretensioners cannot protect you in another collision. Have the airbags, seat belt pretensioner, and seat belt retractor assembly, replaced by an authorized dealer as soon as possible.**

### Enhanced Accident Response Feature

If the airbags deploy after an impact and the electrical system remains functional, vehicles equipped with power door locks will unlock automatically. The hazard lights will flash and the fuel will be cut off to the engine. In addition, after the vehicle has stopped moving, the interior lights will illuminate to aid visibility and remain lit until the ignition switch is turned off.

**NOTE:** The interior lights can only be deactivated if the key is removed from the ignition switch or the vehicle is driven.

### Maintaining Your Airbag System

#### **WARNING!**

- **Modifications to any part of the airbag system could cause it to fail when you need it. You could be injured if the airbag system is not there to protect you. Do not modify the components or wiring, including adding any kind of badges or stickers to the steering wheel hub trim cover or the upper right side of the instrument panel. Do not modify the front bumper or vehicle body structure.**
- **You need proper knee impact protection in a collision. Do not mount or locate any aftermarket equipment on or behind the knee bolsters.**
- **It is dangerous to try to repair any part of the airbag system yourself. Be sure to tell anyone who works on your vehicle that it has an airbag system.**

2

**NOTE:** Perchlorate Material – special handling may apply, See [www.dtsc.ca.gov/hazardouswaste/perchlorate](http://www.dtsc.ca.gov/hazardouswaste/perchlorate).

### **Airbag Warning Light**

You will want to have the airbag system ready to inflate for your protection in an impact. The airbag system is designed to be maintenance free. If any of the following occurs, have an authorized dealer service the system promptly:

- Does not come on during the six to eight seconds after the ignition switch is first turned on.
- Remains on after the six to eight second interval.
- Comes on for any period of time while driving.

### **Event Data Recorder (EDR)**

In the event of an accident, your vehicle is designed to record up to five seconds of specific vehicle data parameters (see the following list) in an event data recorder

prior to the moment of airbag deployment, and up to a quarter-second of high-speed deceleration data during and/or after airbag deployment or near-deployment. EDR data are ONLY recorded if an airbag deploys, or nearly deploys, and are otherwise unavailable.

### **NOTE:**

- Under certain circumstances, EDR data may not be recorded (e.g., loss of battery power).

In conjunction with other data gathered during a complete accident investigation, the electronic data may be used by DaimlerChrysler Corporation and others to learn more about the possible causes of crashes and associated injuries in order to assess and improve vehicle performance. In addition to crash investigations initiated by DaimlerChrysler Corporation, such investigations may be requested by customers, insurance carriers, government officials, and professional crash researchers, such as those associated with universities, and with hospital and insurance organizations.

In the event that an investigation is undertaken by DaimlerChrysler Corporation (regardless of initiative), the company, or its designated representative, will first obtain permission of the appropriate custodial entity for the vehicle (usually the vehicle owner or leasee) before accessing the electronic data stored, unless ordered to download data by a court with legal jurisdiction (i.e., pursuant to a warrant). A copy of the data will be provided to the custodial entity upon request. General data that does not identify particular vehicles or crashes may be released for incorporation in aggregate crash databases, such as those maintained by the U.S. government and various states. Data of a potentially sensitive nature, such as would identify a particular driver, vehicle, or crash, will be treated confidentially. Confidential data will not be disclosed by DaimlerChrysler Corporation to any third party except when:

1. Used for research purposes, such as to match data with a particular crash record in an aggregate database, provided confidentiality of personal data is thereafter preserved
2. Used in defense of litigation involving a DaimlerChrysler Corporation product
3. Requested by police under a legal warrant
4. Otherwise required by law

#### Data Parameters that May Be Recorded:

- Diagnostic trouble code(s) and warning lamp status for electronically-controlled safety systems, including the airbag system
- Airbag disable lamp status (if equipped)
- "Time" of airbag deployment (in terms of ignition cycles and vehicle mileage)

- Airbag deployment level (if applicable)
- Impact acceleration and angle
- Seat belt status
- Brake status (service and parking brakes)
- Accelerator status (including vehicle speed)
- Engine control status (including engine speed)
- Transmission gear selection
- Cruise control status
- Traction/stability control status
- Tire pressure monitoring system (TPMS) status

### **Child Restraint**

Everyone in your vehicle needs to be buckled up at all times — babies and children, too. Every state in the United States and all Canadian provinces require that small children ride in proper restraint systems. This is the law, and you can be prosecuted for ignoring it.

Children 12 years and under should ride properly buckled up in a rear seat, if available. According to crash statistics, children are safer when properly restrained in the rear seats, rather than in the front.

There are different sizes and types of restraints for children from newborn size to the child almost large enough for an adult safety belt. Always check the child seat owner's manual to ensure you have the correct seat for your child. Use the restraint that is correct for your child.

**WARNING!**

In a collision, an unrestrained child, even a tiny baby, can become a missile inside the vehicle. The force required to hold even an infant on your lap could become so great that you could not hold the child, no matter how strong you are. The child and others could be badly injured. Any child riding in your vehicle should be in a proper restraint for the child's size.

**Infants and Child Restraints**

- Safety experts recommend that children ride rearward-facing in the vehicle until they are at least one-year old **and** weigh at least 20 lbs (9 kg). Two types of child restraints can be used rearward-facing: infant carriers and “convertible” child seats.

- The infant carrier is only used rearward-facing in the vehicle. It is recommended for children who weigh up to about 20 lbs (9 kg). “Convertible” child seats often have a higher weight limit in the rearward-facing direction than infant carriers do, so they can be used rearward-facing by children who weigh more than 20 lbs (9 kg) but are less than one year old. Both types of child restraints are held in the vehicle by the lap/shoulder belt or the LATCH child restraint anchorage system (Refer to LATCH — Child Seat Anchorage System in this section.)
- Rearward-facing child seats must **NEVER** be used in the front seat of a vehicle with the front passenger airbag unless the airbag is turned off. An airbag deployment could cause severe injury or death to infants in this position.



**WARNING!**

- **Improper installation can lead to failure of an infant or child restraint. It could come loose in a collision. The child could be badly injured or killed. Follow the manufacturer's directions exactly when installing an infant or child restraint.**
- **A rearward facing infant restraint should only be used in a rear seat. A rearward facing infant restraint in the front seat may be struck by a deploying passenger airbag which may cause severe or fatal injury to the infant.**

Here are some tips for getting the most out of your child restraint:

- Before buying any restraint system, make sure that it has a label certifying that it meets all applicable Safety

Standards. The manufacturer also recommends that you try a child restraint in the vehicle seats where you will use it before you buy it.

- The restraint must be appropriate for your child's weight and height. Check the label on the restraint for weight and height limits.
- Carefully follow the instructions that come with the restraint. If you install the restraint improperly, it may not work when you need it.
- All seating positions (except for driver) have a automatic locking retractor identified by a distinctive label. The seat belts are designed to keep the lap portion tight around the child restraint so that it is not necessary to use a locking clip. For the seat belt with the automatic locking retractor, pull the belt from the retractor until there is enough to allow you to pass through the child restraint and slide the latch plate into the buckle. Then, pull the belt until it is fully

extracted from the retractor. Allow the belt to return to the retractor, pulling on the excess webbing to tighten the lap portion about the child restraint. For additional information, refer to "Automatic Locking Mode" earlier in this section.

- In the rear seat, you may have trouble tightening the lap/shoulder belt on the child restraint because the buckle or latch plate is too close to the belt path opening on the restraint. Disconnect the latch plate from the buckle and twist the short buckle-end belt several times to shorten it. Insert the latch plate into the buckle with the release button facing out.
- If the belt still cannot be tightened, or if pulling and pushing on the restraint loosens the belt, disconnect the latch plate from the buckle, turn the buckle around, and insert the latch plate into the buckle again. If you still cannot make the child restraint secure, try a different seating position.

- Buckle the child into the restraint exactly as the manufacturer's instructions tell you.
- When your child restraint is not in use, secure it in the vehicle with the seat belt or remove it from the vehicle. Do not leave it loose in the vehicle. In a sudden stop or collision, it could strike the occupants or seatbacks and cause serious personal injury.

**NOTE:** For additional information refer to [www.seatcheck.org](http://www.seatcheck.org) or call 1-866-SEATCHECK.

### Older Children and Child Restraints

Children who weigh more than 20 lbs (9 kg) and who are older than one year can ride forward-facing in the vehicle. Forward-facing child seats and convertible child seats used in the forward-facing direction, are for children who weigh 20 to 40 lbs (9 to 18 kg), and who are older than one year. These child seats are also held in the

vehicle by the lap/shoulder belt or the LATCH child restraint anchorage system (Refer to LATCH — Child Seat Anchorage System in this section).

The belt-positioning booster seat is for children weighing more than 40 lbs (18 kg), but who are still too small to fit the vehicle's seat belts properly. If the child cannot sit with knees bent over the vehicle's seat cushion while the child's back is against the seatback, they should use a belt-positioning booster seat. The child and belt-positioning booster seat are held in the vehicle by the lap/shoulder belt.

### **Children Too Large for Booster Seats**

Children who are large enough to wear the shoulder belt comfortably, and whose legs are long enough to bend over the front of the seat when their back is against the seatback, should use the lap/shoulder belt in a rear seat.

- Make sure that the child is upright in the seat.

- The lap portion should be low on the hips and as snug as possible.
- Check belt fit periodically. A child's squirming or slouching can move the belt out of position.
- If the shoulder belt contacts the face or neck, move the child closer to the center of the vehicle. Never allow a child to put the shoulder belt under an arm or behind the back.

### **Automatic-Locking Retractor (ALR)**

To operate the switchable retractor, pull the belt from the retractor until there is enough to allow you to pass through the child restraint and slide the latch plate into the buckle. Then pull on the belt until it is fully extended from the retractor. Allow the belt to return into the retractor, pulling on the excess webbing to tighten the lap portion about the child restraint. Follow the instructions of the child restraint manufacture.

**NOTE:** To reset this feature you must let all of the belt webbing return into the retractor. You will not be able to pull out more webbing until all of the webbing has been returned back into the retractor.

### Installing the Child Restraint System

We urge you to carefully follow the directions of the manufacturer when installing your child restraint. Many, but not all, restraint systems will be equipped with separate straps on each side, with each having a hook or connector for attachment to the lower anchorage, and a means for adjusting the tension of the strap. Forward-facing toddler restraints and some rearward-facing infant restraints will also be equipped with a tether strap having a hook for attachment to the tether strap anchorage, and a means for adjusting the tension of the strap.

In general, you will first loosen the adjusters on the lower and tether straps so that you can more easily attach the hook or connector to the lower and tether anchorages.

The tether strap should be routed under the center of the head restraint and attached to the tether anchor on the rear of the seatback. Then tighten all three straps as you push the child restraint rearward and downward into the seat.

Not all child restraint systems will be installed as we have described here. Again, carefully follow the instructions that come with the child restraint system.

**NOTE:** If your child restraint seat is not LATCH compatible, install the restraint using the vehicle seat belts.

#### **WARNING!**

**An incorrectly anchored tether strap could lead to increased head motion and possible injury to the child. Use only the anchor position directly behind the child seat to secure a child restraint top tether strap.**

### **LATCH — Child Seat Anchorage System (Lower Anchors and Tether for Children)**

Your vehicle's rear seat is equipped with the child restraint anchorage system called LATCH. The LATCH system provides for the installation of the child restraint without using the vehicle's seat belts, instead securing the child restraint using lower anchorages and upper tether straps from the child restraint to the vehicle structure.

LATCH-compatible child restraint systems are now available. However, because the lower anchorages are to be introduced over a period of years, child restraint systems having attachments for those anchorages will continue to also have features for installation using the vehicle's seat belts. Child restraints having tether straps and hooks for connection to the top tether anchorages have been available for some time. For some older child restraints, many child restraint manufacturers offer add-on tether strap

kits or retro-fit kits. You are urged to take advantage of all the available attachments provided with your child restraint in any vehicle.

**NOTE:** When using the LATCH attaching system to install a child restraint, please ensure that all seat belts not being used for occupant restraints are stowed and out of reach of children. It is recommended that before installing the child restraint, buckle the seat belt so the seat belt is tucked behind the child restraint and out of reach. If the buckled seat belt interferes with the child restraint installation, instead of tucking the seat belt behind the child restraint, route the seat belt through the child restraint belt path and then buckle it. This should stow the seat belt out of the reach of an inquisitive child. Remind all children in the vehicle that the seat belts are not toys and should not be played with, and never leave an unattended child in the vehicle.

The rear seating positions have lower anchorages that are capable of accommodating LATCH-compatible child seats having flexible, webbing-mounted lower attachments. Child seats with fixed lower attachments must be installed in the outboard positions only. Regardless of the specific type of lower attachment, **NEVER** install LATCH-compatible child seats such that two seats share a common lower anchorage.

If you are installing LATCH-compatible child restraints in adjacent rear seating positions, you can use the LATCH anchors or the vehicle's seat belt for the outboard position, but you must use the vehicle's seat belt at the center position. If your child restraints are not LATCH-compatible, you can only install the child restraints using the vehicle's seat belts. Please refer to the next section for typical installation instructions.

## Installing the LATCH-Compatible Child Restraint System

We urge you to carefully follow the directions of the manufacturer when installing your child restraint. Not all child restraint systems will be installed as described here. Again, carefully follow the installation instructions that were provided with the child restraint system.



The rear seat lower anchorages are round bars, located at the rear of the seat cushion where it meets the seatback, and are visible when you lean into the rear seat to install the child restraint. You will easily feel them if you run your finger along the intersection of the seatback and seat cushion surfaces.

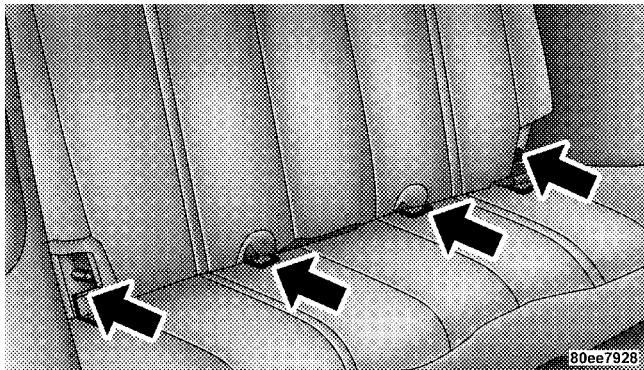

Latch Anchorages (Two-Door Models)

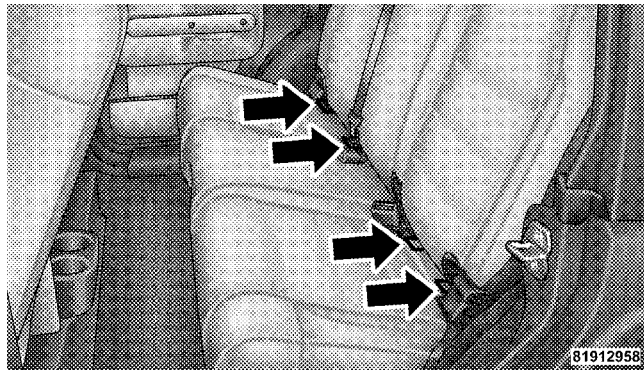

Latch Anchorages (Four-Door Models)

In addition, there are tether strap anchorages behind each rear seating position located on the back of the seat.

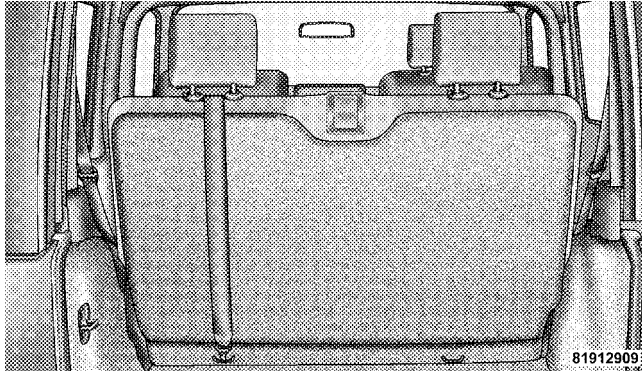

**Tether Strap Mounting (Two-Door Models)**

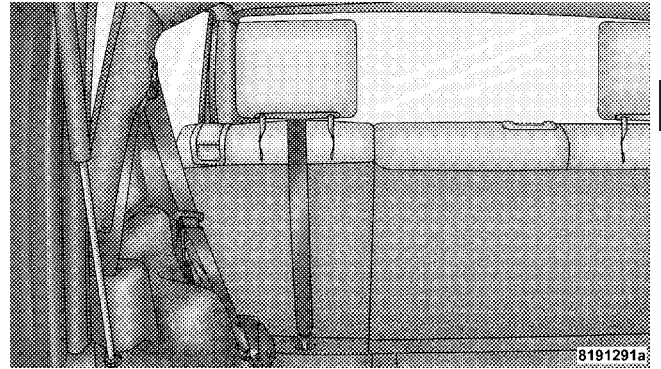

**Tether Strap Mounting (Four-Door Models)**

Many, but not all restraint systems will be equipped with separate straps on each side, with each having a hook or connector for attachment to the lower anchorage and a means for adjusting the tension of the strap. Forward-facing toddler restraints and some rear-facing infant restraints will also be equipped with a tether strap having



a hook for attachment to the tether strap anchorage, and a means for adjusting the tension of the strap.

You will first loosen the adjusters on the lower straps and on the tether strap so that you can more easily attach the hooks or connectors to the vehicle anchorages. Next, attach the lower hooks or connectors over the top of the anchorage bars, pushing aside the seat cover material. Then, locate the tether anchorage directly behind the seat where you are placing the child restraint and attach the tether strap to the anchorage, being careful to route the tether strap to provide the most direct path between the anchor and the child restraint. Finally, tighten all three straps as you push the child restraint rearward and downward into the seat, removing slack in the straps according to the child restraint manufacturer's instructions.

**WARNING!**

**Improper installation of a child restraint to the LATCH anchorages can lead to failure of an infant or child restraint. The child could be badly injured or killed. Follow the manufacturer's directions exactly when installing an infant or child restraint.**

**Installing Child Restraints Using the Vehicle Seat Belt**

The passenger seat belts are equipped with automatic locking retractors, which are designed to keep the lap portion tight around the child restraint so that it is not necessary to use a locking clip. If the seat belt has a cinching latch plate, pulling up on the shoulder portion of the lap/shoulder belt will tighten the belt. Any seat belt system will loosen with time, so check the belt occasionally and pull it tight if necessary.

If the seat belt has an automatic locking retractor, it will have a distinctive label. Pull the belt from the retractor until there is enough to allow you to pass through the child restraint and slide the latch plate into the buckle. Then, pull the belt until it is fully extended from the retractor. Allow the belt to return to the retractor, pulling on the excess webbing to tighten the lap portion about the child restraint. Refer to “Automatic Locking Mode” earlier in this section.

In the rear seat, you may have trouble tightening the lap/shoulder belt on the child restraint because the buckle or latch plate is too close to the belt path opening on the restraint. Disconnect the latch plate from the buckle and twist the short buckle-end belt several times to shorten it. Insert the latch plate into the buckle with the release button facing out.

If the belt still can't be tightened, or if by pulling and pushing on the restraint loosens the belt, you may need

to do something more. Disconnect the latch plate from the buckle, turn the buckle around, and insert the latch plate into the buckle again. If you still can't make the child restraint secure, try a different seating position.

To attach a child restraint tether strap:

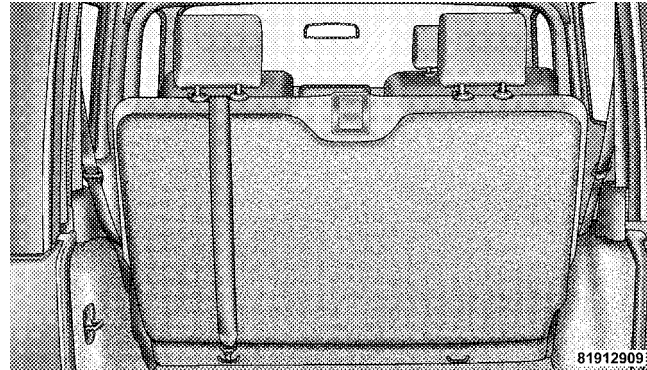

**Tether Strap Mounting (Two-Door Models)**

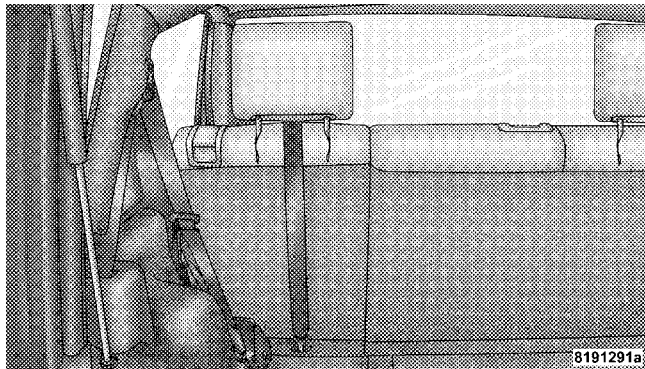

### Tether Strap Mounting (Four-Door Models)

Route the tether strap over the seatback and attach the hook to the tether anchor located on the back of the seat. For the outboard seating positions, route the tether under the head rest, and attach the hook to the tether anchor located on the back of the seat.

### WARNING!

An incorrectly anchored tether strap could lead to increased head motion and possible injury to the child. Use only the anchor positions directly behind the child seat to secure a child restraint top tether strap.

### Transporting Pets

Airbags deploying in the front seat could harm your pet. An unrestrained pet will be thrown about and possibly injured, or injure a passenger during panic braking or in a collision.

Pets should be restrained in the rear seat in pet harnesses or pet carriers that are secured by seat belts.

## ENGINE BREAK-IN RECOMMENDATIONS

A long break-in period is not required for the engine in your vehicle.

Drive moderately during the first 300 mi (500 km). After the initial 60 mi (100 km), speeds up to 50 or 55 mph (80 or 90 km/h) are desirable.

While cruising, brief full-throttle acceleration, within the limits of local traffic laws, contributes to a good break-in. Wide-open throttle acceleration in low gear can be detrimental and should be avoided.

The engine oil installed in the engine at the factory is a high-quality energy-conserving type lubricant. Oil changes should be consistent with anticipated climate conditions under which vehicle operations will occur. For the recommended viscosity and quality grades, refer to "Maintenance Procedures" in Section 7 of this manual. **NON-DETERGENT OR STRAIGHT MINERAL OILS MUST NEVER BE USED.**

A new engine may consume some oil during its first few thousand miles (kilometers) of operation. This should be considered as a normal part of the break-in and not interpreted as an indication of difficulty.

## SAFETY TIPS

### Exhaust Gas

#### **WARNING!**

**Exhaust gases can injure or kill. They contain carbon monoxide (CO) which is colorless and odorless. Breathing it can make you unconscious and can eventually poison you. To avoid breathing (CO) follow the safety tips below.**

- Do not inhale exhaust gases. They contain carbon monoxide, a colorless and odorless gas which can kill. Never run the engine in a closed area, such as a garage, and never sit in a parked vehicle with the engine running for an extended period. If the vehicle is stopped in an open area with the engine running for more than a short time, adjust the ventilation system to force fresh, outside air into the vehicle.
- Guard against carbon monoxide with proper maintenance. Have the exhaust system inspected every time the vehicle is raised. Have any abnormal conditions repaired promptly. Until repaired, drive with all side windows fully open.
- Always run the climate control in panel or floor mode when driving with any windows open, even if only slightly, to help keep fresh air circulating inside the vehicle. Otherwise poisonous gases could be drawn into the vehicle.

- On hardtop models, keep the tailgate window closed when driving your vehicle. On fabric top models, do not drive with the rear window curtain up unless the side curtains are also open. This will prevent carbon monoxide and other poisonous exhaust gases from entering the vehicle.

### **Safety Checks You Should Make Inside The Vehicle**

#### **Seat Belts**

Inspect the seat belt system periodically, checking for cuts, frays and loose parts. Damaged parts must be replaced immediately. Do not disassemble or modify the system.

Seat belt assemblies must be replaced after an accident if they have been damaged (bent retractor, torn webbing, etc.). If there is any question regarding seat belt or retractor condition, replace the seat belt.

### **Airbag Warning Light**

The light should come on and remain on for six to eight seconds as a indicator check when the ignition switch is first turned on. If the indicator is not lit during starting, have it serviced. If the light stays on or comes on while driving, have the system checked by an authorized dealer.

### **Defrosters**

Check operation by selecting the defrost mode and place the blower control on high speed. You should be able to feel the air directed against the windshield. See your authorized dealer for service if your defroster is inoperable.

## **Safety Checks You Should Make Outside The Vehicle**

### **Tires**

Examine tires for excessive tread wear or uneven wear patterns. Check for stones, nails, glass, or other objects lodged in the tread. Inspect for tread cuts or sidewall cracks. Check wheel nuts for tightness and tires (including spare) for proper pressure.

### **Lights**

Have someone observe the operation of all exterior lights while you work the controls. Check turn signal and high beam indicator lights on the instrument panel.

### **Fluid Leaks**

Check area under vehicle after overnight parking for fuel, coolant, oil, or other fluid leaks. Also, if gasoline fumes are detected, the cause should be located and corrected immediately.



# UNDERSTANDING THE FEATURES OF YOUR VEHICLE

## CONTENTS

■ Mirrors . . . . .	.83	□ Front Easy Entry Seats (Two-Door Models) . . . . .	.88
□ Inside Day/Night Mirror . . . . .	.83	□ Head Restraints . . . . .	.89
□ Outside Mirrors . . . . .	.84	□ Fold And Tumble Rear Seat (Two-Door Models) . . . . .	.89
■ Hands-Free Communication (UConnect®) . . . . .	.85	□ Removing The Rear Seat (Two-Door Models) . . . . .	.91
■ Seats . . . . .	.86	□ Replacing The Rear Seat (Two-Door Models) . . . . .	.92
□ Front Seat Adjustment . . . . .	.86	□ 60/40 Split Folding Rear Seat (Four-Door Models) . . . . .	.92
□ Manual Seat Height Adjustment — If Equipped . . . . .	.87		
□ Front Seatback Recline . . . . .	.87		



□ To Raise The Rear Seat . . . . .	94	■ Windshield Wipers And Washers . . . . .	100
■ To Open And Close The Hood . . . . .	94	□ Intermittent Wiper System . . . . .	100
■ Lights . . . . .	95	□ Windshield Wiper Operation . . . . .	100
□ Interior Lights . . . . .	95	□ Windshield Washers . . . . .	101
□ Multifunction Control Lever . . . . .	97	□ Mist Feature . . . . .	101
□ Parking Lights, Instrument Panel Lights, And Headlights . . . . .	97	■ Tilt Steering Column . . . . .	101
□ Lights-On Reminder . . . . .	98	■ Electronic Speed Control — If Equipped . . . . .	102
□ Headlight Dimmer Switch . . . . .	98	□ To Activate . . . . .	102
□ Passing Light . . . . .	99	□ To Set At A Desired Speed . . . . .	103
□ Front Fog Lights — If Equipped . . . . .	99	□ To Deactivate . . . . .	103
□ Turn Signals . . . . .	99	□ To Resume Speed . . . . .	103
□ Daytime Running Lights — If Equipped . . . . .	99	□ To Vary The Speed Setting . . . . .	103
		□ Manual Transmission . . . . .	104

<ul style="list-style-type: none"> <li>□ To Accelerate For Passing . . . . . 105</li> <li>■ Electronic Brake Control System . . . . . 105                             <ul style="list-style-type: none"> <li>□ ABS (Anti-Lock Brake System) . . . . . 105</li> <li>□ TCS (Traction Control System) . . . . . 106</li> <li>□ BAS (Brake Assist System) . . . . . 107</li> <li>□ ERM (Electronic Roll Mitigation) . . . . . 108</li> <li>□ ESP (Electronic Stability Program) . . . . . 109</li> <li>□ ESP/BAS Warning Light . . . . . 115</li> </ul> </li> <li>■ Electrical Power Outlet . . . . . 116                             <ul style="list-style-type: none"> <li>□ Electrical Outlet Use With Engine Off . . . . . 117</li> </ul> </li> <li>■ Cupholders . . . . . 117                             <ul style="list-style-type: none"> <li>□ Front Cupholders . . . . . 117</li> <li>□ Rear Cupholders . . . . . 118</li> </ul> </li> </ul>	<ul style="list-style-type: none"> <li>■ Storage . . . . . 118                             <ul style="list-style-type: none"> <li>□ Console Storage Compartment . . . . . 118</li> <li>□ Rear Storage Compartment . . . . . 119</li> </ul> </li> <li>■ Dual Top — If Equipped . . . . . 120                             <ul style="list-style-type: none"> <li>□ Removing The Soft Top . . . . . 120</li> <li>□ Installing The Soft Top . . . . . 122</li> </ul> </li> <li>■ Freedom Top Three-Piece Modular Hard Top . . . 125                             <ul style="list-style-type: none"> <li>□ Front Panel(s) Removal . . . . . 126</li> <li>□ Front Panel(s) Installation . . . . . 128</li> <li>□ Front Panel(s) Installation Only (With Rear Hard Top Removed) . . . . . 128</li> <li>□ Rear Hard Top Removal . . . . . 129</li> <li>□ Rear Hard Top Installation . . . . . 131</li> </ul> </li> </ul>
--	---

- Door Frame . . . . . 132
  - Door Frame Removal (Two-Door Models) . . . 132
  - Door Frame Installation (Two-Door Models) . . 134
  - Door Frame Removal (Four-Door Models) . . . 135
  - Door Frame Installation (Four-Door Models) . . 138
- Soft Top (Two-Door Models) . . . . . 141
  - Folding Down The Soft Top . . . . . 143
  - Putting Up The Soft Top . . . . . 152
- Sunrider (Two-Door Models) — If Equipped . . . 161
- Sunrider (Four-Door Models) — If Equipped . . . 164
- Soft Top (Four-Door Models) . . . . . 168
  - Folding Down The Soft Top . . . . . 170
  - Putting Up The Soft Top . . . . . 180
- Folding Windshield . . . . . 191
  - Lowering The Windshield And Removing Side Bars . . . . . 193
  - Raising The Windshield And Replacing Side Bars . . . . . 196
- Rear Window Features — Hard Top Only . . . . . 197
  - Rear Window Wiper/Washer — If Equipped . . . . . 197
  - Rear Window Defroster — If Equipped . . . . . 198

## MIRRORS

### Inside Day/Night Mirror

The mirror should be adjusted to center on the view through the rear window. A two-point pivot system allows for horizontal and vertical adjustment of the mirror.

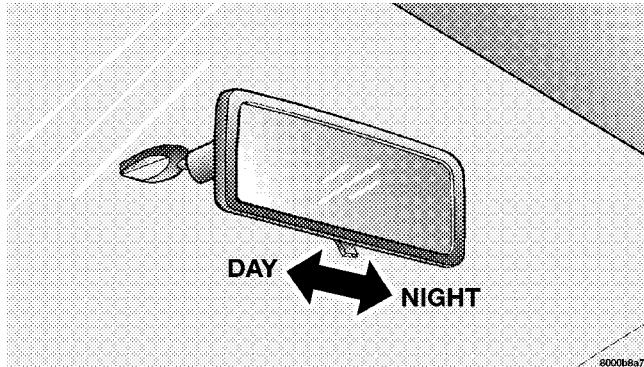

Adjusting Rearview Mirror

Annoying headlight glare can be reduced by moving the small control under the mirror to the night position (toward rear of vehicle). The mirror should be adjusted while set in the day position (toward windshield).

### Outside Mirrors

To receive maximum benefit, adjust the outside mirror(s) to center on the adjacent lane of traffic with a slight overlap of the view obtained on the inside mirror.

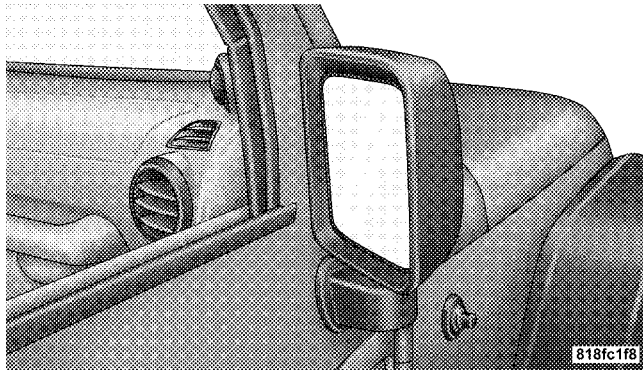

Outside Rearview Mirror

### WARNING!

- Vehicles and other objects seen in the right side convex mirror will look smaller and farther away than they really are. Relying too much on your right side mirror could cause you to collide with another vehicle or other object.
- Use your inside mirror when judging the size or distance of a vehicle seen in the right side mirror.

## HANDS-FREE COMMUNICATION (UConnect®)

This feature is not available on two-door or four-door models.

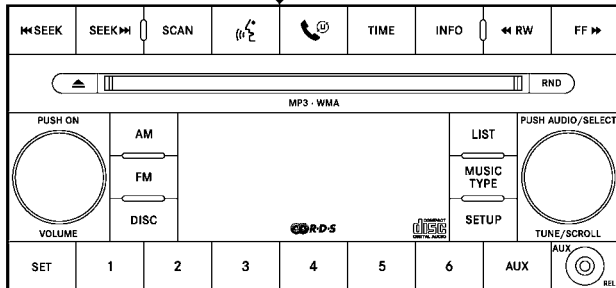

81969789

## Voice Recognition Button (UConnect® Hands-Free Phone)

When you press this button, a “Not Equipped with UConnect” message will display on your radio screen.

## Phone Button (UConnect® Hands-Free Phone)

When you press this button, a “Not Equipped with UConnect” message will display on your radio screen.

3

## SEATS

### WARNING!

Adjusting a seat while the vehicle is moving is dangerous. The sudden movement of the seat could cause you to lose control. The seat belt might not be properly adjusted and you could be injured. Adjust any seat only while the vehicle is parked.

### Front Seat Adjustment

Move seat forward or rearward by lifting the lever. Be sure the latch engages fully.

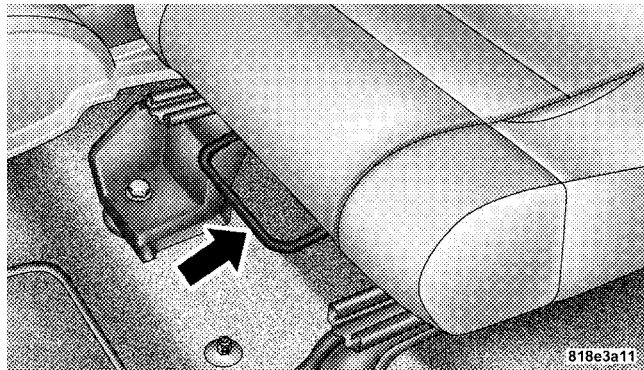

Manual Seat Adjustment

### Manual Seat Height Adjustment — If Equipped

The driver's seat height can be raised or lowered by using the ratcheting handle on the outboard side of the seat. Pull upward on the handle to raise the seat. Push downward on the handle to lower the seat.

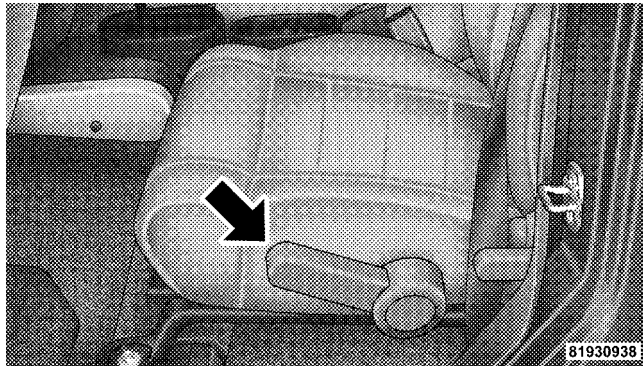

Seat Height Adjustment

### Front Seatback Recline

To recline:

1. Lean forward before lifting the handle, then lean back to the desired position and release the handle.

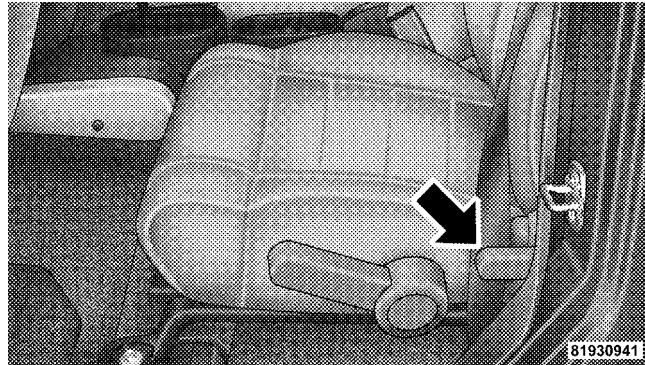

Recline Lever

2. Lift the handle to return the seatback to an upright position.



### Front Easy Entry Seats (Two-Door Models)

Push the lever on the seatback rearward (toward the rear of the vehicle) to tilt the entire seat forward.

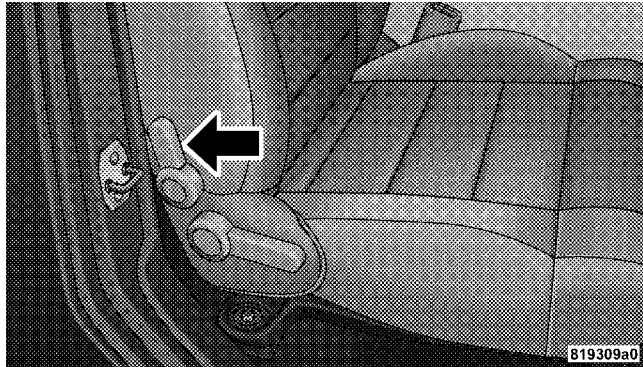

Easy Entry Lever



Easy Entry Seat

1. To return the seat to a sitting position, rotate the seatback upright until it locks.
2. Push the seat rearward until the track locks.

**NOTE:** The front seats have a full recliner memory, which will allow the seatback to be returned to its original position.

**NOTE:** The front seats have a track memory, which returns the seat to just past the halfway point of the track regardless of its original position.

**NOTE:** The recliner and easy entry levers should not be used during the automatic returning of the seat to its sitting position.

### Head Restraints

Head restraints can reduce the risk of whiplash injury in the event of impact from the rear. Adjustable head restraints should be adjusted so that the upper edge is as high as practical. The front head restraints have a locking button that must be pushed inward to lower the head restraint. The restraints may be raised without pushing in the button. The rear head restraints are not adjustable.

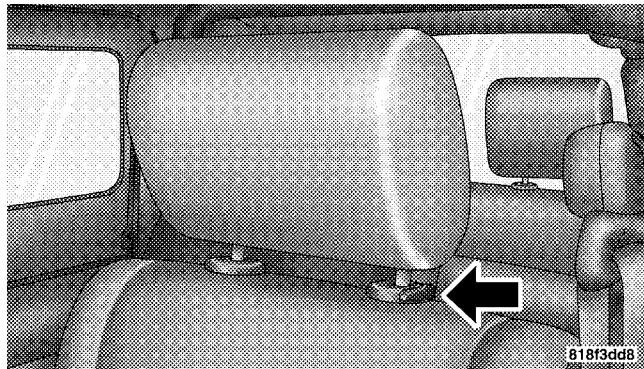

3

### Adjustable Head Restraints

### Fold And Tumble Rear Seat (Two-Door Models)

**NOTE:** Prior to folding the rear seat, it may be necessary to reposition the front seats.

Also, be sure that the front seats are fully upright and positioned forward. This will allow the rear seat to fold down easily.

1. Lift the seatback release lever and fold seatback forward.

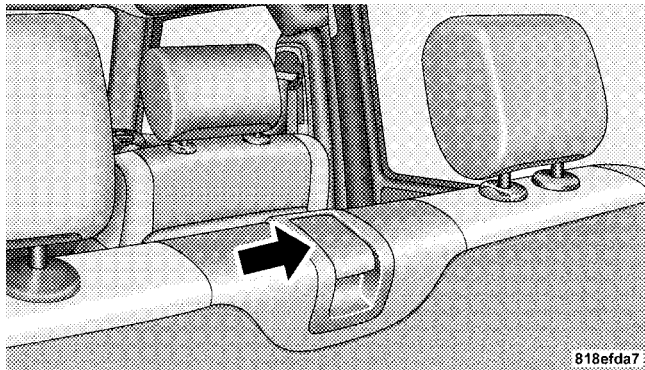

**Rear Seat Release**

2. Slowly flip the entire seat forward.

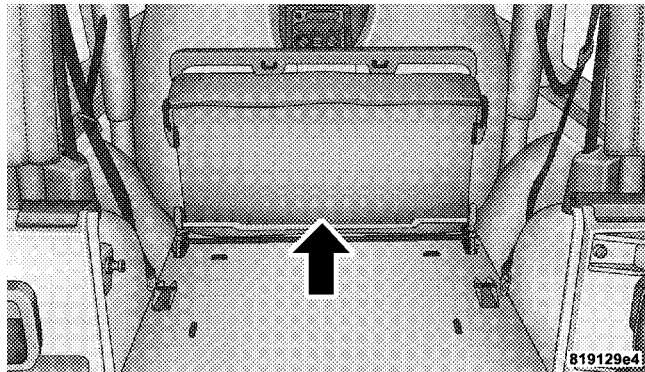

**Folding Rear Seat**

3. When completed, return the seat to its normal position.
4. Raise the rear seatback using the assist strap and firmly lock seat into position.

## Removing the Rear Seat (Two-Door Models)

### WARNING!

- It is extremely dangerous to ride in a cargo area, inside or outside of a vehicle. In a collision people riding in these areas are more likely to be seriously injured or killed.
- Do not allow people to ride in any area of your vehicle that is not equipped with seats and seat belts.
- Be sure everyone in your vehicle is in a seat and using a seat belt properly.
- In a collision, you or others in your vehicle could be injured if seats are not properly latched to their floor attachments. Always be sure that the seats are fully latched.

1. Remove the three rear subwoofer (if equipped) mounting screws using a #T30 Torx® head driver.

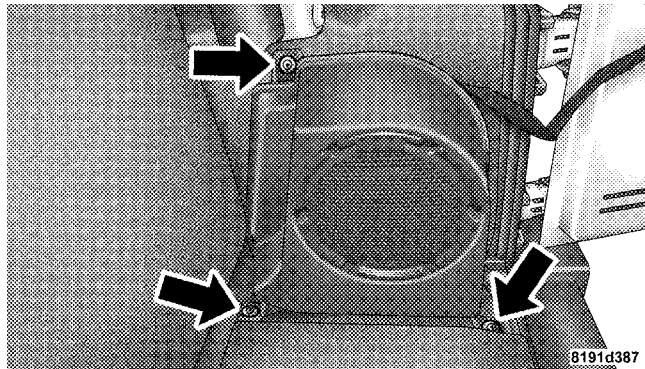

Subwoofer

2. Unplug electrical connector from rear subwoofer (if equipped).
3. Fold the rear seat forward following steps 1 through 3 under "Fold and Tumble Rear Seat" in this section.

- Press down on the release bar on each side, and pull the seat out and away from lower bracket.
- Remove the seat from the vehicle.

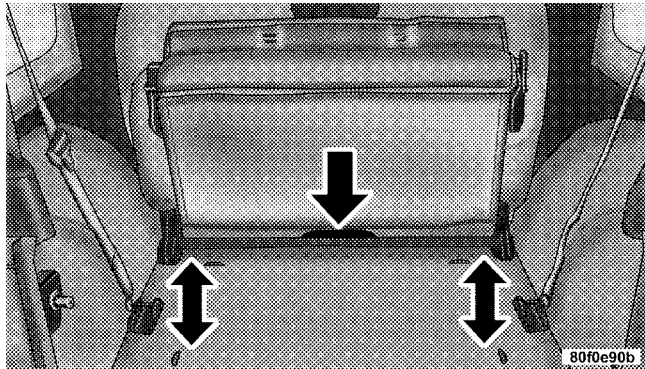

Release Bar Location

### Replacing the Rear Seat (Two-Door Models)

Reverse steps for removing the seat.

#### WARNING!

- To help protect against personal injury, passengers should not be seated in the rear cargo area with the rear seat folded down or removed from the vehicle.
- The rear cargo space is intended for load carrying purposes only, not for passengers, who should sit in seats and use seat belts.

### 60/40 Split Folding Rear Seat (Four-Door Models)

To provide additional storage area, each rear seat can be folded flat to allow for extended cargo space and still maintain some rear seating room.

**NOTE:** Prior to folding the rear seat, it may be necessary to reposition the front seat to its mid-track position.

Also, be sure that the front seats are fully upright and positioned forward. This will allow the rear seat to fold down easily.

### WARNING!

- It is extremely dangerous to ride in a cargo area, inside or outside of a vehicle. In a collision, people riding in these areas are more likely to be seriously injured or killed.
- Do not allow people to ride in any area of your vehicle that is not equipped with seats and seat belts.
- Be sure everyone in your vehicle is in a seat and using a seat belt properly.

### To Fold Down the Rear Seat

Locate the pull strap (lower outboard side of seat), and pull it towards you until the seatback releases.

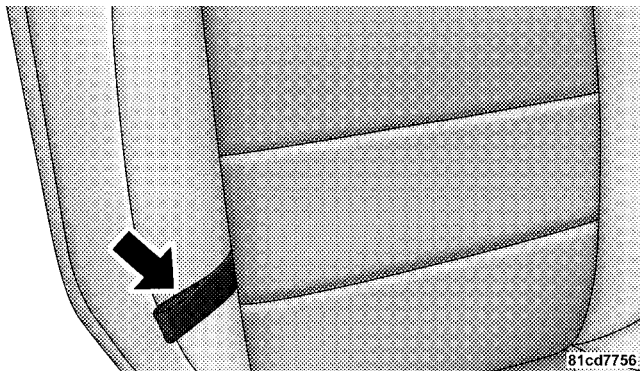

Pull Strap

## To Raise the Rear Seat

1. Raise the seatback and lock it into place. If interference from the cargo area prevents the seatback from fully locking, you will have difficulty returning the seat to its proper position.

**NOTE:** If the rear seatback is not fully latched, the center shoulder belt will not be able to be extended for use. If you cannot extend the center shoulder belt, please make sure your seatback is fully latched.

### WARNING!

Be certain that the seatback is securely locked into position. If the seatback is not securely locked into position the seat will not provide the proper stability for child seats and/or passengers. An improperly latched seat could cause serious injury.

## TO OPEN AND CLOSE THE HOOD

To open the hood, first release both hood latches.

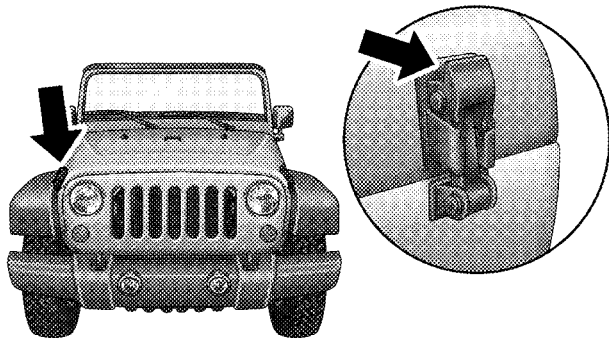

Hood Latch

818f406e

Next, locate handle in middle of the front end of the hood. Insert hand into gap between hood and top of grille, and push handle to the side to raise hood. You may have to push down slightly on the hood before pushing the handle. Insert the support rod into the slot on the hood panel.

To close the hood, remove the support rod from the hood panel and place it in the retaining clip. Lower the hood slowly. Secure both of the hood latches.

### **WARNING!**

**If the hood is not fully latched, it could fly up when the vehicle is moving and block your forward vision. Be sure all hood latches are latched fully before driving.**

## **LIGHTS**

### **Interior Lights**

The overhead light will come on when a door is opened. It may also be turned on by rotating the control for the dimmer switch on the multifunction control lever fully upward.

The overhead light will automatically turn off in about 20 minutes if a door is left open or the dimmer control is left in the dome light position. Turn the ignition switch ON to restore the overhead light operation.

### **Cargo Lamp**

The courtesy and dome lights will turn on when the front doors are opened, when the dimmer control (rotating wheel on the right side of the switch) is rotated to the upward detent position, or if equipped, when the UN-LOCK button is pressed on the RKE key fob.



Also, the rear cargo lamp may be turned on by pressing the lens. Press the lens again to turn it off.

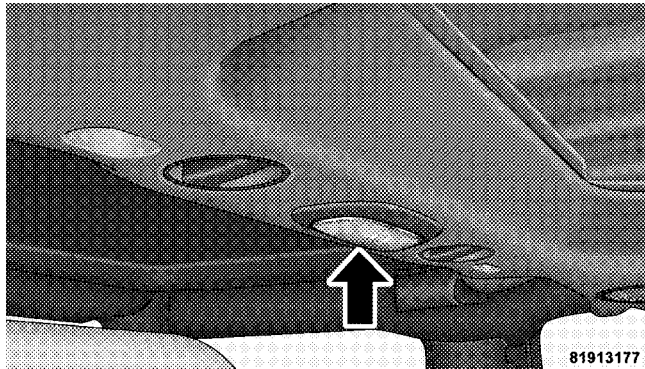

Cargo Lamp

When a door is open and the interior lights are on, rotating the dimmer control all the way down to the OFF detent will cause all the interior lights to turn off. This is also known as the "Party" mode because it allows the doors to stay open for extended periods of time without discharging the vehicle's battery.

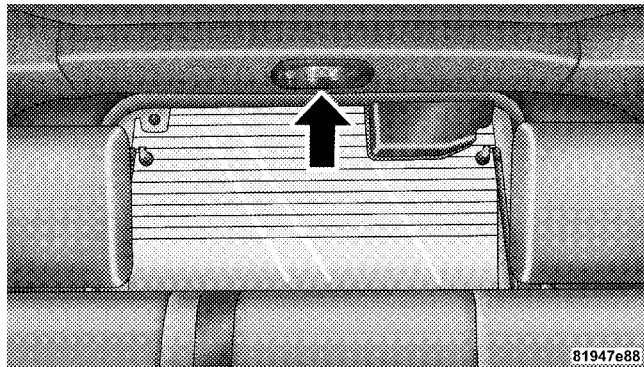

Rear Cargo Lamp (Four-Door Models)

### Daytime Brightness Feature

Certain instrument panel components (odometer, radio display) can be illuminated at full brightness during the daytime. This can be helpful when driving with your headlights on during the daytime, such as in a parade or a funeral procession. To activate this feature, rotate the left stalk one detent lower than the dome light.

### Multifunction Control Lever

The multifunction control lever controls the operation of the parking lights, headlights, headlight beam selection, passing light, fog lights, instrument panel light dimming, and turn signals. The lever is located on the left side of the steering column.

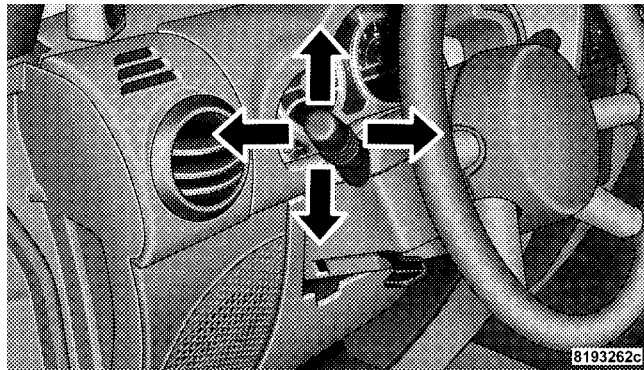

3

#### Multifunction Control Lever

### Parking Lights, Instrument Panel Lights, and Headlights

Turn the end of the multifunction control lever to the first detent for parking lights and instrument panel lights. Turn to the second detent for headlight operation.

**NOTE:** Lens fogging can occur under certain atmospheric conditions. This will usually clear as atmospheric conditions change to allow the condensation to change back into a vapor. Turning the lamps on will usually accelerate the clearing process.

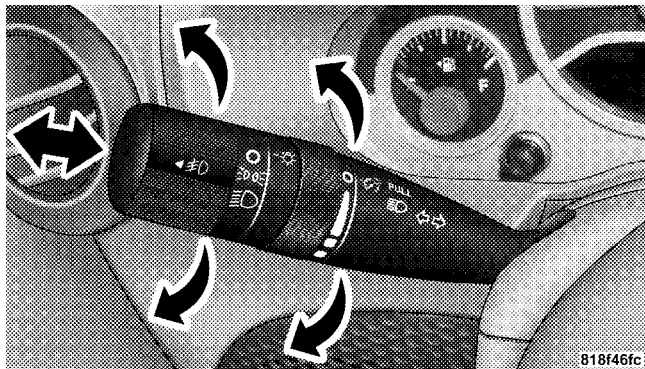

**Headlight Switch**

To change the brightness of the instrument panel lights, rotate the center portion of the multifunction control lever up or down.

**NOTE:** If the driver's door is left open, and the headlights or parking lights are left on, the High Beam Indicator Light will remain illuminated and a chime will sound.

### **Lights-On Reminder**

If the headlights or parking lights are on after the ignition is turned off, a chime will sound when the driver's door is opened.

### **Headlight Dimmer Switch**

Push the multifunction control lever away from you to switch the headlights to high beam. Pull the lever towards you to switch the headlights back to low beam.

## Passing Light

You can signal another vehicle with your headlights by lightly pulling the multifunction control lever toward the steering wheel. This will cause the headlights to turn on at high beam and remain on until the lever is released.

## Front Fog Lights — If Equipped

**#D** The front fog light switch is located on the multifunction control lever. To activate the front fog lights, turn on the parking or low beam headlights and pull out the end of the lever.

**NOTE:** The fog lights will only operate with the parking lights or the headlights on low beam. Selecting high beam headlights will turn off the fog lights.

## Turn Signals

Move the multifunction control lever up or down, and the arrows on each side of the instrument cluster flash, to show proper operation of the front and rear turn signal lights. You can signal a lane change by moving the lever partially up or down without moving beyond the detent.

If either light has a very fast flash rate, check for a defective outside light bulb. If an indicator fails to light when the lever is moved, it would suggest that the fuse or indicator is defective or there may be a circuit failure.

**NOTE:** A tone will chime if the turn signals are left on for more than 1 mi (2 km).

## Daytime Running Lights — If Equipped

The headlights come on at a low intensity level after the vehicle has been driven approximately 3 ft (1 m). They will turn off when the vehicle is turned off or when the headlights are switched on.

## WINDSHIELD WIPERS AND WASHERS

### CAUTION!

In cold weather, always turn off the wiper switch and allow the wipers to return to the park position before turning off the engine. If the wiper switch is left on and the wipers freeze to the windshield, damage to the wiper motor may occur when the vehicle is restarted.

### Intermittent Wiper System

Use the intermittent wiper when weather conditions make a single wiping cycle, with a variable pause between cycles, desirable. Move the lever to the DELAY position, then select the delay interval by turning the end of the lever. The delay can be regulated from a maximum of approximately 18 seconds between cycles, to a cycle every second.

### Windshield Wiper Operation

The windshield wiper/washer control lever operates the windshield wipers and washers when the ignition switch is in the ON position. The lever is located on the right side of the steering column. Move the lever upward to the second detent for LO speed wiper operation, or to the third detent for HI speed operation

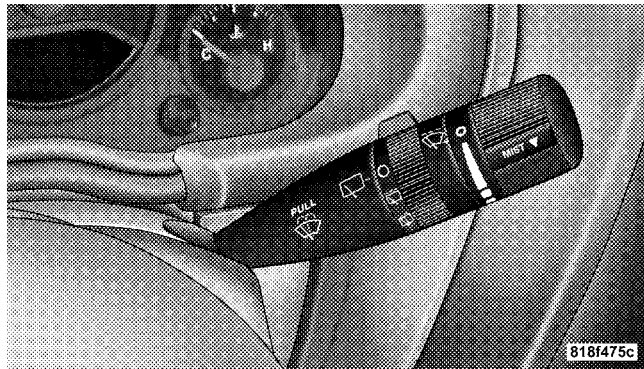

Windshield Wiper/Washer Switch

## Windshield Washers

To use the washer, pull the lever toward you and hold while spray is desired. If the lever is pulled while in the delay range, the wiper will operate for two wipe cycles after the lever is released, and then resume the intermittent interval previously selected.

If the lever is pulled while in the OFF position, the wipers will operate for as long as the lever is held plus two wipe cycles, then turn OFF.

## Mist Feature

Push down on the wiper lever to activate a single wipe to clear off road mist or spray from a passing vehicle. As long as the lever is held down, the wipers will continue to operate.

## TILT STEERING COLUMN

To tilt the column, push down on the lever under the multifunction control lever and move the wheel up or down, as desired. Pull the lever back upwards to lock the column firmly in place.

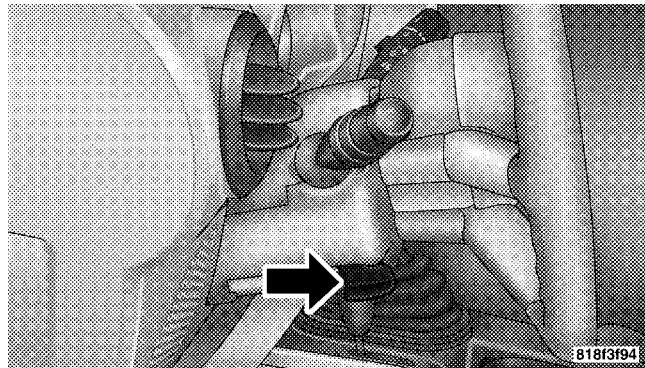

Tilt Steering Column

**WARNING!**

Tilting the steering column while the vehicle is moving is dangerous. Without a stable steering column, you could lose control of the vehicle and have an accident. Adjust the column only while the vehicle is stopped. Be sure it is locked before driving.

**ELECTRONIC SPEED CONTROL — IF EQUIPPED**

When engaged, this device takes over the accelerator operation at speeds greater than 35 mph (56 km/h). The speed control lever is located on the right side of the steering wheel.

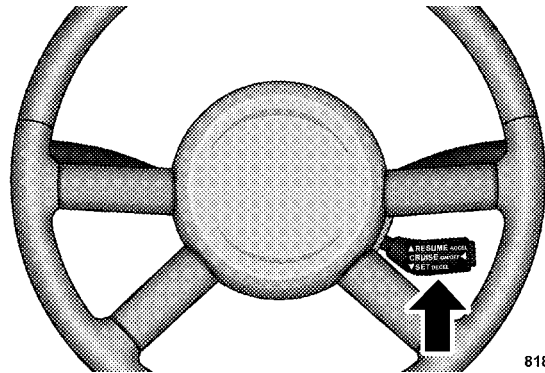

818f547e

**Speed Control Switches****To Activate**

Push the ON/OFF button. The Cruise Indicator Light in the instrument cluster will illuminate. To turn the system OFF, push the ON/OFF button a second time. The Cruise Indicator Light will turn off. The system should be turned OFF when not in use.

**WARNING!**

Leaving the Electronic Speed Control System on when not in use is dangerous. You could accidentally set the system or cause it to go faster than you want. You could lose control and have an accident. Always leave the system OFF when you are not using it.

**To Set At A Desired Speed**

When the vehicle has reached the desired speed, press down on the lever and release. Release the accelerator and the vehicle will operate at the selected speed.

**NOTE:** The vehicle should be traveling at a steady speed and on level ground before pressing the SET lever.

**To Deactivate**

A soft tap on the brake pedal, pulling the speed control lever towards you, or normal brake or clutch pressure while slowing the vehicle will deactivate speed control without erasing the set speed memory. Pressing the ON/OFF button or turning off the ignition switch erases the set speed memory.

**To Resume Speed**

To resume a previously set speed, push the RESUME ACCEL lever up and release. Resume can be used at any speed above 20 mph (32 km/h).

**To Vary The Speed Setting**

When the speed control is ON, speed can be increased by pushing up and holding RESUME ACCEL. Release the lever when the desired speed is reached, and the new speed will be set.



Tapping RESUME ACCEL once will result in a 1 mph (1.6 km/h) speed increase. Each time the lever is tapped, speed increases so that tapping the lever three times will increase speed by 3 mph (4.8 km/h), etc.

To decrease speed while speed control is ON, push down and hold SET DECEL. Release the lever when the desired speed is reached, and the new speed will be set.

Tapping the SET DECEL button once will result in a 1 mph (1.6 km/h) speed decrease. Each time the button is tapped, speed decreases.

**NOTE:** The Electronic Speed Control System has been designed to shut down if multiple speed control switch functions are operated simultaneously in order to ensure proper operation. If this occurs, the system can be reactivated by pushing the speed control switch ON/OFF button and re-setting the desired vehicle SET speed.

### Manual Transmission

Depressing the clutch pedal will disengage the speed control. A slight increase in engine RPM before the speed control disengages is normal.

Vehicles equipped with manual transmissions may need to be shifted into a lower gear to climb hills without speed loss.

#### **WARNING!**

**Speed Control can be dangerous where the system can't maintain a constant speed. Your vehicle could go too fast for the conditions, and you could lose control. An accident could be the result. Do not use Speed Control in heavy traffic or on roads that are winding, icy, snow-covered, or slippery.**

### To Accelerate For Passing

Depress the accelerator as you would normally. When the pedal is released, the vehicle will return to the set speed.

### Using Speed Control On Hills

**NOTE:** The speed control system maintains speed up and down hills. A slight speed change on moderate hills is normal.

On steep hills, a greater speed loss or gain and/or more frequent downshifts (auto transmission only) may occur so it may be preferable to drive without speed control.

## ELECTRONIC BRAKE CONTROL SYSTEM

Your vehicle is equipped with an advanced electronic brake control system that includes ABS (Anti-Lock Brake System), TCS (Traction Control System), BAS (Brake Assist System), ERM (Electronic Roll Mitigation), and

ESP (Electronic Stability Program). All five of these systems work together to enhance vehicle stability and control in various driving conditions.

### ABS (Anti-Lock Brake System)

This system aids the driver in maintaining vehicle control under adverse braking conditions. The system controls hydraulic brake pressure to prevent wheel lock-up and help avoid skidding on slippery surfaces during braking. Refer to “Anti-Lock Brake System” in Section 5 of this manual for more information about ABS.

**WARNING!**

**ABS (Anti-Lock Brake System) cannot prevent the natural laws of physics from acting on the vehicle, nor can it increase the traction afforded by prevailing road conditions. ABS cannot prevent accidents, including those resulting from excessive speed in turns, driving on very slippery surfaces, or hydroplaning. Only a safe, attentive, and skillful driver can prevent accidents. The capabilities of an ABS-equipped vehicle must never be exploited in a reckless or dangerous manner which could jeopardize the user's safety or the safety of others.**

**TCS (Traction Control System)**

This system monitors the amount of wheel spin of each of the driven wheels. If wheel spin is detected, brake pressure is applied to the slipping wheel(s) to provide enhanced acceleration and stability. A feature of the TCS system functions similar to a limited slip differential and controls the wheel spin across a driven axle. If one wheel on a driven axle is spinning faster than the other, the system will apply the brake of the spinning wheel. This will allow more engine torque to be applied to the wheel that is not spinning. This feature remains active even if TCS and ESP are in either the "Partial Off" or "Full Off" modes. Refer to "ESP (Electronic Stability Program)" in this section.

## **BAS (Brake Assist System)**

The BAS is designed to optimize the vehicle's braking capability during emergency braking maneuvers. The system detects an emergency braking situation by sensing the rate and amount of brake application and then applies optimum pressure to the brakes. This can help reduce braking distances. The BAS complements the anti-lock brake system (ABS). Applying the brakes very quickly results in the best BAS assistance. To receive the benefit of the system, you must apply continuous braking pressure during the stopping sequence. Do not reduce brake pedal pressure unless braking is no longer desired. Once the brake pedal is released, the BAS is deactivated.

### **WARNING!**

**BAS (Brake Assist System) cannot prevent the natural laws of physics from acting on the vehicle, nor can it increase the traction afforded by prevailing road conditions. BAS cannot prevent accidents, including those resulting from excessive speed in turns, driving on very slippery surfaces, or hydroplaning. Only a safe, attentive, and skillful driver can prevent accidents. The capabilities of a BAS-equipped vehicle must never be exploited in a reckless or dangerous manner which could jeopardize the user's safety or the safety of others.**

### **ERM (Electronic Roll Mitigation)**

This system anticipates the potential for wheel lift by monitoring the driver's steering wheel input and the speed of the vehicle. When ERM determines that the rate of change of the steering wheel angle and vehicles speed are sufficient to potentially cause wheel lift, it applies the appropriate brake and may reduce engine power to lessen the chance that wheel lift will occur. ERM will only intervene during very severe or evasive driving maneuvers.

ERM can only reduce the chance of wheel lift occurring during severe or evasive driving maneuvers. It cannot prevent wheel lift due to other factors such as road conditions, leaving the roadway or striking objects or other vehicles.

**NOTE:** Anytime the ESP system is in the "Full Off" mode, ERM is disabled. Refer to ESP (Electronic Stability Program) for a complete explanation of the available ESP modes.

#### **WARNING!**

**Many factors, such as vehicle loading, road conditions and driving conditions, influence the chance that wheel lift or rollover may occur. ERM cannot prevent all wheel lift or rollovers, especially those that involve leaving the roadway or striking objects or other vehicles. Only a safe, attentive, and skillful driver can prevent accidents. The capabilities of an ERM-equipped vehicle must never be exploited in a reckless or dangerous manner which could jeopardize the user's safety or the safety of others.**

## ESP (Electronic Stability Program)

This system enhances directional control and stability of the vehicle under various driving conditions. ESP corrects for over/under steering of the vehicle by applying the brake of the appropriate wheel to assist in counteracting the over/under steer condition. Engine power may also be reduced to help the vehicle maintain the desired path.

ESP uses sensors in the vehicle to determine the vehicle path intended by the driver and compares it to the actual path of the vehicle. When the actual path does not match the intended path, ESP applies the brake of the appropriate wheel to assist in counteracting the oversteer or understeer condition.

- Oversteer - when the vehicle is turning more than appropriate for the steering wheel position.
- Understeer - when the vehicle is turning less than appropriate for the steering wheel position.

The ESP/TCS Indicator Light (located in the instrument cluster), starts to flash as soon as the tires lose traction and the ESP system becomes active. The ESP/TCS Indicator Light also flashes when TCS is active. If the ESP/TCS Indicator Light begins to flash during acceleration, ease up on the accelerator and apply as little throttle as possible. Be sure to adapt your speed and driving to the prevailing road conditions.

**WARNING!**

ESP (Electronic Stability Program) cannot prevent the natural laws of physics from acting on the vehicle, nor can it increase the traction afforded by prevailing road conditions. ESP cannot prevent accidents, including those resulting from excessive speed in turns, driving on very slippery surfaces, or hydroplaning. Only a safe, attentive, and skillful driver can prevent accidents. The capabilities of an ESP-equipped vehicle must never be exploited in a reckless or dangerous manner which could jeopardize the user's safety or the safety of others.

The ESP system has three available operating modes in 4H range. The system has one operating mode in 4L range. 2WD vehicles and 4WD vehicles in 2H range have two operating modes.

**4H Range (4WD Models) or 2WD Models***On*

This is the normal operating mode for ESP in 4H and 2WD vehicles. Whenever the vehicle is started or the transfer case (if equipped) is shifted from 4L range or NEUTRAL back to 4H range, the ESP system will be in this mode. This mode should be used for most all driving situations. ESP should only be turned to "Partial Off" or "Full Off" for specific reasons as noted below.

*Partial Off*

This mode is entered by momentarily depressing the ESP OFF switch. When in "Partial Off" mode, the TCS portion of ESP has been disabled and the ESP/TCS Indicator Light will be illuminated. All other stability features of ESP function normally. This mode is intended to be used if the vehicle is in deep snow, sand, or gravel conditions and more wheel spin than ESP would normally allow is

required to gain traction. To turn ESP on again, momentarily depress the ESP OFF switch. This will restore the normal “ESP On” mode of operation.

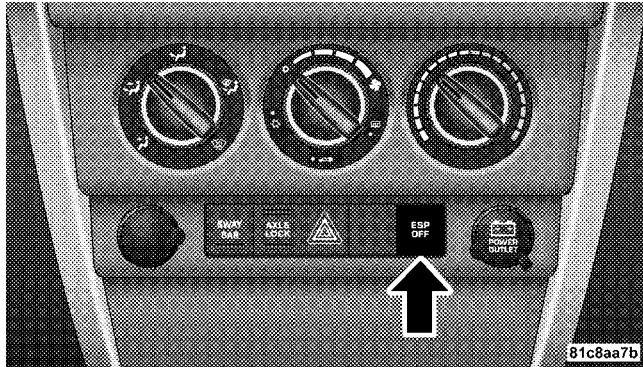

ESP OFF Switch

**NOTE:** To improve the vehicle’s traction when driving with snow chains, or starting off in deep snow, sand, or gravel, it may be desirable to switch to the “Partial Off”

mode by pressing the ESP OFF switch. Once the situation requiring ESP to be switched to the “Partial Off” mode is overcome, turn ESP back on by momentarily depressing the ESP OFF switch. This may be done while the vehicle is in motion.

### *ESP Off (4H Range Only)*

This mode is intended for off-highway or off-road use when ESP stability features could inhibit vehicle maneuverability due to trail conditions. This mode is entered by depressing and holding the ESP OFF switch for five seconds when the vehicle is stopped and the engine is running. In this mode, all ESP and TCS stability features are turned off except for the “limited slip” feature described in the TCS section. After five seconds, a chime will sound, the ESP/TCS Indicator Light will illuminate, and the “ESP OFF” message will appear in the odometer. Refer to “Compass and Mini-Trip Computer — If Equipped” in Section 4 of this manual. To turn ESP on



again, momentarily depress the ESP OFF switch. This will restore the normal “ESP On” mode of operation.

**NOTE:** The ESP system will change to “Partial Off” mode if the vehicle speed exceeds 40 mph (64 km/h). After the vehicle speed is reduced below 35 mph (56 km/h), the ESP system will return to “Full Off” mode.

**NOTE:** The “ESP OFF” message will display and the audible chime will sound when the shift lever is placed in the PARK position from any position other than PARK, and then moved out of the PARK position. This will occur even if the message was previously cleared.

### WARNING!

**With the ESP switched off, the enhanced vehicle stability offered by ESP and ERM are unavailable. In an emergency evasive maneuver, the ESP and ERM systems will not engage to assist in maintaining stability. The “Full Off” ESP mode is intended for off-road use only.**

### 4L Range (4WD Models)

#### *ESP Off*

This is the normal operating mode for ESP in 4L range. Whenever the vehicle is started in 4L range, or the transfer case (if equipped) is shifted from 4H range or NEUTRAL to 4L range, the ESP system will be in this mode. In 4L range, ESP and TCS, except for the “limited slip” feature described in the TCS section, are turned off until the vehicle reaches a speed of 40 mph (48 km/h). At

40 mph (48 km/h), the normal ESP stability function returns but TCS remains off. When the vehicle speed drops below 35 mph (40 km/h), the ESP system shuts off. ESP is off at low vehicle speeds in 4L range so that it will not interfere with off-road driving, but the ESP function returns to provide the stability feature at speeds above 40 mph (48 km/h). The ESP/TCS Indicator Light will always be illuminated in 4L range when ESP is off.

**NOTE:** The “ESP OFF” message will display and the audible chime will sound when the shift lever is placed in the PARK position from any position other than PARK, and then moved out of the PARK position. This will occur even if the message was previously cleared.

### WARNING!

**With the ESP switched off, the enhanced vehicle stability offered by ESP and ERM are unavailable. In an emergency evasive maneuver, the ESP and ERM systems will not engage to assist in maintaining stability. The “Full Off” mode is intended for off-road use only.**

**3**

### Disabling ESP for Modified Vehicles (4WD Models Only)

Vehicles modified with larger tires and/or suspension lifts may experience early ESP activations as compared to a non-modified production vehicle depending on lift size, tire size, suspension changes and/or driving habits. If early ESP activations are experienced while driving a modified vehicle, the additional ability to permanently turn off ESP is available. A steering wheel/ESP button

maneuver must be performed to permanently disable ESP and defeat the functionality of the ESP switch. Repeating the procedure will return the system to normal ESP operation and restore ESP switch functionality allowing ESP “Partial” or “Off” modes.

### WARNING!

**With ESP in the permanent disable mode, enhanced vehicle stability offered by the ESP and ERM systems is unavailable. In an emergency evasive maneuver, the ESP and ERM systems will not engage to assist in maintaining stability. This disabled mode is intended for off-highway or off-road use only. Vehicle modifications requiring the owner to configure the vehicle in the ESP disabled mode, will seriously affect the vehicles roadworthiness and safety and may lead to loss of control and/or accident resulting in possible serious or fatal injuries.**

The following procedure will disable (or re-enable) ESP functionality in the vehicle.

1. Shift the transfer case into the 4H range position.
2. Turn the steering wheel until it is centered and the wheels are pointed straight ahead.
3. Cycle the ignition key OFF to ON.
4. Wait approximately five seconds for the system bulb check.
5. Turn and hold the steering wheel one-half turn to the right (clockwise).
6. Press and hold the ESP OFF button for seven seconds.
7. Turn the steering wheel back to center, and turn and hold an additional one-half turn to the left (counterclockwise).
8. Press and hold the ESP OFF button for seven seconds.

9. Turn the steering wheel back to center.
10. Press and hold the ESP OFF button for seven seconds.
11. Cycle the ignition key to OFF.

After performing the ESP disable procedure correctly, "ESP OFF" will be displayed in the odometer for approximately 12 seconds each time the ignition is moved to ON. Repeating the ESP disable procedure will re-enable normal ESP operation.

### ESP/BAS Warning Light

**ESP  
BAS** The malfunction indicator lamp for the ESP is combined with the BAS indicator. The ESP/BAS Warning Light in the instrument cluster comes on when the ignition switch is turned to the "ON" position. It should go out with the engine running.

If the ESP/BAS Warning Light comes on continuously with the engine running, a malfunction has been detected in either the ESP or the BAS system, or both. If this light remains on after several ignition cycles, and the vehicle has been driven several miles at speeds greater than 30 mph (48 km/h), see your authorized dealer as soon as possible to have the problem diagnosed and corrected.

#### NOTE:

- "The ESP/BAS Warning Light comes on momentarily each time the ignition switch is turned ON.
- Each time the ignition is turned ON, the ESP System will be ON even if it was previously turned off.
- The ESP Control System will make buzzing or clicking sounds when it is active. This is normal; the sounds will stop when ESP becomes inactive following the maneuver that caused the ESP activation.

## ELECTRICAL POWER OUTLET

This vehicle has two auxiliary power outlets that can provide up to 20 Amps of current for accessories designed for use with the standard power outlet adapters. The outlet located in the lower portion of the instrument panel has a snap-on plastic cap so that it can be covered when not in use. As a safety precaution, the outlet in the instrument panel only operates with the ignition switch ON. When the optional cigar lighter heating element is used, it heats when pushed in and pops out automatically when ready for use. **To preserve the heating element, do not hold the lighter in the heating position.**

The right side outlet is powered directly from the battery (power available at all times). Items plugged into this outlet may discharge the battery and/or prevent engine starting.

The left side outlet has power available only when the ignition is on. This outlet will also operate a conventional cigar lighter unit.

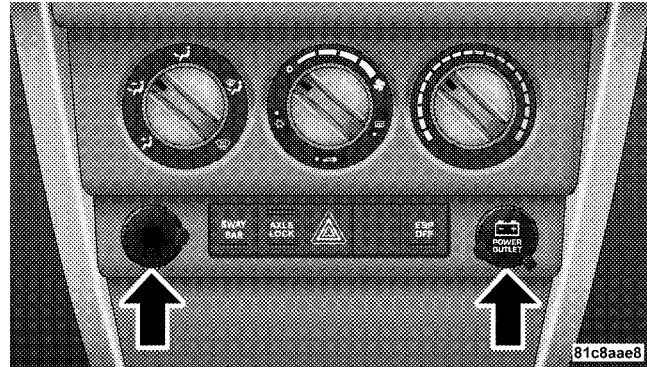

Power Outlets

## Electrical Outlet Use With Engine Off

### WARNING!

- Many accessories that can be plugged in draw power from the vehicle's battery, even when not in use (i.e., cellular phones, etc.). Eventually, if plugged in long enough, the vehicle's battery will discharge sufficiently to degrade battery life and/or prevent engine starting.
- Accessories that draw higher power (i.e., coolers, vacuum cleaners, lights, etc.), will degrade the battery even more quickly. Only use these intermittently and with greater caution.
- After the use of high-power draw accessories, or long periods of the vehicle not being started (with accessories still plugged in), the vehicle must be driven a sufficient length of time to allow the alternator to recharge the vehicle's battery.
- Power outlets are designed for accessory plugs only. Do not hang any type of accessory or accessory bracket from the plug.

## CUPHOLDERS

### Front Cupholders

The front cupholders are located in the center console.

**NOTE:** The front cupholder insert is removable for cleaning.

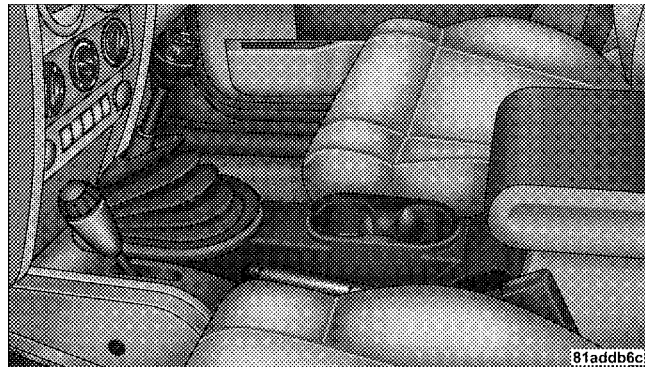

Front Cupholders

## Rear Cupholders

The rear cupholders are located on the back of the center console.

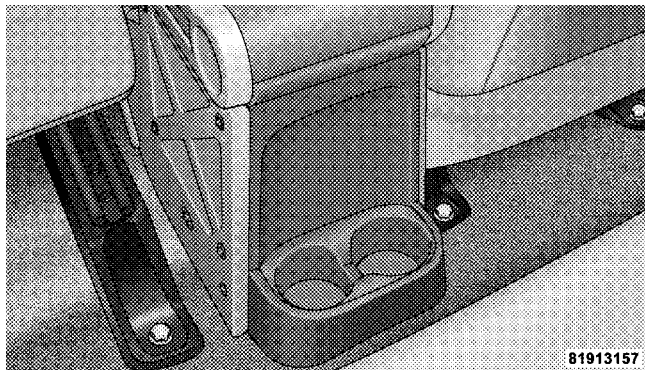

Rear Cupholders

## STORAGE

### Console Storage Compartment

To lock or unlock, insert ignition key and turn. To open, press the latch and lift cover.

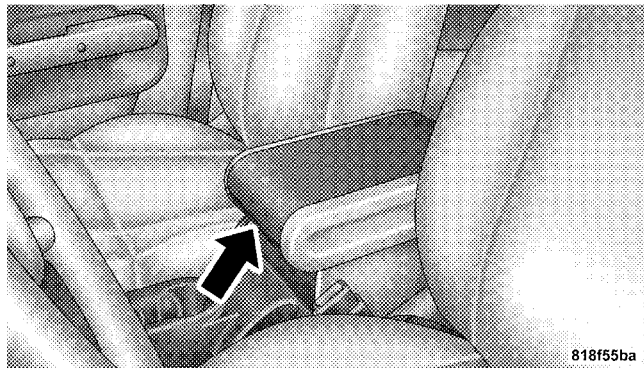

Center Console

## Rear Storage Compartment

The rear storage compartment cover is held by a spring-loaded latch. In order to remove the rear storage compartment cover, use the following procedure:

**NOTE:** The rear storage compartment latch should not be used as cargo tie-down.

1. Flip up pull loop so it is perpendicular (straight up) to the top surface of the tray.
2. Pull up on loop and twist 90 degrees, so it is parallel to the slotted hole in tray.
3. Open rear compartment cover.

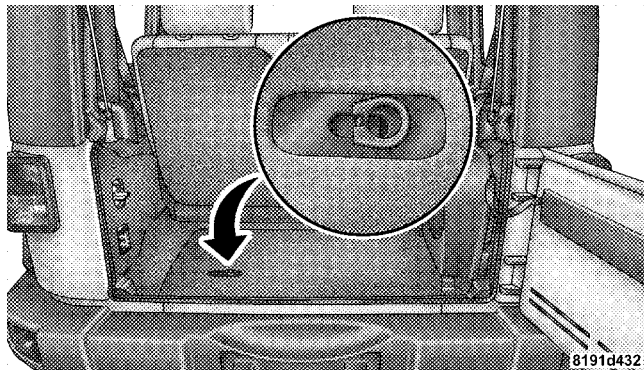

Rear Storage Cover



## DUAL TOP — IF EQUIPPED

If your vehicle is equipped with a Dual Top, **you must remove one of the tops from the vehicle. If the soft top is removed, the pivot brackets must also be removed from the sport bar.** The soft top was installed at the factory for shipping purposes only. **The soft top and the hard top are to be used independently.** Removal is mandatory to prevent any possible wear and tear on the soft top. Your vehicle warranty will not cover damage resulting from both tops remaining on the vehicle at the same time for extended periods of time.

### Removing The Soft Top

1. Locate and remove the two boxes that contain the following items:

- Right and left door frames
- Door frame attachment knobs (four for two-door models, six for four-door models)
- Right and left quarter windows
- Rear window
- Two rear window roll up straps
- Two Sunrider secure straps (If Equipped)
- Two rear swing gate brackets

2. Remove the hard top. Refer to “Freedom Top Three-Piece Modular Hard Top — Front/Rear Panel Removal” later in this section.

3. Remove the soft top bow assembly pivot bracket screws (two per side) using a #T30 Torx® head driver.

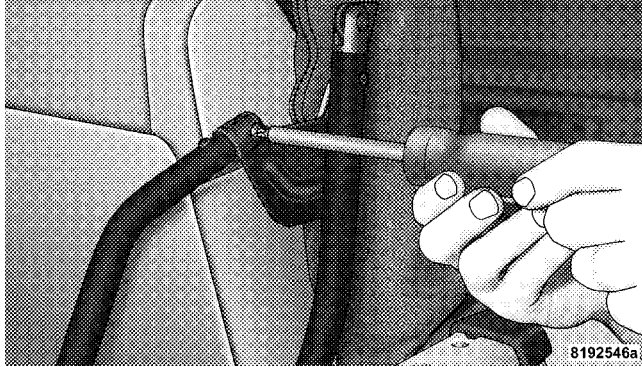

4. Using a rubber mallet, carefully tap the knuckles from the left and right metal pivot brackets. Remove the soft top from the vehicle and store in a clean, dry location.

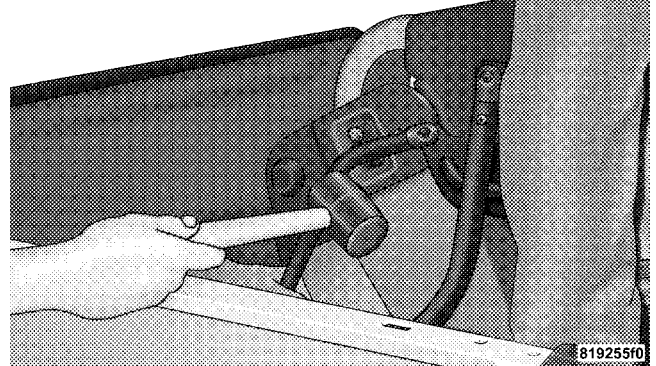

3

5. Unzip the zipper on the sport bar cover to expose the pivot brackets. Remove the brackets using a #T30 Torx® head driver. Recover and re-zip the sports bar cover. Store pivot brackets and screws in a safe place.

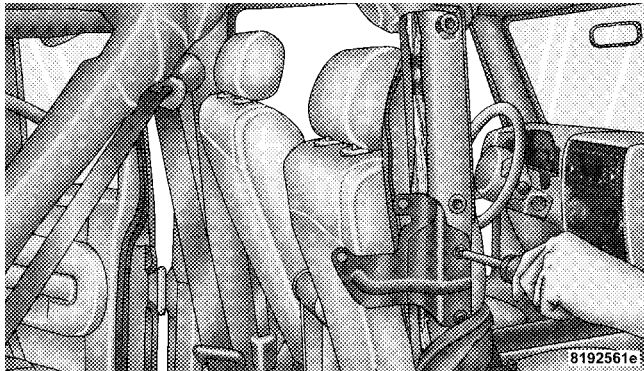

6. Reinstall the hard top. Refer to “Freedom Top Three-Piece Modular Hard Top — Front/Rear Panel Installation” later in this section.

## Installing the Soft Top

**NOTE:** The following procedures are for first time set up only. For future soft top procedures, refer to “Soft Top” in this section.

1. Locate and remove the following items prior to hard top removal:
  - Right and left door frames
  - Door frame attachment knobs (four for two-door models, six for four-door models)
  - Right and left quarter windows
  - Rear window
2. Remove the hard top. Refer to “Freedom Top Three-Piece Modular Hard Top — Front/Rear Panel Removal” later in this section.

3. Install the door frames. Refer to “Door Frame” in this section.
4. If the soft top has been removed, follow these steps to reinstall the soft top. If the soft top is on the vehicle, proceed to step #5.
  - a. If the pivot brackets have been removed, unzip the sport bar covers and attach the pivot brackets to the sports bar with the four screws that were removed using a #T30 Torx® head driver. Re-cover and re-zip sport bar covers.

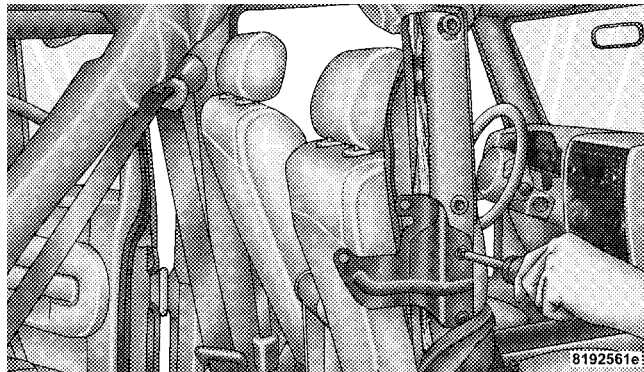

- b. Lay the soft top into the rear of the vehicle with the bows pointing forward and the curved portion of the bows facing upward.

c. Tap the knuckles on the side with a rubber mallet to reattach them to the metal pivot brackets.

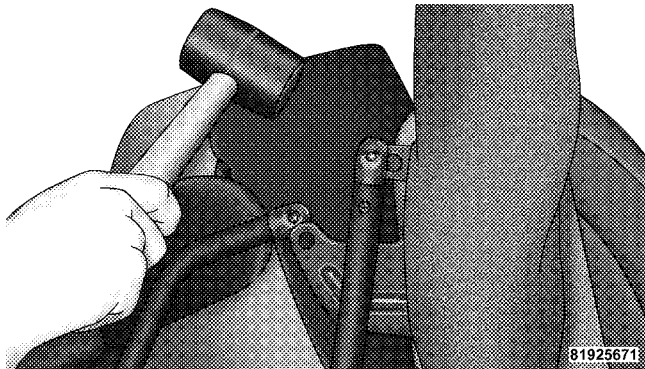

d. Screw the pivot screws back into place using a #T30 Torx® head driver. Secure them until they are snug being careful not to cross-thread the screws or over-tighten.

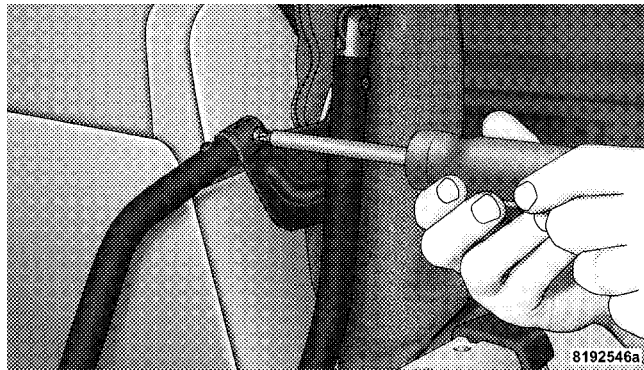

**CAUTION!**

**Do not overtighten the screws. You can strip the screws if they are overtightened.**

5. Unsnap and remove the black boot cover. This cover should be discarded. It was intended as a protective cover for shipping only.

**NOTE:** A visual instruction sheet is enclosed in the dual top wrap.

6. Remove the swing gate bar (black metal bar for bottom of rear window) and set aside.

**NOTE:** Be sure the wire harness in the left rear corner is not tangled in the soft top bows before you lift the top.

7. Put up the soft top. Refer to “Soft Top — Putting Up the Soft Top” in this section.

## FREEDOM TOP THREE-PIECE MODULAR HARD TOP

### CAUTION!

- The hard top is not designed to carry any additional loads such as roof racks, spare tires, building, hunting, or camping supplies, and/or luggage, etc. Also, it was not designed as a structural member of the vehicle, and thus cannot properly carry any additional loads other than environmental (rain, snow, etc.).

### CAUTION!

Do not move your vehicle until the top has been either fully attached to the windshield frame and bodyside, or fully removed.

## Front Panel(s) Removal

**NOTE:** Left panel must be removed before removing right panel.

1. Fold down the sun visor, and move to the side.
2. Turn center L-shaped locks (2) from center of roof panel.

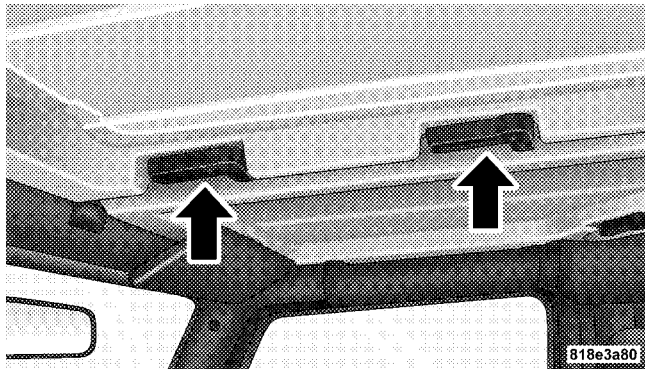

3. Turn rear L-shaped lock (located above shoulder belt anchorage).

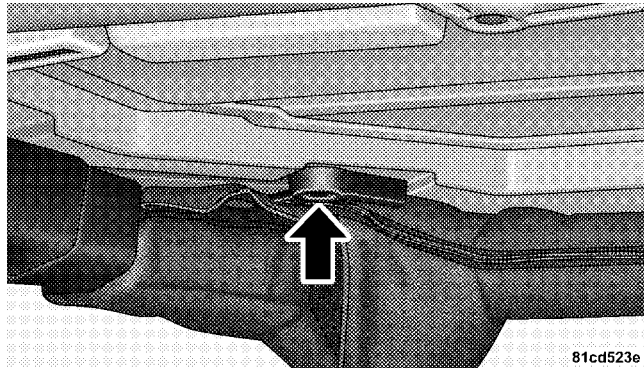

4. Turn rear fasteners (knobs) (located on overhead speaker bar assembly) counterclockwise until they can be removed.

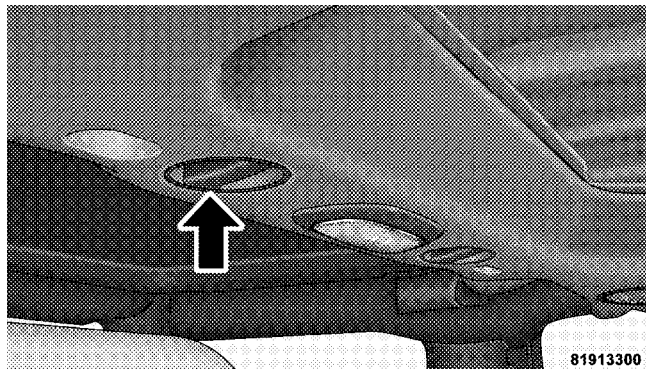

5. Unlatch the header panel latch located at the top of the windshield.

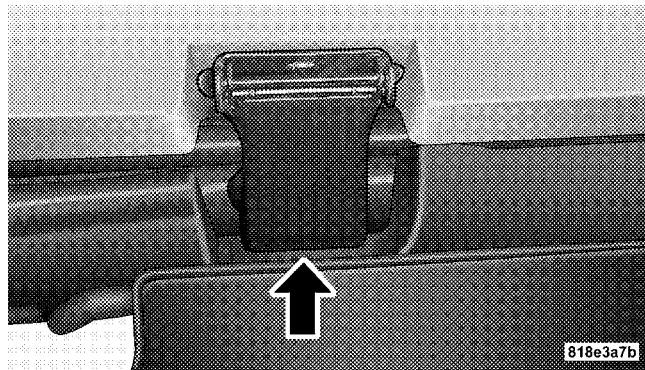

3

6. Remove panel.

To remove right panel, follow steps above except for step 2.



## Front Panel(s) Installation

**NOTE:** The front panel(s) must be positioned properly to ensure sealing. Set the panels on the windshield frame so that there is no overhang. Also, make sure that the panels are sitting flush with the body.

1. Install right panel first, then the left panel.
2. Reinstall panel(s) using the same steps for removal in reverse order.

## Front Panel(s) Installation Only (With Rear Hard Top Removed)

1. Turn left and right panels over and move spacer block (located on rear of panel) upward 90 degrees.

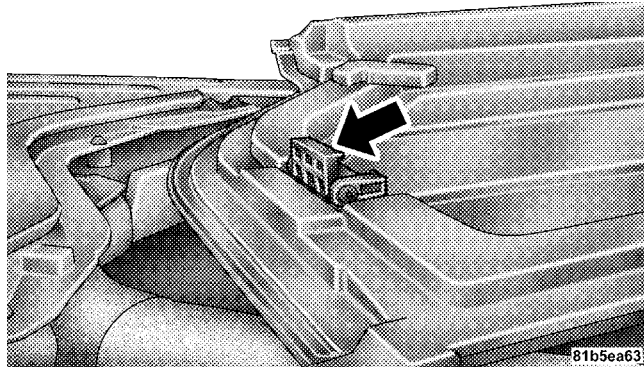

**NOTE:** The front panel(s) must be positioned properly to ensure sealing. Set the panels on the windshield frame so that there is no overhang. Also, make sure that the panels are sitting flush with the body.

2. Install right panel first, then the left panel.

3. Reinstall panel(s) using the same steps for removal in reverse order.

### Rear Hard Top Removal

1. Remove both front panels. Refer to “Front Panel(s) Removal” in this section.

2. Open both doors.

3. Remove the two Torx® head screws that secure the hard top at the B-pillar (near top of door) using a #40 Torx® head driver (4-Door Only).

4. Remove the six Torx® head screws that secure the hard top to the vehicle (along the interior bodyside) using a #40 Torx® head driver.

5. Open swing gate all the way to ensure clearance of the rear window glass. Lift rear window glass.

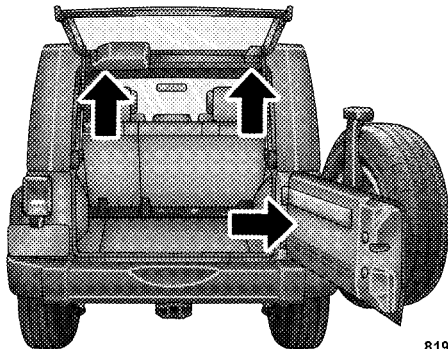

81947a57

3

6. Locate the wiring harness on the left rear inside corner of the vehicle.

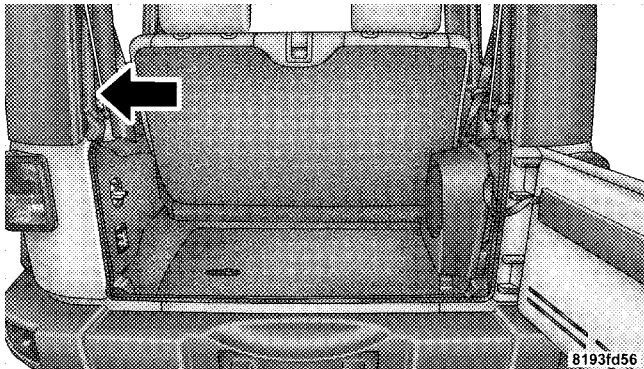

7. Disconnect the rear window washer hose and install the tethered cap.

### CAUTION!

Make sure storage cap is installed to prevent foreign materials from entering washer tube and clogging system, and also to prevent fluid from being sprayed into the rear of the vehicle.

8. Disconnect the wire harness from the hard top by pressing the tab at the side of the connector and pulling to disconnect.

**NOTE:** If the red latch on the connector is locked, push the red latch to the right until you can only see the latch on one end (right) of the connector. This will unlock the connector tab, allowing the tab to be pressed down and enabling the harness to be disconnected from the hard top.

## Rear Hard Top Installation

**NOTE:** If the door frames are installed from soft top usage, they must be removed prior to installation of the hard top.

1. Inspect the hard top seals for damage and replace if necessary.
2. Install the hard top using the same steps for removal in reverse order.

**NOTE:** The hard top must be positioned properly to ensure sealing. Also, make sure that the hard top is sitting flush with the body at the sides and check to ensure that there is a uniform gap between the lift glass and hard top.

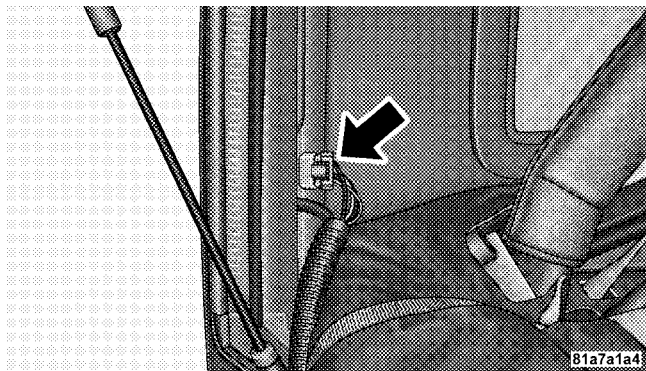

9. Close the swing gate.

10. Remove the hard top from the vehicle. Place on a soft surface to prevent damage.

## DOOR FRAME

### WARNING!

Do not drive your vehicle on pavement with the door frame(s) removed as you will lose the protection that they can provide. This procedure is furnished for use during off-road operation only.

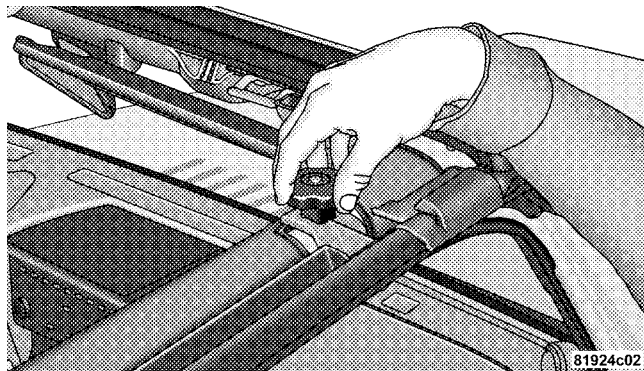

### Door Frame Removal (Two-Door Models)

1. Unscrew and remove the door frame attachment knobs (two per side).

### WARNING!

Use both hands to remove the door frames. The door frames will fold and could cause injury if both hands are not used.

- Place one hand on the upper rear and one hand on the front of the door frame.
- Pull the frame towards you with your rearward hand to remove the frame from the vehicle.

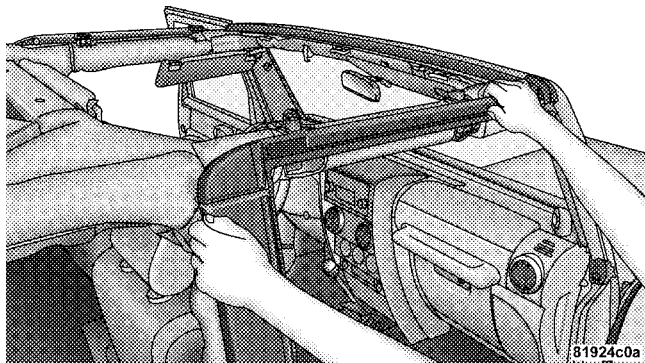

- Screw the knobs back into the door frame and fold for storage. Store in a secure location.

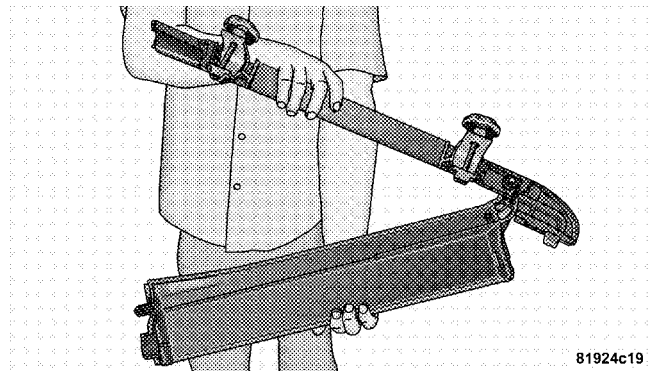

3

**WARNING!**

Never store the door frames in your vehicle. In an event of an accident, a loose door frame may cause personal injury. If removed, always store the door frames outside of the vehicle.

### Door Frame Installation (Two-Door Models)

1. Unfold door frame and unscrew thumbscrews.
2. Set the door frame pin into the hole on top of the body side, behind the door opening.

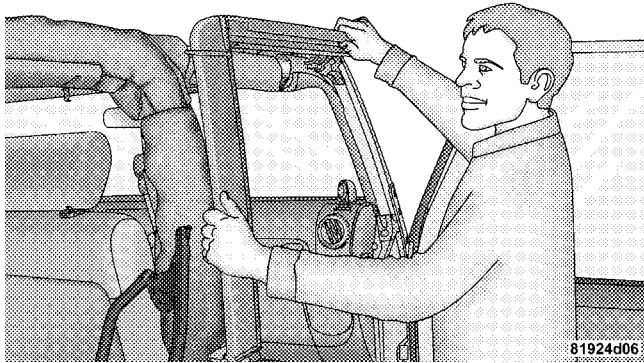

3. After the door frame pin has been set into the body side hole, carefully set the front of the door frame into the rubber seal at the top of the windshield.
4. Starting with the front of the door frame, clip it over the metal side bar and then clip the rear, making sure that the material for the side bar covers is not pinched by the door frame.

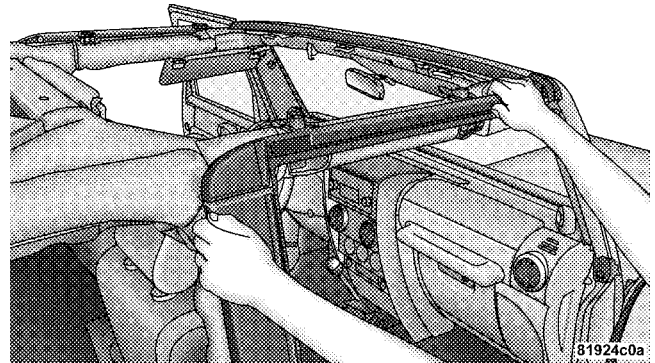

5. Starting with the front knob, screw in and tighten both knobs. Repeat on the other side.

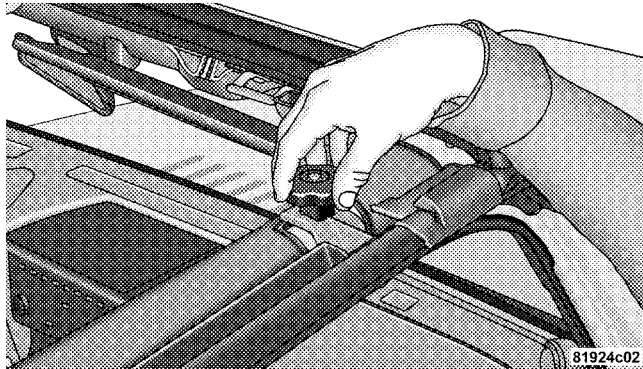

### Door Frame Removal (Four-Door Models)

1. Unscrew and remove the two forward most door frame attachment knobs.

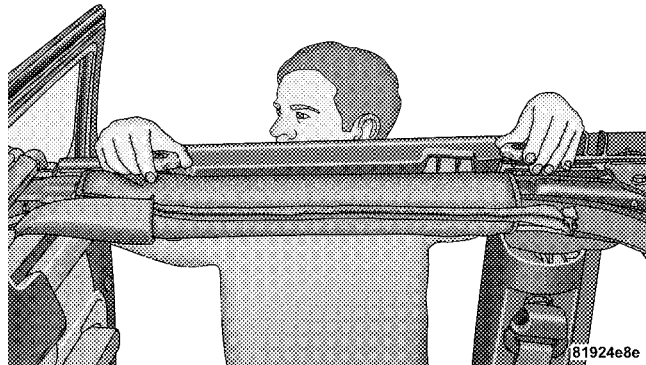

3



**WARNING!**

Use both hands to remove the door frames. The door frames will fold and could cause injury if both hands are not used.

2. Place one hand on the upper rear and one hand on the upper front of the front door frame.

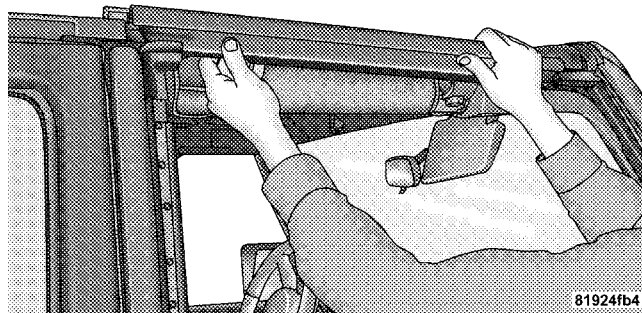

3. Pull the frame towards you with your front hand to remove the frame from the vehicle.

4. Unscrew and remove the remaining door frame attachment knob on the rear door frame.

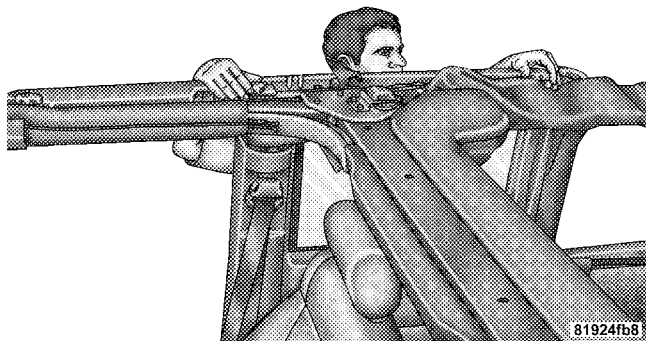

5. Place one hand on the upper rear and one hand on the upper front of the rear door frame. Pull the frame towards you with your rear hand to remove the frame from the vehicle.

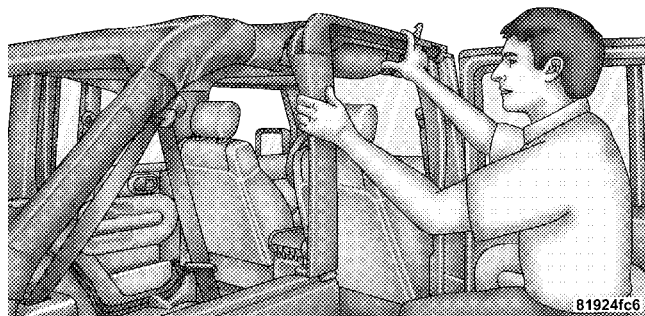

6. Screw the knob back into the door frame and fold for storage. Store in a secure location.

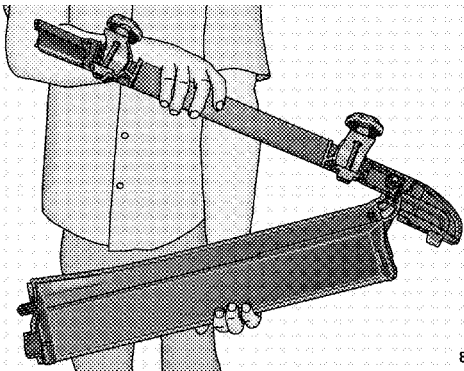

81924c19

### WARNING!

- **Never store the door frames in your vehicle. In an event of an accident, a loose door frame may cause personal injury. If removed, always store the door frames outside of the vehicle.**

### Door Frame Installation (Four-Door Models)

1. Install the rear door frame first.
2. Set the door frame pin into the hole on top of the body side, just behind the rear door opening.

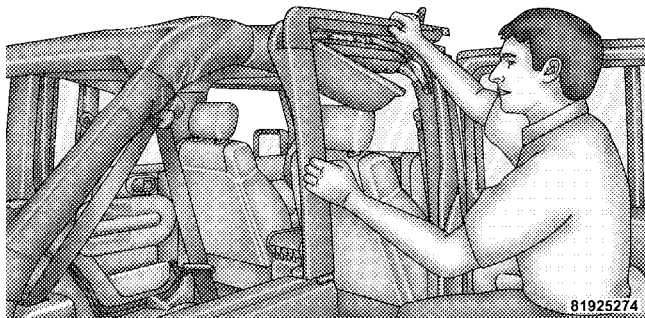

3. Position the top of the door frame against the metal sport bar and press onto the side bar making sure not to pinch the material of the sports bar covers and to ensure it is properly positioned on the seal above the front of the rear door.

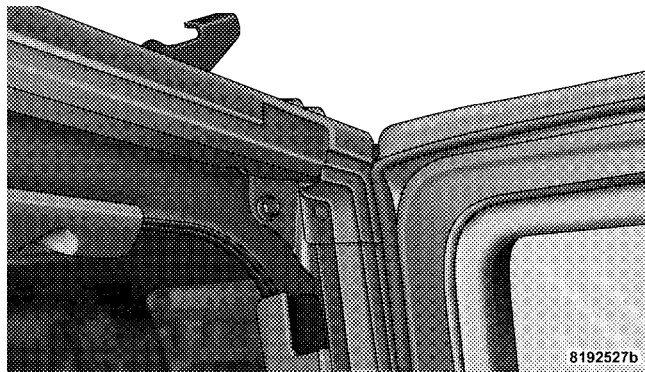

4. Loosely install the rear knob (long knob) to hold the door rail in position.

5. Carefully set the front of the front door frame in the rubber seal at the top of the windshield. Then, clip the front of the door rail over the side bar making sure that the material for the side bar cover is not pinched by the door frame. Position the rear of the front door frame to lay on top of the front of the rear door frame.

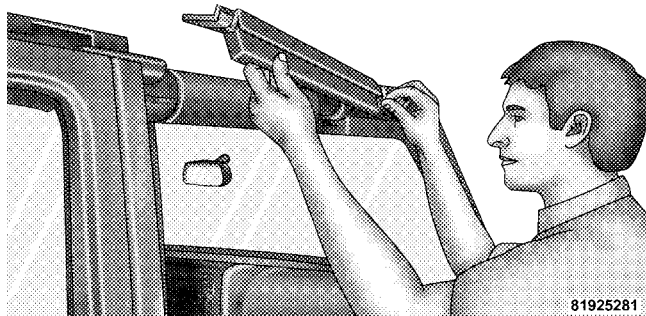

6. Loosely install both knobs beginning with the front knob (long knob). Then, install the middle knob (short knob) through the front and rear door frames and screw into the top of the B-pillar.

7. Tighten the front knob, then the rear most knob, and then the middle knob. Repeat this procedure for the other side.

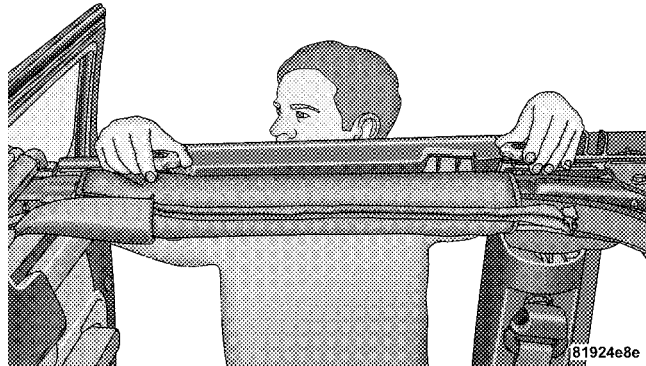

**SOFT TOP (TWO-DOOR MODELS)****CAUTION!**

- The soft top is not designed to carry any additional loads such as roof racks, spare tires, building, hunting, or camping supplies, and/or luggage, etc. Also, it was not designed as a structural member of the vehicle, and thus cannot properly carry any additional loads other than environmental (rain, snow, etc.).

If the temperature is below 72°F (24°C) and/or the top has been folded down for a period of time, the top will appear to have shrunk when you raise it, making it difficult to put up. This is caused by a natural contraction of the vinyl coating on the fabric top.

Place the vehicle in a warm area. Pull steadily on the top fabric. The vinyl will stretch back to its original size and the top can then be installed. **If temperature is 41°F (5°C) or below, do not attempt to put the top down or roll the rear or side curtains.**

**3**

**CAUTION!**

- Do not run a fabric top through an automatic car wash. Window scratches and wax build up may result.
- Do not lower the top when the temperature is below 41°F (5°C). Damage to the top may result.
- Do not move your vehicle until the top has been either fully attached to the windshield frame, or fully lowered.
- Do not lower the top with the windows installed. Window and top damage may occur.
- Refer to “Appearance Care for Fabric Top Models” in Section 7 of this manual. It contains important information on cleaning and caring for your vehicle’s fabric top.
- Do not use any tools (screwdrivers, etc.) to pry or force any of the clamps, clips, or retainers securing the soft top. Do not force or pry the soft top framework when opening or closing. Damage to the top may result.

**WARNING!**

- Do not drive vehicle with rear window curtain up unless side curtains are also removed. Dangerous exhaust gases could enter the vehicle causing harm to the driver and passengers.
- The fabric upper doors and fabric top are designed only for protection against the elements. Do not rely on them to contain occupants within the vehicle or to protect against injury during an accident. Remember, always wear seat belts.

## Folding Down The Soft Top

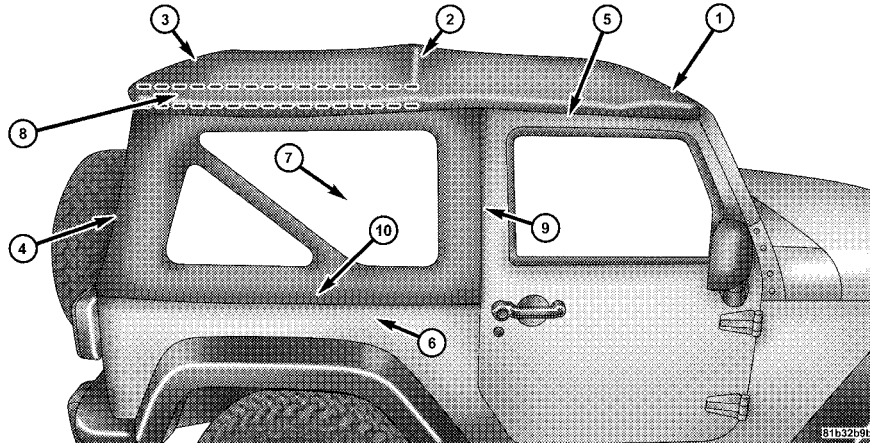

3

- 1 — Header Bow
- 2 — 2-Bow
- 3 — 3-Bow
- 4 — Sail Panel
- 5 — Plastic Retainer

- 6 — Body Side Retainer
- 7 — Quarter Window
- 8 — Check Strap
- 9 — Front Retainer — Quarter Window
- 10 — Bottom Retainer — Quarter Window



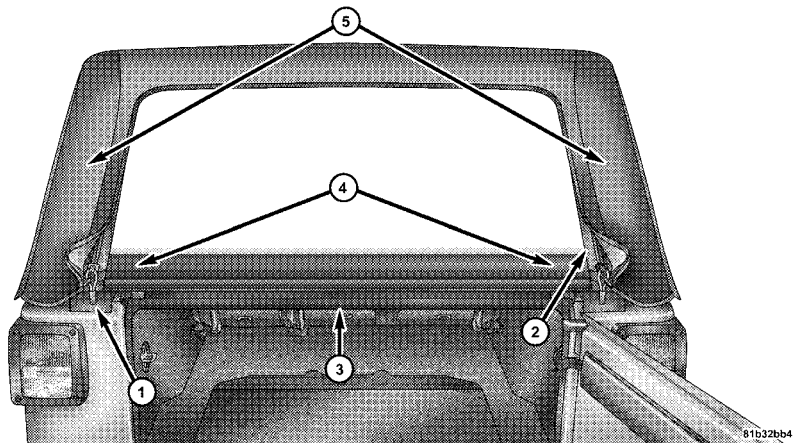

81b32bb4

- 1 — Zipper Start
- 2 — Zipper Finish
- 3 — Swing Gate Bar
- 4 — Swing Gate Brackets
- 5 — Sail Panels

**NOTE:** Clean side and rear windows before removal to assist in preventing scratching during removal of the soft top. If zippers are difficult to operate due to road dust, etc., clean them with a mild soap solution and a small brush. Cleaning products are available through your authorized dealer.

1. If your vehicle has half doors, remove each half door window by opening the door and lifting the half door window out.

**NOTE:** Stow half door windows carefully outside of the vehicle, never inside to avoid scratches.

2. Insert finger behind the plastic retainer. Pull down and roll the retainer out of the channel. Repeat this on the opposite side.

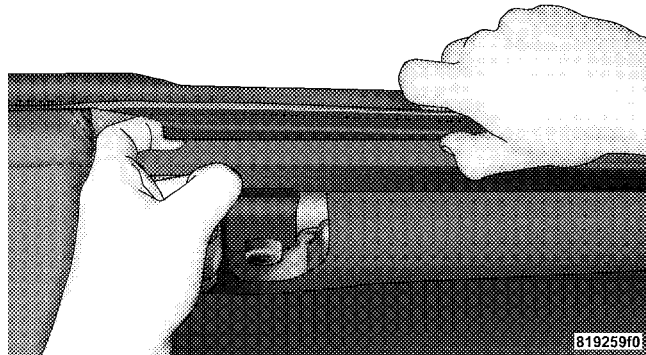

3. Unclip and move the sun visors to the side.
4. Release the header latches and leave the hooks in the loops on the windshield.

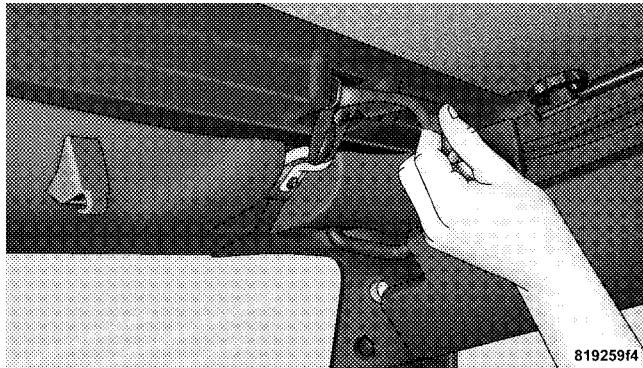

5. Open the swing gate.
6. Before unzipping the rear window, release the first 3 in (7.6 cm) of both sail panels from the channel. Remove the swing gate bar by pulling it straight rearward out of the swing gate brackets.

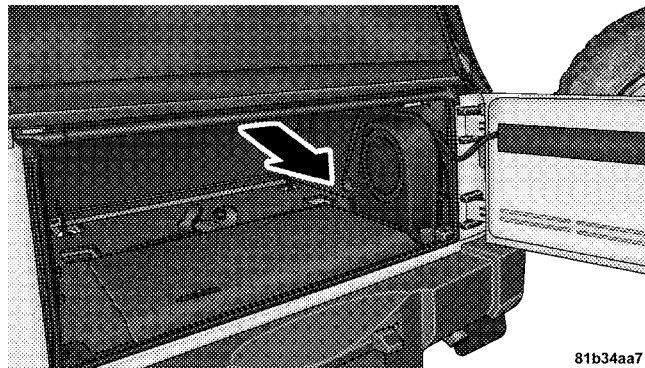

- Unzip the rear window starting at the right lower corner of the window. Pull the zipper up, across the top and down to the left lower corner. **Zipper pulls will stay on the rear window.** Pull down on the rear window to disengage from the zipper on the top cover. Stow the windows carefully to avoid scratching.

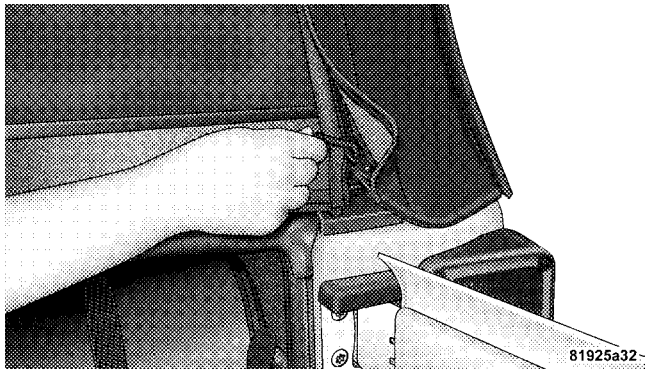

7. Undo the Velcro® that runs along the top and rear edge of the side window.
8. Beginning from the rear lower corner, completely unzip the window.

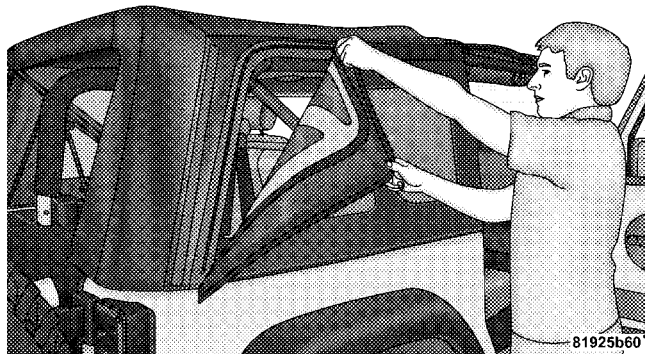

9. Once unzipped, remove side window retainers from the door channel and body side channel. Repeat this step on the opposite side.

10. Finish releasing the sail panel retainers from the body side channel at the rear corners of the vehicle.

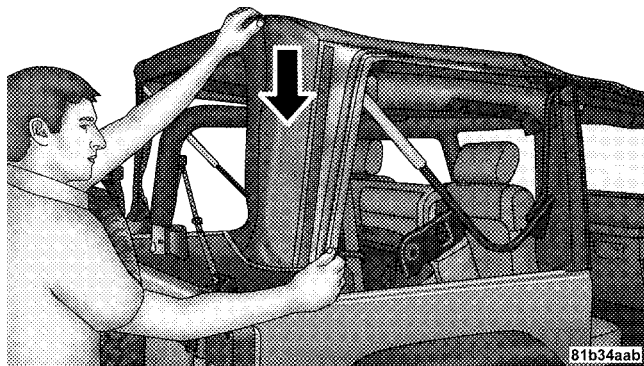

**NOTE:** When releasing the sail panel retainers, it is helpful to pull down on the rear roof bow.

11. As you begin to lower the top, fold the sail panels so that they rest on top of the soft top.

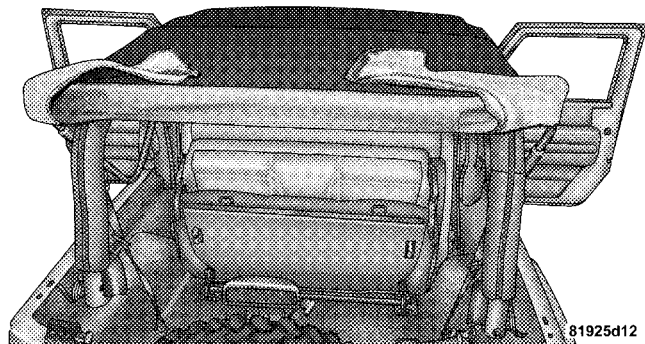

12. The swing gate brackets do not need to be removed unless the hard top is being installed. To remove the swing gate brackets, pull the front of the bracket forward while rolling the entire bracket back in towards the vehicle to disengage.

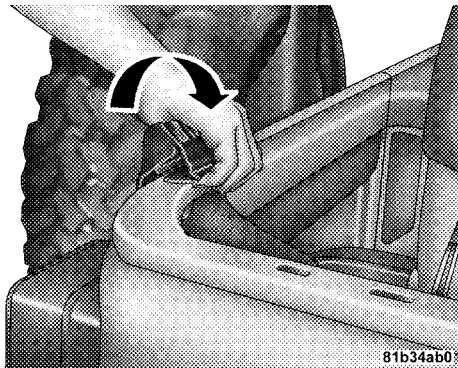

13. Completely release the latches from the loops on the windshield frame. **If your vehicle is not equipped with the Sunrider package, proceed to Step 16.**

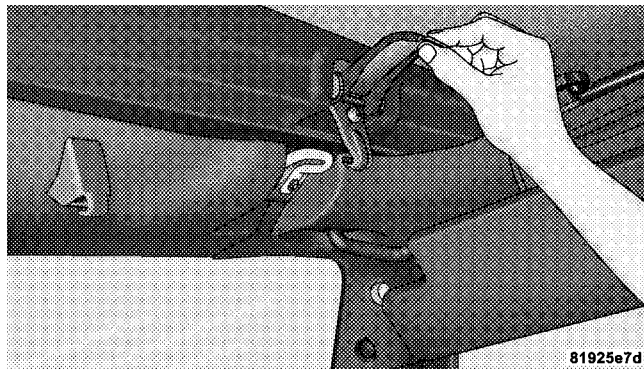

150 UNDERSTANDING THE FEATURES OF YOUR VEHICLE

14. Make sure the plastic sleeves are slid forward over the Sunrider link (Sunrider Models Only).

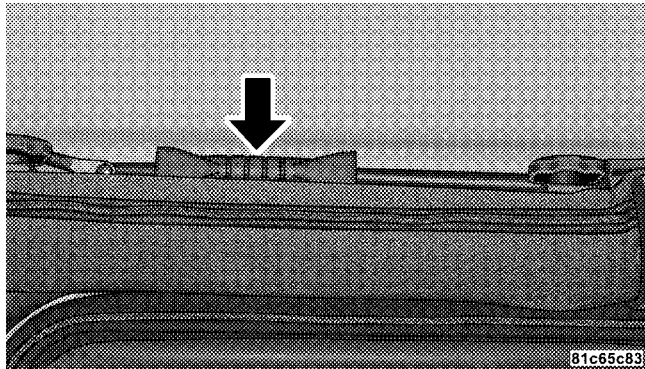

15. Unlatch the side bows from both door rails (Sunrider Models Only).

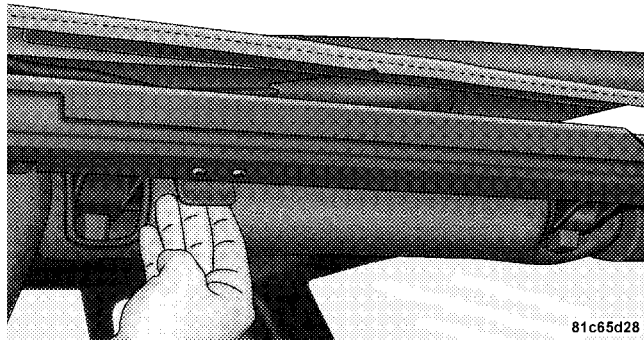

16. Before lowering the top, open the swing gate to prevent possible damage to the rear center high-mounted brake lamp. Move to the front of the vehicle. Grasp the side bow behind the header and lift the top, folding it toward the rear of the vehicle.

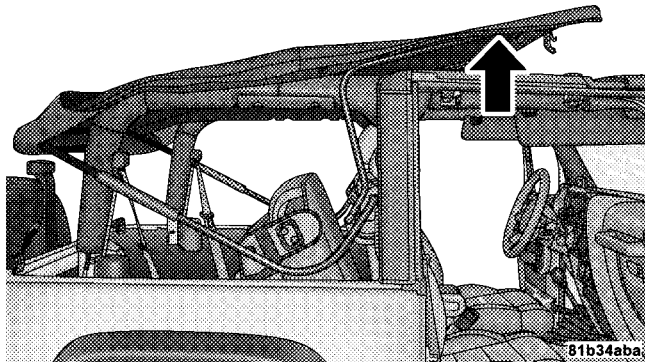

17. Tuck the fabric and the check straps between the bows and as far inward as possible. This will keep any

portion of the top from flapping outside of the vehicle. When the top is completely down, position the drip rails so they make a “v-shape”, this prevents damage to the soft top material.

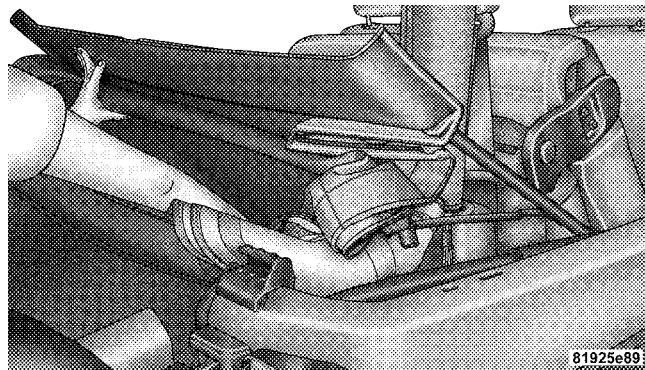

3

18. Close front header latches.

19. Remove door frames, if desired. Refer to “Door Frame” in this section.



## Putting Up The Soft Top

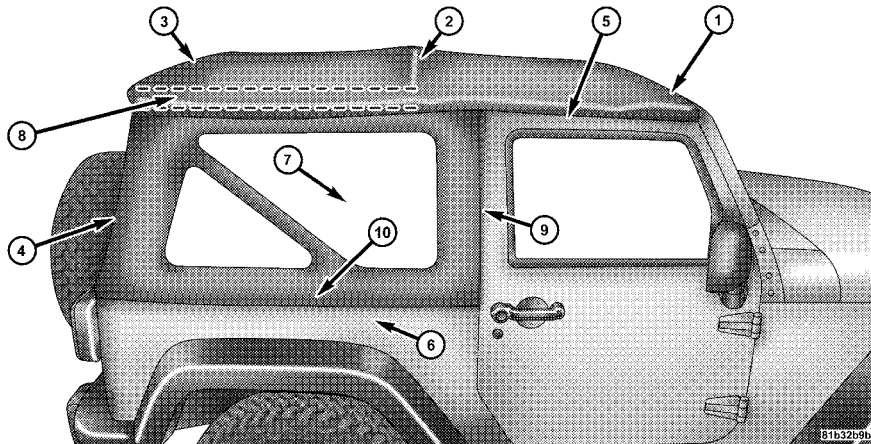

- 1 — Header Bow
- 2 — 2- Bow
- 3 — 3-Bow
- 4 — Sail Panel
- 5 — Plastic Retainer

- 6 — Body Side Retainer
- 7 — Quarter Window
- 8 — Check Strap
- 9 — Front Retainer — Quarter Window
- 10 — Bottom Retainer — Quarter Window

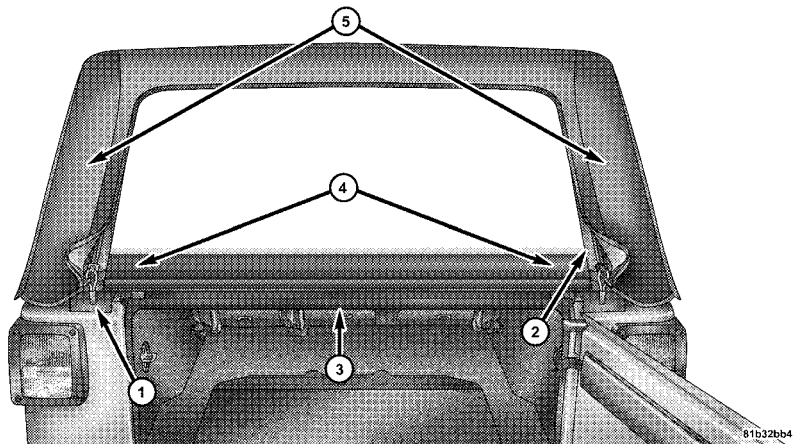

- 1 — Zipper Start
- 2 — Zipper Finish
- 3 — Swing Gate Bar
- 4 — Swing Gate Brackets
- 5 — Sail Panels

1. Unclip and move the sun visors to the side.
2. Install door frames, if removed. Refer to "Door Frame" in this section.
3. Make sure the plastic sleeve is slid rearward over Sunrider link (Sunrider Models Only).

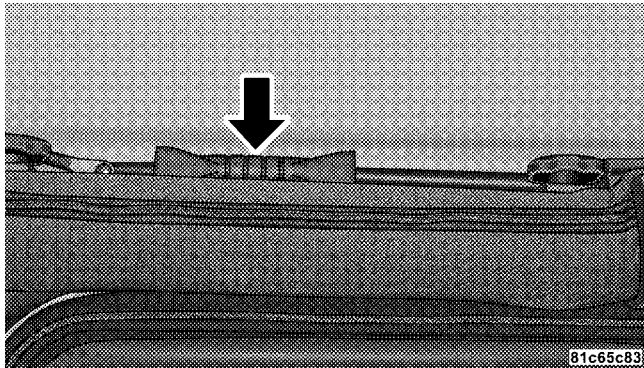

4. Standing on the side of the vehicle, lift the top by the side bow and the 2-bow (middle bow) up and over the sports bar until the header rests on the top of the windshield frame.

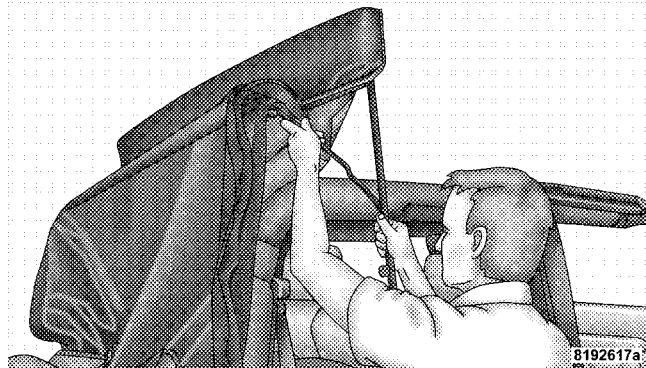

5. Before attaching the header latches, be sure that the top retainers above the door are not trapped between the top and the door frame.

6. Make sure the Sunrider bracket on the side bows latches to the door rails (Sunrider Models Only).

7. Open the header latches and engage the hook on each side onto the windshield loops (do not close the latches).

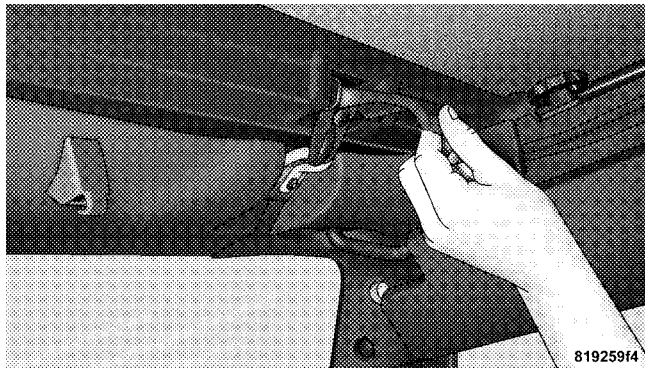

8. If the swing gate brackets were removed, install them by hooking the rear edge of the bracket on the interior side of the body channel. Then, rotate it rearward and over the channel until it snaps onto the exterior part of the rail. To be properly located, the bracket must only be clipped to the shortened rail edge.

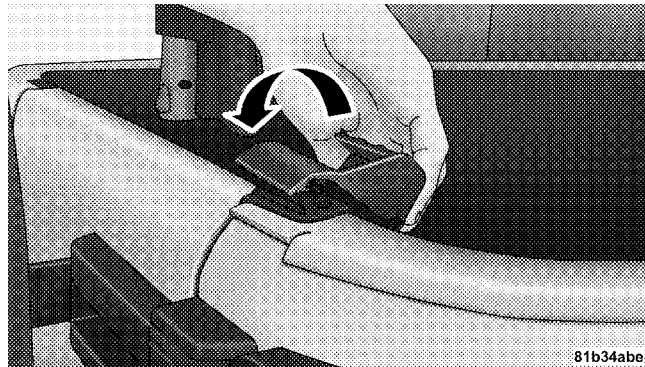

9. Move to the rear of the vehicle and gently pull the sail panels over the rear roof bow.

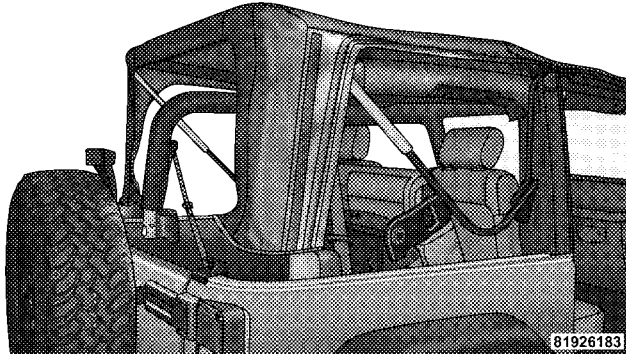

10. Partially install the sail panel retainers into the body side channel, leaving the last 3 in (7.6 cm) towards the rear window loose (on both sides). Pulling down on the rear roof bow (3-bow) will aid to reach the channel with the retainers.

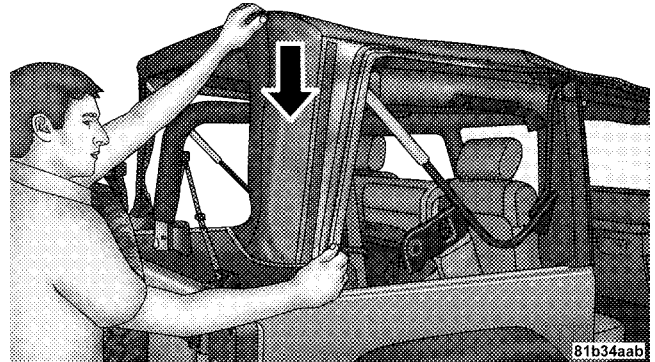

11. To install the side windows, affix the window temporarily by attaching to the Velcro® in the rear corner. Start the zipper but close only about 1 in (2.5 cm).

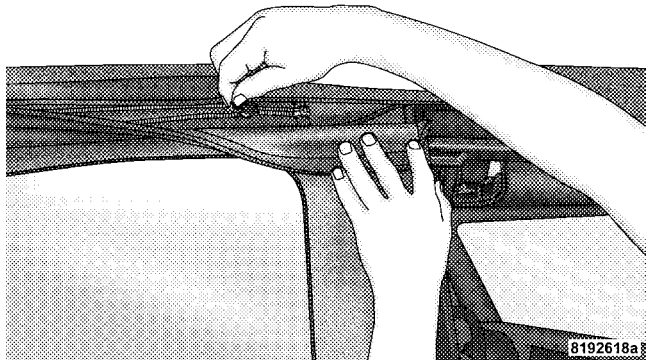

12. Insert the front retainer of the window into the door channel, making sure the retainer is fully seated and properly positioned on the door frame. Failure to do so can result in wind and water leaks or damage to the window.

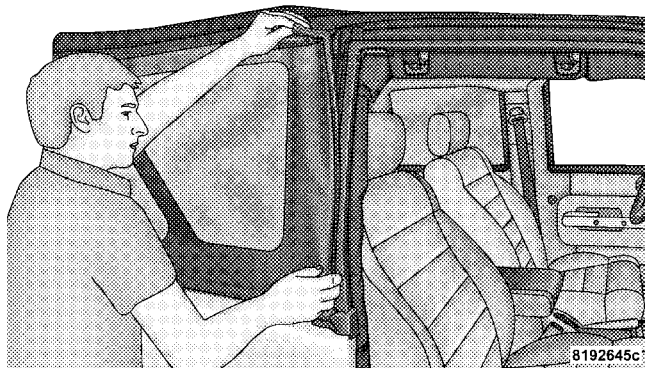

3

13. Continue closing the zipper only along the top edge of the window.

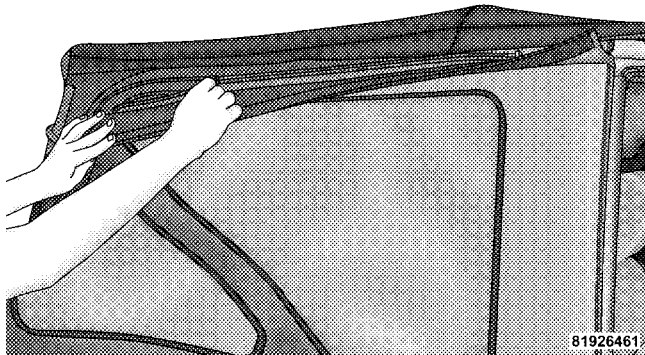

14. Insert the retainer along the bottom edge of the window into the bottom side channel, beginning at the front and working to the rear of the vehicle. Finish by closing the zipper completely and attaching the Velcro® along the top and rear of the window. Repeat this step for the opposite side.

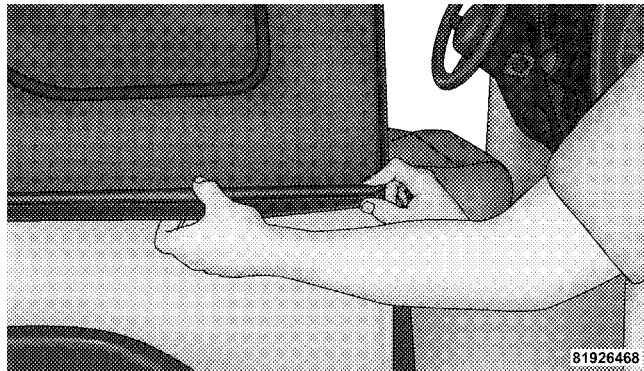

15. Locate the black swing gate bar. Slide the swing gate bar over the receiver at the bottom inside of the rear window. The spongy part of the seal should be down and pointed outward to seal with the swing gate when closed.

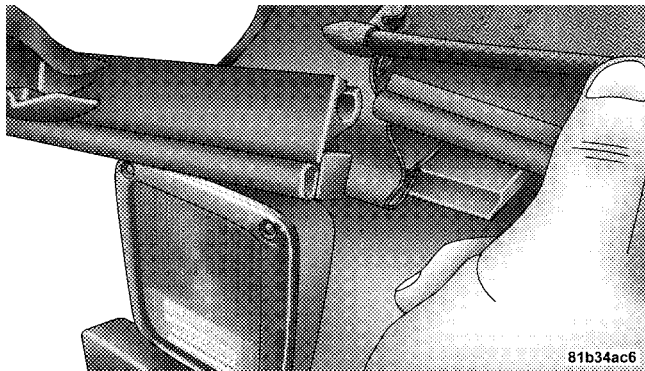

16. Install the rear window by starting both zipper ends at the lower left corner of the rear window opening. Ensure that the zippers are properly started and aligned before zipping to prevent damage.

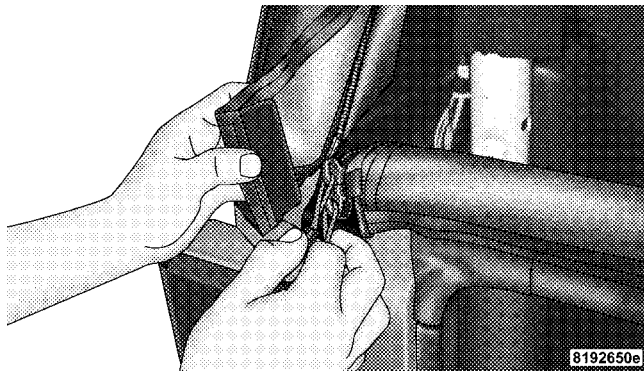

3

17. Run the zipper fully around to the right side of the window.



18. Grasp the swing gate bar and position it into the swing gate brackets.

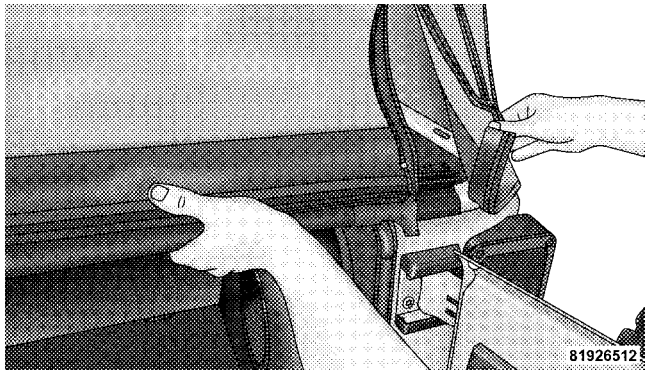

19. Apply downward pressure on the top corner of the rear soft top bow (3-bow), then complete attaching the sail panel retainers into the body side channel.

20. Open the doors and insert the roof retainers into the channels above the door, starting at the front and working rearward.

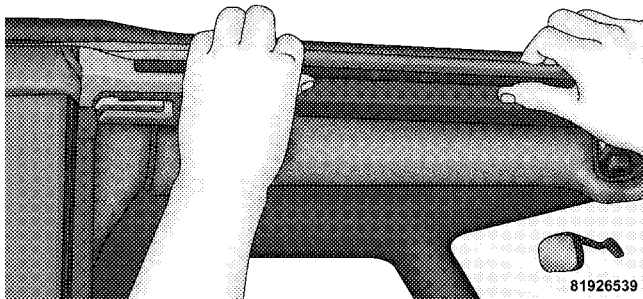

21. Close the header latches and return the sun visors to their secured position.

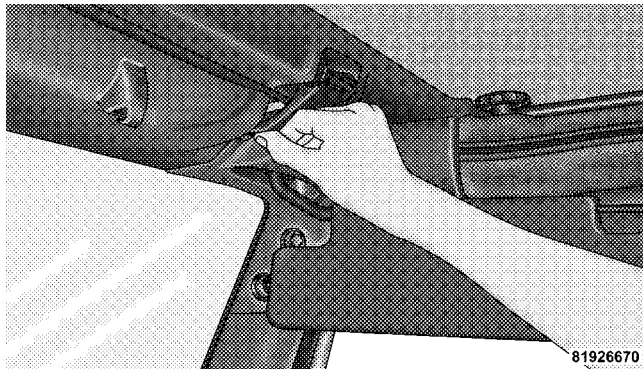

### SUNRIDER (TWO-DOOR MODELS) — IF EQUIPPED

**NOTE:** If you are going to be driving faster than 40 mph (64 km/h) with the Sunrider feature open, it is recommended that you remove the rear window of the vehicle.

### *To Open*

1. Insert finger behind the plastic retainer. Pull down and roll the retainer out of the channel. Repeat this on the other side.

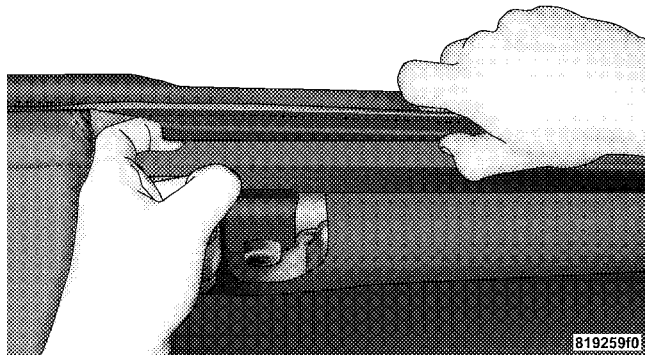

3

2. Unclip and move the sun visors to the side.
3. Release the header latches from the loops on the windshield frame.

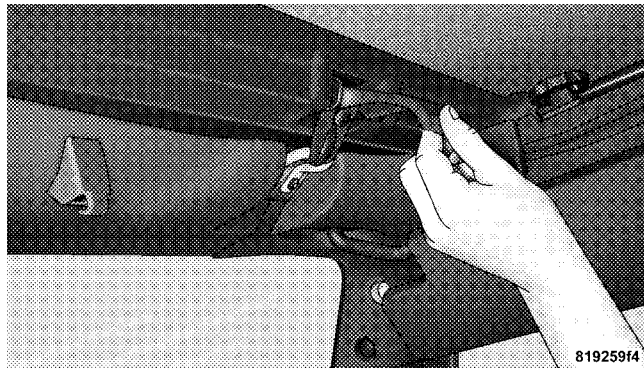

4. Slide the plastic sleeve forward.

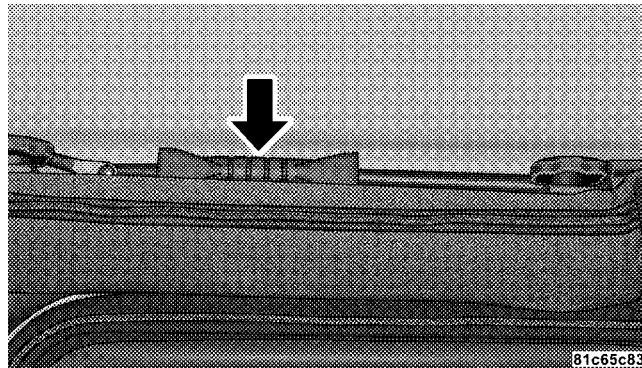

5. Grasp the header and lift the top back. Make sure the material is folded back as shown.

**NOTE:** The Sunrider latch on the door rail should not be activated for Sunrider use. If activated, the soft top must be be reinstalled starting from the sail panels.

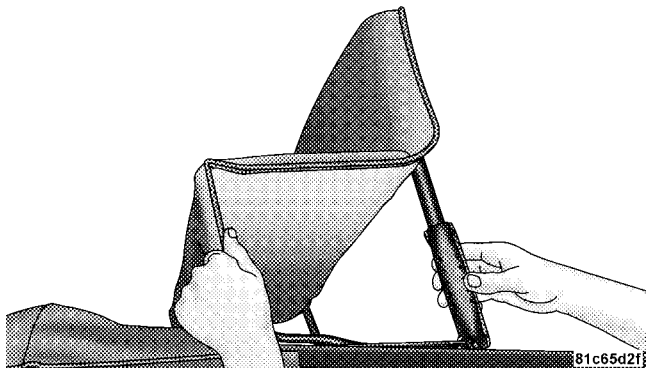

6. Locate straps to secure side bows. Wrap straps around bows as shown. Repeat on the other side.

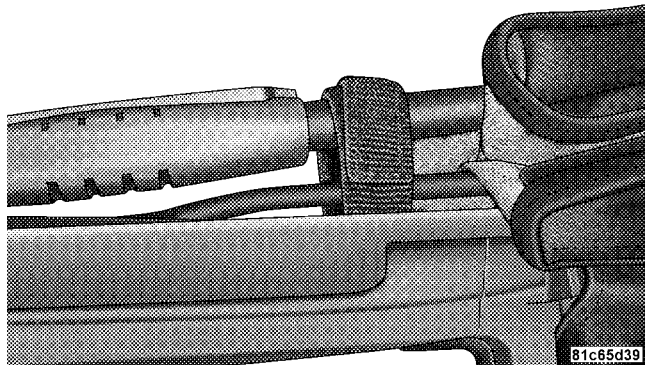

3

7. Reposition sun visors.

*To Close*

1. Remove straps from side bows.
2. Unclip and move sun visors to the side.
3. Grasp the front header and pull to the front of the vehicle.
4. Hook header latches to the loops on the windshield frame, close latches, and return sun visor's to their original position.
5. Slide plastic sleeve rearward over Sunrider link.
6. Tuck drip rail retainers into door frame slots.

**SUNRIDER (FOUR-DOOR MODELS) — IF EQUIPPED**

**NOTE:** If you are going to be driving faster than 40 mph (64 km/h) with the Sunrider feature open, it is recommended that you remove the rear window of the vehicle.

*To Open*

1. Above the front of the rear door, place finger up into the cutout in the plastic retainer and pull down, rolling both the front and rear retainers out of the door frame. Repeat this on the other side.

**NOTE:** All plastic retainers must be removed from the door rail prior to the operation of the Sunrider.

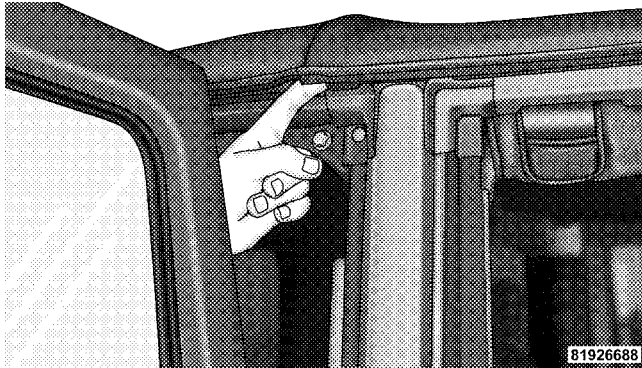

2. Unclip and move the sun visors to the side.

3. Release the header latches from the loops on the windshield frame.

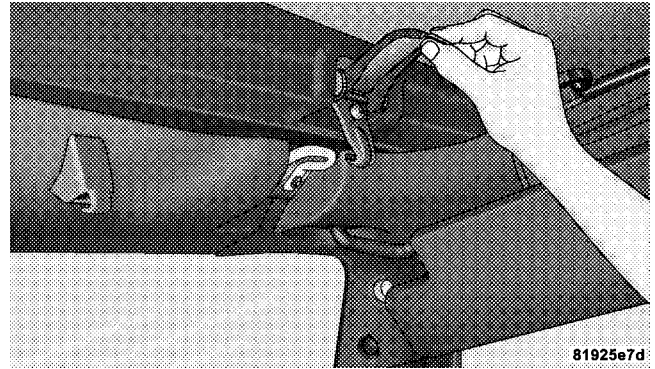

3

4. Grasp the front side bow behind the header, and lift the top.

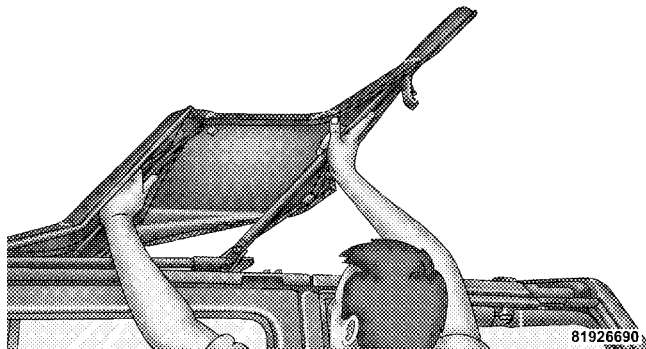

5. Fold back the front section of the top, and gently rest the header on top of the rear portion of the deck.

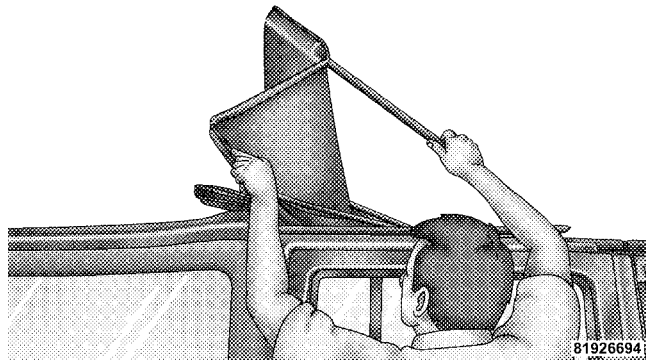

6. Fold the top material so that the plastic retainers form a “W” as shown. Enter the vehicle, and move the material into two folds. Ensure that the straps are securely stowed.

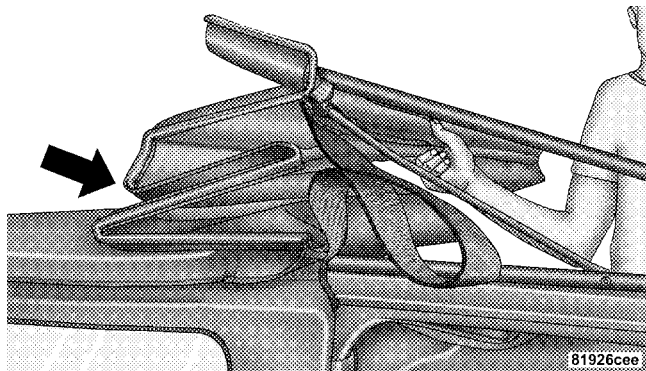

7. Close the front header latches.

8. Secure the top by using the two provided straps. Each strap will wrap around the side bow and Velcro® to itself, use one strap on each side of the vehicle.

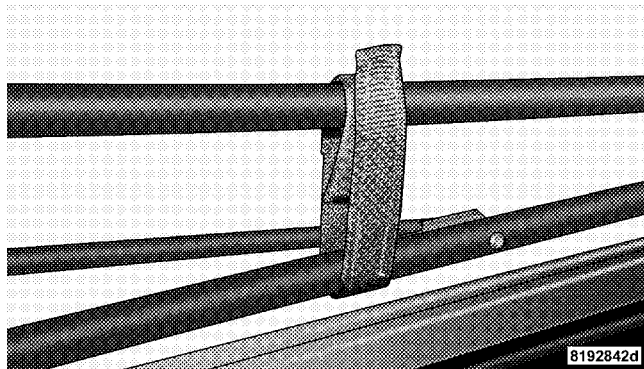

3

*To Close*

Perform the above steps in the opposite order.



**SOFT TOP (FOUR-DOOR MODELS)****CAUTION!**

- **The soft top is not designed to carry any additional loads such as roof racks, spare tires, building, hunting, or camping supplies, and/or luggage, etc. Also, it was not designed as a structural member of the vehicle, and thus cannot properly carry any additional loads other than environmental (rain, snow, etc.).**

If the temperature is below 72°F (24°C) and/or the top has been folded down for a period of time, the top will appear to have shrunk when you raise it, making it difficult to put up. This is caused by a natural contraction of the vinyl coating on the fabric top.

Place the vehicle in a warm area. Pull steadily on the top fabric. The vinyl will stretch back to its original size and the top can then be snapped into place. **If temperature is 41°F (5°C) or below, do not attempt to put the top down or roll the rear or side curtains.**

**CAUTION!**

- Do not run a fabric top through an automatic car wash. Window scratches and wax build-up may result.
- Do not lower the top when the temperature is below 41°F (5°C). Damage to the top may result.
- Do not lower the top when the windows are dirty. Grit may scratch the window.
- Do not move your vehicle until the top has been either fully attached to the windshield frame, or fully lowered.
- Do not lower the top with the windows installed. Window and top damage may occur.
- Refer to “Appearance Care for Fabric Top Models” in Section 7 of this manual. It contains important information on cleaning and caring for your vehicle’s fabric top.
- Do not use any tools (screwdrivers, etc.) to pry or force any of the clamps, clips, or retainers securing the soft top. Do not force or pry the soft top framework when opening or closing. Damage to the top may result.

**WARNING!**

- Do not drive vehicle with rear window curtain up unless side curtains are also open. Dangerous exhaust gases which can kill could enter the vehicle.
- The fabric upper doors and fabric top are designed only for protection against the elements. Do not rely on them to contain occupants within the vehicle or to protect against injury during an accident. Remember, always wear seat belts.

## Folding Down The Soft Top

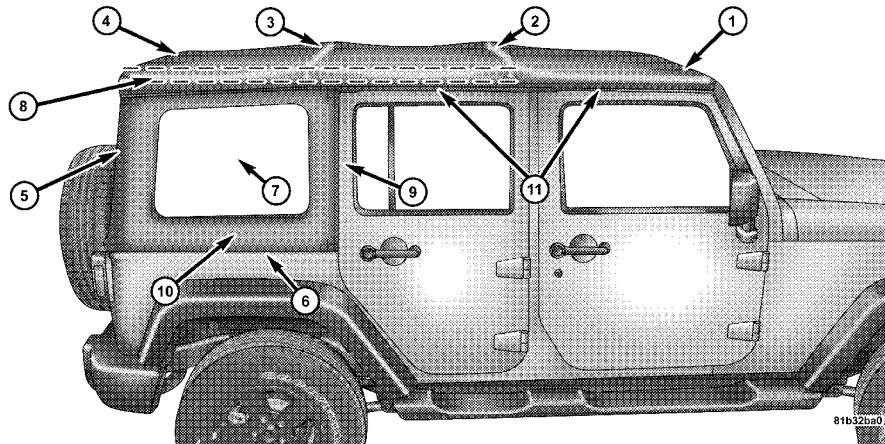

- 1 — Header Bow
- 2 — 2-Bow
- 3 — 3-Bow
- 4 — 4-Bow
- 5 — Sail Panel

- 6 — Body Side Retainer
- 7 — Quarter Window
- 8 — Check Strap
- 9 — Front Retainer — Quarter Window
- 10 — Bottom Retainer — Quarter Window

- 11 — Plastic Retainer

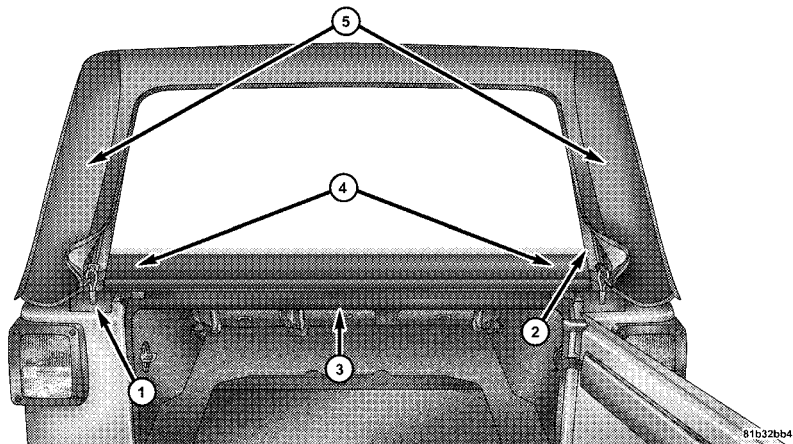

- 1 — Zipper Start
- 2 — Zipper Finish
- 3 — Swing Gate Bar
- 4 — Swing Gate Brackets
- 5 — Sail Panels

**NOTE:** Clean side and rear windows before removal to assist in preventing scratching during removal of the soft top. If zippers are difficult to operate due to road dust, etc., clean them with a mild soap solution and a small brush. Cleaning products are available through your authorized dealer.

1. If your vehicle has half-doors, remove each half-door window by opening the door and lifting the half-door window out.

**NOTE:** Stow half-door windows carefully outside of the vehicle, never inside to avoid scratches.

2. Above the front of the rear door, place finger up into the cutout in the plastic retainer and pull down, rolling both the front and rear retainers out of the door frame. Repeat this on the other side.

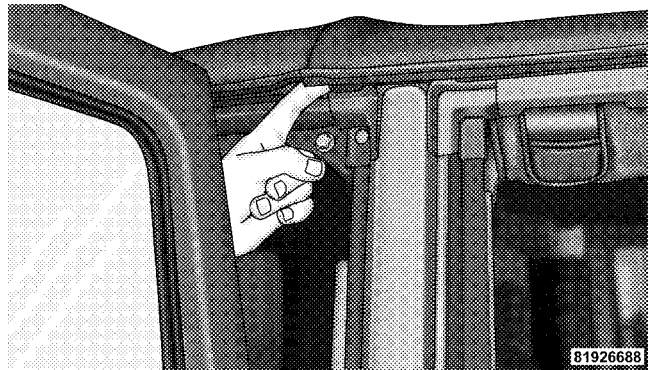

3. Unclip and move the sun visors to the side.

4. Release the header latches and hooks from the loops on the windshield frame.

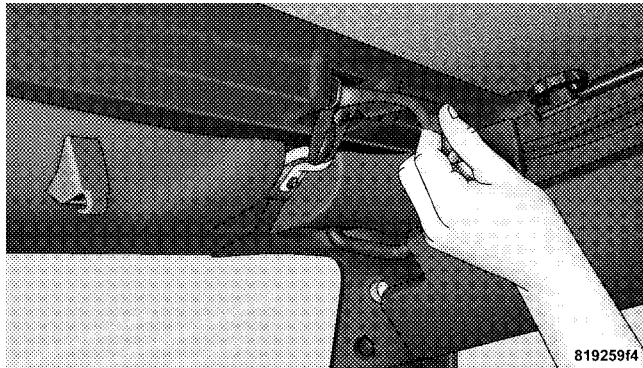

5. Open the swing gate.

6. Before unzipping the rear window, release the first 3 in (7.6 cm) of both sail panels from the channel. Remove the swing gate bar by pulling it straight rearward out of the swing gate brackets.

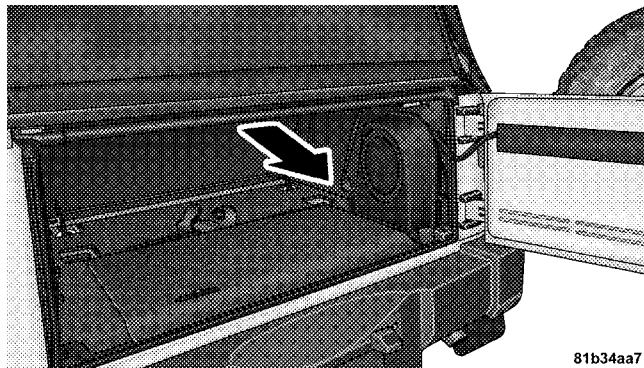

3

- Unzip the rear window starting at the right lower corner of the window. Pull the zipper up, across the top and down to the left lower corner. **Zipper pulls will stay on the rear window.** Pull down on the rear window to disengage from the zipper on the top cover. Stow the windows carefully to avoid scratching.

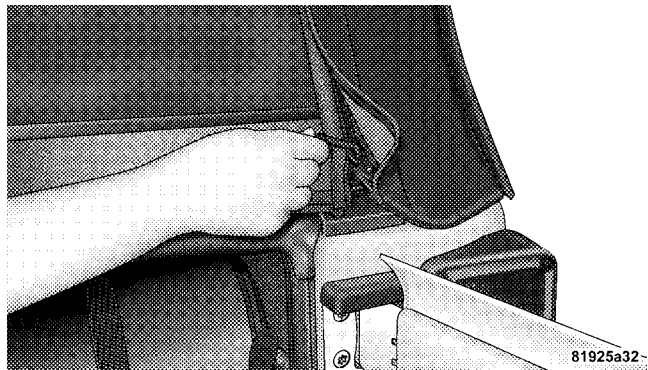

7. Undo the Velcro® that runs along the top and rear edge of the side window.
8. Beginning from the rear lower corner, completely unzip the window.

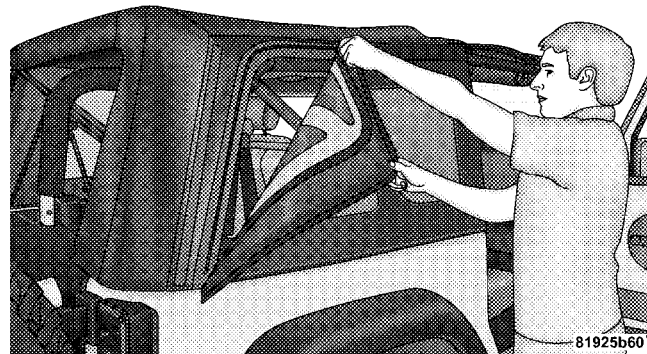

9. Once unzipped, remove side window retainers from the door channel and body side channel. Repeat this step on the opposite side.

10. Finish releasing the sail panel retainers from the body side channel at the rear corners of the vehicle.

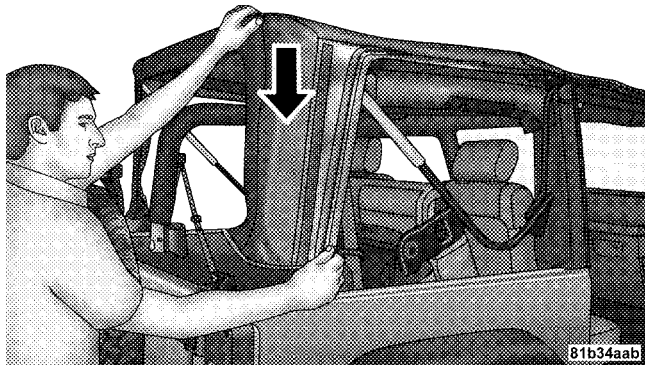

11. Fold the sail panels so that they rest on top of the soft top.

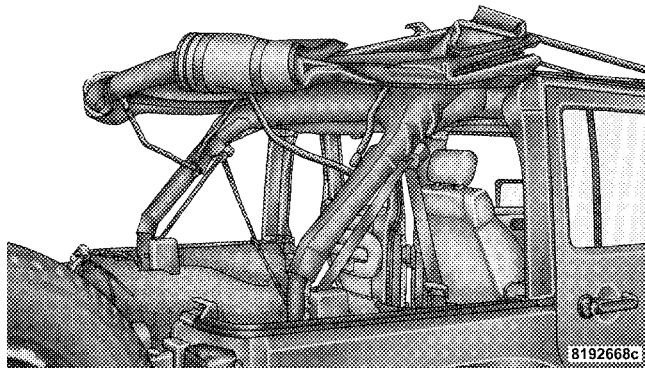

3

**NOTE:** When releasing the sail panel retainers, it is helpful to pull down on the rear roof bow.



12. The swing gate brackets do not need to be removed unless the hard top is being installed. To remove the swing gate brackets, pull the front of the bracket forward while rolling the entire bracket back in towards the vehicle to disengage.

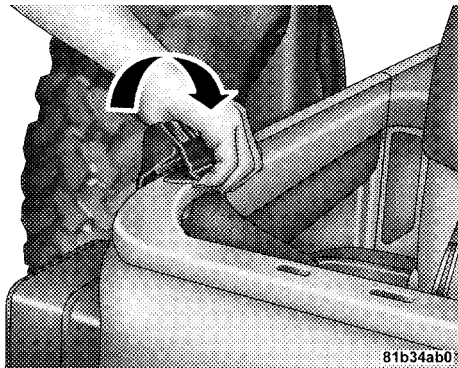

13. Grasp the front side bow behind the header, and lift the top.

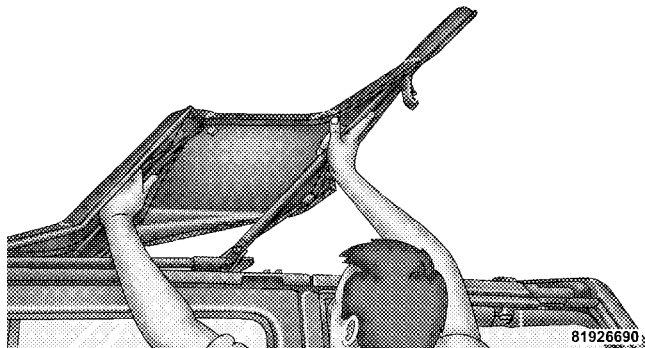

14. Fold back the front section of the top, and gently rest the header on top of the rear portion of the deck.

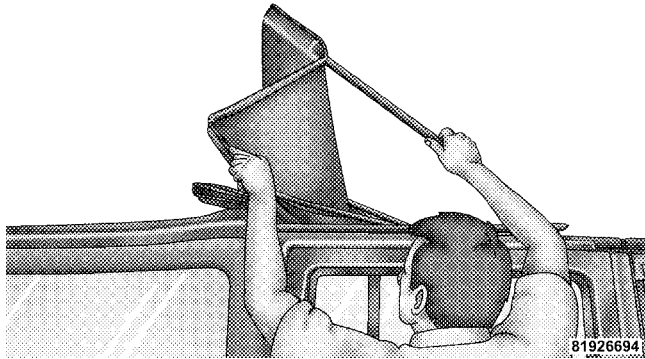

15. Fold the top material so that the plastic retainers form a "W" as shown. Enter the vehicle, and move the material into two folds.

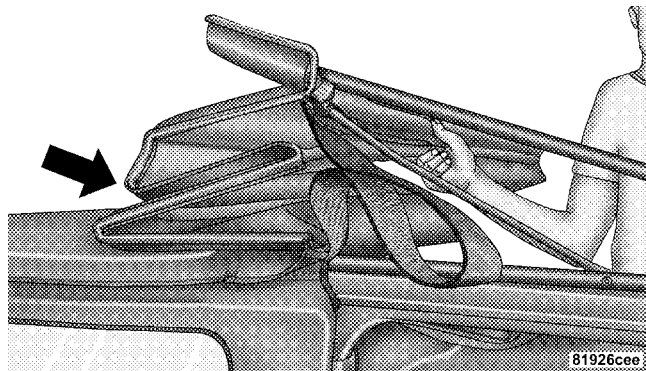

3

16. Release the side bows by pressing down on the latch above the front of the rear door. Push the top rearward to disengage. Repeat this step on the other side.

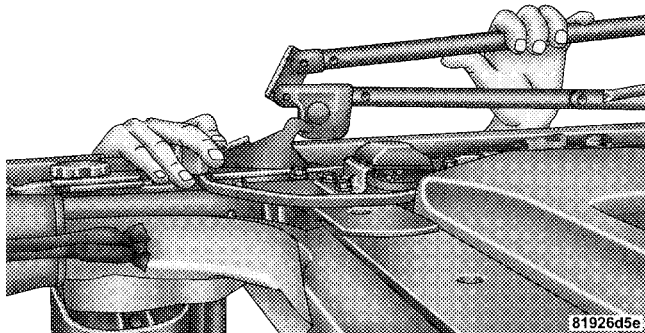

17. Grasp the folded side bows and slide the top along the door frame track to the rear door frame.

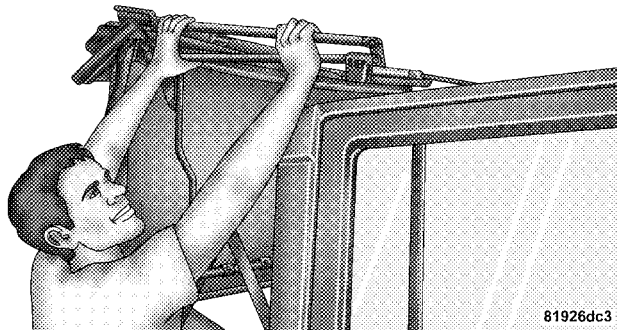

18. Before lowering the top, open the swing gate to prevent possible damage to the rear center high-mounted brake lamp. Gently slide the side bows off the door frame track and lower the top down into the vehicle.

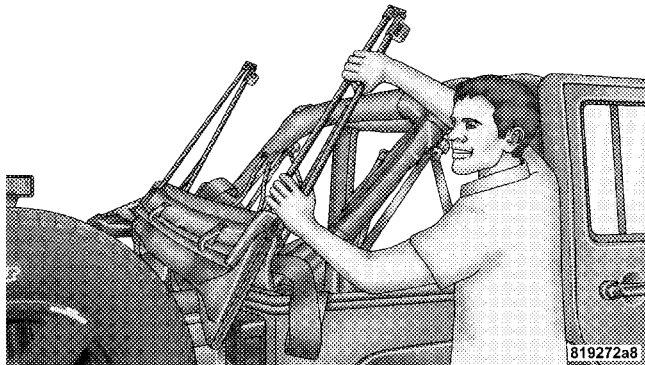

19. Tuck the fabric and the check straps between the bows as far inside as possible. This will keep any portion of the top from flapping outside of the vehicle.

20. Once the top is fully down, use the Velcro straps provided to secure the top to the vehicle by wrapping the strap around the side bows and through the slot on the body.

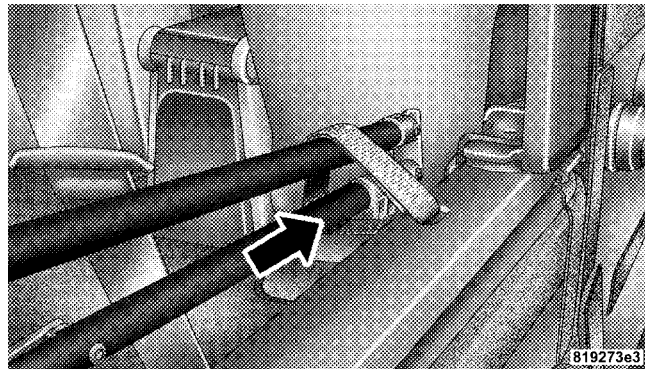

3

21. Close the front header latches.

22. Remove door frames, if desired. Refer to “Door Frame” in this section.

## Putting Up The Soft Top

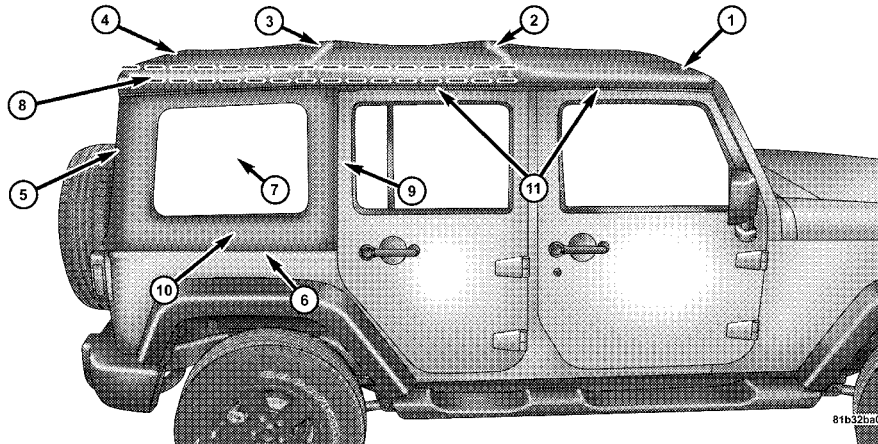

- 1 — Header Bow
- 2 — 2-Bow
- 3 — 3-Bow
- 4 — 4-Bow
- 5 — Sail Panel

- 6 — Body Side Retainer
- 7 — Quarter Window
- 8 — Check Strap
- 9 — Front Retainer — Quarter Window
- 10 — Bottom Retainer — Quarter Window

- 11 — Plastic Retainer

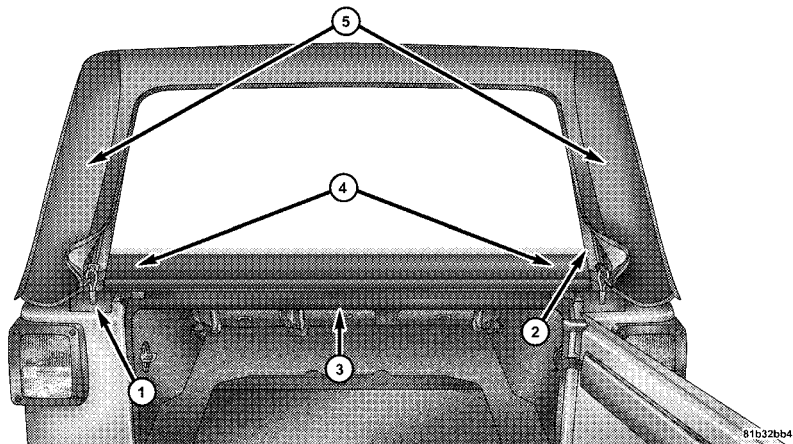

- 1 — Zipper Start
- 2 — Zipper Finish
- 3 — Swing Gate Bar
- 4 — Swing Gate Brackets
- 5 — Sail Panels

**NOTE:** Be extremely careful when putting up the soft top to prevent the doors from getting scratched. It may be helpful to open the rear doors.

1. Install the door frames, if removed. Refer to “Door Frame” in this section.
2. Undo the straps used to secure the top in the down position and store in secure location.
3. Open the swing gate.
4. Grasp the folded side bows and lift to the top of the rear door frames.

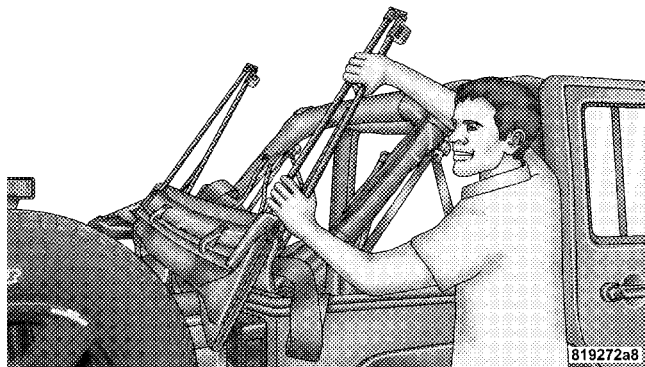

5. Insert the slider feature of the knuckles into the door frame tracks and slide the top forward.

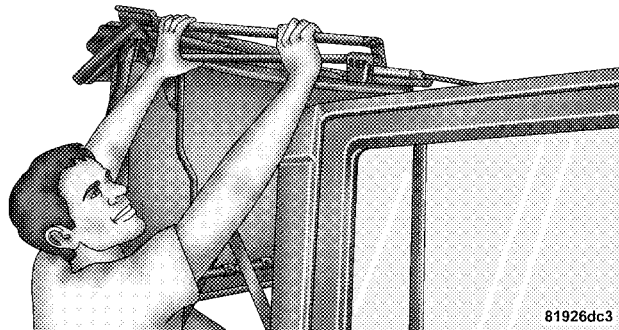

6. Ensure that the top locks into Sunrider locking mechanisms that are located above the front of the rear doors.

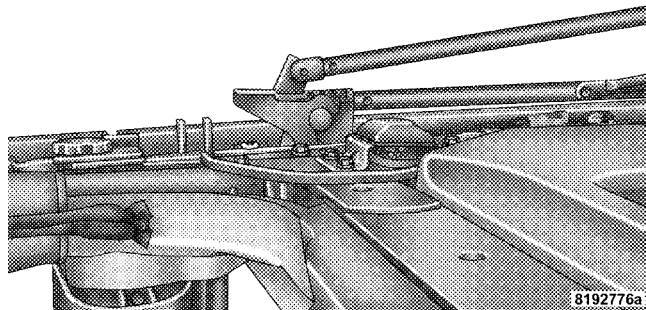

3



- Unclip and move the sun visors to the side.
- Standing on the side of the vehicle, lift the top by the side bow until it rests on the windshield frame.

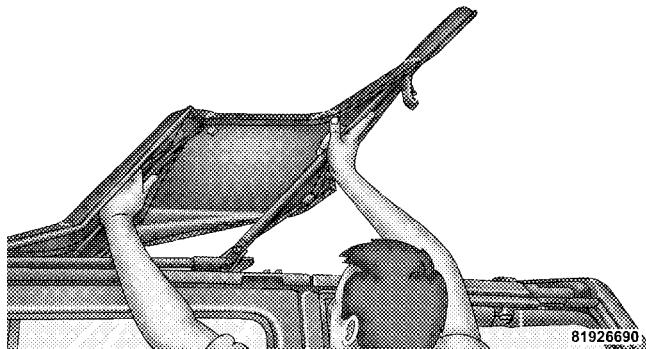

- Before attaching the header latches, be sure the top retainers above the doors do not get trapped between the top and the door frame. Also, make certain the feet at both ends of the 2-bow (forward most bow) seat properly

on the side bows above the front doors. They should cradle the tubing. Finally, make sure that the check strap (the long, woven strap reaching from the rear bow to the 2-bow) does not get entangled in any of the framework when unfolding the top.

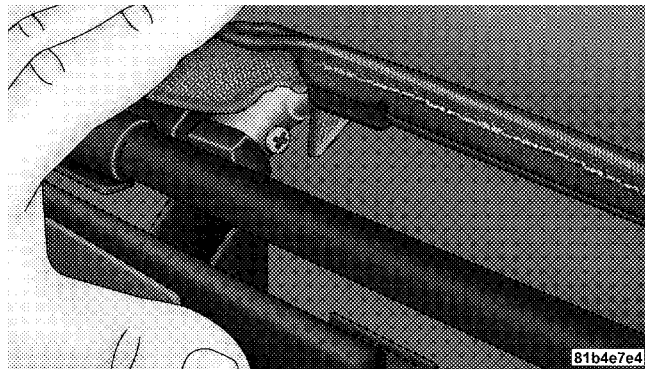

10. Open the header latches and engage the hook on each side onto the windshield loops (do not close the latches).

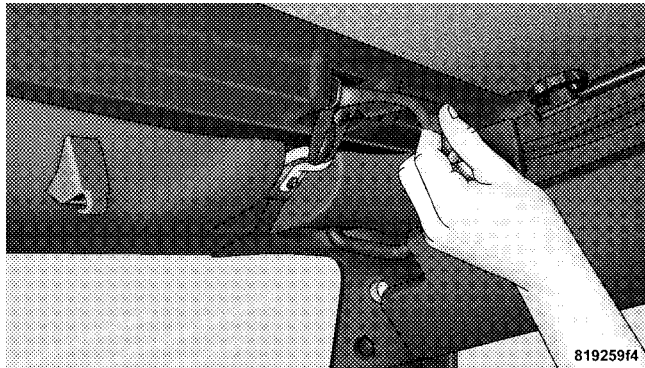

11. If the swing gate brackets were removed, install them by hooking the rear edge of the bracket on the interior side of the body channel. Then, rotate it rearward and

over the channel until it snaps onto the exterior part of the rail. To be properly located, the bracket must only be clipped to the shortened rail edge.

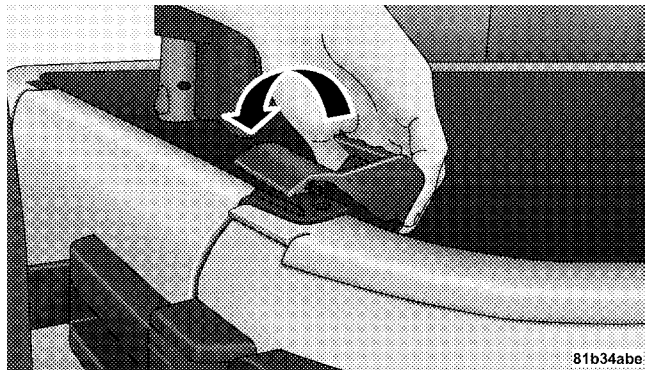

12. Move to the rear of the vehicle and gently pull the sail panels over the rear roof bow (4-bow).

13. Partially install the sail panel retainers into the body side channel, leaving the last 3 in (7.6 cm) towards the rear window loose (on both sides). Pulling down on the rear roof bow (4-bow) will aid to reach the channel with the retainers.

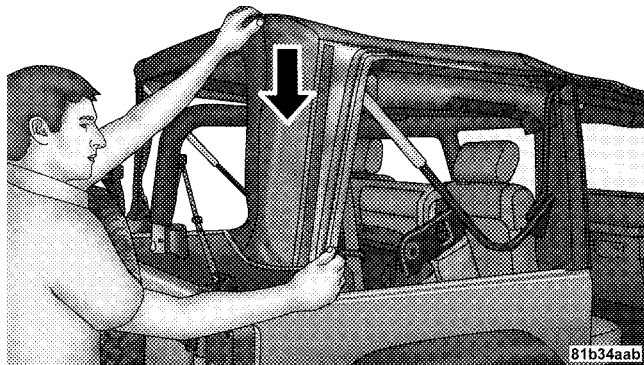

14. To install the side windows, affix the window temporarily by attaching to the Velcro® in the upper rear corner. Start the zipper but close only about 1 in (2.5 cm).

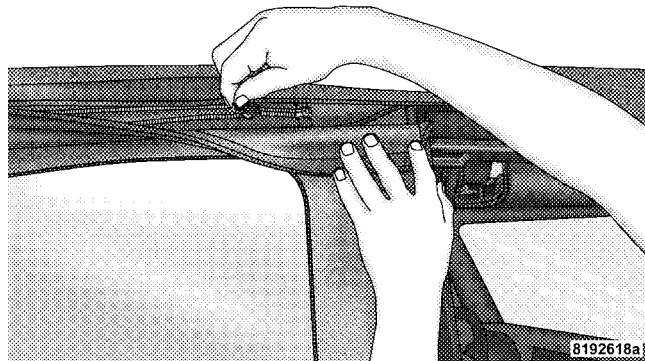

15. Insert the front retainer of the window into the door channel, making sure the retainer is fully seated and properly positioned on the door frame. Failure to do so can result in wind and water leaks or damage to the window.

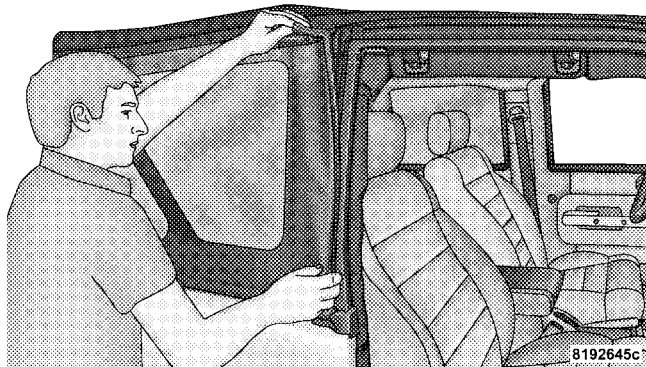

16. Continue closing the zipper only along the top edge of the window.

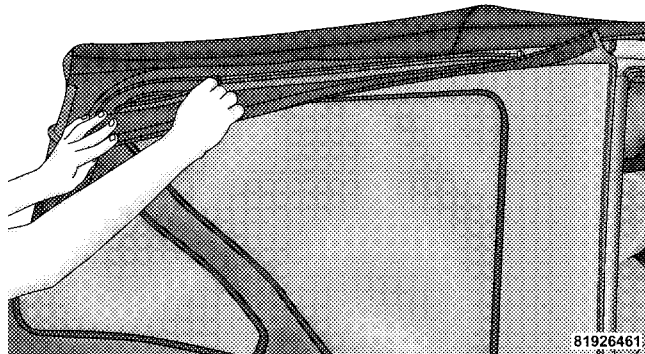

3

17. Insert the retainer along the bottom edge of the window into the bottom side channel, beginning at the front and working to the rear of the vehicle. Finish by closing the zipper completely and attaching the Velcro® along the top and rear of the window. Repeat this step for the opposite side.

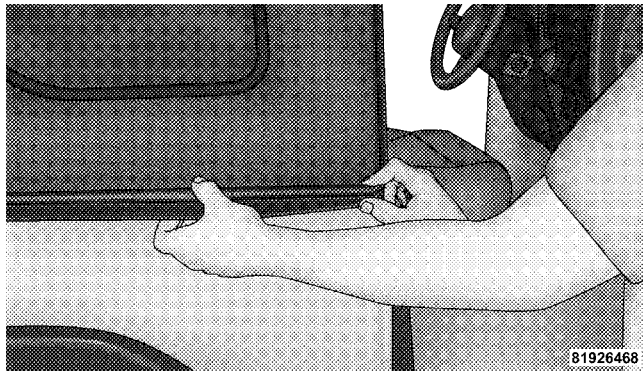

18. Locate the black swing gate bar. Slide the swing gate bar over the receiver at the bottom inside of the rear window. The spongy part of the seal should be down and pointed outward to seal with the swing gate when closed.

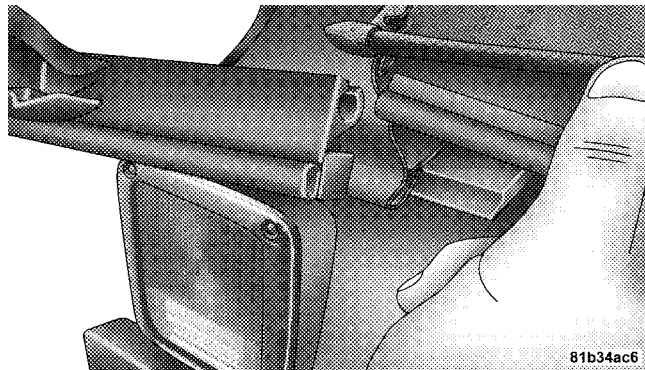

19. Install the rear window by starting both zipper ends at the lower left corner of the rear window opening. Ensure that the zippers are properly started and aligned before zipping to prevent damage.

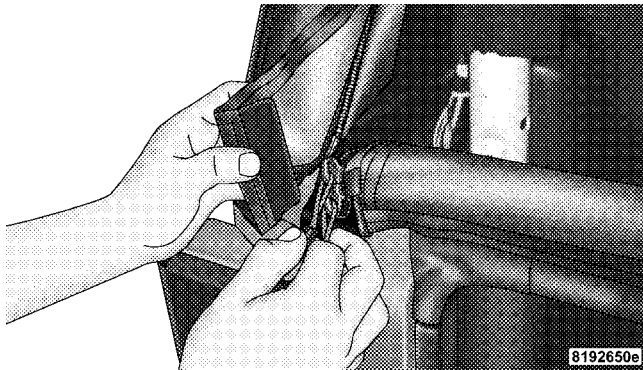

20. Run the first zipper fully around to the right side of the window.

21. Grasp the swing gate bar and position it into the swing gate brackets.

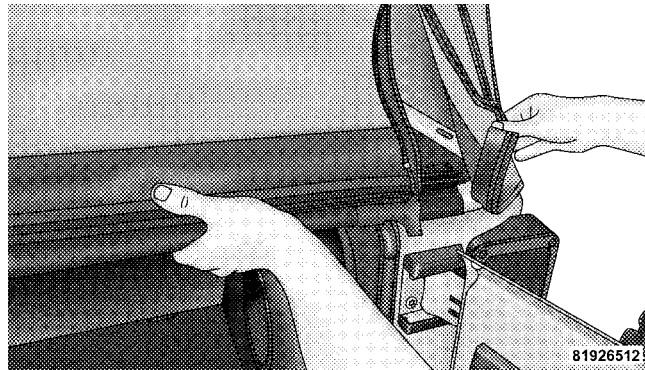

22. Complete the installation of the sail panel by inserting the rest of the retainer into the body channel.

23. Open the doors and insert the top retainers into the channels in the door frame above the doors, starting at the front and working toward the rear of the vehicle.

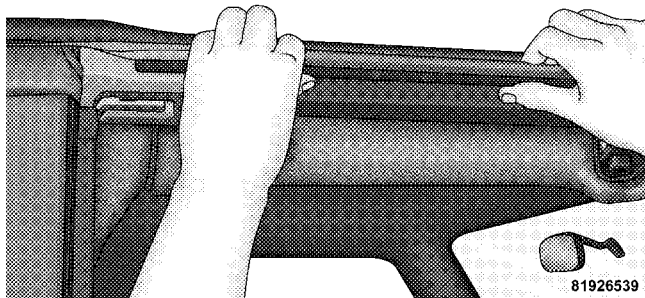

24. Ensure plastic retainer is tucked in properly at B-pillar, not pinching the seal.

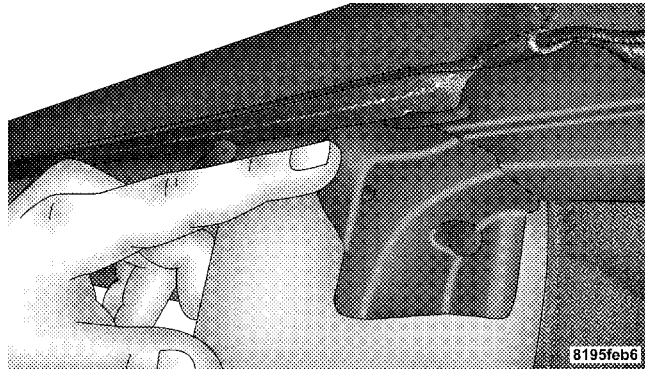

25. Close the header latches and return the sun visors to their secured position.

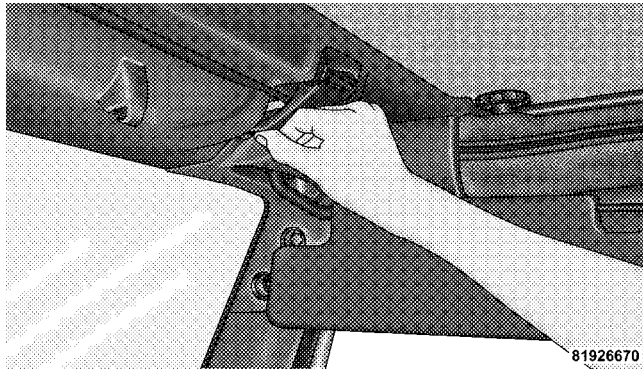

## FOLDING WINDSHIELD

The fold-down windshield and removable side bars on your vehicle are structural elements that can provide some protection in some accidents. The windshield also provides some protection against weather, road debris and intrusion of small branches and other objects.

Do not drive your vehicle on-road with the windshield down and the side bars removed as you lose the protection these structural elements can provide.

If required for certain off-road uses, the side bars can be removed and the windshield folded down. However, the protection afforded by these features is then lost. If you remove the side bars and fold down the windshield, drive slowly and cautiously. It is recommended that the speed of the vehicle be limited to 10 mph (16 km/h), with low range operation preferred, if you are driving off-road with the windshield folded down.



Raise the windshield and reinstall the side bars as soon as the task that required their removal is completed and before you return to on-road driving. Both you and your passenger should wear seat belts at all times, on-road and off-road, regardless of whether the windshield is raised or folded down.

Outside rearview mirrors are mounted on the doors. If you choose to remove the doors, see your authorized dealer for a replacement cowl-mounted outside mirror. Federal law requires outside mirrors on vehicles for on-road use.

## WARNING!

Carefully follow these warnings to help protect against personal injury:

- Do not drive your vehicle on-road with the windshield down.
- Do not drive your vehicle unless the windshield is securely fastened, either up or down.
- Eye protection, such as goggles, should be worn at all times when the windshield is down.
- Be sure that you carefully follow the instructions for raising the windshield. Make sure that the folding windshield, windshield wipers, side bars, and all associated hardware and fasteners are correctly and tightly assembled before driving your vehicle. Failure to follow these instructions may prevent your vehicle from providing you and your passengers protection in some accidents.
- If you remove the doors, store them outside the vehicle. In the event of an accident, a loose door may cause personal injury.



## Lowering The Windshield And Removing Side Bars

1. Lower the fabric top or remove the hard top following the instructions in this manual.

**NOTE:** To assist in properly reinstalling side bars, mark the original locations prior to removing.

2. Remove the two top hex bolts (13 mm), and the one side hex bolt (13 mm) visible through the trim (Do not remove plastic corner trim, sun visor bolts, or sport bar covering).

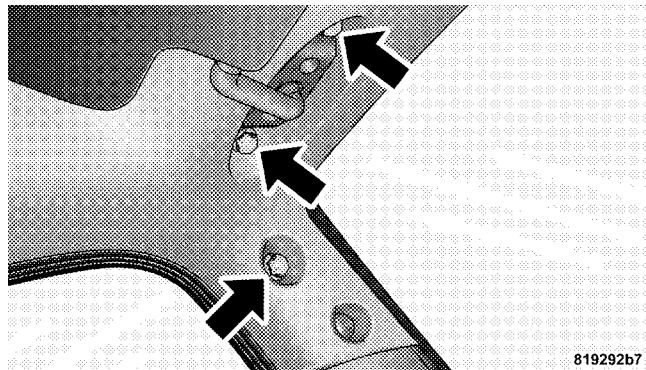

819292b7

3. Open sport bar Velcro covering.

4. Remove the one hex bolt (13 mm) visible through the plastic trim on bottom side of side bar, one hex bolt (13 mm) on the side of the side bar, and one hex bolt (13 mm) on top of the side bar.

**NOTE:** Pull side bar out horizontally when removing.

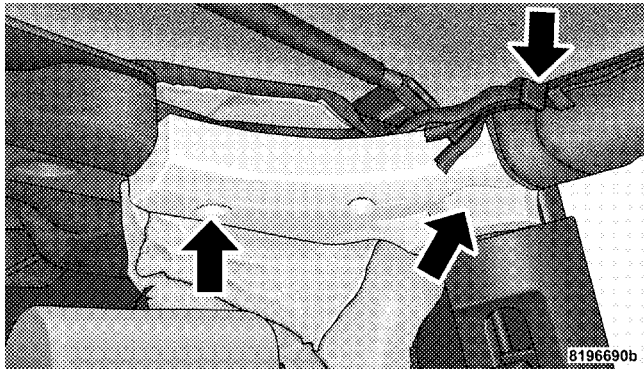

### CAUTION!

Do not remove the head impact foam from the side bars, as damage to the foam may result.

**NOTE:** Store all of the mounting bolts in their original threaded holes and tighten for safekeeping.

- Remove side bar assembly, and reattach sport bar Velcro® covering.
- To safely store the side bars in your vehicle, use four cinch straps (available from your authorized dealer). Attach the straps through the slots located on the floor behind the folded rear seat at the front of the storage bin cover.

### WARNING!

You or others could be injured if you carry the side bars loose in your vehicle. Remove the side bars from the vehicle or securely store them as described or they may cause personal injury if an accident occurs. See your authorized dealer for the cinch straps.

7. Remove the windshield wiper arms by first pulling the wiper away from the windshield and out to the “lock” position. Unsnap the wiper arm nut caps, and remove retaining nuts. Lift the wiper arms off and store in center console or securely behind the rear seat.

8. Remove the lower windshield plates by removing the six black round-headed Torx® head screws (using a #40 Torx® head driver) on each side of the base of the windshield.

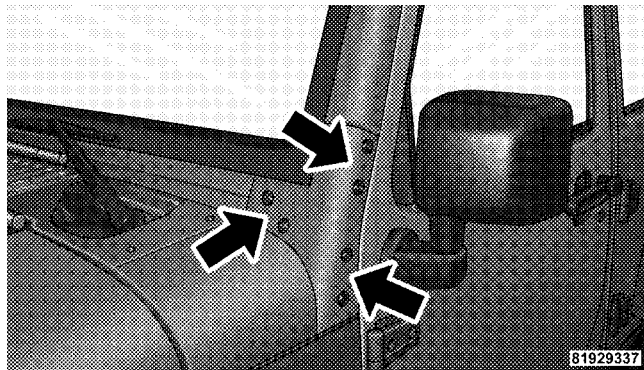

3

9. Lower the windshield gently until it contacts the rubber hood bumpers.

10. Secure the windshield by passing a cinch strap through the footman hoop on the center of the hood and on the center of the windshield frame. Tighten the strap to secure the windshield in place.

## Raising The Windshield And Replacing Side Bars

1. Raise the windshield.
2. Loosely attach rear of side bar to sport bar. Refer to Step 4 of "Lowering Windshield And Removing Side Bars" earlier in this section.

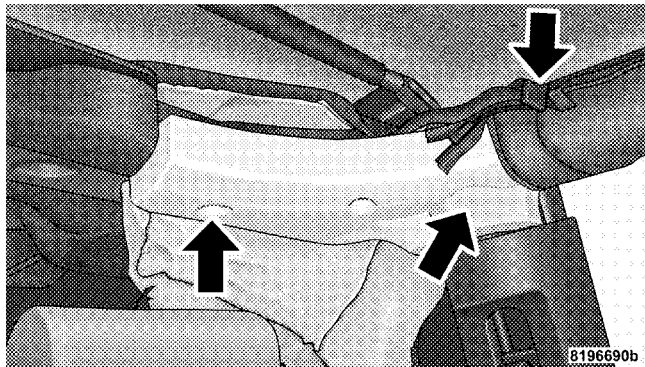

8196690b

- Reattach sport bar Velcro® covering.

3. Attach front of side bar to windshield frame.

- Install top two hex bolts (13 mm) first, then lower side hex bolt (13 mm). Lower side bolt will not align until top two bolts are installed.

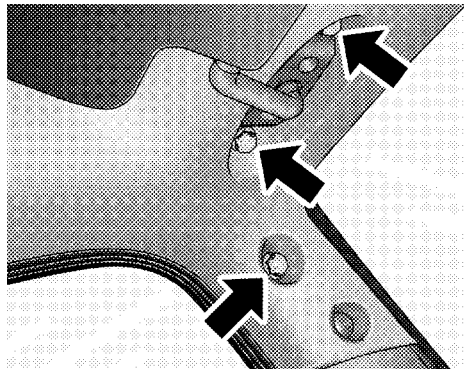

819292b7

4. Tighten all side bar attachment bolts.

5. Install the lower windshield plates with the six black round-headed Torx® head screws (using a #40 Torx® head driver) on each side of the base of the windshield.

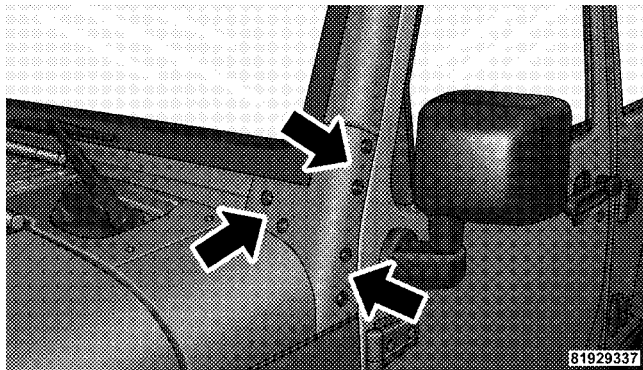

6. Reinstall wiper arms.

## REAR WINDOW FEATURES — HARD TOP ONLY

### Rear Window Wiper/Washer — If Equipped

A rotary ring switch on the control lever (located on the right side of the steering column), controls operation of the rear wiper/washer function. Rotating the center of the switch up to the “On” position will activate the wiper. Rotating the switch ring beyond the “On” or “Off” position will activate the rear washer. The wash pump will continue to operate as long as the lever or ring is engaged. Upon release, the wipers will cycle three times before returning to the set position.

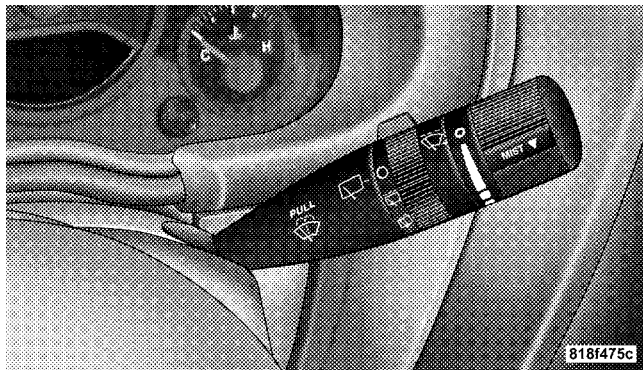

### Windshield Wiper/Washer Switch

If the rear wiper is operating when the ignition is turned OFF, the wiper will automatically return to the “Park” position. When the vehicle is restarted, the wiper will resume function at whichever position the switch is set at.

### Adding Washer Fluid

The fluid reservoir for the windshield washers and the rear window washer is shared. It is located in the front of the engine compartment, and should be checked for fluid level at regular intervals. Fill the reservoir with windshield washer solvent (not radiator antifreeze) and operate the system for a few seconds to flush out the residual water.

### Rear Window Defroster — If Equipped

The pushbutton is located on the bottom right side of the blower control knob. Press this button to turn on the rear window defroster. An amber light shows that the defroster is on.

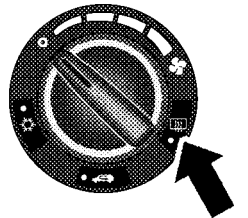

819179d2

The defroster will automatically turn off after about ten minutes. For five more minutes of operation, press the switch again. To prevent excessive battery drain, use the defroster only when the engine is operating.

### CAUTION!

**Use care when washing the inside of the rear window to prevent damage to heating elements. Use a soft cloth and a mild washing solution, wiping parallel to the heating elements. Also, keep all objects a safe distance from the window to prevent damaging the heating elements.**





# UNDERSTANDING YOUR INSTRUMENT PANEL

## CONTENTS

■ Instrument Panel And Controls . . . . .	204	□ Two Types Of Signals . . . . .	221
■ Instrument Cluster . . . . .	205	□ Electrical Disturbances . . . . .	221
■ Instrument Cluster Description . . . . .	206	□ AM Reception . . . . .	221
■ Compass And Trip Computer — If Equipped . . . . .	215	□ FM Reception . . . . .	221
□ Control Buttons . . . . .	216	■ Sales Code RES — AM/FM Stereo Radio With CD Player (MP3 AUX Jack) . . . . .	222
□ Trip Conditions . . . . .	216	□ Operating Instructions - Radio Mode . . . . .	222
□ Compass Temperature Display . . . . .	217	□ Operation Instructions - CD Mode For CD And MP3 Audio Play . . . . .	228
■ Radio General Information . . . . .	220	□ Notes On Playing MP3 Files . . . . .	230
□ Radio Broadcast Signals . . . . .	220		

□ List Button (CD Mode For MP3 Play) . . . . .	233	□ Operating Instructions — Satellite Radio . . . . .	251
□ Info Button (CD Mode For MP3 Play) . . . . .	233	□ Operating Instructions — Hands-Free Communication (UConnect®) (If Equipped) . . .	251
■ Sales Code REQ — AM/FM Stereo Radio And 6-Disc CD/DVD Changer (MP3/WMA AUX Jack) . . . . .	234	□ Clock Setting Procedure . . . . .	251
□ Operating Instructions - Radio Mode . . . . .	235	■ Satellite Radio — If Equipped (REN/REQ/RER/RES Radios Only) . . . . .	253
□ Operation Instructions - (Disc Mode For CD And MP3/WMA Audio Play, DVD-Video) . . . .	243	□ System Activation . . . . .	254
□ Notes On Playing MP3/WMA Files . . . . .	245	□ Electronic Serial Number/Sirius Identification Number (ESN/SID) . . . . .	254
□ List Button (Disc Mode For MP3/WMA Play) . . . . .	247	□ Selecting Satellite Mode . . . . .	255
□ Info Button (Disc Mode For MP3/WMA Play) . . . . .	247	□ Satellite Antenna . . . . .	255
■ Sales Code RER — Multimedia System — If Equipped . . . . .	250	□ Reception Quality . . . . .	255
		□ Operating Instructions - Satellite Mode . . . . .	255

- Operating Instructions - Hands-Free Phone  
(If Equipped) . . . . .257
- Operating Instructions - Video Entertainment  
System (VES®) (If Equipped) . . . . .258
- CD/DVD Disc Maintenance . . . . .258
- Radio Operation And Cellular Phones . . . . .258
- Climate Controls . . . . .259

- Manual Heater Only . . . . .259
- Manual Air Conditioning And Heating System  
— If Equipped . . . . .261
- Air Conditioning . . . . .264
- Operating Tips . . . . .265

## INSTRUMENT PANEL AND CONTROLS

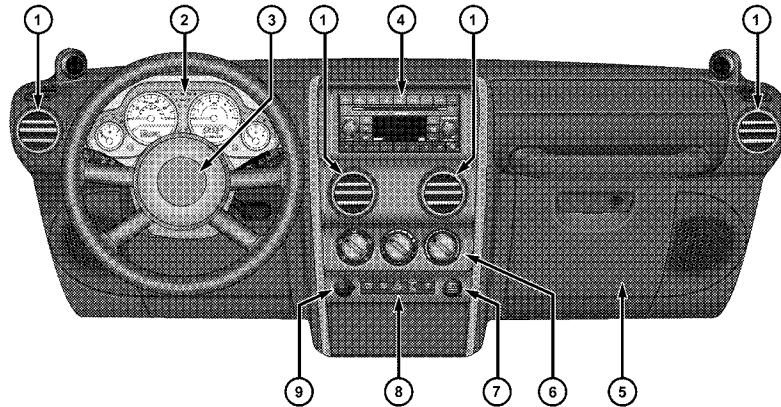

81c25955

- 1 — Air Outlet
- 2 — Instrument Cluster
- 3 — Horn
- 4 — Radio
- 5 — Glove Box

- 6 — Climate Controls
- 7 — Power Outlet
- 8 — Lower Switch Bank
- 9 — Auxiliary Power Outlet

# INSTRUMENT CLUSTER

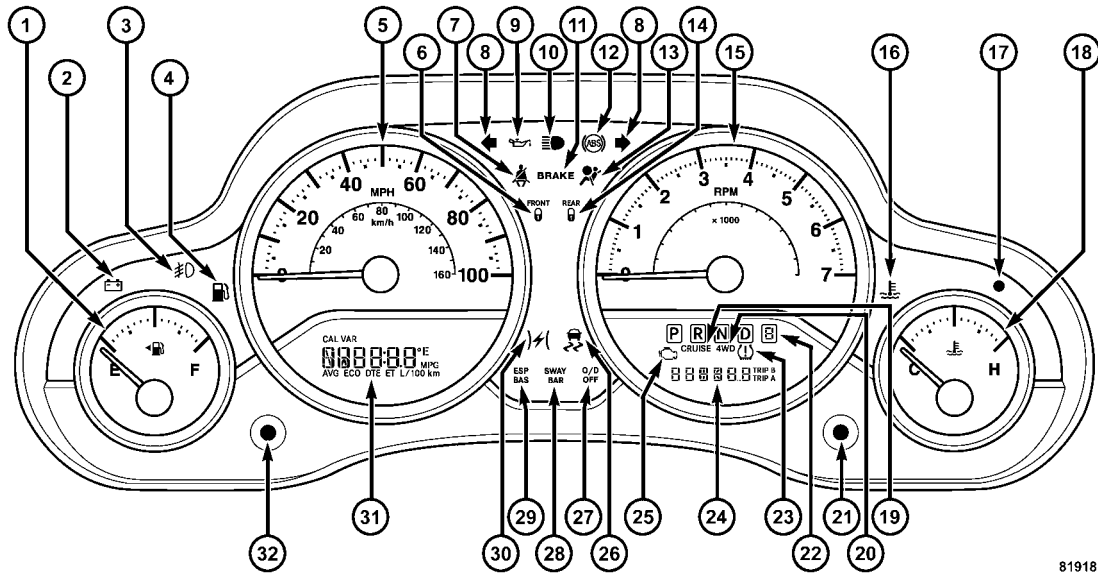

81918b50

## INSTRUMENT CLUSTER DESCRIPTION

Your vehicle is equipped with the instrument cluster described on the following pages.

### 1. Fuel Gauge

The pointer shows the level of fuel in the fuel tank.

**NOTE:** When the ignition switch is turned to OFF, the fuel gauge, voltmeter, oil pressure and temperature gauges may not show accurate readings. When the engine is not running, turn the ignition switch to ON to obtain accurate readings.

### 2. Charging System Warning Light



This light shows the status of the electrical charging system. The light should come on for three seconds when the ignition is first turned ON. If the light comes back on immediately or comes on while driving, it means that there is a problem with the charging system or the battery is low. Also, a chime will sound if the light comes back on. See your authorized dealer immediately.

### 3. Front Fog Light Indicator Light — If Equipped



This light shows when the front fog lights are on.

### 4. Low Fuel Warning Light



When the fuel level reaches approximately 2.8 gal (10.6L) this light will turn on and a single chime will sound.

### 5. Speedometer

Indicates vehicle speed.

### 6. Front Axle Lock Indicator Light — If Equipped

FRONT



Indicates when the front axle lock has been activated.

### 7. *Seat Belt Indicator Light*



A warning chime and an indicator light will alert you to buckle the seat belts. When the belt is buckled, the chime will stop, but the light will stay on until it times out (about six seconds).

### 8. *Turn Signal Indicator Lights*



The arrows will flash with the exterior turn signals when the turn signal lever is operated. A tone will chime if the turn signals are left on for more than 1 mi (2 km).

### 9. *Oil Pressure Warning Light*



Shows low engine oil pressure. The light will come on and remain on when the ignition switch is turned from the OFF to the ON position, and the light will turn off after the engine is started. If the bulb does not come on, have the system checked by your authorized dealer.

If the warning light comes on and remains on while driving, stop the vehicle and shut off the engine. **DO NOT OPERATE THE VEHICLE UNTIL THE CAUSE IS CORRECTED.** Also, a single chime will sound.

### 10. *High Beam Indicator Light*



This light shows that the headlights are on high beam. Push the multifunction control lever away from you to switch the headlights to high beam. Pull the lever towards you to switch the headlights back to low beam. If the driver's door is open, and the headlights or park lights are left on, the High Beam Indicator Light will remain illuminated and a chime will sound.

### 11. *Brake Warning Light*



After the ignition is turned on, this light illuminates to indicate function check at vehicle start-up. It also indicates if the parking brake is applied. If the light stays on when the parking brake is



off, it indicates a possible brake system fluid leak or low pressure level, **see your authorized dealer immediately.**

If the parking brake is applied and the vehicle is in motion, the Brake Warning Light will “flash” and a chime will sound.

The operation of the Brake Warning Light can be checked by turning the ignition switch from the OFF position to the ON position. The light should illuminate for approximately two seconds. The light should then turn off unless the parking brake is applied or a brake fault is detected. If the light does not illuminate, have the light inspected by an authorized dealer.

### 12. Anti-Lock (ABS) Warning Light

 After the ignition is turned on, this light illuminates to indicate function check at vehicle start-up. If the light remains on after start-up or comes on and stays on at road speeds, it may indicate that the ABS has

detected a malfunction or has become inoperative. The system reverts to standard non-anti-lock brakes.

If both the Brake Warning Light and the ABS Warning Light are on, see your authorized dealer immediately. Refer to “Anti-Lock Brake System” in Section 5 of this manual.

### 13. Airbag Warning Light



This indicator lights and remains lit for six to eight seconds when the ignition is first turned on. If the light does not come on for six to eight seconds, stays on or comes on while driving, have the airbag system checked by an authorized dealer.

### 14. Rear Axle Lock Indicator Light — If Equipped



This light indicates when the rear axle lock has been activated.

### 15. Tachometer

This light indicates the engine speed in revolutions per minute (RPM).

#### CAUTION!

Do not operate the engine with the tachometer pointer in the red area. Engine damage will occur.

### 16. Engine Coolant Temperature Warning Light



This light warns of an overheated engine condition. If the engine is critically hot, a warning chime will sound 10 times. After the chime turns off, the engine will still be critically hot until the light goes out.

### 17. Sentry Key®/Security Alarm Indicator Light — If Equipped

Refer to “Sentry Key® Immobilizer System” or “Vehicle Security Alarm” in Section 2 of this manual.

### 18. Coolant Temperature Gauge



Indicates engine coolant temperature. The red zone to the far right indicates possible overheating. Seek your authorized dealer immediately if the gauge operates in the red zone. On U.S. vehicles, the temperature is indicated in degrees fahrenheit; and on Canadian vehicles in degrees centigrade.

### 19. Cruise Indicator Light

**CRUISE** This light shows when the electronic speed control system is turned on.

### 20. 4WD Indicator Light — If Equipped

**4WD** This light alerts the driver that the vehicle is in the four-wheel drive mode, and the front and rear driveshafts are mechanically locked together forcing the front and rear wheels to rotate at the same speed.

### 21. *Odometer/Trip Odometer Reset Button*

Press this button to change the display from odometer to either of two trip odometer settings. Trip A or Trip B will appear when in the trip odometer mode. Press and hold the button for two seconds to reset the trip odometer to 0 miles or kilometers. The odometer must be in trip mode to reset.

### 22. *Transmission Range Indicator*

This display indicator shows the automatic transmission gear selection.

### 23. *Tire Pressure Monitoring Telltale Light*



Each tire, including the spare (if provided), should be checked monthly when cold and inflated to the inflation pressure recommended by the vehicle manufacturer on the vehicle placard or tire inflation pressure label. (If your vehicle has tires of a different size than the size indicated on the

vehicle placard or tire inflation pressure label, you should determine the proper tire inflation pressure for those tires.)

As an added safety feature, your vehicle has been equipped with a tire pressure monitoring system (TPMS) that illuminates a low tire pressure telltale when one or more of your tires is significantly under-inflated. Accordingly, when the low tire pressure telltale illuminates, you should stop and check your tires as soon as possible, and inflate them to the proper pressure. Driving on a significantly under-inflated tire causes the tire to overheat and can lead to tire failure. Under-inflation also reduces fuel efficiency and tire tread life, and may affect the vehicle's handling and stopping ability.

Please note that the TPMS is not a substitute for proper tire maintenance, and it is the driver's responsibility to maintain correct tire pressure, even if under-inflation has not reached the level to trigger illumination of the TPMS low tire pressure telltale.

Your vehicle has also been equipped with a TPMS malfunction indicator to indicate when the system is not operating properly. The TPMS malfunction indicator is combined with the low tire pressure telltale. When the system detects a malfunction, the telltale will flash for approximately one minute and then remain continuously illuminated. This sequence will continue upon subsequent vehicle start-ups as long as the malfunction exists. When the malfunction indicator is illuminated, the system may not be able to detect or signal low tire pressure as intended. TPMS malfunctions may occur for a variety of reasons, including the installation of replacement or alternate tires or wheels on the vehicle that prevent the TPMS from functioning properly. Always check the TPMS malfunction telltale after replacing one or more tires or wheels on your vehicle to ensure that the replacement or alternate tires and wheels allow the TPMS to continue to function properly.

### CAUTION!

**The TPMS has been optimized for the original equipment tires and wheels. TPMS pressures and warning have been established for the tire size equipped on your vehicle. Undesirable system operation or sensor damage may result when using replacement equipment that is not of the same size, type, and/or style. After-market wheels can cause sensor damage. Do not use aftermarket tire sealants or balance beads if your vehicle is equipped with a TPMS, as damage to the sensors may result.**

4

#### *24. Odometer/Trip Odometer*

The odometer shows the total distance the vehicle has been driven.

U.S. federal regulations require that upon transfer of vehicle ownership, the seller certify to the purchaser the correct mileage that the vehicle has been driven. Therefore, if the odometer reading is changed during repair or replacement, be sure to keep a record of the reading before and after the service so the correct mileage can be determined.

### *Vehicle Warning Messages*

When the appropriate conditions exist, messages such as “door” (indicates that a door(s) may be ajar), “gATE” (if the swing gate is open or ajar), “gASCAP” (which indicates that your gas cap is possibly loose or damaged), “CHANgE OIL” (indicates that the engine oil should be changed), “ESPOFF” (indicates that ESP is turned off), and “noFUSE” (indicates that the Ignition Off Draw (IOD) fuse is removed from the Integrated Power Module), will display in the odometer.

### *Change Oil Message*

Your vehicle is equipped with an engine oil change indicator system. The “CHANgE OIL” message will flash in the instrument cluster odometer for approximately 12 seconds after a single chime has sounded to indicate the next scheduled oil change interval. The engine oil change indicator system is duty-cycle based, which means the engine oil change interval may fluctuate dependent upon your personal driving style.

Unless reset, this message will continue to display each time you turn the ignition switch to the ON/RUN position. To turn off the message temporarily, press and release the Trip Odometer button on the instrument cluster. To reset the oil change indicator system (after performing the scheduled maintenance) refer to the following procedure.

1. Turn the ignition switch to the ON position (Do not start the engine).

2. Fully depress the accelerator pedal slowly three times within 10 seconds.

3. Turn the ignition switch to the OFF/LOCK position.

**NOTE:** If the indicator message illuminates when you start the vehicle, the oil change indicator system did not reset. If necessary repeat this procedure.

### 25. Malfunction Indicator Light



This light is a part of an Onboard Diagnostic System called OBD II that monitors engine and automatic transmission control systems. The light will illuminate when the ignition is in the ON position before engine start. If the bulb does not come on when turning the key from OFF to ON, have the condition checked promptly.

Certain conditions such as a loose or missing gas cap, poor quality fuel, etc. may illuminate the light after engine start. The vehicle should be serviced if the light

stays on through several typical driving styles. In most situations, the vehicle will drive normally and will not require towing.

When the engine is running, the Malfunction Indicator Light may flash to alert serious conditions that could lead to immediate loss of power or severe catalytic converter damage. The vehicle should be serviced as soon as possible if this occurs.

### 26. Electronic Stability Program (ESP) Indicator Light/Traction Control System (TCS) Indicator Light



This indicator light starts to flash as soon as the tires lose traction and the ESP system becomes active. The ESP/TCS Indicator Light also flashes when TCS is active. If the ESP/TCS Indicator Light begins to flash during acceleration, ease up on the accelerator and apply as little throttle as possible. Be sure to adapt your speed and driving to the prevailing road conditions. The ESP/TCS Indicator Light

will flash anytime the ESP or TCS is active and helping to improve vehicle stability. If the ESP/TCS Indicator Light is on solid, the ESP system has been turned off by the driver or a temporary condition exists that will not allow full ESP function.

### 27. *O/D (Overdrive) Off Indicator Light*

**O/D OFF** This light will illuminate when the O/D OFF button has been selected. The O/D OFF button is located on the center console.

### 28. *Sway Bar Indicator Light — If Equipped*

**SWAY  
BAR**

This light will illuminate when the front sway bar is disconnected.

### 29. *Electronic Stability Program (ESP)/Brake Assist System (BAS) Warning Light*

**ESP  
BAS**

The ESP/BAS Warning Light in the instrument cluster comes on when the ignition switch is turned to the ON position. The light should go

out with the engine running. If the ESP/BAS Warning Light comes on continuously with the engine running, a malfunction has been detected in either the ESP or the BAS system. If this light stays illuminated, have the ESP and BAS checked at your authorized dealer as soon as possible. Refer to “Electronic Brake Control System” in Section 3 for more information.

### 30. *Electronic Throttle Control (ETC) Warning Light — If Equipped*



This light informs you of a problem with the Electronic Throttle Control System. If a problem is detected while the engine is running, the light will either stay on or flash depending on the nature of the problem. Cycle the ignition key when the vehicle is safely and completely stopped and the shift lever is placed in the PARK position. The light should turn off. If the light remains on with the engine running, your vehicle will usually be drivable, however, see your authorized dealer for service as soon as possible.

If the light continues to flash when the engine is running, immediate service is required and you may experience reduced performance, an elevated/rough idle, or engine stall and your vehicle may require towing. The light will come on when the ignition is first turned on and remain on briefly as a bulb check. If the light does not come on during starting, have the system checked by your authorized dealer.

### 31. *Compass/Mini-Trip Computer Display — If Equipped*

When the appropriate conditions exist, this display shows the Mini-Trip Computer messages. Refer to “Mini-Trip Computer” later in this section.

32. *Compass/Mini-Trip Computer Button—If Equipped*  
Press this button to switch between the different functions.

## COMPASS AND TRIP COMPUTER — IF EQUIPPED

This feature, located on the instrument cluster (speedometer and tachometer), displays information on outside temperature, compass direction, and trip information.

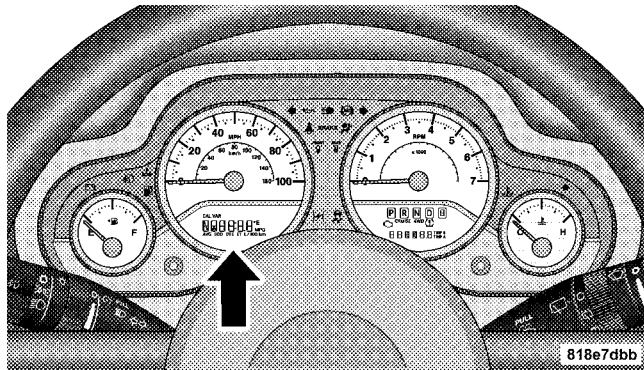



## Control Buttons

Press and release the left button (on the instrument cluster) to access the computer displays.

Press and hold the left button (on the instrument cluster) for two to three seconds to switch from English to Metric displays.

## Reset

Press and hold the right button (on the instrument cluster) while function is being displayed to reset.

The following trip conditions can be reset:

- AVG ECO (changes to present fuel economy)
- ET

## Trip Conditions

### Average Fuel Economy (AVG ECO)

This display shows the average fuel economy since the last reset.

### Estimated Range (DTE)

This display shows the estimated distance that can be traveled with the fuel remaining in the tank. This estimated distance is based on the most recent trip information: (Average Fuel Economy) x (Fuel Remaining)

This display cannot be reset.

### Elapsed Time (ET)

This display shows the accumulated ignition ON time since the last reset.

### **Trip Odometer (ODO)**

This display shows the distance traveled since the last reset. Press and release the right button (on the instrument cluster) to switch from odometer, to Trip A or Trip B. Press and hold the right button while the odometer/trip odometer is displayed to reset.

### **Trip A**

Shows the total distance traveled for Trip A since the last reset.

### **Trip B**

Shows the total distance traveled for Trip B since the last reset.

### **Compass Temperature Display**

This display provides the outside temperature and one of eight compass readings to indicate the direction the vehicle is facing.

### **WARNING!**

**Even if the display still reads a few degrees above 32°F ( 0°C), the road surface may be icy, particularly in woods or on bridges. Drive carefully under such conditions to prevent an accident and possible personal injury or property damage.**

4

### **Compass Calibration**

The Automatic Compass Calibration feature eliminates the need for operator intervention under normal conditions. If the CAL indicator is lit, the compass needs to be calibrated. A good calibration requires a level surface and an environment free of large metal objects such as large buildings, bridges, underground cables, railroad tracks, etc.

**NOTE:** Magnetic materials should be kept away from the top of the instrument panel above the radio. This is where the compass sensor is located.

### Automatic Compass Calibration

The self-calibrating feature of the compass eliminates the need to calibrate the compass for normal conditions. During a short initial period, the compass may appear erratic and the CAL symbol will appear (blinking) on the display. After the vehicle has completed at least one complete circle under 5 mph (8 km/h) in an area free from large metal objects, calibration will be complete when the CAL symbol is extinguished.

After initial calibration, the compass will continue to automatically update this calibration whenever the vehicle is in motion.

### Manual Compass Calibration

**NOTE:** Before attempting a manual compass calibration, the engine must be running and the transmission in the PARK position (if equipped).

If the compass seems in error or erratic, you may wish to manually recalibrate the compass. To manually calibrate the compass, you must first enter the variance mode. Press and hold the left button (located on the instrument cluster) for approximately 10 seconds to enter the variance mode, and release the button when the VAR (Compass Variance) symbol appears. The current variance value will also be displayed. Once in the variance mode, it is necessary to release the button, and then press and hold it again (approximately 10 seconds) until CAL is displayed (solid, not blinking). Manual compass calibration has been initiated. Drive the vehicle slowly in one or more circles under 5 mph (8 km/h) in an area free from large metal objects until the CAL symbol is extinguished.

When the CAL symbol is no longer displayed, the compass is calibrated and should display correct headings. Verify proper calibration by checking North (N), South (S), East (E), and West (W). If the compass does not appear accurate, repeat the calibration procedure in another area.

### Compass Variance (VAR)

Variance is the difference between magnetic North and geographic North. For proper compass function, the correct variance zone must be set.

### Setting the Compass Variance

Refer to the variance map for the correct compass variance zone. To check the variance zone, the ignition must be ON. Press and hold the left button (located on the instrument cluster) for approximately 10 seconds to enter the variance mode and release the button when the VAR symbol appears. The current variance value will also be displayed. To change the zone, press the left button once

to increment the zone. The default is Zone 8. After Zone 15, the values will wrap around to Zone 1. When the correct zone is displayed (per the Compass Variance Zone Map) for the zone that the vehicle is located in, wait for about five seconds, then the trip computer will store the variance value in memory and the compass will resume normal operation.

**NOTE:** The U.S./Metric display will change from English to Metric or Metric to English before the VAR symbol appears, however, it will revert back to its original setting after programming the compass functions.

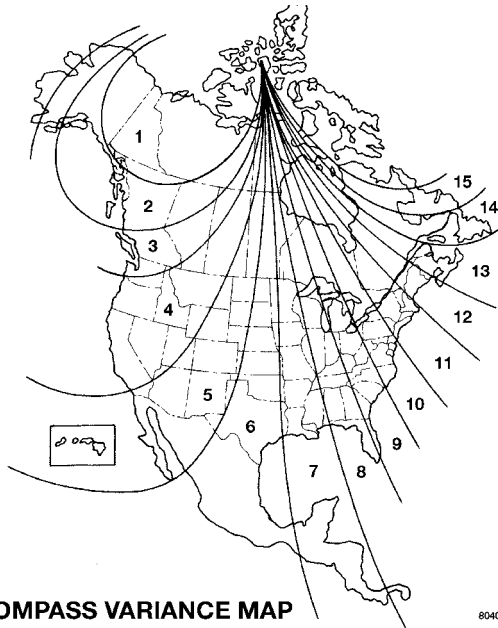

COMPASS VARIANCE MAP

8040bf97

### Outside Temperature

If the outside temperature is more than 131°F (55°C), the display will show 131°F (55°C). When the outside temperature is less than -40°F (-40°C), the display will show -40°F (-40°C).

## RADIO GENERAL INFORMATION

### Radio Broadcast Signals

The radio will provide excellent reception under most operating conditions. Like any system, however, automotive radios have performance limitations, due to mobile operation and natural phenomena, which might lead you to believe your sound system is malfunctioning. To help you understand and save you concern about these “apparent” malfunctions, you must understand a point or two about the transmission and reception of radio signals.

## Two Types of Signals

There are two basic types of radio signals: AM or Amplitude Modulation, in which the transmitted sound causes the amplitude, or height, of the radio waves to vary; and FM or Frequency Modulation, in which the frequency of the wave is varied to carry the sound.

## Electrical Disturbances

Radio waves may pick up electrical disturbances during transmission. They mainly affect the wave amplitude, and thus remain a part of the AM reception. They interfere very little with the frequency variations that carry the FM signal.

## AM Reception

AM sound is based on wave amplitude, so AM reception can be disrupted by such things as lightning, power lines and neon signs.

## FM Reception

Because FM transmission is based on frequency variations, interference that consists of amplitude variations can be filtered out, leaving the reception relatively clear, which is the major feature of FM radio.

**NOTE:** The radio, steering wheel radio controls (if equipped), and six-disc CD/DVD changer (if equipped) will remain active for up to 10 minutes after the ignition switch has been turned OFF. Opening a vehicle front door will cancel this feature.

## SALES CODE RES — AM/FM STEREO RADIO WITH CD PLAYER (MP3 AUX JACK)

**NOTE:** The radio sales code is located on the lower right side of your radio faceplate.

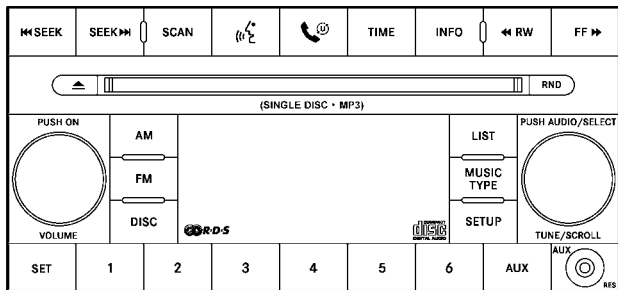

81c7c564

**RES Radio (Non-Satellite Model Shown - With Satellite Similar)**

### Operating Instructions - Radio Mode

**NOTE:** The ignition switch must be in the ON or ACC position to operate the radio.

#### Power Switch/Volume Control (Rotary)

Push the ON/VOLUME control knob to turn on the radio. Push the ON/VOLUME control knob a second time to turn off the radio.

#### Electronic Volume Control

The electronic volume control turns continuously (360 degrees) in either direction without stopping. Turning the ON/VOLUME control knob to the right increases the volume and to the left decreases it.

When the audio system is turned on, the sound will be set at the same volume level as last played.

#### SEEK Buttons

Press and release the SEEK buttons to search for the next listenable station in AM/FM mode. Press the right switch

to seek up and the left switch to seek down. The radio will remain tuned to the new station until you make another selection. Holding either button will bypass stations without stopping until you release it.

### **SCAN Button**

Pressing the SCAN button causes the tuner to search for the next listenable station in AM or FM frequencies, pausing for five seconds at each listenable station before continuing to the next. To stop the search, press the SCAN button a second time.

### **Voice Recognition System (Radio) — If Equipped**

Refer to “Voice Recognition System (VR)” in Section 3.

### **Voice Recognition Button (UConnect® Hands-Free Phone) — If Equipped**

Press this button to operate the Hands-Free Phone (UConnect®) feature (if equipped). Refer to “Hands-Free Communication (UConnect®)” in Section 3.

If your vehicle is not equipped with or this feature is not available on your vehicle, a “Not Equipped With UConnect” message will display on the radio screen.

### **Phone Button (UConnect® Hands-Free Phone) — If Equipped**

Press this button to operate the Hands-Free Phone (UConnect®) feature (if equipped). Refer to “Hands-Free Communication (UConnect®)” in Section 3.

If your vehicle is not equipped with or this feature is not available on your vehicle, a “Not Equipped With UConnect” message will display on the radio screen.

### **TIME Button**

Press the TIME button and the time of day will display. In AM or FM mode, pressing the TIME button will switch between the time and frequency displays.



### Clock Setting Procedure

1. Press and hold the TIME button, until the hours blink.
2. Adjust the hours by turning the right side TUNE/SCROLL control knob.
3. After adjusting the hours, press the right side TUNE/SCROLL control knob to set the minutes. The minutes will begin to blink.
4. Adjust the minutes using the right side TUNE/SCROLL control knob. Press the TUNE/SCROLL control knob to save time change.
5. To exit, press any button/knob or wait five seconds.

The clock can also be set by pressing the SETUP button. For vehicles equipped with satellite radio, press the SETUP button, use the TUNE/SCROLL control to select SET CLOCK, and then follow the above procedure,

starting at Step 2. For vehicles not equipped with satellite radio, press the SETUP button and then follow the above procedure, starting at Step 2.

### INFO Button

Press the INFO button for an RDS station (one with call letters displayed). The radio will return a Radio Text message broadcast from an FM station (FM mode only).

### RW/FF

Pressing the RW (Rewind) or FF (Fast Forward) buttons causes the tuner to search for the next frequency in the direction of the arrows. This feature operates in either AM or FM frequencies.

### TUNE Control

Turn the rotary TUNE/SCROLL control knob clockwise to increase or counterclockwise to decrease the frequency.

### Setting the Tone, Balance, and Fade

Push the rotary TUNE/SCROLL control knob and BASS will display. Turn the TUNE/SCROLL control knob to the right or left to increase or decrease the bass tones.

Push the rotary TUNE/SCROLL control knob a second time and MID will display. Turn the TUNE/SCROLL control knob to the right or left to increase or decrease the mid-range tones.

Push the rotary TUNE/SCROLL control knob a third time and TREBLE will display. Turn the TUNE/SCROLL control knob to the right or left to increase or decrease the treble tones.

Push the rotary TUNE/SCROLL control knob a fourth time and BALANCE will display. Turn the TUNE/SCROLL control knob to the right or left to adjust the sound level from the right or left side speakers.

Push the rotary TUNE/SCROLL control knob a fifth time and FADE will display. Turn the TUNE/SCROLL control knob to the left or right to adjust the sound level between the front and rear speakers.

Push the rotary TUNE/SCROLL control knob again to exit setting tone, balance, and fade.

### MUSIC TYPE Button

Pressing this button once will turn on the Music Type mode for five seconds. Pressing the MUSIC TYPE button or turning the TUNE/SCROLL control knob within five seconds will allow the program format type to be selected. Many radio stations do not currently broadcast Music Type information.

Toggle the MUSIC TYPE button to select the following format types:

Program Type	16-Digit Character Display
No program type or undefined	None
Adult Hits	Adlt Hit
Classical	Classicl
Classic Rock	Cls Rock
College	College
Country	Country
Foreign Language	Language
Information	Inform
Jazz	Jazz
News	News
Nostalgia	Nostalgia
Oldies	Oldies

Program Type	16-Digit Character Display
Personality	Persnlty
Public	Public
Rhythm and Blues	R & B
Religious Music	Rel Musc
Religious Talk	Rel Talk
Rock	Rock
Soft	Soft
Soft Rock	Soft Rck
Soft Rhythm and Blues	Soft R&B
Sports	Sports
Talk	Talk
Top 40	Top 40
Weather	Weather

By pressing the SEEK button when the Music Type icon is displayed, the radio will be tuned to the next frequency

station with the same selected Music Type name. The Music Type function only operates when in the FM mode.

If a preset button is activated while in the Music Type (Program Type) mode, the Music Type mode will be exited and the radio will tune to the preset station.

### SETUP Button

Pressing the SETUP button allows you to select between the following items:

- **Set Clock** — Pressing the SELECT button will allow you to set the clock. Turn the TUNE/SCROLL control knob to adjust the hours and then press and turn the TUNE/SCROLL control knob to adjust the minutes. Press the TUNE/SCROLL control knob again to save changes.

### AM and FM Buttons

Press the buttons to select AM or FM modes.

### SET Button — To Set the Pushbutton Memory

When you are receiving a station that you wish to commit to pushbutton memory, press the SET button. The symbol SET 1 will now show in the display window. Select the button (1 to 6) you wish to lock onto this station and press and release that button. If a button is not selected within five seconds after pressing the SET button, the station will continue to play but will not be stored into pushbutton memory.

You may add a second station to each pushbutton by repeating the above procedure with this exception: Press the SET button twice and SET 2 will show in the display window. Each button can be set for SET 1 and SET 2 in both AM and FM. This allows a total of 12 AM and 12 FM stations to be stored into pushbutton memory. The stations stored in SET 2 memory can be selected by pressing the pushbutton twice.

Every time a preset button is used, a corresponding button number will display.

### **Buttons 1 - 6**

These buttons tune the radio to the stations that you commit to pushbutton memory (12 AM and 12 FM stations).

### **DISC Button**

Pressing the DISC button will allow you to switch from AM/FM modes to Disc modes.

### **Operation Instructions - CD MODE for CD and MP3 Audio Play**

**NOTE:** The ignition switch must be in the ON or ACC position to operate the radio.

**NOTE:** This radio is capable of playing compact discs (CD), recordable compact discs (CD-R), rewritable compact discs (CD-RW), compact discs with MP3 tracks and multisession compact discs with CD and MP3 tracks.

### **Inserting Compact Disc(s)**

Gently insert one CD into the CD player with the CD label facing up. The CD will automatically be pulled into the CD player and the CD icon will illuminate on the radio display. If a CD does not go into the slot more than an inch (2.5 cm), a disc may already be loaded and must be ejected before a new disc can be loaded.

If you insert a disc with the ignition ON and the radio ON, the unit will switch from radio to CD mode and begin to play when you insert the disc. The display will show the disc number, the track number, and index time in minutes and seconds. Play will begin at the start of track 1.

**CAUTION!**

- This CD player will accept 4-3/4 in (12 cm) discs only. The use of other sized discs may damage the CD player mechanism.
- Do not use adhesive labels. These labels can peel away and jam the player mechanism.
- RES is a single CD player. Do not attempt to insert a second CD if one is already loaded.
- Dual-media disc types (one side is a DVD, the other side is a CD) should not be used, and they can cause damage to the player.

**EJECT Button - Ejecting a CD**

Press the EJECT button to eject the CD.



If you have ejected a disc and have not removed it within 10 seconds, it will be reloaded. If the CD is not removed, the radio will reinsert the CD but will not play it.

A disc can be ejected with the radio and ignition OFF.

**NOTE:** Ejecting with ignition OFF is not allowed on convertible or soft-top models (if equipped).

**SEEK Button**

Press the right SEEK button for the next selection on the CD. Press the left SEEK button to return to the beginning of the current selection, or return to the beginning of the previous selection if the CD is within the first second of the current selection. Pressing and holding the SEEK button will allow faster scrolling through the tracks in CD, MP3 modes.

**SCAN Button**

Press the SCAN button to scan through each track on the CD currently playing.

**TIME Button**

Press this button to change the display from a large CD playing time display to a small CD playing time display.

**RW/FF**

Press the RW button to stop the CD at the beginning of the current CD track/title.

Press and hold FF (Fast Forward) and the CD player will begin to fast forward until FF is released or RW or another CD button is pressed. The RW (Reverse) button works in a similar manner.

**AM or FM Button**

Switches the AM or FM radio to the opposite radio mode.

**RND Button (Random Play Button)**

Press this button while the CD is playing to activate Random Play. This feature plays the selections on the compact disc in random order to provide an interesting change of pace.

Press the right SEEK button to move to the next randomly selected track.

Press the RND button a second time to stop Random Play.

**Notes On Playing MP3 Files**

The radio can play MP3 files; however, acceptable MP3 file recording media and formats are limited. When writing MP3 files, pay attention to the following restrictions.

**Supported Media (Disc Types)**

The MP3 file recording media supported by the radio are CDDA, CD-R, CD-RW, MP3, and CDDA+MP3.

**Supported Medium Formats (File Systems)**

The medium formats supported by the radio are ISO 9660 Level 1 and Level 2 and includes the Joliet extension. When reading discs recorded using formats other than ISO 9660 Level 1 and Level 2, the radio may fail to read

files properly and may be unable to play the file normally. UDF and Apple HFS formats are not supported.

The radio uses the following limits for file systems:

- Maximum number of folder levels: 8
- Maximum number of files: 255
- Maximum number of folders. (The radio display of file names and folder names is limited. For large numbers of files and/or folders, the radio may be unable to display the file name and folder name and will assign a number instead. With a maximum number of files, exceeding 20 folders will result in this display. With 200 files, exceeding 50 folders will result in this display.)
- Maximum number of characters in file/folder names:
  - Level 1: 12 (including a separator "." and a three-character extension)

- Level 2: 31 (including a separator "." and a three-character extension)

Multisession disc formats are supported by the radio. Multisession discs may contain combinations of normal CD audio tracks and computer files (including MP3 files). Discs created with an option such as "keep disc open after writing" are most likely multisession discs. The use of multisession for CD audio or MP3 playback may result in longer disc loading times.

### Supported MP3 File Formats

The radio will recognize only files with the \*.MP3 extension as MP3 files. Non-MP3 files named with the \*.MP3 extension may cause playback problems. The radio is designed to recognize the file as an invalid MP3 and will not play the file.

When using the MP3 encoder to compress audio data to an MP3 file, the bit rate and sampling frequencies in the following table are supported. In addition, variable bit



rates (VBR) are also supported. The majority of MP3 files use a 44.1 kHz sampling rate and a 192, 160, 128, 96 or VBR bit rates.

MPEG Specification	Sampling Frequency (kHz)	Bit Rate (kbps)
MPEG-1 Audio Layer 3	48, 44.1, 32	320, 256, 224, 192, 160, 128, 112, 96, 80, 64, 56, 48, 40, 32
MPEG-2 Audio Layer 3	24, 22.05, 16	160, 128, 144, 112, 96, 80, 64, 56, 48, 40, 32, 24, 16, 8

ID3 Tag information for artist, song title, and album title are supported for version 1 ID3 tags. ID3 version 2 is not supported by the radios.

Playlist files are not supported. MP3 Pro files are not supported.

### Playback of MP3 Files

When a medium containing MP3 data is loaded, the radio checks all files on the medium. If the medium contains a lot of folders or files, the radio will take more time to start playing the MP3 files.

Loading times for playback of MP3 files may be affected by the following:

- Media - CD-RW media may take longer to load than CD-R media
- Medium formats - Multisession discs may take longer to load than non-multisession discs
- Number of files and folders - Loading times will increase with more files and folders

To increase the speed of disc loading, it is recommended to use CD-R media and single-session discs. To create a single-session disc, enable the “Disc at Once” option before writing to the disc.

### **LIST Button (CD Mode for MP3 Play)**

Pressing the LIST button will bring up a list of all folders on the disc. Scrolling up or down the list is done by turning the TUNE/SCROLL control knob. Selecting a folder by pressing the TUNE/SCROLL control knob will begin playing the files contained in that folder (or the next folder in sequence if the selection does not contain playable files).

The folder list will time out after five seconds.

### **INFO Button (CD Mode for MP3 Play)**

Pressing the INFO button repeatedly will scroll through the following TAG information: Song Title, Artist, File Name, and Folder Name (if available).

Press the INFO button once more to return to "elapsed time" priority mode.

Press and hold the INFO button for three seconds or more and the radio will display song titles for each file.

Press and hold the INFO button again for three seconds to return to "elapsed time" display.

### **Operation Instructions - Auxiliary Mode**

The auxiliary (AUX) jack is an audio input jack, which allows the user to plug in a portable device such as an MP3 player, or cassette player, and utilize the vehicle's audio system to amplify the source and play through the vehicle speakers.

Pressing the AUX button will change the mode to auxiliary device if the AUX jack is connected.

**NOTE:** The AUX device must be turned on and the device's volume set to proper level. If the AUX audio is not loud enough, turn the device's volume up. If the AUX audio sounds distorted, turn the device's volume down.

### TIME Button (Auxiliary Mode)

Press this button to change the display to time of day. The time of day will display for five seconds (when ignition is OFF).

### Operating Instructions - Hands-Free Phone (UConnect®) (If Equipped)

Refer to “Hands-Free Communication (UConnect®)” in Section 3.

### Operating Instructions - Satellite Radio Mode (If Equipped)

Refer to “Satellite Radio” in this section.

### Operating Instructions - Video Entertainment System™ (VES®) (If Equipped)

Refer to separate “Video Entertainment System™ (VES®) Guide.”

### SALES CODE REQ — AM/FM STEREO RADIO AND 6-DISC CD/DVD CHANGER (MP3/WMA AUX JACK)

**NOTE:** The radio sales code is located on the lower right side of your radio faceplate.

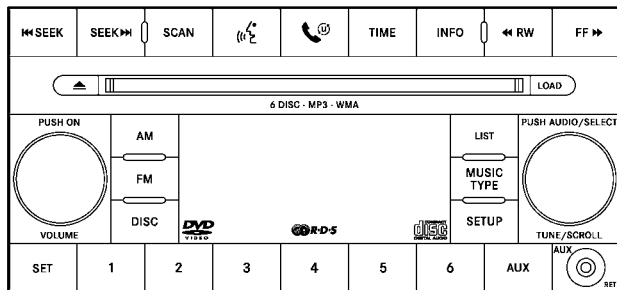

8189f8f9

REQ Radio

## Operating Instructions - Radio Mode

**NOTE:** The ignition switch must be in the ON or ACC position to operate the radio.

### Power Switch/Volume Control (Rotary)

Push the ON/VOLUME control knob to turn on the radio. Press the ON/VOLUME control knob a second time to turn off the radio.

### Electronic Volume Control

The electronic volume control turns continuously (360 degrees) in either direction without stopping. Turning the ON/VOLUME control knob to the right increases the volume and to the left decreases it.

When the audio system is turned ON, the sound will be set at the same volume level as last played.

### SEEK Buttons

Press and release the SEEK buttons to search for the next listenable station in AM/FM mode. Press the right switch

to seek up and the left switch to seek down. The radio will remain tuned to the new station until you make another selection. Holding either button will bypass stations without stopping until you release it.

### SCAN Button

Pressing the SCAN button causes the tuner to search for the next listenable station, in AM, FM or Satellite (if equipped) frequencies, pausing for five seconds at each listenable station before continuing to the next. To stop the search, press the SCAN button a second time.

### Voice Recognition Button (UConnect® Hands-Free Phone) — If Equipped

Press this button to operate the Hands-Free Phone (UConnect®) feature (if equipped). Refer to “Hands-Free Communication (UConnect®)” in Section 3.

If your vehicle is not equipped with or this feature is not available on your vehicle, a “Not Equipped With UConnect” message will display on the radio screen.

**Phone Button (UConnect® Hands-Free Phone) — If Equipped**

Press this button to operate the Hands-Free Phone (UConnect®) feature (if equipped). Refer to “Hands-Free Communication (UConnect®)” in Section 3.

If your vehicle is not equipped with or this feature is not available on your vehicle, a “Not Equipped With UConnect” message will display on the radio screen.

**TIME Button**

Press the TIME button and the time of day will display. In AM or FM mode, pressing the TIME button will switch between the time and frequency displays.

**Clock Setting Procedure**

1. Press and hold the TIME button until the hours blink.
2. Adjust the hours by turning the right side TUNE/SCROLL control knob.

3. After adjusting the hours, press the right side TUNE/SCROLL control knob to set the minutes. The minutes will begin to blink.

4. Adjust the minutes using the right side TUNE/SCROLL control knob. Press the TUNE/SCROLL control knob to save the time change.

5. To exit, press any button/knob or wait five seconds.

The clock can also be set by pressing the SETUP button and selecting the “SET HOME CLOCK” entry. Once in this display follow the above procedure, starting at step 2.

**INFO Button**

Press the INFO button for an RDS station (one with call letters displayed). The radio will return a Radio Text message broadcast from an FM station (FM mode only).

**RW/FF**

Pressing the RW (Rewind) or FF (Fast Forward) buttons causes the tuner to search for the next frequency in the direction of the arrows. This feature operates in AM, FM or Satellite (if equipped) frequencies.

**TUNE Control**

Turn the rotary TUNE/SCROLL control knob clockwise to increase or counterclockwise to decrease the frequency.

**Setting the Tone, Balance, and Fade**

Push the rotary TUNE/SCROLL control knob and BASS will display. Turn the TUNE/SCROLL control knob to the right or left to increase or decrease the bass tones.

Push the rotary TUNE/SCROLL control knob a second time and MID will display. Turn the TUNE/SCROLL control knob to the right or left to increase or decrease the mid-range tones.

Push the rotary TUNE/SCROLL control knob a third time and TREBLE will display. Turn the TUNE/SCROLL control knob to the right or left to increase or decrease the treble tones.

Push the rotary TUNE/SCROLL control knob a fourth time and BALANCE will display. Turn the TUNE/SCROLL control knob to the right or left to adjust the sound level from the right or left side speakers.

Push the rotary TUNE/SCROLL control knob a fifth time and FADE will display. Turn the TUNE/SCROLL control knob to the left or right to adjust the sound level between the front and rear speakers.

Push the rotary TUNE/SCROLL control knob again to exit setting tone, balance, and fade.

**MUSIC TYPE Button**

Pressing this button once will turn on the Music Type mode for five seconds. Pressing the MUSIC TYPE button or turning the TUNE/SCROLL control knob within five seconds will allow the program format type to be selected. Many radio stations do not currently broadcast Music Type information.

Toggle the MUSIC TYPE button to select the following format types:

Program Type	16-Digit Character Display
No program type or undefined	None
Adult Hits	Adlt Hit
Classical	Classicl
Classic Rock	Cls Rock
College	College
Country	Country

Program Type	16-Digit Character Display
Foreign Language	Language
Information	Inform
Jazz	Jazz
News	News
Nostalgia	Nostalga
Oldies	Oldies
Personality	Persnlty
Public	Public
Rhythm and Blues	R & B
Religious Music	Rel Musc
Religious Talk	Rel Talk
Rock	Rock
Soft	Soft
Soft Rock	Soft Rck
Soft Rhythm and Blues	Soft R&B

Program Type	16-Digit Character Display
Sports	Sports
Talk	Talk
Top 40	Top 40
Weather	Weather

By pressing the SEEK button when the Music Type icon is displayed, the radio will be tuned to the next frequency station with the same selected Music Type name. The Music Type function only operates when in the FM mode.

If a preset button is activated while in the Music Type (Program Type) mode, the Music Type mode will be exited and the radio will tune to the preset station.

### SETUP Button

Pressing the SETUP button allows you to select between the following items:

**NOTE:** Turn the TUNE/SCROLL control knob to scroll through the entries. Push the AUDIO/SELECT button to select an entry and make changes.

- **DVD Enter** - When the disc is in DVD Menu mode, selecting DVD Enter will allow you to play the current highlighted selection. Use the remote control to scroll up and down the menu (if equipped).



- **DISC Play/Pause** - You can toggle between playing the DVD and pausing the DVD by pushing the SELECT button (if equipped).

- **DVD Play Options** - Selecting the DVD Play Options will display the following:

- **Subtitle** – Repeatedly pressing SELECT will switch subtitles to different subtitle languages that are available on the disc (if equipped).



- **Audio Stream** – Repeatedly pressing SELECT will switch to different audio languages (if supported on the disc) (if equipped).
- **Angle** – Repeatedly pressing SELECT will change the viewing angle if supported by the DVD disc (if equipped).

**NOTE:** The available selections for each of the above entries varies depending upon the disc.

**NOTE:** These selections can only be made while playing a DVD.

- **VES® Power** - Allows you to turn VES® ON and OFF (if equipped).
- **VES® Lock** - Locks out rear VES® remote controls (if equipped).

- **VES® CH1/CH2** - Allows the user to change the mode of either the IR1 or IR2, wireless headphones by pressing the AUDIO/SELECT button (if equipped).
- **Set Home Clock** - Pressing the SELECT button allows you to set the clock. Turn the TUNE/SCROLL control knob to adjust the hours and then press and turn the TUNE/SCROLL control knob to adjust the minutes. Press the TUNE/SCROLL control knob again to save changes.
- **Player Defaults** - Selecting this item will allow the user to scroll through the following items, and set defaults according to customer preference.

### *Menu Language — If Equipped*

Selecting this item will allow the user to choose the default startup DVD menu language (effective only if language supported by disc). If you want to select a language not listed, then scroll down and select "other."

Enter the four-digit country code using the TUNE/SCROLL control knob to scroll up and down to select the number and then push to select.

### *Audio Language — If Equipped*

Selecting this item allows you to choose a default audio language (effective only if the language is supported by the disc). You can select a language not listed by scrolling down and selecting "other." Enter the country code using the TUNE/SCROLL control knob to scroll up and down to select the number and then push to select.

### *Subtitle Language — If Equipped*

Selecting this item allows you to choose a default subtitle language (effective only if the language is supported by the disc). You can select a language not listed by scrolling down and selecting "other." Enter the country code using the TUNE/SCROLL control knob to scroll up and down to select the number and then push to select.

### *Subtitles — If Equipped*

Selecting this item allows you to choose between subtitle Off or On.

### *Audio DRC — If Equipped*

Selecting this item allows you to limit maximum audio dynamic range. The default is set to "High," and under this setting, dialogues will play at 11 db higher than if the setting is "Normal."

### *Aspect Ratio — If Equipped*

Selecting this item allows you to choose between wide screen, pan scan, and letter box.

### *AutoPlay — If Equipped*

When this is set to On and a DVD video is inserted, it will bypass the DVD menu screen and automatically play the movie. In some rare cases, the DVD player may not

auto-play the main title. In such cases, use the MENU button on the remote control to select desired title to play.

**NOTE:** The user will have to set these defaults before loading a disc. If changes are made to these settings after a disc is loaded, changes will not be effective. Also, the defaults are effective only if the disc supports the customer-preferred settings.

### **AM and FM Buttons**

Press the buttons to select AM or FM Modes.

### **SET Button — To Set the Pushbutton Memory**

When you are receiving a station that you wish to commit to pushbutton memory, press the SET button. The symbol SET 1 will now show in the display window. Select the button (1-6) you wish to lock onto this station and press and release that button. If a button is not selected within five seconds after pressing the SET button, the station will continue to play but will not be stored into pushbutton memory.

You may add a second station to each pushbutton by repeating the above procedure with this exception: Press the SET button twice and SET 2 will show in the display window. Each button can be set for SET 1 and SET 2 in both AM and FM. This allows a total of 12 AM, 12 FM, and 12 Satellite (if equipped) stations to be stored into pushbutton memory. The stations stored in SET 2 memory can be selected by pressing the pushbutton twice.

Every time a preset button is used, a corresponding button number will display.

### **Buttons 1 - 6**

These buttons tune the radio to the stations that you commit to pushbutton memory {12 AM, 12 FM, and 12 Satellite (if equipped) stations}.

### **DISC Button**

Pressing the DISC button will allow you to switch from AM/FM modes to Disc modes.

### Operation Instructions - (DISC MODE for CD and MP3/WMA Audio Play, DVD-VIDEO)

The radio DVD player and many DVD discs are coded by geographic region. These region codes must match in order for the disc to play. If the region code for the DVD disc does not match the region code for the radio DVD player, it will not play the disc. Customers may take their vehicle to an authorized dealer to change the region code of the player a maximum of five times.

#### CAUTION!

The radio may shut down during extremely hot conditions. When this occurs, the radio will indicate "Disc Hot" and shut off until a safe temperature is reached. This shutdown is necessary to protect the optics of the DVD player and other radio internal components.

**NOTE:** The ignition switch must be in the ON or ACC position to operate the radio.

#### LOAD Button — Loading Compact Disc(s)

Press the LOAD button and the pushbutton with the corresponding number (1-6) where the CD is being loaded. The radio will display PLEASE WAIT and prompt when to INSERT DISC. After the radio displays "INSERT DISC," insert the CD into the player.

Radio display will show "LOADING DISC" when the disc is loading and "READING DISC" when the radio is reading the disc.

#### CAUTION!

This CD player will accept 4-3/4 in (12 cm) discs only. The use of other sized discs may damage the CD player mechanism.

**Eject Button — Ejecting Compact Disc(s)**

Press the EJECT button and the pushbutton with the corresponding number (1-6) where the CD was loaded and the disc will unload and move to the entrance for easy removal. Radio display will show "EJECTING DISC" when the disc is being ejected and prompt the user to remove the disc.

Press and hold the EJECT button for five seconds and all CDs will be ejected from the radio.

The disc can be ejected with the radio and ignition OFF.

**SEEK Button (CD MODE)**

Press the right SEEK button for the next selection on the CD. Press the left SEEK button to return to the beginning of the current selection, or return to the beginning of the previous selection if the CD is within the first second of the current selection. Pressing and holding the SEEK button will allow you to scroll through the tracks faster in CD, MP3/MWA modes.

**SCAN Button (CD MODE)**

Press the SCAN button to scan through each track on the CD currently playing.

**TIME Button (CD MODE)**

Press this button to change the display from a large CD playing time display to a small CD playing time display.

**RW/FF (CD MODE)**

Press and hold FF (Fast Forward) and the CD player will begin to fast forward until FF is released, or RW or another CD button is pressed. The RW (Rewind) button works in a similar manner.

**AM or FM Button (CD MODE)**

Switches the radio to the Radio mode.

### Notes On Playing MP3/WMA Files

The radio can play MP3/WMA files; however, acceptable MP3/WMA file recording media and formats are limited. When writing MP3/WMA files, pay attention to the following restrictions.

### Supported Media (Disc Types)

The MP3/WMA file recording media supported by the radio are CDDA, CD-R, CD-RW, MP3, WMA, DVD Video, DVD-R, DVD-RW, DVD+R, DVD+RW, and CDDA+MP3.

### Supported Medium Formats (File Systems)

The medium formats supported by the radio are ISO 9660 Level 1 and Level 2 and includes the Joliet extension. When reading discs recorded using formats other than ISO 9660 Level 1 and Level 2, the radio may fail to read files properly and may be unable to play the file normally. UDF and Apple HFS formats are not supported.

The radio uses the following limits for file systems:

- Maximum number of directory levels: 8
- Maximum number of files: 255
- Maximum number of folders: 100
- Maximum number of characters in file/folder names:
  - Level 1: 12 (including a separator "." and a three-character extension)
  - Level 2: 31 (including a separator "." and a three-character extension)

Multisession disc formats are supported by the radio. Multisession discs may contain combinations of normal CD audio tracks and computer files (including MP3/WMA files). Discs created with an option such as "keep disc open after writing" are most likely multisession discs. The use of multisession for CD audio or MP3/WMA playback may result in longer disc loading times.

If a disc contains multi-formats, such as CD audio and MP3/WMA tracks, the radio will only play the MP3/WMA tracks on that disc.

### Supported MP3/WMA File Formats

The radio will recognize only files with the \*.MP3/WMA extension as MP3/WMA files. Non-MP3/WMA files named with the \*.MP3/WMA extension may cause playback problems. The radio is designed to recognize the file as an invalid MP3/WMA and will not play the file.

When using the MP3/WMA encoder to compress audio data to an MP3/WMA file, the bit rate and sampling frequencies in the following table are supported. In addition, variable bit rates (VBR) are also supported. The majority of MP3/WMA files use a 44.1 kHz sampling rate and a 192, 160, 128, 96 or VBR bit rates.

MPEG Specification	Sampling Frequency (kHz)	Bit Rate (kbps)
MPEG-1 Audio Layer 3	48, 44.1, 32	320, 256, 224, 192, 160, 128, 112, 96, 80, 64, 56, 48
MPEG-2 Audio Layer 3	24, 22.05, 16	160, 128, 144, 112, 96, 80, 64, 56, 48
WMA Specification	Sampling Frequency (kHz)	Bit Rate (kbps)
WMA	44.1 and 48	48, 64, 96, 128, 160, 192 VBR

ID3 Tag information for artist, song title, and album title are supported for ID3 version 1 tags. ID3 version 2 is not supported by the radios.

Playlist files are not supported. MP3 Pro files are not supported.

### Playback of MP3/WMA Files

When a medium containing MP3/WMA data is loaded, the radio checks all files on the medium. If the medium contains a lot of folders or files, the radio will take more time to start playing the MP3/WMA files.

Loading times for playback of MP3/WMA files may be affected by the following:

- Media - CD-RW media may take longer to load than CD-R media
- Medium formats - Multisession discs may take longer to load than non-multisession discs
- Number of files and folders - Loading times will increase with more files and folders

To increase the speed of disc loading, it is recommended to use CD-R media and single-session discs. To create a single-session disc, enable the "Disc at Once" option before writing to the disc.

### LIST Button (DISC Mode for MP3/WMA Play)

Pressing the LIST button will bring up a list of all folders on the disc. Scrolling up or down the list is done by turning the TUNE/SCROLL control knob. Selecting a folder by pressing the TUNE/SCROLL control knob will begin playing the files contained in that folder (or the next folder in sequence if the selection does not contain playable files).

The folder list will time out after five seconds.

### INFO Button (DISC Mode for MP3/WMA Play)

Pressing the INFO button repeatedly will scroll through the following TAG information: Song Title, Artist, File Name, and Folder Name (if available).

Press the INFO button once more to return to "elapsed time" priority mode.

Press and hold the INFO button for three seconds or more and radio will display song titles for each file.



Press and hold the INFO button again for three seconds to return to "elapsed time" display.

### **Operation Instructions - Auxiliary Mode**

The auxiliary (AUX) jack is an audio input jack, which allows the user to plug in a portable device such as an MP3/WMA player, cassette player, or microphone and utilize the vehicle's audio system to amplify the source and play through the vehicle speakers.

Pressing the AUX button will change the mode to auxiliary device if the AUX jack is connected.

**NOTE:** The AUX device must be turned on and the device's volume set to the proper level. If the AUX audio is not loud enough, turn the device's volume up. If the AUX audio sounds distorted, turn the device's volume down.

### **SEEK Button (Auxiliary Mode)**

No function.

### **SCAN Button (Auxiliary Mode)**

No function.

### **EJECT Button (Auxiliary Mode)**

No function.



### **TIME Button (Auxiliary Mode)**

Press the TIME button to change the display from elapsed playing time to time of day. The time of day will display for five seconds.

### **RW/FF (Auxiliary Mode)**

No function.

### **SET Button (Auxiliary Mode)**

No function.

### **Operating Instructions — Voice Recognition System (VR) (If Equipped)**

For the radio, refer to “Voice Recognition System (VR)” in Section 3.

For UConnect® “Voice Recognition System (VR),” refer to “Hands-Free Communication (UConnect®)” in Section 3.

### **Operating Instructions - Hands-Free Phone (UConnect®) (If Equipped)**

Refer to “Hands-Free Communication (UConnect®)” in Section 3.

### **Operating Instructions - Satellite Radio Mode (If Equipped)**

Refer to “Satellite Radio” in this section.

### **Operating Instructions - Video Entertainment System (VES®) (If Equipped)**

Refer to separate “Video Entertainment System (VES®) Guide.”

### ***Dolby®***

Manufactured under license from Dolby® Laboratories. “Dolby®” and the double-D symbol are trademarks of Dolby® Laboratories.

### ***Macrovision***

This product incorporates copyright protection technology that is protected by U.S. patents and other intellectual property rights. Use of this copyright protection technology must be authorized by Macrovision, and is intended for home and other limited viewing uses only, unless otherwise authorized by Macrovision. Reverse engineering or disassembly is prohibited

### ***DTS™***

“DTS™” and “DTS™ 2.0” are trademarks of Digital Theater Systems, Inc.

## SALES CODE RER — MULTIMEDIA SYSTEM — IF EQUIPPED

**NOTE:** The sales code is located on the lower right side of the unit's faceplate.

The RER Multimedia system contains a radio, Sirius Satellite Radio player, navigation system, CD/DVD player, USB port, 20-gigabyte hard drive (HDD), and the UConnect® Hands-Free Bluetooth® cellular system.

**NOTE:** If your vehicle is not equipped with UConnect®, the unit will respond with a "Not Equipped With UConnect®" message when selecting controls related to this feature.

A 6.5 in (16.5 cm) touch screen allows easy menu selection, while the Advanced Voice Dialog System recognizes more than 1,000 words for audio, navigation, entertainment, and hands-free mobile phone use.

The satellite navigation capability combines a Global-Positioning System (GPS)-based navigation system with an integrated color screen to provide maps, turn identification, selection menus, and instructions for selecting a variety of destinations and routes.

A shared HDD for the navigation system, the database, and other radio features allows uploads of music and photos from CDs or through the USB port. The Gracenote database finds the artist, track, and title for the music.

An auxiliary input jack permits passengers to listen to a portable MP3 player through the vehicle's speakers. For vehicles equipped with the Vehicle Entertainment System (VES)®, separate audio outputs allow passengers to listen to the vehicle speakers while different audio tracks play through the system's wireless headphones. This means rear-seat passengers can watch a DVD on the optional rear-seat entertainment system while the driver and front-seat passenger listen to the radio.

Other special features include direct tune, music type selections, traffic messaging (optional), easy store presets, parental lockout for VES® (if equipped), backup camera display for vehicles equipped with a backup camera, and on some models, a dual display screen operation. Refer to your “Navigation User’s Manual” for detailed operating instructions.

### **Operating Instructions — Satellite Radio**

Refer to your “Navigation User’s Manual” for detailed operating instructions.

### **Operating Instructions — Hands-Free Communication (UConnect®) (If Equipped)**

Refer to your “Navigation User’s Manual” for detailed operating instructions.

### **Clock Setting Procedure**

The GPS receiver in this system is synchronized to the time data being transmitted by the GPS satellites. The satellites’ clock is Greenwich Mean Time (GMT). This is the worldwide standard for time. This makes the system’s clock very accurate once the appropriate time zone and daylight savings information is set.

### **Changing the Time Zone**

1. Turn on the multimedia system.
2. Touch the screen where the time is displayed. The clock setting menu will appear on the screen. If the words “Time: GPS Time” are displayed at the top of the screen, proceed to Step 4. Otherwise, proceed to Step 3.
3. If the words “Time: User Clock” are displayed at the top of the screen, touch the bottom of the screen where the words “User Clock” are displayed. The GPS time setting menu will appear on the screen.

4. Touch the screen where the words “Set Time Zone” are displayed. The time zone selection menu will appear on the screen.

5. Select a time zone by touching the screen where your selection appears. If you do not see a time zone that you want to select, touch the screen where the word “Page” is displayed to view additional time zones in the menu.

### **Changing Daylight Savings Time**

When selected, this feature will display the time of day in daylight savings time. Proceed as follows to change the current setting:

1. Turn on the multimedia system.
2. Touch the screen where the time is displayed. The clock setting menu will appear on the screen.

3. When this feature is on, a check mark will appear in the box next to the words “Daylight Savings.” Touch the screen where the words “Daylight Savings” are displayed to change the current setting.

### **Setting the User Clock**

If you wish to set the clock to a time different from the system clock, you can manually adjust the time by performing the following:

1. Turn on the multimedia system.
2. Touch the screen where the time is displayed. The clock setting menu will appear on the screen. If the words “Time: User Clock” are displayed at the top of the screen, proceed to Step 4. Otherwise, proceed to Step 3.
3. If the words “Time: GPS Time” are displayed at the top of the screen, touch the bottom of the screen where the words “GPS Time” are displayed. The user clock time setting menu will appear on the screen.

4. To move the hour forward, touch the screen where the word “Hour” with the arrow pointing upward is displayed. To move the hour backward, touch the screen where the word “Hour” with the arrow pointing downward is displayed.
5. To move the minute forward, touch the screen where the word “Min” with the arrow pointing upward is displayed. To move the minute backward, touch the screen where the word “Min” with the arrow pointing downward is displayed.
6. To save the new time setting, touch the screen where the word “Save” is displayed.

#### **Show Time if Radio is Off**

When selected, this feature will display the time of day on the touch screen when the system is turned off. Proceed as follows to change the current setting:

1. Turn on the multimedia system.

2. Touch the screen where the time is displayed. The clock setting menu will appear on the screen.
3. When this feature is on, a check mark will appear in the box next to the words “Show Time if Radio is Off.” Touch the screen where the words “Show Time if Radio is Off” are displayed to change the current setting.

#### **SATELLITE RADIO — IF EQUIPPED (REN/REQ/RER/RES RADIOS ONLY)**

Satellite radio uses direct satellite-to-receiver broadcasting technology to provide clear digital sound, coast to coast. The subscription service provider is Sirius Satellite Radio. This service offers over 130 channels of music, sports, news, entertainment, and programming for children, directly from its satellites and broadcasting studios.

**NOTE:** Sirius service is not available in Hawaii and has limited coverage in Alaska.

## System Activation

Sirius Satellite Radio service is pre-activated, and you may begin listening immediately to the one year of audio service that is included with the factory-installed satellite radio system in your vehicle. Sirius will supply a welcome kit that contains general information, including how to setup your on-line listening account at no additional charge. For further information, call the toll-free number 888-539-7474, or visit the Sirius web site at [www.sirius.com](http://www.sirius.com), or at [www.siriuscanada.ca](http://www.siriuscanada.ca) for Canadian residents.

## Electronic Serial Number/Sirius Identification Number (ESN/SID)

Please have the following information available when calling:

1. The Electronic Serial Number/Sirius Identification Number (ESN/SID).
2. Your Vehicle Identification Number.

To access the ESN/SID, refer to the following steps:

### ESN/SID Access With RES/REQ Radios

With the ignition switch in the ON/RUN or ACC position and the radio ON, press the SETUP button and scroll using the TUNE/SCROLL control knob until Sirius ID is selected. Press the TUNE/SCROLL control knob and the Sirius ID number will display. The Sirius ID number display will time out in two minutes. Press any button on the radio to exit this screen.

### ESN/SID Access With RER/REN Radios

While in SAT mode, press the MENU button on the radio faceplate.

Next touch the SUBSCRIPTION tab on the touch screen. All the ESNs that apply to your vehicle will be displayed.

### Selecting Satellite Mode

Press the SAT button until "SAT" appears in the display. A CD may remain in the radio while in the Satellite radio mode.

### Satellite Antenna

To ensure optimum reception, do not place items on the roof around the rooftop antenna location or strap items to the trunk lid around the trunk lid antenna (if equipped). Metal objects placed within the line of sight of the antenna will cause decreased performance. Larger luggage items such as bikes should be placed as far rearward as possible, within the loading design of the rack. Do not place items directly on or above the antenna.

### Reception Quality

Satellite reception may be interrupted due to one of the following reasons:

- The vehicle is parked in an underground parking structure or under a physical obstacle.

- Dense tree coverage may interrupt reception in the form of short audio mutes.
- Driving under wide bridges or along tall buildings can cause intermittent reception.
- Placing objects over or too close to the antenna can cause signal blockage.

### Operating Instructions - Satellite Mode

**NOTE:** The ignition switch must be in the ON or ACC position to operate the radio.

### SEEK Buttons

Press and release the SEEK buttons to search for the next channel in Satellite mode. Press the right switch to seek up and the left switch to seek down. The radio will remain tuned to the new channel until you make another selection. Holding either button will bypass channels without stopping until you release it.



**SCAN Button**

Pressing the SCAN button causes the tuner to search for the next channel, pausing for eight seconds before continuing to the next. To stop the search, press the SCAN button a second time.

**INFO Button**

Pressing the INFO button will cycle between Artist, Song Title, and Composer (if available) information. Also, pressing and holding the INFO button for an additional three seconds will make the radio display the Song Title all of the time (press and hold again to return to normal display).

**RW/FF**

Pressing the RW (Rewind) or FF (Fast Forward) buttons causes the tuner to search for the next channel in the direction of the arrows.

**TUNE Control (Rotary)**

Turn the rotary TUNE/SCROLL control knob clockwise to increase or counterclockwise to decrease the channel.

**MUSIC TYPE Button**

Pressing this button once will turn on the Music Type mode for five seconds. Pressing the MUSIC TYPE button or turning the TUNE/SCROLL control knob within five seconds will allow the program format type to be selected.

Toggle the MUSIC TYPE button again to select the music type.

By pressing the SEEK button when the Music Type function is active, the radio will be tuned to the next channel with the same selected Music Type name.

If a preset button is activated while in the Music Type (Program Type) mode, the Music Type mode will be exited and the radio will tune to the preset channel.

### SETUP Button

Pressing the SETUP button allows you to select the following items:

- Display Sirius ID number — Press the AUDIO/SELECT button to display the Sirius ID number. This number is used to activate, deactivate, or change the Sirius subscription.

### SET Button – To Set the Pushbutton Memory

When you are receiving a channel that you wish to commit to pushbutton memory, press the SET button. The symbol SET 1 will now show in the display window. Select the button (1-6) you wish to lock onto this channel and press and release that button. If a button is not selected within five seconds after pressing the SET button, the channel will continue to play but will not be stored into pushbutton memory.

You may add a second channel to each pushbutton by repeating the above procedure with this exception: Press the SET button twice and SET 2 will show in the display window. Each button can be set for SET 1 and SET 2. This allows a total of 12 Satellite channels to be stored into pushbutton memory. The channels stored in SET 2 memory can be selected by pressing the pushbutton twice.

Every time a preset button is used, a corresponding button number will display.

### Buttons 1 - 6

These buttons tune the radio to the channels that you commit to pushbutton memory (12 Satellite stations).

### Operating Instructions - Hands-Free Phone (If Equipped)

Refer to “Hands-Free Communication (UConnect®)” in Section 3.

### **Operating Instructions - Video Entertainment System (VES®) (If Equipped)**

Refer to separate "Video Entertainment System (VES®) Guide."

### **CD/DVD DISC MAINTENANCE**

To keep the CD/DVD discs in good condition, take the following precautions:

1. Handle the disc by its edge; avoid touching the surface.
2. If the disc is stained, clean the surface with a soft cloth, wiping from center to edge.
3. Do not apply paper, paper CD labels, or tape to the disc; avoid scratching the disc.
4. Do not use solvents such as benzine, thinner, cleaners, or antistatic sprays.
5. Store the disc in its case after playing.

6. Do not expose the disc to direct sunlight.
7. Do not store the disc where temperatures may become too high.
8. Do not play discs that are small in size or have irregular shapes.

### **RADIO OPERATION AND CELLULAR PHONES**

Under certain conditions, the cellular phone being ON in your vehicle can cause erratic or noisy performance from your radio. This condition may be lessened or eliminated by relocating the cellular phone antenna. This condition is not harmful to the radio. If your radio performance does not satisfactorily "clear" by the repositioning of the antenna, it is recommended that the radio volume be turned down or off during cellular phone operation.

## CLIMATE CONTROLS

### Manual Heater Only

The controls for the heating/ventilation system in this vehicle consist of a series of rotary knobs. These comfort controls can be set to obtain desired interior conditions.

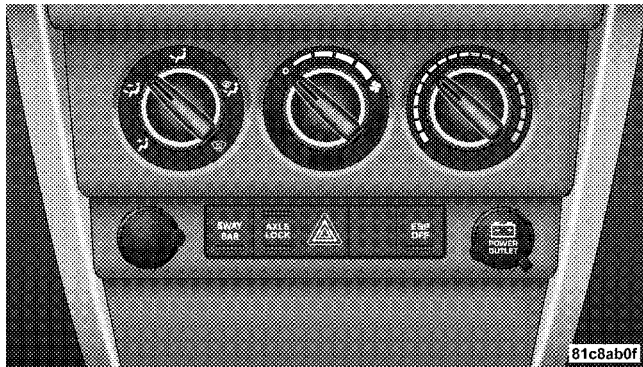

### Mode Control

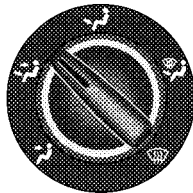

81915f2a

The mode control allows you to choose from several patterns of air distribution. You can select either a primary mode, as identified by the symbols, or a blend of two of these modes. The closer the control is to a particular mode, the more air distribution you receive from that

4

mode.

#### Panel

 Air is directed through the outlets in the instrument panel. These outlets can be adjusted to direct airflow.

#### Bi-Level

 Air is directed through the panel and floor outlets.

**NOTE:** There is a difference in temperature between the upper and lower outlets for added comfort. The warmer air goes to the floor outlets. This feature gives improved comfort during sunny but cool conditions.

### *Floor*

 Air is directed through the floor outlets and side window demist outlets with a small amount through the defrost outlet.

### *Mix*

 Air is directed through the floor, defrost and side window demist outlets. This setting works best in cold or snowy conditions that require extra heat at the windshield. This setting is good for maintaining comfort while reducing moisture on the windshield.

### *Defrost*



Air is directed through the windshield and side window demist outlets. Use this mode with maximum fan and temperature settings for best windshield and side window defrosting.

### **Blower Control**

Use this control (center rotary knob) to regulate the amount of air forced through the system in any mode you select. The fan speed increases as you move the control to the right from the OFF position.

### **Temperature Control**

Use this control (right rotary knob) to regulate the temperature of the air inside the passenger compartment. The blue area of the scale indicates cooler temperatures while the red area indicates warmer temperatures.



## Manual Air Conditioning and Heating System — If Equipped

The controls for the heating/air conditioning and ventilation system in this vehicle consist of a series of rotary knobs. These comfort controls can be set to obtain desired interior conditions.

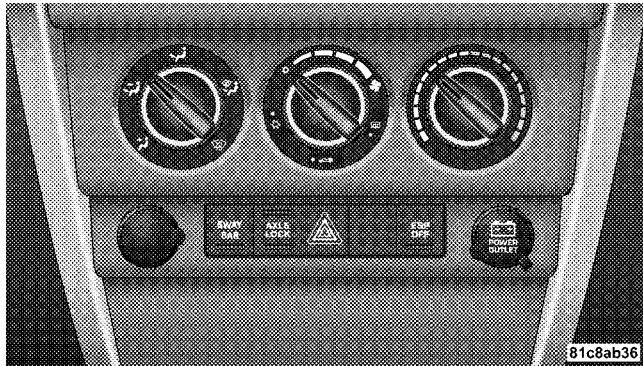

The instrument panel features four airflow registers. Two registers are located on the outer ends of the instrument panel and two are located in the center of the instrument panel. These registers can be closed to partially block airflow, and they can be adjusted to direct airflow where the occupant desires.

### Mode Control

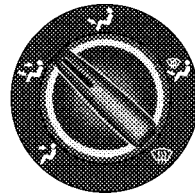

81915f2a

mode.

The mode control allows you to choose from several patterns of air distribution. You can select either a primary mode, as identified by the symbols, or a blend of two of these modes. The closer the control is to a particular mode, the more air distribution you receive from that

### *Panel*

 Air is directed through the outlets in the instrument panel. These outlets can be adjusted to direct airflow.

### *Bi-Level*

 Air is directed through the panel and floor outlets.

**NOTE:** There is a difference in temperature between the upper and lower outlets for added comfort. The warmer air goes to the floor outlets. This feature gives improved comfort during sunny but cool conditions.

### *Floor*

 Air is directed through the floor outlets and side window demist outlets with a small amount through the defrost outlet.

### *Mix*

 Air is directed through the floor, defrost and side window demist outlets. This setting works best in

cold or snowy conditions that require extra heat at the windshield. This setting is good for maintaining comfort while reducing moisture on the windshield.

### *Defrost*

 Air is directed through the windshield and side window demist outlets. Use this mode with maximum fan and temperature settings for best windshield and side window defrosting.

**NOTE:** The air conditioning compressor operates in both Mix and Defrost or a blend of these modes even if the fan switch is not in the A/C position. This dehumidifies the air to help dry the windshield. To improve fuel economy, use these modes only when necessary.

## Blower Control

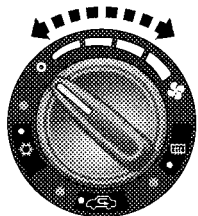

81cab396

Use this control to regulate the amount of air forced through the system in any mode you select. The fan speed increases as you move the control to the right from the OFF position.

## Temperature Control

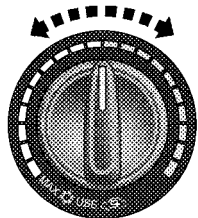

81caad41

Use this control to regulate the temperature of the air inside the passenger compartment. The blue area of the scale indicates cooler temperatures while the red area indicates warmer temperatures.

**NOTE:** If your air conditioning performance seems lower than expected, check the front of the A/C condenser: located in front of the radiator, for an accumulation of dirt or insects. Clean with a gentle water spray from behind the radiator and through the condenser. Fabric front fascia protectors may reduce air flow to the condenser, reducing air conditioning performance.

## Recirculation Control

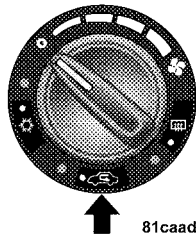

81caad32

Press this button to choose between outside air intake or recirculation of the air inside the vehicle. A lamp will illuminate when you are in "Recirculate" mode. Only use the "Recirculate" mode to temporarily block out any outside odors, smoke, or dust and to cool the interior rapidly upon initial start up in very hot or humid weather.



**NOTE:** Continuous use of the “Recirculate” mode may make the inside air stuffy and window fogging may occur. Extended use of this mode is not recommended.

In cold or damp weather, the use of the “Recirculate” mode will cause windows to fog on the inside because of moisture buildup inside the vehicle. For maximum defogging, select the Outside Air position.

**NOTE:** The “Recirculate” mode will not operate in floor, mix or defrost modes.

## Air Conditioning

### Normal Operation

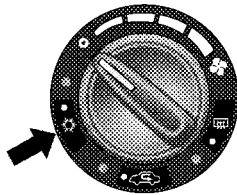

81caad38

Press this button to engage the air conditioning. A lamp will illuminate when the air conditioning system is engaged. Once the air conditioning is engaged, use a combination of the mode control, fan speed control, and temperature control to achieve your desired interior temperature.

**NOTE:** The air conditioning compressor will not engage until the engine has been running for about 10 seconds.

## MAX A/C

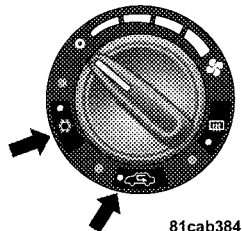

For maximum cooling, select either the Panel or Bi-Level position using the mode control. Then, press the "A/C" and the "Recirculate" buttons so that both lamps are illuminated, and set the temperature control to its coolest setting.

### NOTE:

- Recirculation Mode will not operate in floor, mix or defrost modes.
- Refer to "Recirculation Control" in this section, for proper or extended use of this position.

## Operating Tips

### Window Fogging

Windows will fog on the inside when the humidity inside the vehicle is high. This often occurs in mild or cool temperatures when it's rainy or humid. In most cases turning on the air-conditioning (pressing the snowflake button) will clear the fog. Adjust the temperature control, air direction and blower speed to maintain comfort.

As the temperature gets colder it may be necessary to direct air onto the windshield. Adjust the temperature control and blower speed to maintain comfort. Higher blower speeds will reduce fogging. Interior fogging on the windshield can be quickly removed by selecting the defrost mode.

Regular cleaning of the inside of the windows with a non-filming cleaning solution (vinegar and water works very well) will help prevent contaminants (cigarette smoke, perfumes, etc.) from sticking to the windows. Contaminates increase the rate of window fogging.

### **Summer Operation**

Air conditioned vehicles must be protected with a high quality antifreeze coolant during summer to provide proper corrosion protection and to raise the boiling point of the coolant for protection against overheating. A 50 % concentration is recommended. Refer to Fluids and Genuine Parts in Section 7 for the proper coolant type.

When using the air conditioner in extremely heavy traffic in hot weather especially when towing a trailer, additional engine cooling may be required. If this situation is encountered, operate the transmission in a lower gear to increase engine RPM, coolant flow and fan speed. When stopped in heavy traffic, it may be necessary to shift into

NEUTRAL (N) and depress the accelerator slightly for fast idle operation to increase coolant flow and fan speed.

### **Winter Operation**

When operating the system during the winter months, make sure the air intake, located directly in front of the windshield, is free of ice, slush, snow, or other obstructions.

### **Vacation Storage**

Anytime you store your vehicle, or keep it out of service (i.e., vacation) for two weeks or more, run the air conditioning system at idle for about five minutes in the fresh air and high blower setting. This will ensure adequate system lubrication to minimize the possibility of compressor damage when the system is started again.

# STARTING AND OPERATING

## CONTENTS

■ Starting Procedures . . . . .	271	■ Manual Transmission . . . . .	275
□ Manual Transmission . . . . .	271	□ Shifting . . . . .	276
□ Automatic Transmission . . . . .	271	□ Downshifting . . . . .	277
□ Normal Starting . . . . .	271	□ Reverse Shifting . . . . .	278
□ Extreme Cold Weather (Below -20°F Or -29°C) . . . . .	272	■ Automatic Transmission . . . . .	279
□ If Engine Fails To Start . . . . .	273	□ Shift Lock Manual Override . . . . .	279
□ After Starting . . . . .	274	□ Brake/Transmission Interlock System . . . . .	281
■ Engine Block Heater — If Equipped . . . . .	275	□ Automatic Transmission With Overdrive . . . . .	281

- Four-Wheel Drive Operation (Command-Trac™ Or Rock-Trac™) — If Equipped . . . . .285
  - Operating Instructions/Precautions . . . . .285
  - Shift Positions . . . . .287
  - Shifting Procedure . . . . .288
- Trac-Lok™ Rear Axle — If Equipped . . . . .289
- Axle Lock (Tru-Lok™) — Rubicon Models . . . . .290
- Rear Axle Lock — 4WD Non-Rubicon Models (If Equipped) . . . . .291
- Electronic Sway Bar Disconnect — If Equipped . . .292
- On-Road Driving Tips . . . . .294
- Off-Road Driving Tips . . . . .294
  - Side Step Removal — If Equipped . . . . .294
  - The Basics Of Off-Road Driving . . . . .296
  - When To Use 4L (Low) Range . . . . .297
  - Simultaneous Brake And Throttle Operation . . .297
  - Driving In Snow, Mud And Sand . . . . .297
  - Crossing Obstacles (Rocks And Other High Points) . . . . .299
  - Hill Climbing . . . . .301
  - Driving Through Water . . . . .304
  - After Driving Off-Road . . . . .307
- Parking Brake . . . . .308
- Anti-Lock Brake System . . . . .309
- Power Steering . . . . .311
- Tire Safety Information . . . . .313
  - Tire Markings . . . . .313

□ Tire Identification Number (TIN) . . . . .	316	■ Tire Rotation Recommendations . . . . .	329
□ Tire Loading And Tire Pressure . . . . .	317	■ Tire Pressure Monitor System (TPMS) . . . . .	330
■ Tires — General Information . . . . .	321	□ Base System . . . . .	333
□ Tire Pressure . . . . .	321	□ General Information . . . . .	335
□ Tire Inflation Pressures . . . . .	322	■ Fuel Requirements . . . . .	336
□ Tire Pressures For High-Speed Operation . . . . .	324	□ Reformulated Gasoline . . . . .	336
□ Radial-Ply Tires . . . . .	325	□ Gasoline/Oxygenate Blends . . . . .	337
□ Tire Spinning . . . . .	325	□ MMT In Gasoline . . . . .	337
□ Tread Wear Indicators . . . . .	326	□ Materials Added To Fuel . . . . .	338
□ Life Of Tire . . . . .	326	□ Fuel System Cautions . . . . .	338
□ Replacement Tires . . . . .	327	□ Carbon Monoxide Warnings . . . . .	339
□ Alignment And Balance . . . . .	328	■ Adding Fuel . . . . .	340
■ Tire Chains . . . . .	329	□ Fuel Filler Cap (Gas Cap) . . . . .	340

■ Vehicle Loading . . . . .	342	□ Trailer And Trailer Tongue Weight . . . . .	352
□ Certification Label . . . . .	342	□ Towing Requirements . . . . .	353
■ Trailer Towing . . . . .	344	□ Towing Tips . . . . .	357
□ Common Towing Definitions . . . . .	345	■ Recreational Towing (Behind Motorhome, Etc.) . .	359
□ Trailer Hitch Classification . . . . .	348	□ Towing – 2WD Models . . . . .	359
□ Trailer Towing Weights (Maximum Trailer Weight Ratings) . . . . .	348	□ Towing – 4WD Models . . . . .	360

## STARTING PROCEDURES

Before starting your vehicle, adjust your seat, adjust both inside and outside mirrors, and fasten your seat belts.

### WARNING!

**Do not leave children or animals inside parked vehicles in hot weather. Interior heat buildup may cause serious injury or death.**

### Manual Transmission

Apply the parking brake, place the shift lever in NEUTRAL and depress the clutch pedal before starting vehicle. This vehicle is equipped with a clutch interlocking ignition system. It will not start unless the clutch pedal is pressed to the floor.

### *4WD Models Only*

In 4L mode, this vehicle will start regardless of whether or not the clutch pedal is pressed to the floor. This feature enhances off-road performance by allowing the vehicle to start when in 4L without having to depress the clutch pedal. The 4WD Indicator Light will illuminate when the transfer case has been shifted into this mode.

### Automatic Transmission

Start the engine with the shift lever in the NEUTRAL or PARK position. Apply the brake before shifting to any driving range.

### Normal Starting

**NOTE:** Normal starting of either a cold or a warm engine is obtained without pumping or depressing the accelerator pedal.



Turn the ignition switch to the START position and release when the engine starts. If the engine fails to start within 10 seconds, turn the ignition switch to the LOCK position, wait 10 to 15 seconds, then repeat the normal starting procedure.

#### Tip Start Feature — Automatic Transmission Only

Turn the ignition switch to START position and release it as soon as the starter engages. The starter motor will continue to run, but will automatically disengage itself when the engine is running. If the engine fails to start, the starter will disengage automatically in 10 seconds. If this occurs, turn the ignition switch to the LOCK position, wait 10 to 15 seconds, then repeat the normal starting procedure.

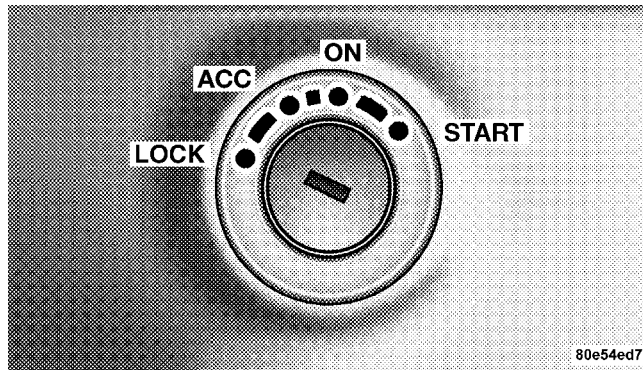

#### Ignition Key Positions

#### Extreme Cold Weather (below $-20^{\circ}\text{F}$ or $-29^{\circ}\text{C}$ )

To ensure reliable starting at these temperatures, use of an externally-powered electric engine block heater (available from your authorized dealer) is recommended.

## If Engine Fails to Start

### WARNING!

- Never pour fuel or other flammable liquids into the throttle body air inlet opening in an attempt to start the vehicle. This could result in a flash fire causing serious personal injury.
- Do not attempt to push or tow your vehicle to get it started. Vehicles equipped with an automatic transmission cannot be started this way. Unburned fuel could enter the catalytic converter and once the engine has started, ignite and damage the converter and vehicle. If the vehicle has a discharged battery, booster cables may be used to obtain a start from a booster battery or the battery in another vehicle. This type of start can be dangerous if done improperly. Refer to Section 6 of this manual for proper jump starting procedures and follow them carefully.

### *Without Tip Start (Manual Transmission Only)*

If the engine fails to start after you have followed the “Normal Starting” or “Extreme Cold Weather” procedures, it may be flooded. Push the accelerator pedal all the way to the floor and hold it there while cranking the engine. This should clear any excess fuel in case the engine is flooded.

### CAUTION!

To prevent damage to the starter, do not crank the engine for more than 15 seconds at a time. Wait 10 to 15 seconds before trying again.

If the engine has been flooded, it may start to run, but not have enough power to continue running when the key is released. If this occurs, continue cranking with the accelerator pedal pushed all the way to the floor. Release the accelerator pedal and the key once the engine is running smoothly.

If the engine shows no sign of starting after two 15 second periods of cranking with the accelerator pedal held to the floor, repeat the “Normal Starting” or “Extreme Cold Weather” procedures.

*With Tip Start (Automatic Transmission Only)*

If the engine fails to start after you have followed the “Normal Starting” or “Extreme Cold Weather” procedures, it may be flooded. To clear any excess fuel, push the accelerator pedal all the way to the floor and hold it. Then, turn the ignition switch to the START position and release it as soon as the starter engages. The starter motor will disengage automatically in 10 seconds. Once this occurs, release the accelerator pedal, turn the ignition switch to the LOCK position, wait 10 to 15 seconds, then repeat the normal starting procedure.

**CAUTION!**

**To prevent damage to the starter, wait 10 to 15 seconds before trying again.**

**After Starting**

The idle speed will automatically decrease as the engine warms up.

**WARNING!**

**Do not leave children or animals inside parked vehicles in hot weather. Interior heat buildup may cause serious injury or death.**

## ENGINE BLOCK HEATER — IF EQUIPPED

The engine block heater warms engine coolant and permits quicker starts in cold weather. Connect the cord to a standard 110-115 Volt AC electrical outlet with a grounded, three wire extension cord. The engine block heater cord is found under the hood bundled in front of the battery tray.

### WARNING!

**Remember to disconnect the cord before driving. Damage to the 110-115 Volt AC electrical cord could cause electrocution.**

Use the heater when temperatures below 0°F (-18°C) are expected to last for several days.

## MANUAL TRANSMISSION

### WARNING!

**You or others could be injured if you leave the vehicle unattended without having the parking brake fully applied. The parking brake should always be applied when the driver is not in the vehicle, especially on an incline.**

### CAUTION!

**Never drive with your foot resting on the clutch pedal, or attempt to hold the vehicle on a hill with the clutch pedal partially engaged, as this will cause abnormal wear on the clutch.**

**NOTE:** During cold weather, you may experience increased effort in shifting until the transmission fluid warms up. This is normal.

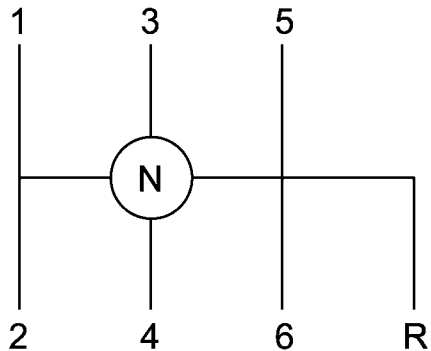

Shift Pattern

81cd6226

## Shifting

Fully depress the clutch pedal before shifting gears. As you release the clutch pedal, lightly depress the accelerator pedal.

You should always use 1st gear when starting from a standing position if under heavy load or when pulling a trailer.

## Recommended Vehicle Shift Speeds

To utilize your manual transmission efficiently for both fuel economy and performance, it should be upshifted as listed in recommended shift speed chart. Shift at the vehicle speeds listed for acceleration. When heavily loaded or pulling a trailer these recommended up-shift speeds may not apply.

Manual Transmission Shift Speeds in MPH (KM/H)						
En- gine	Speeds	1 to 2	2 to 3	3 to 4	4 to 5	5 to 6
3.8L	Accel.	15 (24)	24 (39)	34 (55)	47 (76)	56 (90)
	Cruise	10 (16)	19 (31)	27 (43)	37 (60)	41 (66)

### Downshifting

Moving from a high gear down to a lower gear is recommended to preserve brakes when driving down steep hills. In addition, downshifting at the right time provides better acceleration when you desire to resume speed. Downshift progressively. Do not skip gears to avoid overspeeding the engine and clutch.

### WARNING!

**Do not downshift for additional engine braking on a slippery surface. The drive wheels could lose their grip and the vehicle could skid.**

### CAUTION!

**When descending a hill, be very careful to downshift one gear at a time to prevent overspeeding the engine which can cause valve damage, and/or clutch disc damage even if the clutch pedal is depressed.**

## Maximum Recommended Downshift Speeds

### CAUTION!

Failure to follow the maximum recommended downshifting speeds may cause the engine to overspeed and/or damage the clutch disc even if the clutch pedal is depressed.

### Manual Transmission Downshift Speeds in MPH (KM/H)

Gear Selection	6 to 5	5 to 4	4 to 3	3 to 2	2 to 1
Maximum Speed	80 (129)	70 (113)	50 (81)	30 (48)	15 (24)

## Reverse Shifting

To shift into REVERSE, bring the vehicle to a complete stop. Depress the clutch and pause briefly to allow the gear train to stop rotating. Beginning from the NEUTRAL position, move the shift lever in one quick smooth motion straight across and into the REVERSE area (the driver will feel a firm “click” as the shifter passes the “knock-over”). Complete the shift by pulling the shift lever into REVERSE.

The “knock-over” prevents the driver from accidentally entering the REVERSE shift area and warns the driver that they are about to shift the transmission into REVERSE. Due to this feature, a slow shift to REVERSE can be perceived as a high shift effort.

## AUTOMATIC TRANSMISSION

### CAUTION!

Damage to the transmission may occur if the following precautions are not observed:

- Shift into PARK only after the vehicle has come to a complete stop.
- Shift into or out of REVERSE only after the vehicle has come to a complete stop and the engine is at idle speed.
- Do not shift from REVERSE, PARK, or NEUTRAL into any forward gear when the engine is above idle speed.
- Before shifting into any gear, make sure your foot is firmly on the brake pedal.

### WARNING!

It is dangerous to move the shift lever out of PARK or NEUTRAL if the engine speed is higher than idle speed. If your foot is not firmly on the brake pedal, the vehicle could accelerate quickly forward or in reverse. You could lose control of the vehicle and hit someone or something. Only shift into gear when the engine is idling normally and when your foot is firmly on the brake pedal.



### Shift Lock Manual Override

Your vehicle may be equipped with a shift lock manual override. The manual override may be used in the event that the shift lever should fail to move from PARK with the key in the ON position and the brake pedal depressed. To operate the shift lock manual override, perform the following steps:

1. Firmly set the parking brake.
2. Using a flat blade screwdriver, carefully remove the shift lock manual override cover which is located on the PRNDL bezel, above the PARK position.
3. Depress and maintain firm pressure on the brake pedal.
4. Using the screwdriver, reach into the manual override opening. Press and hold the shift lock lever down.

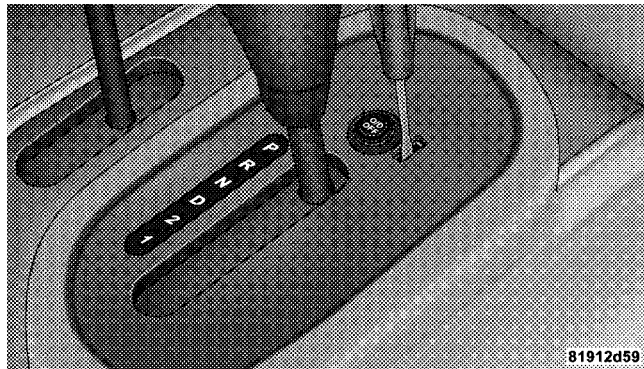

5. Depress the shifter release button and shift into NEUTRAL.
6. The vehicle may then be started in NEUTRAL.

Have your vehicle inspected by your local authorized dealer, if the shift lock manual override has been used.

### Brake/Transmission Interlock System

This system prevents you from moving the shift lever out of PARK and into any gear unless the brake pedal is pressed. This system is active only while the ignition switch is in the ON position. Always depress the **brake pedal first**, before moving the shift lever out of PARK.

### Automatic Transmission with Overdrive

Shifting from DRIVE to PARK or REVERSE (or from P or R to D) should be done only after the accelerator pedal is released and the vehicle is stopped. Be sure to keep your foot on the brake when moving the shift lever between these gears.



Automatic Shift Controls

### Gear Ranges

DO NOT race the engine when shifting from PARK or NEUTRAL position into another gear range.

### **PARK**

This gear position supplements the parking brake by locking the transmission. The engine can be started in this range. Never use PARK while the vehicle is in motion. Apply the parking brake when leaving the vehicle in this range. Always apply parking brake first, then place the shift lever in the PARK position.

#### **WARNING!**

**Never use the PARK position as a substitute for the parking brake. Always apply parking brake fully when parked to guard against vehicle movement and possible injury or damage.**

#### **WARNING!**

**It is dangerous to move the shift lever out of PARK or NEUTRAL if the engine speed is higher than idle speed. If your foot is not firmly on the brake pedal, the vehicle could accelerate quickly forward or in reverse. You could lose control of the vehicle and hit someone or something. Only shift into gear when the engine is idling normally and when your right foot is firmly on the brake pedal.**

### **REVERSE**

Use this range only after the vehicle has come to a complete stop.

### **NEUTRAL**

Shift into NEUTRAL when the vehicle is standing for prolonged periods with the engine running. The engine may be started in this range. Set the parking brake if you must leave the vehicle.



**NOTE:** Towing, coasting, or driving the vehicle for any other reason with the shift lever in NEUTRAL can result in severe transmission damage. Refer to “Recreational Towing” in Section 5 and “Towing a Disabled Vehicle” in Section 6 of this manual.

### OVERDRIVE

For most city and highway driving. The transmission contains an electronically-controlled 4th gear Overdrive, and will automatically shift from DRIVE to OVERDRIVE if the following conditions are present:

- The shift lever is in DRIVE.
- The O/D OFF switch has not been activated.
- Vehicle speed is above approximately 30 mph (48 km/h).

When frequent transmission shifting occurs while using Overdrive, such as when operating the vehicle under heavy load conditions (for example, in hilly terrain, strong head winds, or trailer towing), turning off overdrive will improve performance and extend transmission life by reducing excessive shifting and heat buildup.

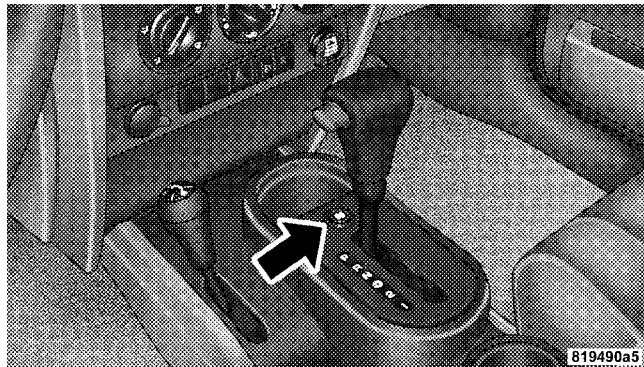

Overdrive Off Switch

Overdrive can be locked out by pressing the O/D OFF switch located on the center console. The O/D OFF indicator light (on the switch) will illuminate to show that the switch has been activated. When the indicator light is on, Overdrive is locked out. Pressing the switch a second time restores the Overdrive function. The lockout feature is useful when towing a trailer or carrying a heavy load.

### *2 (Second)*

For moderate grades and to assist braking on dry pavement or in mud and snow. Begins from a stop in low gear with automatic upshift to 2nd gear. Will not shift to 3rd.

### *1 (First)*

For hard pulling at low speeds in mud, sand, snow, or on steep grades. Begins and stays in low gear with no upshift. Provides engine compression braking at low speeds.

## CAUTION!

- **Before moving the shift lever out of PARK, you must turn the ignition from LOCK so the steering wheel and shift lever are released. Otherwise, damage to steering column or shift lever could result.**
- **Never race the engine with the brakes on and the vehicle in gear, and never hold the vehicle on an incline without applying the brakes. These practices can overheat and damage the transmission.**
- **When “rocking” a stuck vehicle by moving between DRIVE and REVERSE, do not spin the wheels faster than 15 mph (24 km/h), or drivetrain damage may result.**

## Torque Converter Clutch

A feature designed to improve fuel economy has been added to the automatic transmission of this vehicle. A clutch within the torque converter engages automatically at calibrated speeds. This may result in a slightly different feeling or response during normal operation in high gear. When the vehicle speed drops or during acceleration, the clutch automatically and smoothly disengages.

## FOUR-WHEEL DRIVE OPERATION (COMMAND-TRAC™ OR ROCK-TRAC™) — IF EQUIPPED

### Operating Instructions/Precautions

The transfer case provides four mode positions — 2H (Two-wheel drive high range), 4H (Four-wheel drive high range), N (Neutral), and 4L (Four-wheel drive low range).

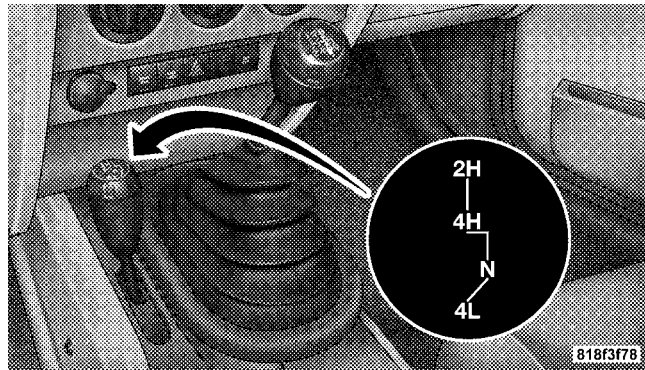

4WD Shift Controls

The transfer case is intended to be driven in the 2H position for normal street and highway conditions such as hard-surfaced roads.

In the event that additional traction is required, the transfer case 4H and 4L positions can be used to lock the front and rear driveshafts together, forcing the front and

rear wheels to rotate at the same speed. This is accomplished by simply moving the shift lever to one of these positions. The 4H and 4L positions are intended for loose, slippery road surfaces only, and not intended for normal driving. Driving in the 4H and 4L positions on hard surfaced roads will cause increased tire wear and damage to the driveline components.

The 4WD Indicator Light (located in the instrument cluster) alerts the driver that the vehicle is in four-wheel drive, and the front and rear driveshafts are locked together. The light will illuminate when the transfer case is shifted into the 4H position.

**NOTE:** Do not attempt to shift when only the front or rear wheels are spinning. The transfer case is not equipped with a synchronizer, and the front and rear driveshaft speeds must be equal for a shift to take place. Shifting while only the front or rear wheels are spinning can cause damage to the transfer case.

When operating your vehicle in 4L, the engine speed will be approximately three times (four times for Rubicon models) that of the 2H or 4H positions at a given road speed. Take care not to overspeed the engine.

Proper operation of four-wheel drive vehicles depends on tires of equal size, type, and circumference on each wheel. Any difference will adversely affect shifting and cause damage to the transfer case.

Because four-wheel drive provides improved traction, there is a tendency to exceed safe turning and stopping speeds. Do not go faster than road conditions permit.

**WARNING!**

You or others could be injured if you leave the vehicle unattended with the transfer case in the N (Neutral) position without first fully engaging the parking brake. The transfer case N (Neutral) position disengages both the front and rear driveshaft from the powertrain, and will allow the vehicle to move regardless of the transmission position. The parking brake should always be applied when the driver is not in the vehicle.

**Shift Positions**

For additional information on the appropriate use of each transfer case mode position, see the information below:

**2H Position**

This range is used for normal street and highway driving. Hard surfaced roads.

**4H Position**

This range locks the front and rear driveshafts together, forcing the front and rear wheels to rotate at the same speed. This range (4H) provides additional traction for loose, slippery road surfaces and should not be used on wet or dry pavement.

The 4WD Indicator Light (located in the instrument cluster) will illuminate when the transfer case is shifted into the 4H position.



### **N (Neutral) Position**

This range disengages the front and rear driveshafts from the powertrain. To be used for flat towing behind another vehicle. Refer to “Recreational Towing” in Section 5 of this manual.

### **4L Position**

This range locks the front and rear driveshafts together, forcing the front and rear wheels to rotate at the same speed. This range (4L) provides additional traction and maximum pulling power for loose, slippery road surfaces only. Do not exceed 25 mph (40 km/h).

The 4WD Indicator Light (located in the instrument cluster) will illuminate when the transfer case is shifted into the 4L position.

### **Shifting Procedure**

#### **2H to 4H or 4H to 2H**

Shifting between 2H and 4H can be made with the vehicle stopped or in motion. If the vehicle is in motion, shifts can be made up to 50 mph (80 km/h). With the vehicle in motion, the transfer case will engage/disengage faster if you momentarily release the accelerator pedal after completing the shift. Apply a constant force when shifting the transfer case lever.

### 4H to 4L or 4L to 4H

With the vehicle rolling at 2 to 3 mph (3 to 5 km/h), shift an automatic transmission into NEUTRAL (N), or depress the clutch pedal on a manual transmission. While the vehicle is coasting at 2 to 3 mph (3 to 5 km/h), shift the transfer case lever firmly to the desired position. Do not pause with the transfer case in N (Neutral).

**NOTE:** Shifting into or out of 4L is possible with the vehicle completely stopped, however, difficulty may occur due to the mating teeth not being properly aligned. Several attempts may be required for clutch teeth alignment and shift completion to occur. The preferred method is with the vehicle rolling at 2 to 3 mph (3 to 5 km/h). Avoid attempting to engage or disengage 4L with the vehicle moving faster than 2 to 3 mph (3 to 5 km/h).

### WARNING!

**Failure to engage a position completely can cause transfer case damage or loss of power and vehicle control. You could have an injury accident. Do not drive the vehicle unless the transfer case is fully engaged.**

5

### TRAC-LOK™ REAR AXLE — IF EQUIPPED

The Trac-Lok™ rear axle provides a constant driving force to both rear wheels and reduces wheel spin caused by the loss of traction at one driving wheel. If traction differs between the two rear wheels, the differential automatically proportions the usable torque by providing more torque to the wheel that has traction.

Trac-Lok™ is especially helpful during slippery driving conditions. With both rear wheels on a slippery surface, a slight application of the accelerator will supply maximum traction.

### WARNING!

On vehicles equipped with a limited-slip differential, never run the engine with one rear wheel off the ground. The vehicle may drive through the rear wheel remaining on the ground and cause you to lose control of your vehicle.

### AXLE LOCK (TRU-LOK™) — RUBICON MODELS

The AXLE LOCK switch is located on the lower switch bank (below the climate controls).

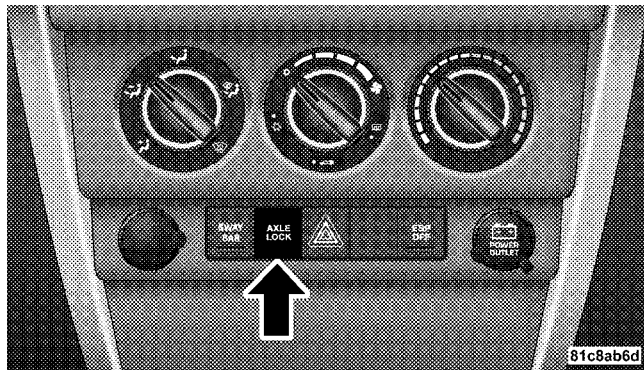

Axle Lock Switch

This feature will only activate when the following conditions are met:

- Key in ignition, vehicle in 4L (Low) range.

- Vehicle speed should be 10 mph (16 km/h) or less.

To activate the system, press the bottom of the AXLE LOCK switch once to lock the rear axle only (the Rear Axle Lock Indicator Light will illuminate), press the bottom of the switch again to lock the front axle (the Front Axle Lock Indicator Light will illuminate). When the rear axle is locked, pressing the switch again will lock or unlock the front axle.

**NOTE:** The indicator lights will flash until the axles are fully locked or unlocked.

To unlock the axles, press the top of the AXLE LOCK switch.

Axle lock will disengage if the vehicle is taken out of 4L (Low) range, or the ignition switch is turned to the OFF position.

## REAR AXLE LOCK — 4WD NON-RUBICON MODELS (IF EQUIPPED)

The REAR AXLE LOCK switch is located on the lower switch bank (below the climate controls).

This feature will only activate when the following conditions are met:

- Key in ignition, vehicle in 4L (Low) range.
- Vehicle speed should be 10 mph (16 km/h) or less.

To activate the system, press the REAR AXLE LOCK switch down to lock the rear axle (the Rear Axle Lock Indicator Light will illuminate), press the switch up to unlock the rear axle.

**NOTE:** The indicator lights will flash until the axle is fully locked or unlocked.

The rear axle lock will disengage if the vehicle is taken out of 4L (Low) range, or the ignition switch is turned to the OFF position.

### **ELECTRONIC SWAY BAR DISCONNECT — IF EQUIPPED**

Your vehicle may be equipped with an electronic disconnecting stabilizer/sway bar. This system allows greater front suspension travel in off-road situations.

This system is controlled by the electronic control SWAY BAR switch located on the lower switch bank (below the climate controls).

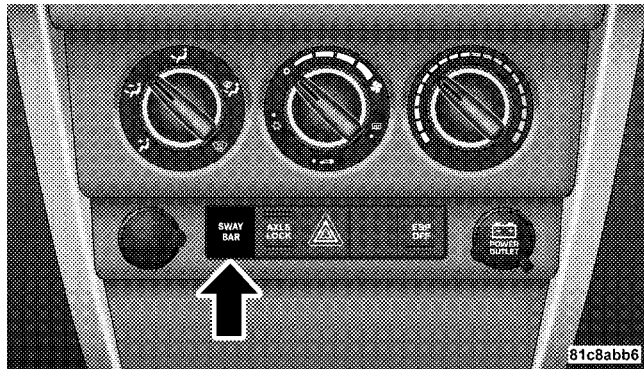

**Sway Bar Switch**

Press the SWAY BAR switch to activate the system. Press the switch again to deactivate the system. The Sway Bar Indicator Light (located in the instrument cluster) will illuminate when the bar is disconnected. The Sway Bar Indicator Light will flash during activation transition, or

when activation conditions are not met. The stabilizer/sway bar should remain in on-road mode during normal driving conditions.

### WARNING!

**Do not disconnect the stabilizer bar and drive on hard surfaced roads or at speeds above 18 mph (29 km/h), you may lose control of the vehicle, which could result in serious injury. The front stabilizer bar enhances vehicle stability and is necessary for maintaining control of the vehicle. The system monitors vehicle speed and will attempt to reconnect the stabilizer bar at speeds over 18 mph (29 km/h). This is indicated by a flashing or solid Sway Bar Indicator Light. Once vehicle speed is reduced below 14 mph (22 km/h), the system will once again attempt to return to off-road mode.**

To disconnect the stabilizer/sway bar, shift to either 4H or 4L (refer to “Four Wheel Drive Operation” in this section) and press the SWAY BAR switch to obtain the off-road position. The Sway Bar Indicator Light will flash until the stabilizer/sway bar has been fully disconnected.

**NOTE:** The stabilizer/sway bar may be torque locked due to left and right suspension height differences. This condition is due to driving surface differences or vehicle loading. In order for the stabilizer/sway bar to disconnect/reconnect, the right and left halves of the bar must be aligned. This alignment may require that the vehicle be driven onto level ground or rocked from side to side.

To return to on-road mode, press the SWAY BAR switch again.

**WARNING!**

If the stabilizer/sway bar will not return to on-road mode, vehicle stability is greatly reduced. Do not attempt to drive vehicle over 18 mph (29 km/h). Driving faster than 18 mph (29 km/h) may cause loss of control of the vehicle, which could result in serious injury. Contact your local authorized dealer for assistance.

**ON-ROAD DRIVING TIPS**

Utility vehicles have higher ground clearance and a narrower track to make them capable of performing in a wide variety of off-road applications. Specific design characteristics give them a higher center of gravity than ordinary cars.

An advantage of the higher ground clearance is a better view of the road, allowing you to anticipate problems. They are not designed for cornering at the same speeds as conventional two-wheel drive vehicles any more than low-slung sports cars are designed to perform satisfactorily in off-road conditions. If at all possible, avoid sharp turns or abrupt maneuvers. As with other vehicles of this type, failure to operate this vehicle correctly may result in loss of control or vehicle rollover.

**OFF-ROAD DRIVING TIPS****Side Step Removal — If Equipped**

**NOTE:** Prior to off-road usage, the side steps should be removed to prevent damage.

1. Remove two nuts from bodyside.

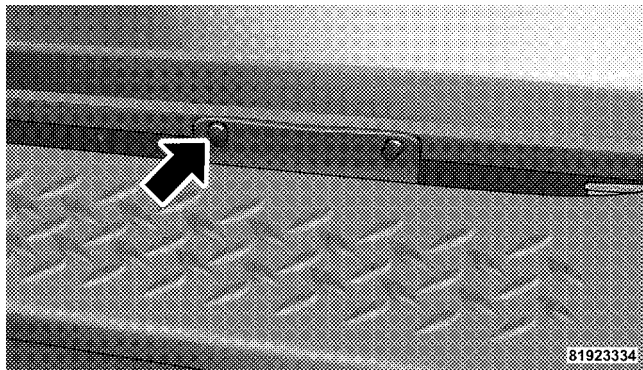

2. Remove one bolt from underside of vehicle.

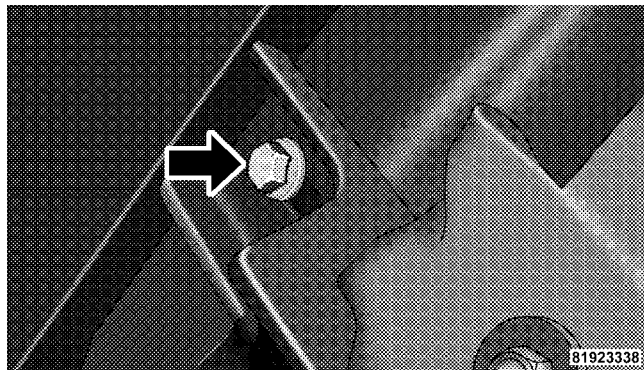

3. Remove side step assembly.



## The Basics of Off-Road Driving

You will encounter many types of terrain driving off-road. You should be familiar with the terrain and area before proceeding. There are many types of surface conditions: hard packed dirt, gravel, rocks, grass, sand, mud, snow and ice. Every surface has a different effect on your vehicle's steering, handling and traction. Controlling your vehicle is one of the keys to successful off-road driving, so always keep a firm grip on the steering wheel and maintain a good driving posture. Avoid sudden accelerations, turns or braking. In most cases there are no road signs, posted speed limits or signal lights. Therefore you will need to use your own good judgment on what is safe and what isn't. When on a trail you should always be looking ahead for surface obstacles and changes in terrain. The key is to plan your future driving route while remembering what you are currently driving over.

### CAUTION!

**Never park your vehicle over dry grass or other combustible materials. The heat from your vehicle exhaust system could cause a fire.**

### WARNING!

**Always wear your seat belt and firmly tie down cargo. Unsecured cargo can become projectiles in an off-road situation.**

## When To Use 4L (Low) Range

When off-road driving, shift into 4L (Low) for additional traction and control on slippery or difficult terrain, ascending or descending steep hills, and to increase low speed pulling power. This range should be limited to extreme situations such as deep snow, mud, steep inclines, or sand where additional low speed pulling power is needed. Vehicle speeds in excess of 25 mph (40 km/h) should be avoided when in 4L (Low) range.

## Simultaneous Brake And Throttle Operation

Many off-road driving conditions require the simultaneous use of the brake and throttle (two-footed driving). When climbing rocks, logs, or other stepped objects, using light brake pressure with light throttle will keep the vehicle from jerking or lurching. This technique is also used when you need to stop and restart a vehicle on a steep incline.

## Driving In Snow, Mud and Sand

### Snow

In heavy snow or for additional control and traction at slower speeds, shift the transmission into a low gear and the transfer case into 4L (Low) if necessary. Don't shift to a lower gear than necessary to maintain headway. Over-revving the engine can spin the wheels and traction will be lost. If you start to slow to a stop, try turning your steering wheel no more than a 1/4 turn quickly back and forth, while still applying throttle. This will allow the tires to get a fresh "bite" and help maintain your momentum.

5

### CAUTION!

**On icy or slippery roads, do not downshift at high engine RPM or vehicle speeds, because engine braking may cause skidding and loss of control.**

## Mud

Deep mud creates a great deal of suction around the tires and is very difficult to get through. You should use 2nd gear (manual transmission), or DRIVE (automatic transmission), with the transfer case in the 4L (Low) position to maintain your momentum. If you start to slow to a stop, try turning your steering wheel no more than a 1/4 turn quickly back and forth for additional traction. Mud holes pose an increased threat of vehicle damage and getting stuck. They are normally full of debris from previous vehicles getting stuck. As a good practice before entering any mud hole, get out and determine how deep it is, if there are any hidden obstacles and if the vehicle can be safely recovered if stuck.

## Sand

Soft sand is very difficult to travel through with full tire pressure. When crossing soft sandy spots in a trail maintain your vehicle's momentum and do not stop. The key to driving in soft sand is using the appropriate tire

pressure, accelerating slowly, avoiding abrupt maneuvers and maintaining the vehicle's momentum. If you are going to be driving on large soft sandy areas or dunes, reduce your tire pressure to a minimum of 15 psi (103 kPa) to allow for a greater tire surface area. Reduced tire pressure will drastically improve your traction and handling, while driving on the soft sand, but you must return the tires to normal air pressure before driving on pavement or other hard surfaces. Be sure you have a way to reinflate the tires prior to reducing the pressure.

### CAUTION!

**Reduced tire pressures may cause tire unseating and total loss of air pressure. To reduce the risk of tire unseating, while at a reduced tire pressure, reduce your speed and avoid sharp turns or abrupt maneuvers.**

## Crossing Obstacles (Rocks And Other High Points)

While driving off-road, you will encounter many types of terrain. These varying types of terrain bring different types of obstacles. Before proceeding, review the path ahead to determine the correct approach and your ability to safely recover the vehicle if something goes wrong. Keeping a firm grip on the steering wheel, bring the vehicle to a complete stop and then inch the vehicle forward until it makes contact with the object. Apply the throttle lightly while holding a light brake pressure and ease the vehicle up and over the object.

### WARNING!

**Crossing obstacles can cause abrupt steering system loading which could cause you to lose control of your vehicle.**

## Using A Spotter

There are many times where it is hard to see the obstacle or determine the correct path. Determining the correct path can be extremely difficult when you are confronting many obstacles. In these cases have someone guide you over, through, or around the obstacle. Have the person stand a safe distance in front of you where they can see the obstacle, watch your tires and undercarriage, and guide you through.

## Crossing Large Rocks

When approaching large rocks, choose a path which ensures you drive over the largest of them with your tires. This will lift your undercarriage over the obstacle. The tread of the tire is tougher and thicker than the side wall and is designed to take the abuse. Always look ahead and make every effort to cross the large rocks with your tires.

**CAUTION!**

Never attempt to straddle a rock that is large enough to strike your axles or undercarriage.

**CAUTION!**

Never attempt to drive over a rock which is large enough to contact the door sills.

**Crossing A Ravine, Gully, Ditch, Washout Or Rut**

When crossing a ravine, gully, ditch, washout or a large rut, the angled approach is the key to maintaining your vehicle's mobility. Approach these obstacles at a 45-degree angle and let each tire go through the obstacle independently. You need to use caution when crossing large obstacles with steep sides. Do not attempt to cross

any large obstacle with steep sides at an angle great enough to put the vehicle at risk of a rollover. If you get caught in a rut, dig a small trench to the right or left at a 45-degree angle ahead of the front tires. Use the removed dirt to fill the rut ahead of the turnout you just created. You should now be able to drive out following the trench you just created at a 45-degree angle.

**WARNING!**

There is an increased risk of rollover when crossing an obstacle, at any angle, with steep sides.

**Crossing Logs**

To cross a log, approach it at a slight angle (approximately 10 to 15 degrees). This allows one front tire to be on top of the log while the other just starts to climb the log. While climbing the log, modulate your brake and

accelerator to avoid spinning the log out from under your tires. Then ease the vehicle off the log using your brakes.

### CAUTION!

**Do not attempted to cross a log with a greater diameter than the running ground clearance or the vehicle will become high centered.**

### Getting High-Centered

If you get hung up or high-centered on an object, get out of the vehicle and try to determine what the vehicle is hung up on, where it is contacting the underbody and what is the best direction to recover the vehicle. Depending on what you are in contact with, jack the vehicle up and place a few rocks under the tires so the weight is off of the high point when you let the vehicle down. You can also try rocking the vehicle or winching the vehicle off the object.

### CAUTION!

**Winching or rocking the vehicle off hard objects increases the risk of underbody damage.**

### Hill Climbing

Hill climbing requires good judgment and a good understanding of your abilities and your vehicle's limitations. Hills can cause serious problems. Some are just too steep to climb and should not be attempted. You should always feel confident with the vehicle and your abilities. You should always climb hills straight up and down. Never attempt to climb a hill on an angle.

### Before Climbing A Steep Hill

As you approach a hill consider its grade or steepness. Determine if it is too steep. Look to see what the traction is on the hill side trail. Is the trail straight up and down? What is on top and the other side? Are there ruts, rocks,

branches or other obstacles on the path? Can you safely recover the vehicle if something goes wrong? If everything looks good and you feel confident, shift the transmission into a lower gear with 4L (Low) engaged, and proceed with caution maintaining your momentum as you climb the hill.

### Driving Up Hill

Once you have determined your ability to proceed and have shifted into the appropriate gear, line your vehicle up for the straightest possible run. Accelerate with an easy constant throttle and apply more power as you start up the hill. Do not race forward into a steep grade, the abrupt change of grade could cause you to lose control. If the front end begins to bounce, ease off the throttle slightly to bring all four tires back on the ground. As you approach the crest of the hill, ease off the throttle and slowly proceed over the top. If the wheels start to slip as you approach the crest of a hill, ease off the accelerator and maintain headway by turning the steering wheel no

more than a 1/4 turn quickly back and forth. This will provide a fresh "bite" into the surface and will usually provide enough traction to complete the climb. If you do not make it to the top, place the vehicle in REVERSE and back straight down the grade using engine resistance along with the vehicle brakes.

### WARNING!

**Never attempt to climb a hill at an angle or turn around on a steep grade. Driving across an incline increases the risk of a rollover, which may result in severe injury.**

### Driving Down Hill

Before driving down a steep hill you need to determine if it is too steep for a safe descent. What is the surface traction? Is the grade too steep to maintain a slow controlled descent? Are there obstacles? Is it a straight

descent? Is there plenty of distance at the base of the hill to regain control if the vehicle descends too fast? If you feel confident in your ability to proceed then make sure you are in 4L (Low) and proceed with caution. Allow engine braking to control the descent and apply your brakes if necessary, but do not allow the tires to lock.

### WARNING!

**Do not descend a steep grade in NEUTRAL. Use vehicle brakes in conjunction with engine braking. Descending a grade too fast could cause you to lose control and be seriously injured.**

### Driving Across An Incline

If at all possible avoid driving across an incline. If it is necessary, know your vehicle's abilities. Driving across an incline places more weight on the downhill wheels, which increases the possibilities of a downhill slide or

rollover. Make sure the surface has good traction with firm and stable soils. If possible transverse the incline at an angle heading slightly up or down.

### WARNING!

**Driving across an incline increases the risk of a rollover, which may result in severe injury.**

5

### If You Stall Or Begin To Lose Headway

If you stall or begin to lose headway while climbing a steep hill, allow your vehicle to come to a stop and immediately apply the brake. Restart the engine and shift into REVERSE. Back slowly down the hill allowing engine braking to control the descent and apply your brakes if necessary, but do not allow the tires to lock.



**WARNING!**

**If the engine stalls or you lose headway or cannot make it to the top of a steep hill or grade, never attempt to turn around. To do so may result in tipping and rolling the vehicle, which may result in severe injury. Always back carefully straight down a hill in REVERSE gear. Never back down a hill in NEUTRAL using only the vehicle brakes. Never drive diagonally across a hill, always drive straight up or down.**

**Driving Through Water**

Extreme care should be taken crossing any type of water. Water crossings should be avoided if possible, and only be attempted when necessary in a safe responsible manner. You should only drive through areas which are designated and approved. You should tread lightly and

avoid damage to the environment. You should know your vehicles abilities and be able to recover it if something goes wrong. You should never stop or shut a vehicle off when crossing deep water unless you ingested water into the engine air intake. If the engine stalls, do not attempt to restart it. Determine if it has ingested water first. The key to any crossing is low and slow. Shift into 1st gear (manual transmission), or DRIVE (automatic transmission), with the transfer case in the 4L (Low) position and proceed very slowly with a constant slow speed {3 to 5 mph (5 to 8 km/h) maximum} and light throttle. Keep the vehicle moving; do not try to accelerate through the crossing. After crossing any water higher than the bottom of the axle differentials, you should inspect all of the vehicle fluids for signs of water ingestion.

**CAUTION!**

**Water ingestion into the axles, transmission, transfer case, engine or vehicle interior can occur if you drive too fast or through too deep of water. Water can cause permanent damage to engine, driveline or other vehicle components and your brakes will be less effective once wet and/or muddy.**

**Before You Cross Any Type Of Water**

As you approach any type of water you need to determine if you can cross it safely and responsibly. If necessary, get out and walk through the water or probe it with a stick. You need to be sure of its depth, approach angle, current and bottom condition. Be careful of murky or muddy waters, check for hidden obstacles. Make sure you will not be intruding on any wildlife and you can recover the vehicle if necessary. The key to a safe crossing

is the water depth, current and bottom conditions. On soft bottoms the vehicle will sink in, effectively increasing the water level on the vehicle. Be sure to consider this when determining the depth and the ability to safely cross

**Crossing Puddles, Pools, Flooded Areas Or Other Standing Water**

Puddles, pools, flooded or other standing water areas normally contain murky or muddy waters. These water types normally contain hidden obstacles and make it difficult to determine an accurate water depth, approach angle, and bottom condition. Murky or muddy water holes are where you want to hook up tow straps prior to entering. This makes for a faster, cleaner and easier vehicle recovery. If you are able to determine you can safely cross, than proceed using the low and slow method.

**CAUTION!**

**Muddy waters can reduce the cooling system effectiveness by depositing debris onto the radiator.**

**Crossing Ditches, Streams, Shallow Rivers Or Other Flowing Water**

Flowing water can be extremely dangerous. Never attempt to cross a fast running stream or river even in shallow water. Fast moving water can easily push your vehicle downstream sweeping it out of control. Even in very shallow water, a high current can still wash the dirt out from around your tires putting you and your vehicle in jeopardy. There is still a high risk of personal injury and vehicle damage with slower water currents in depths greater than the vehicle's running ground clearance. You should never attempt to cross flowing water which is deeper than the vehicle's running ground clearance. Even

the slowest current can push the heaviest vehicle downstream out of control if the water is deep enough to push on the large surface area of the vehicle's body. Before you proceed determine the speed of the current, the water's depth, approach angle, bottom condition and if there are any obstacles, then cross at an angle heading slightly upstream using the low and slow technique.

**WARNING!**

**Never drive through fast moving deep water. It can push your vehicle downstream, sweeping it out of control. This could put you and your passengers at risk of injury or drowning.**

## After Driving Off-Road

Off-road operation puts more stress on your vehicle than does most on-road driving. After going off-road it is always a good idea to check for damage. That way you can get any problems taken care of right away and have your vehicle ready when you need it.

- Completely inspect the underbody of your vehicle. Check tires, body structure, steering, suspension, and exhaust system for damage.
- Check threaded fasteners for looseness, particularly on the chassis, drivetrain components, steering, and suspension. Retighten them, if required, and torque to the values specified in the Service Manual.
- Check for accumulations of plants or brush. These things could be a fire hazard. They might hide damage to fuel lines, brake hoses, axle pinion seals, and propeller shafts.

- After extended operation in mud, sand, water, or similar dirty conditions, have the radiator, brake rotors, wheels, brake linings, and axle yokes inspected and cleaned as soon as possible.

### WARNING!

**Abrasive material in any part of the brakes may cause excessive wear or unpredictable braking. You might not have full braking power when you need it to prevent an accident. If you have been operating your vehicle in dirty conditions, get your brakes checked and cleaned as necessary.**

- If you experience unusual vibration after driving in mud, slush or similar conditions, check the wheels for impacted material. Impacted material can cause a wheel imbalance and freeing the wheels of it will correct the situation.

## PARKING BRAKE

To set the parking brake, pull the lever up as firmly as possible. When the parking brake is applied with the ignition ON, the Brake Warning Light in the instrument cluster will light. To release the parking brake, pull up slightly, press the center button, then lower the lever completely.

**NOTE:** The instrument cluster Brake Warning Light indicates only that the parking brake is applied. You must be sure the parking brake is fully applied before leaving the vehicle.

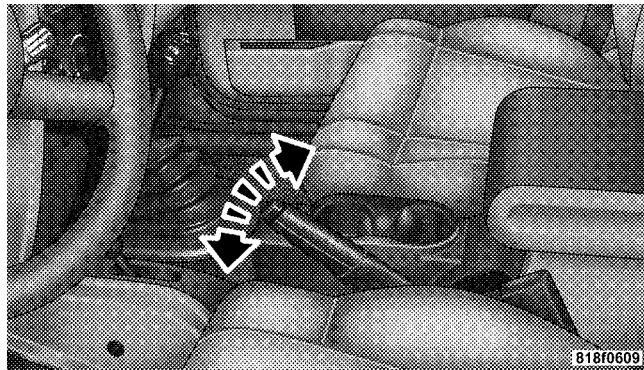

### Parking Brake

Be sure the parking brake is firmly set when parked, and the shift lever is in the PARK position (automatic transmission), or REVERSE, or 1st gear (manual transmission). When parking on a hill, you should apply the parking brake before placing the shift lever in PARK, otherwise

the load on the transmission locking mechanism may make it difficult to move the shifter out of PARK.

### WARNING!

- **Always fully apply the parking brake when leaving your vehicle, or it may roll and cause damage or injury. Also, be certain to leave an automatic transmission in PARK, a manual transmission in REVERSE or 1st gear. Failure to do so may allow the vehicle to roll and cause damage or injury.**
- **Never leave children alone in a vehicle. Leaving unattended children in a vehicle is dangerous for a number of reasons. A child or others could be seriously or fatally injured. Do not leave the key in the ignition. A child could operate power windows, other controls, or move the vehicle.**

When parking on a hill, turn the front wheels toward the curb on a downhill grade and away from the curb on an uphill grade.

The parking brake should always be applied whenever the driver is not in the vehicle.

### ANTI-LOCK BRAKE SYSTEM

The Anti-Lock Brake System (ABS) is designed to aid the driver in maintaining vehicle control under adverse braking conditions. The system operates with a separate computer to modulate hydraulic pressure to prevent wheel lock-up and help avoid skidding on slippery surfaces.

All vehicle wheels and tires must be the same size and type and tires must be properly inflated to produce accurate signals for the computer.

**WARNING!**

**Significant over or under-inflation of tires, or mixing sizes of tires or wheels on the vehicle can lead to loss of braking effectiveness.**

The Anti-Lock Brake System conducts a low speed self-test at about 12 mph (20 km/h). If for any reason, your foot is on the brake when the vehicle reaches 12 mph (20 km/h), this check will be delayed until 25 mph (40 km/h).

The Anti-Lock Brake System pump motor runs during the self-test, and during an ABS stop, to provide the regulated hydraulic pressure. The motor pump makes a low humming noise during operation, this is normal.

During off-road use, loss of traction can temporarily defeat the system and cause the warning light to illuminate. Turn the ignition OFF and ON again to restore Anti-Lock Brake System function.

**WARNING!**

**Pumping of the Anti-Lock Brakes will diminish their effectiveness and may lead to an accident. Pumping makes the stopping distance longer. Just press firmly on your brake pedal when you need to slow down or stop.**

**WARNING!**

- Anti-Lock Brake Systems (ABS) cannot prevent the natural laws of physics from acting on the vehicle, nor can it increase braking or steering efficiency beyond that afforded by the condition of the vehicle brakes and tires or the traction afforded.
- The ABS cannot prevent accidents, including those resulting from excessive speed in turns, following another vehicle too closely, or hydroplaning. Only a safe, attentive, and skillful driver can prevent accidents.
- The capabilities of an ABS-equipped vehicle must never be exploited in a reckless or dangerous manner which could jeopardize the user's safety or the safety of others.

**CAUTION!**

The Anti-Lock Brake System is subject to possible detrimental effects of electronic interference caused by improperly installed aftermarket radios or telephones.

**NOTE:** During severe braking conditions, a pulsing sensation may occur and a clicking noise will be heard. This is normal, indicating that the Anti-Lock Brake System is functioning.

**POWER STEERING**

The standard power steering system will give you good vehicle response and increased ease of maneuverability in tight spaces. The system will provide mechanical steering capability if power assist is lost.

**5**



If for some reason the power assist is interrupted, it will still be possible to steer your vehicle. Under these conditions, you will observe a substantial increase in steering effort, especially at very low vehicle speeds and during parking maneuvers.

**NOTE:** Increased noise levels at the end of the steering wheel travel are considered normal and do not indicate that there is a problem with the power steering system.

Upon initial start-up in cold weather, the power steering pump may make noise for a short amount of time. This is due to the cold, thick fluid in the steering system. This noise should be considered normal, and it does not in any way damage the steering system.

**WARNING!**

**Continued operation with reduced power steering assist could pose a safety risk to yourself and others. Service should be obtained as soon as possible.**

**CAUTION!**

**Prolonged operation of the steering system at the end of the steering wheel travel will increase the steering fluid temperature and it should be avoided when possible. Damage to the power steering pump may occur.**

## TIRE SAFETY INFORMATION

### Tire Markings

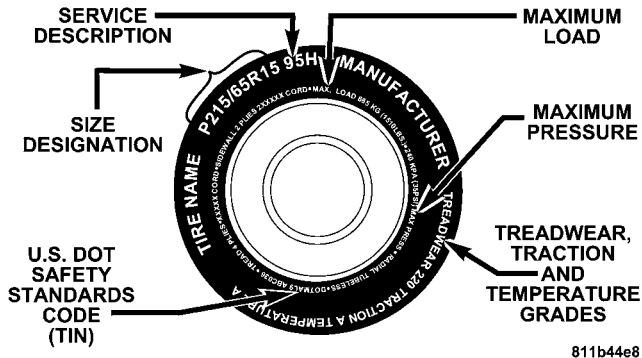

### NOTE:

- P(Passenger)-Metric tire sizing is based on U.S. design standards. P-Metric tires have the letter "P" molded into the sidewall preceding the size designation. Example: P215/65R15 95H.

- European Metric tire sizing is based on European design standards. Tires designed to this standard have the tire size molded into the sidewall beginning with the section width. The letter "P" is absent from this tire size designation. Example: 215/65R15 96H
- LT(Light Truck)-Metric tire sizing is based on U.S. design standards. The size designation for LT-Metric tires is the same as for P-Metric tires except for the letters "LT" that are molded into the sidewall preceding the size designation. Example: LT235/85R16.
- Temporary Spare tires are high pressure compact spares designed for temporary emergency use only. Tires designed to this standard have the letter "T" molded into the sidewall preceding the size designation. Example: T145/80D18 103M.
- High Flotation tire sizing is based on U.S. design standards and begins with the tire diameter molded into the sidewall. Example: 31x10.5 R15 LT.

## Tire Sizing Chart

### EXAMPLE:

#### Size Designation:

- P** = Passenger car tire size based on U.S. design standards
- "...**blank**..." = Passenger car tire based on European design standards
- LT** = Light Truck tire based on U.S. design standards
- T** = Temporary Spare tire
- 31** = Overall Diameter in Inches (in)
- 215** = Section Width in Millimeters (mm)
- 65** = Aspect Ratio in Percent (%)
  - Ratio of section height to section width of tire
- 10.5** = Section Width in Inches (in)
- R** = Construction Code
  - "R" means Radial Construction
  - "D" means Diagonal or Bias Construction
- 15** = Rim Diameter in Inches (in)

**EXAMPLE:****Service Description:**

**95** = Load Index

—A numerical code associated with the maximum load a tire can carry

**H** = Speed Symbol

—A symbol indicating the range of speeds at which a tire can carry a load corresponding to its load index under certain operating conditions

—The maximum speed corresponding to the Speed Symbol should only be achieved under specified operating conditions (ie., tire pressure, vehicle loading, road conditions and posted speed limits)

**Load Identification:**

"...blank..." = Absence of any text on sidewall of the tire indicates a Standard Load (SL) Tire

**Extra Load (XL)** = Extra Load (or Reinforced) Tire

**Light Load** = Light Load Tire

**C,D,E** = Load range associated with the maximum load a tire can carry at a specified pressure

**Maximum Load** — Maximum Load indicates the maximum load this tire is designed to carry

**Maximum Pressure** — Maximum Pressure indicates the maximum permissible cold tire inflation pressure for this tire.

### Tire Identification Number (TIN)

The TIN may be found on one or both sides of the tire however the date code may only be on one side. Tires with white sidewalls will have the full TIN including date code

located on the white sidewall side of the tire. Look for the TIN on the outboard side of black sidewall tires as mounted on the vehicle. If the TIN is not found on the outboard side then you will find it on the inboard side of the tire.

#### EXAMPLE:

**DOT MA L9 ABCD 0301**

**DOT** = Department of Transportation

—This symbol certifies that the tire is in compliance with the U.S. Department of Transportation tire safety standards, and is approved for highway use.

**MA** = Code representing the tire manufacturing location (2 digits)

**L9** = Code representing the tire size (2 digits)

**ABCD** = Code used by tire manufacturer (1 to 4 digits)

**03** = Number representing the week in which the tire was manufactured (2 digits)

—03 means the 3rd week

**01** = Number representing the year in which the tire was manufactured (2 digits)

—01 means the year 2001

—Prior to July 2000, tire manufacturers were only required to have 1 number to represent the year in which the tire was manufactured. Example: 031 could represent the 3rd week of 1981 or 1991.

## Tire Loading and Tire Pressure

### Tire Placard Location

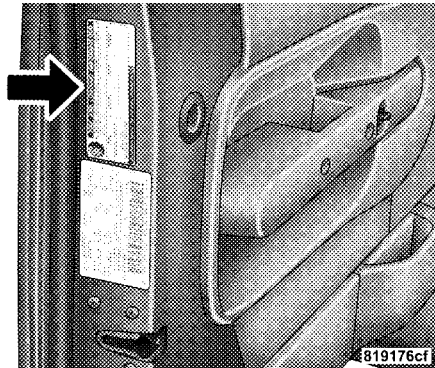

Tire Placard Location (Two-Door Models)

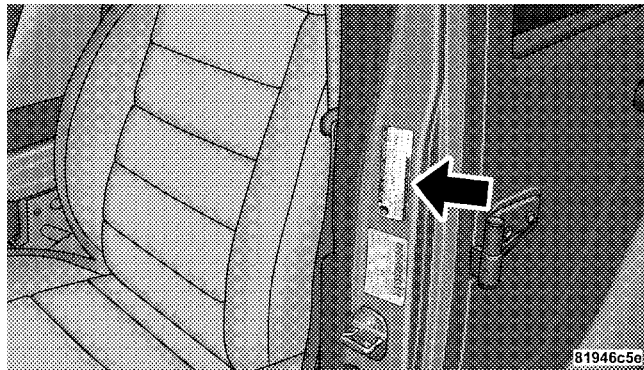

Tire Placard Location (Four-Door Models)

## Tire and Loading Information Placard

TIRE AND LOADING INFORMATION			
SEATING CAPACITY - TOTAL 5 FRONT 2 REAR 3			
THE COMBINED WEIGHT OF OCCUPANTS AND CARGO SHOULD NEVER EXCEED XXX KG OR XXX LBS.			
TIRE	FRONT	REAR	SPARE
ORIGINAL TIRE SIZE	P195/70R14	P195/70R14	T125/70D15
COLD TIRE INFLATION PRESSURE	200kPa, 29PSI	200kPa, 29PSI	420kPa, 60PSI
SEE OWNER'S MANUAL FOR ADDITIONAL INFORMATION			4N109268

### Tire And Loading Information Placard

811b5a9a

This placard tells you important information about the

- 1) number of people that can be carried in the vehicle
- 2) total weight your vehicle can carry
- 3) tire size designed for your vehicle

4) cold tire inflation pressures for the front, rear and spare tires.

### Loading

The vehicle maximum load on the tire must not exceed the load carrying capacity of the tire on your vehicle. You will not exceed the tire's load carrying capacity if you adhere to the loading conditions, tire size and cold tire inflation pressures specified on the Tire and Loading Information placard and the Vehicle Loading section of this manual. Refer to "Vehicle Loading" in this section.

**NOTE:** Under a maximum loaded vehicle condition, gross axle weight ratings (GAWRs) for the front and rear axles must not be exceeded. For further information on GAWRs, vehicle loading and trailer towing. Refer to "Vehicle Loading" in this section.

To determine the maximum loading conditions of your vehicle, locate the statement "The combined weight of occupants and cargo should never exceed XXX kg or XXX

lbs.” on the Tire and Loading Information placard. The combined weight of occupants, cargo/luggage and trailer tongue weight (if applicable) should never exceed the weight referenced here.

### *Steps for Determining Correct Load Limit*

1. Locate the statement “The combined weight of occupants and cargo should never exceed XXX pounds” on your vehicle’s placard.
2. Determine the combined weight of the driver and passengers that will be riding in your vehicle.
3. Subtract the combined weight of the driver and passengers from XXX kilograms or XXX pounds.
4. The resulting figure equals the available amount of cargo and luggage load capacity. For example, if “XXX” amount equals 1,400 lbs (635 kg) and there will be five 150 lbs (68 kg) passengers in your vehicle, the amount of available cargo and luggage load capacity is 650 lbs (295 kg) (since  $5 \times 150 = 750$ , and  $1400 - 750 = 650$  lbs (295 kg)).

5. Determine the combined weight of luggage and cargo being loaded on the vehicle. That weight may not safely exceed the available cargo and luggage load capacity calculated in step 4.

6. If your vehicle will be towing a trailer, the load from your trailer will be transferred to your vehicle. Consult this manual to determine how this reduces the available cargo and luggage load capacity of your vehicle.

**NOTE:** The following table shows examples on how to calculate total load, cargo/luggage and towing capacities of your vehicle with varying seating configurations and number and size of occupants. This table is for illustration purposes only and may not be accurate for the seating and load carry capacity of your vehicle.

**NOTE:** For the following example the combined weight of occupants and cargo should never exceed 865 lbs (392 kg).



Occupants			Combined weight of occupants and cargo from Tire Placard	MINUS	Combined Occupant's weight	=	AVAILABLE Cargo/Luggage and Trailer Tongue Weight
TOTAL	FRONT	REAR					
<b>EXAMPLE 1</b>			865 lbs	minus	670 lbs	=	195 lbs
5	2	3					
<b>EXAMPLE 2</b>			865 lbs	minus	540 lbs	=	325 lbs
3	2	1					
<b>EXAMPLE 3</b>			865 lbs	minus	400 lbs	=	465 lbs
2	2	0					

811a4d11

**WARNING!**

Overloading of your tires is dangerous. Overloading can cause tire failure, affect vehicle handling, and increase your stopping distance. Use tires of the recommended load capacity for your vehicle. Never overload them.

**TIRES — GENERAL INFORMATION****Tire Pressure**

Proper tire inflation pressure is essential to the safe and satisfactory operation of your vehicle. Three primary areas are affected by improper tire pressure:

**Safety****WARNING!**

Improperly inflated tires are dangerous and can cause accidents.

- Under-inflation increases tire flexing and can result in tire failure.
- Over-inflation reduces a tire's ability to cushion shock. Objects on the road and chuck holes can cause damage that results in tire failure.
- Unequal tire pressures can cause steering problems. You could lose control of your vehicle.
- Over-inflated or under-inflated tires can affect vehicle handling and can fail suddenly, resulting in loss of vehicle control.
- Unequal tire pressures from one side of the vehicle to the other can cause the vehicle to drift to the right or left. Always drive with each tire properly inflated.

### Economy

Improper inflation pressures can cause uneven wear patterns to develop across the tire tread. These abnormal wear patterns will reduce tread life resulting in a need for earlier tire replacement. Under-inflation also increases tire rolling resistance and results in higher fuel consumption.

### Ride Comfort and Vehicle Stability

Proper tire inflation contributes to a comfortable ride. Over-inflation produces a jarring and uncomfortable ride.

### Tire Inflation Pressures

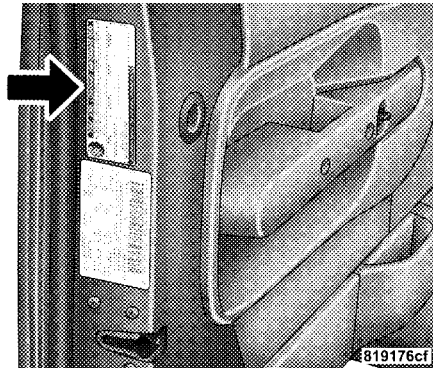

Tire Placard Location (Two-Door Models)

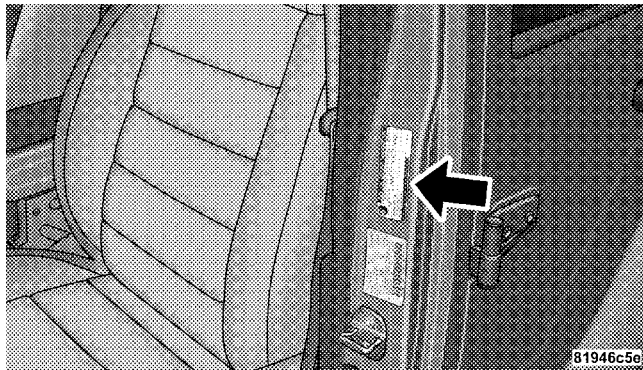

#### Tire Placard Location (Four-Door Models)

Tire pressure should be checked and adjusted as well as inspecting for signs of tire wear or visible damage, at least once a month. Use a good quality pocket-type gauge to check tire pressure. Do not make a visual judgement when determining proper inflation. Radial tires may look properly inflated even when they are under inflated.

### CAUTION!

After inspecting or adjusting the tire pressure always reinstall the valve stem cap. This will prevent moisture and dirt from entering the valve stem, which could damage the Tire Pressure Monitoring Sensor.

Inflation pressures specified on the placard are always “cold tire inflation pressure.” Cold tire inflation pressure is defined as the tire pressure after the vehicle has not been driven for at least three hours, or driven less than 1 mi (1 km) after a three hour period. The cold tire inflation pressure must not exceed the maximum inflation pressure molded into the tire side wall.

Check tire pressures more often if subject to a wide range of outdoor temperatures, as tire pressures vary with temperature changes.

5

Tire pressures change by approximately 1 psi (7 kPa) per 12° F (7° C) of air temperature change. Keep this in mind when checking tire pressure inside a garage especially in the winter.

Example: If garage temperature = 68° F (20° C) and the outside temperature = 32° F (0° C) then the cold tire inflation pressure should be increased by 3 psi (21 kPa), which equals 1 psi (7 kPa) for every 12° F (7° C) for this outside temperature condition.

Tire pressure may increase from 2 to 6 psi (13 to 40 kPa) during operation. DO NOT reduce this normal pressure buildup or your tire pressure will be too low.

### **Tire Pressures for High-Speed Operation**

The manufacturer advocates driving at safe speeds within posted speed limits. Where speed limits or conditions are such that the vehicle can be driven at high speeds, maintaining correct tire inflation pressure is very important. Increased tire pressure and reduced vehicle

loading may be required for high-speed vehicle operation. Refer to original equipment or an authorized tire dealer for recommended safe operating speeds, loading and cold tire inflation pressures.

### **WARNING!**

**High speed driving with your vehicle under load is dangerous. The added strain on your tires could cause them to fail. You could have a serious accident. Do not drive a vehicle loaded to maximum capacity at continuous speeds above 75 mph (120 km/h).**

## Radial-Ply Tires

### WARNING!

Combining radial ply tires with other types of tires on your vehicle will cause your vehicle to handle poorly. The instability could cause an accident. Always use radial tires in sets of four. Never combine them with other types of tires.

Cuts and punctures in radial tires are repairable only in the tread area because of sidewall flexing. Consult your authorized dealer for radial tire repairs.

## Tire Spinning

When stuck in mud, sand, snow, or ice conditions, do not spin your vehicle's wheels above 35 mph (55 km/h).

### WARNING!

Fast spinning tires can be dangerous. Forces generated by excessive wheel speeds may cause tire damage or failure. A tire could explode and injure someone. Do not spin your vehicle's wheels faster than 35 mph (55 km/h) when you are stuck, and do not let anyone near a spinning wheel no matter what the speed.

## Tread Wear Indicators

Tread wear indicators are in the original equipment tires to help you in determining when your tires should be replaced.

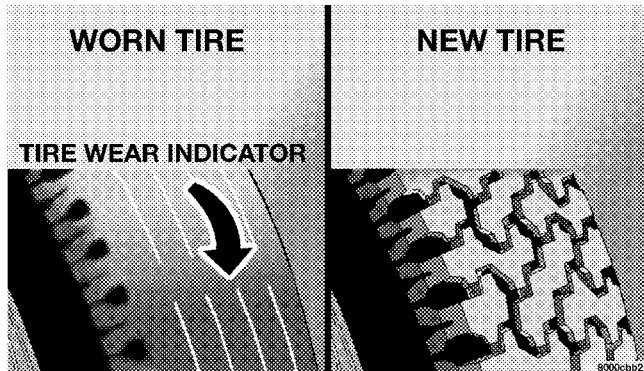

These indicators are molded into the bottom of the tread grooves and will appear as bands when the tread depth becomes 1/16 inch (2 mm). When the indicators appear in two or more adjacent grooves, the tire should be replaced.

Many states have laws requiring tire replacement at this point.

## Life of Tire

The service life of a tire is dependent upon varying factors including but not limited to:

- Driving style
- Tire pressure
- Distance driven

**WARNING!**

**Tires and spare tire should be replaced after six years, regardless of the remaining tread. Failure to follow this warning can result in sudden tire failure. You could lose control and have an accident resulting in serious injury or death.**

Keep unmounted tires in a cool, dry place with as little exposure to light as possible. Protect tires from contact with oil, grease and gasoline.

**Replacement Tires**

The tires on your new vehicle provide a balance of many characteristics. They should be inspected regularly for wear and correct cold tire inflation pressure. The manufacturer strongly recommends that you use tires equivalent to the originals in size, quality and performance when replacement is needed (see the paragraph on tread wear indicators). Refer to the Tire and Loading Information placard for the size designation of your tire. The service description and load identification will be found on the original equipment tire. Failure to use equivalent replacement tires may adversely affect the safety, handling, and ride of your vehicle. We recommend that you contact your original equipment or an authorized tire dealer with any questions you may have on tire specifications or capability.



**WARNING!**

- Do not use a tire, wheel size or rating other than that specified for your vehicle. Some combinations of unapproved tires and wheels may change suspension dimensions and performance characteristics, resulting in changes to steering, handling, and braking of your vehicle. This can cause unpredictable handling and stress to steering and suspension components. You could lose control and have an accident resulting in serious injury or death. Use only the tire and wheel sizes with load ratings approved for your vehicle.
- Never use a tire with a smaller load index or capacity, other than what was originally equipped on your vehicle. Using a tire with a smaller load index could result in tire overloading and failure. You could lose control and have an accident.
- Failure to equip your vehicle with tires having adequate speed capability can result in sudden tire failure and loss of vehicle control.

**CAUTION!**

Replacing original tires with tires of a different size may result in false speedometer and odometer readings.

**Alignment and Balance**

Poor suspension alignment may result in:

- Fast tire wear.
- Uneven tire wear, such as feathering and one-sided wear.
- Vehicle pull to right or left.

Tires may also cause the vehicle to pull left or right. Alignment will not correct this problem. See your authorized dealer for proper diagnosis.

Improper alignment will not cause vehicle vibration. Vibration may be a result of tire and wheel out-of-balance. Proper balancing will reduce vibration and avoid tire cupping and spotty wear.

### TIRE CHAINS

Install chains on rear tires only. Tire chains may be installed on all models except the Sahara and Rubicon. Follow these recommendations to guard against damage and excessive tire and chain wear:

- Use chains on P225/75R16 tires only. P245/75R16, P255/75R17, P255/70R18, and LT255/75R17 tires do not provide adequate clearance.
- Use SAE class “S” tire chains or traction devices only.
- Chains must be the proper size for the vehicle, as recommended by the chain manufacturer.
- Follow tire chain manufacturer’s instructions for mounting chains.

- Install chains snugly and tighten after 0.6 mi (1 km) of driving.
- **Do not** exceed 30 mph (48 km/h).
- Drive cautiously, avoiding large bumps, potholes and extreme driving maneuvers.

### TIRE ROTATION RECOMMENDATIONS

Tires on the front and rear axles of vehicles operate at different loads and perform different steering, handling, and braking functions. For these reasons, they wear at unequal rates, and develop irregular wear patterns.

These effects can be reduced by timely rotation of tires. The benefits of rotation are especially worthwhile with aggressive tread designs such as those on On/Off Road type tires. Rotation will increase tread life, help to maintain mud, snow, and wet traction levels, and contribute to a smooth, quiet ride.

Follow the recommended tire rotation frequency for your type of driving. Refer to the “Maintenance Schedule” in Section 8 of this manual. More frequent rotation is permissible if desired. The reasons for any rapid or unusual wear should be corrected prior to rotation being performed.

The suggested rotation method is the “forward-cross” shown in the following diagram.

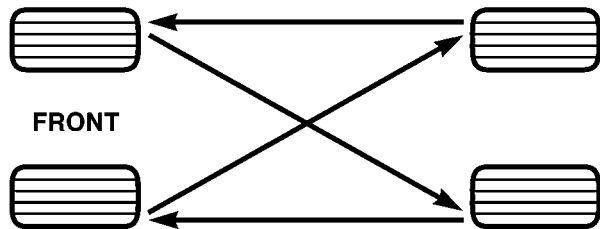

### TIRE PRESSURE MONITOR SYSTEM (TPMS)

The Tire Pressure Monitoring System (TPMS) will warn the driver of a low tire pressure based on the vehicle recommended cold placard pressure.

The tire pressure will vary with temperature by about 1 psi (6.9 kPa) for every 12°F (6.5°C). This means that when the outside temperature decreases, the tire pressure will decrease. Tire pressure should always be set based on cold inflation tire pressure. This is defined as the tire pressure after a vehicle has not been driven for more than three hours, or driven less than 1 mi (1 km) after a three hour period. **Refer to the “Tires — General Information” in this section for information on how to properly inflate the vehicle’s tires.** The tire pressure will also increase as the vehicle is driven, this is normal and there should be no adjustment for this increased pressure.

The TPMS will warn the driver of a low tire pressure if the tire pressure falls below the low pressure warning threshold for any reason, including low temperature effects, or natural pressure loss through the tire.

The TPMS will continue to warn the driver of low tire pressure as long as the condition exists, and will not turn off until the tire pressure is at or above recommended cold placard pressure. Once the Tire Pressure Monitoring Telltale Light has been illuminated, the tire pressure must be increased to the recommended cold placard pressure in order for the Tire Pressure Monitoring Telltale Light to be turned off. The system will automatically update and the Tire Pressure Monitoring Telltale Light will extinguish once the updated tire pressures have been received. The vehicle may need to be driven for up to 10 minutes above 15 mph (25 km/h) to receive this information.

For example, your vehicle may have a recommended cold (parked for more than three hours) air pressure of 35 psi (241 kPa). If the ambient temperature is 68°F (20°C) and the measured tire pressure is 30 psi (207 kPa), a temperature drop to 20°F (-7°C) will decrease the tire pressure to approximately 26 psi (179 kPa). This tire pressure is sufficiently low enough to turn ON the Tire Pressure Monitoring Telltale Light. Driving the vehicle may cause the tire pressure to rise to approximately 30 psi (207 kPa), but the Tire Pressure Monitoring Telltale Light will still be ON. In this situation, the Tire Pressure Monitoring Telltale Light will turn OFF only after the tires have been inflated to the vehicle's recommended cold placard pressure value.

**CAUTION!**

The TPMS has been optimized for the original equipment tires and wheels. TPMS pressures have been established for the tire size equipped on your vehicle. Undesirable system operation or sensor damage may result when using replacement equipment that is not of the same size, type, and/or style. Aftermarket wheels can cause sensor damage. Do not use aftermarket tire sealants or balance beads if your vehicle is equipped with a TPMS, as damage to the sensors may result.

**CAUTION!**

After inspecting or adjusting the tire pressure always reinstall the valve stem cap. This will prevent moisture and dirt from entering the valve stem, which could damage the Tire Pressure Monitoring Sensor.

**NOTE:**

- The TPMS is not intended to replace normal tire care and maintenance, nor to provide warning of a tire failure or condition.
- The TPMS should not be used as a tire pressure gauge while adjusting your tire pressure.
- Driving on a significantly under-inflated tire causes the tire to overheat and can lead to tire failure. Under-inflation also reduces fuel efficiency and tire tread life, and may affect the vehicle's handling and stopping ability.

- The TPMS is not a substitute for proper tire maintenance, and it is the driver's responsibility to maintain correct tire pressure, even if under-inflation has not reached the level to trigger illumination of the Tire Pressure Monitoring Telltale Light.
- Seasonal temperature changes will affect tire pressure, and the TPM System will monitor the actual tire pressure in the tire.

### Base System

The Tire Pressure Monitor System (TPMS) uses wireless technology with wheel rim-mounted electronic sensors to monitor tire pressure levels. Sensors, mounted to each wheel as part of the valve stem, transmit tire pressure readings to the Receiver Module.

**NOTE:** It is particularly important, for you to check the tire pressure in all of your tires regularly and to maintain the proper pressure.

The Tire Pressure Monitor System (TPMS) consists of the following components:

- Receiver Module
- Four Tire Pressure Monitoring Sensors
- Tire Pressure Monitoring Telltale Light

A tire pressure monitoring sensor is located in the spare wheel if the vehicle is equipped with a matching full size spare wheel and tire assembly. The matching full size spare tire can be used in place of any of the four road tires. A low spare tire will not cause the Tire Pressure Monitoring Telltale Light to illuminate or the chime to sound.



The Tire Pressure Monitoring Telltale Light will illuminate in the instrument cluster, and an audible chime will be activated when one or more of the four active road tire pressures are low. Should this occur, you should stop as soon as possible, check the

inflation pressure of each tire on your vehicle, and inflate each tire to the vehicle's recommended cold placard pressure value. The system will automatically update and the Tire Pressure Monitoring Telltale Light will extinguish once the updated tire pressures have been received. The vehicle may need to be driven for up to 10 minutes above 15 mph (25 km/h) to receive this information.

The Tire Pressure Monitoring Telltale Light will flash on and off for 75 seconds, and will remain on solid when a system fault is detected. The system fault will also sound a chime. If the ignition key is cycled, this sequence will repeat, providing the system fault still exists. A system fault can occur by any of the following scenarios:

1. Jamming due to electronic devices or driving next to facilities emitting the same Radio Frequencies as the TPM sensors.
2. Installing some form of aftermarket window tinting that affects radio wave signals.

3. Lots of snow or ice around the wheels or wheel housings.
4. Using tire chains on the vehicle.
5. Using wheels/tires not equipped with TPM sensors.

**NOTE:** If your vehicle is equipped with a matching full-size spare wheel and tire assembly, it has a tire pressure monitoring sensor, and can be monitored by the Tire Pressure Monitoring System (TPMS). In the event that the matching full-size spare tire is swapped with a low pressure road tire, the next ignition key cycle will still show the Tire Pressure Monitoring Telltale Light to be ON, and a chime to sound. Driving the vehicle for up to 10 minutes above 15 mph (25 km/h) will turn OFF the Tire Pressure Monitoring Telltale Light as long as none of the road tires are below the low pressure warning threshold.

**NOTE:** If your vehicle is not equipped with a matching full-size spare wheel and tire assembly, it does not have a tire pressure monitoring sensor in the spare tire. The TPMS will not be able to monitor the tire pressure. If you install the spare tire in place of a road tire that has a pressure below the low-pressure warning limit, upon the next ignition key cycle, a chime will sound and the Tire Pressure Monitoring Telltale Light will turn ON. After driving the vehicle for up to 10 minutes above 15 mph (25 km/h), the Tire Pressure Monitoring Telltale Light will flash on and off for 75 seconds and then remain on solid. For each subsequent ignition key cycle, a chime will sound and the Tire Pressure Monitoring Telltale Light will flash on and off for 75 seconds and then remain on solid. Once you repair or replace the original road tire, and reinstall it on the vehicle in place of the spare tire, the TPMS will update automatically and the Tire Pressure Monitoring Telltale Light will turn OFF, as long as no tire pressure is below the low-pressure warning limit in any

of the four active road tires. The vehicle may need to be driven for up to 10 minutes above 15 mph (25 km/h) in order for the TPMS to receive this information.

### General Information

This device complies with part 15 of the FCC rules and RSS 210 of Industry Canada. Operation is subject to the following conditions:

- This device may not cause harmful interference.
- This device must accept any interference received, including interference that may cause undesired operation.

The tire pressure sensors are covered under one of the following licenses:

United States . . . . .	KR5S120123
Canada . . . . .	2671-S120123



## FUEL REQUIREMENTS



All engines (except 5.7L engines) are designed to meet all emissions regulations and provide excellent fuel economy and performance when using high quality unleaded "regular" gasoline having an octane rating of 87. The use of premium gasoline is not recommended. Under normal conditions, the use of premium gasoline will not provide a benefit over high quality regular gasoline, and in some circumstances may result in poorer performance.

Light spark knock at low engine speeds is not harmful to your engine. However, continued heavy spark knock at high speeds can cause damage and immediate service is required.

Poor quality gasoline can cause problems such as hard starting, stalling and hesitations. If you experience these symptoms, try another brand of gasoline before considering service for the vehicle.

Over 40 auto manufacturer's worldwide have issued and endorsed consistent gasoline specifications (the Worldwide Fuel Charter, WWFC) to define fuel properties necessary to deliver enhanced emissions, performance, and durability for your vehicle. The manufacturer recommends the use of gasoline that meets the WWFC specifications if they are available.

### Reformulated Gasoline

Many areas of the country require the use of cleaner burning gasoline referred to as "Reformulated Gasoline."

Reformulated gasoline contains oxygenates, and are specifically blended to reduce vehicle emissions and improve air quality.

The manufacturer supports the use of reformulated gasoline. Properly blended reformulated gasoline will provide excellent performance and durability for the engine and fuel system components.

### **Gasoline/Oxygenate Blends**

Some fuel suppliers blend unleaded gasoline with oxygenates such as 10% ethanol, MTBE, and ETBE. Oxygenates are required in some areas of the country during the winter months to reduce carbon monoxide emissions. Fuels blended with these oxygenates may be used in your vehicle.

#### **CAUTION!**

**DO NOT use gasolines containing Methanol. Use of these blends may result in starting and drivability problems and may damage critical fuel system components.**

Problems that result from using methanol/gasoline blends are not the responsibility of the manufacturer. While MTBE is an oxygenate made from Methanol, it does not have the negative effects of Methanol.

### **MMT In Gasoline**

MMT is a manganese containing metallic additive that is blended into some gasoline to increase the octane number. Gasoline blended with MMT offers no performance advantage beyond gasoline of the same octane number without MMT. Gasoline blended with MMT has shown to reduce sparkplug life and reduce emission system performance in some vehicles. The manufacturer recommends that gasoline without MMT be used in your vehicle. The MMT content of gasoline may not be indicated on the gasoline pump, therefore, you should ask your gasoline retailer if the gasoline contains MMT.

It is even more important to look for gasoline without MMT in Canada, because MMT can be used at levels higher than those allowed in the United States.

MMT is prohibited in Federal and California-reformulated gasoline.

### Materials Added To Fuel

All gasoline sold in the United States is required to contain effective detergent additives. Use of additional detergents or other additives are not needed under normal conditions and would result in additional cost. Therefore you should not have to add anything to the fuel.

### Fuel System Cautions

#### CAUTION!

Follow these guidelines to maintain your vehicle's performance:

- The use of leaded gasoline is prohibited by Federal law. Using leaded gasoline can impair engine performance, and damage the emission control system.
- An out-of-tune engine, or certain fuel or ignition malfunctions, can cause the catalytic converter to overheat. If you notice a pungent burning odor or some light smoke, your engine may be out of tune or malfunctioning and may require immediate service. Contact your authorized dealer for service assistance.

- The use of fuel additives which are now being sold as octane enhancers is not recommended. Most of these products contain high concentrations of methanol. Fuel system damage or vehicle performance problems resulting from the use of such fuels or additives is not the responsibility of the manufacturer.

**NOTE:** Intentional tampering with emissions control systems can result in civil penalties being assessed against you.

### Carbon Monoxide Warnings

#### **WARNING!**

**Carbon monoxide (CO) in exhaust gases is deadly. Follow the precautions below to prevent carbon monoxide poisoning:**

- Do not inhale exhaust gases. They contain carbon monoxide, a colorless and odorless gas which can kill. Never run the engine in a closed area, such as a garage, and never sit in a parked vehicle with the engine running for an extended period. If the vehicle is stopped in an open area with the engine running for more than a short period, adjust the ventilation system to force fresh, outside air into the vehicle.
- Guard against carbon monoxide with proper maintenance. Have the exhaust system inspected every time the vehicle is raised. Have any abnormal conditions repaired promptly. Until repaired, drive with all side windows fully open.
- Keep the swing gate closed when driving your vehicle to prevent carbon monoxide and other poisonous exhaust gases from entering the vehicle.

## ADDING FUEL

### Fuel Filler Cap (Gas Cap)

The gas cap is located on the driver's side of the vehicle. If the gas cap is lost or damaged, be sure the replacement cap is the correct one for this vehicle.

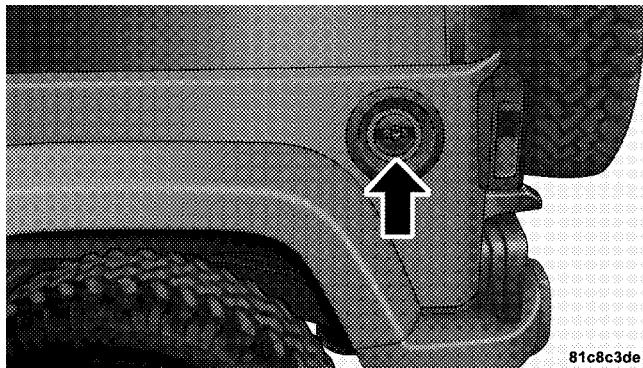

Fuel Filler Cap

### Loose Fuel Filler Cap Message (gASCAP)

After fuel has been added, the vehicle diagnostic system can determine if the fuel filler cap is possibly loose, improperly installed, or damaged. If the system detects a malfunction, the "gASCAP" message will display in the odometer display. Tighten the gas cap until a "clicking" sound is heard. This is an indication that the gas cap is properly tightened. Press the odometer reset button to turn the message off. If the problem persists, the message will appear the next time the vehicle is started. This might indicate a damaged cap. If the problem is detected twice in a row, the system will turn on the Malfunction Indicator Light. Resolving the problem will turn the MIL light off.

**CAUTION!**

Damage to the fuel system or emission control system could result from using an improper fuel cap (gas cap). A poorly fitting cap could let impurities into the fuel system. Also, a poorly fitting aftermarket cap can cause the Malfunction Indicator Light to illuminate, due to fuel vapors escaping from the system.

**CAUTION!**

To avoid fuel spillage and overfilling, do not “top off” the fuel tank after filling.

**NOTE:** When the fuel nozzle “clicks” or shuts off, the fuel tank is full.

**WARNING!**

- Never have any smoking materials lit in or near the vehicle when the gas cap is removed or the tank filled.
- Never add fuel when the engine is running. This is in violation of most state and federal fire regulations and will cause the Malfunction Indicator Light to turn on.

**NOTE:** Tighten the gas cap about 1/4 turn until you hear one click. This is an indication that cap is properly tightened.

If the gas cap is not tightened properly, the Malfunction Indicator Light will come on. Be sure the gas cap is tightened every time the vehicle is refueled.

**WARNING!**

A fire may result if gasoline is pumped into a portable container that is inside of a vehicle. You could be burned. Always place gas containers on the ground while filling.

**VEHICLE LOADING****Certification Label**

As required by National Highway Traffic Safety Administration regulations, your vehicle has a certification label affixed to the driver's side door or B-Pillar.

This label contains the month and year of manufacture, Gross Vehicle Weight Rating (GVWR), Gross Axle Weight Rating (GAWR) front and rear, and Vehicle Identification Number (VIN). A Month-Day-Hour (MDH) number is

included on this label and indicates the month, day, and hour of manufacture. The bar code that appears on the bottom of the label is your VIN.

**Gross Vehicle Weight Rating (GVWR)**

The GVWR is the total permissible weight of your vehicle including driver, passengers, vehicle, options, trailer tongue weight, and cargo. The label also specifies maximum capacities of front and rear axle systems (GAWR). Total load must be limited, so GVWR, and front and rear GAWR are not exceeded.

**Payload**

The payload of a vehicle is defined as the allowable load weight a truck can carry, including the weight of the driver, all passengers, options and cargo.

**Gross Axle Weight Rating (GAWR)**

The GAWR is the maximum permissible load on the front and rear axles. The load must be distributed in the cargo area so that the GAWR of each axle is not exceeded.

Each axle's GAWR is determined by the components in the system with the lowest load carrying capacity (axle, springs, tires, or wheels). Heavier axles or suspension components, sometimes specified by purchasers for increased durability, does not necessarily increase the vehicle's GVWR.

### **Tire Size**

The tire size on the label represents the actual tire size on your vehicle. Replacement tires must be equal to the load capacity of this tire size.

### **Rim Size**

This is the rim size that is appropriate for the tire size listed.

### **Inflation Pressure**

This is the cold tire inflation pressure for your vehicle for all loading conditions up to full GAWR.

### **Curb Weight**

The curb weight of a vehicle is defined as the total weight of the vehicle with all fluids, including vehicle fuel, at full capacity conditions, and with no occupants or cargo loaded into the vehicle. The front and rear curb weight values are determined by weighing your vehicle on a commercial scale before any occupants or cargo are added.

### **Loading**

The actual total weight and the weight of the front and rear of your vehicle at the ground can best be determined by weighing it when it is loaded and ready for operation.

The entire vehicle should first be weighed on a commercial scale to ensure that the GVWR has not been exceeded. The weight on the front and rear of the vehicle should then be determined separately to be sure that the load is properly distributed over front and rear axle. Weighing the vehicle may show that the GAWR of either



the front or rear axles has been exceeded, but the total load is within the specified GVWR. If so, weight must be shifted from front to rear, or rear to front, as appropriate until the specified weight limitations are met. Store the heavier items down low and be sure that the weight is distributed equally. Stow all loose items securely before driving.

Improper weight distributions can have an adverse affect on the way your vehicle steers and handles, and the way the brakes operate.

### CAUTION!

**Do not load your vehicle any heavier than the GVWR or the maximum front and rear GAWR. If you do, parts on your vehicle can break, or it can change the way your vehicle handles. This could cause you to lose control. Also, overloading can shorten the life of your vehicle.**

### TRAILER TOWING

In this section you will find safety tips and information on limits to the type of towing you can reasonably do with your vehicle. Before towing a trailer carefully review this information to tow your load as efficiently and safely as possible.

To maintain warranty coverage, follow the requirements and recommendations in this Owner's Manual concerning vehicles used for trailer towing.

## Common Towing Definitions

The following trailer towing-related definitions will assist you in understanding the following information:

### Gross Vehicle Weight Rating (GVWR)

The GVWR is the total allowable weight of your vehicle. This includes driver, passengers, cargo and trailer tongue weight. The total load must be limited so that you do not exceed the GVWR.

### Gross Trailer Weight (GTW)

The GTW is the weight of the trailer plus the weight of all cargo, consumables and equipment (permanent or temporary) loaded in or on the trailer in its "loaded and ready for operation" condition. The recommended way to measure GTW is to put your fully-loaded trailer on a vehicle scale. The entire weight of the trailer must be supported by the scale.

### Gross Combination Weight Rating (GCWR)

The GCWR is the total permissible weight of your vehicle and trailer when weighed in combination. (Note that GCWR ratings include a 150 lbs (68 kg) allowance for the presence of a driver).

### Gross Axle Weight Rating (GAWR)

The GAWR is the maximum capacity of the front and rear axles. Distribute the load over the front and rear axles evenly. Make sure that you do not exceed either front or rear GAWR.

## WARNING!

**It is important that you do not exceed the maximum front or rear GAWR. A dangerous driving condition can result if either rating is exceeded. You could lose control of the vehicle and have an accident.**

### **Trailer Tongue Weight (TW)**

The trailer tongue weight is the downward force exerted on the hitch ball by the trailer. In most cases it should not be less than 10% or more than 15% of the trailer load. You must consider this as part of the load on your vehicle.

### **Frontal Area**

The frontal area is the maximum height and maximum width of the front of a trailer.

### **Trailer Sway Control**

The trailer sway control is a telescoping link that can be installed between the hitch receiver and the trailer tongue. It typically provides adjustable friction associated with the telescoping motion to dampen any unwanted trailer swaying motions while traveling.

### **Weight-Carrying Hitch**

A weight-carrying hitch supports the trailer tongue weight, just as if it were luggage located at a hitch ball or some other connecting point of the vehicle. This kind of

hitch is the most popular on the market today and is commonly used to tow small and medium-sized trailers.

### **Weight-Distributing Hitch**

A weight-distributing hitch system works by applying leverage through spring (load) bars. It is typically used for heavier loads, to distribute trailer tongue weight to the tow vehicle's front axle and the trailer axle(s). When used in accordance with the manufacturers' directions, it provides for a more level ride, offering more consistent steering and brake control thereby enhancing towing safety. The addition of a friction/hydraulic sway control also dampens sway caused by traffic and crosswinds, and contributes positively to tow vehicle and trailer stability. Trailer sway control and a weight-distributing (load-equalizing) hitch are recommended for heavier tongue weights (TW) and may be required depending on vehicle and trailer configuration/loading to comply with Gross Axle Weight Rating (GAWR) requirements.

**WARNING!**

An improperly adjusted weight-distributing hitch system may reduce handling, stability, braking performance, and could result in an accident.

Weight-Distributing Hitch Systems may not be compatible with Surge Brake Couplers. Consult with your hitch and trailer manufacturer or a reputable Recreational Vehicle dealer for additional information.

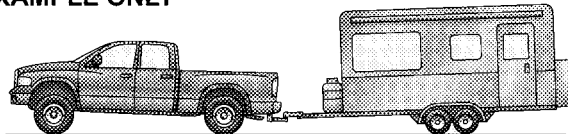
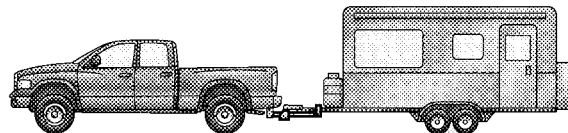
**EXAMPLE ONLY****FIG. 1 WITHOUT WEIGHT DISTRIBUTION****FIG. 2. WITH WEIGHT DISTRIBUTION**

8181F965

**Weight-Distributing Hitch System**

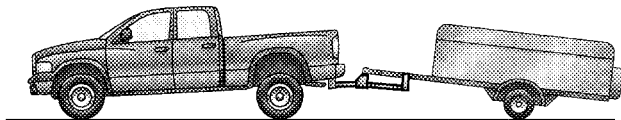
**EXAMPLE ONLY****FIG. 3 IMPROPER ADJUSTMENT (INCORRECT)**

8181f96f

**Improper Adjustment of Weight-Distributing System****Trailer Hitch Classification**

The following chart provides the industry standard for the maximum trailer weight a given trailer hitch class can tow and should be used to assist you in selecting the correct trailer hitch for your intended towing condition.

Refer to the Trailer Towing Weights (Maximum Trailer Weight Ratings) chart for the Max. GTW towable for your given drivetrain.

<b>Trailer Hitch Classification</b>	
<b>Class</b>	<b>Max. GTW (Gross Trailer Wt.)</b>
Class I - Light Duty	2,000 lbs (907 kg)
Class II - Medium Duty	3,500 lbs (1 587 kg)

All trailer hitches should be professionally installed on your vehicle.

**Trailer Towing Weights (Maximum Trailer Weight Ratings)**

The following chart provides the maximum trailer weight ratings towable for your given drivetrain.

Engine/ Transmission	Axle	Model	GCWR (Gross Combined Wt. Rating)	Frontal Area	Max. GTW (Gross Trailer Wt.)	Max. Trailer Tongue Wt. (See Note)
3.8L/Manual	3.21	2-Door X Model (4WD)	4,987 lbs (2 262 kg)	25 sq ft (2.32 sq m)	1,000 lbs (453 kg)	100 lbs (45 kg)
3.8L/Manual	3.73	2-Door X Model (4WD)	5,987 lbs (2 716 kg)	25 sq ft (2.32 sq m)	2,000 lbs (907 kg)	200 lbs (91 kg)
3.8L/ Automatic	3.73	2-Door X Model (4WD)	6,032 lbs (2 736 kg)	25 sq ft (2.32 sq m)	2,000 lbs (907 kg)	200 lbs (91 kg)
3.8L/Manual	3.21	2-Door Sahara Model (4WD)	5,163 lbs (2 342 kg)	25 sq ft (2.32 sq m)	1,000 lbs (453 kg)	100 lbs (45 kg)
3.8L/Manual	3.73	2-Door Sahara Model (4WD)	6,163 lbs (2 795 kg)	25 sq ft (2.32 sq m)	2,000 lbs (907 kg)	200 lbs (91 kg)
3.8L/ Automatic	3.73	2-Door Sahara Model (4WD)	6,163 lbs (2 795 kg)	25 sq ft (2.32 sq m)	2,000 lbs (907 kg)	200 lbs (91 kg)
3.8L/Manual	4.10	2-Door Rubi- con Model (4WD)	6,236 lbs (2 829 kg)	25 sq ft (2.32 sq m)	2,000 lbs (907 kg)	200 lbs (91 kg)

## 350 STARTING AND OPERATING

3.8L/ Automatic	4.10	2-Door Rubi- con Model (4WD)	6,281 lbs (2 849 kg)	25 sq ft (2.32 sq m)	2,000 lbs (907 kg)	200 lbs (91 kg)
3.8L/Manual	3.21	4-Door X Model (2WD)	5,121 lbs (2 323 kg)	32 sq ft (2.97 sq m)	1,000 lb s (453 kg)	100 lbs (45 kg)
3.8L/Manual	3.73	4-Door X Model (2WD)	7,621 lbs (3 457 kg)	32 sq ft (2.97 sq m)	3,500 lbs (1 587 kg)	350 lbs (159 kg)
3.8L/ Automatic	3.73	4-Door X Model (2WD)	7,647 lbs (3 469 kg)	32 sq ft (2.97 sq m)	3,500 lbs (1 587 kg)	350 lbs (159 kg)
3.8L/Manual	3.21	4-Door Sahara Model (2WD)	5,277 lbs (2 394 kg)	32 sq ft (2.97 sq m)	1,000 lbs (453 kg)	100 lbs (45 kg)
3.8L/Manual	3.73	4-Door Sahara Model (2WD)	7,777 lbs (3 527 kg)	32 sq ft (2.97 sq m)	3,500 lbs (1 587 kg)	350 lbs (159 kg)
3.8L/ Automatic	3.73	4-Door Sahara Model (2WD)	7,803 lbs (3 539 kg)	32 sq ft (2.97 sq m)	3,500 lbs (1 587 kg)	350 lbs (159 kg)
3.8L/Manual	3.21	4-Door X Model (4WD)	5,325 lbs (2 415 kg)	32 sq ft (2.97 sq m)	1,000 lbs (453 kg)	100 lbs (45 kg)
3.8L/Manual	3.73	4-Door X Model (4WD)	7,825 lbs (3 549 kg)	32 sq ft (2.97 sq m)	3,500 lbs (1 587 kg)	350 lbs (159 kg)

3.8L/ Automatic	3.73	4-Door X Model (4WD)	7,825 lbs (3 549 kg)	32 sq ft (2.97 sq m)	3,500 lbs (1 587 kg)	350 lbs (159 kg)
3.8L/Manual	3.21	4-Door Sahara Model (4WD)	5,481 lbs (2 486 kg)	32 sq ft (2.97 sq m)	1,000 lbs (453 kg)	100 lbs (45 kg)
3.8L/Manual	3.73	4-Door Sahara Model (4WD)	7,981 lbs (3 620 kg)	32 sq ft (2.97 sq m)	3,500 lbs (1 587 kg)	350 lbs (159 kg)
3.8L/ Automatic	3.73	4-Door Sahara Model (4WD)	8,027 lbs (3 641 kg)	32 sq ft (2.97 sq m)	3,500 lbs (1 587 kg)	350 lbs (159 kg)
3.8L/Manual	4.10	4-Door Rubi- con Model (4WD)	8,059 lbs (3 655 kg)	32 sq ft (2.97 sq m)	3,500 lbs (1 587 kg)	350 lbs (159 kg)
3.8L/ Automatic	4.10	4-Door Rubi- con Model (4WD)	8,104 lbs (3 676 kg)	32 sq ft (2.97 sq m)	3,500 lbs (1 587 kg)	350 lbs (159 kg)
Refer to local laws for maximum trailer towing speeds.						

**NOTE:** The trailer tongue weight must be considered as part of the combined weight of occupants and cargo, and should never exceed the weight referenced on the Tire

and Loading Information placard. Refer to the "Tire Safety Information" section in this manual.



### Trailer and Trailer Tongue Weight

Always load a trailer with 60% to 65% of the weight in the front of the trailer. This places 10% to 15% of the Gross Trailer Weight (GTW) on the tow hitch of your vehicle. Loads balanced over the wheels or heavier in the rear can cause the trailer to sway **severely** side-to-side which will cause loss of control of vehicle and trailer. Failure to load trailers heavier in front is the cause of many trailer accidents.

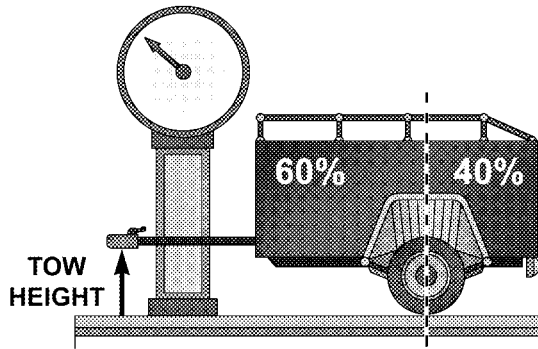

81546c40

Consider the following items when computing the weight on the rear axle of the vehicle:

- The trailer tongue weight.
- The weight of any other type of cargo or equipment put in or on your vehicle.
- The weight of the driver and all passengers.

**NOTE:** Remember that everything put into or on the trailer adds to the load on your vehicle. Also, additional factory-installed options, or authorized dealer-installed options, must be considered as part of the total load on your vehicle. Refer to the Tire and Loading Information placard in the “Tire Safety Information” section of this manual for the maximum combined weight of occupants and cargo for your vehicle.

### Towing Requirements

To promote proper break-in of your new vehicle drivetrain components, the following guidelines are recommended:

**NOTE:** Trailer towing requires special rear axle lubricant. Refer to “Fluids, Lubricants, and Genuine Parts” in Section 7 for more information.

### CAUTION!

- **Avoid towing a trailer for the first 500 mi (805 km) of vehicle operation. Doing so may damage your vehicle.**

Perform the maintenance listed in the “Maintenance Schedule.” Refer to Section 8 of this manual. When towing a trailer, never exceed the GAWR, or GCWR, ratings.

**WARNING!**

**Improper towing can lead to an injury accident. Follow these guidelines to make your trailer towing as safe as possible:**

**Make certain that the load is secured in the trailer and will not shift during travel. When trailering cargo that is not fully secured, dynamic load shifts can occur that may be difficult for the driver to control. You could lose control of your vehicle and have an accident.**

- When hauling cargo or towing a trailer, do not overload your vehicle or trailer. Overloading can cause a loss of control, poor performance or damage to brakes, axle, engine, transmission, steering, suspension, chassis structure or tires.

- Safety chains must always be used between your vehicle and trailer. Always connect the chains to the frame or hook retainers of the vehicle hitch. Cross the chains under the trailer tongue and allow enough slack for turning corners.
- Vehicles with trailers should not be parked on a grade. When parking, apply the parking brake on the tow vehicle. Put the tow vehicle automatic transmission in PARK. With a manual transmission, shift the transmission into 1st gear. And with four-wheel-drive vehicles, make sure the transfer case is not in N (Neutral). Always, block or "chock" the trailer wheels.
- GCWR must not be exceeded.
- **Total weight must be distributed between the tow vehicle and the trailer such that the following four ratings are not exceeded:**

1. GVWR

2. GTW
3. GAWR
4. Tongue weight rating for the trailer hitch utilized (This requirement may limit the ability to always achieve the 10% to 15% range of tongue weight as a percentage of total trailer weight).

### Towing Requirements — Tires

- Do not attempt to tow a trailer while using a compact spare tire.
- Proper tire inflation pressures are essential to the safe and satisfactory operation of your vehicle. Refer to the “Tires–General Information” section of this manual for proper tire inflation procedures.
- Also, check the trailer tires for proper tire inflation pressures before trailer usage.

- Check for signs of tire wear or visible tire damage before towing a trailer. Refer to the “Tires–General Information” section of this manual for the proper inspection procedure.
- When replacing tires, refer to the “Tires–General Information” section for proper tire replacement procedures. Replacing tires with a higher load carrying capacity will not increase the vehicle’s GVWR and GAWR limits.

### Towing Requirements — Trailer Brakes

- Do **not** interconnect the hydraulic brake system or vacuum system of your vehicle with that of the trailer. This could cause inadequate braking and possible personal injury.

- An electronically-actuated trailer brake controller is required when towing a trailer with electronically actuated brakes. When towing a trailer equipped with a hydraulic surge-actuated brake system, an electronic brake controller is not required.
- Trailer brakes are recommended for trailers over 1,000 lbs (454 kg) and required for trailers in excess of 2,000 lbs (907 kg).

### CAUTION!

If the trailer weighs more than 1,000 lbs (454 kg) loaded, it should have its own brakes and they should be of adequate capacity. Failure to do this could lead to accelerated brake lining wear, higher brake pedal effort, and longer stopping distances.

### WARNING!

**Do not connect trailer brakes to your vehicle's hydraulic brake lines. It can overload your brake system and cause it to fail. You might not have brakes when you need them and could have an accident.**

**Towing any trailer will increase your stopping distance. When towing you should allow for additional space between your vehicle and the vehicle in front of you. Failure to do so could result in an accident.**

### Towing Requirements — Trailer Lights & Wiring

Whenever you pull a trailer, regardless of the trailer size, stop lights and turn signals on the trailer are required for motoring safety.

The Trailer Tow Package will include a 4-pin wiring harness. Use a factory-approved trailer harness and connector.

**NOTE:** Do not cut or splice wiring into the vehicles wiring harness.

The electrical connections are all complete to the vehicle but you must mate the harness to a trailer connector. Refer to the following illustration.

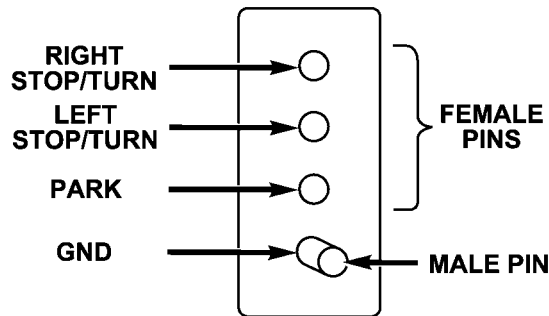

813262be

4 - Pin Connector

### Towing Tips

Before setting out on a trip, practice turning, stopping and backing the trailer in an area away from heavy traffic.

If using a manual transmission vehicle for trailer towing, all starts must be in 1st gear to avoid excessive clutch slippage.

### **Towing Tips — Automatic Transmission**

The DRIVE range can be selected when towing. However, if frequent shifting occurs while in this range, the OVERDRIVE range should be selected.

**NOTE:** Using “O/D OFF” while operating the vehicle under heavy operating conditions will improve performance and extend transmission life by reducing excessive shifting and heat build up. This action will also provide better engine braking.

The automatic transmission fluid and filter should be changed if you REGULARLY tow a trailer for more than 45 minutes of continuous operation. Refer to the “Maintenance Schedule” in Section 8 of this manual for transmission fluid change intervals.

**NOTE:** Check the automatic transmission fluid level before towing.

### **Towing Tips — O/D Off**

To reduce potential for automatic transmission overheating, select the “O/D OFF” feature when driving in hilly areas or shift the transmission to DRIVE position 2 on more severe grades. Refer to “Transmission Shifting” in this section.

### **Towing Tips — Electronic Speed Control (If Equipped)**

- Don’t use in hilly terrain or with heavy loads.
- When using the speed control, if you experience speed drops greater than 10 mph (16 km/h), disengage until you can get back to cruising speed.
- Use speed control in flat terrain and with light loads to maximize fuel efficiency.

### Towing Tips — Cooling System

To reduce potential for engine and transmission overheating, take the following actions:

– *Highway Driving*

Reduce speed.

– *Air Conditioning*

Turn off temporarily.

– refer to Cooling System Operating information in the Maintenance section of this manual for more information.

### RECREATIONAL TOWING (BEHIND MOTORHOME, ETC.)

#### CAUTION!

Front or rear wheel lifts should not be used. Internal damage to the transmission or transfer case will occur if a front or rear wheel lift is used when recreational towing.

5

### Towing – 2WD Models

Recreational towing is allowed **ONLY** if the rear driveshaft is removed. See your authorized dealer or refer to the **Service Manual**. Towing with the rear wheels on the ground while the driveshaft is connected can result in severe transmission damage.



## Towing – 4WD Models

**NOTE:** The transfer case must be shifted into N (Neutral) for recreational towing.

### Shifting Into Neutral (N)

Use the following procedure to prepare your vehicle for recreational towing.

#### CAUTION!

**It is necessary to follow these steps to be certain that the transfer case is fully in N (Neutral) before recreational towing to prevent damage to internal parts.**

1. Depress brake pedal.
2. Shift automatic transmission into NEUTRAL or depress clutch pedal on manual transmission.
3. Shift transfer case lever into N (Neutral).

4. Start engine.
5. Shift automatic transmission into DRIVE or manual transmission into gear.
6. Release brake pedal and ensure that there is no vehicle movement.
7. Shut the engine off and place the ignition key into the ACC position.
8. Shift automatic transmission into PARK.
9. Apply parking brake.
10. Attach vehicle to the tow vehicle with tow bar.
11. Release parking brake.
12. Disconnect the negative battery cable, and secure it away from the negative battery post.

**CAUTION!**

Damage to the transmission may occur if the transmission is shifted into PARK with the transfer case in N (Neutral) and the engine running. With the transfer case in N (Neutral) ensure that the engine is off prior to shifting the transmission into PARK (refer to steps 7 – 8 above).

**Shifting Out Of Neutral (N)**

Use the following procedure to prepare your vehicle for normal usage.

1. Shift automatic transmission into NEUTRAL or depress clutch pedal on manual transmission.
2. Shift transfer case lever into desired position.
3. Shift automatic transmission into DRIVE or release clutch on manual transmissions.

**NOTE:** When shifting out of transfer case N (Neutral) on automatic transmission-equipped vehicles, turning the engine off may be required to avoid gear clash.

**WARNING!**

You or others could be injured if you leave the vehicle unattended with the transfer case in the N (Neutral) position without first fully engaging the parking brake. The transfer case N (Neutral) position disengages both the front and rear driveshafts from the powertrain and will allow the vehicle to move despite the transmission position. The parking brake should always be applied when the driver is not in the vehicle.

**CAUTION!**

- Do not use a bumper-mounted clamp-on tow bar on your vehicle. The bumper face bar will be damaged.

# WHAT TO DO IN EMERGENCIES

## CONTENTS

---

■ Hazard Warning Flashers . . . . .	364	□ Preparations For Jacking . . . . .	367
■ If Your Engine Overheats . . . . .	365	□ Jacking Instructions . . . . .	368
■ Jacking And Tire Changing . . . . .	366	■ Jump Starting . . . . .	371
□ Jack Location . . . . .	366	■ Emergency Tow Hooks — If Equipped . . . . .	374
□ Spare Tire Stowage . . . . .	367	■ Towing A Disabled Vehicle . . . . .	374

## HAZARD WARNING FLASHERS

Your vehicle's hazard warning flasher is an emergency warning system. When you activate it, all front and rear directional signals will flash intermittently. Use it when your vehicle is disabled on or near the road. It warns other drivers to steer clear of you and your vehicle. This is an emergency warning system, not to be used when the vehicle is in motion.

To activate the warning flashers, press the switch on the lower switch bank (below the climate controls). To turn the warning flashers off, press the switch again.

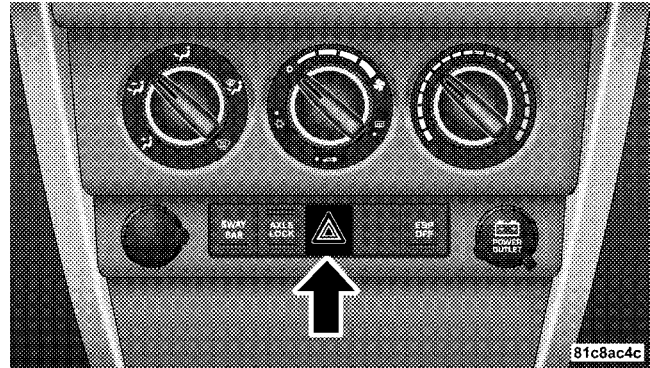

**Hazard Warning Switch**

**NOTE:** With extended use, the flasher may wear down your battery.

## IF YOUR ENGINE OVERHEATS

In any of the following situations, you can reduce the potential for overheating by taking the appropriate action.

- On the highways — Slow down.
- In city traffic — While stopped, shift transmission into NEUTRAL, but do not increase engine idle speed.

**NOTE:** There are steps that you can take to slow down an impending overheat condition. If your air conditioner is on, turn it off. The air conditioning system adds heat to the engine cooling system and turning off the A/C removes this heat. You can also turn the Temperature Control to maximum heat, the Mode Control to floor, and the Fan Control to High. This allows the heater core to act as a supplement to the radiator and aids in removing heat from the engine cooling system.

### CAUTION!

Driving with a hot cooling system could damage your vehicle. If the temperature gauge reads **HOT (H)**, pull over and stop the vehicle. Idle the vehicle with the air conditioner turned off until the pointer drops back into the normal range. If the pointer remains on **HOT (H)**, and you hear continuous chimes, turn the engine off immediately, and call for service.

## JACKING AND TIRE CHANGING

### WARNING!

- Getting under a jacked-up vehicle is dangerous. The vehicle could slip off the jack and fall on you. You could be crushed. Never get any part of your body under a vehicle that is on a jack. If you need to get under a raised vehicle, take it to a service center where it can be raised on a lift.
- The jack is designed to use as a tool for changing tires only. The jack should not be used to lift the vehicle for service purposes. The vehicle should be jacked on a firm level surface only. Avoid ice or slippery areas.

### Jack Location

The jack and lug wrench are located in the rear storage compartment. Refer to “Storage” in Section 3 of this manual.

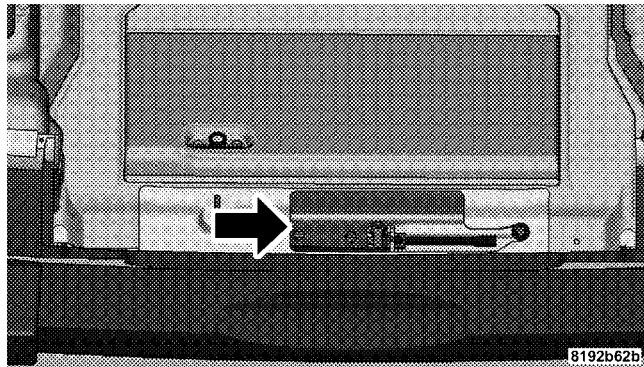

Jack Storage

## Spare Tire Stowage

To remove the spare tire from the carrier, remove the tire cover, if equipped, and remove the lug nuts with the lug wrench turning them counterclockwise.

**NOTE:** If you have added aftermarket accessories to the spare tire mounted carrier, it cannot exceed a gross weight of 50 lbs (23 kg) including the weight of the spare tire.

## Preparations For Jacking

Park on a firm level surface, avoid ice or slippery areas, **set the parking brake** and shift automatic transmission into PARK, or manual transmission into REVERSE. Turn OFF the ignition.

### WARNING!

**Do not attempt to change a tire on the side of the vehicle close to moving traffic. Pull far enough off the road to avoid being hit when operating the jack or changing the wheel.**

- Turn on the hazard warning flashers. Refer to “Hazard Warning Flashers” in this section.

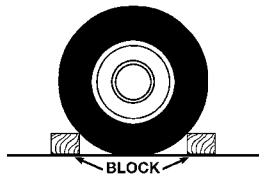

- Block both the front and rear of the wheel diagonally opposite of the jacking position. For example, if changing the right front tire, block the left rear wheel.

- Passengers should not remain in the vehicle when the vehicle is being jacked.



## Jacking Instructions



Jack Warning Label

### WARNING!

Carefully follow these tire changing warnings to help prevent personal injury or damage to your vehicle:

- Always park on a firm, level surface as far from the edge of the roadway as possible before raising the vehicle.
- Block the wheel diagonally opposite the wheel to be raised.
- Set the parking brake firmly, and shift a automatic transmission into PARK; or a manual transmission into REVERSE.
- Never start or run the engine with the vehicle on a jack.
- Do not let anyone sit in the vehicle when it is on a jack.
- Do not get under the vehicle when it is on a jack.
- Only use the jack in the positions indicated and for lifting this vehicle during a tire change.
- If working on or near a roadway, be extremely careful of motor traffic.
- To assure that spare tires, flat or inflated are securely stowed, spares must be stowed with the valve stem facing the ground.
- Turn on the hazard warning flasher.

1. Remove spare tire, jack and tools from stored location.
2. Loosen (but do not remove) the wheel lug nuts by turning them to the left one turn while the wheel is still on the ground.
3. Assemble the jack and jacking tools. Connect jack handle driver to extension, then to lug wrench.
4. Operate jack from the front or the rear of the vehicle. Place the jack under the axle tube, as shown. **Do not raise the vehicle until you are sure the jack is fully engaged.**

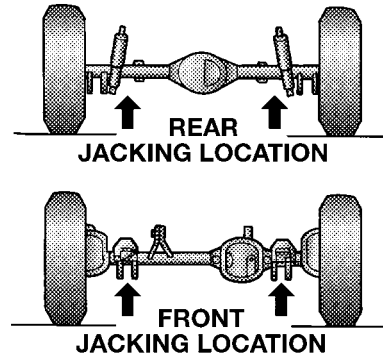

Jacking Locations

5. Raise the vehicle by turning the jack screw to the right. Raise the vehicle only until the tire just clears the surface and enough clearance is obtained to install the spare tire. Minimum tire lift provides maximum stability.

80a95422

6

**WARNING!**

**Raising the vehicle higher than necessary can make the vehicle less stable and cause an accident. It could slip off the jack and hurt someone near it. Raise the vehicle only enough to remove the tire.**

6. Remove the lug nuts and wheel.
7. Position spare wheel/tire on vehicle and install lug nuts with cone-shaped end toward wheel. Lightly tighten nuts clockwise. To avoid the risk of forcing the vehicle off the jack, do not tighten the nuts fully until the vehicle has been lowered.
8. Lower the vehicle by turning the jack screw to the left, and remove the jack and wheel blocks.

9. Finish tightening the lug nuts. Push down on the wrench while tightening for increased leverage. Alternate nuts until each nut has been tightened twice. Correct wheel nut tightness is 95 ft lbs (130 N·m). If in doubt about the correct tightness, have them checked with a torque wrench by your authorized dealer or at a service station.

10. Remove jack assembly and wheel blocks.

**WARNING!**

**A loose tire or jack, thrown forward in a collision or hard stop, could endanger the occupants of the vehicle. Always stow the jack parts and the spare tire in the places provided.**

11. Secure the tire, jack, and tools in their proper locations.

## JUMP STARTING

If the vehicle has a discharged battery, booster cables may be used to obtain a start from a booster battery or the battery in another vehicle. This type of start can be dangerous if done improperly, so follow this procedure carefully.

### WARNING!

**Battery fluid is a corrosive acid solution; do not allow battery fluid to contact eyes, skin or clothing. Don't lean over battery when attaching clamps or allow the clamps to touch each other. If acid splashes in eyes or on skin, flush contaminated area immediately with large quantities of water.**

**A battery generates hydrogen gas which is flammable and explosive. Keep flame or spark away from the vent holes.**

**Do not use a booster battery or any other booster source that has a greater than 12-volt system, i.e., Do not use a 24-volt power source.**

6

1. Remove all metal jewelry such as watch bands or bracelets which might make an unintended electrical contact.

2. Park the booster vehicle within cable reach but without letting the vehicles touch. Set the parking brake on both vehicles, shift the automatic transmission into PARK, or the manual transmission into NEUTRAL, and turn the ignition OFF.
3. Turn off the heater, radio, and all unnecessary electrical loads.
4. Connect one end of a jumper cable to the positive terminal of the booster battery. Connect the other end of the same cable to the positive terminal of the discharged battery.

**WARNING!**

**Do not permit vehicles to touch each other as this could establish a ground connection and personal injury could result.**

5. Connect the other cable, first to the negative terminal of the booster battery and then to the engine of the vehicle with the discharged battery. Make sure you have a good contact on the engine.
6. Start the engine in the vehicle which has the booster battery, let the engine idle a few minutes, then start the engine in the vehicle with the discharged battery.
7. When removing the jumper cables, reverse the above sequence exactly. Be careful of the moving belts and fan.

**WARNING!**

Any procedure other than above could result in:

1. Personal injury caused by electrolyte squirting out the battery vent;
2. Personal injury or property damage due to battery explosion;
3. Damage to charging system of booster vehicle or of immobilized vehicle.

**WARNING!**

- You should not try to start your vehicle by pushing or towing.
- Do not connect the cable to the negative post of the discharge battery. The resulting electrical spark could cause the battery to explode.
- During cold weather when temperatures are below freezing point, electrolyte in a discharged battery may freeze. Do not attempt jump starting because the battery could rupture or explode. The battery temperature must be brought up above freezing point before attempting jump start.

### EMERGENCY TOW HOOKS — IF EQUIPPED

If your vehicle is equipped with tow hooks, they are mounted in the front and the rear.

#### CAUTION!

Tow hooks are for emergency use only, to rescue a vehicle stranded off road. Do not use tow hooks for tow truck hookup or highway towing. You could damage your vehicle. Tow straps are recommended when towing the vehicle, chains may cause vehicle damage.

#### WARNING!

Stand clear of vehicles when pulling with tow hooks. Tow straps and chains may break, causing serious injury.

### TOWING A DISABLED VEHICLE

The manufacturer recommends towing with all four wheels **OFF** the ground. Acceptable methods are to tow the vehicle on a flatbed or with one end of the vehicle raised and the other end on a towing dolly.

# MAINTAINING YOUR VEHICLE

## CONTENTS

■ Engine Compartment – 3.8L . . . . .	378	□ Drive Belts — Check Condition And Tension . .	386
■ Onboard Diagnostic System — OBD II . . . . .	379	□ Spark Plugs . . . . .	386
□ Loose Fuel Filler Cap Message . . . . .	380	□ Catalytic Converter . . . . .	386
■ Emissions Inspection And Maintenance Programs . . . . .	380	□ Crankcase Emission Control System . . . . .	388
■ Replacement Parts . . . . .	382	□ Fuel Filter . . . . .	388
■ Authorized Dealer Service . . . . .	382	□ Engine Air Cleaner Filter . . . . .	389
■ Maintenance Procedures . . . . .	383	□ Maintenance-Free Battery . . . . .	389
□ Engine Oil . . . . .	383	□ Air Conditioner Maintenance . . . . .	390
		□ Power Steering Fluid Check . . . . .	391



- Driveline And Steering Component Lubrication . . . . .392
- Body Lubrication . . . . .392
- Windshield Wiper Blades . . . . .392
- Windshield And Rear Window Washers . . . . .393
- Exhaust System . . . . .393
- Cooling System . . . . .394
- Hoses And Vacuum/Vapor Harnesses . . . . .399
- Brake System . . . . .399
- Automatic Transmission . . . . .401
- Hydraulic Clutch Fluid — Manual Transmission . . . . .403
- Manual Transmission . . . . .403
- Transfer Case . . . . .404
- Front/Rear Axle Fluid . . . . .405
- Maintenance After Off-Road Driving . . . . .405
- Appearance Care And Protection From Corrosion . . . . .406
- Fuses (Totally Integrated Power Module) . . . . .413
- Vehicle Storage . . . . .419
- Replacement Bulbs — If Equipped . . . . .420
- Bulb Replacement . . . . .420
  - Head Light . . . . .420
  - Front Park/Turn Signal . . . . .421
  - Front Side Marker . . . . .422
  - Front Fog Light . . . . .422
  - Rear Tail, Stop, Turn Signal, And Backup Lights . . . . .422

□ Center High-Mounted Stop Light (CHMSL) . . . . .	423	□ Engine . . . . .	424
■ Fluid Capacities . . . . .	424	□ Chassis . . . . .	425
■ Fluids, Lubricants And Genuine Parts . . . . .	424		

## ENGINE COMPARTMENT – 3.8L

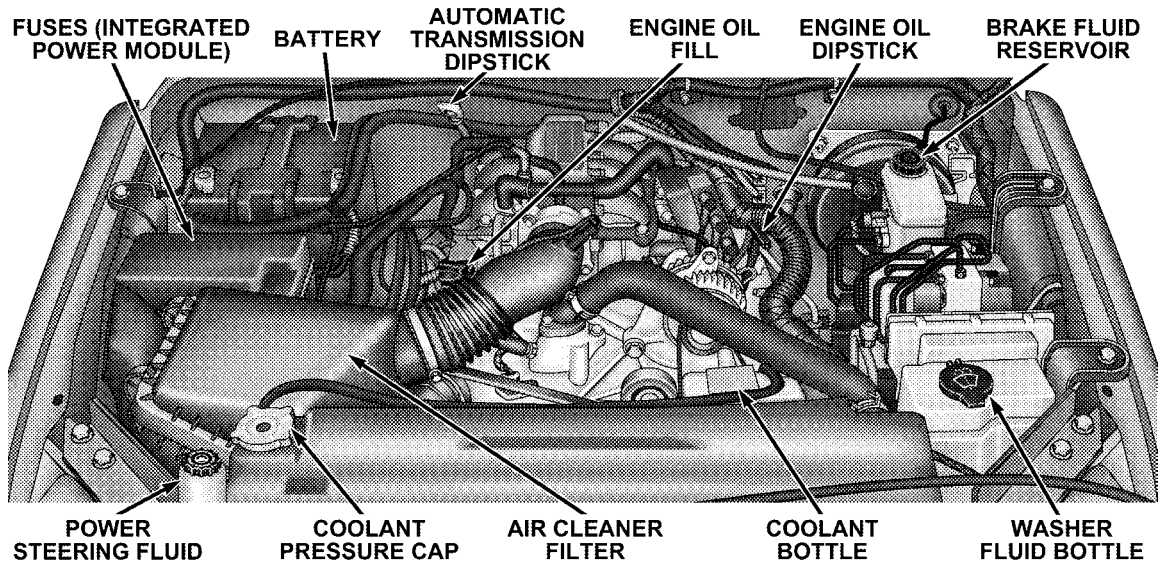

8191f0ee

## ONBOARD DIAGNOSTIC SYSTEM — OBD II

Your vehicle is equipped with a sophisticated onboard diagnostic system called OBD II. This system monitors the performance of the emissions, engine, and automatic transmission control systems. When these systems are operating properly, your vehicle will provide excellent performance and fuel economy, as well as engine emissions well within current government regulations.

If any of these systems require service, the OBD II system will turn on the “Malfunction Indicator Light.” It will also store diagnostic codes and other information to assist your service technician in making repairs. Although your vehicle will usually be drivable and not need towing, see your authorized dealer for service as soon as possible.

### CAUTION!

- **Prolonged driving with the “Malfunction Indicator Light” on could cause further damage to the emission control system. It could also affect fuel economy and drivability. The vehicle must be serviced before any emissions tests can be performed.**
- **If the “Malfunction Indicator Light” is flashing while the engine is running, severe catalytic converter damage and power loss will soon occur. Immediate service is required.**

### Loose Fuel Filler Cap Message

After fuel is added, the vehicle diagnostic system can determine if the fuel filler cap is possibly loose, improperly installed, or damaged. A "gASCAP" message will be displayed in the odometer. Tighten the gas cap until a "clicking" sound is heard. This is an indication that the gas cap is properly tightened. Press the odometer reset button to turn the message off. If the problem persists, the message will appear the next time the vehicle is started. This might indicate a damaged cap. If the problem is detected twice in a row, the system will turn on the "Malfunction Indicator Light." Resolving the problem will turn the "Malfunction Indicator Light." off.

### EMISSIONS INSPECTION AND MAINTENANCE PROGRAMS

In some localities, it may be a legal requirement to pass an inspection of your vehicle's emissions control system. Failure to pass could prevent vehicle registration.



For states that require an Inspection and Maintenance (I/M), this check verifies the Malfunction Indicator Light (MIL) is functioning and is not on when the engine is running, and that the OBD II system is ready for testing.

Normally, the OBD II system will be ready. The OBD II system may **not** be ready if your vehicle was recently serviced, recently had a dead battery, or a battery replacement. If the OBD II system should be determined not ready for the I/M test, your vehicle may fail the test.

Your vehicle has a simple ignition key-actuated test, which you can use prior to going to the test station. To check if your vehicle's OBD II system is ready, you must do the following:

1. Insert your ignition key into the ignition switch.
2. Turn the ignition to the ON position, but do not crank or start the engine.
3. If you crank or start the engine, you will have to start this test over.
4. As soon as you turn your key to the ON position, you will see the MIL symbol come on as part of a normal bulb check.
5. Approximately 15 seconds later, one of two things will happen:
  - a. The MIL will flash for about 10 seconds and then return to being fully illuminated until you turn OFF

the ignition key or start the engine. This means that your vehicle's OBD II system is **not ready** and you should **not** proceed to the I/M station.

- b. The MIL will not flash at all and will remain fully illuminated until you turn OFF the ignition key or start the engine. This means that your vehicle's OBD II system is **ready** , and you can proceed to the I/M station.

If your OBD II system is **not ready**, you should see your authorized dealer or repair facility. If your vehicle was recently serviced or had a battery failure or replacement, you may need to do nothing more than drive your vehicle as you normally would in order for your OBD II system to update. A recheck with the above test routine may then indicate that the system is now ready.

Regardless of whether your vehicle's OBD II system is ready or not ready, if the MIL is illuminated during normal vehicle operation, you should have your vehicle

serviced before going to the I/M station. The I/M station can fail your vehicle because the MIL is on with the engine running.

### REPLACEMENT PARTS

Use of genuine MOPAR® parts for normal/scheduled maintenance and repairs is highly recommended to ensure the designed performance. Damage or failures caused by the use of non-MOPAR® parts for maintenance and repairs will not be covered by the manufacturer's warranty.

### AUTHORIZED DEALER SERVICE

Your authorized dealer has the qualified service personnel, special tools, and equipment to perform all service operations in an expert manner. Service manuals are available which include detailed service information for your vehicle. Refer to these Service manuals before attempting any procedure yourself.

**NOTE:** Intentional tampering with emissions control systems can result in civil penalties being assessed against you.

### WARNING!

**You can be badly injured working on or around a motor vehicle. Only do service work for which you have the knowledge and the proper equipment. If you have any doubt about your ability to perform a service job, take your vehicle to a competent mechanic.**

## MAINTENANCE PROCEDURES

The pages that follow contain the **required** maintenance services determined by the engineers who designed your vehicle.

Besides the maintenance items for which there are fixed maintenance intervals, there are other items that should operate satisfactorily without periodic maintenance. However, if a malfunction of these items does occur, it could adversely affect the engine or vehicle performance. These items should be inspected if a malfunction is observed or suspected.

### Engine Oil

#### Checking Oil Level

To assure proper lubrication of your vehicle's engine, the engine oil must be maintained at the correct level. The best time to check the engine oil level is about five minutes after a fully warmed up engine is shut off or before starting the engine after it has sat overnight.

Checking the oil while the vehicle is on level ground will improve the accuracy of the oil level readings. Always maintain the oil level within the SAFE zone on the dipstick. Adding 1 U.S. Quart (0.95L) of oil when the reading is at the bottom of the SAFE zone will result in a reading at the top of the safe zone on these engines.

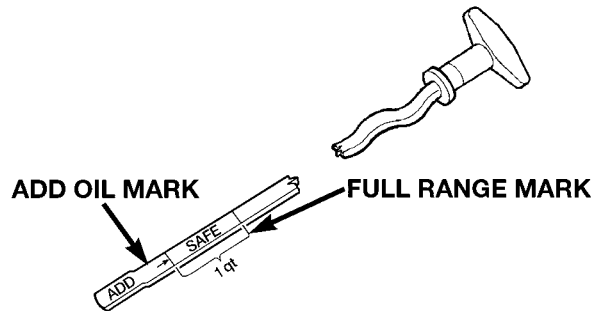



**CAUTION!**

Overfilling or underfilling the crankcase will cause aeration or loss of oil pressure. This could damage your engine.

**Change Engine Oil**

Refer to the Maintenance Schedule in Section 8 for recommended engine oil change intervals.

**Engine Oil Selection**

For best performance and maximum protection for all engines under all types of operating conditions, the manufacturer recommends engine oils that are API Certified and meet the requirements of DaimlerChrysler Material Standard MS-6395.

**American Petroleum Institute (API) Engine Oil Identification Symbol**

This symbol means that the oil has been certified by the American Petroleum Institute (API). The manufacturer only recommends API Certified engine oils.

**Engine Oil Viscosity (3.8L Engines)**

SAE 5W-20 engine oil is recommended for all operating temperatures. This engine oil improves low temperature starting and vehicle fuel economy.

The engine oil filler cap also shows the recommended engine oil viscosity for your engine. For information on engine oil filler cap location, refer to the "Engine Compartment" illustration in this section.

Lubricants which do not have both, the engine oil certification mark and the correct SAE viscosity grade number, should not be used.

### Synthetic Engine Oils

Synthetic engine oils can be used if the recommended oil quality requirements are met, and the recommended maintenance intervals for oil and filter changes are followed.

### Materials Added To Engine Oils

The manufacturer **strongly recommends** against the addition of any additives (other than leak detection dyes) to engine oil. Engine oil is an engineered product and its performance may be impaired by supplemental additives.

### Disposing of Used Engine Oil

Care should be taken in disposing of used engine oil from your vehicle. Used oil, indiscriminately discarded, can present a problem to the environment. Contact your

authorized dealer, service station, or governmental agency for advice on how and where used oil can be safely discarded in your area.

### Engine Oil Filter

The engine oil filter should be replaced at every engine oil change.

### Engine Oil Filter Selection

All of the manufacturer's engines have a full-flow type disposable oil filter. Use a filter of this type for replacement. The quality of replacement filters varies considerably. Only high quality filters should be used to assure most efficient service. MOPAR® engine oil filters are high quality oil filters and are recommended.

### **Drive Belts — Check Condition and Tension**

Belt tension is controlled by means of an automatic tensioner. No belt tension adjustments are required. However, belt and belt tensioner condition should be inspected at the specified intervals, and replaced if required. See your authorized dealer for service.

At the mileage indicated in the Maintenance Schedule, the condition of all the belts and tensioner should be checked. Refer to Section 8 of this manual. Improper belt tension can cause belt slippage and failure.

Belts should be inspected for evidence of cuts, cracks, glazing, or frayed cords and replaced if there is indication of damage, which could result in belt failure. Low generator belt tension can cause battery failure.

Also, check belt routing to make sure there is no interference between the belts and other engine components.

### **Spark Plugs**

Spark plugs must fire properly to assure engine performance and emission control. New plugs should be installed at the mileage specified in the Maintenance Schedule. Refer to Section 8 of this manual. The entire set should be replaced if there is any malfunction due to a faulty spark plug. Refer to Fluids, Lubricants, and Genuine Parts in this section for spark plug information.

### **Catalytic Converter**

The catalytic converter requires the use of unleaded fuel only. Leaded gasoline will destroy the effectiveness of the converter as an emission control device.

Under normal operating conditions, the catalytic converter will not require maintenance. However, it is important to keep the engine properly tuned to assure proper catalyst operation and prevent possible catalyst damage.

**CAUTION!**

Damage to the catalytic converter can result if your vehicle is not kept in proper operating condition. In the event of engine malfunction, particularly involving engine misfire or other apparent loss of performance, have your vehicle serviced promptly. Continued operation of your vehicle with a severe malfunction could cause the converter to overheat, resulting in possible damage to the converter and vehicle.

**WARNING!**

A hot exhaust system can start a fire if you park over materials that can burn. Such materials might be grass or leaves coming into contact with your exhaust system. Do not park or operate your vehicle in areas where your exhaust system can contact anything that can burn.

In unusual situations involving grossly malfunctioning engine operation, a scorching odor may suggest severe and abnormal catalyst overheating. If this occurs, stop the vehicle, turn off the engine and allow it to cool. Service, including a tune up to manufacturer's specifications, should be obtained immediately.

To minimize the possibility of catalytic converter damage:

- Do not shut off the engine or interrupt the ignition when the transmission is in gear and the vehicle is in motion.
- Do not try to start the engine by pushing or towing the vehicle.
- Do not idle the engine with any spark plug wires disconnected or removed, such as when diagnostic testing.
- Do not idle the engine for prolonged periods during very rough idle or malfunctioning operating conditions.
- Do not allow vehicle to run out of fuel.

**NOTE:** Intentional tampering with emissions control systems can result in civil penalties being assessed against you.

### **Crankcase Emission Control System**

Proper operation of this system depends on freedom from sticking or plugging due to deposits. As vehicle mileage builds up, the PCV valve and passages may accumulate deposits. If a valve is not working properly, replace it with a new valve. **DO NOT ATTEMPT TO CLEAN THE OLD PCV VALVE!**

Check ventilation hose for indication of damage or plugging deposits. Replace if necessary.

### **Fuel Filter**

A plugged fuel filter can cause hard starting or limit the speed at which a vehicle can be driven. Should an excessive amount of dirt accumulate in the fuel tank, frequent replacement of the fuel filter which is mounted in the fuel tank may be necessary.

### Engine Air Cleaner Filter

Refer to the Maintenance Schedule in Section 8 for recommended engine air cleaner filter change intervals.

#### WARNING!

The air cleaner can provide protection in the case of engine backfire. Do not remove the air cleaner unless it is necessary for repair or maintenance. Make sure that no one is near the engine compartment before starting the vehicle with the air cleaner removed. Failure to do so can result in serious personal injury.

### Maintenance-Free Battery

Your vehicle is equipped with a maintenance-free battery. You will never have to add water, nor is periodic maintenance required.

#### WARNING!

Battery posts, terminals, and related accessories contain lead and lead compounds. Always wash hands after handling the battery.

#### CAUTION!

It is essential when replacing the cables on the battery that the positive cable is attached to the positive post and the negative cable is attached to the negative post. Battery posts are marked (+) positive and negative (-) and identified on the battery case. Also, if a "fast charger" is used while battery is in the vehicle, disconnect both vehicle battery cables before connecting the charger to battery. Do not use a "fast charger" to provide starting voltage.

### Air Conditioner Maintenance

For best possible performance, your air conditioner should be checked and serviced by an authorized dealer at the start of each warm season. This service should include cleaning of the condenser fins and a performance test. Drive belt tension should also be checked at this time.

#### WARNING!

- Use only refrigerants and compressor lubricants approved by the manufacturer for your air conditioning system. Some unapproved refrigerants are flammable and can explode, injuring you. Other unapproved refrigerants or lubricants can cause the system to fail, requiring costly repairs. Refer to Section 3 of the Warranty Information Book for further warranty information.
- The air conditioning system contains refrigerant under high pressure. To avoid risk of personal injury or damage to the system, adding refrigerant or any repair requiring lines to be disconnected should be done by an experienced repairman.

**NOTE:** Use only manufacturer approved A/C System Sealers, Stop Leak Products, Seal Conditioners, Compressor Oil, and Refrigerants.

### Refrigerant Recovery and Recycling

R-134a Air Conditioning Refrigerant is a hydrofluorocarbon (HFC) that is endorsed by the Environmental Protection Agency (EPA) and is an ozone-saving product. However, the manufacturer recommends that air conditioning service be performed by authorized dealers or other service facilities using recovery and recycling equipment.

### Power Steering Fluid Check

Checking the power steering fluid level at a defined service interval is not required. The fluid should only be checked if a leak is suspected, abnormal noises are apparent, and/or the system is not functioning as anticipated. Coordinate inspection efforts through an authorized DaimlerChrysler Dealership.

### WARNING!

**Fluid level should be checked on a level surface with the engine off to prevent injury from moving parts, and to ensure accurate fluid level reading. Do not overfill. Use only the manufacturer's recommended power steering fluid.**

If necessary, add fluid to restore to the proper indicated level. With a clean cloth, wipe any spilled fluid from all surfaces. Refer to Fluids, Lubricants, and Genuine Parts in this section for correct fluid type.

**NOTE:** Upon initial start-up in cold weather, the power steering pump may make noise for a short period of time. This is due to the cold, thick fluid in the steering system. This noise should be considered normal, and does not in any way damage the steering system.



### **Driveline And Steering Component Lubrication**

All driveline and steering components are sealed and do not require lubrication. Driveshafts are not serviceable.

### **Body Lubrication**

Locks and all body pivot points, including such items as seat tracks, doors, tailgate and hood hinges, should be lubricated periodically to assure quiet, easy operation and to protect against rust and wear. Prior to the application of any lubricant, the parts concerned should be wiped clean to remove dust and grit; after lubricating excess oil and grease should be removed. Particular attention should also be given to hood latching components to ensure proper function. When performing other underhood services, the hood latch, release mechanism and safety catch should be cleaned and lubricated.

The external lock cylinders should be lubricated twice a year, preferably in the Fall and Spring. Apply a small

amount of a high quality lubricant such as MOPAR® Lock Cylinder Lubricant directly into the lock cylinder.

### **Windshield Wiper Blades**

Clean the rubber edges of the wiper blades and the windshield periodically with a sponge or soft cloth and a mild non-abrasive cleaner. This will remove accumulations of salt or road film.

Operation of the wipers on dry glass for long periods may cause deterioration of the wiper blades. Always use washer fluid when using the wipers to remove salt or dirt from a dry windshield. Avoid using the wiper blades to remove frost or ice from the windshield. Keep the blade rubber out of contact with petroleum products such as engine oil, gasoline, etc.

## Windshield And Rear Window Washers

The fluid reservoir for the windshield washers and the rear window washer (if equipped) is shared. The fluid reservoir is located in the engine compartment. Be sure to check the fluid level at regular intervals. Fill the reservoir with windshield washer solvent only (not radiator anti-freeze). When refilling the washer fluid reservoir, take some washer fluid and apply it to a cloth or towel and wipe clean the wiper blades, this will help blade performance.

To prevent freeze-up of your windshield washer system in cold weather, select a solution or mixture that meets or exceeds the temperature range of your climate. This rating information can be found on most washer fluid containers.

### WARNING!

**Commercial windshield washer solvents are flammable. They could ignite and burn you. Care must be exercised when filling or working around the washer solution.**

## Exhaust System

The best protection against carbon monoxide entry into the vehicle body is a properly maintained engine exhaust system.

If you notice a change in the sound of the exhaust system; or if the exhaust fumes can be detected inside the vehicle; or when the underside or rear of the vehicle is damaged; have an authorized technician inspect the complete exhaust system and adjacent body areas for broken, damaged, deteriorated, or mispositioned parts. Open seams or loose connections could permit exhaust fumes to seep

7

into the passenger compartment. In addition, inspect the exhaust system each time the vehicle is raised for lubrication or oil change. Replace as required.

## Cooling System

### WARNING!

**You or others can be badly burned by hot antifreeze/coolant or steam from your radiator. If you see or hear steam coming from under the hood, don't open the hood until the radiator has had time to cool. Never try to open a cooling system pressure cap when the radiator or coolant bottle is hot.**

## Engine Coolant Checks

Check antifreeze/coolant protection every 12 months (before the onset of freezing weather, where applicable). If antifreeze/coolant is dirty or rusty in appearance, the

system should be drained, flushed and refilled with fresh antifreeze/coolant. Check the front of the A/C condenser (if equipped) or radiator for any accumulation of bugs, leaves, etc. If dirty, clean by gently spraying water from a garden hose vertically down the face of the A/C condenser (if equipped) or the back of the radiator core.

Check the engine cooling system hoses for brittle rubber, cracking, tears, cuts, and tightness of the connection at the coolant recovery bottle and radiator. Inspect the entire system for leaks.

With the engine at normal operating temperature (but not running), check the cooling system pressure cap for proper vacuum sealing by draining a small amount of antifreeze/coolant from the radiator drain cock. If the cap is sealing properly, the antifreeze/coolant will begin to drain from the coolant recovery bottle. **DO NOT REMOVE THE COOLANT PRESSURE CAP WHEN THE COOLING SYSTEM IS HOT.**

### Cooling System — Drain, Flush, And Refill

The cooling system should be drained, flushed, and refilled, at the intervals shown on the Maintenance Schedule. Refer to Section 8 of this manual.

If the solution is dirty and contains a considerable amount of sediment, clean and flush with reliable cooling system cleaner. Follow with a thorough rinsing to remove all deposits and chemicals. Properly dispose of old antifreeze/coolant solution.

Discard old antifreeze/coolant solution according to recommended procedure.

### Selection Of Engine Coolant

Use only the manufacturer's recommended antifreeze/coolant. Refer to Fluids, Lubricants, and Genuine Parts in this section for correct antifreeze/coolant type.

### CAUTION!

- **Mixing of antifreeze/coolants other than the specified HOAT antifreeze/coolants, may result in engine damage and may decrease corrosion protection. If a non-HOAT antifreeze/coolant is introduced into the cooling system in an emergency, it should be replaced with the specified antifreeze/coolant as soon as possible.**
- **Do not use plain water alone or alcohol-base antifreeze/coolant products. Do not use additional rust inhibitors or antirust products, as they may not be compatible with the antifreeze/coolant and may plug the radiator.**
- **This vehicle has not been designed for use with Propylene Glycol based antifreeze/coolants. Use of Propylene Glycol base antifreeze/coolants is not recommended.**

## Adding Engine Coolant

Your vehicle has been built with an improved antifreeze/coolant that allows extended maintenance intervals. This antifreeze/coolant can be used up to 5 Years or 100,000 mi (160 000 km) before replacement. To prevent reducing this extended maintenance period, it is important that you use the same antifreeze/coolant throughout the life of your vehicle. Please review these recommendations for using Hybrid Organic Additive Technology (HOAT) antifreeze/coolant. When adding antifreeze/coolant:

- The manufacturer recommends using MOPAR® Antifreeze/Coolant 5 Year/100,000 Mile Formula HOAT (Hybrid Organic Additive Technology).
- Mix a minimum solution of 50% HOAT engine coolant and distilled water. Use higher concentrations (not to exceed 70%) if temperatures below -34°F (-37°C) are anticipated.

- Use only high purity water such as distilled or deionized water when mixing the water/engine coolant solution. The use of lower quality water will reduce the amount of corrosion protection in the engine cooling system.

Please note that it is the owner's responsibility to maintain the proper level of protection against freezing according to the temperatures occurring in the area where the vehicle is operated.

**NOTE:** Mixing antifreeze/coolant types will decrease the life of the antifreeze/coolant and will require more frequent antifreeze/coolant changes.

## Cooling System Pressure Cap

The cap must be fully tightened to prevent loss of antifreeze/coolant, and to ensure that antifreeze/coolant will return to the radiator from the coolant reserve tank.

The cap should be inspected and cleaned if there is any accumulation of foreign material on the sealing surfaces.

### WARNING!

The warning words **DO NOT OPEN HOT** on the cooling system pressure cap are a safety precaution. Never add antifreeze/coolant when the engine is overheated. Do not loosen or remove the cap to cool an overheated engine. Heat causes pressure to build up in the cooling system. To prevent scalding or injury, do not remove the pressure cap while the system is hot or under pressure.

### Disposal of Used Engine Coolant

Used ethylene glycol based antifreeze/coolant is a regulated substance requiring proper disposal. Check with your local authorities to determine the disposal rules for your community. To prevent ingestion by animals or

children, do not store ethylene glycol based antifreeze/coolant in open containers or allow it to remain in puddles on the ground. If ingested by a child, contact a physician immediately. Clean up any ground spills immediately.

### Engine Coolant Level

The coolant bottle provides a quick visual method for determining that the coolant level is adequate. With the engine idling, and warm to normal operating temperature, the level of the antifreeze/coolant in the bottle should be between the ranges indicated on the bottle.

The radiator normally remains completely full, so there is no need to remove the radiator cap unless checking for antifreeze/coolant freeze point or replacing antifreeze/coolant. Advise your service attendant of this. As long as the engine operating temperature is satisfactory, the coolant bottle need only be checked once a month.

When additional antifreeze/coolant is needed to maintain the proper level, it should be added to the coolant bottle. Do not overfill.

### Points To Remember

**NOTE:** When the vehicle is stopped after a few miles of operation, you may observe vapor coming from the front of the engine compartment. This is normally a result of moisture from rain, snow, or high humidity accumulating on the radiator and being vaporized when the thermostat opens, allowing hot antifreeze/coolant to enter the radiator.

If an examination of your engine compartment shows no evidence of radiator or hose leaks, the vehicle may be safely driven. The vapor will soon dissipate.

- Do not overfill the coolant bottle.
- Check antifreeze/coolant freeze point in the radiator and in the coolant recovery bottle. If antifreeze/

coolant needs to be added, contents of coolant recovery bottle must also be protected against freezing.

- If frequent antifreeze/coolant additions are required, or if the level in the recovery bottle does not drop when the engine cools, the cooling system should be pressure-tested for leaks.
- Maintain antifreeze/coolant concentration at 50% HOAT antifreeze/coolant (minimum) and distilled water for proper corrosion protection of your engine which contains aluminum components.
- Make sure that the radiator and coolant recovery bottle hoses are not kinked or obstructed.
- Keep the front of the radiator clean. If your vehicle is equipped with air conditioning, keep the front of the condenser clean, also.
- Do not change the thermostat for summer or winter operation. If replacement is ever necessary, install

ONLY the correct type thermostat. Other designs may result in unsatisfactory cooling performance, poor gas mileage, and increased emissions.

### Hoses and Vacuum/Vapor Harnesses

Inspect surfaces of hoses and nylon tubing for evidence of heat and mechanical damage. Hard or soft spots, brittle rubber, cracking, tears, cuts, abrasions, and excessive swelling indicate deterioration of the rubber.

Pay particular attention to the hoses nearest to high heat sources such as the exhaust manifold. Inspect hose routing to be sure hoses do not touch any heat source or moving component that may cause heat damage or mechanical wear.

Ensure nylon tubing in these areas has not melted or collapsed. Inspect all hose connections such as clamps and couplings to make sure they are secure and no leaks

are present. Components should be replaced immediately if there is any evidence of degradation that could cause failure.

### Brake System

In order to assure brake system performance, all brake system components should be inspected periodically. Refer to the Maintenance Schedule in Section 8 for suggested service intervals.

#### WARNING!

**Riding the brakes can lead to brake failure and possibly an accident. Driving with your foot resting or riding on the brake pedal can result in abnormally high brake temperatures, excessive lining wear, and possible brake damage. You wouldn't have your full braking capacity in an emergency.**



### Brake and Power Steering System Hoses

When servicing the vehicle for scheduled maintenance, inspect surface of hoses for evidence of heat and mechanical damage. Hard and brittle rubber, cracking, tears, cuts, abrasion, and excessive swelling suggest deterioration of the rubber. Particular attention should be made to examining those hose surfaces nearest to high heat sources, such as the exhaust manifold.

Inspect all hose clamps and couplings to make sure they are secure and no leaks are present.

**NOTE:** Inspection of brake hoses should be done whenever the brake system is serviced and every engine oil change.

#### WARNING!

**Worn brake hoses can burst and cause brake failure. You could have an accident. If you see any signs of cracking, scuffing, or worn spots, have the brake hoses replaced immediately.**

### Brake Master Cylinder — Brake Fluid Level Check

Refer to Fluids, Lubricants, and Genuine Parts in this section for the correct fluid type.

#### WARNING!

**Use of a brake fluid that may have a lower initial boiling point, or is unidentified as to specification, may result in sudden brake failure during hard prolonged braking. You could have an accident.**

Use only brake fluid that has been in a tightly closed container to avoid contamination from foreign matter or moisture.

### CAUTION!

Do not allow petroleum base fluid to contaminate the brake fluid. Seal damage will result.

## Automatic Transmission

### Selection of Lubricant

It is important that the proper lubricant is used in the transmission to assure optimum transmission performance. Use only manufacturer's recommended transmission fluid. Refer to Fluids, Lubricants, and Genuine Parts in this section for the correct fluid type. It is important that the transmission fluid be maintained at the prescribed level using the recommended fluid.

### CAUTION!

Using a transmission fluid other than the manufacturer's recommended fluid may cause deterioration in transmission shift quality and/or torque converter shudder. Using a transmission fluid other than the manufacturer's recommended fluid will result in more frequent fluid and filter changes. Refer to Fluids, Lubricants, and Genuine Parts in this section for the correct fluid type.

### Fluid Level Check — 42RLE

Check the fluid level while the transmission is at normal operating temperature 180° F (82° C). This occurs after at least 15 mi (25 km) of driving. At normal operating temperature the fluid cannot be held comfortably between the fingertips.

To properly check the automatic transmission fluid level, the following procedure must be used:

1. Operate the engine at idle speed and normal operating temperature.
2. The vehicle must be on level ground.
3. Fully apply parking brake.
4. Place the gear selector momentarily in each gear position ending with the lever in PARK.
5. Remove the dipstick, wipe it clean and reinsert it until seated.
6. Remove the dipstick again and note the fluid level on both sides. The fluid level should be between the HOT (upper) reference holes on the dipstick at normal operating temperature. Verify that a solid coating of oil is seen on both sides of the dipstick. If the fluid is low, add as required into the dipstick tube. **Do not overfill.** After

adding any quantity of oil through the dipstick tube, wait a minimum of two minutes for the oil to fully drain into the transmission before rechecking the fluid level.

**NOTE:** If it is necessary to check the transmission below the operating temperature, the fluid level should be between the two cold (lower) holes on the dipstick with the fluid at approximately 70° F (21° C) (room temperature). If the fluid level is correctly established at room temperature, it should be between the HOT (upper) reference holes when the transmission reaches 180° F (21° C). Remember it is best to check the level at the normal operating temperature.

**CAUTION!**

**Be aware that if the fluid temperature is below 50° F (10° C), it may not register on the dipstick. Do not add fluid until the temperature is elevated enough to produce an accurate reading.**

7. Check for leaks. Release the parking brake.

**NOTE:** To prevent dirt and water from entering the transmission after checking or replenishing fluid, make certain that the dipstick cap is properly reseated. It is normal for the dipstick cap to spring back slightly from its fully seated positions, as long as its seal remains engaged in the dipstick tube.

**Special Additives**

Automatic Transmission Fluid (ATF) is an engineered product and its performance may be impaired by supplemental additives. Therefore, do not add any fluid additives to the transmission. The only exception to this policy is the use of special dyes to aid in detecting fluid leaks. In addition, avoid using transmission sealers as they may adversely affect seals.

**Hydraulic Clutch Fluid — Manual Transmission**

The clutch hydraulic system is a sealed maintenance free system. In the event of leakage or other malfunction, the system must be replaced.

**Manual Transmission****Selection of Lubricant**

Use only manufacturer's recommended manual transmission fluid. Refer to Fluids, Lubricants, and Genuine Parts in this section for the correct fluid type.

### Fluid Level Check

Check the fluid level by removing the fill plug. The fluid level should be between the bottom of the fill hole and a point not more than 3/16 in (4.76 mm) below the bottom of the hole.

Add fluid, if necessary, to maintain the proper level.

### Frequency of Fluid Change

Under normal operating conditions, the fluid installed at the factory will give satisfactory lubrication for the life of the vehicle. Fluid changes are not necessary unless the lubricant has become contaminated with water. If contaminated with water, the fluid should be changed immediately.

### Transfer Case

#### Fluid Level Check

The fluid level should be to the bottom edge of the fill hole (A) when the vehicle is in a level position.

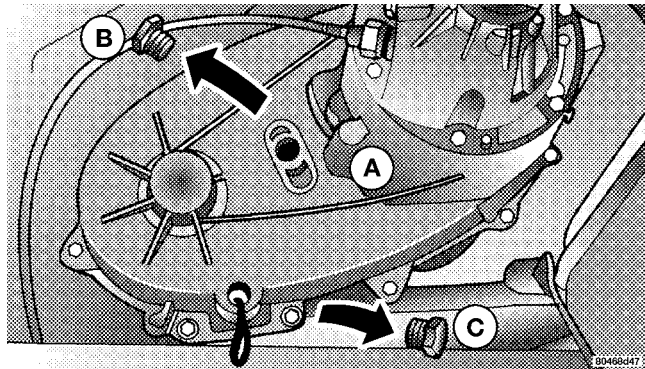

#### Adding Fluid

Fluid should be added only at filler hole until fluid begins to run out of the hole.

## Drain

First remove fill plug (B), then drain plug (C). Recommended tightening torque for drain and fill plugs is 15 to 25 ft lbs (20 to 34 N·m).

### CAUTION!

When replacing plugs, do not overtighten. You could damage them and cause them to leak.

## Selection of Lubricant

Use only manufacturer's recommended fluid. Refer to Fluids, Lubricants, and Genuine Parts in this section for the correct fluid type.

## Front/Rear Axle Fluid

### Fluid Level Check

Lubricant should be at bottom edge of the oil fill hole.

### Adding Fluid

Add lubricant only at the fill hole and only to the level specified above.

### Selection of Lubricant

Use only manufacturer's recommended fluid. Refer to Fluids, Lubricants, and Genuine Parts in this section for the correct fluid type.

## Maintenance After Off-Road Driving

After extended operation in mud, sand or water, or similar dirty conditions, have your brake drums, brake linings, and axle joints inspected and cleaned as soon as possible. This will prevent any abrasive material from causing excessive wear or unpredictable braking action.

Following off-road usage, completely inspect the underbody of your vehicle. Check tires, body structure, steering, suspension and exhaust system for damage. Check threaded fasteners for looseness, particularly on the chassis, drivetrain components, steering and suspension. Retighten, if required, to torque values specified in the Service Manual. Also check for accumulations of vegetation or brush that could become a fire hazard, or conceal damage to fuel lines, brake hoses, axle pinion seals, and propeller shafts. Check air conditioning drain tube on the lower dash wall in the engine compartment for mud or debris, and clean as required. A plugged tube will adversely affect air conditioning performance.

### CAUTION!

**Under frequent heavy-duty driving conditions, change all lubricants, and lubricate body components more often than in normal service to prevent excessive wear.**

## Appearance Care And Protection From Corrosion

### Protection Of Body And Paint From Corrosion

Vehicle body care requirements vary according to geographic locations and usage. Chemicals that make roads passable in snow and ice, and those that are sprayed on trees and road surfaces during other seasons, are highly corrosive to the metal in your vehicle. Outside parking, which exposes your vehicle to airborne contaminants, road surfaces on which the vehicle is operated, extreme



hot or cold weather and other extreme conditions will have an adverse effect on paint, metal trim, and underbody protection.

The following maintenance recommendations will enable you to obtain maximum benefit from the corrosion resistance built into your vehicle.

### What Causes Corrosion?

Corrosion is the result of deterioration or removal of paint and protective coatings from your vehicle.

The most common causes are:

- Road salt, dirt and moisture accumulation.
- Stone and gravel impact.
- Insects, tree sap and tar.
- Salt in the air near sea-coast localities.
- Atmospheric fallout/industrial pollutants.

- Bird droppings.

### Washing

- Wash your vehicle regularly. Always wash your vehicle in the shade using MOPAR® Car Wash or a mild car wash soap, and rinse the panels completely with clear water.
- If insects, tar, or other similar deposits have accumulated on your vehicle, use MOPAR® Super Kleen Bug and Tar Remover to remove.
- Use MOPAR® Cleaner Wax to remove road film, stains, and to protect your paint finish. Take care never to scratch the paint.
- Avoid using abrasive compounds and power buffing that may diminish the gloss or thin out the paint finish.



**CAUTION!**

- Do not use abrasive or strong cleaning materials such as steel wool or scouring powder, which will scratch metal and painted surfaces.
- Use of power washers exceeding 1,200 psi (8 274 kPa) can result in damage or removal of paint and decals.

**Special Care**

- If you drive on salted or dusty roads or if you drive near the ocean, hose off the undercarriage at least once a month.
- It is important that the drain holes in the lower edges of the doors, rocker panels and tailgate must be kept clear and open.

- If you detect any stone chips or scratches in the paint, touch them up immediately. The cost of such repairs is considered the responsibility of the owner.
- If your vehicle is damaged due to an accident or similar cause which destroys the paint and protective coating have your vehicle repaired as soon as possible. The cost of such repairs is considered the responsibility of the owner.
- If you carry special cargo such as chemicals, fertilizers, de-icer salt, etc., assure that such materials are well packaged and sealed.
- If a lot of driving is done on gravel roads, consider installing mud or stone shields behind each wheel.
- Use MOPAR® Touch-Up Paint on scratches or chips as soon as possible. Your authorized dealer has touch-up paint to match the color of your vehicle.

### Wheel and Wheel Trim Care

All wheels and wheel trim, especially aluminum and chrome plated wheels should be cleaned regularly with a mild soap and water to prevent corrosion. To remove heavy soil, use MOPAR® Wheel Cleaner or select a nonabrasive, non-acidic cleaner. Do not use scouring pads, steel wool, a bristle brush or metal polishes. Only MOPAR® cleaners are recommended. Do not use oven cleaner. Avoid automatic car washes that use acidic solutions or harsh brushes that may damage the wheels' protective finish.

### YES Essentials® Fabric Cleaning Procedure – If Equipped

YES Essentials® seats may be cleaned in the following manner:

- Remove as much of the stain as possible by blotting with a clean, dry towel.
- Blot any remaining stain with a clean, damp towel.

- For tough stains, apply MOPAR® Total Clean or a mild soap solution to a clean, damp cloth and remove stain. Use a fresh, damp towel to remove soap residue.
- For grease stains, apply MOPAR® Multi-Purpose Cleaner to a clean, damp cloth and remove stain. Use a fresh, damp towel to remove soap residue.
- Do not use any solvents or protectants on Yes Essentials® products.

### Interior Care

Use MOPAR® Total Clean to clean fabric upholstery and carpeting.

Interior Trim should be cleaned starting with a damp cloth, a damp cloth with MOPAR® Total Clean, then MOPAR® Spot & Stain Remover if absolutely necessary. Do not use harsh cleaners or Armorall. Use MOPAR® Total Clean to clean vinyl upholstery.

**WARNING!**

**Do not use volatile solvents for cleaning purposes. Many are potentially flammable, and if used in closed areas they may cause respiratory harm.**

**CAUTION!**

**When installing hanging air fresheners in your vehicle, read the installation instructions carefully. Some air fresheners will damage the finish of painted or decorated parts if allowed to directly contact any surface.**

**Glass Surfaces**

All glass surfaces should be cleaned on a regular basis with MOPAR® Glass Cleaner or any commercial

household-type glass cleaner. Never use an abrasive type cleaner. Use caution when cleaning inside rear windows equipped with electric defrosters. Do not use scrapers or other sharp instruments which may scratch the elements.

When cleaning the rearview mirror, spray cleaner on the towel or rag that you are using. Do not spray cleaner directly on the mirror.

**Cleaning Plastic Instrument Cluster Lenses**

The lenses in front of the instruments in this vehicle are molded in clear plastic. When cleaning the lenses, care must be taken to avoid scratching the plastic.

1. Clean with a wet soft rag. A mild soap solution may be used, but do not use high alcohol content or abrasive cleaners. If soap is used, wipe clean with a clean damp rag.
2. Dry with a soft tissue.

### Seat Belt Maintenance

Do not bleach, dye or clean the belts with chemical solvents or abrasive cleaners. This will weaken the fabric. Sun damage will also weaken the fabric.

If the belts need cleaning, use MOPAR® Total Clean, a mild soap solution, or lukewarm water. Do not remove the belts from the vehicle to wash them.

Replace the belts if they appear frayed or worn or if the buckles do not work properly.

### Appearance Care For Fabric Top Models

#### CAUTION!

To maintain the appearance of your vehicle's interior trim and top, follow these precautions:

- Avoid leaving your vehicle unattended with the top down, as exposure to sun or rain may damage interior trim.
- Do not use harsh cleaners or bleaching agents on top material, as damage may result.
- Do not allow any vinyl cleaner to run down and dry on the paint, leaving a streak.
- After cleaning your vehicle's fabric top, always make sure it is completely dry before lowering.
- Be especially careful when washing the windows by following the directions for "Care of Fabric Top Windows."

**WASHING** — Use MOPAR® Car Wash or mild soap suds, lukewarm water, and a brush with soft bristles. If extra cleaning is required, use MOPAR® Convertible Cloth Top Cleaner or a mild foaming cleaner on the entire top, but support top from underneath.

**RINSING** — Be sure to remove all trace of cleaner by rinsing the top thoroughly with clean water. Remember to allow the top to dry before lowering it.

### Care Of Fabric Top Windows

#### CAUTION!

Your vehicle's fabric top has pliable plastic windows which can be scratched unless special care is taken by following these directions:

1. Never use a dry cloth to remove dust. Instead, **use a microfiber towel or soft cotton cloth moistened with cold or warm, clean water, and wipe across the window, not up and down.** MOPAR® Jeep Soft Glass Window Cleaner will safely clean all plastic windows without scratching. Removes fine scratches to improve visibility and provide UV protection to help prevent yellowing.

2. When washing, **never use hot water** or anything stronger than a mild soap. Never use solvents such as alcohol or harsh cleaning agents.

3. Always rinse thoroughly with cold water, then wipe with a soft and slightly moist, clean cloth.

4. When removing frost, snow or ice, **never use a scraper or de-icing chemicals.** Use warm water only if you must clean the window quickly.

5. Debris (sand, mud/dirt, dust, or salt) from off-road driving will have a major impact on zipper operation. Even normal on-road driving and vehicle washing will eventually impact window zipper operation. To maintain ease of use of the window zippers, each window zipper should be cleaned and lubricated regularly. Use MOPAR® Soft Top Zipper Cleaner and Lubricant to ease zipper operation. Before applying, make sure the zipper teeth are clear of sand, mud, and other materials. Clean both sides of the zipper, not just one side. Rinse both

zipper halves with fresh water and allow to dry. Aggressively work the MOPAR® Soft Top Zipper Cleaner and Lubricant into the zipper teeth. If a stuck zipper slide is experienced, work the MOPAR® Soft Top Zipper Cleaner and Lubricant into the zipper slide. Several applications may be required before the zipper comes free.

6. Never paste stickers, gummed labels or any tape to the windows. Adhesives are hard to remove and may damage the windows.

## FUSES (TOTALLY INTEGRATED POWER MODULE)

The Totally Integrated Power Module (TIPM) is located in the engine compartment near the battery. This center contains cartridge fuses, mini fuses and relays. A label that identifies each component is printed on the inside of the cover.

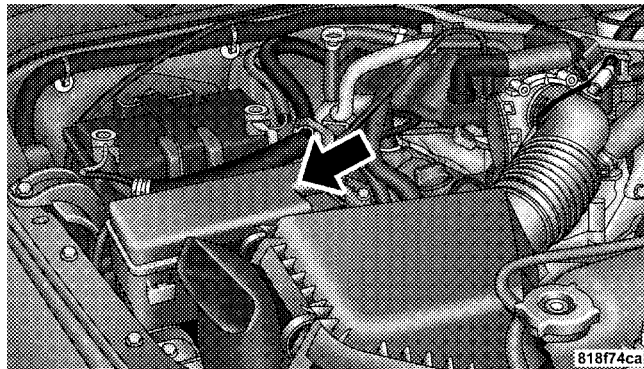

Integrated Power Module (TIPM)

Cavity	Cartridge Fuse	Mini Fuse	Description
J1	—		—
J2	30 Amp Pink		Transfer Case Module
J3	—		—

Cavity	Cartridge Fuse	Mini Fuse	Description
J4	25 Amp Natural		Driver Door Node
J5	25 Amp Natural		Passenger Door Node
J6	40 Amp Green		Anti-Lock Brake System (ABS) Pump Feed/ESP
J7	30 Amp Pink		Anti-Lock Brake System (ABS) Valve Feed/ESP
J8	—		—
J9	40 Amp Green		PZEV Sec Motor Feed/ Flex Fuel
J10	30 Amp Pink		Headlamp Wash Relay/ Manifold Tuning Valve
J11	30 Amp Pink		Sway Bar

Cavity	Cartridge Fuse	Mini Fuse	Description
J13	60 Amp Yellow		Ignition Off Draw (IOD) — Main
J14	40 Amp Green		EBL (Rear Window De-fogger)
J15	30 Amp Pink		Rear Blower
J17	40 Amp Green		Starter Solenoid
J18	20 Amp Yellow		Powertrain Control Module (PCM) Trans Range
J19	60 Amp Yellow		Radiator Fan
J20	30 Amp Pink		Front Wiper LO/HI

Cavity	Cartridge Fuse	Mini Fuse	Description
J21	20 Amp Yellow		Front/Rear Washer
J22	—		Spare
M1		15 Amp Blue	Center High-Mounted Stop Light (CHMSL)/ Switch Stop Lamp Feed
M2		20 Amp Yellow	Relay Trailer Lighting (Stop)
M3		20 Amp Yellow	Frt/Rear Axle Locker Relay
M4		—	—
M5		—	—
M6		20 Amp Yellow	Power Outlet #1/Rain Sensor
M7		20 Amp Yellow	Power Outlet #2 (BATT/ACC SELECT)

Cavity	Cartridge Fuse	Mini Fuse	Description
M8		20 Amp Yellow	Front Heated Seat
M9		20 Amp Yellow	Rear Heated Seat (If Equipped)
M10		20 Amp Yellow	Ignition Off Draw — Vehicle Entertainment System (IOD-VES), Satellite Digital Audio Receiver (SDARS), DVD, Hands-Free Module (HFM), RADIO, Antenna (ANT), Universal Garage Door Opener (UGDO), Vanity Lamp (VANITY LP)



Cavity	Cartridge Fuse	Mini Fuse	Description
M11		10 Amp Red	(Ignition Off Draw) IOD-HVAC/ATC, MW SENSR, Underhood Lamp (UH LMP)
M12		30 Amp Green	Amplifier (AMP)
M13		20 Amp Yellow	Ignition Off Draw— Cabin Compartment Node (IOD-CCN), Wireless Control Mod- ule (WCM), SIREN, Multifunction Control Switch (MULTIFCTN SW)
M14		20 Amp Yellow	Trailer Tow (Export Only)

Cavity	Cartridge Fuse	Mini Fuse	Description
M15		20 Amp Yellow	COL MOD, IR SNS, Heater Ventilation, Air Conditioning/ Automatic Temperature Control (HVAC/ATC), Rear View Mirror (RR VW MIR), Cabin Com- partment Node (CCN), Transfer Case Switch (T-CASE SW), RUN/ST, Multi-Function Control Switch (MULTIFCTN SW), Tire Pressure Monitor (TPM), Glow Plug Module (GLW PLG MOD) — Export Diesel Only

Cavity	Cartridge Fuse	Mini Fuse	Description
M16		10 Amp Red	Occupant Restraint Controller (ORC)
M17		15 Amp Blue	Left Tail/License/Park Lamp (LT-TAIL/LIC/PRK LMP)
M18		15 Amp Blue	Right Tail/Park/Run Lamp (RT-TAIL/PRK/RUN LMP)
M19		25 Amp Natural	Auto Shut Down (ASD #1 and #2)
M20		15 Amp Blue	Cabin Compartment Node Interior Light (CCN INT LIGHT), Switch Bank (SW BANK)
M21		20 Amp Yellow	Auto Shut Down (ASD #3)

Cavity	Cartridge Fuse	Mini Fuse	Description
M22		10 Amp Red	Right Horn (RT HORN (HI/LOW)
M23		10 Amp Red	Left Horn (LT HORN (HI/LOW)
M24		25 Amp Natural	Rear Wiper (REAR WIPER)
M25		20 Amp Yellow	Fuel Pump (FUEL PUMP), Diesel Lift Pump (DSL LIFT PUMP) — Export Only
M26		—	—
M27		10 Amp Red	Ignition Switch Feed, Wireless Module
M28		10 Amp Red	PCM Feed/TCM
M29		—	—

Cavity	Cartridge Fuse	Mini Fuse	Description
M30		15 Amp Blue	Wiper Motor Frt, J1962 Diagnostic Feed
M31		20 Amp Yellow	Backup Lamps (B/U LAMPS)
M32		10 Amp Red	Occupant Restraint Controller (ORC), TT EUROPE
M33		10 Amp Red	Next Generation Con- troller (NGC), Global Powertrain Engine Controller (GPEC)
M34		10 Amp Red	Park Assist (PRK ASST), Heater Ventilation, Air Conditioning Module (HVAC MOD), Headlamp Wash (HDLP WASH), Compass (COMPAS)

Cavity	Cartridge Fuse	Mini Fuse	Description
M35		10 Amp Red	Heated Mirrors
M36		20 Amp Yellow	Power Outlet
M37		10 Amp Red	Anti-Lock Brake System (ABS), Electronic Stabil- ity Program (ESP), Stop Lamp Switch (STP LP SW), Fuel Pump Rly Hi Control
M38		25 Amp Natural	Lock/Unlock Motors (LOCK/UNLOCK MTRS)

**CAUTION!**

- When installing the Integrated Power Module cover, it is important to ensure the cover is properly positioned and fully latched. Failure to do so may allow water to get into the Integrated Power Module, and possibly result in an electrical system failure.
- When replacing a blown fuse, it is important to use only a fuse having the correct amperage rating. The use of a fuse with a rating other than indicated may result in a dangerous electrical system overload. If a properly rated fuse continues to blow, it indicates a problem in the circuit that must be corrected.

**VEHICLE STORAGE**

If you are leaving your vehicle dormant for more than 21 days you may want to take steps to protect your battery. You may:

- Remove Cartridge fuse #15 in the Power Distribution Center labeled Ignition-Off Draw (IOD).
- Store the removed IOD fuse in the Power Distribution Center location #11 labeled "IOD Storage."
- Or, disconnect the negative cable from the battery.
- Anytime you store your vehicle, or keep it out of service (i.e., vacation) for two weeks or more, run the air conditioning system at idle for about five minutes in the fresh air and high blower setting. This will ensure adequate system lubrication to minimize the possibility of compressor damage when the system is started again.

**REPLACEMENT BULBS — IF EQUIPPED**

<b>Interior Lights</b>	<b>Bulb Type</b>
Auto. Trans. Indicator Light . . . . .	658
Courtesy Lights, Under Dash (1). . . . .	906
Heater Control Lights (2) . . . . .	194
Rocker Switch Indicator Light (Rear Window Defogger, and Rear Wash/Wipe). . . . .	**
Soundbar Dome Light . . . . .	912

\*\* Bulbs only available from authorized dealer.

<b>Exterior Lights</b>	<b>Bulb Type</b>
Backup Lights (2). . . . .	3157
Center High-Mounted Stop Light (1) . . . . .	L.E.D.
Fog Lights. . . . .	9145
Front Park/Turn Lights (2) . . . . .	3157
Front Side Marker Lights (2). . . . .	168
Headlights (2) . . . . .	H13
Stop/Tail/Turn Lights (2) . . . . .	3157
Underhood Light. . . . .	561
License Light . . . . .	194

**NOTE:** Numbers refer to commercial bulb types that can be purchased from your local authorized dealer.

If a bulb needs to be replaced, visit your authorized dealer or refer to the applicable Service Manual.

**BULB REPLACEMENT**

**NOTE:** Lens fogging can occur under certain atmospheric conditions. This will usually clear as atmospheric conditions change to allow the condensation to change back into a vapor. Turning the lamps on will usually accelerate the clearing process.

**Head Light**

1. Open hood and support using prop rod.
2. Remove the front grille. Turn the retainers along the top 1/4 turn counterclockwise and remove.
3. Pull the bottom of the grille away starting at one side and working toward the other.

4. Turn both park and turn signal socket assemblies 1/4 turn counterclockwise and remove.
5. Remove the four screws holding the metal retaining ring.
6. Remove the lamp from the collar.
7. Grasp the bulb and turn 1/4 turn counterclockwise.
8. Pull the bulb from the housing.
9. Push connector locking tab to the unlock position.
10. Remove connector from bulb.
11. Push connector onto new bulb base, and push the connector locking tab to the lock position.

### CAUTION!

**Do not touch the new bulb with your fingers. Oil contamination will severely shorten bulb life. If the bulb comes in contact with any oily surface, clean the bulb with rubbing alcohol.**

12. Reinstall bulb housing. Rotate the bulb 1/4 turn clockwise.

### Front Park/Turn Signal

1. Remove the front grille. Turn the retainers along the top 1/4 turn counterclockwise and remove.
2. Pull the bottom of the grille away starting at one side and working toward the other.

3. Turn the socket assembly 1/4 turn counterclockwise and remove from housing. Pull the bulb straight from the socket to replace.

### Front Side Marker

1. Reach under the front fender flare and locate the front side marker socket.
2. Turn the socket assembly counterclockwise 1/3 turn and remove it from the housing. Pull the bulb straight from the socket to replace.

### Front Fog Light

1. Locate the front fog lamp in the front fascia, and disconnect the electrical connector from underneath.
2. Turn the bulb 1/4 turn counterclockwise.

### CAUTION!

**Do not touch the new bulb with your fingers. Oil contamination will severely shorten bulb life. If the bulb comes in contact with any oily surface, clean the bulb with rubbing alcohol.**

### Rear Tail, Stop, Turn Signal, and Backup Lights

1. Remove the two inboard screws attaching the tail light housing to the body. **DO NOT REMOVE THE OUTER SCREWS AT ANY TIME.**

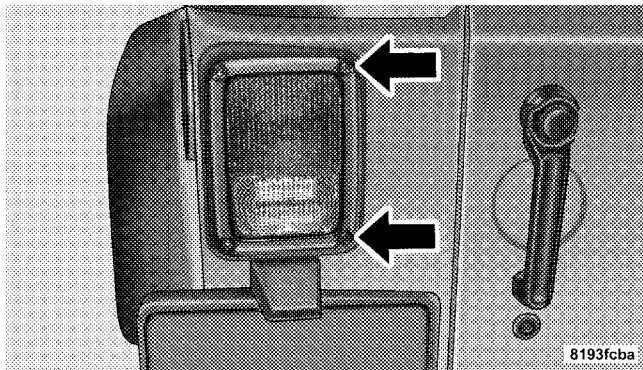

2. Separate the housing from the body by pushing the lamp inboard while pulling the lamp away from the body.
3. Rotate the appropriate socket 1/4 turn counterclockwise, then remove it from the housing.

4. Pull the bulb straight from the socket to replace.

### Center High-Mounted Stop Light (CHMSL)

The stop lamp is mounted on a bracket that extends upward from the tailgate behind the spare tire. If service is needed, obtain the LED/Cover Assembly from your local authorized dealer.

1. Remove the spare tire.
2. Remove the four screws holding the lens/cover in place on the spare tire carrier.
3. Disconnect the wire harness from the back of the LED cover.



**FLUID CAPACITIES**

	<b>U.S.</b>	<b>Metric</b>
<b>Fuel (Approximate) — 2-Door Models</b>	18.5 Gallons	70 Liters
<b>Fuel (Approximate) — 4-Door Models</b>	22.5 Gallons	85 Liters
<b>Engine Oil with Filter</b>		
3.8 Liter Engine (SAE 5W-20, API Certified Engine Oil)	6 Quarts	5.7 Liters
<b>Cooling System *</b>		
3.8 Liter Engine (MOPAR® Antifreeze/Engine Coolant 5 Year/ 100,000 Mile Formula)	13 Quarts	12 Liters

\* Includes heater and coolant recovery bottle filled to MAX level.

## FLUIDS, LUBRICANTS AND GENUINE PARTS

### Engine

Component	Fluid, Lubricant, or Genuine Part
Engine Coolant	MOPAR® Antifreeze/Coolant 5 Year/100,000 Mile Formula HOAT (Hybrid Organic Additive Technology)
Engine Oil	Use API Certified SAE 5W-20 Engine Oil, meeting the requirements of DaimlerChrysler Material Standard MS-6395. Refer to your engine oil filler cap for correct SAE grade.
Spark Plugs (3.8L Engine)	RE14PLP5 (Gap 0.050 in [1.27 mm])
Oil Filter (3.8L Engine)	MOPAR® Oil Filter (P/N 04105409AC)
Fuel Selection	87 Octane

## Chassis

Component	Fluid, Lubricant, or Genuine Part
Automatic Transmission	MOPAR® ATF+4 Automatic Transmission Fluid
Manual Transmission	MOPAR® Manual Transmission Lubricant or equivalent (meeting the requirements of DaimlerChrysler Material Standard MS-9224)
Transfer Case	MOPAR® ATF+4 Automatic Transmission Fluid or equivalent.
Axle Differential (Front)	MOPAR® Gear & Axle Lubricant (SAE 80W-90) (API GL-5) or equivalent.
Axle Differential (Rear)	<b>198 RBI (Model 35) and 226 RBI (Model 44)</b> - MOPAR® Gear & Axle Lubricant (SAE 80W-90) (API GL-5) or equivalent. For trailer towing, use MOPAR® Synthetic Gear & Axle Lubricant (SAE 75W-140) or equivalent. Models equipped with Trac-Lok™ require an additive.
Brake Master Cylinder	MOPAR® DOT 3 Brake Fluid, SAE J1703 should be used. If DOT 3, SAE J1703 brake fluid is not available, then DOT 4 is acceptable. Use only recommended brake fluids.
Power Steering Reservoir	MOPAR® ATF+4 Automatic Transmission Fluid

# MAINTENANCE SCHEDULES

## CONTENTS

---

■ Emissions Control System Maintenance . . . . .	428	□ Required Maintenance Intervals . . . . .	431
■ Maintenance Schedule . . . . .	428		

## EMISSIONS CONTROL SYSTEM MAINTENANCE

The Scheduled Maintenance services listed in **bold type** must be done at the times or mileages specified to ensure the continued proper functioning of the emission control system. These, and all other maintenance services included in this manual, should be done to provide best vehicle performance and reliability. More frequent maintenance may be needed for vehicles in severe operating conditions, such as dusty areas and very short trip driving.

Inspection and service should also be done any time a malfunction is suspected.

**NOTE:** Maintenance, replacement, or repair of the emissions control devices and systems on your vehicle may be performed by any automotive repair establishment or individual using any automotive part that has been certified pursuant to U.S. EPA or, in the State of California, California Air Resources Board regulations.

## MAINTENANCE SCHEDULE

The oil change indicator system will remind you that it is time to take your vehicle in for scheduled maintenance.

On Non-EVIC equipped vehicles “CHANG<sup>E</sup> OIL” will flash in the instrument cluster odometer and a single chime will sound, indicating that an oil change is necessary.

Based on engine operation conditions the oil change indicator message will illuminate, this means that service is required for your vehicle. Have your vehicle serviced as soon as possible, within the next 500 mi (805 km).

### NOTE:

- The oil change indicator message will not monitor the time since the last oil change. Change your vehicles oil if it has been 6 months since your last oil change even if the oil change indicator message is NOT illuminated.

- Change your engine oil more often if you drive your vehicle off-road for an extended period of time.
- Under no circumstances should oil change intervals exceed 6,000 mi (10,000 km) or 6 months, whichever comes first.

Your dealer will reset the oil change indicator message after completing the scheduled oil change. If this scheduled oil change is performed by someone other than your dealer the message can be reset by referring to the steps described under “Odometer/Trip Odometer” in the “Instrument Cluster Description” section of this manual.

#### *At Each Stop for Fuel*

- Check the engine oil level about 5 minutes after a fully warmed engine is shut off. Checking the oil level while the vehicle is on level ground will improve the accuracy of the oil level reading. Add oil only when the level is at or below the ADD or MIN mark.

- Check the windshield washer solvent and add if required.

#### *Once a Month*

- Check tire pressure and look for unusual wear or damage.
- Inspect the battery and clean and tighten the terminals as required.
- Check the fluid levels of coolant reservoir, brake master cylinder, power steering and transmission and add as needed.
- Check all lights and other electrical items for correct operation.

## 430 MAINTENANCE SCHEDULES

*At Each Oil Change*

- Change the engine oil filter.
- Inspect the brake hoses and lines.
- Check the manual transmission fluid level.

**CAUTION!**

**Failure to perform the required maintenance items may result in damage to the vehicle.**



Information Provided by:

**DEALER**  
E-PROCESS

### Required Maintenance Intervals

Maintenance Items	Perform Maintenance Every (Where time and mileage are listed, follow the interval that occurs first.)		
	Miles	Kilometers	or Months
Change the engine oil and engine oil filter.	6,000	10 000	6
Rotate tires.	6,000	10 000	6
If using your vehicle for any of the following: Dusty or off-road conditions. Inspect the engine air cleaner filter, replace if necessary.	12,000	20 000	12
Inspect the brake linings, replace if necessary.	12,000	20 000	12
Replace the air conditioning filter.	12,000	20 000	12
Inspect the front & rear axle fluid, change if using your vehicle for police, taxi, fleet, off-road or frequent trailer towing.	18,000	30 000	18
Inspect the CV joints. Perform the first inspection at 12,000 mi (20 000 km) or 12 months.	24,000	40 000	24
Inspect exhaust system. Perform the first inspection at 12,000 mi (20 000 km) or 12 months.	24,000	40 000	24



## 432 MAINTENANCE SCHEDULES

Maintenance Items	Perform Maintenance Every (Where time and mileage are listed, follow the interval that occurs first.)		
	Miles	Kilometers	or Months
Inspect the front suspension, tie rod ends and boot seals, replace if necessary.	24,000	40 000	24
Replace the engine air cleaner filter.	30,000	50 000	30
Change the manual transmission fluid if using your vehicle for any of the following: trailer towing, snow plowing, heavy loading, taxi, police, delivery service (commercial service), off-road, desert operation or more than 50% of your driving is at sustained high speeds during hot weather, above 90°F (32°C).	30,000	50 000	30
Inspect the transfer case fluid.	30,000	50 000	30
Change the automatic transmission fluid and main sump filter if using your vehicle for any of the following: police, taxi, fleet or frequent trailer towing.	60,000	100 000	60

Maintenance Items	Perform Maintenance Every (Where time and mileage are listed, follow the interval that occurs first.)		
	Miles	Kilometers	or Months
Change the transfer case fluid if using your vehicle for any of the following: police, taxi, fleet, off-road or frequent trailer towing.	60,000	100 000	60
<b>Inspect and replace PCV valve if necessary.</b>	90,000	150 000	90
Flush and replace the engine coolant.	102,000	170 000	60
<b>Replace the ignition cables.</b>	102,000	170 000	102
<b>Replace the spark plugs.</b>	102,000	170 000	102
Change the automatic transmission fluid, and filter(s).	120,000	200 000	120
Replace accessory drive belt(s).	120,000	200 000	120

**WARNING!**

You can be badly injured working on or around a motor vehicle. Do only that service work for which you have the knowledge and the right equipment. If you have any doubt about your ability to perform a service job, take your vehicle to a competent mechanic.



Information Provided by:

**DEALER**  
e-PROCESS

# IF YOU NEED CONSUMER ASSISTANCE

## CONTENTS

■ Suggestions For Obtaining Service For Your Vehicle . . . . .	437	□ In Mexico Contact . . . . .	438
□ Prepare For The Appointment . . . . .	437	□ Customer Assistance For The Hearing Or Speech Impaired (TDD/TTY) . . . . .	439
□ Prepare A List . . . . .	437	□ Service Contract . . . . .	439
□ Be Reasonable With Requests . . . . .	437	■ Warranty Information (U.S. Vehicles Only) . . . . .	440
■ If You Need Assistance . . . . .	437	■ MOPAR® Parts . . . . .	440
□ DaimlerChrysler Motors Corporation Customer Center . . . . .	438	■ Reporting Safety Defects . . . . .	440
□ DaimlerChrysler Canada Inc. Customer Center . . . . .	438	□ In The 50 United States And Washington, D.C. . . . .	440
		□ In Canada . . . . .	441

■ Publication Order Forms . . . . .	441	□ Traction Grades . . . . .	443
■ Department Of Transportation Uniform Tire Quality Grades . . . . .	442	□ Temperature Grades . . . . .	444
□ Treadwear . . . . .	443		

## SUGGESTIONS FOR OBTAINING SERVICE FOR YOUR VEHICLE

### Prepare For The Appointment

If you're having warranty work done, be sure to have the right papers with you. Take your warranty folder. All work to be performed may not be covered by the warranty. Discuss additional charges with the service manager. Keep a maintenance log of your vehicle's service history. This can often provide a clue to the current problem.

### Prepare A List

Make a written list of your vehicle's problems or the specific work you want done. If you've had an accident or work done that is not on your maintenance log, let the service advisor know.

### Be Reasonable With Requests

If you list a number of items and you must have your vehicle by the end of the day, discuss the situation with the service advisor and list the items in order of priority. At many authorized dealers, you may obtain a rental vehicle at a minimal daily charge. If you need a rental, it is advisable to make these arrangements when you call for an appointment.

## IF YOU NEED ASSISTANCE

The manufacturer and its authorized dealers are vitally interested in your satisfaction. We want you to be happy with our products and services.

Warranty service must be done by an authorized dealer. We strongly recommend that you take your vehicle to your authorized selling dealer. They know you and your vehicle best, and are most concerned that you get prompt and high quality service. The manufacturer's authorized dealers have the facilities, factory-trained technicians,

special tools, and the latest information to ensure your vehicle is fixed correctly and in a timely manner.

This is why you should always talk to your authorized dealer's service manager first. Most matters can be resolved with this process.

- If for some reason you are still not satisfied, talk to the general manager or owner of the authorized dealership. They want to know if you need assistance.
- If your authorized dealership is unable to resolve the concern, you may contact the Manufacturer's Customer Center.

Any communication to the Manufacturer's Customer Center should include the following information:

- Owner's name and address
- Owner's telephone number (home and office)
- Authorized dealership name

- Vehicle Identification Number (VIN)
- Vehicle delivery date and mileage

**DaimlerChrysler Motors Corporation Customer Center**

P.O. Box 21-8004

Auburn Hills, MI 48321-8004

Phone: (800) 992-1997

**DaimlerChrysler Canada Inc. Customer Center**

P.O. Box 1621

Windsor, Ontario N9A 4H6

Phone: (800) 465-2001

**In Mexico contact:**

Av. Prolongacion Paseo de la Reforma, 1240

Sante Fe C.P. 05109

Mexico, D. F.

In Mexico City: 5081-4568

Outside Mexico City: 1-800-505-1300

## Customer Assistance For The Hearing Or Speech Impaired (TDD/TTY)

To assist customers who have hearing difficulties, the manufacturer has installed special TDD (Telecommunication Devices for the Deaf) equipment at its Customer Center. Any hearing or speech impaired customer, who has access to a TDD or a conventional teletypewriter (TTY) in the United States, can communicate with the manufacturer by dialing 1-800-380-CHRY.

## Service Contract

You may have purchased a service contract for your vehicle to help protect you from the high cost of unexpected repairs after your manufacturer's New Vehicle Limited Warranty expires. The manufacturer stands behind only the manufacturer's Service Contracts. If you purchased a manufacturer's Service Contract, you will receive Plan Provisions and an Owner Identification Card in the mail within three weeks of your vehicle delivery date. If you have any questions about your service

contract, call the manufacturer's Service Contract National Customer Hotline at 1-800-521-9922.

The manufacturer will not stand behind any service contract that is not the manufacturer's Service Contract. It is not responsible for any service contract other than the manufacturer's Service Contract. If you purchased a service contract that is not a manufacturer's Service Contract, and you require service after your manufacturer's New Vehicle Limited Warranty expires, please refer to your contract documents, and contact the person listed in those documents.

We appreciate that you have made a major investment when you purchased your vehicle. Your authorized dealer has also made a major investment in facilities, tools, and training to assure that you are absolutely delighted with your ownership experience. You'll be pleased with their sincere efforts to resolve any warranty issues or related concerns.



**WARNING!**

Engine exhaust, some of its constituents, and certain vehicle components contain, or emit, chemicals known to the State of California to cause cancer and birth defects or other reproductive harm. In addition, certain fluids contained in vehicles and certain products of component wear contain, or emit, chemicals known to the State of California to cause cancer and birth defects or other reproductive harm.

**WARRANTY INFORMATION (U.S. Vehicles Only)**

See the Warranty Information Booklet for the terms and provisions of DaimlerChrysler's warranties applicable to this vehicle.

**MOPAR® PARTS**

MOPAR® fluids, lubricants, parts, and accessories are available from your authorized dealer. They will help you keep your vehicle operating at its best.

**REPORTING SAFETY DEFECTS****In The 50 United States And Washington, D.C.**

If you believe that your vehicle has a defect that could cause a crash or cause injury or death, you should immediately inform the National Highway Traffic Safety Administration (NHTSA) in addition to notifying the manufacturer.

If NHTSA receives similar complaints, it may open an investigation, and if it finds that a safety defect exists in a group of vehicles, it may order a recall and remedy campaign. However, NHTSA cannot become involved in individual problems between you, your authorized dealer, and the manufacturer.

To contact NHTSA, you may either call the Auto Safety Hotline toll free at 1-888-327-4236 (TTY: 1-800-424-9153), or go to <http://www.safercar.gov>; or write to: Administrator, NHTSA, 400 Seventh Street, SW., Washington, D.C. 20590. You can also obtain other information about motor vehicle safety from <http://www.safercar.gov>.

### In Canada

If you believe that your vehicle has a safety defect, you should contact the Customer Service Department immediately. Canadian customers who wish to report a safety defect to the Canadian government should write to: Transport Canada, Motor Vehicle Defect Investigations and Recalls, 2780 Sheffield Road, Ottawa, Ontario K1B 3V9.

### PUBLICATION ORDER FORMS

To order the following manuals, you may use either the website or the phone numbers listed below. Visa, Mastercard, American Express, and Discover orders are accepted. If you prefer mailing your payment, please call for an order form.

**NOTE:** A street address is required when ordering manuals (no P.O. Boxes).

- *Service Manuals*

These comprehensive Service Manuals provide the information that students and professional technicians need in diagnosing/troubleshooting, problem solving, maintaining, servicing, and repairing DaimlerChrysler Corporation vehicles. A complete working knowledge of the vehicle, system, and/or components is written in straightforward language with illustrations, diagrams, and charts.

- *Diagnostic Procedure Manuals*

Diagnostic Procedure Manuals are filled with diagrams, charts and detailed illustrations. These practical manuals make it easy for students and technicians to find and fix problems on computer-controlled vehicle systems and features. They show exactly how to find and correct problems the first time, using step-by-step troubleshooting and drivability procedures, proven diagnostic tests and a complete list of all tools and equipment.

- *Owner's Manuals*

These Owner's Manuals have been prepared with the assistance of service and engineering specialists to acquaint you with specific DaimlerChrysler Corporation vehicles. Included are starting, operating, emergency and maintenance procedures as well as specifications, capabilities and safety tips.

*Call toll free at:*

- 1-800-890-4038 (U.S.)
- 1-800-387-1143 (Canada)

Or

*Visit us on the Worldwide Web at:*

- [www.techauthority.daimlerchrysler.com](http://www.techauthority.daimlerchrysler.com)
- [www.daimlerchrysler.ca/manuals](http://www.daimlerchrysler.ca/manuals)

## **DEPARTMENT OF TRANSPORTATION UNIFORM TIRE QUALITY GRADES**

The following tire grading categories were established by the National Highway Traffic Safety Administration. The specific grade rating assigned by the tire's manufacturer in each category is shown on the sidewall of the tires on your vehicle.

All passenger car tires must conform to Federal safety requirements in addition to these grades.

### **Treadwear**

The treadwear grade is a comparative rating, based on the wear rate of the tire when tested under controlled conditions on a specified government test course. For example, a tire graded 150 would wear 1-1/2 times as well on the government course as a tire graded 100. The relative performance of tires depends upon the actual conditions of their use, however, and may depart significantly from the norm due to variations in driving habits, service practices, and differences in road characteristics and climate.

### **Traction Grades**

The traction grades, from highest to lowest, are AA, A, B, and C. These grades represent the tire's ability to stop on wet pavement, as measured under controlled conditions on specified government test surfaces of asphalt and concrete. A tire marked C may have poor traction performance.

#### **WARNING!**

**The traction grade assigned to this tire is based on straight-ahead braking traction tests, and does not include acceleration, cornering, hydroplaning, or peak traction characteristics.**

## Temperature Grades

The temperature grades are A (the highest), B, and C, representing the tire's resistance to the generation of heat and its ability to dissipate heat, when tested under controlled conditions on a specified indoor laboratory test wheel. Sustained high temperature can cause the material of the tire to degenerate and reduce tire life, and excessive temperature can lead to sudden tire failure. The grade C corresponds to a level of performance, which all passenger car tires must meet under the Federal Motor Vehicle Safety Standard No. 109. Grades B and A represent higher levels of performance on the laboratory test wheel, than the minimum required by law.

### WARNING!

**The temperature grade for this tire is established for a tire that is properly inflated and not overloaded. Excessive speed, under-inflation, or excessive loading, either separately or in combination, can cause heat buildup and possible tire failure.**

---

# INDEX

ABS (Anti-Lock Brake System) . . . . .	208,309	Alterations/Modifications, Vehicle . . . . .	8
Adding Fuel . . . . .	340	Antenna, Satellite Radio . . . . .	255
Adding Washer Fluid . . . . .	198	Antifreeze (Engine Coolant) . . . . .	424
Air Cleaner, Engine (Engine Air Cleaner Filter) . . .	389	Anti-Lock Brake System (ABS) . . . . .	105,309
Air Conditioner Maintenance . . . . .	390	Anti-Lock Warning Light . . . . .	208
Air Conditioning . . . . .	261,264	Appearance Care . . . . .	406
Air Conditioning Controls . . . . .	264	Arming Theft System (Security Alarm) . . . . .	18
Air Conditioning, Operating Tips . . . . .	265	Audio Systems (Radio) . . . . .	250
Air Conditioning Refrigerant . . . . .	391	Auto Down Power Windows . . . . .	37
Air Conditioning System . . . . .	264	Automatic Transmission . . . . .	401
Air Filter . . . . .	389	Fluid and Filter Changes . . . . .	401
Air Pressure, Tires . . . . .	322	Fluid Level Check . . . . .	401
Airbag . . . . .	51	Fluid Type . . . . .	401
Airbag Deployment . . . . .	57	Gear Ranges . . . . .	281
Airbag Light . . . . .	60,208	Shifting . . . . .	281
Airbag Maintenance . . . . .	59	Special Additives . . . . .	403
Airbag, Side . . . . .	57	Torque Converter . . . . .	285
Alarm (Security Alarm) . . . . .	18	Auxiliary Electrical Outlet (Power Outlet) . . . . .	116
Alignment and Balance . . . . .	328	Auxiliary Power Outlet . . . . .	116

Axle Lock . . . . .	290,291	Bulb Replacement . . . . .	420
Battery . . . . .	389	Capacities, Fluid . . . . .	424
Emergency Starting . . . . .	371	Caps, Filler	
Keyless Transmitter Replacement (RKE) . . . . .	24	Fuel . . . . .	340
Belts, Drive . . . . .	386	Power Steering . . . . .	391
Belts, Seat . . . . .	41	Car Washes . . . . .	407
Body Mechanism Lubrication . . . . .	392	Carbon Monoxide Warning . . . . .	339
Brake Assist System . . . . .	107	Cargo Light . . . . .	95
Brake Assist Warning Light . . . . .	214	Cargo (Vehicle Loading) . . . . .	342
Brake Control System, Electronic . . . . .	105	Catalytic Converter . . . . .	386
Brake System . . . . .	399	Caution, Exhaust Gas . . . . .	75
Anti-Lock (ABS) . . . . .	105,309	CD (Compact Disc) Player . . . . .	250
Hoses . . . . .	400	CD (Compact Disc) Player Maintenance . . . . .	258
Master Cylinder . . . . .	400	Cellular Phone . . . . .	85,250,251,258
Parking . . . . .	308	Center High Mounted Stop Light . . . . .	423
Warning Light . . . . .	207	Certification Label . . . . .	342
Brake/Transmission Interlock . . . . .	281	Chains, Tire . . . . .	329
Break-In Recommendations, New Vehicle . . . . .	75	Changing A Flat Tire . . . . .	366



Charging System Light . . . . .	206	Coolant Capacity . . . . .	424
Chart, Tire Sizing . . . . .	314	Coolant Level . . . . .	397
Check Engine Light (Malfunction Indicator Light) . . . . .	213,380	Disposal of Used Coolant . . . . .	397
Child Restraint . . . . .	62,63,69,72	Drain, Flush, and Refill . . . . .	395
Child Restraint Tether Anchors . . . . .	68,69	Inspection . . . . .	394
Child Seat . . . . .	67	Points to Remember . . . . .	398
Climate Control . . . . .	259	Pressure Cap . . . . .	396
Clock . . . . .	224,236,251	Selection of Coolant (Antifreeze) . . . . .	395,424
Compact Disc (CD) Maintenance . . . . .	258	Temperature Gauge . . . . .	209
Compass . . . . .	215	Corrosion Protection . . . . .	406
Compass Calibration . . . . .	217	Crankcase Emission Control System . . . . .	388
Computer, Trip/Travel . . . . .	215	Cruise Light . . . . .	209
Console . . . . .	118	Cup Holder . . . . .	117
Console, Floor . . . . .	118	Customer Assistance . . . . .	437
Contract, Service . . . . .	439	Data Recorder, Event . . . . .	60
Converter, Catalytic . . . . .	386	Daytime Running Lights . . . . .	99
Cooling System . . . . .	394	Dealer Service . . . . .	382
Adding Coolant (Antifreeze) . . . . .	396	Defroster, Rear Window . . . . .	198

Defroster, Windshield . . . . .	260,262	Dual Top . . . . .	120
Delay (Intermittent) Wipers . . . . .	100	Electrical Outlet, Auxiliary (Power Outlet) . . . . .	116
Diagnostic System, Onboard . . . . .	379	Electrical Power Outlets . . . . .	116
Digital Video Disc (DVD) Player . . . . .	250	Electronic Brake Control System . . . . .	105
Dimmer Switch, Headlight . . . . .	98	Anti-Lock Brake System . . . . .	105
Dipsticks		Brake Assist System . . . . .	107
Oil (Engine) . . . . .	383	Electronic Roll Mitigation . . . . .	108
Disabled Vehicle Towing . . . . .	374	Electronic Stability Program . . . . .	109
Disarming, Theft System . . . . .	18	Traction Control System . . . . .	106
Disposal		Electronic Roll Mitigation (ERM) . . . . .	108
Engine Oil . . . . .	385	Electronic Speed Control (Cruise Control) . . . . .	102
Used Coolant (Antifreeze) . . . . .	397	Electronic Stability Program (ESP) . . . . .	109
Door Locks . . . . .	31,32	Electronic Throttle Control Warning Light . . . . .	214
Doors . . . . .	26	Emergency Brake . . . . .	308
Drive Belts . . . . .	386	Emergency, In Case of	
Driver's Seat Back Tilt . . . . .	87	Brake Warning Light . . . . .	207
Driving . . . . .	294	Coolant Temperature Gauge . . . . .	209
Off-Pavement . . . . .	294	Hazard Warning Flasher . . . . .	364
Off-Road . . . . .	294		

Jacking . . . . .	366	Operation . . . . .	75
Jump Starting . . . . .	371	Overheating . . . . .	365
Tow Hooks . . . . .	374	Starting . . . . .	271
Emission Control System Maintenance . . . . .	380,428	Temperature Gauge . . . . .	209
Engine . . . . .	75	Engine Oil Viscosity . . . . .	384
Air Cleaner . . . . .	389	Engine Oil Viscosity Chart . . . . .	384
Block Heater . . . . .	275	Enhanced Accident Response Feature . . . . .	59
Break-In Recommendations . . . . .	75	Entry System, Illuminated . . . . .	19
Compartment . . . . .	378	Event Data Recorder . . . . .	60
Compartment Identification . . . . .	378	Exhaust Gas Caution . . . . .	75,339
Exhaust Gas Caution . . . . .	75,339	Exhaust System . . . . .	393
Fails to Start . . . . .	273	Extender, Seat Belt . . . . .	50
Flooded, Starting . . . . .	273	Exterior Finish Care . . . . .	407
Fuel Requirements . . . . .	336,424	Fabric Care . . . . .	409,411
Jump Starting . . . . .	371	Fabric Top . . . . .	411
Oil . . . . .	383,424	Filters	
Oil Disposal . . . . .	385	Air Cleaner . . . . .	389
Oil Filter . . . . .	385	Engine Fuel . . . . .	388
Oil Selection . . . . .	424		

Engine Oil . . . . .	385	Shifting . . . . .	287
Finish Care . . . . .	407	Four Wheel Drive Operation . . . . .	285
Flashers		Four-Way Hazard Flasher . . . . .	364
Hazard Warning . . . . .	364	Front Axle (Differential) . . . . .	405
Turn Signal . . . . .	207,421,422	Fuel . . . . .	336
Flooded Engine Starting . . . . .	273	Filler Cap (Gas Cap) . . . . .	340
Fluid Capacities . . . . .	424	Filter . . . . .	388
Fluid Level Checks . . . . .	405	Gasoline . . . . .	336
Automatic Transmission . . . . .	401	Gauge . . . . .	206
Engine Oil . . . . .	383	Materials Added . . . . .	338
Manual Transmission . . . . .	404	Octane Rating . . . . .	336
Power Steering . . . . .	391	Requirements . . . . .	424
Fluids, Lubricants and Genuine Parts . . . . .	425	Tank Capacity . . . . .	424
Fog Light Service . . . . .	422	Fuel System Caution . . . . .	338,341
Fog Lights . . . . .	99,422	Fuses . . . . .	413
Fold and Tumble Rear Seat . . . . .	89	Gas Cap (Fuel Filler Cap) . . . . .	340,380
Folding Rear Seat . . . . .	92	Gasoline (Fuel) . . . . .	336
Folding Windshield . . . . .	191	Gasoline, Reformulated . . . . .	336
Four Wheel Drive . . . . .	285		

Gasoline/Oxygenate Blends . . . . .	337	Hazard Warning Flasher . . . . .	364
Gauges		Head Restraints . . . . .	89
Coolant Temperature . . . . .	209	Head Rests . . . . .	89
Fuel . . . . .	206	Headlights	
Odometer . . . . .	211	Bulb Replacement . . . . .	420
Speedometer . . . . .	206	Dimmer Switch . . . . .	98
Tachometer . . . . .	209	Replacing . . . . .	420
Gear Ranges . . . . .	276,281	Switch . . . . .	97
General Information . . . . .	17,335	Heater . . . . .	259
Glass Cleaning . . . . .	410	Heater, Engine Block . . . . .	275
Gross Axle Weight Rating . . . . .	342,345	High Beam Indicator . . . . .	207
Gross Vehicle Weight Rating . . . . .	342,345	Hitches	
GVWR . . . . .	342	Trailer Towing . . . . .	348
Hands-Free Phone (UConnect™) . . . . .	85,250,251	Holder, Cup . . . . .	117
Hard Drive (HDD) . . . . .	250	Hood Release . . . . .	94
Hard Top . . . . .	125	Hoses . . . . .	399,400
Hard Top, Modular . . . . .	125	Hydraulic Clutch Fluid . . . . .	403
Hard Top Removal . . . . .	129	Ignition . . . . .	12

Key . . . . .	12	Jump Starting . . . . .	371
Ignition Key Removal . . . . .	12	Key, Programming . . . . .	16
Illuminated Entry . . . . .	19	Key, Replacement . . . . .	16
Immobilizer (Sentry Key) . . . . .	14	Key, Sentry (Immobilizer) . . . . .	14
Infant Restraint . . . . .	63	Key-In Reminder . . . . .	14
Inflation Pressure Tires . . . . .	322	Keyless Entry System . . . . .	19
Inside Rearview Mirror . . . . .	83	Keys . . . . .	12
Instrument Cluster . . . . .	205	Lane Change and Turn Signals . . . . .	207
Instrument Panel and Controls . . . . .	204	Lap Belts . . . . .	41
Instrument Panel Lens Cleaning . . . . .	410	Lap/Shoulder Belts . . . . .	41
Integrated Power Module (Fuses) . . . . .	413	LATCH	
Interior Appearance Care . . . . .	409	(Lower Anchors and Tether for CHildren) . . . . .	68,69
Interior Lights . . . . .	95	Lead Free Gasoline . . . . .	336
Intermittent Wipers (Delay Wipers) . . . . .	100	Lights . . . . .	95
Introduction . . . . .	4	Airbag . . . . .	60,208
Jack Location . . . . .	366	Anti-Lock . . . . .	208
Jack Operation . . . . .	366,368,369	Anti-Lock Warning . . . . .	208
Jacking Instructions . . . . .	368		

Back-Up	422
Brake Assist Warning	115,214
Brake Warning	207
Bulb Replacement	420
Cargo	95
Center Mounted Stop	423
Check Engine (Malfunction Indicator)	213
Cruise	209
Daytime Running	99
Dimmer Switch, Headlight	98
Electronic Stability Program (ESP) Indicator	115,213,214
Electronic Throttle Control Warning	214
Engine Temperature Warning	209
Fog	99,422
Hazard Warning Flasher	364
Headlight Switch	97
Headlights	420
High Beam	207

High Beam Indicator	207
Instrument Cluster	97
Interior	95
Lights On Reminder	98
Low Fuel	206
Low Tire	210
Oil Pressure	207
Passing	99
Rear Servicing	422
Rear Tail	422
Seat Belt Reminder	207
Sentry Key	209
Service	420
Side Marker	422
Tire Pressure Monitoring (TPMS)	210
Traction Control	213
Turn Signal	99,207,421,422
Warning (Instrument Cluster Description)	206
Loading Vehicle	342

Tires . . . . .	317	Master Cylinder (Brakes) . . . . .	400
Locking Axle . . . . .	290,291	Mini-Trip Computer . . . . .	215
Locks		Mirrors . . . . .	83
Door . . . . .	31,32	Outside . . . . .	84
Power Door . . . . .	33	Rearview . . . . .	83
Steering Wheel . . . . .	14	Modifications/Alterations, Vehicle . . . . .	8
Lower Anchors and Tether for CHildren		Modular Hard Top . . . . .	125
(LATCH) . . . . .	68,69	Monitor, Tire Pressure System . . . . .	330
Lubrication, Body . . . . .	392	Mopar Parts . . . . .	382,440
		MP3 Player . . . . .	250
Maintenance Free Battery . . . . .	389	Multi-Function Control Lever . . . . .	97
Maintenance Procedures . . . . .	383		
Maintenance Schedule . . . . .	428	Navigation Radio . . . . .	250
Malfunction Indicator Light (Check Engine) . . . . .	213,380	Navigation System . . . . .	250
Manual, Service . . . . .	441	New Vehicle Break-In Period . . . . .	75
Manual Transmission . . . . .	275,403		
Fluid Level Check . . . . .	404	Occupant Restraints . . . . .	40
Lubricant Selection . . . . .	403	Octane Rating, Gasoline (Fuel) . . . . .	336
Shift Speeds . . . . .	276	Odometer . . . . .	211



Trip	210,211	Paint Care	406
Off-Pavement Driving (Off-Road)	294	Paint Damage	406
Off-Road Driving (Off-Pavement)	294	Panic Alarm	21
Oil Change Indicator	212	Parking Brake	308
Oil Change Indicator, Reset	212	Passing Light	99
Oil, Engine	383	PCV Valve	388
Capacity	424	Pets	74
Dipstick	383	Phone, Cellular	85,250,251
Filter	385	Phone, Hands-Free (UConnect™)	85,250,251
Identification Logo	384	Placard, Tire and Loading Information	318
Materials Added to	385	Polishing and Waxing	407
Pressure Warning Light	207	Port	
Recommendation	384,424	Universal Serial Bus (USB)	250
Viscosity	384,424	USB	250
Oil Pressure Light	207	Power	
Onboard Diagnostic System	379,380	Distribution Center (Fuses)	413
Outside Rearview Mirrors	84	Door Locks	33
Overheating, Engine	365	Steering	311,391
Owner's Manual (Operator Manual)	441	Windows	36

Pregnant Women and Seat Belts . . . . .	50	Recorder, Event Data . . . . .	60
Preparation for Jacking . . . . .	367	Recreational Towing . . . . .	359
Pretensioners		Shifting into Transfer Case Neutral (N) . . . . .	360
Seat Belts . . . . .	48	Shifting out of Transfer Case Neutral (N) . . . . .	361
Programming Transmitters		Reformulated Gasoline . . . . .	336
(Remote Keyless Entry) . . . . .	22	Refrigerant . . . . .	391
		Release, Hood . . . . .	94
Radial Ply Tires . . . . .	325	Reminder, Lights On . . . . .	98
Radio Broadcast Signals . . . . .	220	Reminder, Seat Belt . . . . .	49
Radio, Navigation . . . . .	250	Remote Control	
Radio Operation . . . . .	251,258	Door Locks . . . . .	19
Radio, Satellite . . . . .	250,251,253	Remote Keyless Entry (RKE) . . . . .	19
Radio (Sound Systems) . . . . .	250	Remote Starting System . . . . .	25
Rear Axle (Differential) . . . . .	405	Replacement Bulbs . . . . .	420
Rear Swing Gate . . . . .	38	Replacement Keys . . . . .	16
Rear Window Defroster . . . . .	198	Replacement Parts . . . . .	382
Rear Window Features . . . . .	197	Replacement Tires . . . . .	327
Rear Wiper/Washer . . . . .	197	Reporting Safety Defects . . . . .	440
Rearview Mirrors . . . . .	83	Restraint, Head . . . . .	89

Restraints, Child . . . . .	62,67	Front Seat . . . . .	41
Restraints, Occupant . . . . .	40	Maintenance . . . . .	411
Roll Over Warning . . . . .	5	Pretensioners . . . . .	48
Rotation, Tires . . . . .	329	Reminder . . . . .	207
Safety Checks Inside Vehicle . . . . .	76	Seats . . . . .	86
Safety Checks Outside Vehicle . . . . .	77	Adjustment . . . . .	86
Safety Defects, Reporting . . . . .	440	Cleaning . . . . .	409
Safety Information, Tire . . . . .	313	Easy Entry . . . . .	88
Safety Tips . . . . .	75	Fold and Tumble Rear . . . . .	89
Satellite Radio . . . . .	250,251,253	Head Restraints . . . . .	89
Satellite Radio Antenna . . . . .	255	Height Adjustment . . . . .	87
Schedule, Maintenance . . . . .	428	Rear Folding . . . . .	92
Seat Belt Reminder . . . . .	49	Removal . . . . .	91,92
Seat Belts . . . . .	41	Seatback Release . . . . .	87
Adjustable Upper Shoulder Anchorage . . . . .	47	Tilting . . . . .	87
And Pregnant Women . . . . .	50	Security Against Theft . . . . .	18
Child Restraint . . . . .	62,72	Security Alarm (Theft Alarm) . . . . .	18
Extender . . . . .	50	Selection of Oil . . . . .	384
		Sentry Key (Immobilizer) . . . . .	14

Sentry Key Programming . . . . .	16	Specifications	
Sentry Key Replacement . . . . .	16	Fuel (Gasoline) . . . . .	336
Service Assistance . . . . .	437	Oil . . . . .	384
Service Contract . . . . .	439	Speed Control (Cruise Control) . . . . .	102
Service Manuals . . . . .	441	Speedometer . . . . .	206
Setting the Clock . . . . .	224,236,251	Starting . . . . .	271
Shift Lock Manual Override . . . . .	280	Automatic Transmission . . . . .	271
Shifting . . . . .	279	Cold Weather . . . . .	272
Automatic Transmission . . . . .	281	Engine Block Heater . . . . .	275
Manual Transmission . . . . .	275	Engine Fails to Start . . . . .	273
Shoulder Belt Upper Anchorage . . . . .	47	Manual Transmission . . . . .	271
Shoulder Belts . . . . .	41	Remote . . . . .	25
Side Airbag . . . . .	57	Steering	
Signals, Turn . . . . .	99,207,421,422	Power . . . . .	311,391
Snow Chains (Tire Chains) . . . . .	329	Tilt Column . . . . .	101
Soft Top . . . . .	141,168	Wheel Lock . . . . .	14
Sound Systems (Radio) . . . . .	250	Wheel, Tilt . . . . .	101
Spare Tire . . . . .	367	Storage . . . . .	118,419
Spark Plugs . . . . .	386	Storage, Behind the Seat . . . . .	119

Storage, Vehicle . . . . .	266,419	Tire Safety Information . . . . .	313
Storing Your Vehicle . . . . .	419	Tires . . . . .	321,442
Sunrider . . . . .	161,164	Air Pressure . . . . .	322
Supplemental Restraint System - Airbag . . . . .	51	Alignment and Balance . . . . .	328
Sway Bar Disconnect, Electronic . . . . .	292	Chains . . . . .	329
Swing Gate, Rear . . . . .	38	Changing . . . . .	366
System, Navigation . . . . .	250	General Information . . . . .	321
System, Remote Starting . . . . .	25	High Speed . . . . .	324
		Inflation Pressures . . . . .	322
Tachometer . . . . .	209	Jacking . . . . .	366,369
Temperature Gauge, Engine Coolant . . . . .	209	Load Capacity . . . . .	317,318
Tether Anchor, Child Restraint . . . . .	68	Pressure Monitor System (TPMS) . . . . .	330
Theft System Arming . . . . .	18	Pressure Warning Light . . . . .	210
Theft System Disarming . . . . .	18	Quality Grading . . . . .	442
Tilt Steering Column . . . . .	101	Radial . . . . .	325
Tip Start . . . . .	272	Replacement . . . . .	327
Tire and Loading Information Placard . . . . .	317,318	Rotation . . . . .	329
Tire Identification Number (TIN) . . . . .	316	Safety . . . . .	313
Tire Markings . . . . .	313	Sizes . . . . .	314

Spare Tire . . . . .	367	Trailer and Tongue Weight . . . . .	352
Spinning . . . . .	325	Wiring . . . . .	356
Tread Wear Indicators . . . . .	326	Trailer Towing Guide . . . . .	348
To Open Hood . . . . .	94	Trailer Weight . . . . .	348
Tongue Weight/Trailer Weight . . . . .	352	Transfer Case . . . . .	404
Torque Converter Clutch . . . . .	285	Four-Wheel-Drive Operation . . . . .	285
Tow Hooks, Emergency . . . . .	374	Maintenance . . . . .	404
Towing . . . . .	344,374	Transmission	
Disabled Vehicle . . . . .	374	Automatic . . . . .	281
Guide . . . . .	348	Maintenance . . . . .	401,403
Recreational . . . . .	359	Manual . . . . .	275
Weight . . . . .	348	Range Indicator . . . . .	210
Trac-Lok Rear Axle . . . . .	289	Shifting . . . . .	279
Traction Control . . . . .	106	Transmitter Battery Service	
Traction Control Light . . . . .	213	(Remote Keyless Entry) . . . . .	24
Trailer Towing . . . . .	344	Transmitter Programming	
Cooling System Tips . . . . .	359	(Remote Keyless Entry) . . . . .	22
Hitches . . . . .	336,348	Transporting Pets . . . . .	74
Minimum Requirements . . . . .	353	Tread Wear Indicators . . . . .	326

Trip Computer . . . . .	215	Warning Flasher, Hazard . . . . .	364
Trip Odometer . . . . .	211	Warning Lights (Instrument Cluster Description) . . . . .	206
Trip Odometer Reset Button . . . . .	210	Warning, Roll Over . . . . .	5
Turn Signals . . . . .	99,207,421,422	Warnings and Cautions . . . . .	8
UConnect™ (Hands-Free Phone) . . . . .	85,250	Warranty Information . . . . .	440
Uniform Tire Quality Grades . . . . .	442	Washer, Adding Fluid . . . . .	198
Universal Serial Bus (USB) Port . . . . .	250	Washers, Windshield . . . . .	393
Upholstery Care . . . . .	409	Waxing and Polishing . . . . .	407
USB Port . . . . .	250	Wheel Alignment and Balance . . . . .	328
Vacuum/Vapor Harnesses . . . . .	399	Wheel and Wheel Trim . . . . .	409
Vehicle Certification Label . . . . .	342	Wheel and Wheel Trim Care . . . . .	409
Vehicle Identification Number (VIN) . . . . .	8	Wheel Mounting . . . . .	370
Vehicle Loading . . . . .	318,342	Wind Buffeting . . . . .	38
Vehicle Modifications/Alterations . . . . .	8	Window Fogging . . . . .	265
Vehicle Storage . . . . .	266,419	Windows . . . . .	36
Viscosity, Engine Oil . . . . .	384	Power . . . . .	36
		Windshield, Folding . . . . .	191

Windshield Washers . . . . .	100,393
Fluid . . . . .	393
Windshield Wiper Blades . . . . .	392
Windshield Wipers . . . . .	100
Wiper, Rear . . . . .	197
YES Essentials® Fabric Cleaning Procedure . . . . .	409







**Stick with the Specialists<sup>®</sup>**

DaimlerChrysler Corporation

