



2013
FIT



TRY FIT ON FOR SIZE.

THE FIT IS A QUICK STUDY IN SPORTY EYE-CATCHING DESIGN.

It's function-friendly with a One-Motion 60/40 Split 2nd-Row Magic Seat® that's easily operated with a single hand. It's traffic-taming i-VTEC® power with a dash of shortcut-carving agility. It's big on safety with an Advanced Compatibility Engineering™ (ACE™) body structure. It's also mighty fuel efficient with its "all the way there, and back, and there again" approach to driving. And it's built by Honda, but made for you and your life on the go.

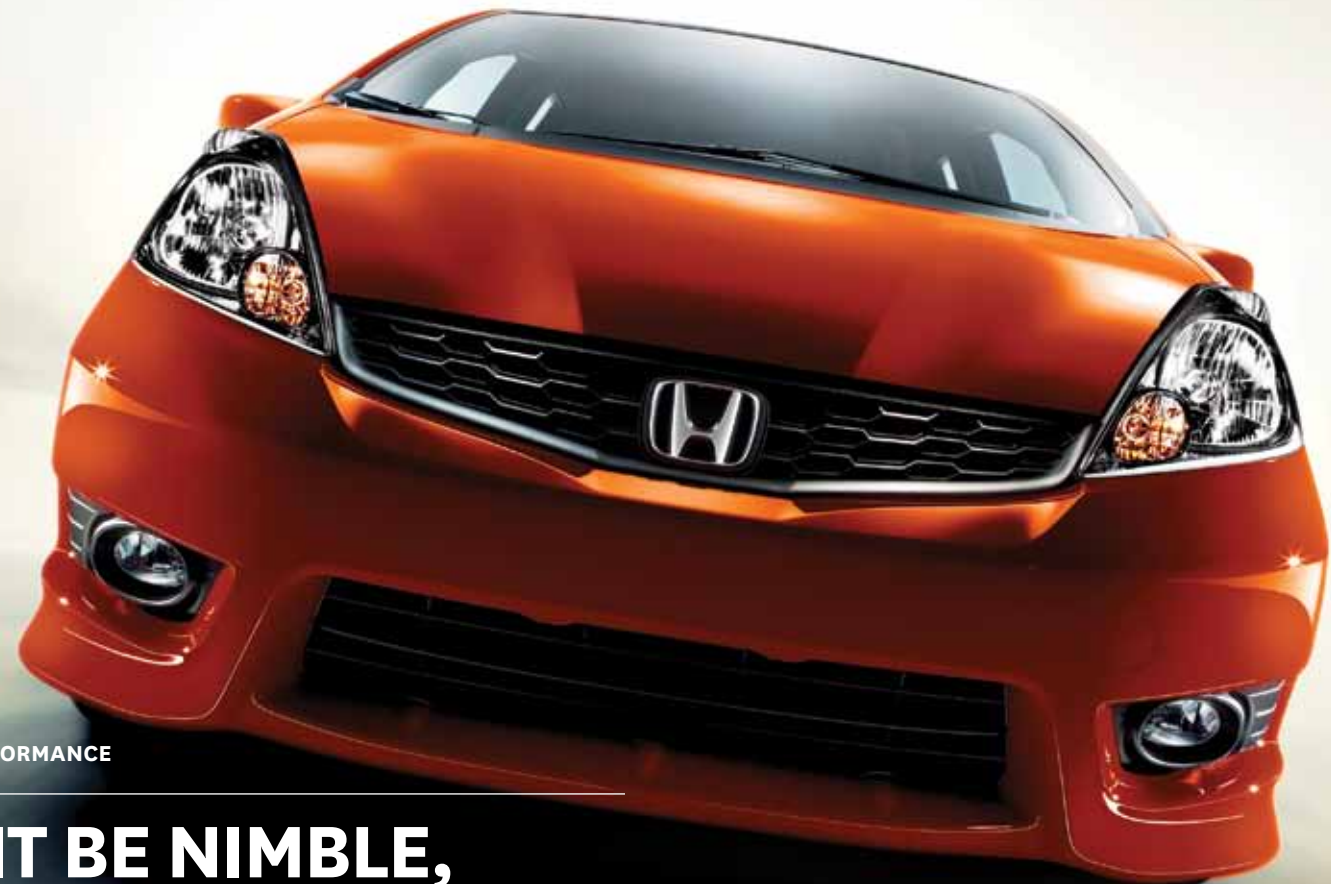

PERFORMANCE

FIT BE NIMBLE, FIT BE QUICK.

THE FIT IS INCREDIBLY PERFORMANCE SAVVY.

Yes, it's got pep, but pep without handling, agility, control and a dash of confidence can only take you so far. Thankfully, the Fit nimbly answers the call with its electric power-assisted rack-and-pinion steering (EPS) and its precision-tuned independent MacPherson strut front and torsion-beam rear suspension.

All trim levels have Vehicle Stability Assist (VSA®) with Traction Control to give you enhanced handling stability by correcting oversteer and understeer, helping to ensure better control in slippery conditions. So when it comes to tackling traffic, finding shortcuts or just conquering the rest of the concrete jungle, the Fit has got what it takes.



STYLING

NOT SHY ON STYLE.

THE FIT HAS A BOLD LOOK.

It has a confident character that comes to life in lines that are sculpted. It has an attractive attitude that's enhanced by a muscular body style. It's an attitude that rises from the ground up, from the available 16-inch alloy wheels and available body-coloured side mirrors and body-coloured door handles, all the way up to its available body-coloured rear roofline spoiler. And it rolls in your choice of seven available exterior colours, giving the Fit a style you can call your own.

- ▶ Power windows with auto-up/down driver's window / Available air conditioning with air-filtration system / Available power door locks / Available remote entry system / Rear window defroster / Rear window wiper with washer / 12-volt power outlet



EFFICIENCY

IT'S ON A LOW FUEL DIET.

THE FIT IS MIGHTY FUEL-EFFICIENT AND EXCEPTIONALLY EXCITING TO DRIVE.

It's equipped with a fierce 4-cylinder, 1.5-litre, i-VTEC engine that's super-powerful and super-fuel-efficient. And because we're talking i-VTEC engineering, we're also talking about the confident power and torque you want at any engine speed. Plus, the Drive-by-Wire Throttle System™ delivers quick and smooth acceleration, allowing for almost instant access to the 117 spirited horses packed under the hood.

The Fit gets its zip from Honda's innovative intelligent Variable Valve Timing and Lift Electronic Control (i-VTEC) engineering. This track-tested technology spreads engine power across the entire rpm range to offer you low-rpm torque off the line and high-rpm passing power on the highway. And to keep you moving in a fun, fuel-sipping fashion, the Fit features Variable Timing Control (VTC) to help maximize efficiency and minimize fuel consumption.



TECHNOLOGY

HI, TECH.

IF THERE IS SUCH A THING AS SUBCOMPACT LUXURY, THE FIT IS IT.

Inside the cavernous cabin, you'll find nothing but sophisticated style, high-quality materials and form-fitting comfort. Dials and displays are easy to reach and read. And the telescopic steering column with tilt feature helps you sit behind the wheel exactly the way you want.

As comfortably as the Fit carries people and possessions, it can also carry a tune or two. From CDs and MP3s, to iPod® and Windows Media® Audio, the Fit hasn't met a musical format it doesn't like. There's an available 6-speaker, 160-watt AM/FM/CD audio system with tweeters. There's an integrated auxiliary input jack and an available USB device connector for a more customized listening experience. And to top it all off, the Speed-sensitive Volume Control (SVC) system helps to ensure everything always sounds just right.

You'll always be on the go in the Fit, and you can always stay connected, too. The available Bluetooth® HandsFreeLink™ lets you wirelessly call your friends without having to take your hands off the wheel.



U.S. MODEL SHOWN

FLIPS, FOLDS AND BENDS OVER BACKWARDS FOR YOU.

WHEN IT COMES TO BRINGING FAMILY, FRIENDS, PETS OR STUFF ALONG FOR THE RIDE, THE FIT HAS AN OPEN MIND.

With the One-Motion 60/40 Split 2nd-Row Magic Seat,[®] you can easily create four different seating configurations that'll accommodate practically everything and everyone. And should you find yourself running heavy on friends, the Fit has you covered with comfortable, spacious seating for five.

TALL MODE

Seats that flip down are a great option. But in the Fit, you have two options: the 60/40 Split 2nd-Row Magic Seat not only folds down, but it also flips up, giving you over four feet of floor-to-ceiling space for those really tall items.

PEOPLE MODE

With a car that's this fuel-efficient and this exciting to drive, it's easy to find yourself on the road for hours. But what if you get tired? Not a problem. Park for a while, and recline back comfortably.

LONG MODE

When it comes to stepladders, hockey sticks, snowboards and other long stuff – the Fit can handle them all. With a front passenger seat and the 60/40 Split 2nd-Row Magic Seat that both fold completely flat, you can transport objects up to 2.36 m (7'9") in length.

- › Rear under-seat concealed storage / Available under-cargo floor storage / Front door-pocket storage bins / 8 beverage holders / Cargo area storage bins / 4 cargo area tie-down anchors / Two-tier glove compartment storage

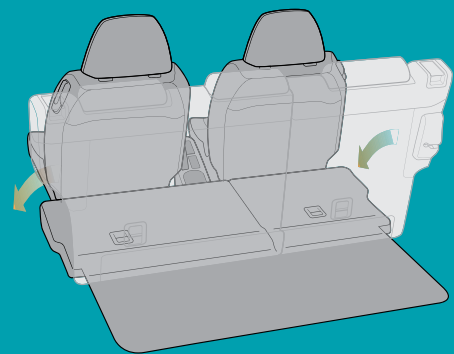

UTILITY MODE

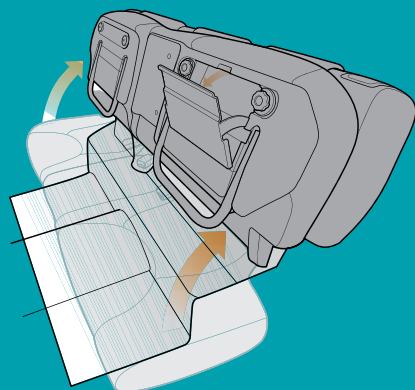

TALL MODE

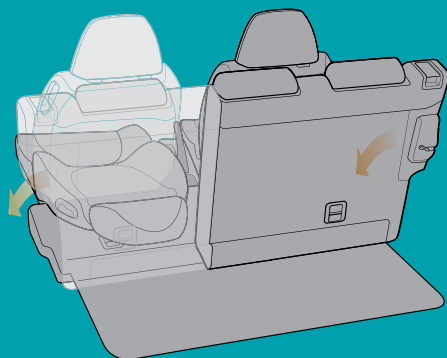

LONG MODE

FIT. IT'S BIG ON SAFETY.

SAFETY FOR EVERYONE is our commitment to providing one of the highest levels of standard safety features to help ensure occupant safety and protection*. And through real-world research, Honda is also focusing on developing unequalled measures of protection to enhance the safety of occupants in other vehicles and even pedestrians – an innovative idea that is quickly becoming a reality.

*Based on tests published by the National Highway Traffic Safety Administration (NHTSA) for models featuring standard front and side airbags. Government star ratings are part of the NHTSA New Car Assessment Program (www.safercar.gov).

ACTIVE FRONT SEAT HEAD RESTRAINTS.

Active front seat head restraints lessen the potential for neck injuries during rear-end collisions by reducing the space between the occupant's head and the seat head.

ANTI-LOCK BRAKES.

To assist with safe stopping, the 4-wheel Anti-lock Braking System (ABS) helps you maintain control under hard braking conditions, while Electronic Brake-force Distribution (EBD) optimizes braking power based on weight distribution inside the vehicle.

SIX STANDARD AIRBAGS.

Six airbags line the vehicle's cabin, including side curtain airbags and front side airbags with passenger-side Occupant Position Detection System (OPDS) that will not deploy if the system detects a smaller-sized or out-of-position occupant.

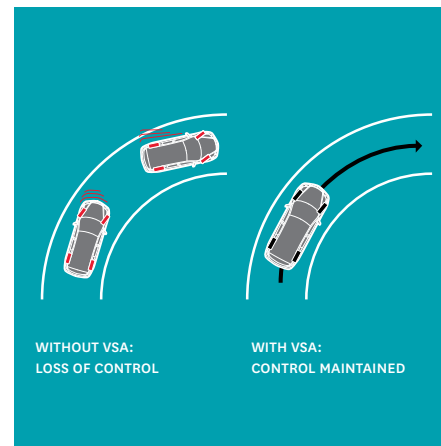

ACE™ BODY STRUCTURE.

The Fit's Advanced Compatibility Engineering (ACE) body structure disperses frontal impact energy to increase occupant protection and allow for collision compatibility between vehicles of different weights and sizes.

VEHICLE STABILITY ASSIST (VSA®) WITH TRACTION CONTROL.

Vehicle Stability Assist senses and corrects oversteer and understeer situations to enhance handling and cornering stability, while Traction Control helps to ensure better control during acceleration on loose or slippery surfaces.

CHILD SAFETY.

The Fit features childproof rear door locks, as well as rear seat Lower Anchors and Tethers for Children (LATCH) for secure child-seat restraint.

SEAT BELT SAFETY.

Be prepared for the unexpected with 3-point height-adjustable seat belts with front pretensioners and a 3-point rear centre seat belt.

Honda reminds you and your passengers to always buckle up. Children 12 and under are safest when properly secured in the rear seat.

PEDESTRIAN SAFETY.

Innovative pedestrian safety features include energy-absorbing hood and front fenders and breakaway wiper pivots.

ACCESSORIES

PACKAGES AND KITS

PROTECTION PACKAGE 1

- > All-weather floor mats
- > Cargo tray

PROTECTION PACKAGE 2

- > All-weather floor mats
- > Cargo tray
- > Rear splash guard

INTERIOR TRIM PACKAGE

- > Door switch panel
- > Meter visor panel
- > Side outlet panel

FIT STORAGE PACKAGE

- > Armrest with storage compartment
- > Cargo net
- > Cargo net tie-down hook

REMOTE STARTER KIT WITH / WITHOUT FOP SECURITY

Accessories listed in the packages may also be added individually to your Fit.



1

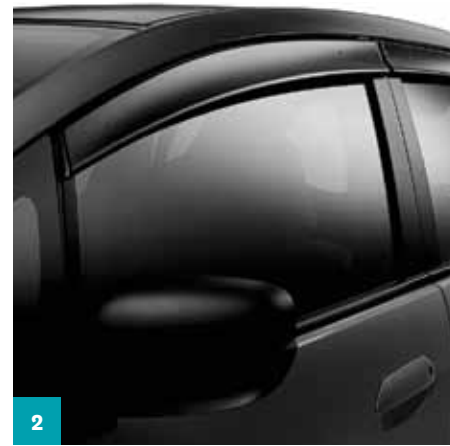

2



7



8



3

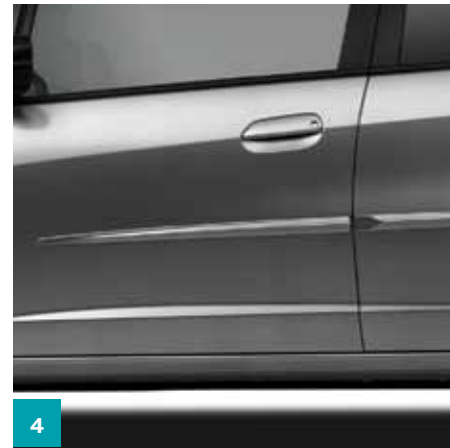

4



9



10



5



6



11

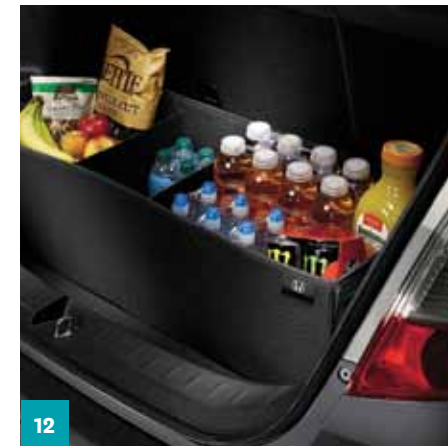

12

OTHER ACCESSORIES AVAILABLE

- > Ashtray – cup holder style
- > B-pillar trim kit
- > Cargo liner
- > Carpet floor mats
- > Chrome exhaust finisher
- > Door edge film
- > Engine block heater
- > Fog lights
- > Hood edge deflector
- > Locking wheel nuts
- > Rear shelf
- > Rear tailgate spoiler
- > Magic board
- > Shift knob (MT/AT) – leather
- > Steering wheel cover
- > Trunk edge and bumper protector
- > USB adapter

1 FRONT GRILLE

2 DOOR VISOR KIT

3 CAR COVER

4 BODY SIDE MOULDINGS

5 16" ALLOY WHEELS

6 SPORT PEDALS

7 INTERIOR ILLUMINATION

8 SIDE SILL GARNISH

9 FULL NOSE MASK (DX/SPORT)

10 REAR BUMPER APPLIQUÉ

11 SEAT COVER

12 CARGO ORGANIZER

THE POWER OF DREAMS, IN ALL THEIR FORMS.

AT HONDA, WE'RE COMMITTED TO BEING A LEADER IN INNOVATIVE THINKING, from the design of our vehicles to the way we work. We have a proud tradition of turning ideas into products and initiatives that help make the world around us a bit brighter and a little more fun. We continually strive to do things others think can't be done, because true innovation comes from daring to dream. Here are just some of the technically ingenious things Honda has brought to life through The Power of Dreams.

- 1 THE FUEL-EFFICIENT HONDAJET
- 2 ASIMO™, THE ADVANCED LIFE-ASSISTING ROBOT
- 3 LEED® GOLD CERTIFIED MARKHAM HEAD OFFICE
- 4 MOTORCYCLES WITH RIDER-FOCUSED DESIGN
- 5 THE RUGGED, VERSATILE BIG RED
- 6 CLEANER MARINE PRODUCTS



1



2



3



4



5



6

OUR COMMITMENT TO ENVIRONMENTAL RESPONSIBILITY IS A TOP PRIORITY.

THE CREATION OF THIS BROCHURE IS NO EXCEPTION. HERE'S HOW WE DID IT:

100% RECYCLED PAPER

The first step to making this brochure in an environmentally responsible way was to customize the size of the press sheet, with a minimum of paper waste in mind. The paper in this brochure is manufactured certified Processed Chlorine Free and made up of 100% post-consumer waste from municipal recycling programs.

MADE IN CANADA

We place a very high value on being environmentally responsible citizens, and also good corporate citizens, proudly employing some 19,000 people in Canada. And this brochure was produced here from concept through printing, using recycled material from North American recycling programs.

PRINTER

We use a local printer that continues to be recognized for their environmental initiatives. They were among the first in North America to install solar panels and wind turbines and to receive Forest Stewardship Council® Chain-Of-Custody certification. They're also committed to giving back to the community through their extensive charitable efforts.

LESS INK

Our brochures are printed with bio-derived inks utilizing "stochastic" screening technology that uses less ink than conventional screening technologies.

PRODUCTION

The paper in this brochure was produced using biogas energy (gas collected from the decomposition of nearby landfill waste), an alternative green energy source that helps produce 94% less greenhouse gas emissions than the average non-recycled paper.* We've also made arrangements for the greenhouse gas emissions from the manufacturing of the paper to be counterbalanced with the purchase of verified carbon offset credits.

RECYCLABILITY

This brochure is printed on 100% post-consumer waste recycled fibre and is 100% blue bin recyclable. If you do need to dispose of it, please recycle it properly.

RESULTS

By using 100% post-consumer waste recycled paper to create our 2013 Honda brochures, we've helped save the equivalent of 771 trees, 2,839,043 l of water and over 43,000 kg of waste.*

*Life Cycle Assessment report and environmental calculation comparisons have been sourced from cascades.com/papers/.

FIT



FIT SPORT

ENGINE	DX	LX	SPORT
1.5-LITRE, 16-VALVE, SOHC, I-VTEC® 4-CYLINDER	•	•	•
HORSEPOWER @ RPM*	117 @ 6600	117 @ 6600	117 @ 6600
TORQUE (LB. - FT. @ RPM)*	106 @ 4800	106 @ 4800	106 @ 4800
DISPLACEMENT (CC)	1497	1497	1497
EMISSIONS RATING	TIER 2 BIN 5	TIER 2 BIN 5	TIER 2 BIN 5
COMPRESSION RATIO	10.4:1	10.4:1	10.4:1
BORE AND STROKE (MM)	73 X 89.4	73 X 89.4	73 X 89.4
*HORSEPOWER AND TORQUE CALCULATIONS REFLECT SAE NET, REV. 08/04, SAE J1349 PROCEDURES.			
DRIVETRAIN	DX	LX	SPORT
5-SPEED AUTOMATIC TRANSMISSION (AT) WITH GRADE LOGIC CONTROL	AVAILABLE†	AVAILABLE	AVAILABLE
5-SPEED MANUAL TRANSMISSION (MT)	•	•	•
DRIVE-BY-WIRE THROTTLE SYSTEM™	•	•	•
ELECTRIC POWER-ASSISTED RACK-AND-PINION STEERING (EPS)	•	•	•
FRONT-WHEEL DRIVE	•	•	•
†DX-A MODEL ONLY.			
CHASSIS	DX	LX	SPORT
15" STEEL WHEELS WITH FULL COVERS	•	•	•
16" ALLOY WHEELS			•
ALL-SEASON TIRES	P175/65 R15	P175/65 R15	P185/55 R16
MACPHERSON STRUT FRONT SUSPENSION	•	•	•
POWER-ASSISTED, VENTILATED FRONT DISC/REAR DRUM BRAKES	•	•	•
REAR STABILIZER BAR			•
TORSION-BEAM REAR SUSPENSION	•	•	•
EXTERIOR	DX	LX	SPORT
BLACK SIDE MIRRORS	•		
BODY-COLOURED DOOR HANDLES		•	•
BODY-COLOURED REAR ROOFLINE SPOILER		•	•
BODY-COLOURED SIDE MIRRORS		•	•
BODY-COLOURED UNDERBODY SPOILER KIT			•
CENTRE HIGH MOUNT STOP LIGHT	•	•	•
CHROME EXHAUST FINISHER			•
FRONT SPLASH GUARDS	•	•	
HEATED SIDE MIRRORS		•	•
HOOD INSULATOR	•	•	•
INTEGRATED FOG LIGHTS			•
POWER SIDE MIRRORS	•	•	•
REAR WINDOW WIPER/WASHER	•	•	•
ROOF-MOUNTED ANTENNA	•	•	•



FIT SPORT

SAFETY	DX	LX	SPORT
3-POINT HEIGHT-ADJUSTABLE SEAT BELTS WITH FRONT PRETENSIONERS	•	•	•
3-POINT REAR CENTRE SEAT BELT	•	•	•
4-WHEEL ANTI-LOCK BRAKING SYSTEM (ABS) WITH ELECTRONIC BRAKE-FORCE DISTRIBUTION (EBD)	•	•	•
ACTIVE FRONT SEAT HEAD RESTRAINTS	•	•	•
ADVANCED COMPATIBILITY ENGINEERING™ (ACE™) BODY STRUCTURE	•	•	•
CHILDPROOF REAR DOOR LOCKS	•	•	•
DUAL-STAGE, DUAL-THRESHOLD FRONT AIRBAGS (SRS)	•	•	•
FRONT SIDE AIRBAGS WITH PASSENGER-SIDE OCCUPANT POSITION DETECTION SYSTEM (OPDS)	•	•	•
IMMOBILIZER THEFT-DETERRENT SYSTEM	•	•	•
LOWER ANCHORS AND TETHERS FOR CHILDREN (LATCH)	•	•	•
SECURITY SYSTEM			•
SIDE CURTAIN AIRBAGS	•	•	•
SPARE TIRE	MT ONLY	MT ONLY	MT ONLY
TIRE REPAIR KIT	AT ONLY*	AT ONLY	AT ONLY
VEHICLE STABILITY ASSIST (VSA®) WITH TRACTION CONTROL	•	•	•

*DX-A MODEL ONLY.

DIMENSIONS	DX	LX	SPORT
CARGO VOLUME – REAR SEAT UP/DOWN (L)	585/1622	585/1622	585/1622
CURB WEIGHT – MT/AT (KG)	1125 [†] /1162 [†]	1125/1163	1145/1182
FUEL TANK CAPACITY (L)	40	40	40
GROSS VEHICLE WEIGHT RATING (KG)	1594	1594	1594
GROUND CLEARANCE (MM)	150	150	150
HEADROOM – FRONT/REAR (MM)	1027/991	1027/991	1027/991
HEIGHT (MM)	1525	1525	1525
HIP ROOM – FRONT/REAR (MM)	1308/1302	1308/1302	1308/1302
LEGGROOM – FRONT/REAR (MM)	1050/888	1050/888	1050/888
LENGTH (MM)	4105	4105	4105
PASSENGER VOLUME (L)	2572	2572	2572
SHOULDER ROOM – FRONT/REAR (MM)	1338/1302	1338/1302	1338/1302
TRACK – FRONT/REAR (MM)	1492/1475	1492/1475	1476/1459
TURNING DIAMETER (M)	10.5	10.5	10.5
WHEELBASE (MM)	2500	2500	2500
WIDTH (MM)	1695	1695	1695

†DX-A MODEL ONLY.

SEATING & TRIM	DX	LX	SPORT
60/40 SPLIT 2ND-ROW MAGIC SEAT® WITH UNDERSEAT STORAGE COMPARTMENT	•	•	•
ADJUSTABLE FRONT SEAT HEAD RESTRAINTS	•	•	•
FOLD-FLAT-CAPABLE SEATING	•	•	•
RECLINING FRONT SEATBACKS	•	•	•



FIT SPORT

COMFORT & CONVENIENCE	DX	LX	SPORT
2-SPEED INTERMITTENT WINDSHIELD WIPERS	•	•	•
12-VOLT POWER OUTLET	•	•	•
ADJUSTABLE TILT AND TELESCOPIC STEERING COLUMN	•	•	•
AIR CONDITIONING WITH AIR-FILTRATION SYSTEM	AVAILABLE	•	•
CARGO AREA LIGHT	•	•	•
CARGO AREA STORAGE POCKET	•	•	•
CARGO AREA TIE-DOWN ANCHORS (4)	•	•	•
DIGITAL ODOMETER	•	•	•
DIGITAL TRIP METER	•	•	•
DRIVER'S AND FRONT PASSENGER'S VANITY MIRRORS	•	•	•
DRIVER-SIDE ARMREST	•	•	•
FRONT DOOR-POCKET STORAGE BINS	•	•	•
FUEL CONSUMPTION DISPLAY	•	•	•
HANDSFREELINK™-BILINGUAL BLUETOOTH® WIRELESS MOBILE PHONE INTERFACE	•	•	•
MAINTENANCE MINDER™ SYSTEM	•	•	•
PASSENGER-SIDE SEATBACK POCKET	•	•	•
PERFORATED LEATHER-WRAPPED STEERING WHEEL	•	•	•
PORTABLE AIR COMPRESSOR	AT ONLY*	AT ONLY	AT ONLY
POWER DOOR LOCKS	•	•	•
POWER WINDOWS WITH AUTO-UP/DOWN DRIVER'S WINDOW	•	•	•
REAR WINDOW DEFROSTER	•	•	•
REMOTE ENTRY SYSTEM	•	•	•
STEERING WHEEL-MOUNTED CRUISE CONTROL	•	•	•
TACHOMETER	•	•	•
UNDER-CARGO FLOOR STORAGE	AT ONLY*	AT ONLY	AT ONLY

*DX-A MODEL ONLY.

ENTERTAINMENT	DX	LX	SPORT
160-WATT AM/FM/CD AUDIO SYSTEM	2 SPEAKERS	4 SPEAKERS	6 SPEAKERS
FRONT SPEAKERS	•	•	•
REAR SPEAKERS	•	•	•
MP3/AUXILIARY INPUT JACK	•	•	•
MP3/WINDOWS MEDIA® AUDIO PLAYBACK CAPABILITY	•	•	•
SPEED-SENSITIVE VOLUME CONTROL (SVC)	•	•	•
TWEETERS	•	•	•
USB DEVICE CONNECTOR	•	•	•

FUEL ECONOMY* (L/100 KM)	DX	LX	SPORT
AUTOMATIC TRANSMISSION (CITY/HWY/COMBINED)	7.1/5.4/6.3†	7.1/5.4/6.3	7.1/5.4/6.3
MANUAL TRANSMISSION (CITY/HWY/COMBINED)	7.1/5.7/6.5	7.1/5.7/6.5	7.1/5.7/6.5

*Based on 2012 EnerGuide Fuel Consumption Guide ratings published by Natural Resources Canada. Transport Canada approved test methods used.

Your actual fuel consumption will vary based on driving habits and other factors – use for comparison only

†DX-A model only.



FIT SPORT

FIT DX

117-HP, 1.5-LITRE, SOHC, I-VTEC® 4-CYLINDER ENGINE · 5-SPEED MANUAL TRANSMISSION (MT) · AVAILABLE 5-SPEED AUTOMATIC TRANSMISSION (AT) WITH GRADE LOGIC CONTROL* · 15" STEEL WHEELS WITH FULL COVERS · 4-WHEEL ANTI-LOCK BRAKING SYSTEM (ABS) WITH ELECTRONIC BRAKE-FORCE DISTRIBUTION (EBD) · 2-SPEED INTERMITTENT WINDSHIELD WIPERS · 60/40 SPLIT 2ND-ROW MAGIC SEAT® WITH UNDERSEAT STORAGE COMPARTMENT · 160-WATT AM/FM/CD AUDIO SYSTEM WITH 2 SPEAKERS AND MP3/WINDOWS MEDIA® AUDIO PLAYBACK CAPABILITY · ACTIVE FRONT SEAT HEAD RESTRAINTS · ADJUSTABLE TILT AND TELESCOPIC STEERING COLUMN · ADVANCED COMPATIBILITY ENGINEERING™ (ACE™) BODY STRUCTURE · AVAILABLE AIR CONDITIONING WITH AIR-FILTRATION SYSTEM · BLACK SIDE MIRRORS · CARGO AREA LIGHT · CARGO AREA STORAGE POCKET · CARGO AREA TIE-DOWN ANCHORS (4) · DRIVER'S AND FRONT PASSENGER'S VANITY MIRRORS · DUAL-STAGE, DUAL-THRESHOLD FRONT AIRBAGS (SRS) · ELECTRIC POWER-ASSISTED RACK-AND-PINION STEERING (EPS) · FRONT DOOR-POCKET STORAGE BINS · FRONT SIDE AIRBAGS WITH PASSENGER-SIDE OCCUPANT POSITION DETECTION SYSTEM (OPDS) · FUEL CONSUMPTION DISPLAY · IMMOBILIZER THEFT-DETERRENT SYSTEM · MAINTENANCE MINDER™ SYSTEM · MP3/AUXILIARY INPUT JACK · POWER SIDE MIRRORS · POWER WINDOWS WITH AUTO-UP/DOWN DRIVER'S WINDOW · REAR WINDOW DEFROSTER · REAR WINDOW WIPER/WASHER · SIDE CURTAIN AIRBAGS · VEHICLE STABILITY ASSIST (VSA®) WITH TRACTION CONTROL
*DX-A MODEL ONLY.

FIT LX

ADDS TO OR REPLACES DX FEATURES:

160-WATT AM/FM/CD AUDIO SYSTEM WITH 4 SPEAKERS AND MP3/WINDOWS MEDIA® AUDIO PLAYBACK CAPABILITY · AIR CONDITIONING WITH AIR-FILTRATION SYSTEM · BODY-COLOURED REAR ROOFLINE SPOILER · BODY-COLOURED SIDE MIRRORS AND DOOR HANDLES · DRIVER-SIDE ARMREST · HANDSFREELINK™-BILINGUAL BLUETOOTH® WIRELESS MOBILE PHONE INTERFACE · HEATED SIDE MIRRORS · POWER DOOR LOCKS · REMOTE ENTRY SYSTEM · STEERING WHEEL-MOUNTED CRUISE CONTROL

FIT SPORT

ADDS TO OR REPLACES LX FEATURES:

16" ALLOY WHEELS · 160-WATT AM/FM/CD AUDIO SYSTEM WITH 6 SPEAKERS AND MP3/WINDOWS MEDIA® AUDIO PLAYBACK CAPABILITY · BODY-COLOURED UNDERBODY SPOILER KIT · CHROME EXHAUST FINISHER · INTEGRATED FOG LIGHTS · PASSENGER-SIDE SEATBACK POCKET · PERFORATED LEATHER-WRAPPED STEERING WHEEL · REAR STABILIZER BAR · SECURITY SYSTEM · USB DEVICE CONNECTOR

EXTERIOR / INTERIOR COLOURS

EXTERIOR / INTERIOR COLOURS	DX	LX	SPORT
VORTEX BLUE PEARL	GF	GF	BF
MILANO RED	GF	GF	BF
CRYSTAL BLACK PEARL	GF*	GF	BF
POLISHED METAL METALLIC	GF	GF	BF
COOL TURQUOISE METALLIC	GF*	GF	BF
TAFFETA WHITE	GF*	GF	BF
ORANGE BURST METALLIC			BF

*DX-A MODEL ONLY

FIT – EXTERIOR COLOURS

CRYSTAL BLACK PEARL

POLISHED METAL METALLIC

TAFFETA WHITE

MILANO RED

VORTEX BLUE PEARL

COOL TURQUOISE METALLIC

ORANGE BURST METALLIC

FIT – INTERIOR COLOURS

BLACK FABRIC (BF)

GREY FABRIC (GF)

**GET THE LATEST PHOTOS, MSRPS,
FEATURES, ACCESSORIES, SPECS
AND MORE AT WWW.HONDA.CA.**

Specifications, features, illustrations and equipment shown in this catalogue are based on the latest available information at the time of publication. Although descriptions are believed to be correct, accuracy cannot be guaranteed. Honda Canada Inc. reserves the right to make changes at any time, without notice or obligation, in colours, specifications, accessories, materials and models. Some vehicles are shown with optional equipment. Some vehicles shown are U.S. models. Canadian specifications may vary. Bluetooth is a registered trademark of SIG Inc. HandsFreeLink is a trademark of Johnson Controls Technology. iPod is a registered trademark of Apple Inc. Windows Media is a registered trademark of Microsoft Corporation. Honda, Fit, i-VTEC, ACE, Advanced Compatibility Engineering, Drive-by-Wire Throttle System, Magic Seat, Maintenance Minder, VSA, The Power of Dreams, HondaJet and ASIMO are trademarks of Honda Motor Co., Ltd.

© 2012 Honda Canada Inc., 180 Honda Boulevard, Markham, Ontario, Canada L6C 0H9

