

2014 Europa Super Show Texas

Division: [NOV-13-14-B94] Teen NO GI >> Novice (0-1 yrs) >> 13 to 14 years >> BOYS 0-94.9 lbs

Copyright © 2014 STRONGVON LLC

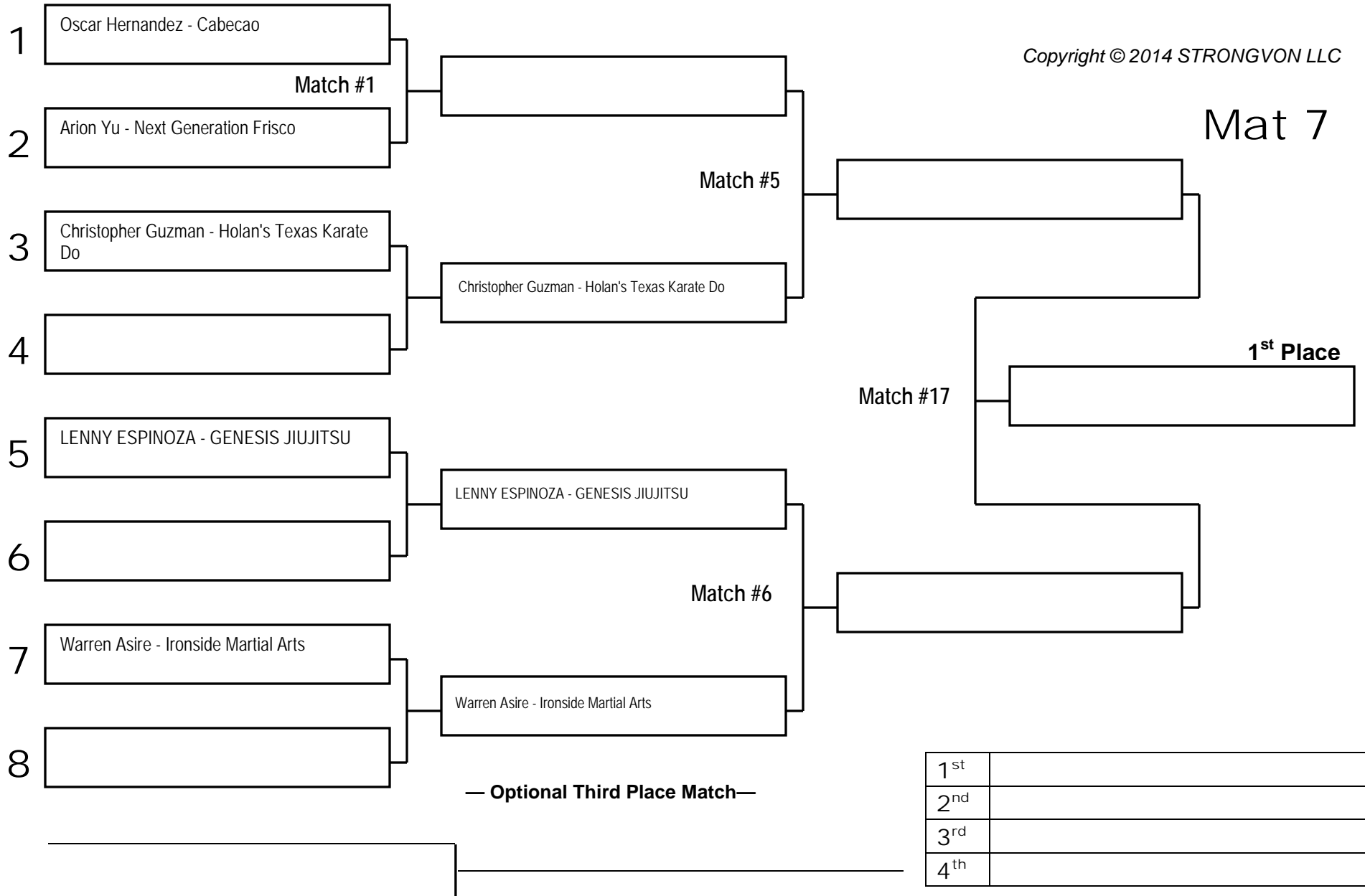

1 st	
2 nd	
3 rd	
4 th	

MAT: _____ Name: _____ Signature: _____

2014 Europa Super Show Texas

Division: [NOV-13-14-B134] Teen NO GI >> Novice (0-1 yrs) >> 13 to 14 years >> BOYS 120-134.9 lbs

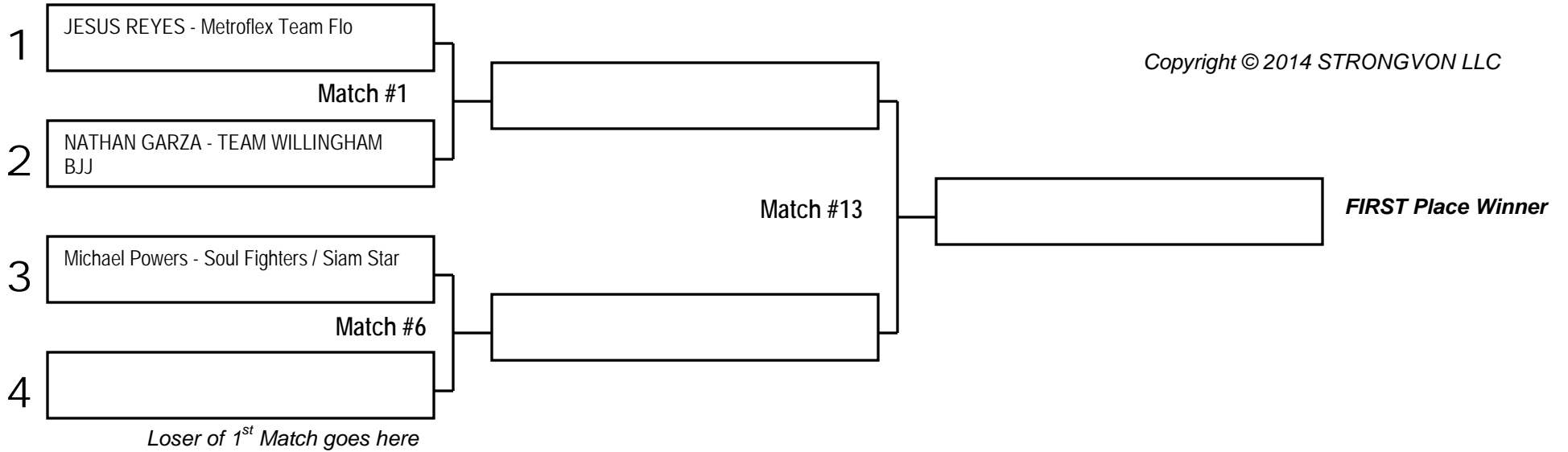

Mat 9

MAT: _____ Name: _____ Signature: _____

1 st	
2 nd	
3 rd	

2014 Europa Super Show Texas

Division: [NOV-13-14-B179] Teen NO GI >> Novice (0-1 yrs) >> 13 to 14 years >> BOYS 165-179.9 lbs

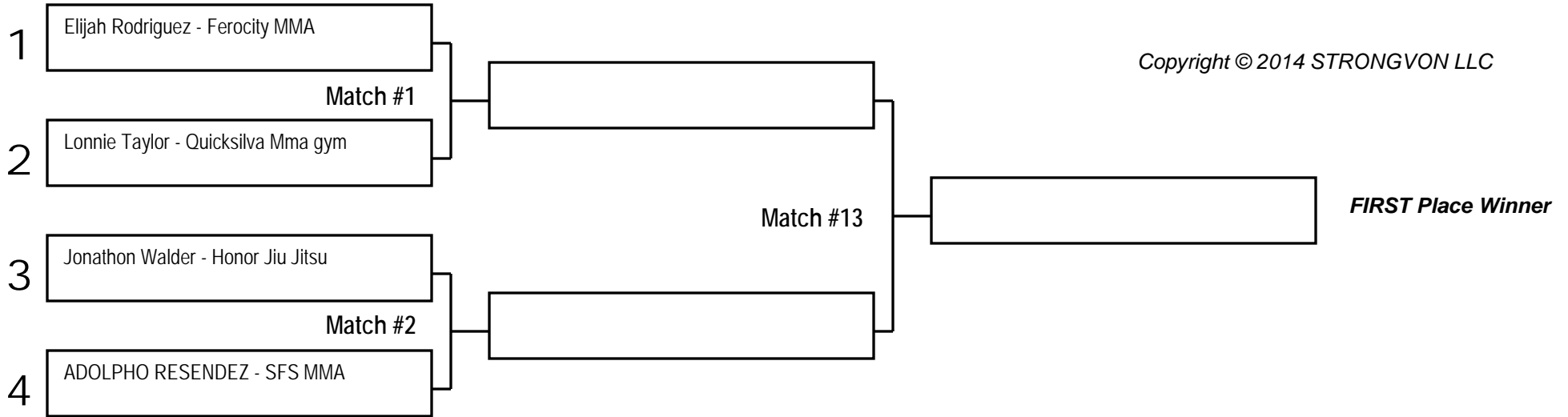

Mat 10

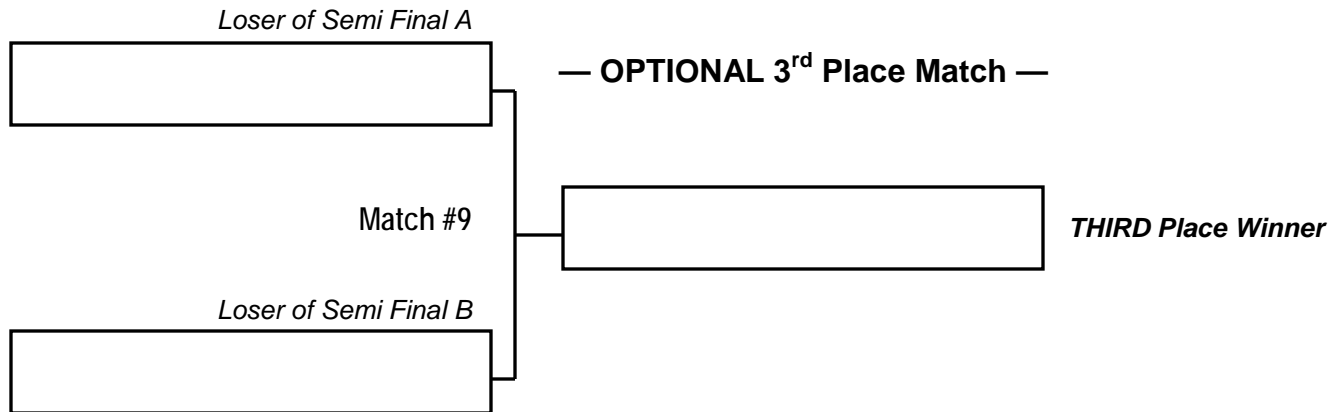

1 st	
2 nd	
3 rd	
4 th	

MAT: _____ Name: _____ Signature: _____

2014 Europa Super Show Texas

Division: [NOV-13-14-B999] Teen NO GI >> Novice (0-1 yrs) >> 13 to 14 years >> BOYS 180 lbs and up

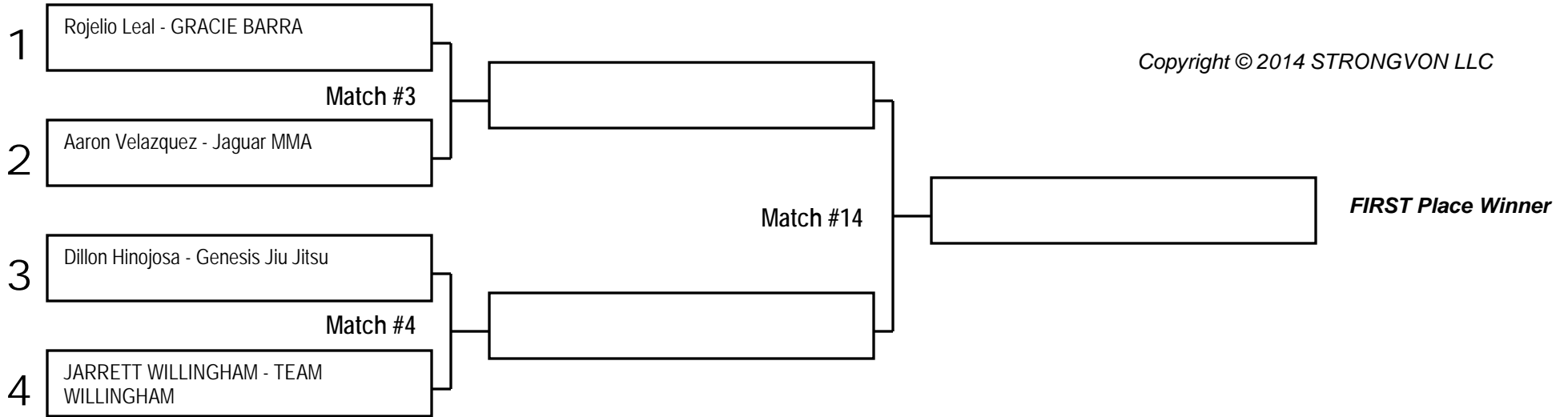

Mat 10

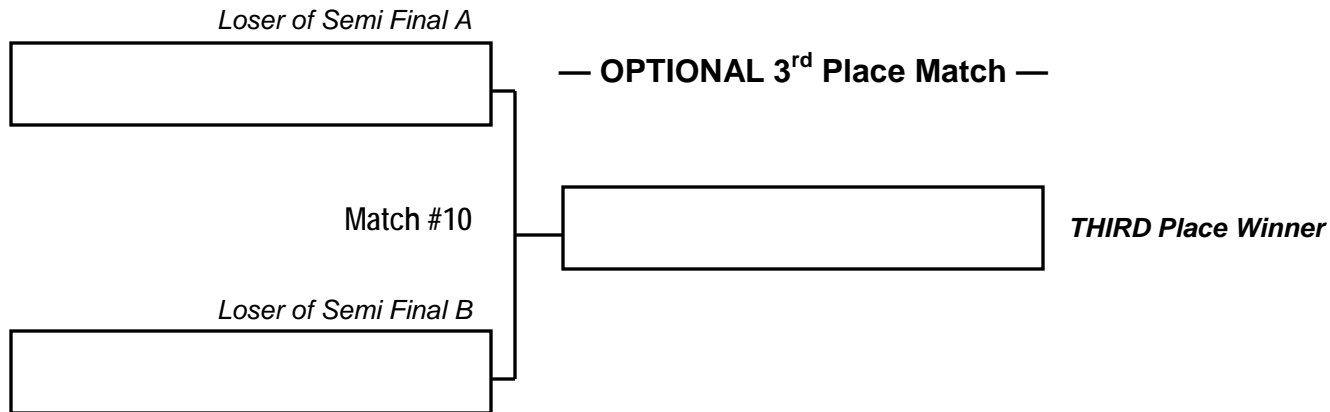

1 st	
2 nd	
3 rd	
4 th	

MAT: _____ Name: _____ Signature: _____

2014 Europa Super Show Texas

Division: [NOV-13-14-G109] Teen NO GI >> Novice (0-1 yrs) >> 13 to 14 years >> GIRLS 0-109.9 lbs

Copyright © 2014 STRONGVON LLC

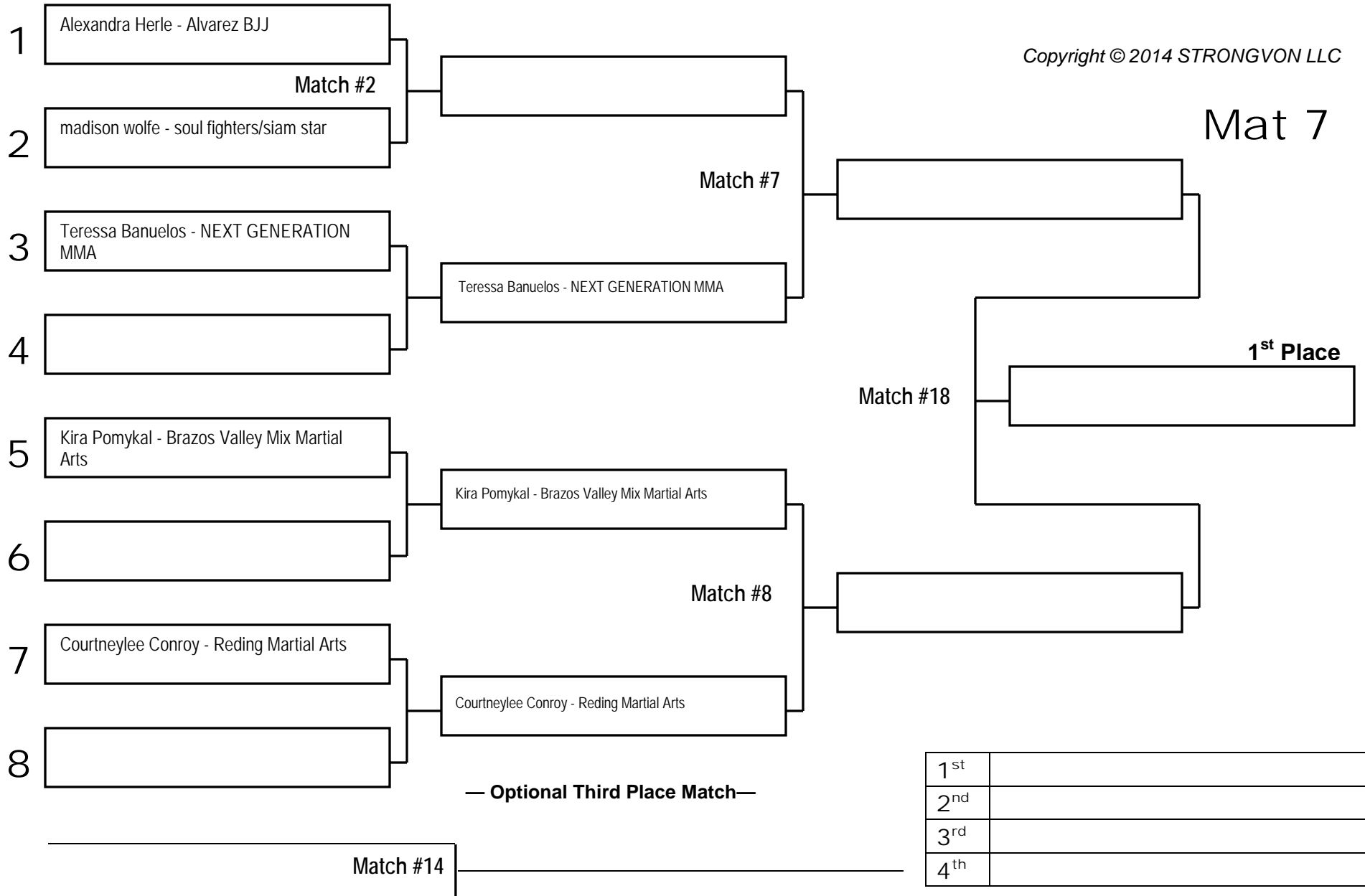

1 st	[]
2 nd	[]
3 rd	[]
4 th	[]

MAT: _____ Name: _____ Signature: _____

2014 Europa Super Show Texas

Division: [NOV-13-14-G129] Teen NO GI >> Novice (0-1 yrs) >> 13 to 14 years >> GIRLS 110-129.9 lbs

Copyright © 2014 STRONGVON LLC

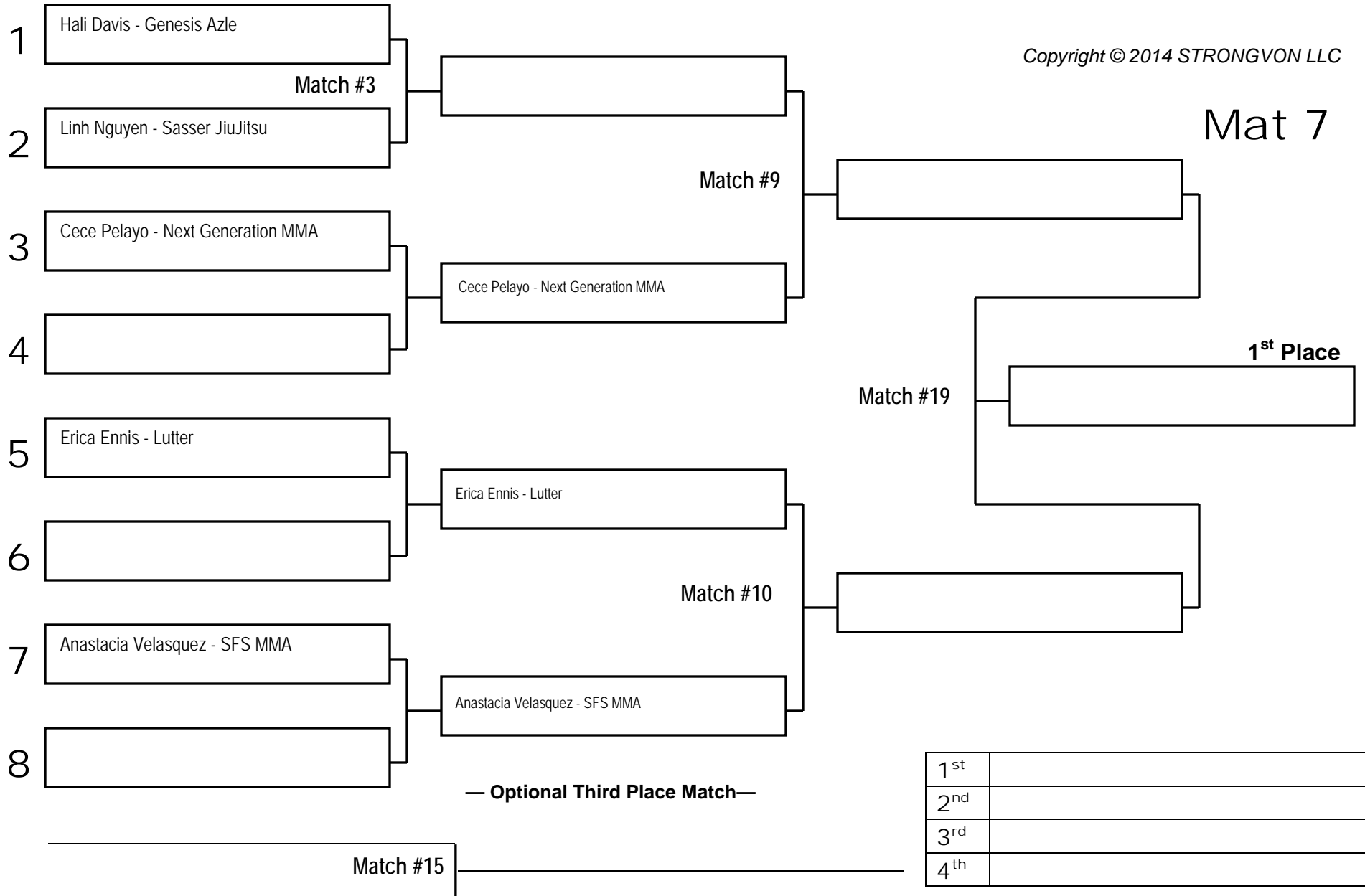

MAT: _____ Name: _____ Signature: _____

2014 Europa Super Show Texas

Division: [NOV-15-17-B119] Teen NO GI >> Novice (0-1 yrs) >> 15 to 17 years >> BOYS 106-119.9 lbs

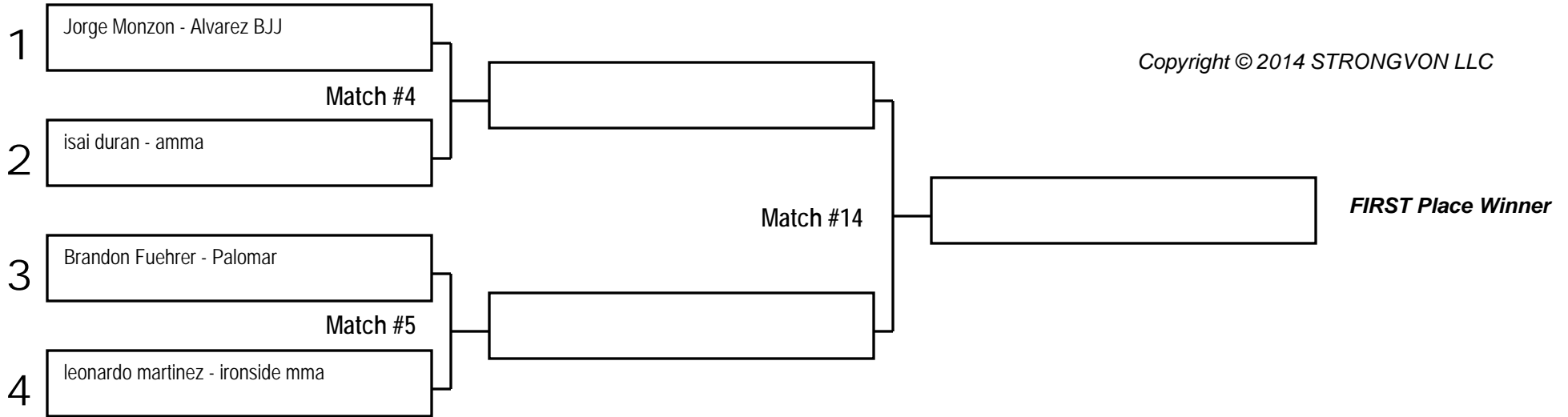

Mat 8

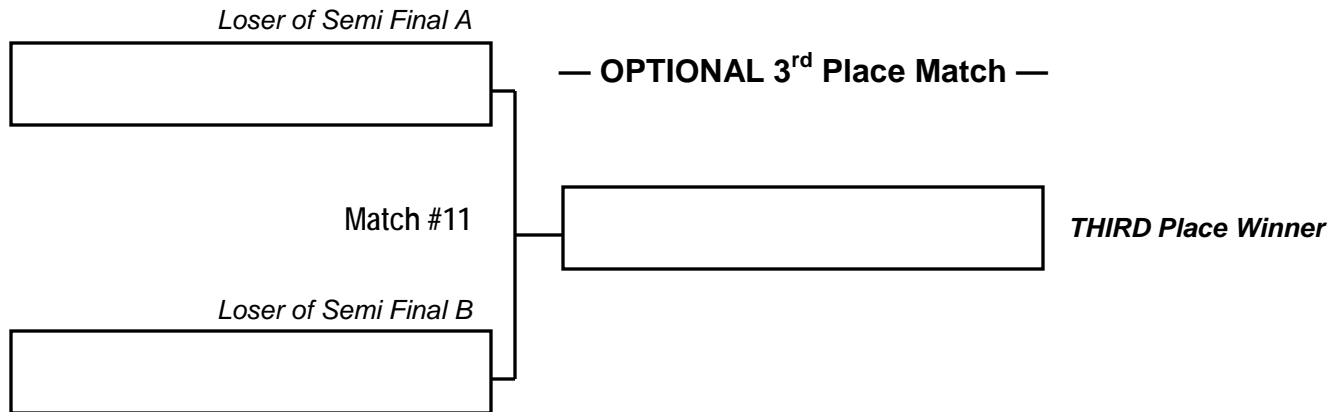

1 st	
2 nd	
3 rd	
4 th	

MAT: _____ Name: _____ Signature: _____

2014 Europa Super Show Texas

Division: [NOV-15-17-B149] Teen NO GI >> Novice (0-1 yrs) >> 15 to 17 years >> BOYS 135-149.9 lbs

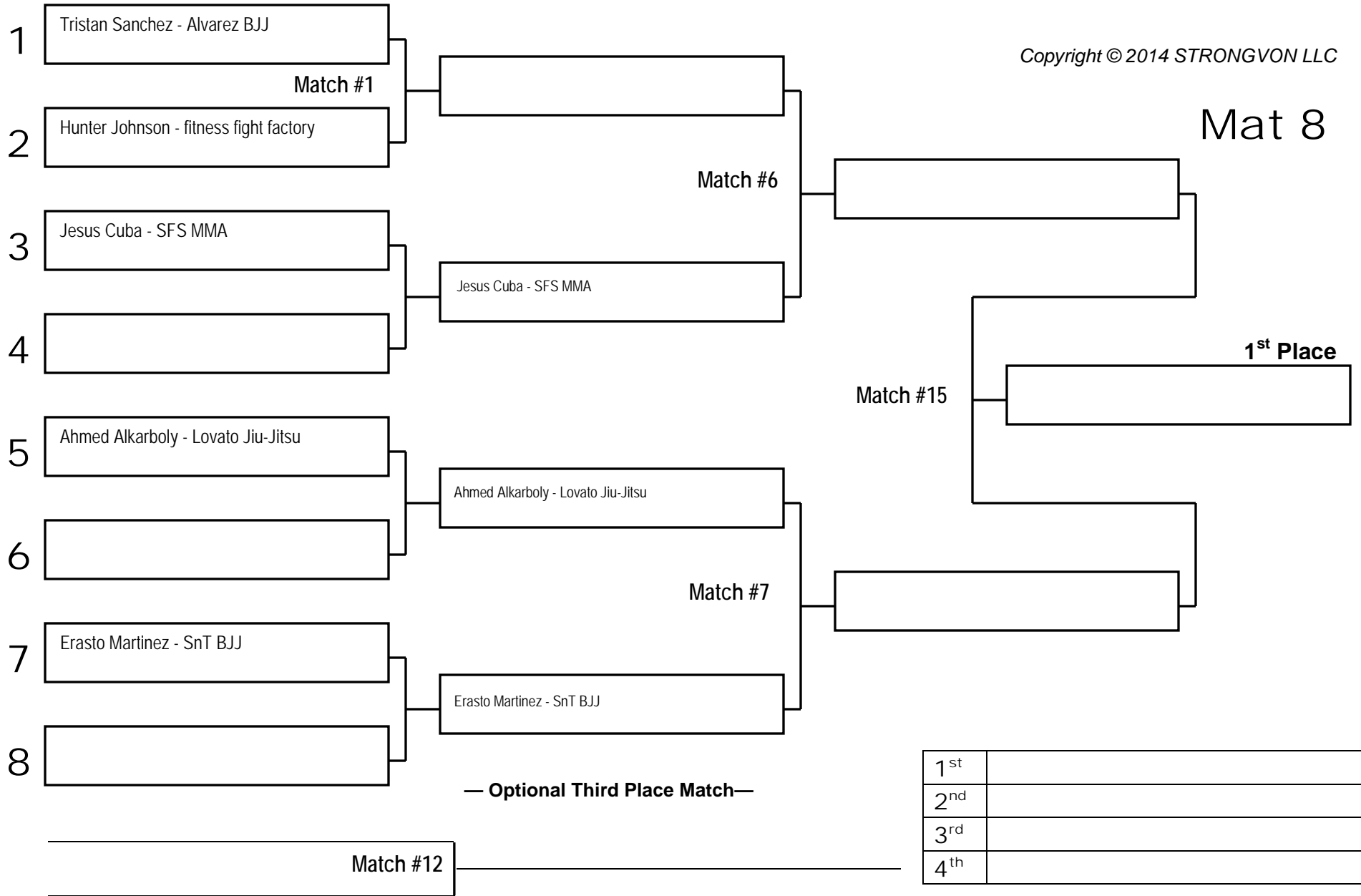

MAT: _____ Name: _____ Signature: _____

2014 Europa Super Show Texas

Division: [NOV-15-17-B179] Teen NO GI >> Novice (0-1 yrs) >> 15 to 17 years >> BOYS 165-179.9 lbs

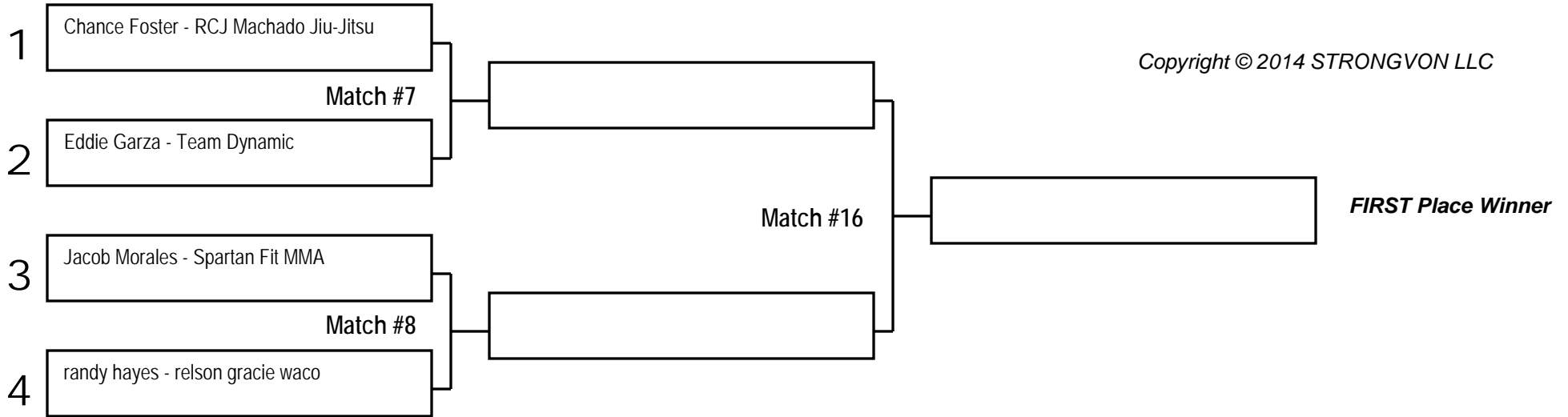

Mat 10

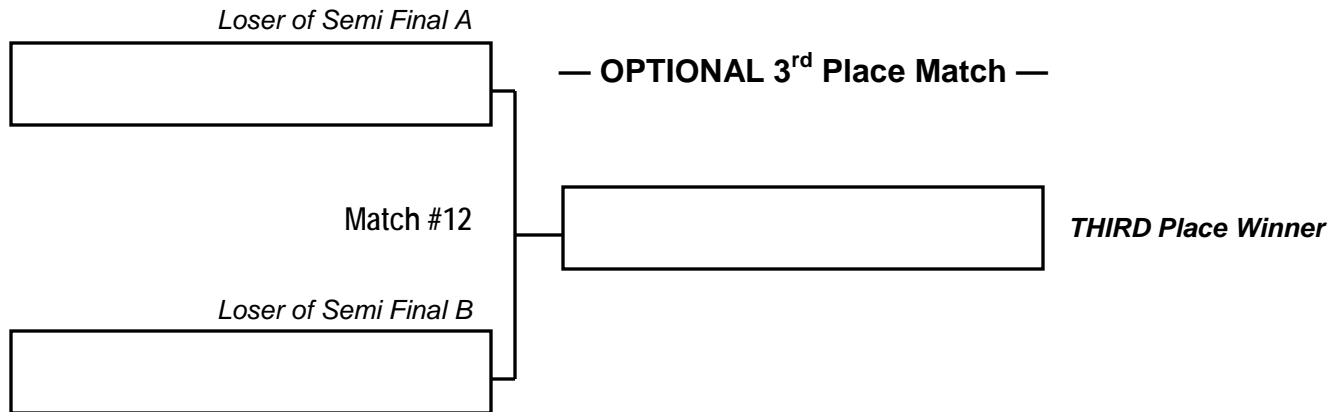

1 st	
2 nd	
3 rd	
4 th	

MAT: _____ Name: _____ Signature: _____

2014 Europa Super Show Texas

Division: [NOV-15-17-B999] Teen NO GI >> Novice (0-1 yrs) >> 15 to 17 years >> BOYS 180 lbs and up

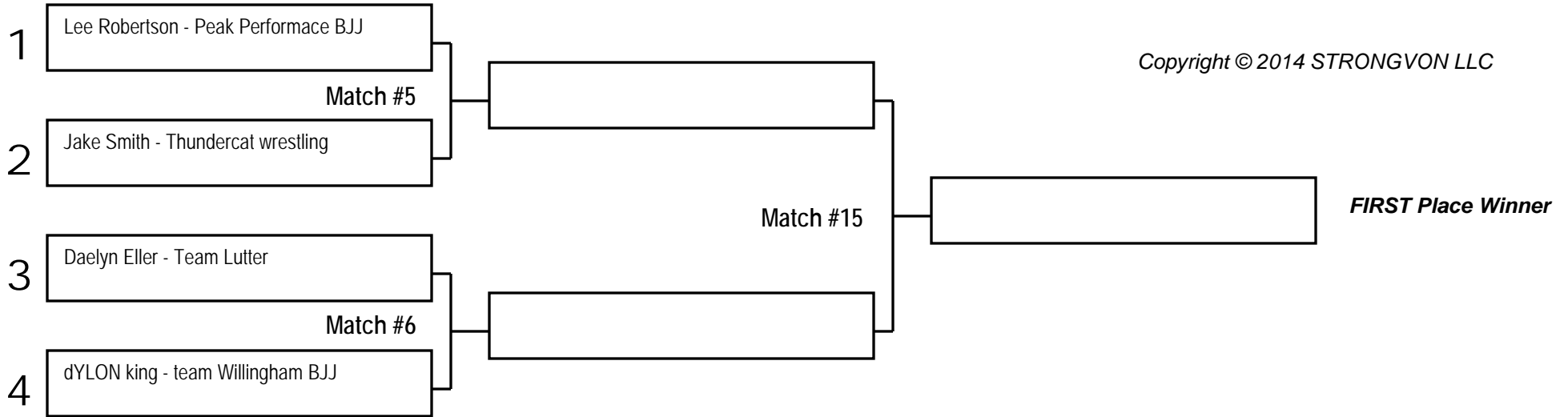

Mat 10

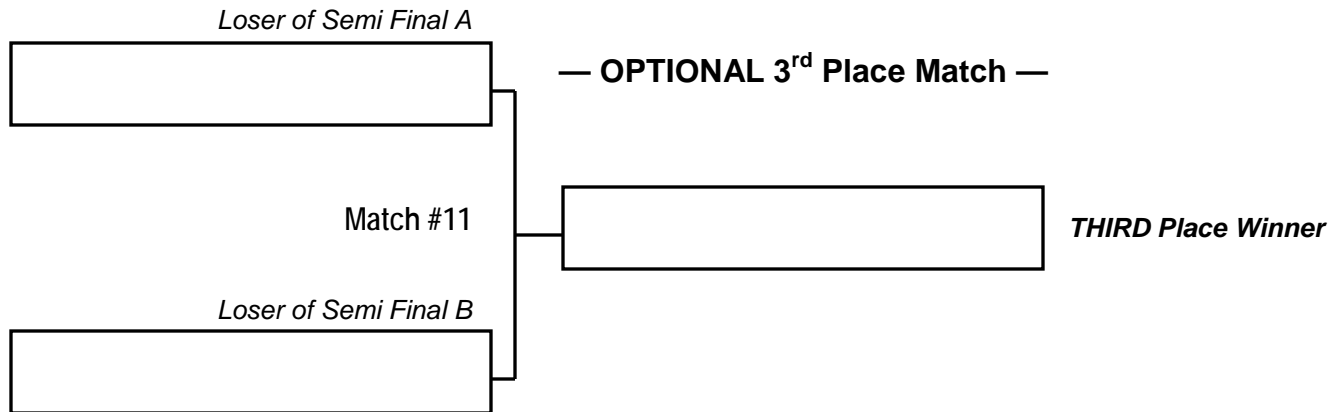

1 st	
2 nd	
3 rd	
4 th	

MAT: _____ Name: _____ Signature: _____

2014 Europa Super Show Texas

Division: [BEG-13-14-B105] Teen NO GI >> Beginner (1-3 yrs) >> 13 to 14 years >> BOYS 95-105.9 lbs

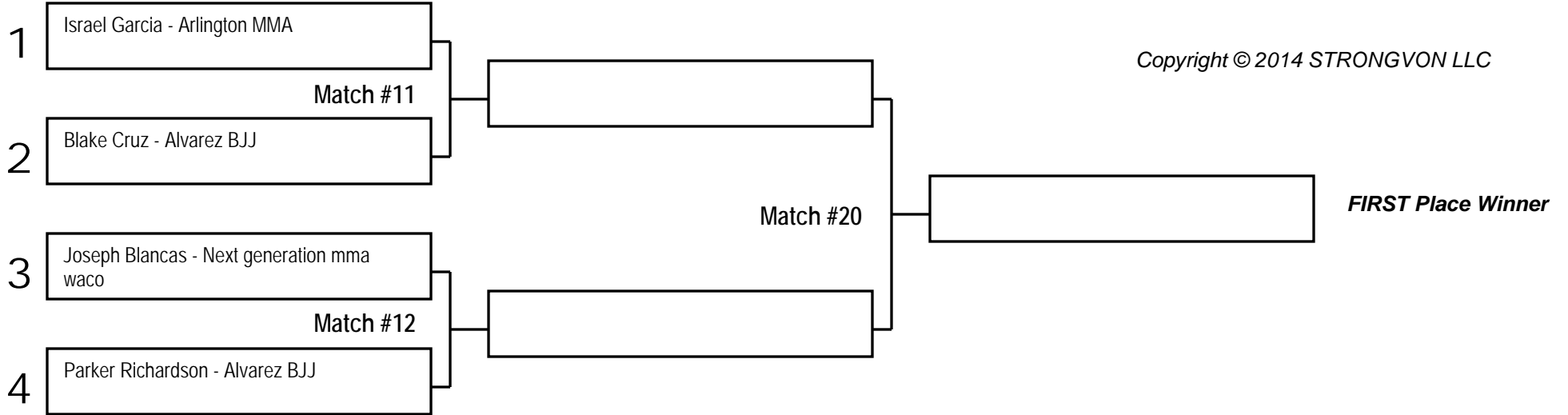

Mat 7

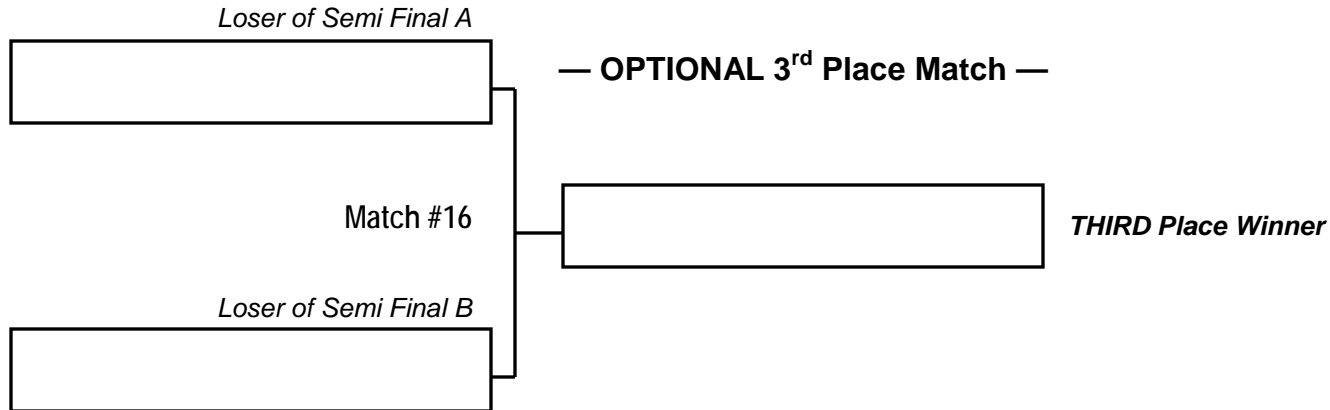

1 st	
2 nd	
3 rd	
4 th	

MAT: _____ Name: _____ Signature: _____

2014 Europa Super Show Texas

Division: [BEG-13-14-B134] Teen NO GI >> Beginner (1-3 yrs) >> 13 to 14 years >> BOYS 120-134.9 lbs

Copyright © 2014 STRONGVON LLC

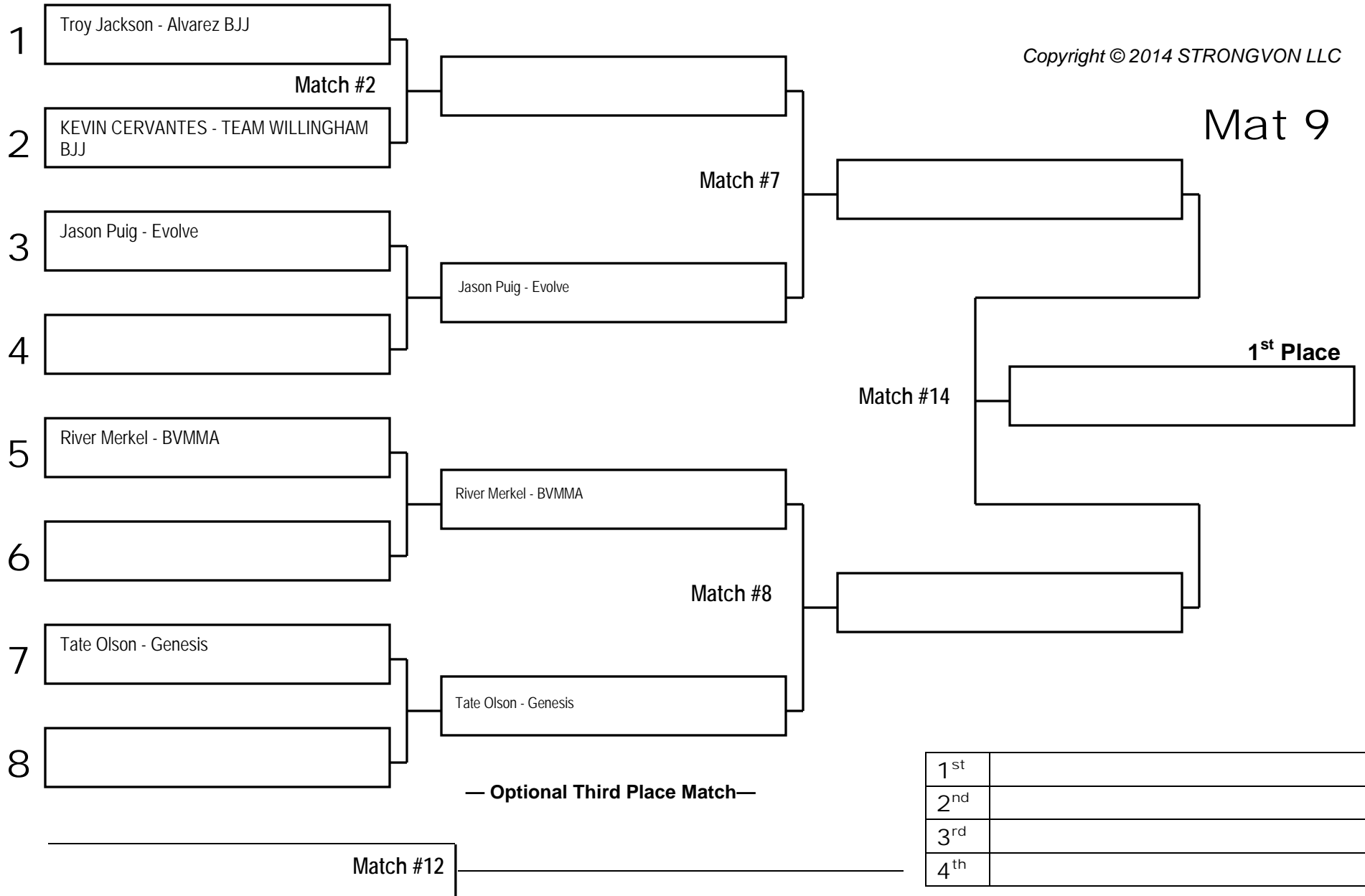

1 st	
2 nd	
3 rd	
4 th	

MAT: _____ Name: _____ Signature: _____

2014 Europa Super Show Texas

Division: [BEG-13-14-B149] Teen NO GI >> Beginner (1-3 yrs) >> 13 to 14 years >> BOYS 135-149.9 lbs

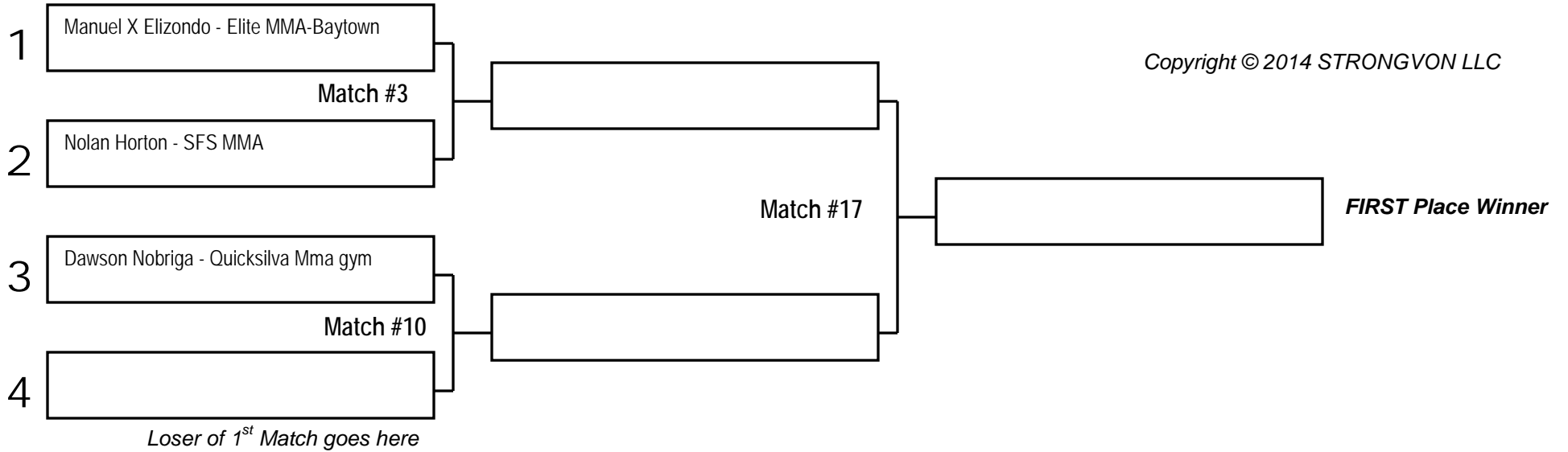

Mat 8

MAT: _____ Name: _____ Signature: _____

1 st	
2 nd	
3 rd	

2014 Europa Super Show Texas

Division: [BEG-15-17-B134] Teen NO GI >> Beginner (1-3 yrs) >> 15 to 17 years >> BOYS 120-134.9 lbs

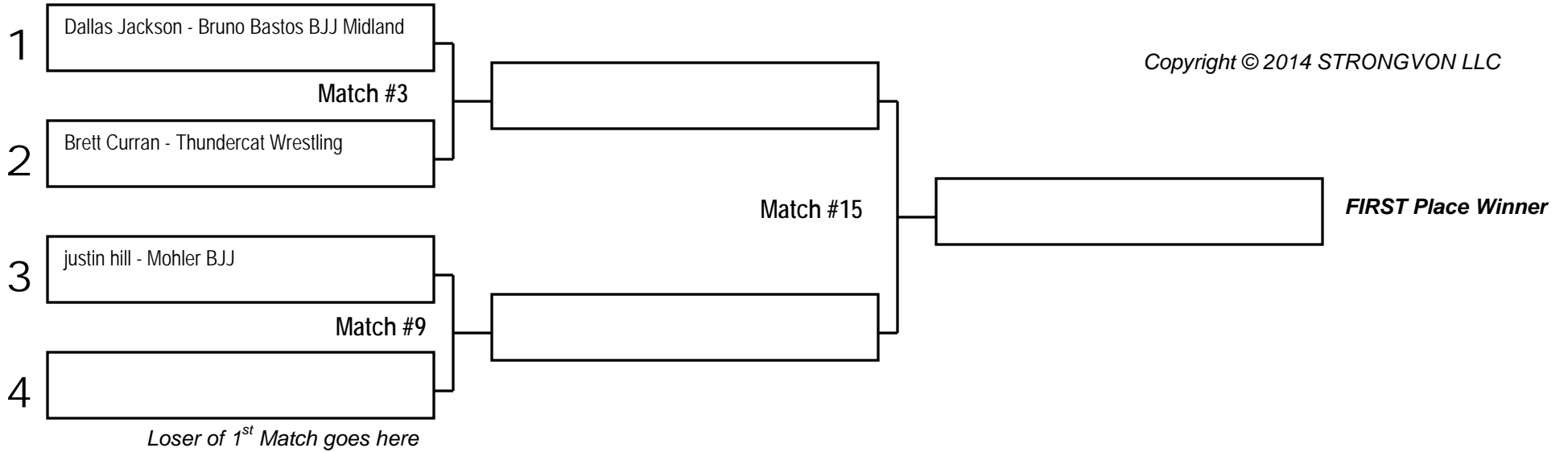

Mat 9

MAT: _____ Name: _____ Signature: _____

1 st	
2 nd	
3 rd	

2014 Europa Super Show Texas

Division: [BEG-15-17-G999] Teen NO GI >> Beginner (1-3 yrs) >> 15 to 17 years >> GIRLS 130 lbs and Over

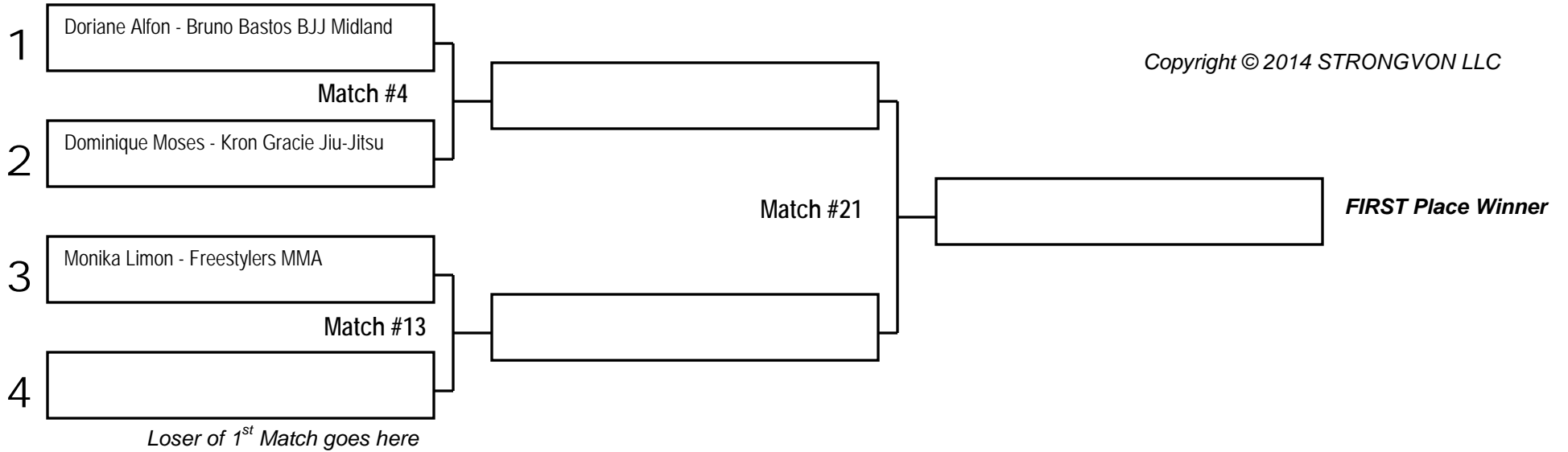

Mat 7

MAT: _____ Name: _____ Signature: _____

1 st	
2 nd	
3 rd	

2014 Europa Super Show Texas

Division: [INT-13-14-B119] Teen NO GI >> Intermediate (over 3 yrs) >> 13 to 14 years >> BOYS 106-119.9 lbs

Copyright © 2014 STRONGVON LLC

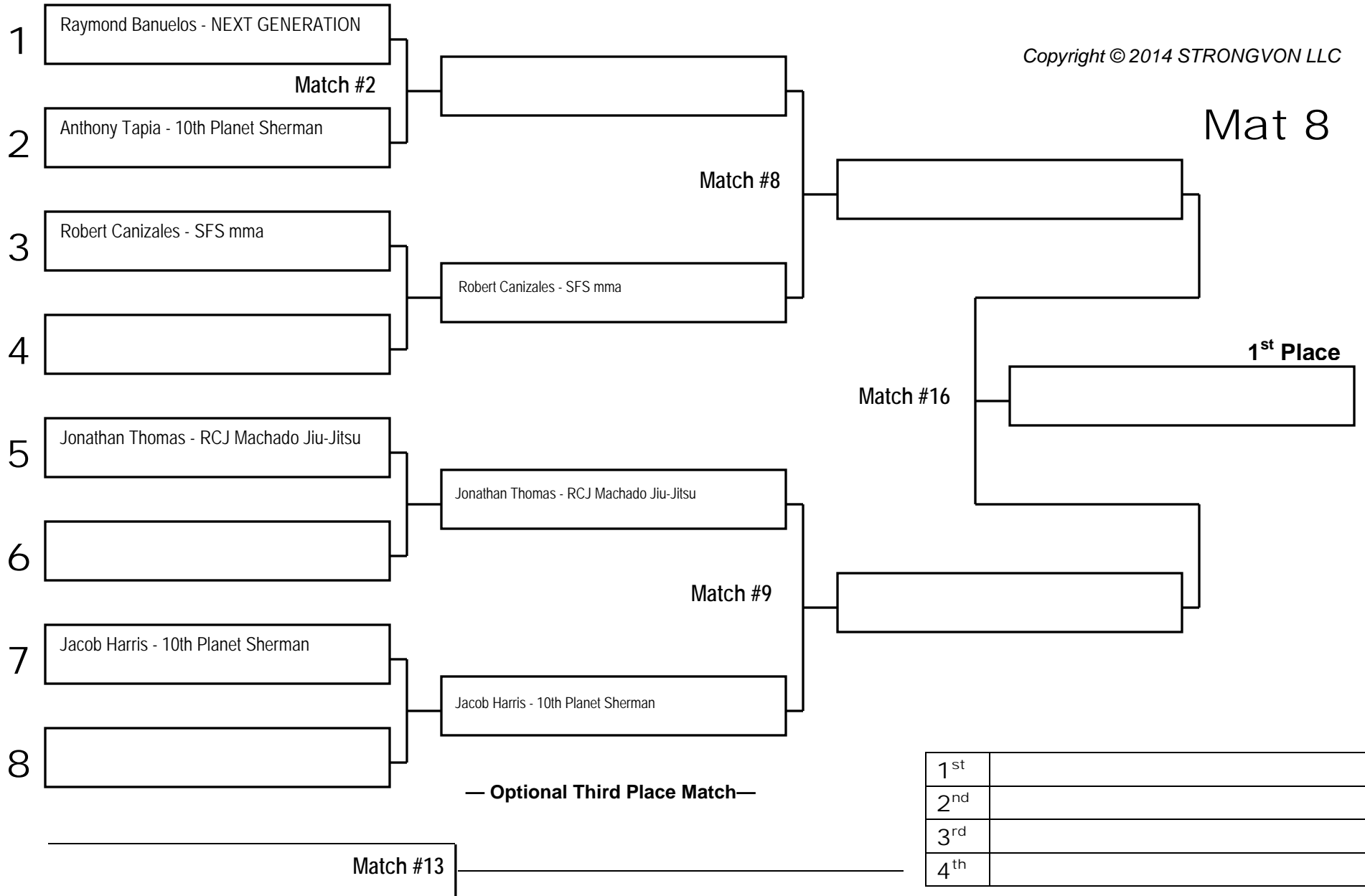

1 st	
2 nd	
3 rd	
4 th	

MAT: _____ Name: _____ Signature: _____

2014 Europa Super Show Texas

Division: [INT-13-14-B134] Teen NO GI >> Intermediate (over 3 yrs) >> 13 to 14 years >> BOYS 120-134.9 lbs

Copyright © 2014 STRONGVON LLC

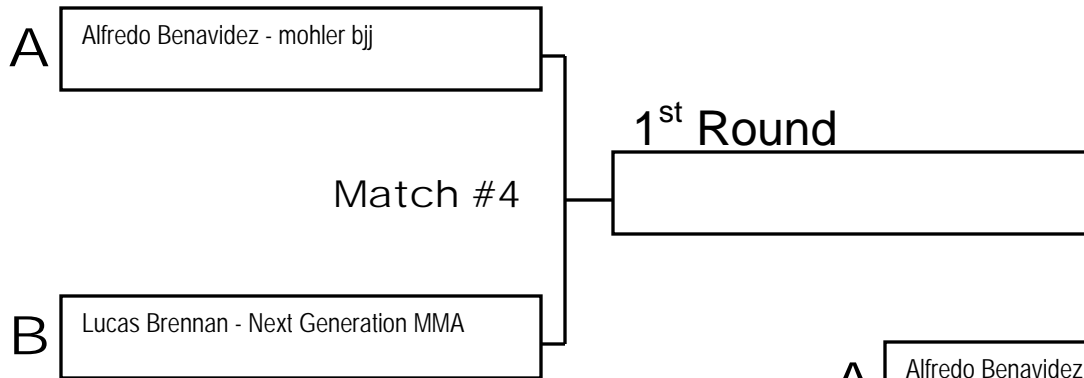

Mat 9

—Best of 3 Matches—

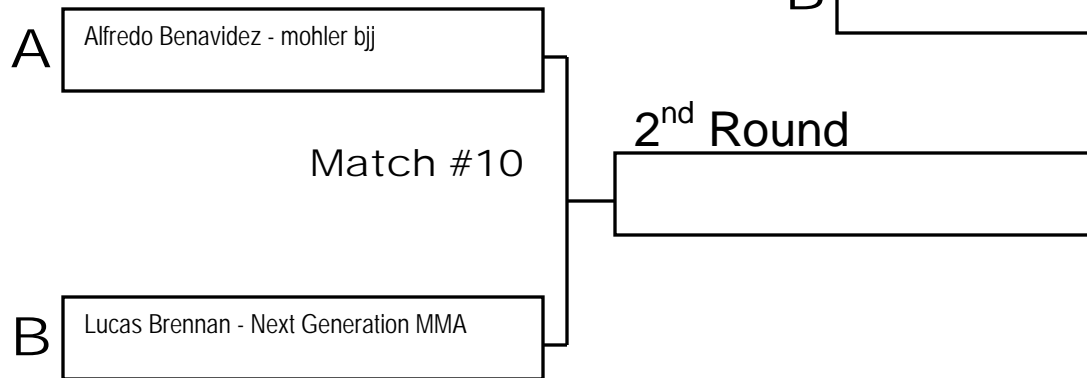
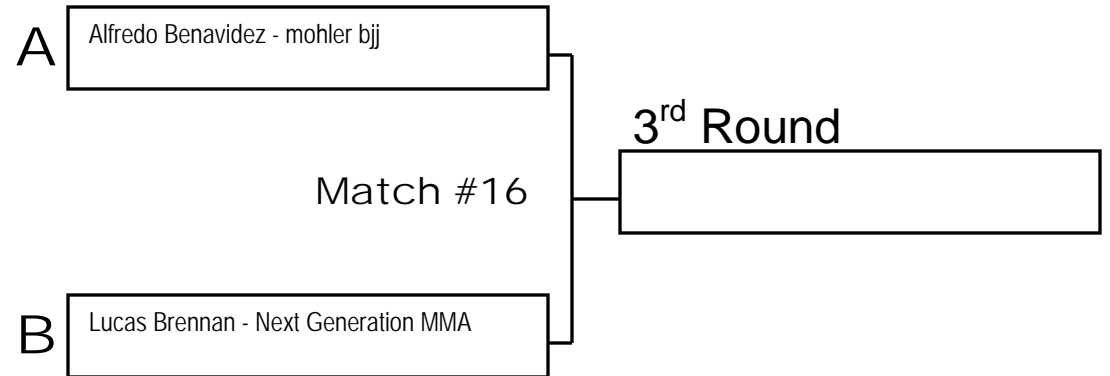

1st

2nd

MAT: _____ Name: _____ Signature: _____

2014 Europa Super Show Texas

Division: [INT-15-17-B134] Teen NO GI >> Intermediate (over 3 yrs) >> 15 to 17 years >> BOYS 120-134.9 lbs

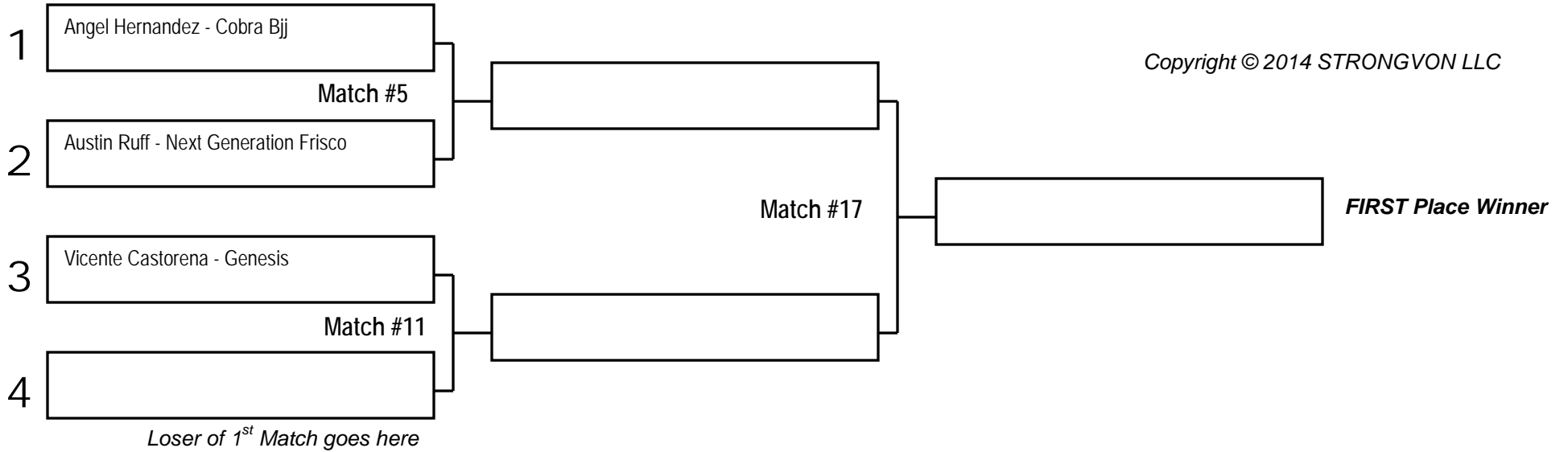

Mat 9

MAT: _____ Name: _____ Signature: _____

1 st	
2 nd	
3 rd	

2014 Europa Super Show Texas

Division: [NOV-7yr-44] Children NO GI >> Novice (0-1 yrs) >> Ages 5-7 years 0-44.9 lbs

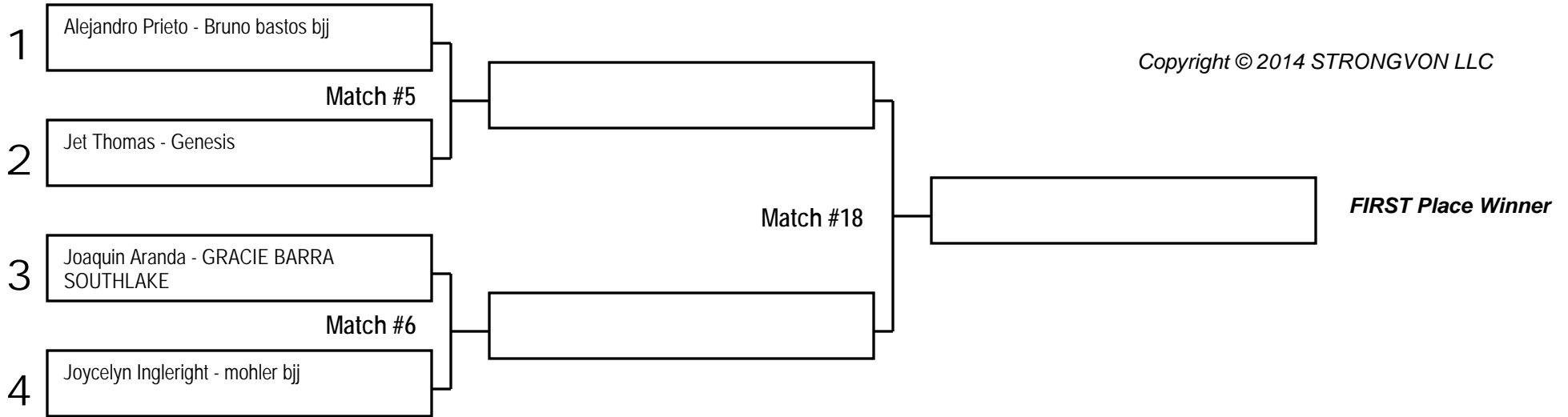

Mat 1

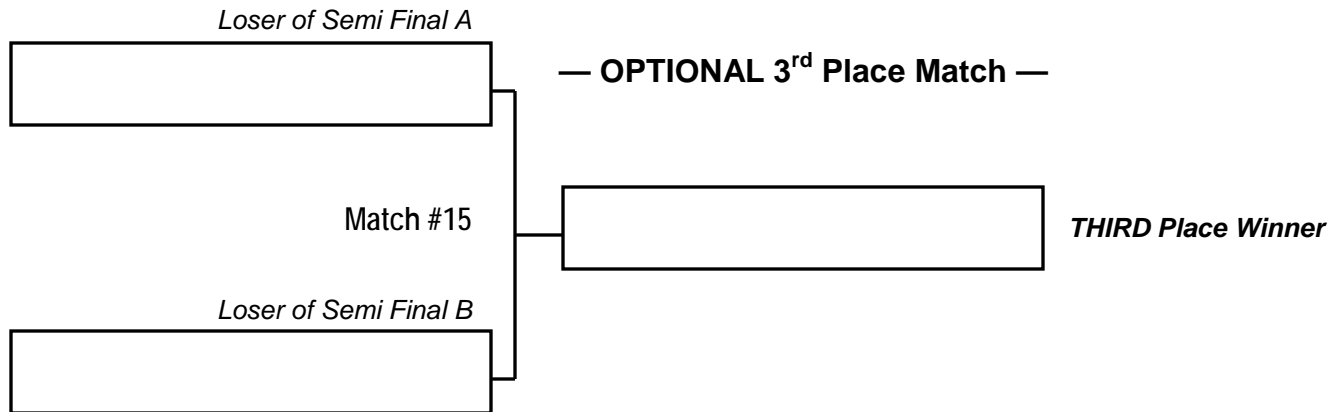

1 st	
2 nd	
3 rd	
4 th	

MAT: _____ Name: _____ Signature: _____

2014 Europa Super Show Texas

Division: [NOV-7yr-49] Children NO GI >> Novice (0-1 yrs) >> Ages 5-7 years 45-49.9 lbs

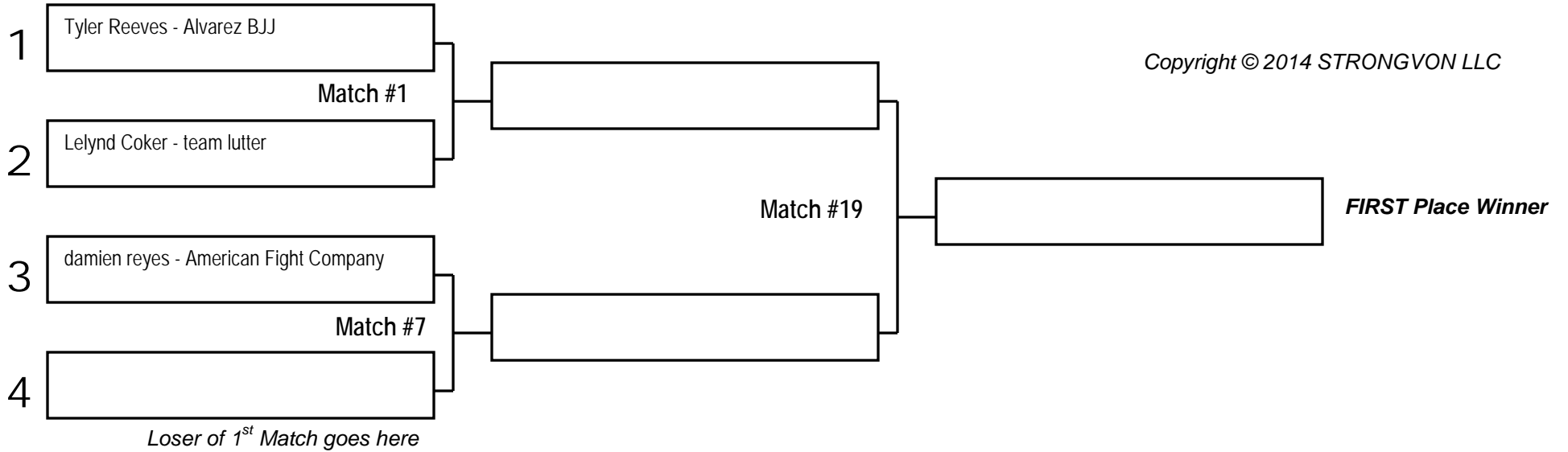

Mat 1

MAT: _____ Name: _____ Signature: _____

1 st	
2 nd	
3 rd	

2014 Europa Super Show Texas

Division: [NOV-7yr-59] Children NO GI >> Novice (0-1 yrs) >> Ages 5-7 years 50-59.9 lbs

Copyright © 2014 STRONGVON LLC

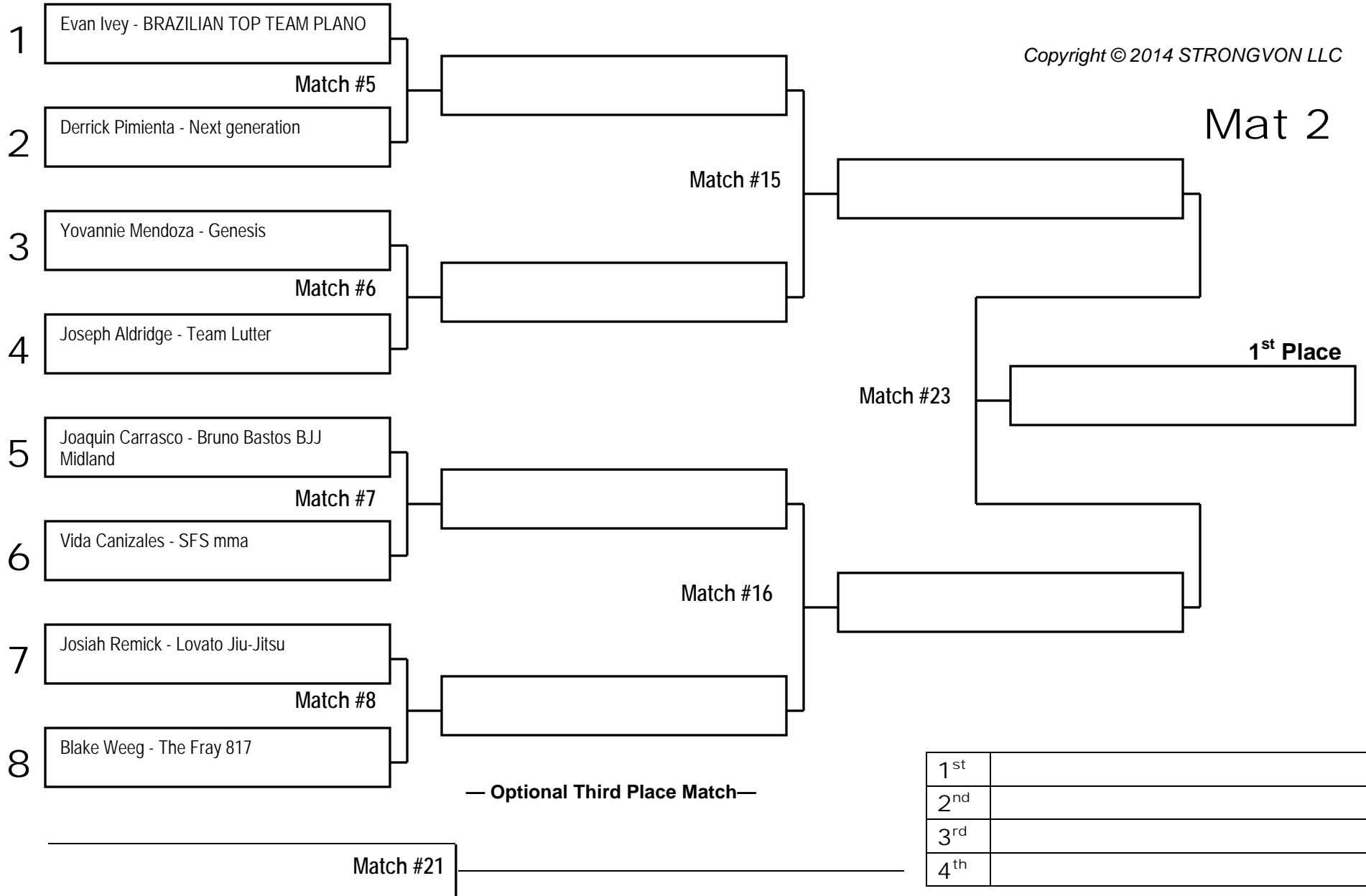

MAT: _____ Name: _____ Signature: _____

2014 Europa Super Show Texas

Division: [NOV-7yr-69] Children NO GI >> Novice (0-1 yrs) >> Ages 5-7 years 60-69.9 lbs

Copyright © 2014 STRONGVON LLC

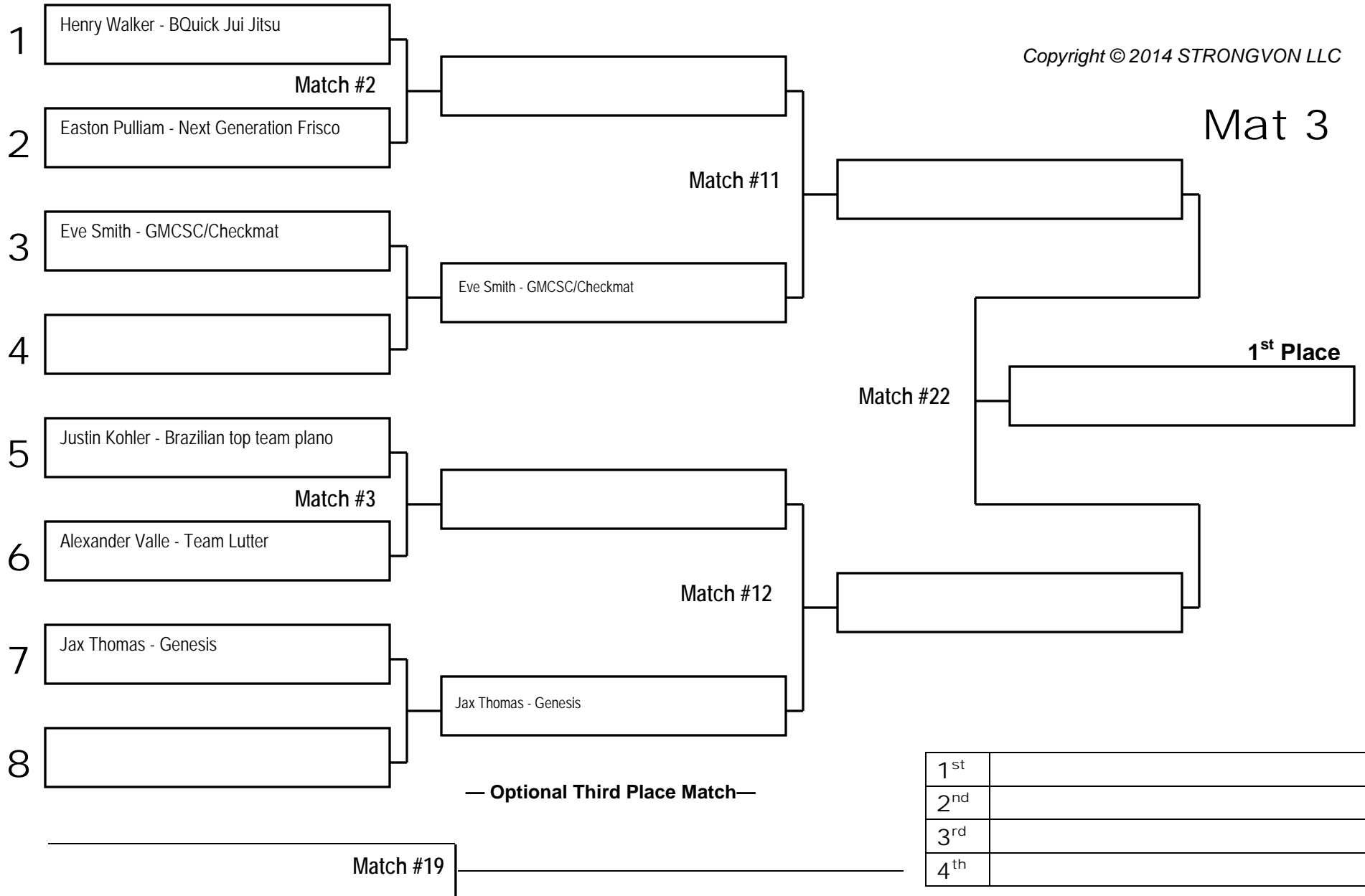

1 st	
2 nd	
3 rd	
4 th	

MAT: _____ Name: _____ Signature: _____

2014 Europa Super Show Texas

Division: [NOV-10yr-49] Children NO GI >> Novice (0-1 yrs) >> Age 10 years and under 45-49.9 lbs

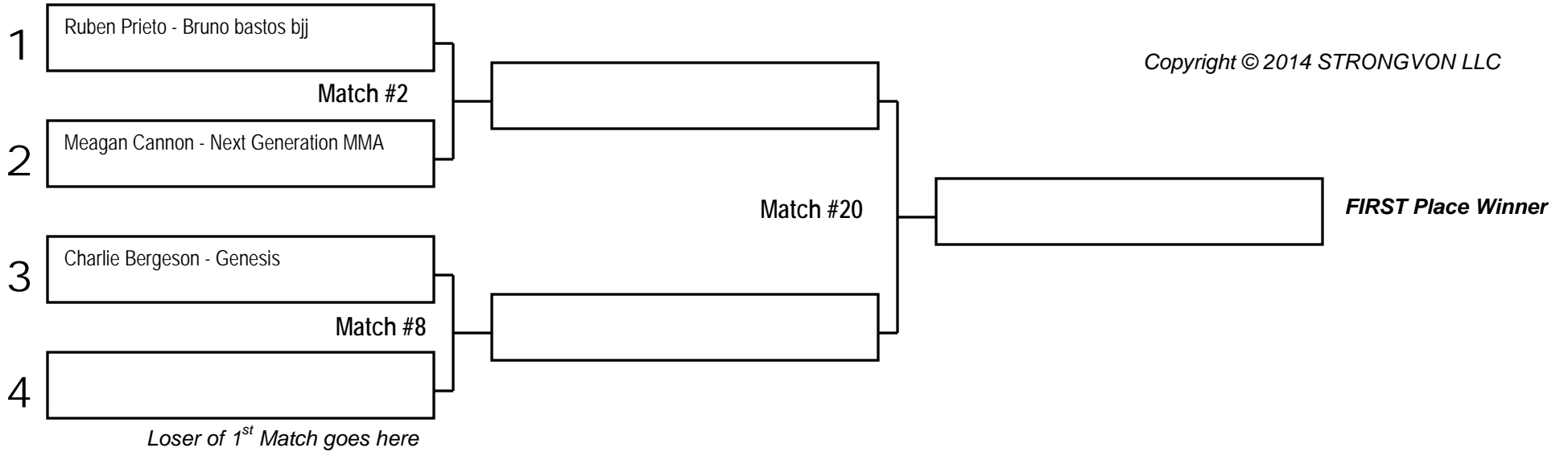

Mat 1

MAT: _____ Name: _____ Signature: _____

1 st	
2 nd	
3 rd	

2014 Europa Super Show Texas

Division: [NOV-10yr-59] Children NO GI >> Novice (0-1 yrs) >> Age 10 years and under 50-59.9 lbs

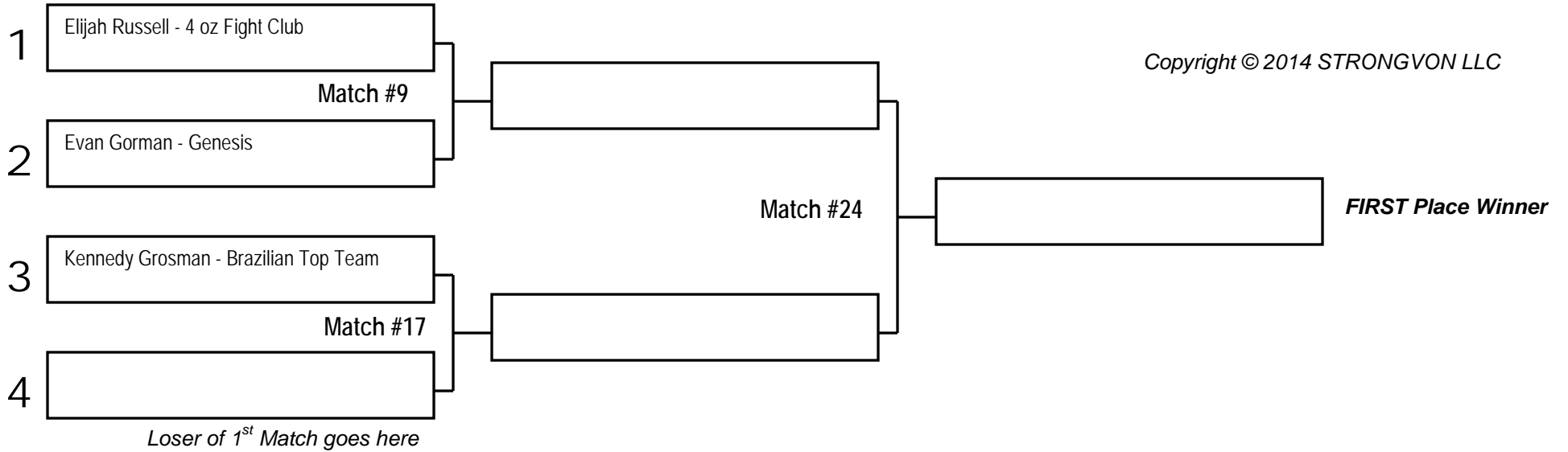

Mat 2

MAT: _____ Name: _____ Signature: _____

1 st	
2 nd	
3 rd	

2014 Europa Super Show Texas

Division: [NOV-10yr-69] Children NO GI >> Novice (0-1 yrs) >> Age 10 years and under 60-69.9 lbs

Copyright © 2014 STRONGVON LLC

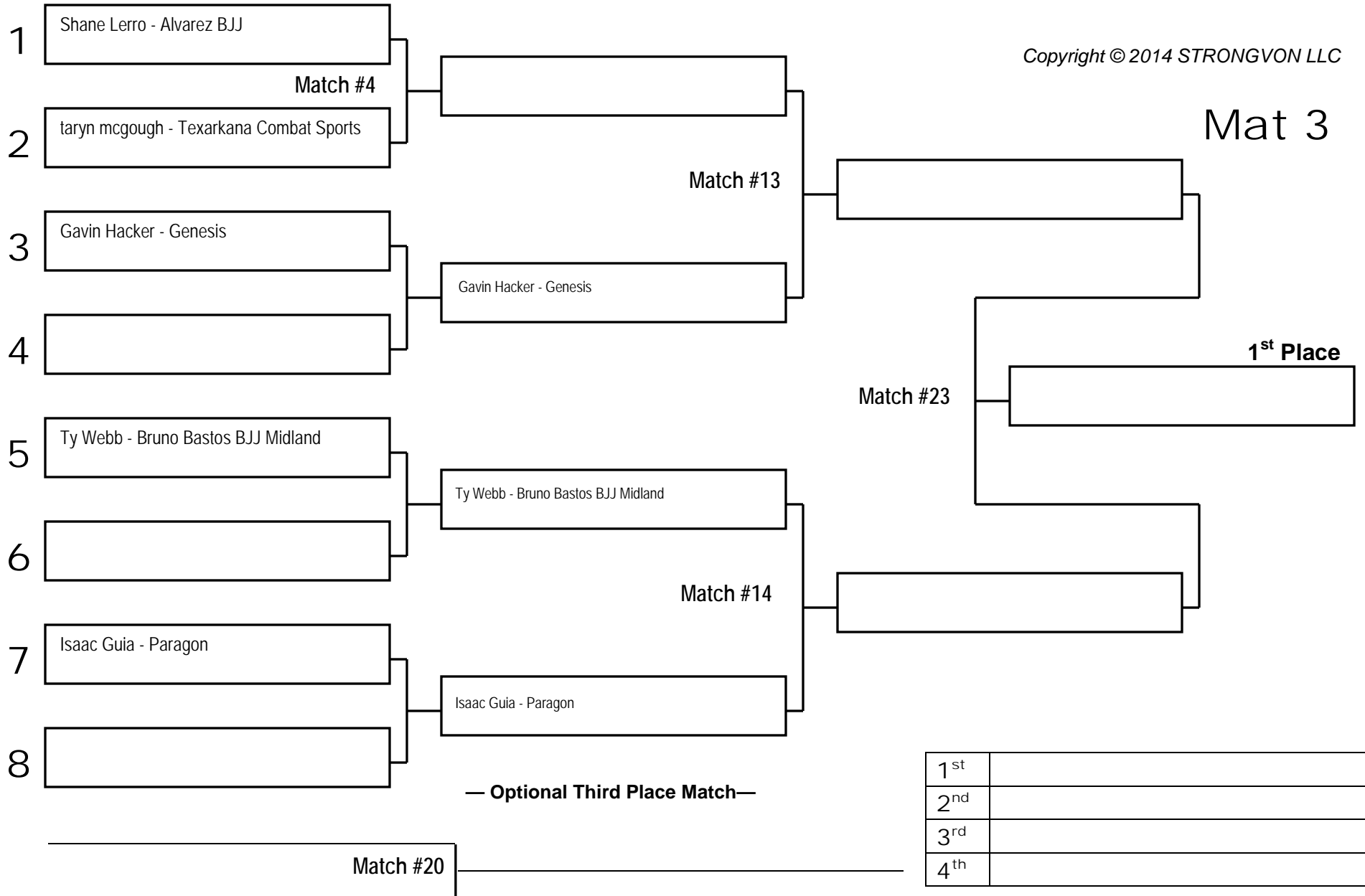

1 st	
2 nd	
3 rd	
4 th	

MAT: _____ Name: _____ Signature: _____

2014 Europa Super Show Texas

Division: [NOV-10yr-79] Children NO GI >> Novice (0-1 yrs) >> Age 10 years and under 70-79.9 lbs

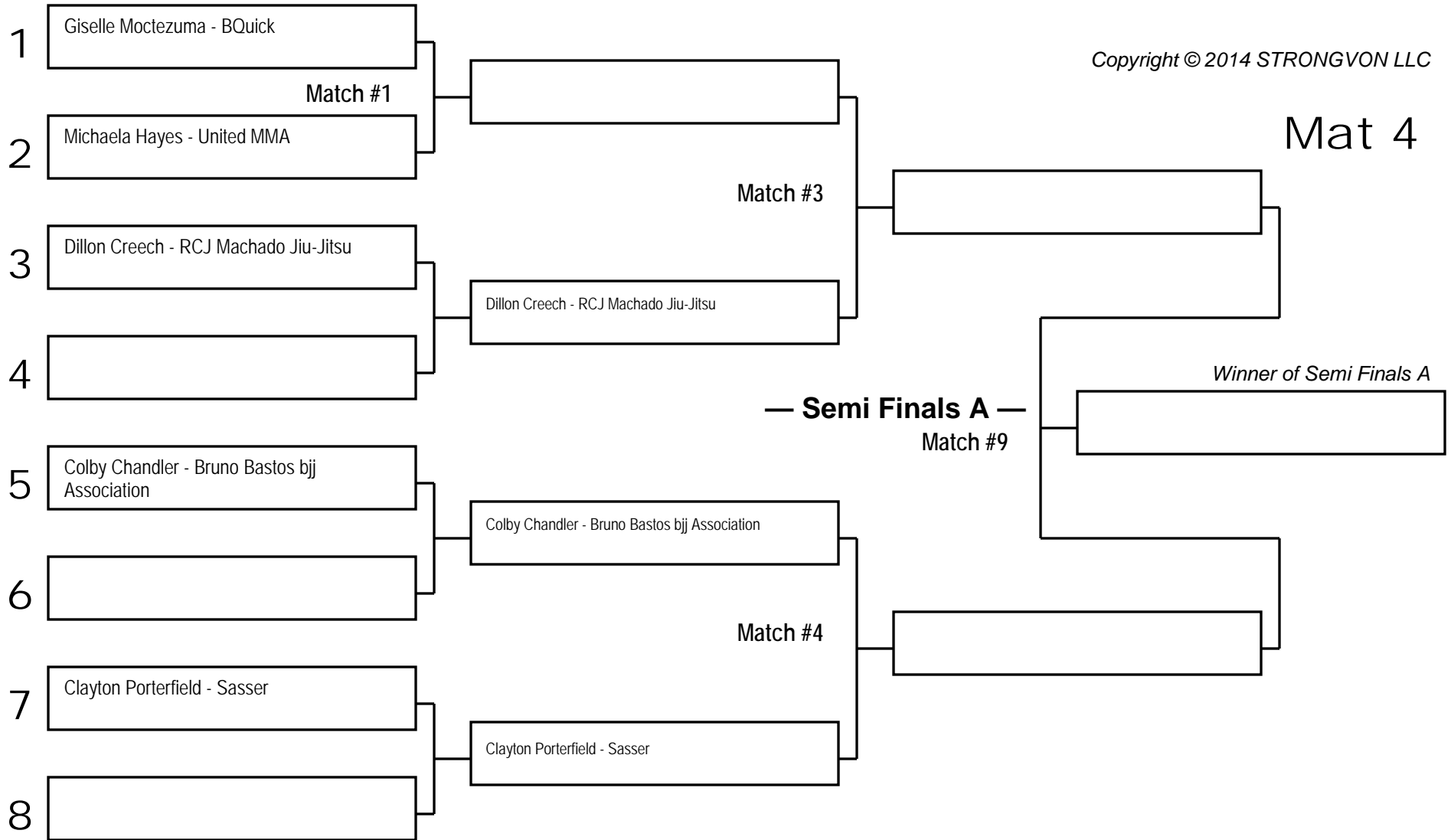

— GROUP A —

Please copy winner into Finals on Page 3

MAT: _____ Name: _____ Signature: _____

2014 Europa Super Show Texas

Division: [NOV-10yr-79] Children NO GI >> Novice (0-1 yrs) >> Age 10 years and under 70-79.9 lbs

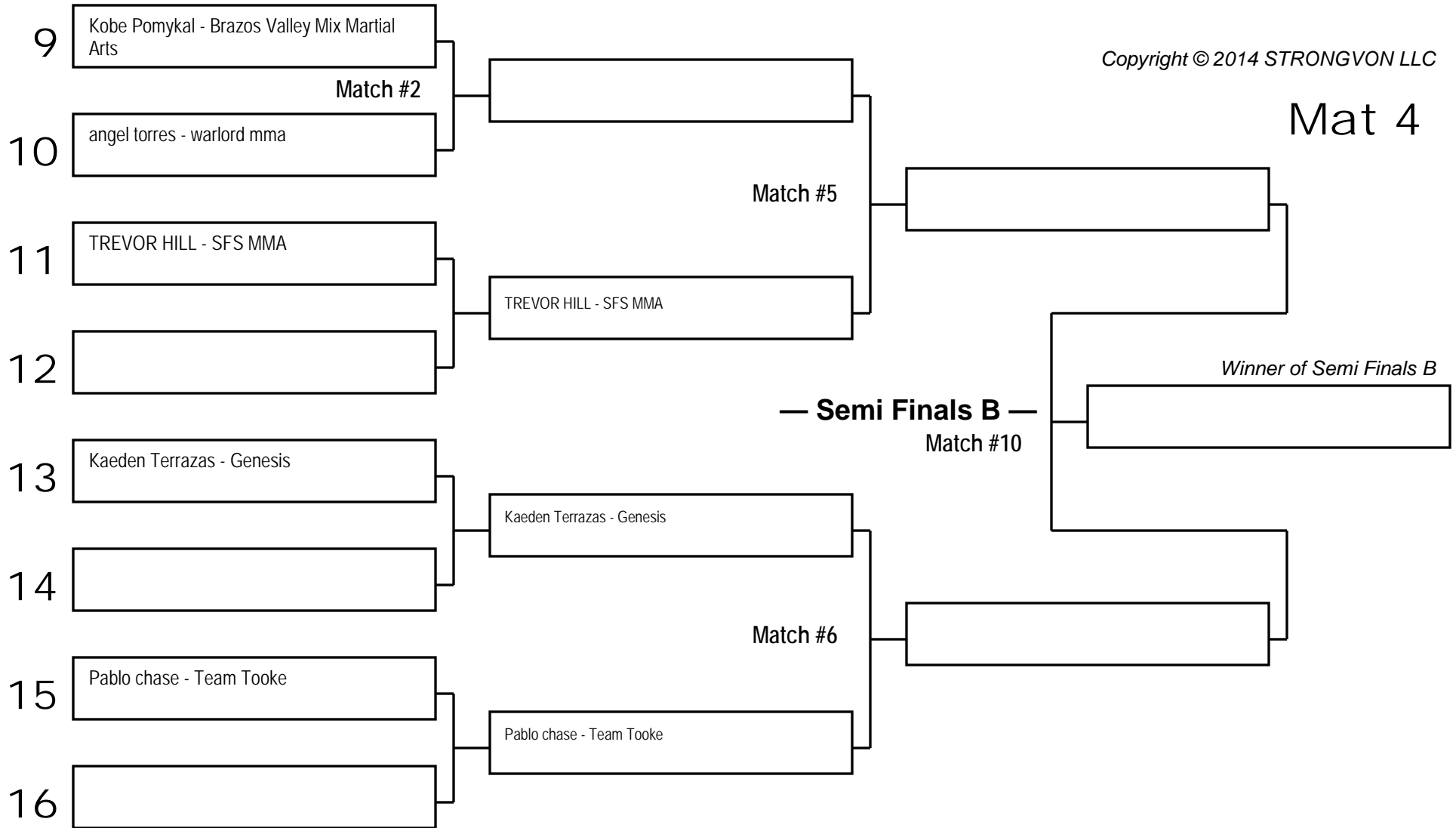

Copyright © 2014 STRONGVON LLC

Mat 4

Winner of Semi Finals B

— Semi Finals B —
Match #10

— GROUP B —

Please copy winner into Finals on Page 3

MAT: _____ Name: _____ Signature: _____

2014 Europa Super Show Texas

Division: [NOV-10yr-79] Children NO GI >> Novice (0-1 yrs) >> Age 10 years and under 70-79.9 lbs

Copyright © 2014 STRONGVON LLC

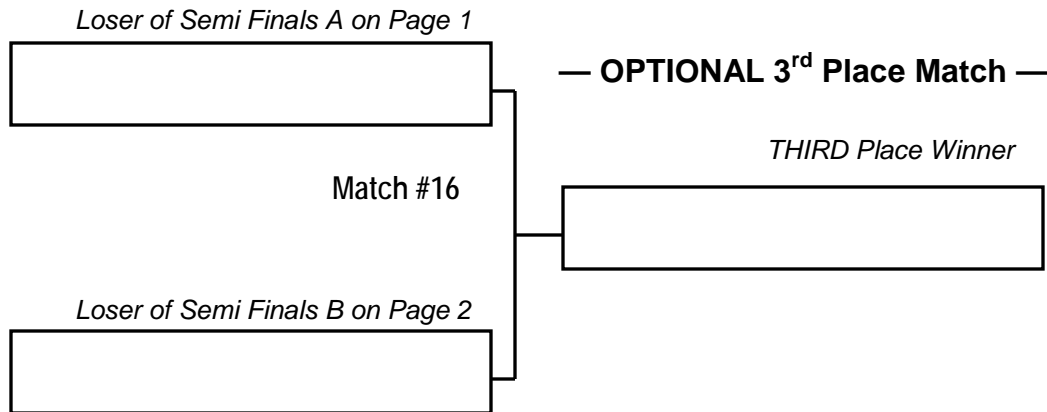
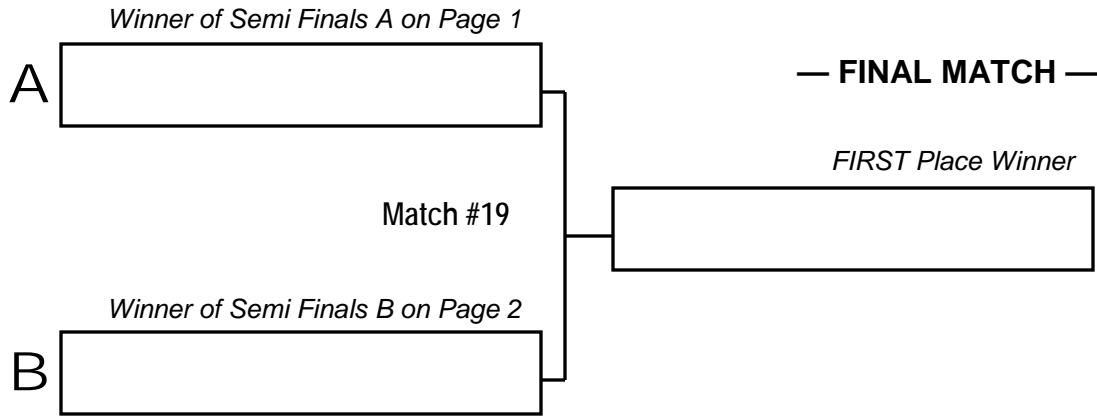

Mat 4

1 st	<input type="text"/>
2 nd	<input type="text"/>
3 rd	<input type="text"/>
4 th	<input type="text"/>

MAT: _____ Name: _____ Signature: _____

2014 Europa Super Show Texas

Division: [NOV-10yr-89] Children NO GI >> Novice (0-1 yrs) >> Age 10 years and under 80-89.9 lbs

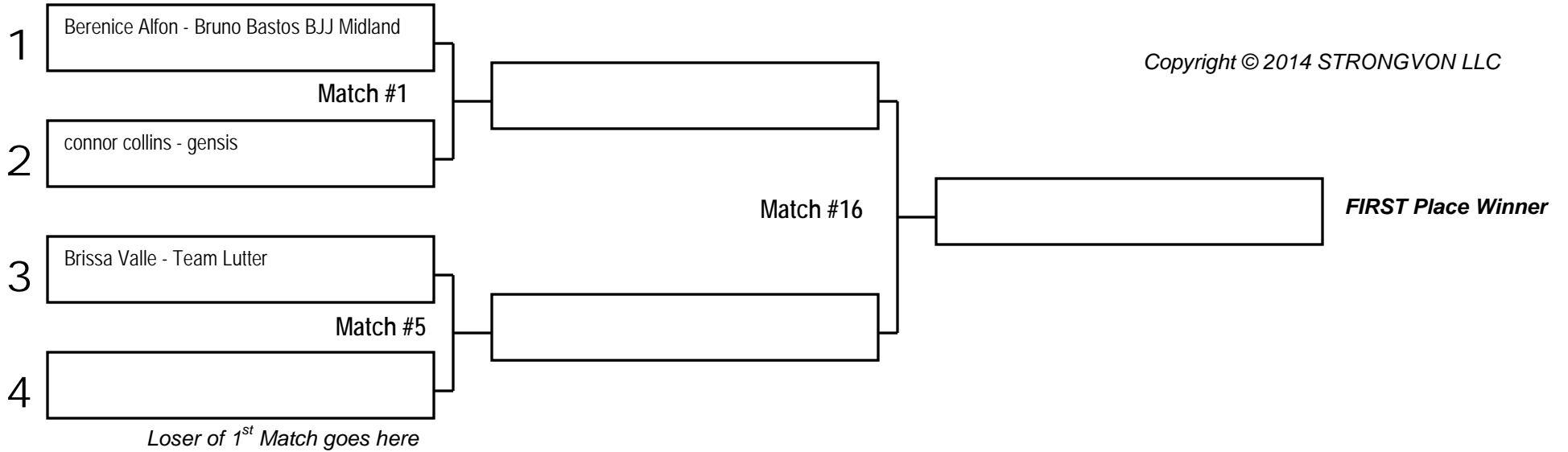

Mat 5

MAT: _____ Name: _____ Signature: _____

1 st	
2 nd	
3 rd	

2014 Europa Super Show Texas

Division: [NOV-10yr-99] Children NO GI >> Novice (0-1 yrs) >> Age 10 years and under 90-99.9 lbs

Copyright © 2014 STRONGVON LLC

Mat 6

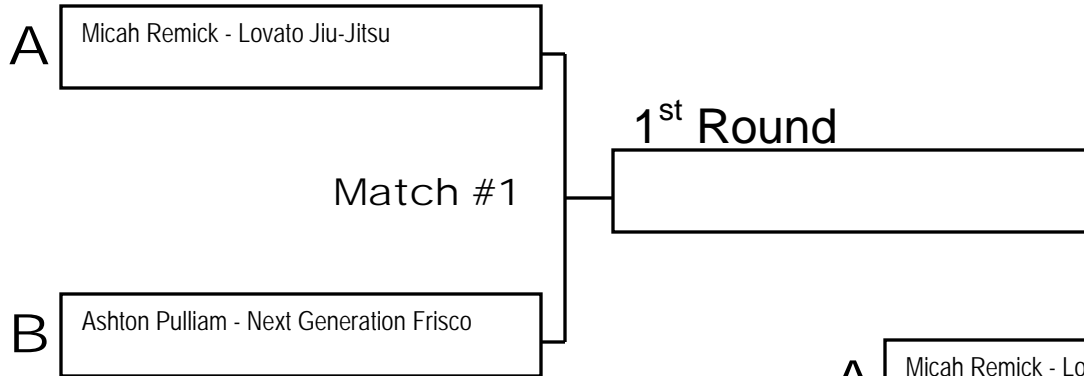

—Best of 3 Matches—

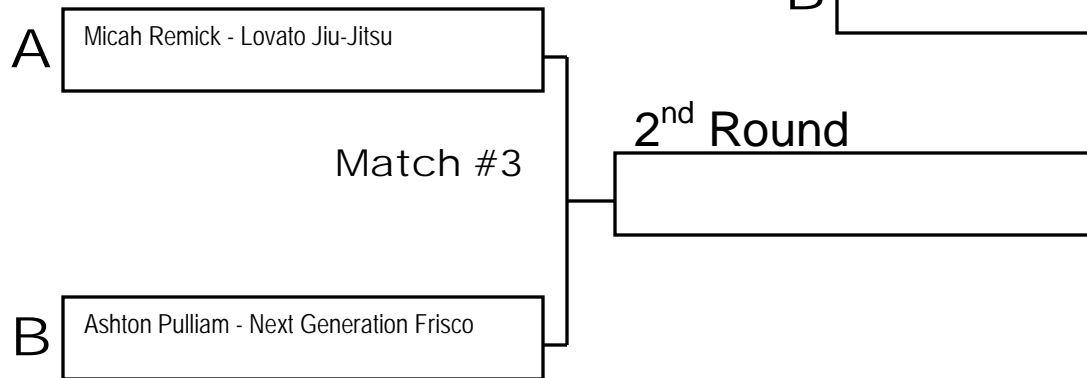
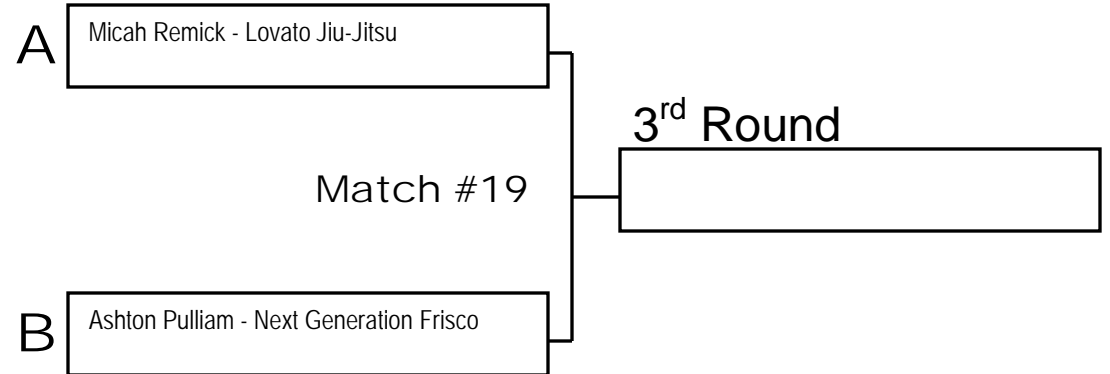

1st

2nd

MAT: _____ Name: _____ Signature: _____

2014 Europa Super Show Texas

Division: [NOV-12yr-69] Children NO GI >> Novice (0-1 yrs) >> Age 12 years and under 60-69.9 lbs

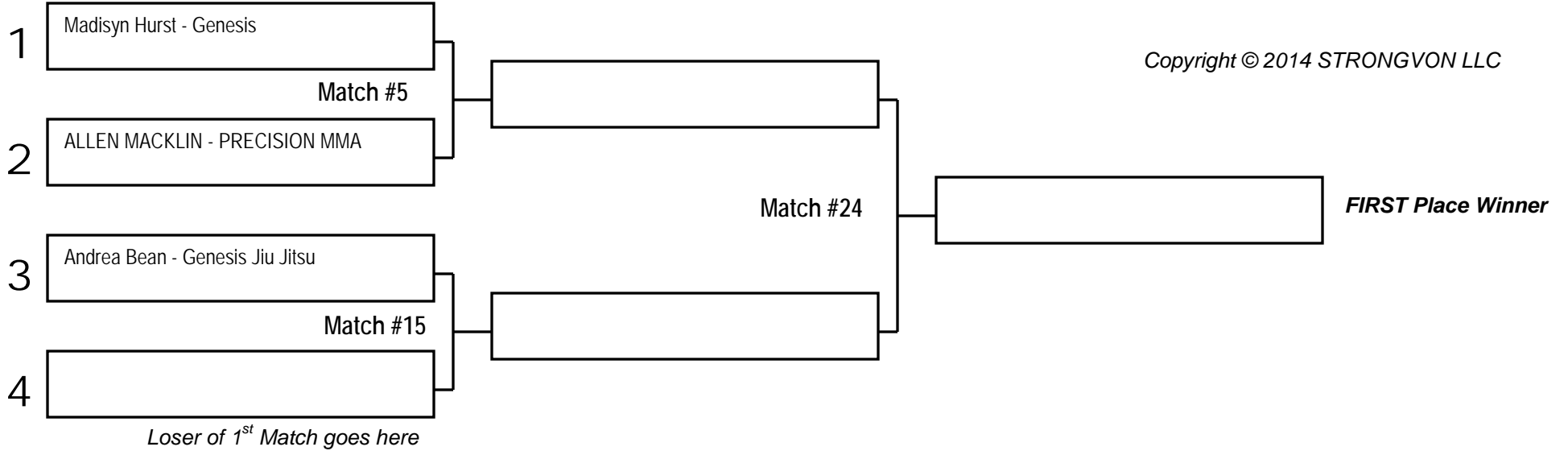

Mat 3

MAT: _____ Name: _____ Signature: _____

1 st	
2 nd	
3 rd	

2014 Europa Super Show Texas

Division: [NOV-12yr-79] Children NO GI >> Novice (0-1 yrs) >> Age 12 years and under 70-79.9 lbs

Copyright © 2014 STRONGVON LLC

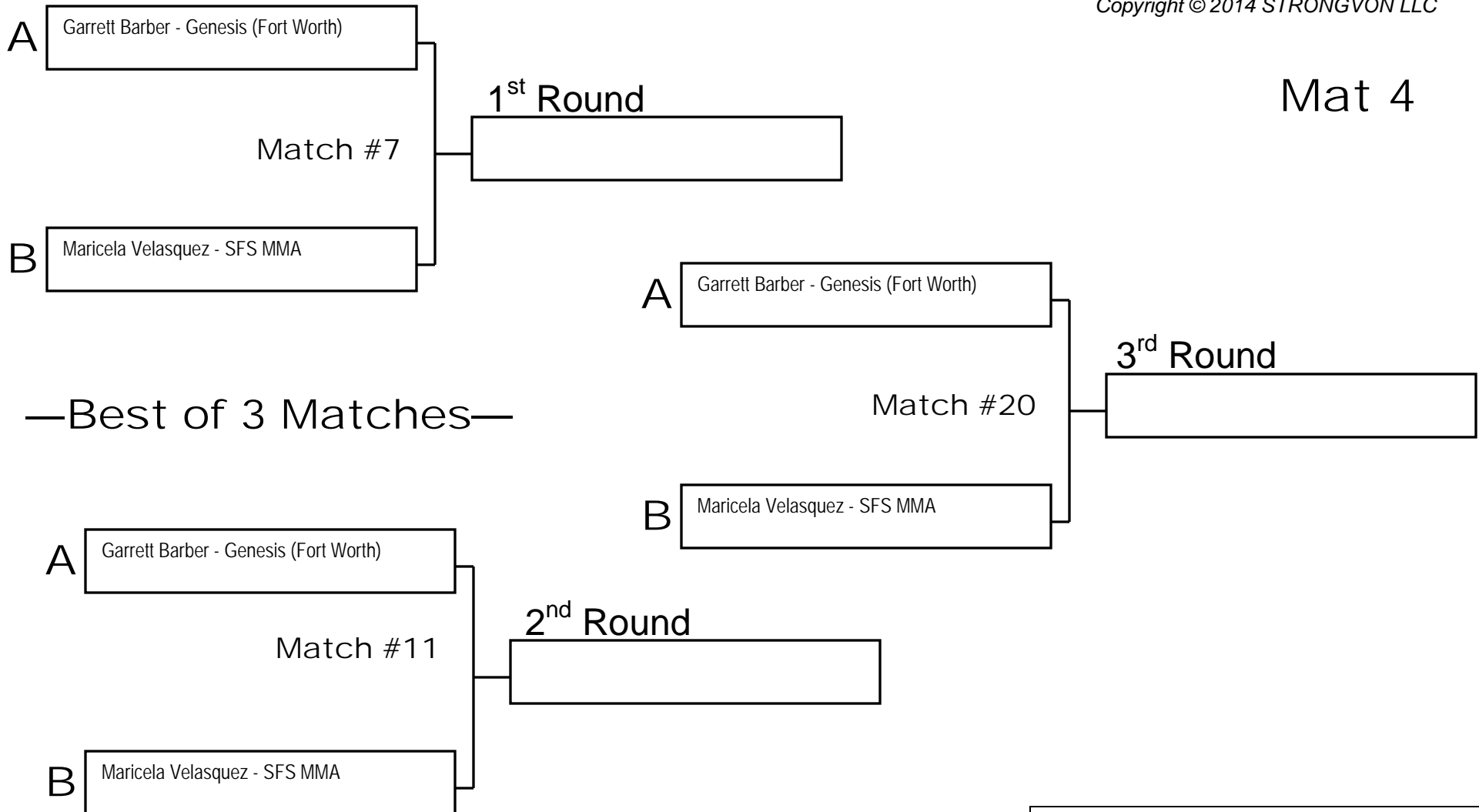

1st

2nd

MAT: _____ Name: _____ Signature: _____

2014 Europa Super Show Texas

Division: [NOV-12yr-89] Children NO GI >> Novice (0-1 yrs) >> Age 12 yrs and under 80-89.9 lbs

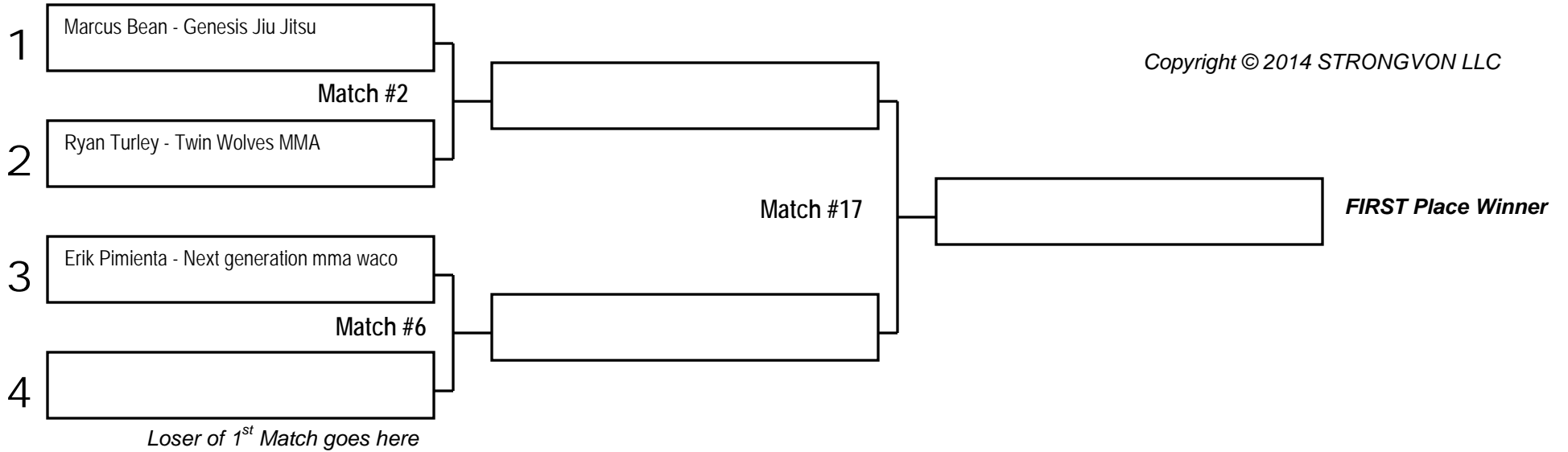

Mat 5

MAT: _____ Name: _____ Signature: _____

1 st	
2 nd	
3 rd	

2014 Europa Super Show Texas

Division: [NOV-12yr-99] Children NO GI >> Novice (0-1 yrs) >> Age 12 years and under 90-99.9 lbs

Copyright © 2014 STRONGVON LLC

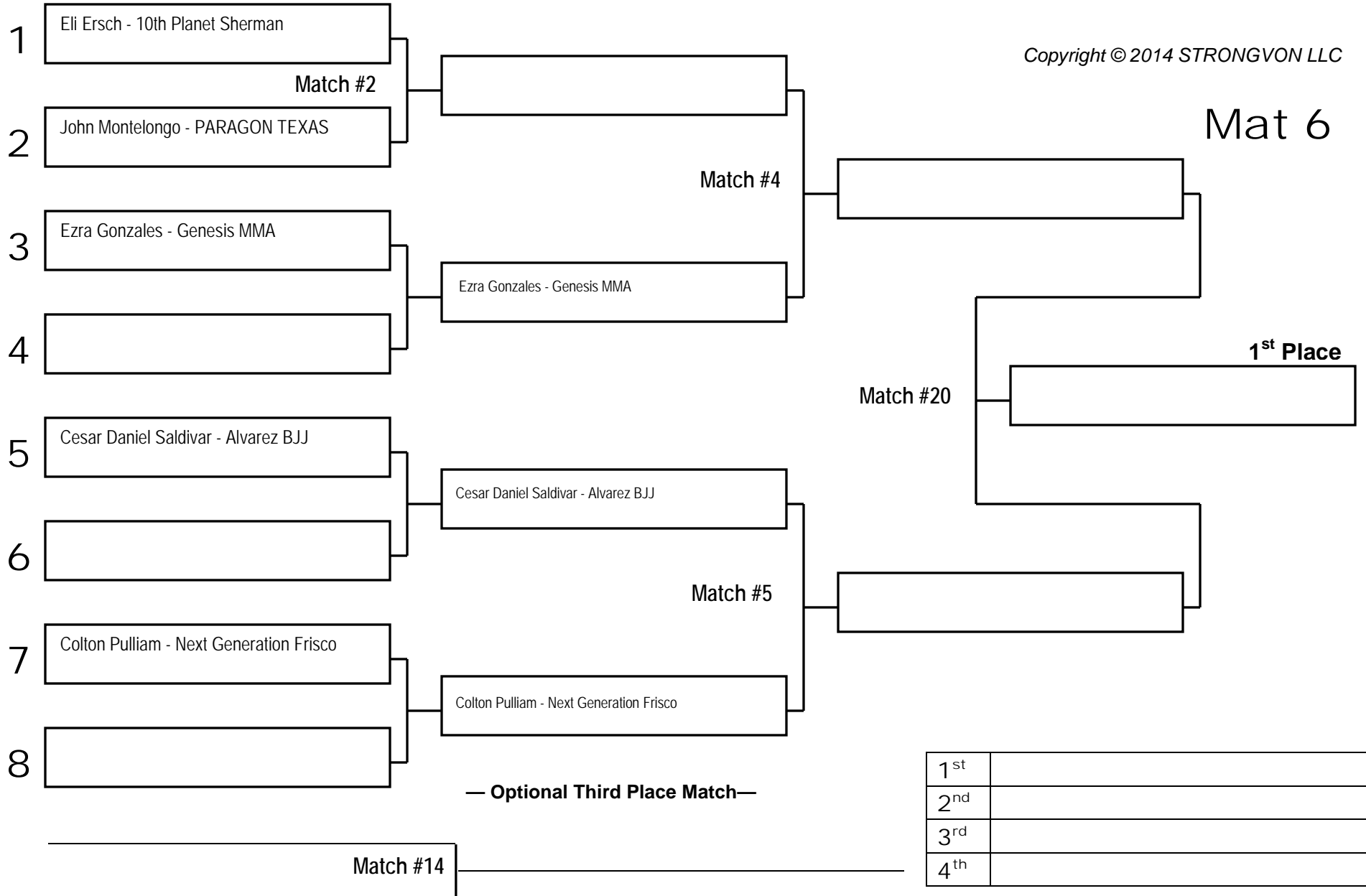

MAT: _____ Name: _____ Signature: _____

2014 Europa Super Show Texas

Division: [NOV-12yr-999] Children NO GI >> Novice (0-1 yrs) >> Age 12 years and under 120 lbs and up

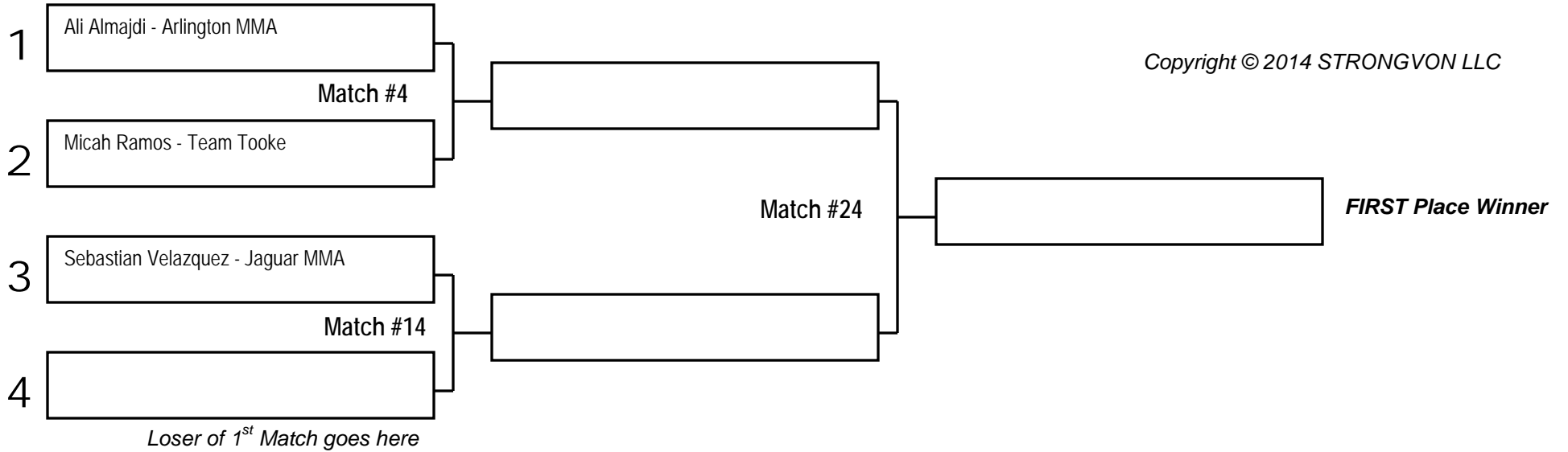

Mat 1

MAT: _____ Name: _____ Signature: _____

1 st	
2 nd	
3 rd	

2014 Europa Super Show Texas

Division: [BEG-7yr-59] Children NO GI >> Beginner (1-3 yrs) >> Ages 5-7 years 50-59.9 lbs

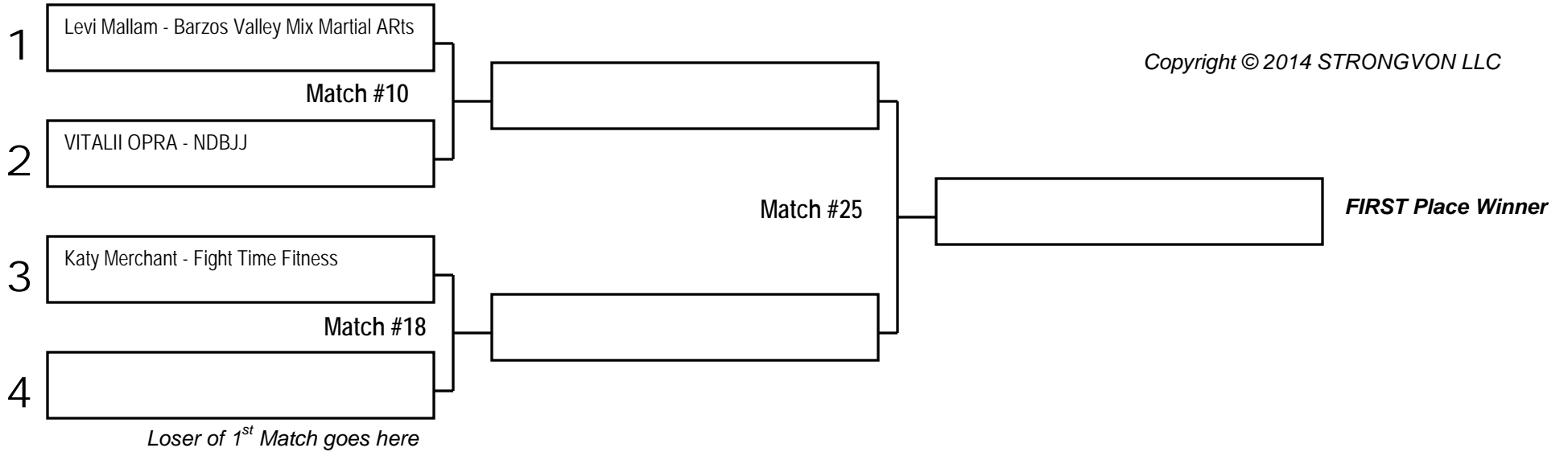

Mat 2

MAT: _____ Name: _____ Signature: _____

1 st	
2 nd	
3 rd	

2014 Europa Super Show Texas

Division: [BEG-10yr-49] Children NO GI >> Beginner (1-3 yrs) >> Age 10 years and under 45-49.9 lbs

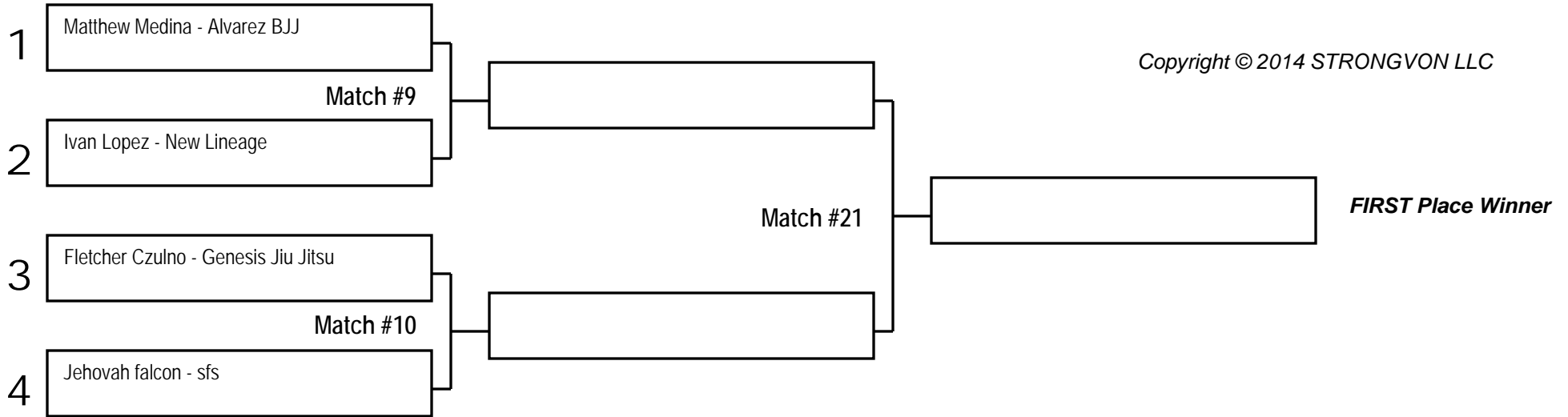

Mat 1

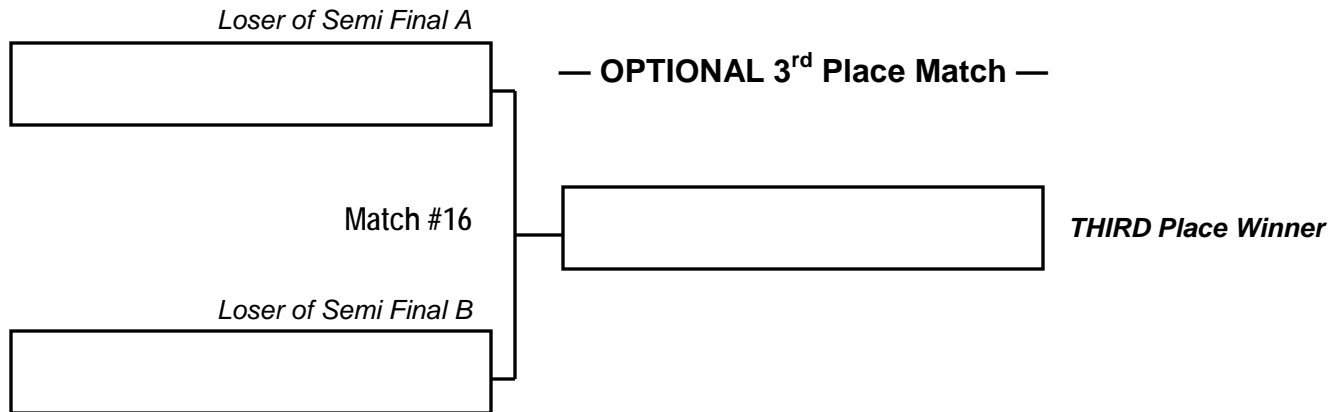

1 st	
2 nd	
3 rd	
4 th	

MAT: _____ Name: _____ Signature: _____

2014 Europa Super Show Texas

Division: [BEG-10yr-59] Children NO GI >> Beginner (1-3 yrs) >> Age 10 years and under 50-59.9 lbs

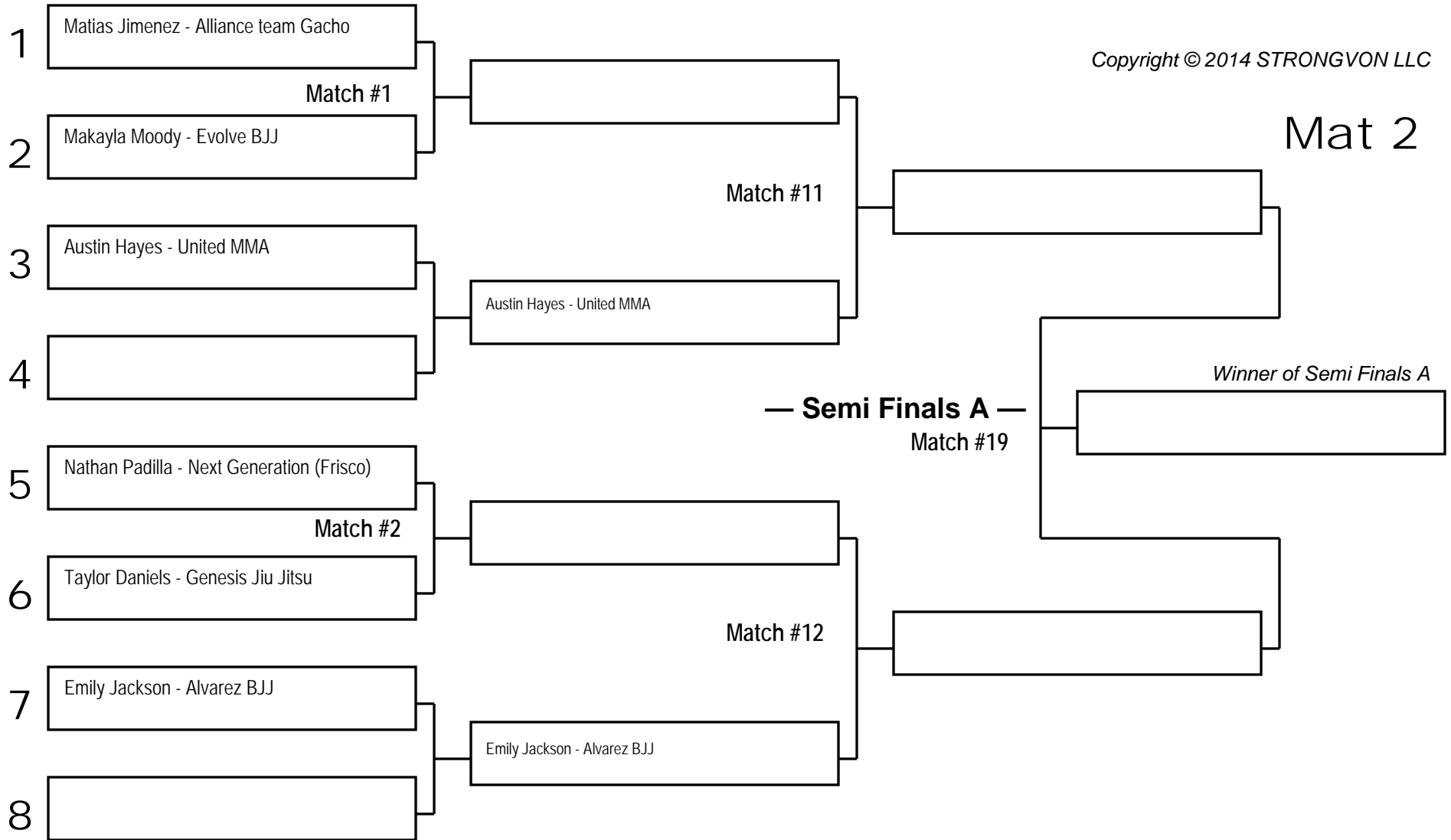

Copyright © 2014 STRONGVON LLC

Mat 2

Winner of Semi Finals A

— Semi Finals A —
Match #19

— GROUP A —

Please copy winner into Finals on Page 3

MAT: _____ Name: _____ Signature: _____

2014 Europa Super Show Texas

Division: [BEG-10yr-59] Children NO GI >> Beginner (1-3 yrs) >> Age 10 years and under 50-59.9 lbs

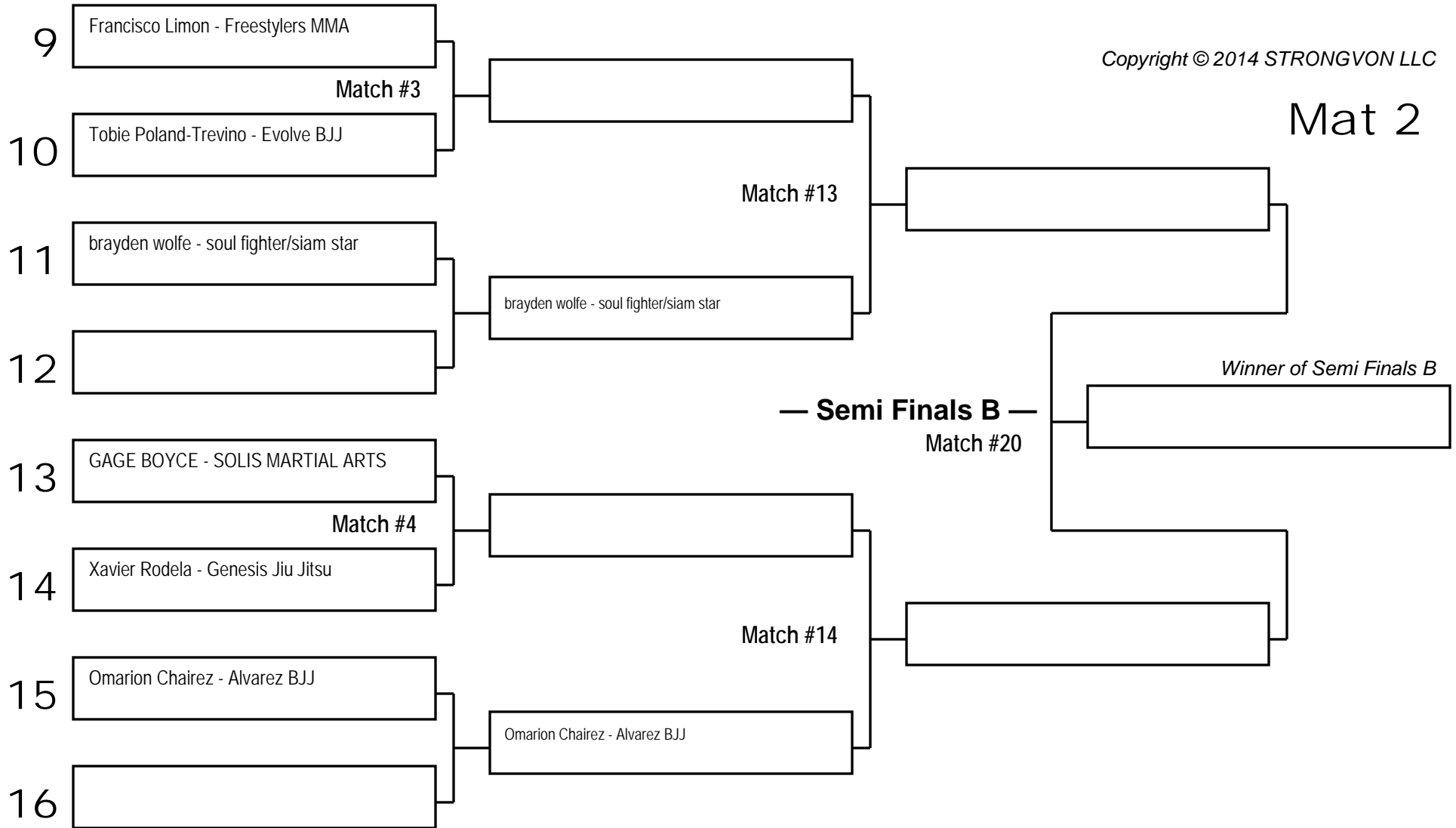

Copyright © 2014 STRONGVON LLC

Mat 2

Winner of Semi Finals B

— Semi Finals B —
Match #20

— GROUP B —

Please copy winner into Finals on Page 3

MAT: _____ Name: _____ Signature: _____

2014 Europa Super Show Texas

Division: [BEG-10yr-59] Children NO GI >> Beginner (1-3 yrs) >> Age 10 years and under 50-59.9 lbs

Copyright © 2014 STRONGVON LLC

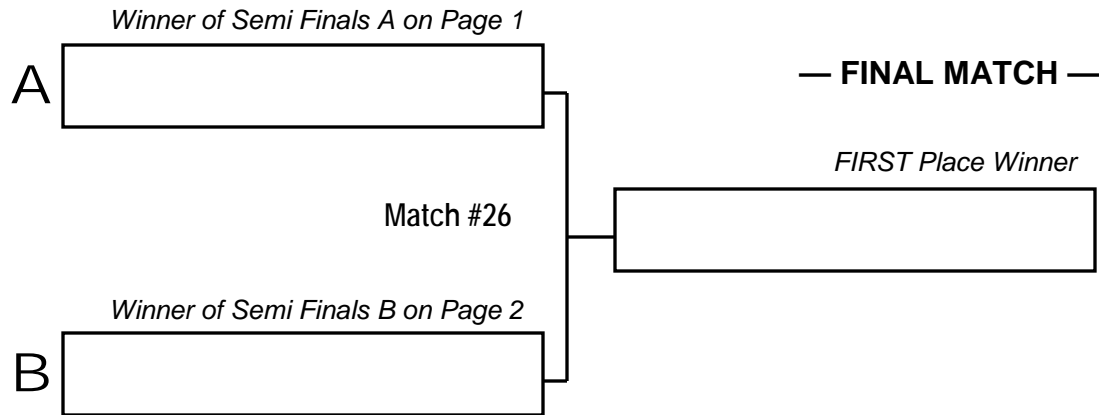

Mat 2

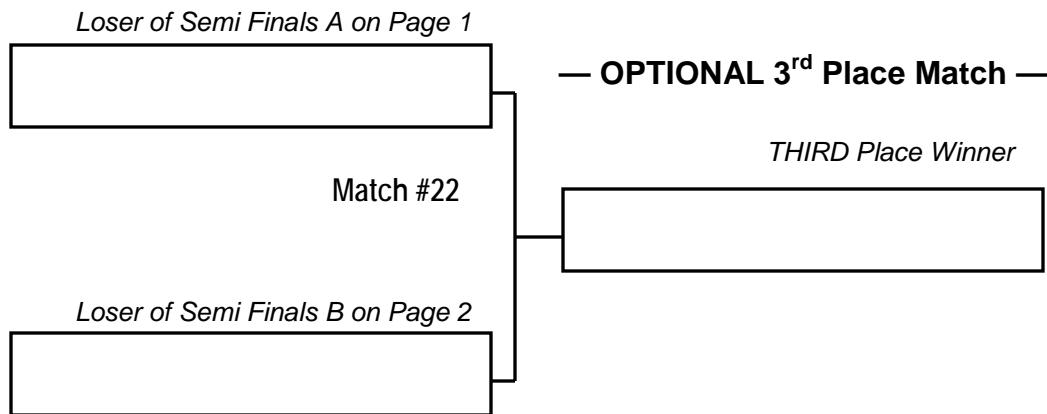

1 st	<input type="text"/>
2 nd	<input type="text"/>
3 rd	<input type="text"/>
4 th	<input type="text"/>

MAT: _____ Name: _____ Signature: _____

2014 Europa Super Show Texas

Division: [BEG-10yr-69] Children NO GI >> Beginner (1-3 yrs) >> Age 10 years and under 60-69.9 lbs

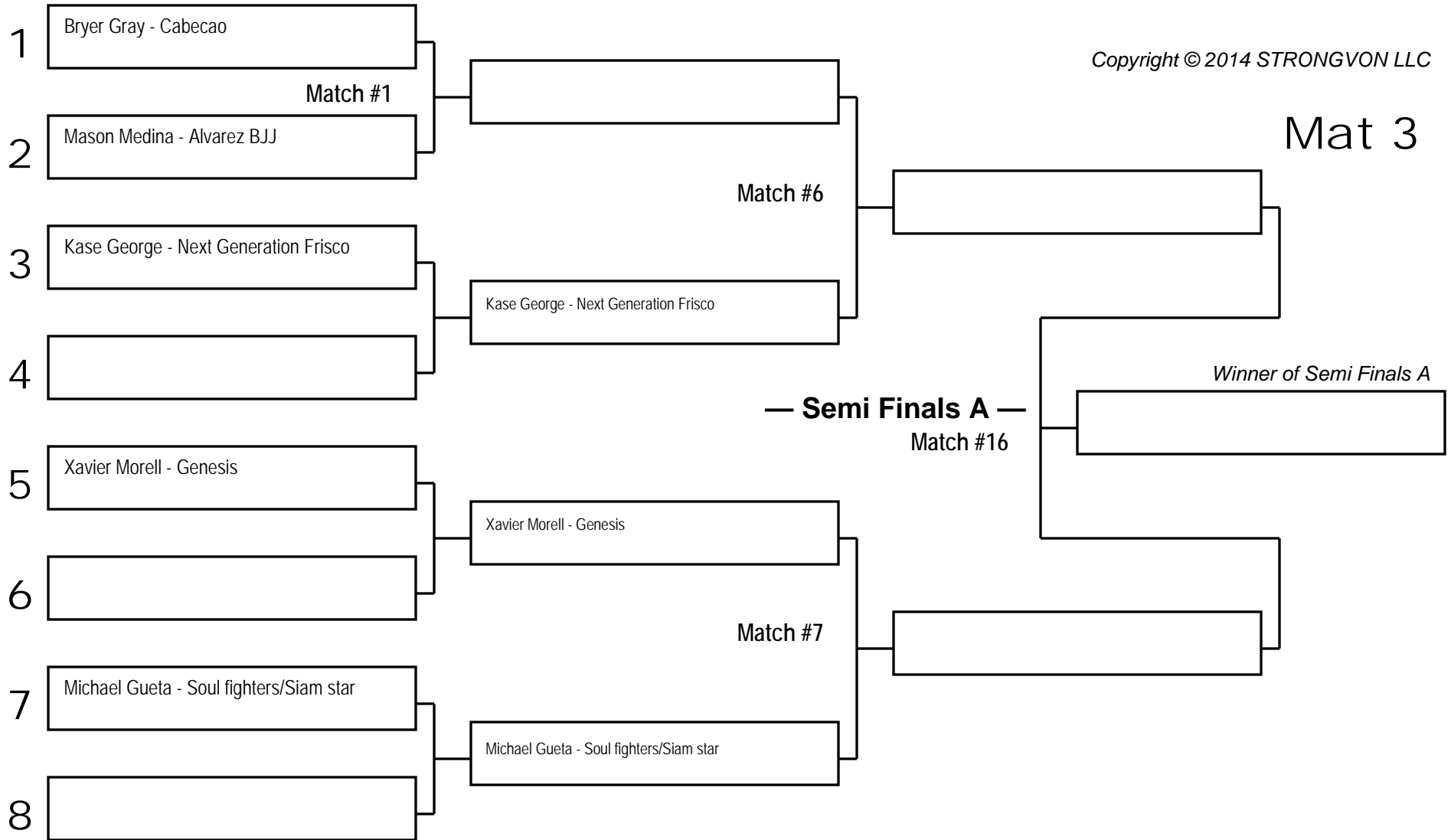

Copyright © 2014 STRONGVON LLC

Mat 3

— Semi Finals A —
Match #16

Winner of Semi Finals A

— GROUP A —

Please copy winner into Finals on Page 3

MAT: _____ Name: _____ Signature: _____

2014 Europa Super Show Texas

Division: [BEG-10yr-69] Children NO GI >> Beginner (1-3 yrs) >> Age 10 years and under 60-69.9 lbs

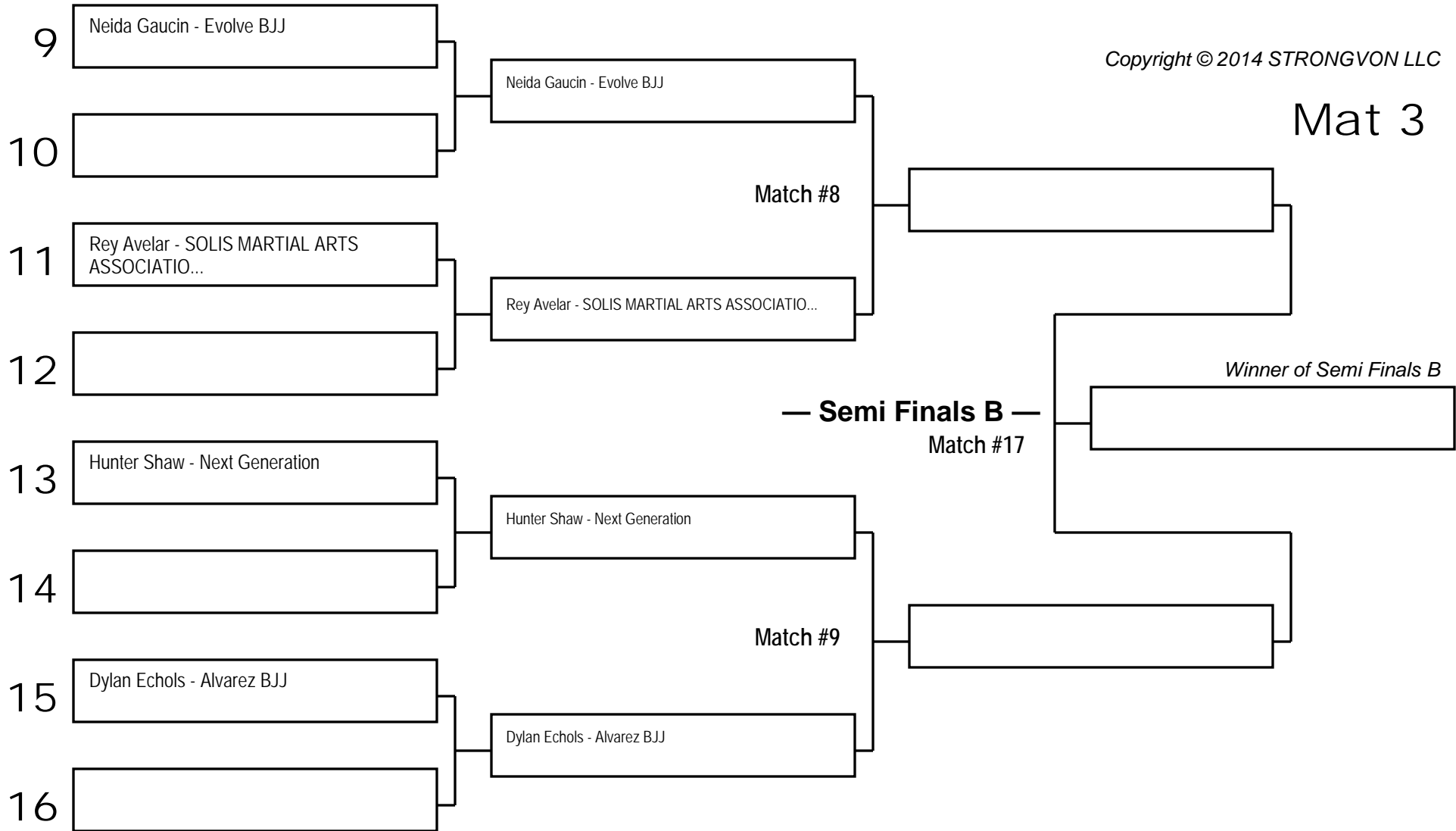

— GROUP B —

Please copy winner into Finals on Page 3

MAT: _____ Name: _____ Signature: _____

2014 Europa Super Show Texas

Division: [BEG-10yr-69] Children NO GI >> Beginner (1-3 yrs) >> Age 10 years and under 60-69.9 lbs

Copyright © 2014 STRONGVON LLC

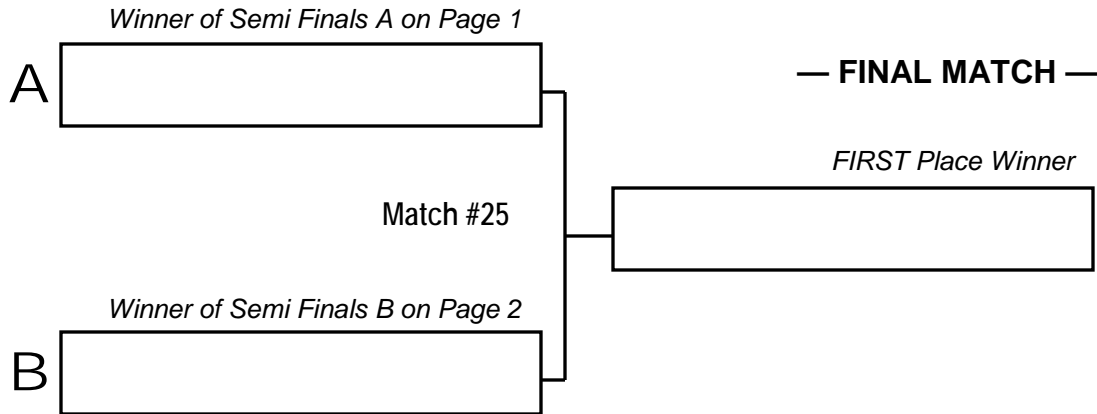

Mat 3

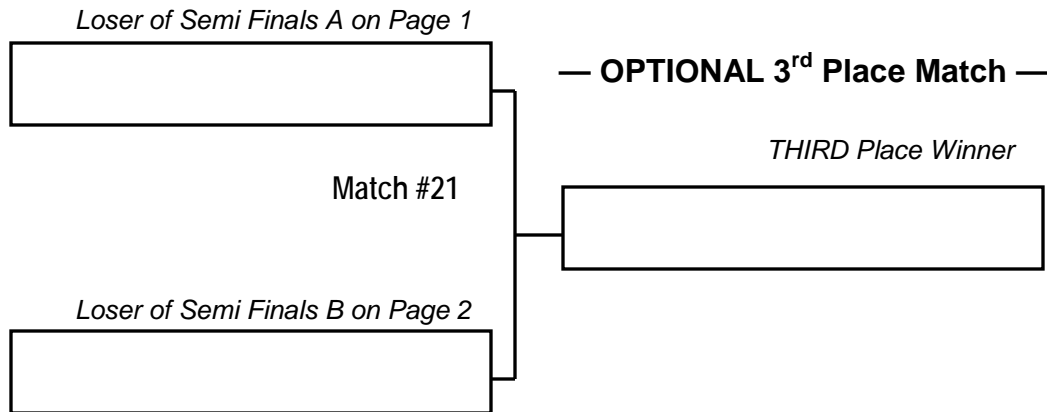

1 st	
2 nd	
3 rd	
4 th	

MAT: _____ Name: _____ Signature: _____

2014 Europa Super Show Texas

Division: [BEG-10yr-79] Children NO GI >> Beginner (1-3 yrs) >> Age 10 years and under 70-79.9 lbs

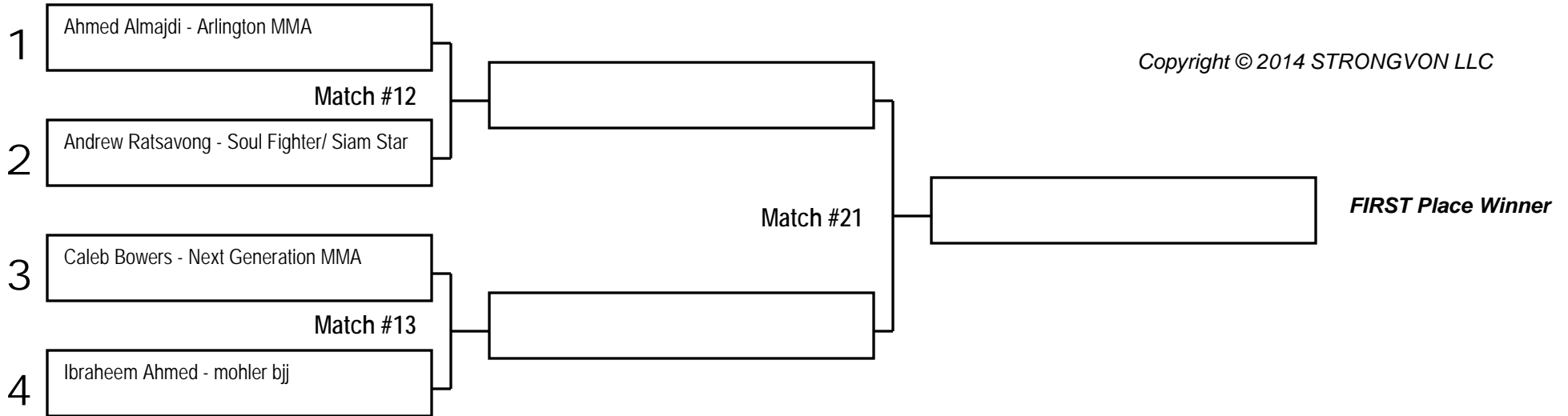

Mat 4

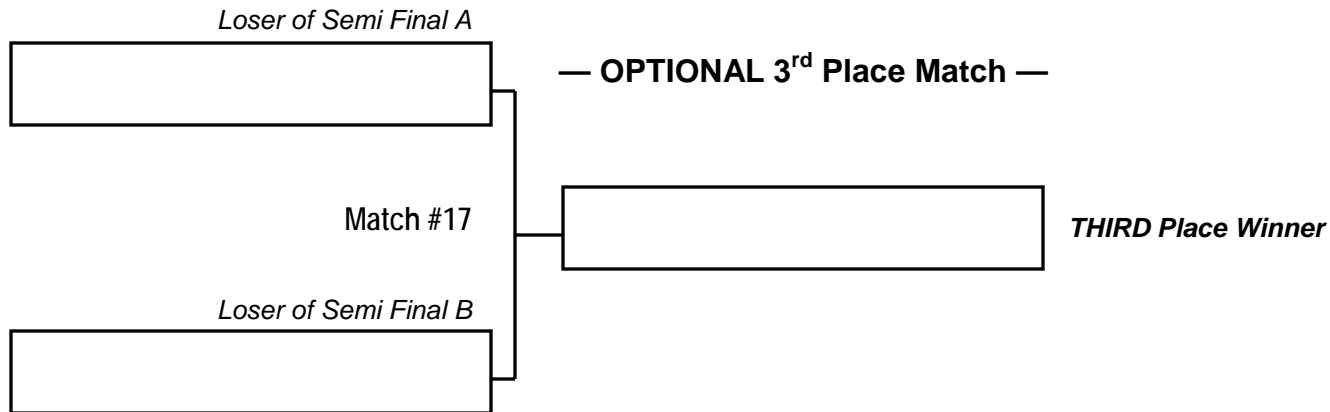

1 st	
2 nd	
3 rd	
4 th	

MAT: _____ Name: _____ Signature: _____

2014 Europa Super Show Texas

Division: [BEG-10yr-89] Children NO GI >> Beginner (1-3 yrs) >> Age 10 years and under 80-89.9 lbs

Copyright © 2014 STRONGVON LLC

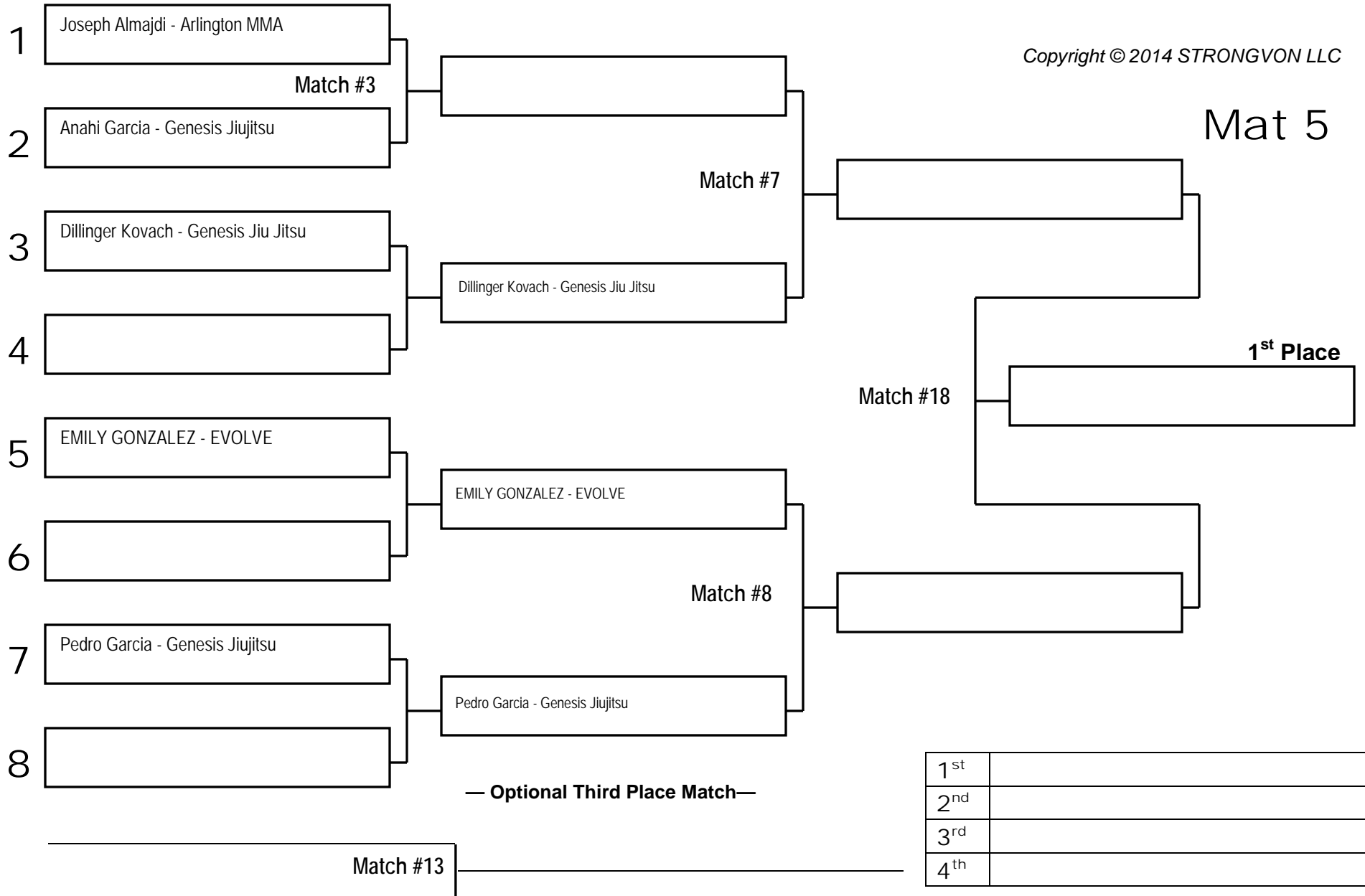

1 st	
2 nd	
3 rd	
4 th	

MAT: _____ Name: _____ Signature: _____

2014 Europa Super Show Texas

Division: [BEG-10yr-99] Children NO GI >> Beginner (1-3 yrs) >> Age 10 years and under 90-99.9 lbs

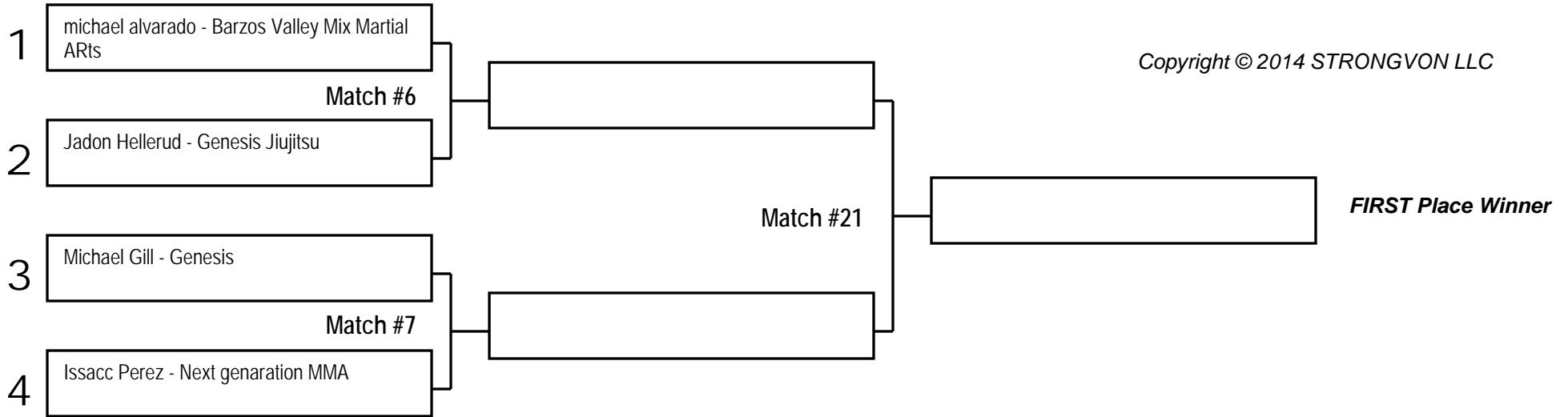

Mat 6

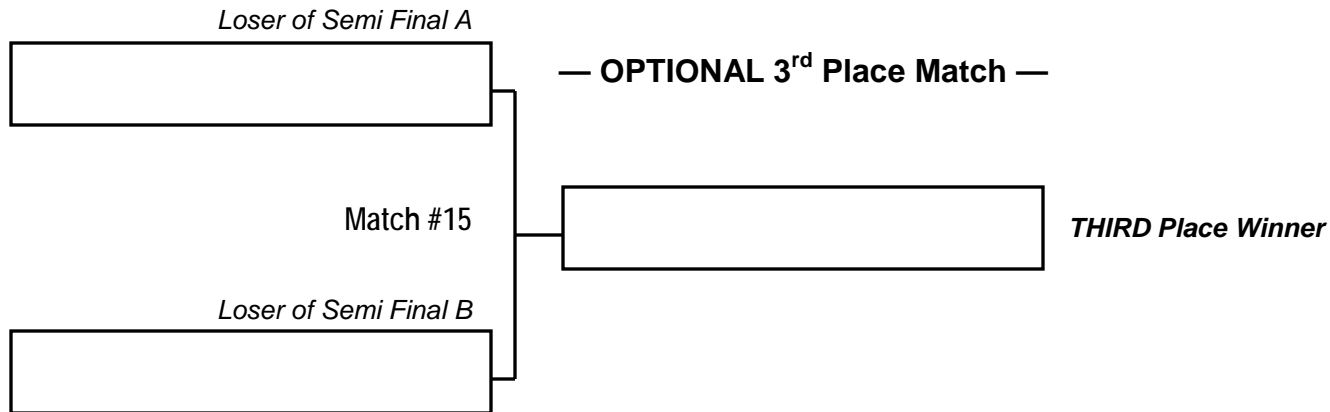

MAT: _____ Name: _____ Signature: _____

1 st	
2 nd	
3 rd	
4 th	

2014 Europa Super Show Texas

Division: [BEG-12yr-69] Children NO GI >> Beginner (1-3 yrs) >> Age 12 years and under 60-69.9 lbs

Copyright © 2014 STRONGVON LLC

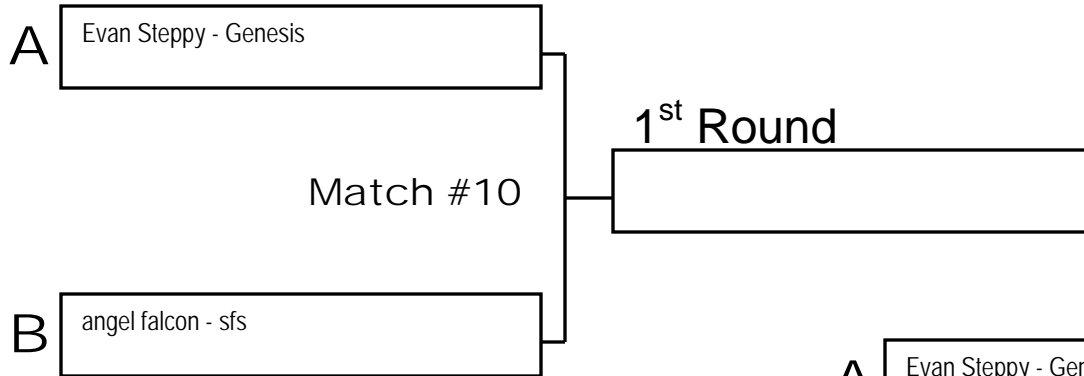

Mat 3

—Best of 3 Matches—

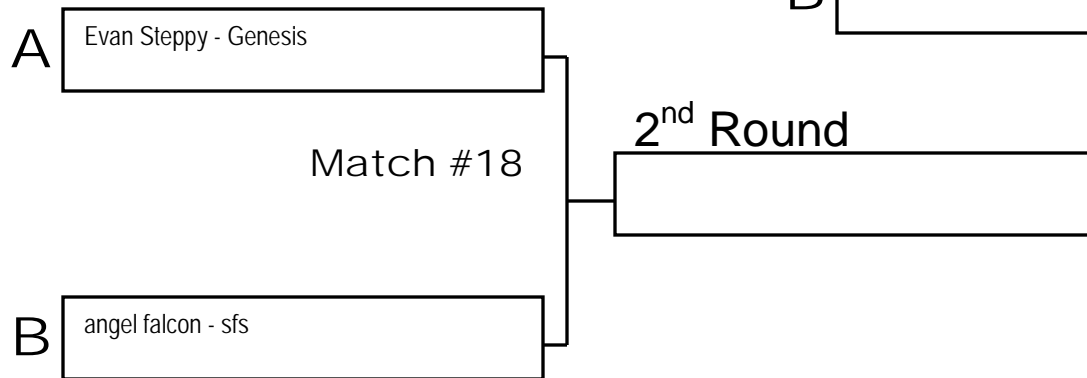
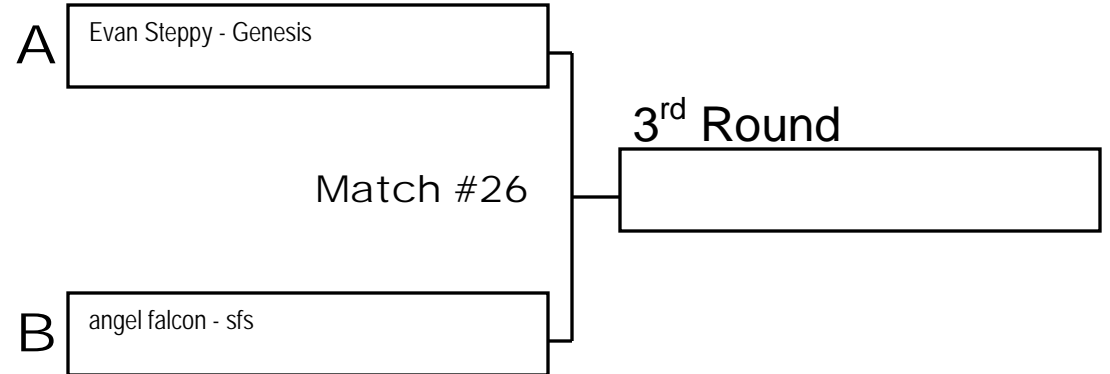

1st

2nd

MAT: _____ Name: _____ Signature: _____

2014 Europa Super Show Texas

Division: [BEG-12yr-79] Children NO GI >> Beginner (1-3 yrs) >> Age 12 years and under 70-79.9 lbs

Copyright © 2014 STRONGVON LLC

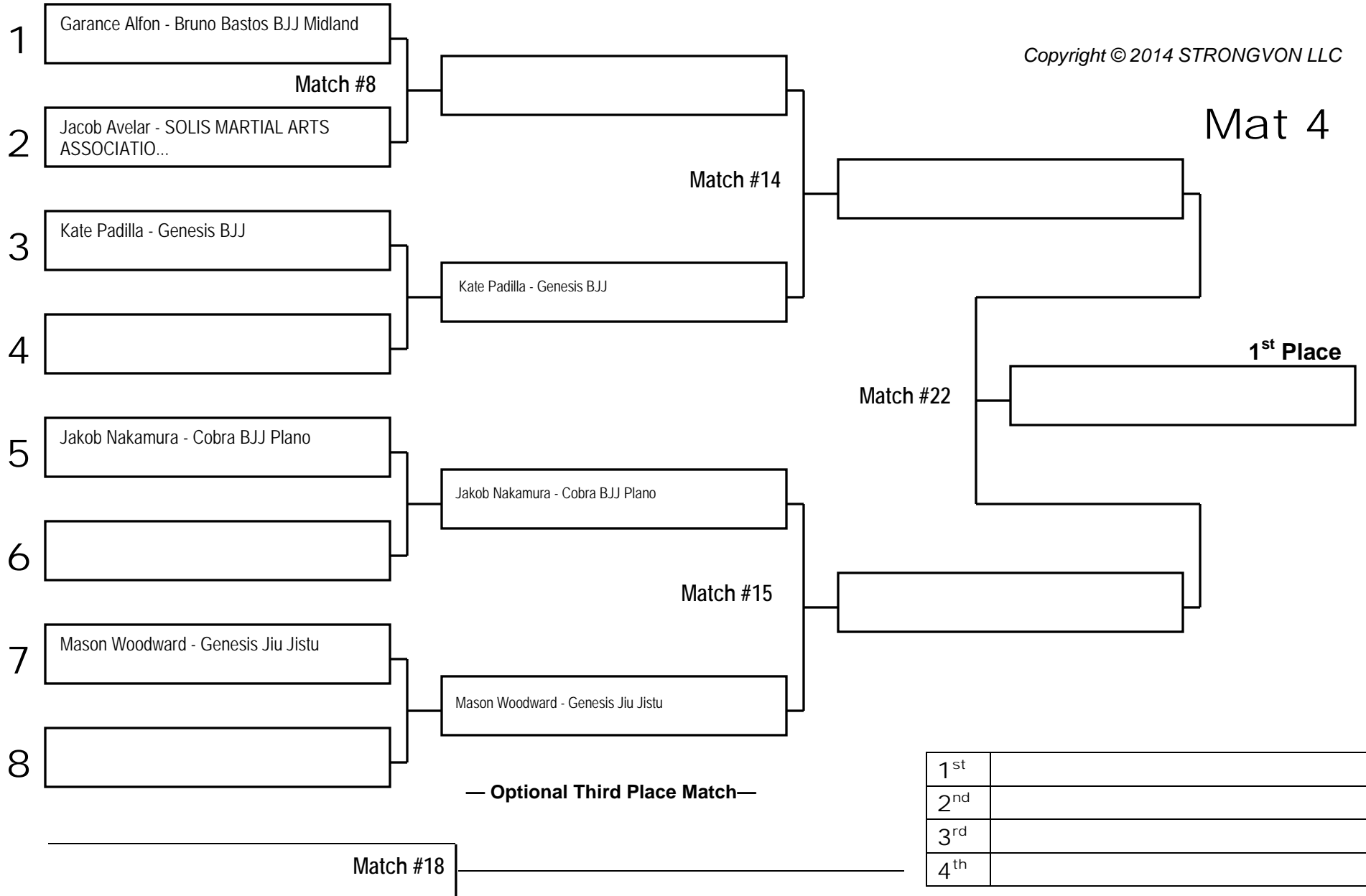

— Optional Third Place Match—

MAT: _____ Name: _____ Signature: _____

2014 Europa Super Show Texas

Division: [BEG-12yr-89] Children NO GI >> Beginner (1-3 yrs) >> Age 12 yrs and under 80-89.9 lbs

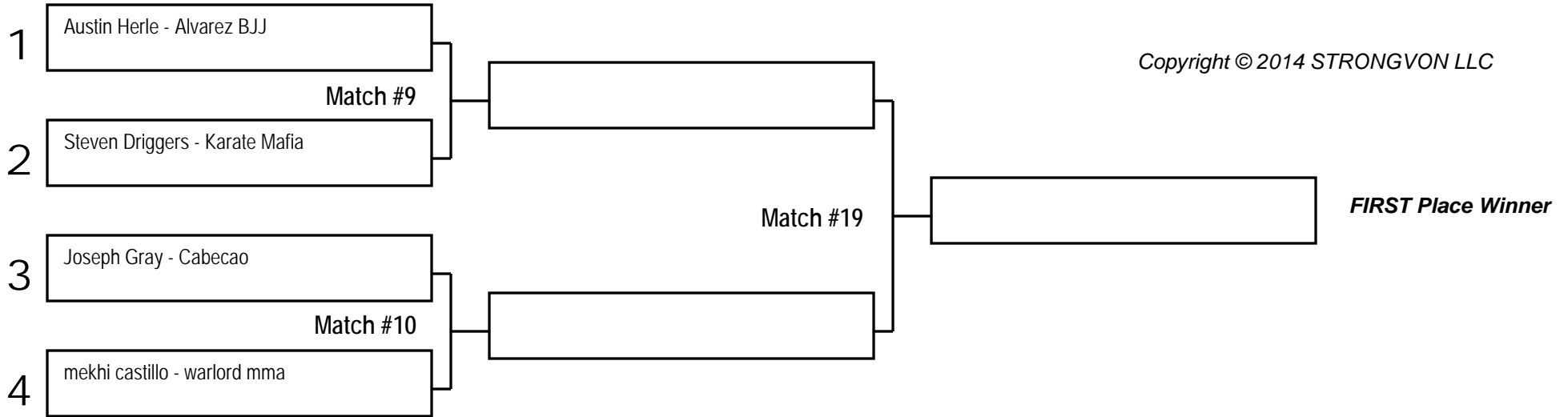

Mat 5

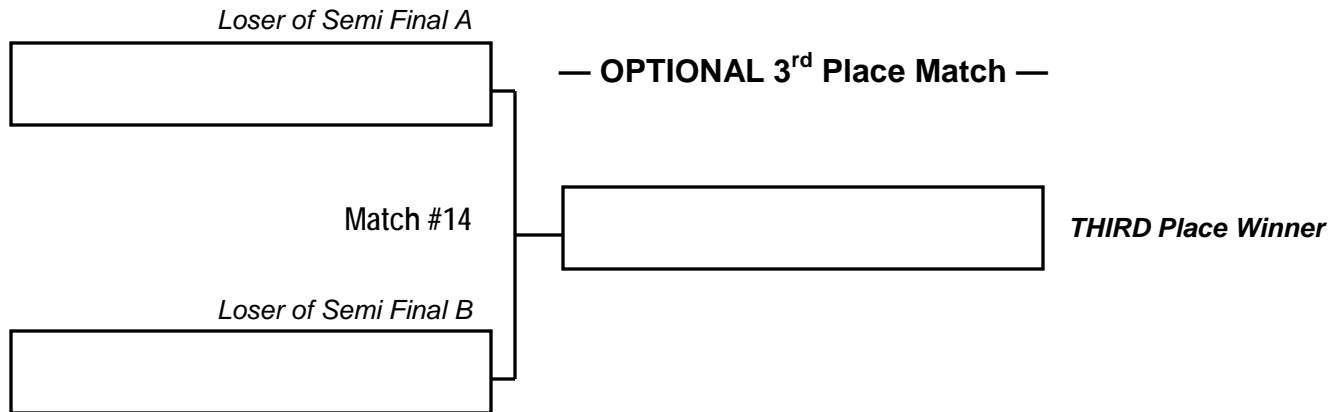

1 st	
2 nd	
3 rd	
4 th	

MAT: _____ Name: _____ Signature: _____

2014 Europa Super Show Texas

Division: [BEG-12yr-99] Children NO GI >> Beginner (1-3 yrs) >> Age 12 years and under 90-99.9 lbs

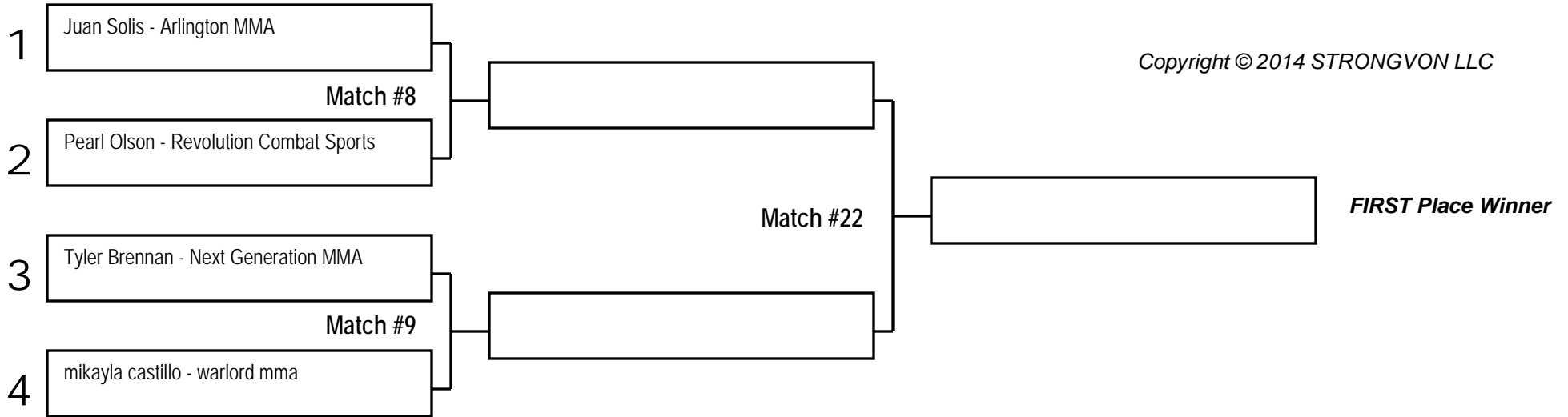

Mat 6

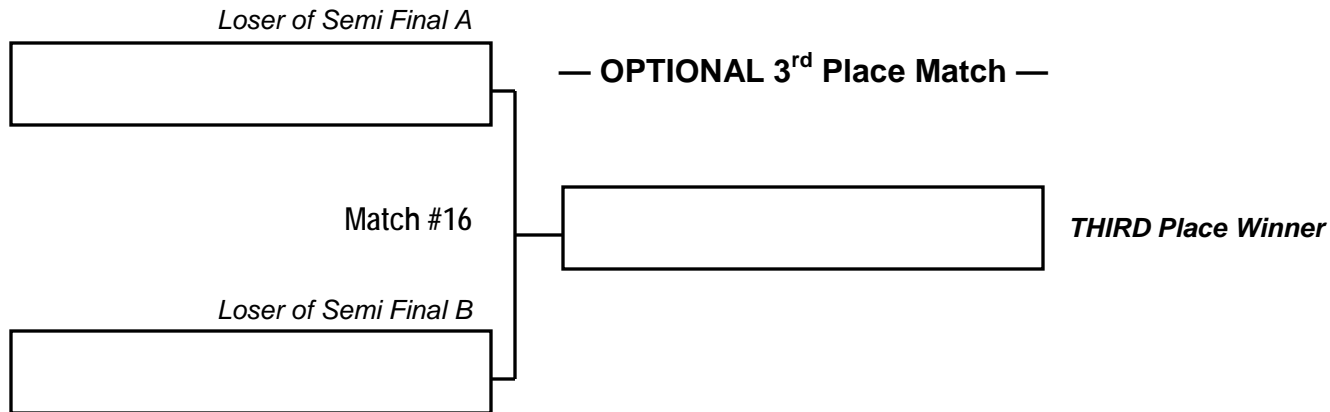

1 st	
2 nd	
3 rd	
4 th	

MAT: _____ Name: _____ Signature: _____

2014 Europa Super Show Texas

Division: [BEG-12yr-109] Children NO GI >> Beginner (1-3 yrs) >> Age 12 years and under 100-109.9 lbs

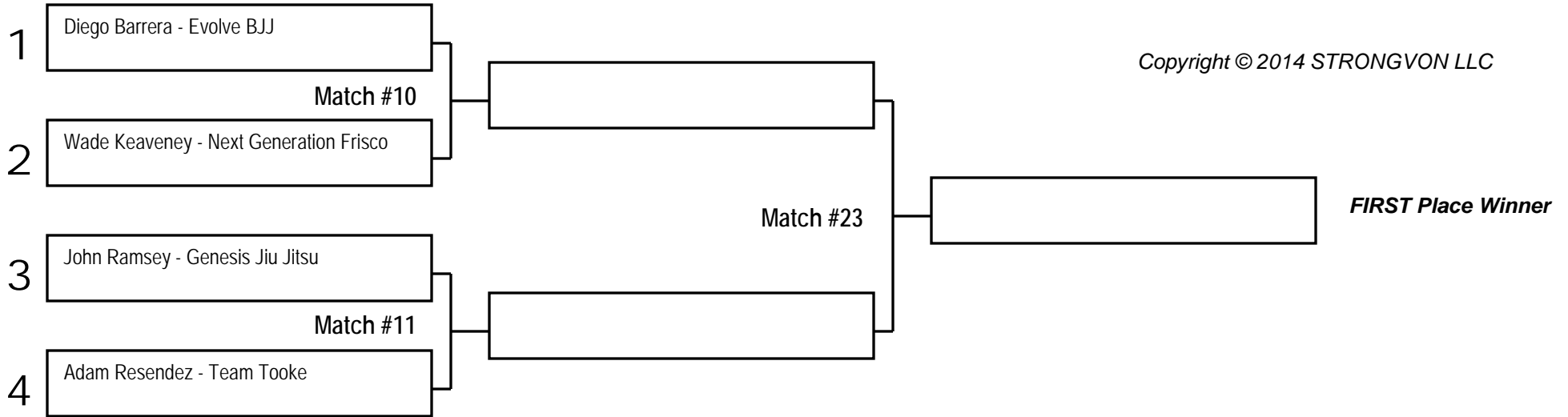

Mat 6

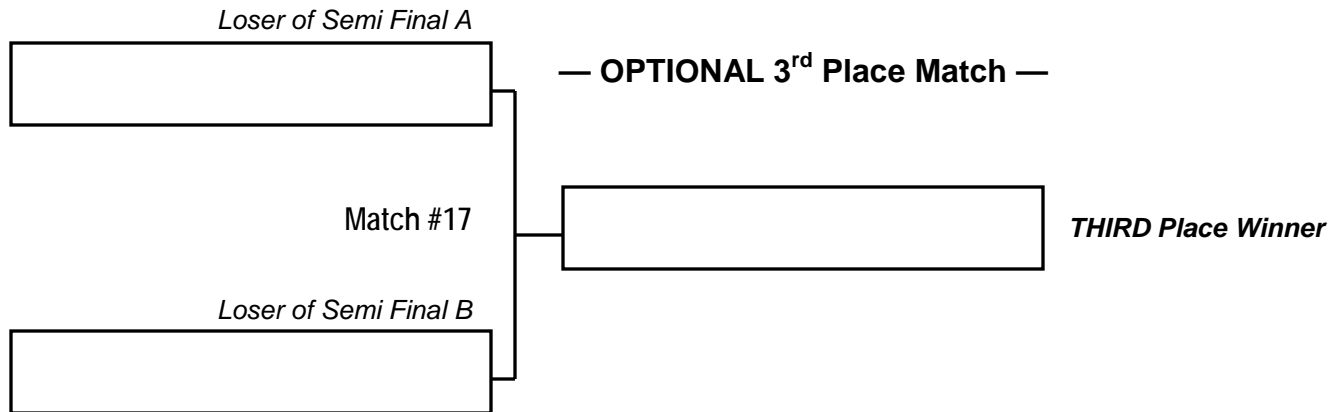

1 st	
2 nd	
3 rd	
4 th	

MAT: _____ Name: _____ Signature: _____

2014 Europa Super Show Texas

Division: [BEG-12yr-119] Children NO GI >> Beginner (1-3 yrs) >> Age 12 years and under 110-119.9 lbs

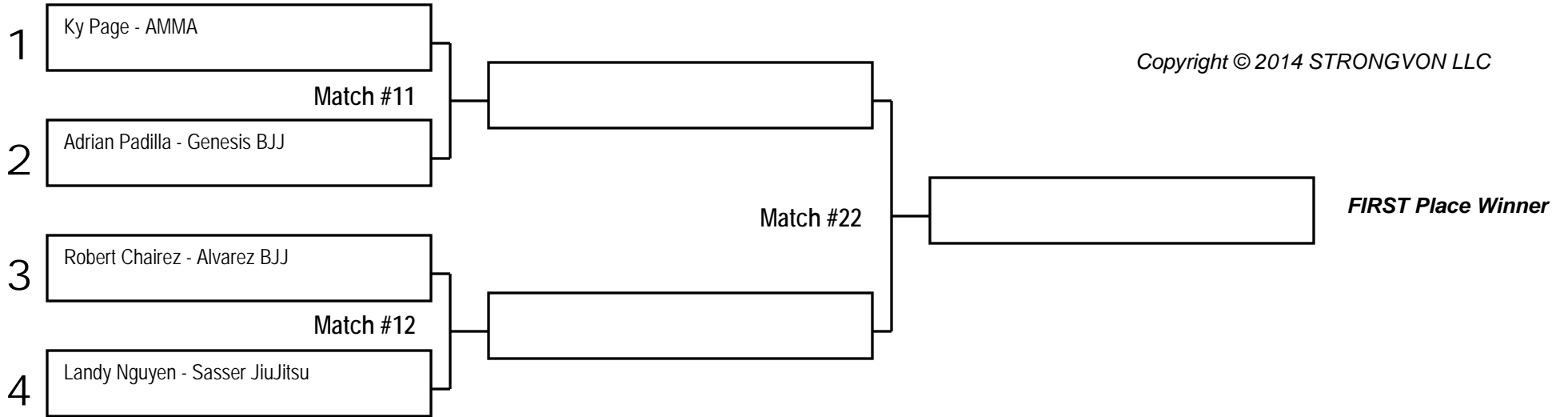

Mat 1

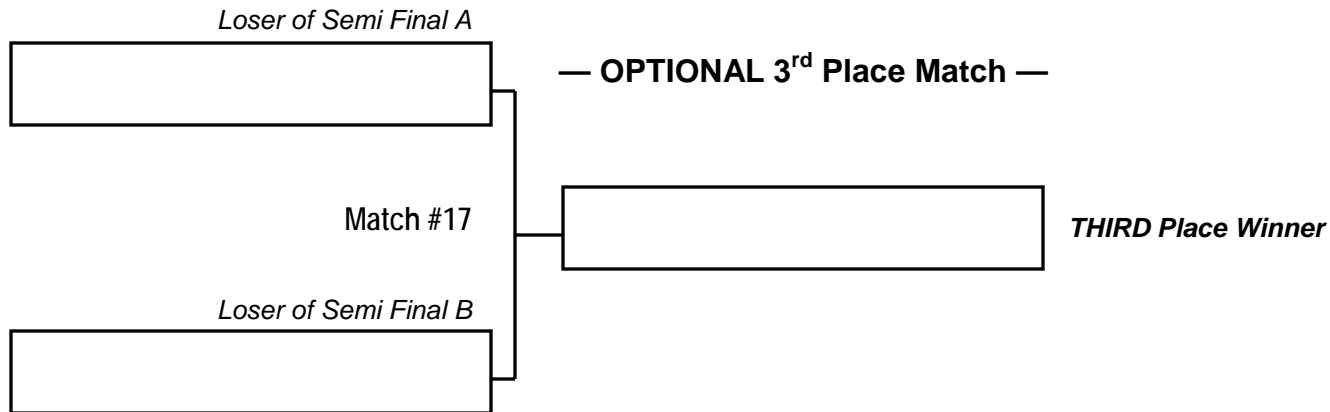

1 st	
2 nd	
3 rd	
4 th	

MAT: _____ Name: _____ Signature: _____

2014 Europa Super Show Texas

Division: [INT-12yr-89] Children NO GI >> Intermediate (over 3 yrs) >> Age 12 yrs and under 80-89.9 lbs

Copyright © 2014 STRONGVON LLC

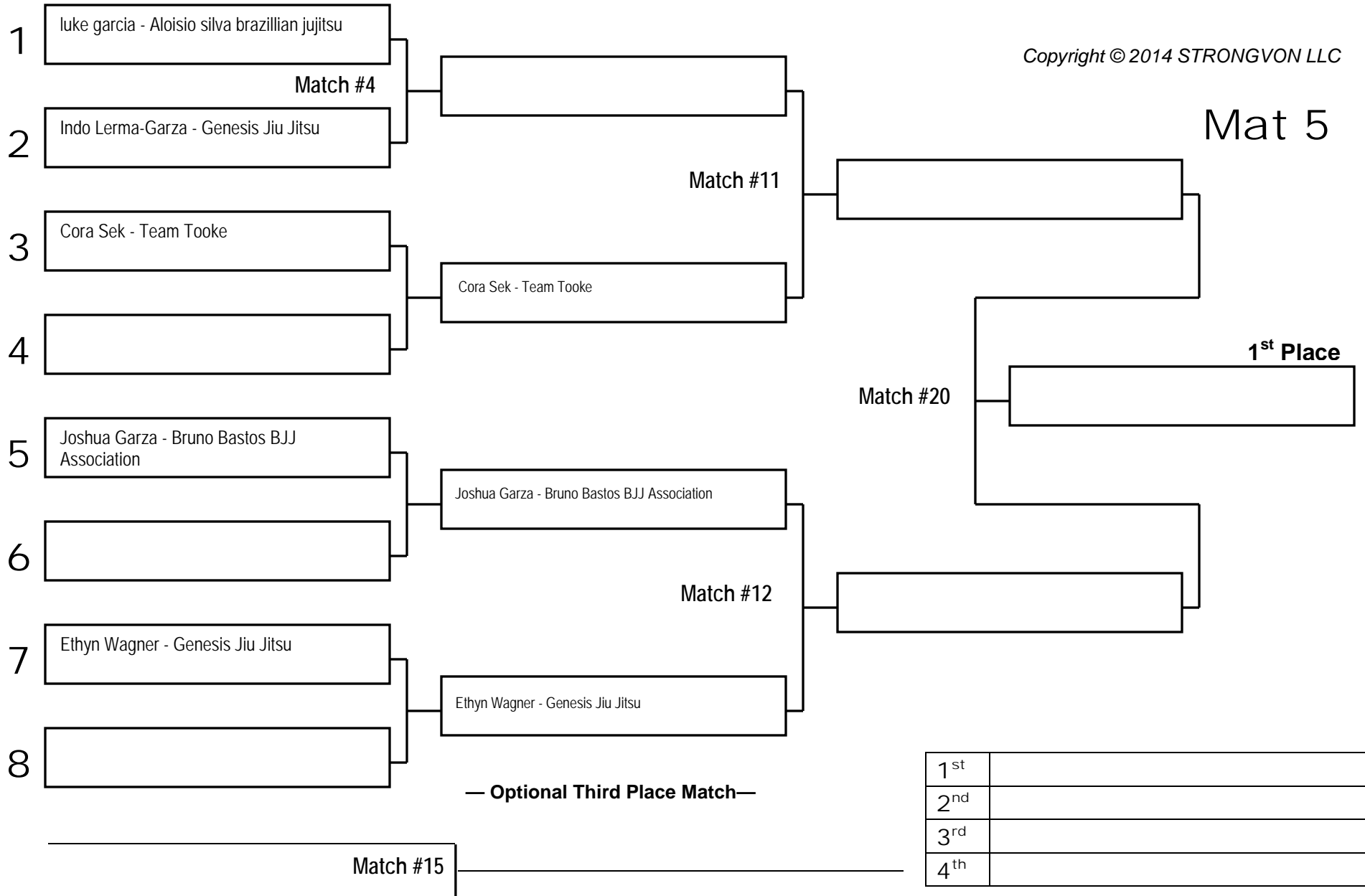

1 st	
2 nd	
3 rd	
4 th	

MAT: _____ Name: _____ Signature: _____

2014 Europa Super Show Texas

Division: [INT-12yr-109] Children NO GI >> Intermediate (over 3 yrs) >> Age 12 years and under 100-109.9 lbs

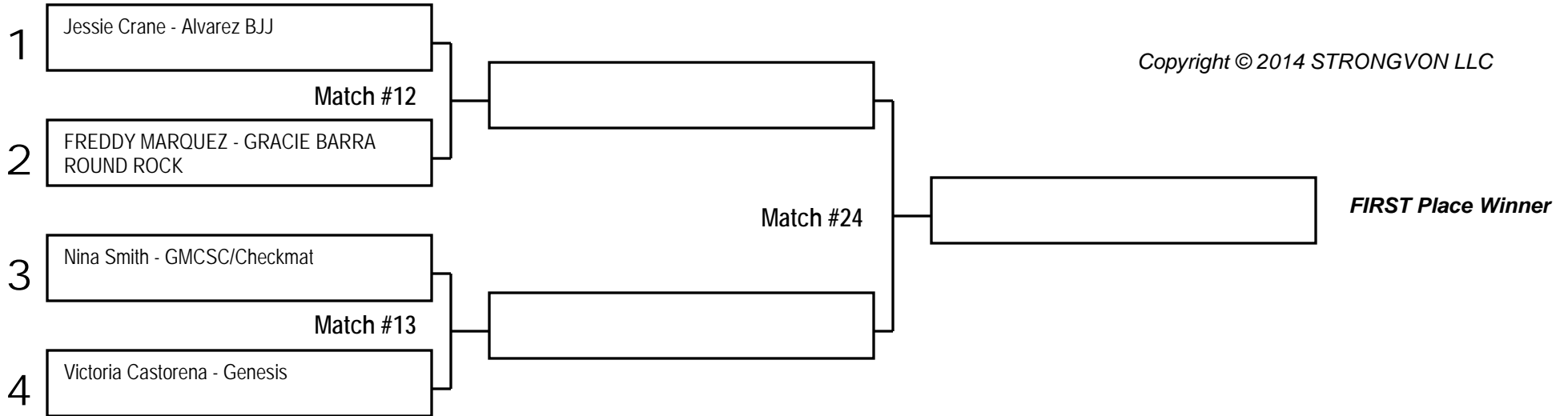

Mat 6

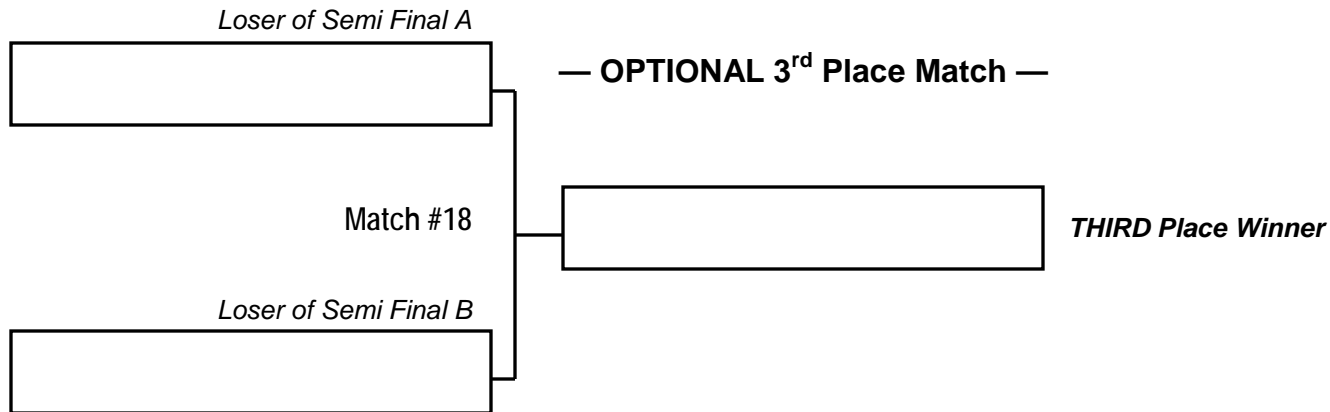

1 st	
2 nd	
3 rd	
4 th	

MAT: _____ Name: _____ Signature: _____

2014 Europa Super Show Texas

Division: [INT-12yr-999] Children NO GI >> Intermediate (over 3 yrs) >> Age 12 years and under 120 lbs and up

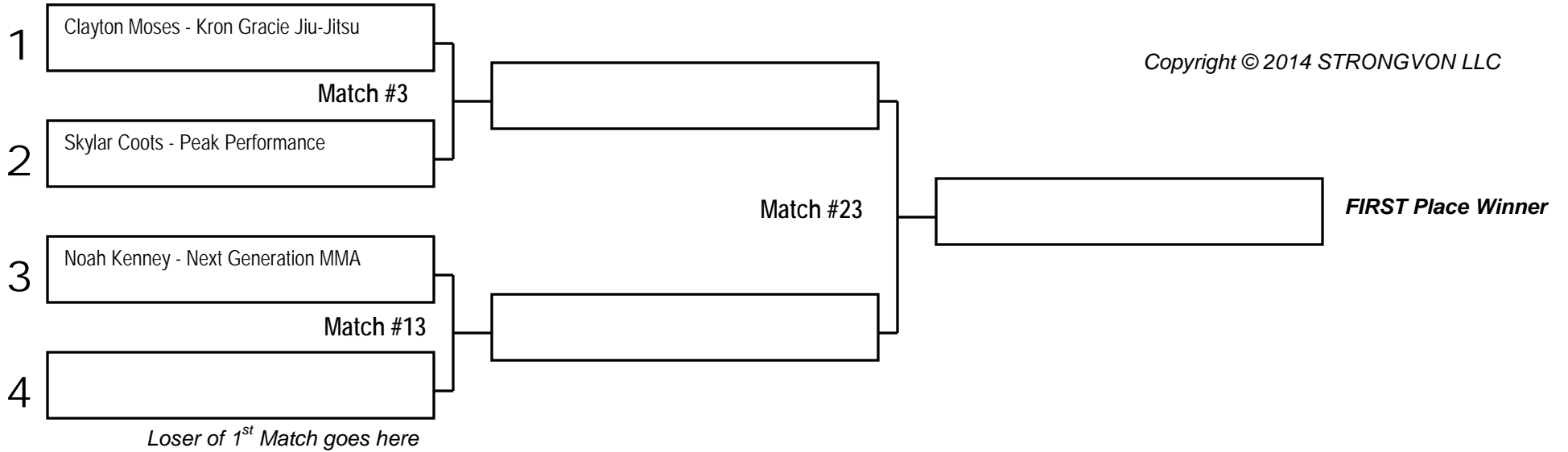

Mat 1

MAT: _____ Name: _____ Signature: _____

1 st	
2 nd	
3 rd	

2014 Europa Super Show Texas

Division: [TEEN-Boy] ABSOLUTE NO GI >> TEEN Boys (all levels and weights)

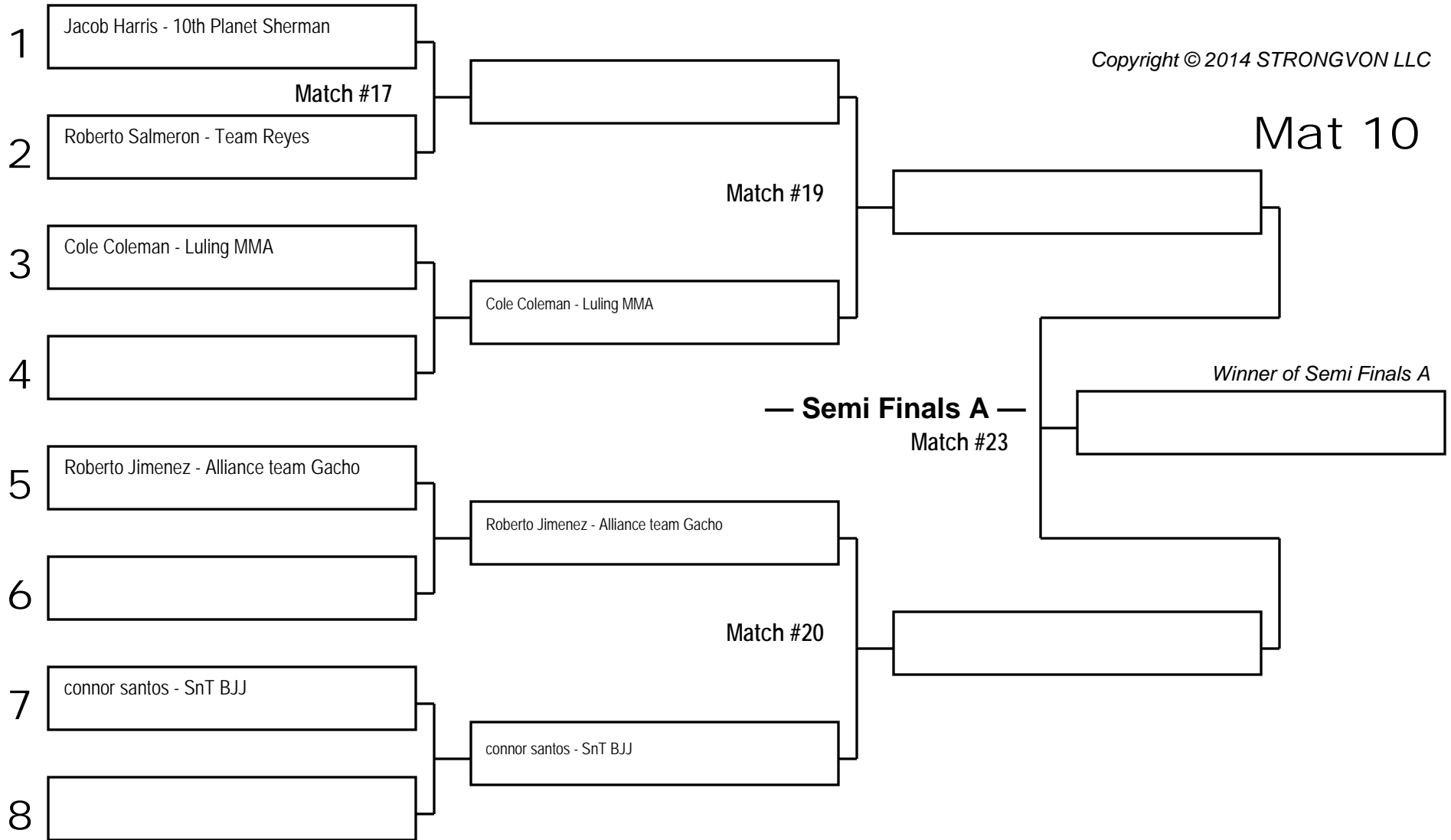

— GROUP A —

Please copy winner into Finals on Page 3

MAT: _____ Name: _____ Signature: _____

2014 Europa Super Show Texas

Division: [TEEN-Boy] ABSOLUTE NO GI >> TEEN Boys (all levels and weights)

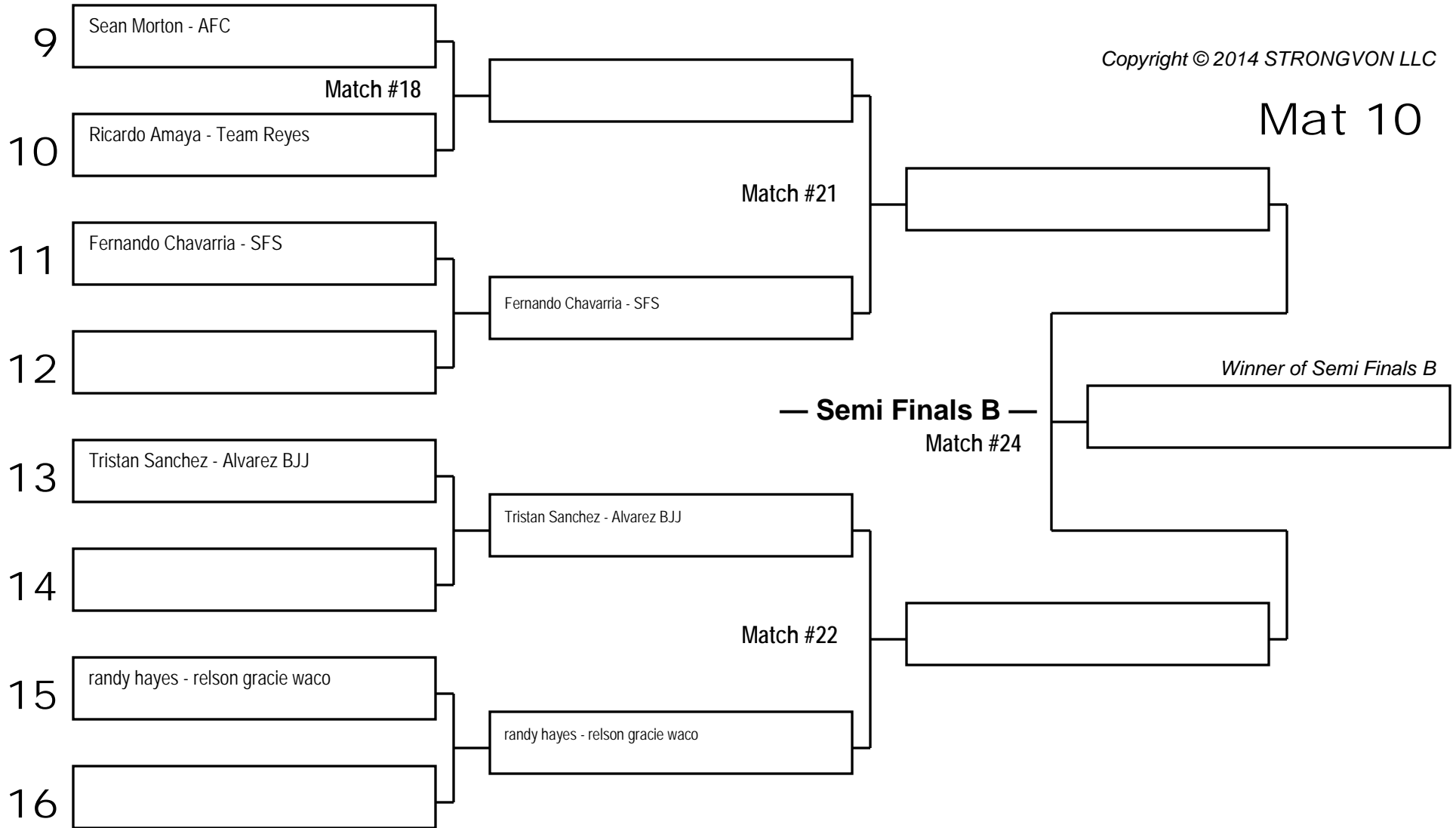

— GROUP B —

Please copy winner into Finals on Page 3

MAT: _____ Name: _____ Signature: _____

2014 Europa Super Show Texas

Division: [TEEN-Boy] ABSOLUTE NO GI >> TEEN Boys (all levels and weights)

Copyright © 2014 STRONGVON LLC

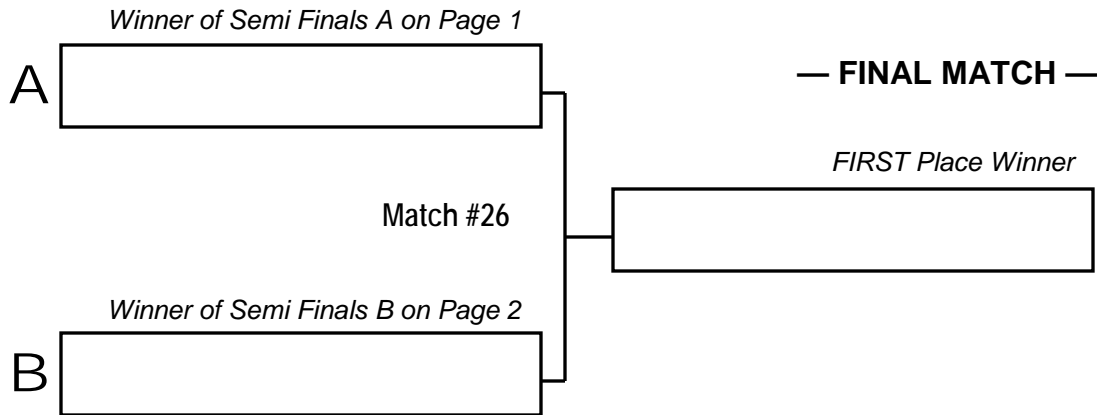

Mat 10

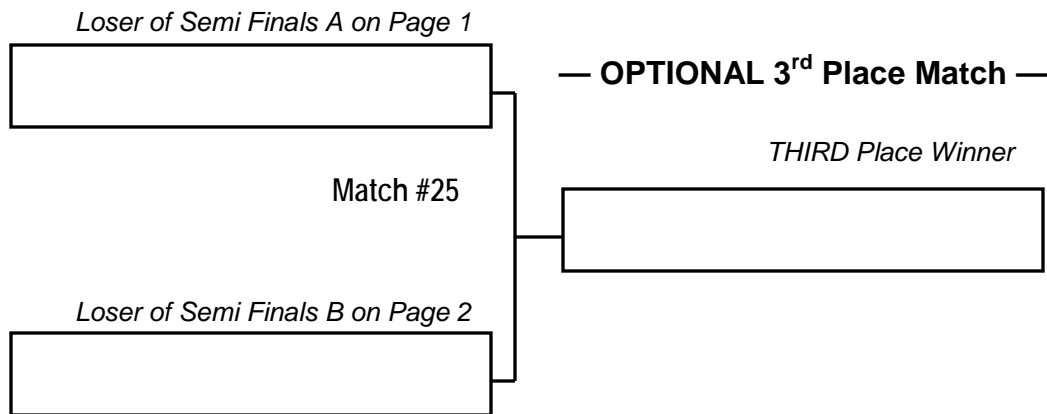

1 st	<input type="text"/>
2 nd	<input type="text"/>
3 rd	<input type="text"/>
4 th	<input type="text"/>

MAT: _____ Name: _____ Signature: _____