

2014 Insight Navigation Manual (Unlinked)

This document may not contain hyperlinks and may be formatted for printing instead of web use. This is due to changes in content and specifications of the vehicle that happen throughout the model year. This manual will be replaced with a hyperlinked version at the end of the model year.

The information and specifications included in this publication were in effect at the time of approval for printing. Honda Motor Co., Ltd., reserves the right, however, to discontinue or change specifications or design at any time without notice and without incurring any obligation.

Accessories Precautions

The GPS antenna is located in the dashboard. Metallic front or side window tinting can seriously degrade or obstruct GPS reception.

Signal noise from devices such as radar detectors, vehicle tracking devices, remote starters, and additional amplifiers can disrupt the navigation system. If you install any such item, install it away from the navigation display and antenna.

Important Safety Information



WARNING

Using the navigation system while driving can take your attention away from the road, causing a crash in which you could be seriously injured or killed.

Only operate system controls when the conditions permit you to safely do so.

Avoid focusing on the screen or manually operating the system controls while driving.

Certain on-screen controls are disabled when driving, but most of the audible instructions and voice commands continue to function. Pull to the side of the road if you need to devote more attention and time to look at the screen or access additional menus.

Route guidance may conflict with street closures, road construction, detours, and out-of-date map data.

The system itself may also have limitations. Verify route information by carefully observing roads, signs, and signals. Always use your own judgment and obey traffic laws.

 **System Limitations P. 178**

NOTICE

This vehicle's navigation display, if so equipped, includes mercury-containing components. Upon removal, please reuse, recycle, or dispose of as hazardous waste.

Clean the screen with a soft, damp cloth. You may use a mild cleaner intended for use on navigation screens.

Contents

➤ System Setup P. 17			
Start-up 18	Voice Control System 20	Interface Settings 22	Personal Information 30
Routing & Guidance 40	Clock Adjustment 47	Vehicle 50	Data Reset 53
➤ Navigation P. 55			
Entering a Destination 56	Calculating the Route 77	Driving to Your Destination 80	Map Menu 85
Changing Your Route 101	Changing Your Destination 108	Resuming Your Trip 112	
➤ Audio P. 113			
Audio System 114	Playing FM/AM Radio 116	Playing a Disc 121	Playing an iPod® 125
Playing a USB Flash Drive 129	Playing <i>Bluetooth</i> ® Audio 133	Adjusting the Sound 136	Audio Remote Controls 137
➤ <i>Bluetooth</i>® HandsFreeLink® P. 139			
<i>Bluetooth</i> ® HandsFreeLink® 140	Pairing a Phone 142	Setting Up Speed Dialing 147	Editing Phone Information 150
Phone Setup 151	Making a Call 152	Receiving a Call 155	HFL Menus 156
➤ Other Features P. 159			
Trip Computer 160	Information Functions 161	Rearview Camera 162	
➤ Troubleshooting P. 163			
Troubleshooting 164	Error Messages 171		
➤ Reference Information P. 175			
System Initialization 176	System Limitations 178	Customer Assistance 180	Legal Information 183
➤ Voice Commands P. 187			
Voice Commands 188	List of Categories 197		

Quick Reference Guide P.2

System Setup P.17

Navigation P.55

Audio P.113

***Bluetooth*® HandsFreeLink®** P.139

Other Features P.159

Troubleshooting P.163

Reference Information P.175

Voice Commands P.187

Index P.198

Overview—Functions at a Glance

Navigation

You can select any place/landmark as a destination by using voice control or the touch screen. The navigation system gives you turn-by-turn driving directions to your destination.



Store home addresses [↔ P.36](#)

Register **2** home addresses.

Store contacts [↔ P.31](#)

Store up to **200** contacts in **2** address books.

Enter destination [↔ P.56](#)

Select your destination using **11** methods.

Select route [↔ P.78](#)

Set route preferences and select one of **3** routes.

Track route [↔ P.80](#)

Follow your route in real-time with voice guidance.

FM Traffic [↔ P.99](#)

View and avoid congestion and traffic incidents.

Avoid certain areas [↔ P.102](#)

Set streets and areas to detour around.

Add waypoints [↔ P.103](#)

Add up to **4** "pit stops" along your route.



Audio

The advanced audio system provides clear, well-defined sound and makes the most of your music. Enjoy listening to a variety of audio sources, such as:



AM/FM Radio → P.116

Compact Disc → P.121

iPod® → P.125

USB Flash Drive → P.129

Bluetooth® Audio → P.133

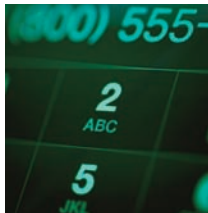
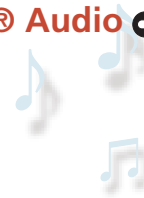

Voice Control → P.20

Use voice commands to control the system while driving. You can operate all key functions of the navigation, audio, and climate control systems.

Bluetooth® HandsFreeLink® → P.140

Pair a compatible cell phone to receive incoming and make outgoing calls. You can operate the phone features without ever taking your hands off the wheel.



Other Features

Rearview Camera → P.162

Helps you check for obstacles around the rear of your vehicle on the navigation screen when reversing.

System Controls

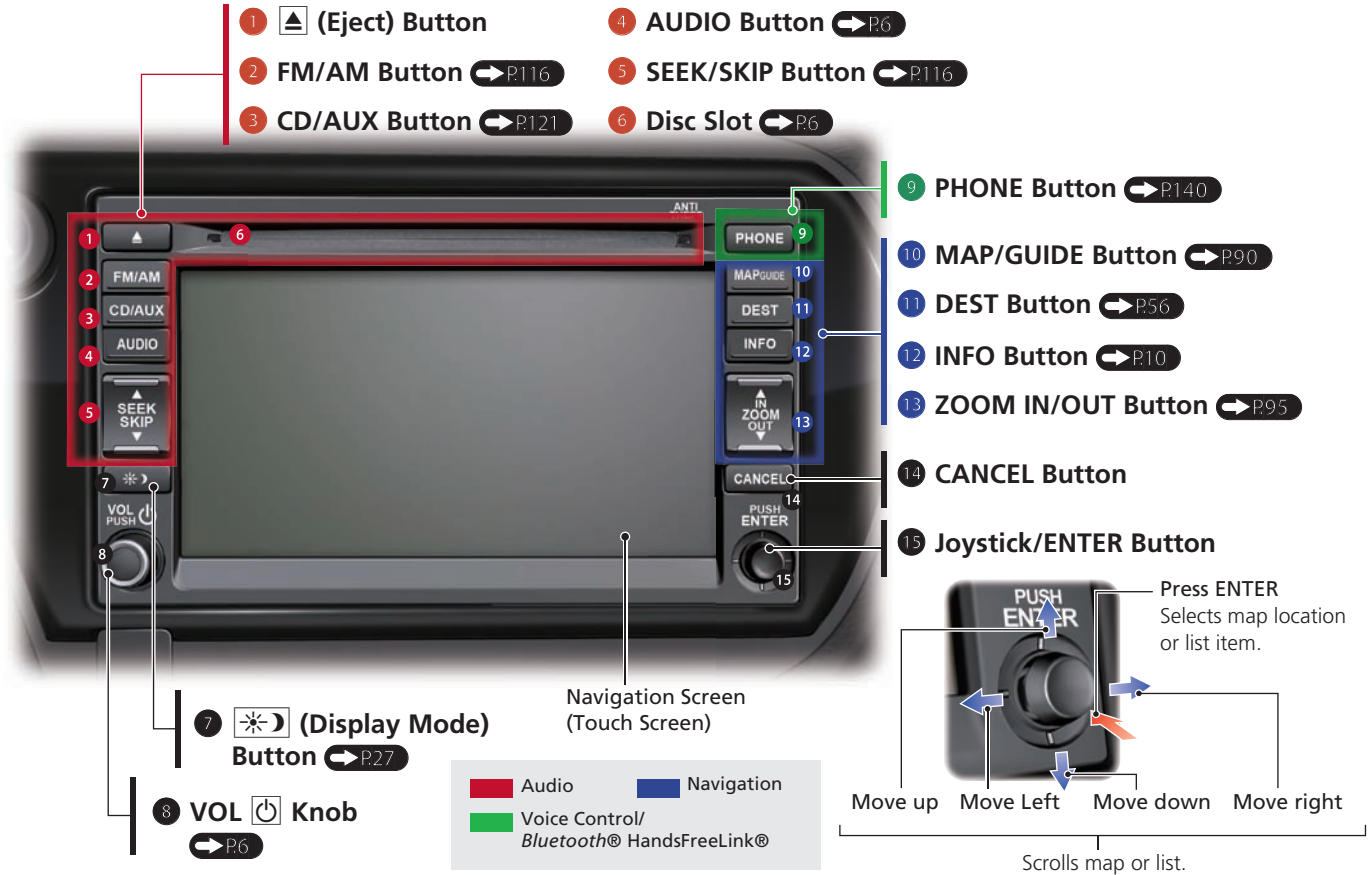

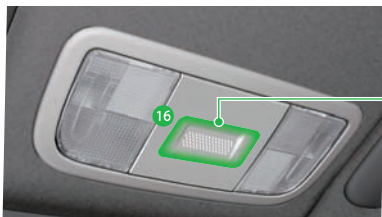

16 Microphone

➔ P.20



17 MODE Button ➔ P.137

18 VOL (Volume) Button

➔ P.138

19 CH (Channel) Button

➔ P.138



20 (Pick-Up) Button ➔ P.155

21 (Hang-Up) Button ➔ P.155

22 (Talk) Button ➔ P.5

23 (Back) Button ➔ P.5

Voice Control Operation



- 1 Press and release the  (Talk) button.

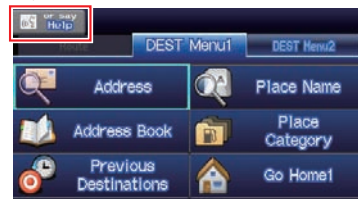

A helpful prompt asks what you would like to do. Press and release the  (Talk) button again to bypass this prompt.

 (Talk) Button



- The  icon is displayed and the system beeps when ready for a command. Press the  (Back) button to cancel.
- Available voice commands are highlighted on the screen.

- 2 Say a voice command.

Voice Command ➔ P.187

- The audio system is muted during voice control mode.
- Say  "Help" to see supported commands for the current screen. A voice help tutorial is also available. **Voice Help** ➔ P.13
- Carefully read the usage note for the voice control. **Voice Control System** ➔ P.20

Audio System

You can play music from a wide array of media sources. You can also control the audio system using voice commands.

Basic Operation

- 1 Press the VOL  (Volume/Power) button to turn the audio system on or off.
- 2 Press the AUDIO button and select **SOURCE** on the screen.
- 3 Select the audio source.

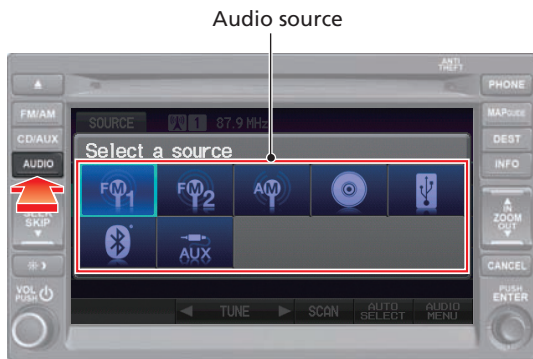

Or, press the FM/AM button or CD/AUX button repeatedly to select the audio source.

- 4 Rotate the VOL  (Volume/Power) knob to adjust the volume.



Audio Control Display

Press the AUDIO button to display the audio system on the navigation screen.



Map Screen Legend

Map orientation ➔ P.97

- North up
- Heading up

GPS signal strength

- Best reception
- Good reception
- No icon: Poor/No reception

Traffic status indicator ➔ P.99

- Traffic information available
- Flow or incident data not available
- Traffic information not available
- Traffic information off or map scale too large

Map scale ➔ P.95

Traffic incident icons ➔ P.99

- Congestion
- Incident
- Weather
- Construction
- Road Closed

Traffic flow indicator ➔ P.99

- Heavy (approx.)
surface: 0 to 20 mph
freeway: 0 to 25 mph
- Moderate (approx.)
surface: 21 to 30 mph
freeway: 25 to 52 mph

Streets

- Freeways
- State routes
- Verified streets
- Unverified streets
- One-way streets

Landmark icons ➔ P.92

- Acura dealer
- Honda dealer
- ATM
- School
- Parking lot
- Parking garage
- Grocery store
- Hotel/Lodging
- Gas station
- Hospital
- Post office
- Restaurant
- Freeway exit information

Feature areas

- Park
- Hospital
- Shopping Mall
- Golf Course
- Airport
- Water Area
- Cemetery
- University

Current map scale

Current street name/audio control
(Select **AUDIO / STREET** to switch the display.)

Current vehicle position ➔ P.98

Map menu ➔ P.85

During Route Guidance

During route guidance, route information is displayed on the map/guidance screen. Press the MAP/GUIDE button to display the guidance screen.

Map Screen

Calculated route

→ P80

Destination direction indicator
Direction "as the crow flies"

Distance to destination
Distance of the actual route.

Estimated time to destination
02:08

Guidance indicator
Distance to the next guidance point.
0.4 mi

Calculated route (unverified roads)
→ P82

Destination icon
→ P79

Waypoint → P103

Day or Night Mode

Press the (Display mode) button to manually switch between day and night mode.



Guidance Screen

Street name of guidance point
W 182ND ST

Route guidance list scroll bar
Select ▲ or ▼ to scroll the list of guidance points.

Distance to guidance point
500 ft

Route progress bar
0:13 to go



No entry icon

How to Enter Information

You can enter information (e.g., city names, street names, personal names, and business names comprising letters, numbers, and symbols) when prompted on input screens by two different methods.



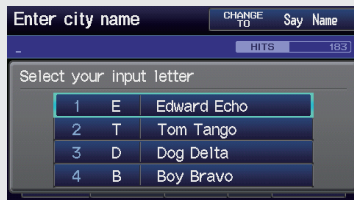

Using Voice Control

When you see  in this manual, voice commands are available for that feature.

- Say the letter, number, or symbol (e.g., say  "A").
- Use spelling assist (e.g., say  "Alpha" to enter the letter "A" or  "Hyphen" to enter a hyphen).
- The system beeps if you say an unavailable (grayed out) letter or number.
- If a voice command is not recognized, a list is displayed with possible options.



On list screens:

- Say the number of the list item (e.g., say  "Five" to select item 5).
- Say  "Up" or  "Previous" to scroll up one page.
- Say  "Down" or  "Next" to scroll down one page.

Using the Touch Screen

Touch a character or icon on the screen to select it.

- Select **Delete** to remove the last entered character.
- Select **Shift** to display accented and upper/lower case characters.
- Select **Space** to enter a space character.
- Select **More** to display symbols.

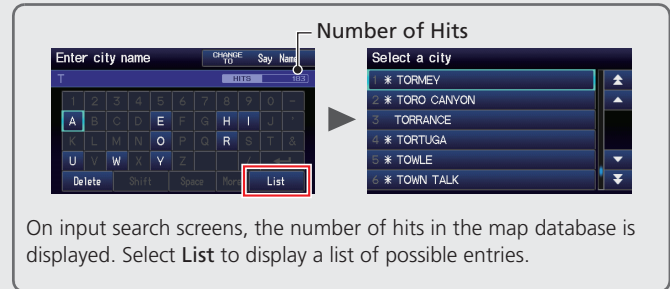

On input search screens, the number of hits in the map database is displayed. Select List to display a list of possible entries.

NOTE

You can also use the joystick to enter information.

 System Controls P. 4

On list screens:

Scrolling through lists or tabs is limited while the vehicle is moving.

Certain touch screen functions are limited or inoperable while the vehicle is moving. For these functions, use available voice commands or pull over to proceed.

Navigation—Home Addresses and Going Home

The “Home” feature automatically routes you to your home address from any location simply by selecting **Go Home 1** or **2**, or saying “Go Home.” You can store two home addresses as **Home Address 1** and **Home Address 2**.

Storing Your Home Address

- 1 Press the INFO button.



- 2 Select Setup.



- 3 Select Personal Information.
- 4 Select Home Address 1.

- 5 Select Edit Name.

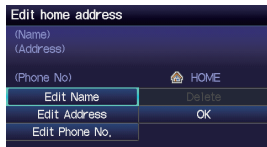

- 6 Enter a name and select OK.



- 7 Select Edit Address.
- 8 Select Address.
- 9 Enter an address.
- 10 Select Edit Phone No.

- 11 Enter a phone number and select OK.

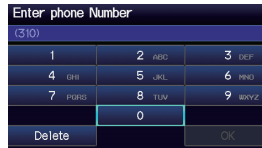

- 12 Select OK.

Going Home

- 1 Press the DEST button.



- 2 Select Go Home 1.

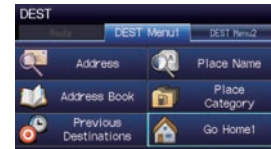

Alternatively, you can say “Go Home” from any screen. Your home address is displayed on the Calculate Route screen.

- 3 Select Set as Dest.

- The following voice commands are available: say “Go Home,” “Go Home 1,” “Go Home 2.”
- If you have two home addresses stored, saying “Go Home” will select **Home Address 1** when **DEST Menu1** is displayed or **Home Address 2** when **DEST Menu2** is displayed.

Navigation—Entering a Destination

Enter your destination using one of several methods, then follow route guidance on the map or guidance screen to your destination. You can also perform these steps using  voice control.

- 1 Press the DEST button.



- 2 Select Address.

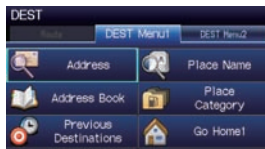

- 3 Select Street.

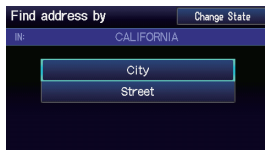

- 4 Enter the name of your destination street and select List if necessary.



- 5 Select your destination street from the list.

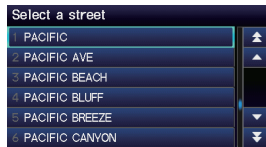

- 6 Enter the street number. Select OK when finished.



- 7 If there is more than one city with the specified street, a list of cities is displayed. Select the desired city from the list.



- 8 Select Set as Dest.

Route guidance to the destination begins.

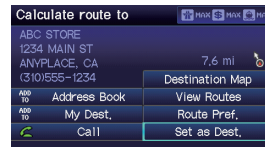

- **View Routes:** Choose one of three routes.

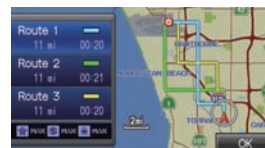

- **Route Pref.:** Choose MAX or MIN for the three settings.



Navigation—Changing Route or Destination

You can alter your route by adding waypoints to visit, adding streets to avoid, or changing your destination during route guidance.

Adding a Waypoint (“Pit Stop”)

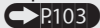
You can add up to four waypoints along your route. 

- 1 Press the DEST button.
- 2 Select **Waypoint**.

- 3 Select search method.

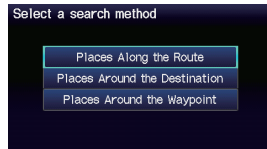



When you select **Places Around the Waypoint**, select the desired waypoint.

- 4 Select the icon category and location to add to the destination list when prompted.

Changing Your Destination

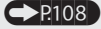
There are four methods you can use to specify a new destination during route guidance.

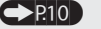
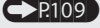
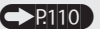
- Say  “Find Nearest...”  Searches for the nearest place/landmark on the map screen (e.g.,  “Find nearest gas station”).
- Say  “Go Home”  Routes to your home address.
- Selecting an icon on the map  Scroll the map to position the cursor over a place/landmark icon or a new area on the map. Press the ENTER button twice.
- Entering a new destination  Press the DEST button. Select **DEST Menu1/2** and enter a new destination.

Canceling Your Route

- 1 Press the DEST button.

- 2 Select **Cancel Route**.

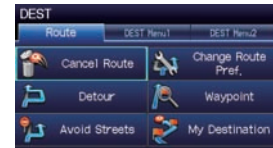

From the map screen:

- 1 Select **MAP MENU**.

- 2 Select **Cancel Route**.

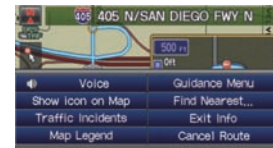

Voice Help

This navigation system comes with voice help information, which tells you how to use the voice command functions. Go to Voice Info for tips when using the voice command functions.

Getting Started Tutorial

1 Press the INFO button.

2 Select Voice Info.



3 Select Getting started.



You can also view the available command list for each system. See **Command Help** on this page.

4 Select Using the talk button.

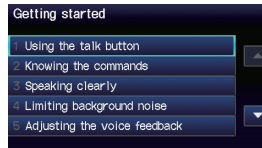

5 Select Read to hear the tutorial read aloud.

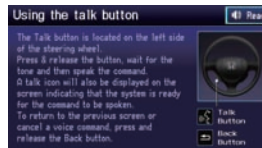

Select **Stop** to stop the tutorial.

Command Help

For "Command Help" menu items, all voice commands that are available for that system are listed.

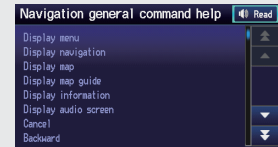

Select **Read** to hear the commands in the list read aloud.

Voice Commands → P.187

Troubleshooting

For more information  P163



Why does the vehicle position icon on the map “lag” a short distance behind my actual position, especially at intersections?



This is normal. The navigation system is unaware of the width of intersections. Large differences in vehicle position can indicate a temporary loss of the GPS signal.



Why does the “time to destination” display sometimes increase even though I am getting closer to my destination?



The “time to destination” is based on the posted road speed signs and your actual road speed to give you a better estimate of arrival time.



Why does my clock frequently change the time forward and backward by one hour?



The clock setting is automatically updated based on your GPS location. If you normally drive between two time zones, the clock may keep adjusting the time. You can turn this feature off.

 **Clock Adjustment** P. 47



How do I specify a destination when an entered city or street could not be found?



Try entering the street first. Some cities are lumped in with a major metro area. In rural “unverified” areas or new subdivisions, streets may be missing or only partially numbered.



How do I turn on the navigation system voice guidance?



1. Press the INFO button. Select **Setup**. Check that **Volume** is not set to **Off**.
2. Select **Other**, then **Basic Settings**. Set **Voice Recognition Tutor** to **On** if you want the system to provide confirmations and system prompts.



My battery was disconnected or went dead, and the navigation system is asking for a code. Where do I find it?



Your vehicle comes with a label in the Owner’s Manual kit that includes the system’s security code and serial number. You should keep this label in a safe place outside your vehicle. If you cannot find it, contact your dealer.

How to Use This Manual



This section explains different methods on how you can easily find information in this manual.



Searching the Table of Contents

➔ P.1

Two types of Tables of Contents help you find your desired information.

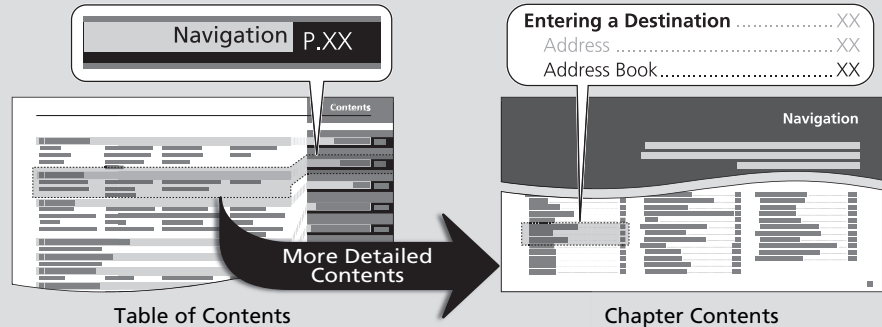

First, find the general chapter related to what you are looking for (e.g., entering a destination from the Address Book). Then, go to that chapter to view a more specific table of contents.

This more detailed table of contents shows you exactly what information is listed by section and title.



Searching the Index

➔ P.198

Menu items displayed on the navigation screen (e.g., Address Book) can be found individually in the Index.

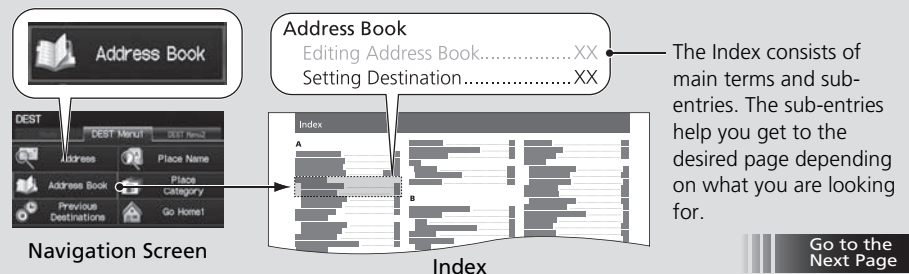

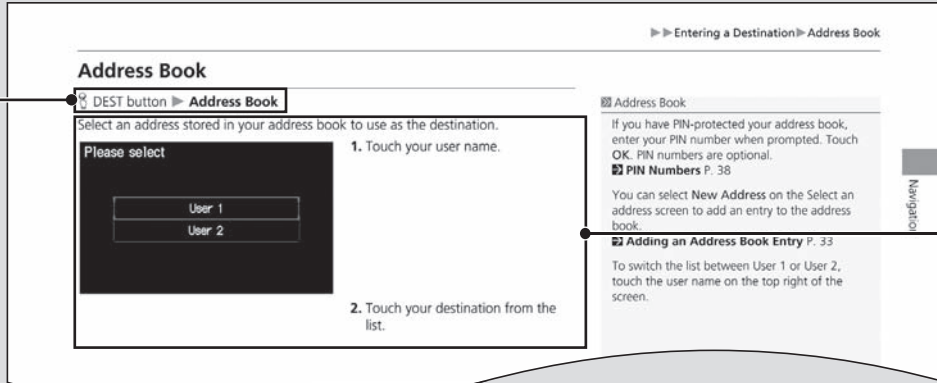

After following the menu tree, step-by-step instructions explain how to achieve the desired result.



Menu Tree

The menu tree helps guide you through the system's menu options. To get to your desired function, follow the menu tree in order of the steps shown.

NOTE:

All menu options can also be activated with voice commands.

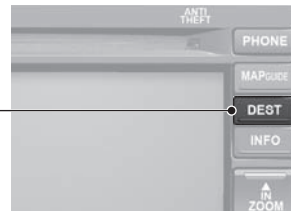

Press the hard button on the system control panel.

Press the DEST button.



Select the menu option.

Select Address Book.

* Sample pages and images in this section may differ from the actual ones.

System Setup

This section describes the start-up procedure and the navigation and setup functions.



Start-up	18	User Name	38	Data Reset	53
Voice Control System	20	Previous Destinations	39	Reset Factory Default Settings	53
Command Input	20	Routing & Guidance	40	Clear All Speed Dial.....	54
Voice Recognition	21	Rerouting.....	41		
Interface Settings	22	Unverified Area Routing.....	42		
Display and Volume Settings	22	Edit Avoid Area	44		
Guidance Prompts.....	23	Edit Waypoint Search Area.....	46		
Basic Settings.....	24	Clock Adjustment	47		
Color	25	Adjust Time	48		
Language.....	29	Resetting the Clock Settings.....	48		
Personal Information	30	Setting the Clock Type	49		
Address Book.....	31	Vehicle	50		
Home Addresses	36	Off-road Tracking	51		
PIN Numbers.....	37	Correct Vehicle Position	52		

The navigation system starts automatically when you turn the ignition to ACCESSORY (I) or ON (II). At start-up, the following Confirmation screen is displayed.

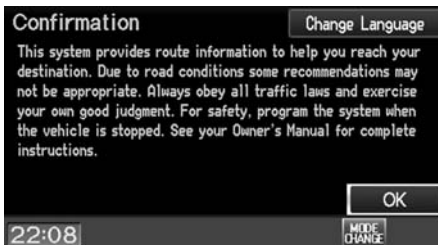
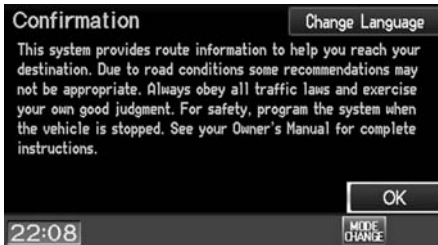

1. Select **Change Language**.

- ▶ If you do not need to change the system language, proceed to step 3.

2. Select the system language.

3. Select OK.

- ▶ Your current position is displayed on the map screen.

» Start-up

If the navigation system loses power at any time, you may need to press and hold the VOL  (Volume/Power) button for more than two seconds, or you may be prompted for the 5-digit security code.

➤ **System Initialization** P. 176

You can change the system language at any time.

➤ **Language** P. 29

“OK” on the Confirmation screen cannot be selected by using a voice command. If you do not select OK within 30 seconds, the screen turns dark and you cannot use voice commands. Press any navigation or voice control button to continue.

➤ **Clock Adjustment** P. 47

➤ **Setting the Clock Type** P. 49

Limitations for Manual Operation

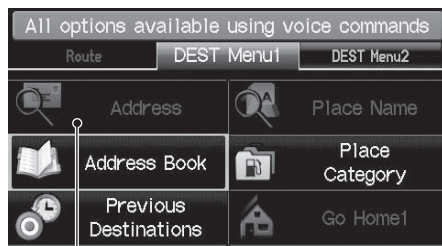



Disabled Option

Certain manual functions are disabled or inoperable while the vehicle is in motion. You cannot select a grayed-out option until the vehicle is stopped.

Voice commands are still operable while the vehicle is in motion.

Your vehicle has a voice control system that allows hands-free operation of most of the navigation system functions. You can also control the audio and climate control system, and make and receive phone calls using *Bluetooth*® HandsFreeLink®.

The voice control system uses the  (Talk) and  (Back) buttons on the steering wheel and a microphone near the map lights on the ceiling.

A “Voice Info” feature provides a tutorial that explains how to use the voice control system.

 **Voice Help** P. 13

Command Input

If the system does not understand a command or you wait too long to give a command, it responds with “Pardon? No command was heard. Please press the talk button and say a command.”

When you give a command, the system generally either repeats the command as a confirmation or asks you for further information. If you do not wish to hear this feedback, you can turn it off. However, listening to the feedback will help familiarize you with the way the system expects commands to be phrased.

 **Basic Settings** P. 24



If the system cannot perform a command or the command is not appropriate for the screen you are on, the system beeps.

If the system responds with prompts such as “Please use the touch screen to...” or “Please use the joystick to...,” the system is asking for input that cannot be performed using the voice control system.

On character input screens, a list of possible characters is displayed if the system does not recognize your command.

You can find out which voice commands are available for a particular screen using the  Help command. The system will display and read the list of available commands to you.

(Talk) Button

When you press the  (Talk) button, a helpful prompt asks what you would like to do. Press and release the  (Talk) button again to bypass this prompt and give a command.

Command Input

The audio system is muted while using the voice control system.

Voice Recognition

To achieve optimum voice recognition when using either the navigation voice control system or *Bluetooth*® HandsFreeLink®:

- Make sure the correct screen is displayed for the voice command that you are using.
▶ **Voice Commands** P. 188
- Close the windows and moonroof.
- Adjust the dashboard and side vents so air does not blow onto the microphone on the ceiling.
- Speak clearly in a clear, natural speaking voice without pausing between words.
- Reduce any background noise if possible. The system may misinterpret your command if more than one person is speaking at the same time.
- Refer to the Voice Info tutorial.
▶ **Voice Help** P. 13

Display and Volume Settings

INFO button ► **Setup**

Use the Main Setup screen to adjust the display and volume.



Select ◀ or ▶ to adjust the desired item.

The following items are available:

- **Brightness:** Adjusts the screen's brightness.
- **Contrast:** Adjusts the screen's contrast.
- **Black Level:** Adjusts the screen's black level.
- **Volume:** Adjusts the navigation system volume level.

» Display and Volume Settings

You can set separate daytime and nighttime settings for **Brightness**, **Contrast**, and **Black Level**. Adjust each setting when the display is in either daytime or nighttime mode.

You can set the display and volume settings using voice commands.

➤ **Main Setup Screen Commands** P. 193

Volume

If you set **Volume** to **Off**, you will not hear route guidance or voice command confirmations. If you then select **Voice** on the map menu, you will hear route guidance at the default volume.

Guidance Prompts

INFO button ▶ **Setup**

Set the number of guidance prompts before you get to the guidance point.



Select an option.

The following options are available:

Items	Distance from Guidance Point		
	About 1/2 mile	About 1/4 mile	Just before
MIN		Yes	
NORMAL (factory default)	Yes	Yes	Yes
MAX	Yes*	Yes*	Yes

* Provides extra voice guidance information (e.g., "Take the second exit toward Los Angeles").

Guidance Prompts

To replay voice guidance, select **Voice** on the map menu.

▶ **Listening to Voice Guidance** P. 84

You can turn voice guidance off if you prefer.

▶ **Display and Volume Settings** P. 22

Basic Settings

🔍 INFO button ► Setup ► Other ► Basic Settings

Set the map units to either miles or kilometers, and control the voice feedback from the navigation system.



Select an item.

The following items are available:

- **Keyboard Layout:** Sets the type of keyboard screen to either Alphabet (factory default) or QWERTY.
- **Units:** Sets the map units to either miles (factory default) or kilometers.
- **Voice Recognition Tutor:** Turns the voice feedback feature on or off.
On (factory default): Provides voice control system confirmation or prompts.
Off: Disables the feature.
- **Display Voice Command Tips:** Alerts you when manual control of the system is disabled to prevent distraction while driving. Only voice commands are available.
On (factory default): Displays a message.
Off: Disables the message, but some options may be grayed out on the screen.

- **Verbal Reminder:** Turns the verbal reminders on or off.
 - On** (factory default): Provides warning voice messages when:
 - Driving with the parking brake on
 - Driving without wearing the driver and/or passenger seat belt
 - Off:** Disables the feature.

Color

INFO button ▶ **Setup** ▶ **Other** ▶ **Color**

Choose the color of the navigation map and system menus.



Select an item.

The following items are available:

- **Map:** Sets the color of the map screen.
 - **Map Color** P. 26
- **Menu:** Sets the color of the menu screens.
 - **Menu Color** P. 26

■ Map Color

🔍 INFO button ▶ **Setup** ▶ **Other** ▶ **Color** ▶ **Map**

Set separate map colors for Day and Night modes.



Select a color for the map screen.

■ Menu Color

🔍 INFO button ▶ **Setup** ▶ **Other** ▶ **Color** ▶ **Menu**

Set separate menu colors for Day and Night modes.



Select a color for the menu screens.

»» Map Color

For Day mode

Set to **White** (factory default is **Beige**) to obtain the best daytime display contrast.

For Night mode

Set to **Black** (factory default) to obtain the best nighttime display contrast.

»» Menu Color

For Day mode

Set to **Black** (factory default is **Blue**) to obtain the best daytime display contrast.





For Night mode

Set to **Black** (factory default is **Blue**) to obtain the best nighttime display contrast.

Switching Display Mode Manually

Set the screen brightness separately for Day and Night modes. Press the  (Display mode) button to cycle through the display modes (Day to Night to Off).



1. Press the  button.
 - ▶ The Brightness bar is displayed for a few seconds.
2. Press the  button again.
 - ▶ Repeat the procedure to switch the display modes.
 - ▶ Select  or  to adjust the brightness.

Switching Display Mode Manually

A visual guide helps you see the difference between Day and Night modes.

 **Day or Night Mode** P. 8

Recommended Settings

- Select mid-range for the dash illumination.
- Select **White** for the map Day display and **Black** for the map Night display.

Illumination control	Priority	Operation
☾☼ button	1	Selects Day, Night, or Off display mode. This button has the highest priority and overrides all other display control adjustments listed below.
Sunlight sensor (see your Owner's Manual for location)	2	If the sunlight sensor detects daylight and the headlights are turned on, the system automatically overrides the Night display and displays the Day display mode. Remember: If desired, use the ☾☼ button to override this automatic choice.
Dash illumination adjustment buttons (see your Owner's Manual for location)	3	When the headlights are turned on, and you wish to have the Day display mode, adjust the illumination to full brightness (beeps). Remember: Adjust the dash brightness back to mid-range to allow auto switching by sensing the headlights are on or off.
Headlights (Auto/On/Off)	4	When turned on, the display changes to Night display mode. The previous three controls listed above can "cancel" this function. Remember: Use the ☾☼ button, or adjust the dash illumination to full brightness, to set the display to your desired choice.
Screen color choice	N/A	The user can select the color of the screen that will be displayed for the Day and Night display modes described above. Remember: For best contrast, ensure that the map color is white for Day and black for Night.

Language

INFO button ▶ **Setup** ▶ **Other** ▶ **Language**

Set the system language used on all screens. You can choose from three languages: **English**, **Français** (French), **Español** (Spanish).



Select the system language.

Language

Voice confirmation of cities and streets only occurs when **English** is the system language.

When **Français** or **Español** is selected, some messages continue to be displayed in English.

INFO button ► Setup ► Personal Information

Use the personal information menu to select and set your address books, home addresses, and PINs. You can also delete unwanted destinations from the list of previously routed destinations.

Edit personal information	
Address Book	PIN Number
Home Address1	User Name
Home Address2	Previous Destinations

Select an item.

The following items are available:

- **Address Book:** Stores new addresses or edits your address book.
➤ **Address Book** P. 31
- **Home Address 1:** Sets or edits your home address.
➤ **Home Addresses** P. 36
- **Home Address 2:** Sets or edits another home address.
➤ **Home Addresses** P. 36
- **PIN Number:** Sets or changes your PIN.
➤ **PIN Numbers** P. 37
- **User Name:** Sets or changes your user name.
➤ **User Name** P. 38
- **Previous Destinations:** Deletes the destination history.
➤ **Previous Destinations** P. 39

» Personal Information

Personal information cannot be backed up or moved to another navigation system.

Address Book

INFO button ▶ Setup ▶ Personal Information ▶ Address Book

Store up to 200 address entries in two address books (User 1 and User 2). You can add, edit, and delete information in the address books.



Select the user name to edit the user address book.

Displays the address book.

- ▶ Select the user name to change the user address book.
- ▶ Select the category tab to display only the address in the selected category.



Address Book

The number of addresses is shared by the two address books. For example, if User 1 has 150 addresses, User 2 can only have 50.

If you have PIN-protected your address book, enter your PIN when prompted. Select **OK**. PINs are optional.

▶ **PIN Numbers** P. 37

Any address book categories you create are also displayed on the Select an address screen.

▶ **Selecting an Address Book Category** P. 34

■ Adding an Address Book Entry

🔑 INFO button ▶ **Setup** ▶ **Personal Information** ▶ **Address Book**

This section explains how to enter the name and address.



1. Select **New Address**.



2. Select an item.

The following items are available:

- **Edit Name:** Edits the name of the entry.
- **Edit Address:** Edits the address of the entry.
- **Edit Phone No.:** Edits the phone number of the entry.
- **Edit Category:** Specifies the category of the entry.
- **Delete:** Deletes the entry.

▶▶ Adding an Address Book Entry

If you do not give the address a name, one is automatically assigned (e.g., ADDRESS 001). You can re-enter, edit, or make changes to any entry. "Address" is the only required field.

Input address by	
Current Position	Place Name
Address	Place Category
Previous Destinations	Place Phone Number

3. Select **Edit Name**.
4. Enter a name or title. Select **OK**.
5. Select **Edit Address**.
6. Select an item for specifying the address.

The following items are available:

- **Current Position:** Select your current location.
- **Address:** Enter an address on the character input screen when prompted.
 - **Address** P. 58
- **Previous Destinations:** Select a previous destination.
 - **Previous Destinations** P. 64
- **Place Name:** Enter the name of a place/landmark.
 - **Place Name** P. 65
- **Place Category:** Select a category to search for a place/landmark (e.g., Banking, Lodging).
 - **Place Category** P. 67
- **Place Phone Number:** Enter the phone number of a place/landmark.
 - **Place Phone Number** P. 72

➤ Adding an Address Book Entry

When you use **Place Name** or **Place Category**, the name and phone number are automatically entered.

■ Editing an Address Book Entry

🔍 INFO button ▶ **Setup** ▶ **Personal Information** ▶ **Address Book**

Edit address	
ABC STORE 1234 MAIN ST ANYPLACE, CA (310)555-1234	
🔍 PERSONAL	
Edit Name	Edit Category
Edit Address	Delete
Edit Phone No.	OK

1. Select the address to edit.
2. Enter the name, address, phone number, and category fields.
 - ▶ **Adding an Address Book Entry**
P. 32
3. Select OK.

■ Selecting an Address Book Category

🔍 INFO button ▶ **Setup** ▶ **Personal Information** ▶ **Address Book**

Select a category	Edit Category
1 > New Category	▲
2 📁 BUSINESS	
3 📁 PERSONAL	
4 UNFILED	▼

1. Select an address.
2. Select **Edit Category**.
3. Select **BUSINESS**, **PERSONAL**, or a category you created.

▶▶ Editing an Address Book Entry

The entered contents are displayed on the Edit address screen.

▶▶ Selecting an Address Book Category

You can have up to 100 categories (including "UNFILED"). These categories can be shared with User 1 and User 2. For example, if User 1 creates some categories, User 2 can also use them.

If you delete a category that is used by other addresses, the category type for those addresses changes to "UNFILED."

Category Icons

The following icons can be selected for a category:



■ **Creating a New Category**

1. Select **New Category**.
2. Enter a name and select an icon when prompted. Select **OK**.
 - ▶ The created category is displayed in the list of categories.

■ **Deleting or Editing a Category**

1. Select **Edit Category**.
2. Select **Edit Category** or **Delete**.
3. Delete an existing category, or change the name and icon.

■ **Deleting an Address Book Entry**

🔑 INFO button ▶ **Setup** ▶ **Personal Information** ▶ **Address Book**



1. Select the address to delete.
2. Select **Delete**.
3. Select **Yes**.

⌘ **Deleting an Address Book Entry**

When you transfer the vehicle to a third party, delete all address book entries.

Home Addresses

INFO button ▶ Setup ▶ Personal Information ▶ Home Address 1 or Home Address 2

Set two home addresses that you frequently use.

Edit home address	
(Name)	
(Address)	
(Phone No)	HOME
Edit Name	Delete
Edit Address	OK
Edit Phone No.	

1. Edit the name, address, and phone number the same way as an address in the address book.

▶ **Adding an Address Book Entry**
P. 32

2. Select **OK**.

▶▶ Home Addresses

If you have PIN-protected your home addresses, enter your PIN when prompted. Select **OK**. PINs are optional.

▶ **PIN Numbers** P. 37

If your home street is not in the system database, park on the nearest verified street to your home. When entering the “Address” field, select **Current Position** to use your current location as the home address.

You can delete a home address if necessary. Select **Delete**. Select **Yes**.

When you transfer the vehicle to a third party, delete all home addresses.

The home icon is shown on the map screen on 5 mile or less map scales.

PIN Numbers

INFO button ► **Setup** ► **Personal Information** ► **PIN Number**

Set a 4-digit PIN for protecting personal addresses and your home addresses. Once you set a PIN, you are prompted to enter it whenever you access a personal address or a home address.

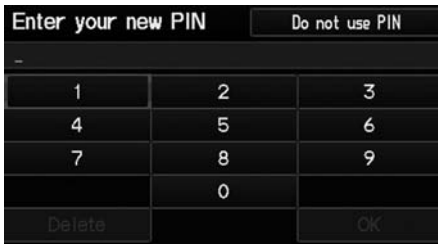
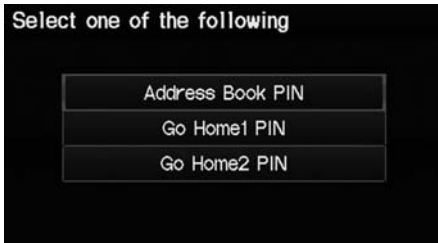

1. Select the PIN to create.
2. Select the user name (when selecting **Address Book PIN**).
3. Enter a 4-digit PIN.
4. Re-enter the new PIN when prompted to confirm the number you just entered.
 - If you do not enter the same number both times, an "INCORRECT PIN" message is displayed. Enter your PIN again.

PIN Numbers

PIN

Personal Identification Number (PIN) is a password used to access some personal data.

PINs are optional. If you choose to use a PIN, keep a note of the number in a secure location. If you forget your PIN, your dealer will have to reset the navigation system and all of your stored information will be erased. The factory default is no PIN.

Go Home PIN

Go Home PINs are shared with User 1 and User 2. If either User 1 or User 2 sets a Go Home PIN, both of them need to enter the PIN when:

- selecting **Go Home** for a destination
- selecting **Home Address** for editing

If you want to stop using a PIN, select **Do not use PIN**.

User Name

🔍 INFO button ▶ **Setup ▶ Personal Information ▶ User Name**

Change the user name ("User 1" or "User 2") to your desired name.

Select the user name to edit

User 1

User 2

1. Select the name to change.
2. Enter a name. Select OK.

Previous Destinations

INFO button ▶ Setup ▶ Personal Information ▶ Previous Destinations

The navigation system maintains a list of your previously routed destinations as a shortcut for entering the same destination in the future. You can delete some or all of your previous destinations from the list.



1. Select the destination to delete.
 - ▶ Repeat the procedure as necessary.
 - ▶ Items to be deleted are indicated with a trash icon.



Trash icon

2. Select OK to delete the selected destinations.

Previous Destinations

Up to 50 destinations can be stored.

The list of previous destinations is shared with User 1 and User 2. For example, if User 1 deletes some previous destinations, they are deleted for User 2 as well.

To cancel the selection of a previous destination, select the destination again.

Selecting **Delete All** allows you to delete all destinations.

INFO button ► **Setup** ► **Other** ► **Routing & Guidance**

Choose various settings that determine the navigation system functionality during route guidance.

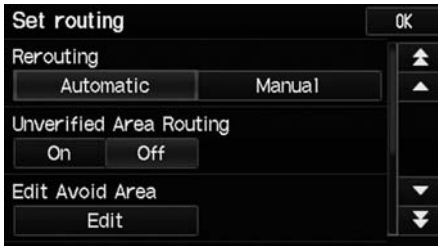

Select an item.

The following items are available:

- **Rerouting**: Sets the route recalculation to automatic or manual mode.
➤ **Rerouting** P. 41
- **Unverified Area Routing**: Sets whether you use the route guidance in unverified areas.
➤ **Unverified Area Routing** P. 42
- **Edit Avoid Area**: Specifies areas to avoid when calculating a route.
➤ **Edit Avoid Area** P. 44
- **Edit Waypoint Search Area**: Sets the distance from the route to find waypoints.
➤ **Edit Waypoint Search Area** P. 46
- **Guidance Mode**: Sets whether to display only the map screen or a split map-guidance screen.
➤ **Guidance Mode** P. 90

Rerouting

INFO button ► **Setup** ► **Other** ► **Routing & Guidance**

Set whether route recalculation occurs automatically or manually during route guidance.

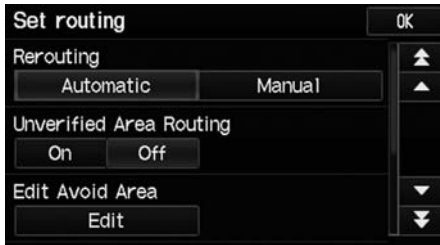

Select an option.

The following options are available:

- **Automatic** (factory default): The system calculates a new route automatically when you deviate from the route. It is strongly recommended that you leave the system set to Automatic.
- **Manual**: Disables route recalculation. The system beeps and “Off route” is displayed when you deviate from the route.

⌘ Rerouting

If you live in an area with poor mapping, you may wish to set **Rerouting** to **Manual** to avoid constant recalculation. You will need to select **Recalc.** manually to make the system recalculate your new route.

Unverified Area Routing

INFO button ► Setup ► Other ► Routing & Guidance

Receive turn-by-turn map and voice guidance in unverified areas.

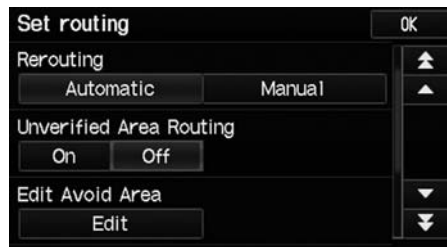

Select **On** or **Off**.

Differences	Off (factory default)	On
On or Off?	The driver wishes to manually navigate using the navigation map and choose the streets that lead to the destination.	The driver chooses to let the navigation system suggest possible routing, knowing that the guidance may not be accurate.
Route calculation	Route is usually longer, using verified roads whenever possible.	Route is shorter, but uses unverified (purple) streets that may not be accurate.
Route line	A blue dotted vector line is displayed on the map that continually points to your destination.	A blue-pink dashed route line highlights suggested unverified streets on the map while traveling to your destination.
Cautionary messages	Cautionary pop-up screens and voice announcements remind you to obey all traffic restrictions.	Cautionary pop-up screens and voice announcements remind you to exercise additional caution and obey all traffic restrictions.

Unverified Area Routing

Unverified roads are found in rural areas, and typically include residential streets away from the center of a town. They may not be accurate, and can contain errors in location, naming, and address range.

Unverified roads are shown only when viewing the map in the 1/20, 1/8, 1/4, 1/2, 1, or 2 mile map scales.

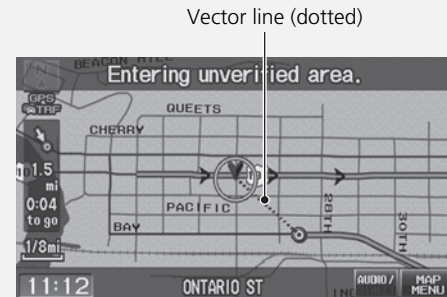

Vector line (dotted)

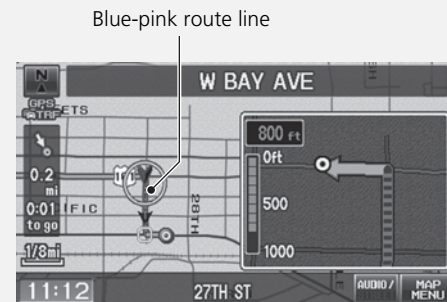

Blue-pink route line

Differences	Off (factory default)	On
Guidance (map/voice)	There is no turn-by-turn map or voice guidance.	Voice guidance commands end with the phrase “if possible” to remind you to verify all traffic restrictions.
My Destination (Direction list)	A direction list is typically not available. However, depending on your route, directions are provided to help you reach the first available verified road.	A direction list is provided showing unverified street names in blue boxes and turn symbols in pink.

Edit Avoid Area

🔍 INFO button ► Setup ► Other ► Routing & Guidance ► Edit Avoid Area
"Edit"

Specify up to five areas to avoid (e.g., road construction, closures), if possible, when the system calculates routes to your destination.

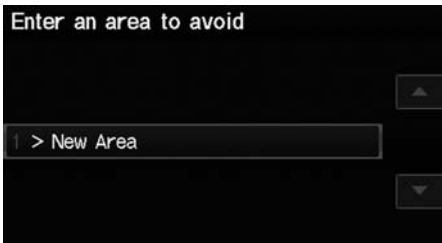

1. Select **New Area** or an existing area to edit.
2. Select **Edit Name** to label the area to avoid.
3. Enter a name or title. Select **OK**.
4. Select **Edit Area** to define the area to avoid.

The following items are available (after an area is set):

- **View Area Map:** Displays the selected avoid area on the map.
- **Delete:** Deletes the selected avoid area.

» Edit Avoid Area

The avoid areas are shared with User 1 and User 2. For example, if User 1 specifies some avoid areas, User 2 can also use them for setting a route.

The maximum size of an "avoid area" is about 1 square mile.

If your selected area contains a freeway, you are asked "Do you want to avoid freeways?" Answering "No" allows you to use a route through an avoid area on a freeway without any pop-up messages.

You can select areas to avoid, however you cannot select roads or areas that you want the system to use for routing.

You can enter characters for the name until the input field is full.



5. Select a method for specifying the area.

The following items are available:

- **Address:** Specify the general area by entering an address.
▶ Address P. 58
- **Map Input:** Specify the general area by map input.
▶ Map Input P. 75

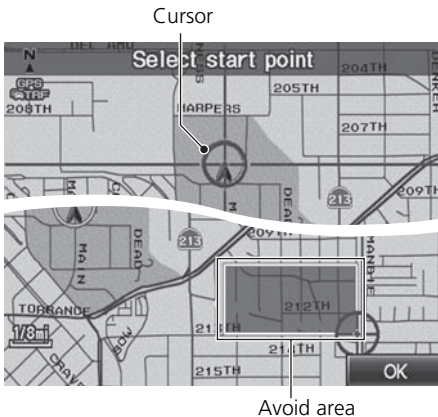

6. Scroll the map to position the cursor over your desired start point, adjusting the map scale as necessary. Press the ENTER button to mark the start point.

▶ To redo the area selection, press the CANCEL button.

7. Scroll the map to "draw" the area. Press the ENTER button to mark the end point.

8. Select OK.

▶ The area you specify is displayed in the list of areas to avoid.

Edit Waypoint Search Area

📍 INFO button ► **Setup** ► **Other** ► **Routing & Guidance** ► **Edit Waypoint Search Area** **“Edit”**

Select the distance from your highlighted route line (on either side of your route) that the system will search for a waypoint.

📖 **Adding Waypoints** P. 103

You can specify a different search distance for freeways and surface streets.

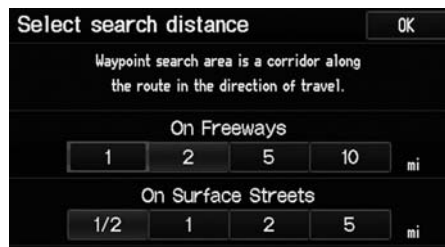

1. Select a search distance.
2. Select OK.

The following options are available:

- **On Freeways:** 1, 2, 5, or 10 miles can be set. Factory default is 2 miles.
- **On Surface Street:** 1/2, 1, 2, or 5 miles can be set. Factory default is 1/2 mile.

» Edit Waypoint Search Area

The search distance does not affect the search range used for the Find Nearest voice commands (e.g., say  "Find nearest gas station").

INFO button ► **Setup** ► **Other** ► **Clock Adjustment** ► **Clock Adjustment**

Set the automatic adjustment of the system clock for daylight saving and international time zones.



Select an item.

The following items are available:

- **Auto Daylight:** The navigation system automatically adjusts the clock ("spring ahead" or "fall back" by one hour) when a daylight saving time change occurs.
On (factory default): Adjusts the clock automatically.
Off: Disables the feature.
- **Auto Time Zone:** The navigation system automatically adjusts the clock when driving through different time zones.
On (factory default): Adjusts the clock automatically.
Off: Disables the feature.
- **Clock Format:** Sets the time notation to either 12-hour clock (**12H**, factory default) or 24-hour clock (**24H**).
- **Time Adjustment:** Adjust the current time manually.
► **Adjust Time** P. 48
- **Reset:** Reset the clock settings to the factory default.
► **Resetting the Clock Settings** P. 48

► Clock Adjustment

You can check the time and date from any screen using voice commands.

► **Global Commands** P. 188

Auto Daylight

This function is not activated in areas that have not adopted daylight saving time, even if you have set **Auto Daylight** to **On**.

Auto Time Zone

If you live and work in two different time zones, you may want to turn **Auto Time Zone** to **Off**. When driving near a time zone boundary, the displayed time zone may fluctuate between the two zone times.

Adjust Time

INFO button ▶ Setup ▶ Other ▶ Clock Adjustment ▶ Clock Adjustment

Adjust the current time (hours and minutes).

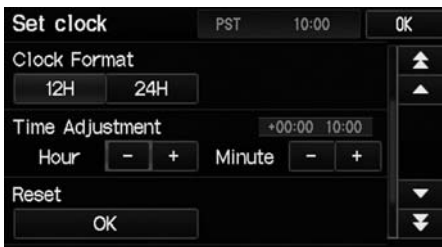

1. Select or to adjust the value.
2. Select OK on the top right of the screen.

Resetting the Clock Settings

INFO button ▶ Setup ▶ Other ▶ Clock Adjustment ▶ Clock Adjustment

Reset all clock settings to the factory defaults.

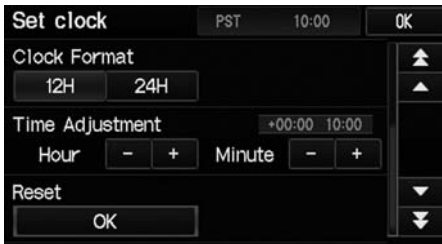

Select OK under Reset.

Setting the Clock Type

INFO button ▶ **Setup** ▶ **Other** ▶ **Clock Adjustment** ▶ **Clock Type**

Set the design of the clock screen.



1. Select **Clock Type** or **Background**.
2. Select an option to change the design.
3. Select **OK**.

INFO button ► **Setup** ► **Other** ► **Vehicle**

Set the off-road tracking feature and correct the vehicle position displayed on the map.



Select an item.

The following items are available:

- **Off-road Tracking:** Set whether to display the tracking dots on the map.
➤ **Off-road Tracking** P. 51
- **Current Vehicle Position:** Adjust the position of the vehicle on the map.
➤ **Correct Vehicle Position** P. 52

Off-road Tracking

INFO button ▶ **Setup** ▶ **Other** ▶ **Vehicle**

The navigation system can be set to display white off-road tracking dots (“breadcrumbs”) on the map screen whenever you drive into an area approximately 1/2 mile away from a mapped road.

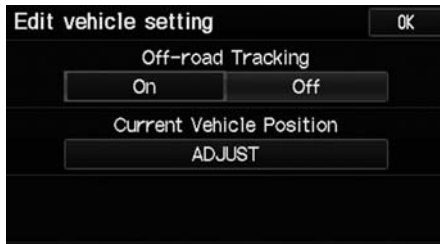

Select an option.

The following options are available:

- **On:** The system displays the white tracking dots.
 ▶ **Driving Off-road P. 83**
- **Off** (factory default): Disables the feature.

Correct Vehicle Position

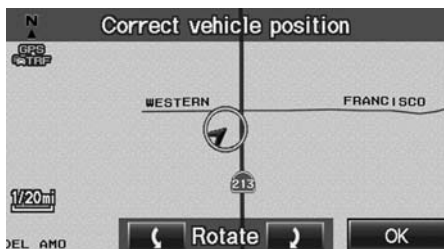

INFO button ▶ Setup ▶ Other ▶ Vehicle

Manually adjust the current position of the vehicle as displayed on the map screen if the position appears to be incorrect.

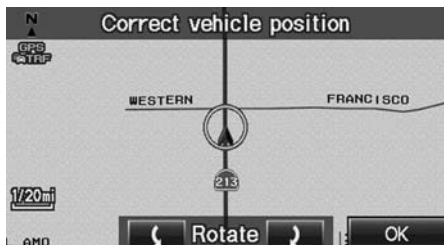

1. Put the vehicle in Park.
2. Select **ADJUST** under **Current Vehicle Position**.
3. Scroll the map to position the arrowhead at your correct position.



4. Select  or  to position the arrowhead in the correct direction the vehicle is facing.
5. Select **OK**.

» Correct Vehicle Position

An apparent position error can occur where buildings, tunnels, and other objects block or reflect the GPS signals, forcing the system to use "dead reckoning" to determine your location and direction.

Using this function to adjust vehicle position is not recommended. When the system reacquires a GPS signal, it will automatically place the vehicle in the correct location.

If you continually have to adjust the vehicle position, you may have problems with the GPS reception or there may be database errors.

 **System Limitations** P. 178

Reset Factory Default Settings

INFO button ► **Setup** ► **Other** ► **Reset Factory Default**

Reset all the settings on the Setup screens to their factory defaults.

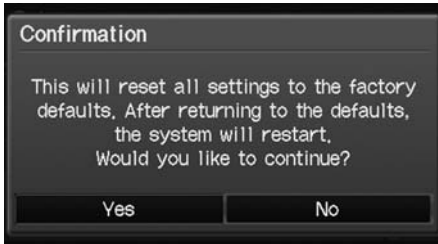

Select **Yes**.

Reset Factory Default Settings

The following settings are reset:

- Brightness, Contrast, Black Level, Volume, Guidance Prompts
- Basic Settings: Keyboard Layout, Units, Voice Recognition Tutor, Verbal Reminder, Display Voice Commands Tips
- Routing & Guidance: Rerouting, Unverified Area Routing, Edit Waypoint Search Area, Guidance Mode
- Clock Adjustment: Auto Daylight, Auto Time Zone, Clock Format Time, Clock Type
- Vehicle: Off-road Tracking
- Color: Map Color, Menu Color

When you transfer the vehicle to a third party, reset all settings to default and delete all personal data.

- **Deleting an Address Book Entry** P. 35
- **Home Addresses** P. 36
- **PIN Numbers** P. 37
- **User Name** P. 38
- **Previous Destinations** P. 39
- **Edit Avoid Area** P. 44
- **Deleting a Paired Phone** P. 145

Clear All Speed Dial

INFO button ▶ **Setup** ▶ **Other** ▶ **Clear All Speed Dial**

Delete all registered speed dials stored in *Bluetooth*® HandsFreeLink®.

Select **Yes**.

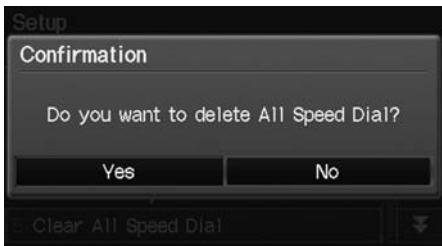

» Clear All Speed Dial

You can also delete a speed dial individually.

▶ **Setting Up Speed Dialing** P. 147

Navigation



This section describes how to enter a destination, select a route to take, and follow the route to your destination. It also describes how to change your route or destination along the way.

Entering a Destination	56	Calculating the Route	77	Changing Your Route	101
Address	58	Changing the Route Preference	78	Canceling the Route	102
Address Book	63	Viewing the Routes	78	Taking a Detour	102
Previous Destinations	64	Calculating the Route on the Destination		Avoiding Streets	102
Place Name	65	Map	79	Adding Waypoints	103
Place Category	67	Driving to Your Destination	80	Editing My Destination	107
Place Phone Number	72	Viewing the Route	80	Changing Your Destination	108
Coordinate	73	Listening to Voice Guidance	84	Find Nearest Place	108
Intersection	74	Map Menu	85	Selecting a Destination on the Map	109
Map Input	75	Displaying the Map Menu	85	Entering a New Destination	110
		Guidance Menu	87	Resuming Your Trip	112
		Showing Icons on the Map	92		
		Map Legend	94		
		FM Traffic	99		

Entering a Destination

DEST button

This section describes how to enter a destination for route guidance.





Select an item.

- ▶ Select **DEST Menu 2** to display additional menu entries.



The following items are available:

- **Address**: Sets a destination by entering an address.
 **Address** P. 58
- **Address Book**: Sets a destination by selecting an address stored in your Address Book.
 **Address Book** P. 63
- **Previous Destinations**: Sets a destination by selecting a previous destination.
 **Previous Destinations** P. 64

» Entering a Destination

 "Display Menu",  "Display Navigation"

If you press the DEST button when en route, the Route Menu screen is displayed.

 **Changing Your Route** P. 101

Prior to departure, you can set areas along your route to avoid.

 **Avoiding Streets** P. 102

Certain touchscreen functions are disabled while the vehicle is moving.

 **Limitations for Manual Operation** P. 19

- **Place Name:** Sets a destination by entering a place name.
 ▶ **Place Name** P. 65
- **Place Category:** Sets a destination by selecting a place/landmark.
 ▶ **Place Category** P. 67
- **Place Phone Number:** Sets a destination by entering the phone number of a place/landmark.
 ▶ **Place Phone Number** P. 72
- **Coordinate:** Sets a destination by entering latitude and longitude.
 ▶ **Coordinate** P. 73
- **Intersection:** Sets a destination (intersection) by entering two streets.
 ▶ **Intersection** P. 74
- **Map Input:** Sets a destination by scrolling through the map.
 ▶ **Map Input** P. 75
- **Go Home 1 or 2:** Sets your home address as a destination.
 ▶ **Going Home** P. 10

Address

🔑 DEST button ▶ **Address**

Enter an address to use as the destination. The state or province you are currently in is displayed (e.g., California).



Select an item.

The following items are available:

- **City**: Selects your destination city.
📄 **Selecting a City** P. 60
- **Street**: Selects your destination street.
📄 **Selecting a Street** P. 61
- **Change State**: Selects the state or province.
📄 **Selecting the State or Province** P. 59

Selecting the State or Province

📍 DEST button ▶ **Address** ▶ **Change State**



1. Enter a state name.
 - ▶ Select **List** to display a list of states.
2. Select a state from the list.

■ Selecting a City

📍 DEST button ▶ **Address** ▶ **City**

The name of the city where you are currently located is displayed.



Non-detailed area mark: Try entering the street first and then select the city.

1. Enter the name of a different city, or select **List** for the current city.

▶ Select **List** to display a list of cities.

2. Select your destination city from the list.

▶ A list of matching hits is automatically displayed after you enter several letters, with the closest match at the top of the list.

▶ Next, you are prompted to enter a street name.

📍 **Selecting a Street** P. 61

▶▶ Selecting a City by Name

Vehicle position may not be displayed when:

- The automobile is traveling off-road.
- The vehicle position data cannot be updated.

Using Voice Command (English only)

Say 🗣️ "City" on the Find address by screen, and the following screen is displayed:



Say 🗣️ "Current City" to select your current location, or say the name of a different city.

📍 **Selecting a Street** P. 61

If your city is not listed, it may be part of a larger metropolitan area. Try entering the street first.

Selecting a Street

🗨️ DEST button ▶ **Address** ▶ **Street**



1. Enter the name of your destination street.

▶ Do not enter the street type (e.g., street, road, avenue) or direction (e.g., north, south, east, west).

▶ Select **List** to display a list of streets.

2. Select your destination street from the list.

▶ A list of matching hits is automatically displayed after you enter several letters, with the closest match at the top of the list.

▶ Selecting a Street

When entering the names of major freeways, you can use the following abbreviations. For interstates, use an "I" (e.g., I-10). For U.S. freeways, use "US" (e.g., US-18). For state freeways, use the two-character state designation (e.g., CA-101). For county roads, use the appropriate designation (e.g., G-2).

Using Voice Command (English only)

Say "Street" on the Find address by screen, and the following screen is displayed:



- Say the name of your destination street, and say the street number as a string of individual numbers.

- Set the route to your destination.

Calculating the Route P. 77



3. Enter the street number. Select **OK**.
 - ▶ Only valid street numbers can be entered.
4. Set the route to your destination.
 - ▶ **Calculating the Route** P. 77

▶▶ Selecting a Street

If you did not select a city first and there is more than one city with the specified street, a list of cities is displayed.



Select the desired city from the list.

Address Book

 DEST button ▶ **Address Book**

Select an address stored in your address book to use as the destination.

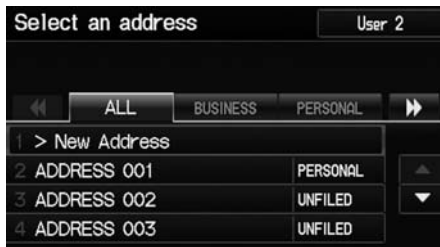



1. Select your user name.

2. Select your destination from the list.

3. Set the route to your destination.

 **Calculating the Route** P. 77

▶ Select  or  to display only the entries in a category: **ALL**, **BUSINESS**, **PERSONAL**, or other categories you have created.

 **Selecting an Address Book Category** P. 34

Address Book

If you have PIN-protected your address book, enter your PIN when prompted. Select **OK**. PINs are optional.

 **PIN Numbers** P. 37

You can select **New Address** on the Select an address screen to add an entry to the address book.

 **Adding an Address Book Entry** P. 32

To switch the list between User 1 or User 2, select the user name on the top right of the screen.

Previous Destinations

📍 DEST button ▶ **Previous Destinations**

Select an address from a list of your 50 most recent destinations to use as the destination. The list is displayed with the most recent destination at the top.



1. Select a destination from the list.

2. Set the route to your destination.

➤ **Calculating the Route** P. 77

▶▶ Previous Destinations

Your home addresses and addresses stored in your address book are not added to the list of previous destinations.

You can delete unwanted previous destinations from the list.

➤ **Previous Destinations** P. 39

Place Name

 DEST button ▶ **Place Name**

Enter the name of a place (e.g., business, hotel, restaurant) stored in the map database to use as the destination.



1. Enter a place name.
2. Select **List** to display a list of matching hits.
3. Select a place name from the list.
 - ▶ If the place name is in multiple categories, the categories are displayed when you select it.
 - **Place Name in Multiple Categories** P. 66
4. Set the route to your destination.
 - **Calculating the Route** P. 77

Place Name

This option is convenient if you know the exact name of a place.

Select **More** to enter symbols and accented letters, select **Space** to enter a space character, or select **Delete** to remove the last character.

Once a name is entered and selected, select **SORT BY Name** or **SORT BY Distance**. Matching letters are in yellow.

Place Name in Multiple Categories

If the place name is in multiple categories in the map database, the following screen is displayed.



1. Select a place name.

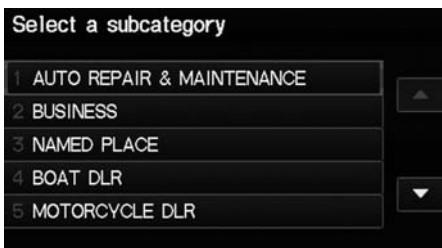

2. Select a subcategory.

3. Set the route to your destination.

➡ **Calculating the Route** P. 77

Place Name in Multiple Categories

Select **SORT BY Name** or **SORT BY Distance**.
Matching letters are in yellow.

Place Category

 DEST button ▶ **Place Category**



Select the category of a place (e.g., Banking, Lodging, Restaurant) stored in the map database to search for the destination.

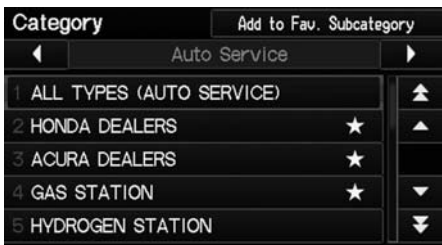

1. Select a category.



2. Select a subcategory.

▶ Select  or  to change the main category.

▶ **List of Categories** P. 197

Place Category

This option is convenient if you do not know the exact name of a place or if you want to narrow down the number of matches returned for places with a common name.

You can store up to 30 favorite subcategories. Select **Fav. Subcategory** to access your favorites.

▶ **Favorite Subcategories** P. 69

Advanced helps you to search the subcategory. When you enter a keyword and select **List**, the list of appropriate subcategories is displayed.



3. Select an item.

The following items are available:

- **Place Name:** Searches for a place in the subcategory by name. Enter a city name when prompted.
- **Sort by Distance to Travel:** Displays all the places in the subcategory sorted by distance from your current location. The closest place is displayed at the top.
- **City Vicinity:** Searches for a place in the subcategory within a 20-mile radius of a specific city. Enter a city name and then a place name when prompted. Only the first approximately 1000 matching places/landmarks are displayed.
- **Search by Keyword:** Searches for a place by keyword when you do not know the exact category. Select **Sort by Distance to Travel** for locations near your current location, or select **City Vicinity** for locations in a specific city. Enter a keyword when prompted. Select **List** to view a list of possible locations if one is not found automatically.

» Place Category

Search by Keyword

You can select **More** to increase the scope of the search. The number of locations increases to 100, 200, and up to approximately 1000. When the number of locations is 100 or less, you can increase the scope to 500 miles, 1000 miles, or all of U.S.





4. Select a place name from the list.

5. Set the route to your destination.

➤ **Calculating the Route** P. 77

➤ Place Category

The straight line distance (as the crow flies, not driving distance) and direction to the destination are shown for the highlighted place.

Favorite Subcategories

📍 DEST button ▶ **Place Category** ▶ **Fav. Subcategory**

Store up to 30 favorite subcategories.

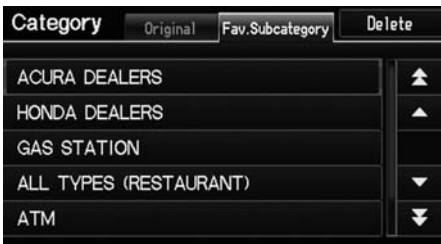

■ To store a subcategory in favorites:

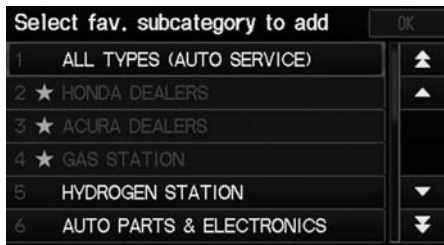
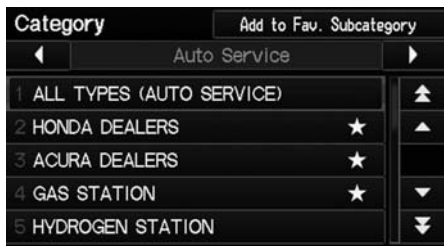

1. Select a category on the Category screen.
2. Select Add to Fav. Subcategory.
3. Select the favorite subcategories to add. Select OK.

» Favorite Subcategories

Stored categories

A subcategory stored in Fav. Subcategory has a star at the end of the line.

■ To delete a subcategory from favorites:



1. Select **Delete** on the Favorite Subcategory screen.

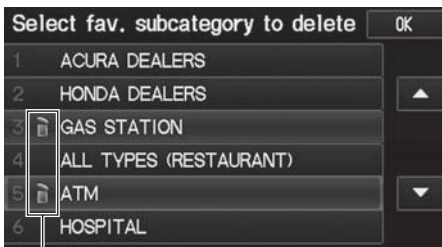

Trash icon

2. Select the subcategories to delete.

- ▶ Repeat the procedure as necessary.
- ▶ Items to be deleted are indicated with a trash icon.

3. Select **OK**.

» Favorite Subcategories

Deleting categories

You can also delete a favorite subcategory on any Subcategory screen. Select ▲ or ▼ to select a favorite subcategory (which has a star at the end of line) and select **Delete Fav. Subcategory**.

Place Phone Number

🔑 DEST button ▶ **DEST Menu 2** ▶ **Place Phone Number**

Select a destination by phone number. Only phone numbers in the database are recognized.

Enter phone number		
┌		
1	2 ABC	3 DEF
4 GHI	5 JKL	6 MNO
7 PQRS	8 TUV	9 WXYZ
	0	
Delete		OK

1. Enter the area code and phone number. Select **OK**.
2. Set the route to your destination.
 - ▶ **Calculating the Route** P. 77

▶▶ Place Phone Number

All 10 digits must be entered.

Phone numbers of private residences entered in your address book are not stored in the database and thus cannot be used to search for a destination.

A list is displayed if there are multiple locations in the database with the same phone number. Select a place from the list.

Coordinate

📍 DEST button ▶ **DEST Menu 2** ▶ **Coordinate**

Specify a location using latitude and longitude map coordinates.

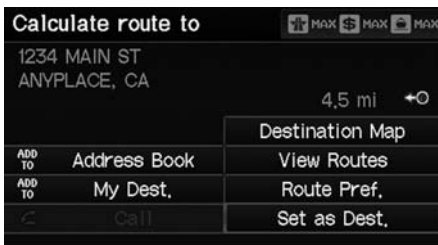

1. Enter the latitude. Select **OK**.
2. Enter the longitude. Select **OK**.
3. Scroll the map to position the cursor over your desired destination, adjusting the map scale as necessary. Press the **ENTER** button.
 - ▶ If the address is not the desired location, scroll to another location and try again.
4. Press the **ENTER** button again to display the route calculation menu.
 - **Calculating the Route** P. 77
5. Select **Set as Dest.**

Coordinate

Latitude and longitude must be entered up to the seconds' value.

A yellow box (shown at scales above 1/4 mile) denotes the area that can be viewed when you press the **ENTER** button on the current map.

Information icons are displayed at scales from 1 mile to 1/4 mile. Place/landmark icons are displayed at 1/8 mile or less. Roads are displayed at 1/4 mile or less.

If you select multiple icons within the cursor radius, you are prompted to select one of the items from a list.

Intersection

📍 DEST button ▶ DEST Menu 2 ▶ Intersection

Select the intersection of two streets as the destination. The state or province for your current location is displayed at the top of the screen (e.g., California).



1. Select the intersection search method.
2. Set the route to your destination.
➤ **Calculating the Route** P. 77

The following items are available:

- **City:** Selects the city where the intersection is located. You are prompted to enter the name of the two intersecting streets.
➤ **Selecting a City** P. 60
- **Street:** Selects the two intersecting streets. The city or cities that the streets are located in are displayed.
➤ **Selecting a Street** P. 61
- **Change State:** Selects the state or province.
➤ **Selecting the State or Province** P. 59

➤ Intersection

It is usually easier to select **Street** to find the streets first. The city or cities that the streets are in will be displayed. If you select **City** and your city is not listed, it may be part of a larger metropolitan area. Try entering the street first.

If the intersection is outside the state you are currently in, select **Change State**.

➤ **Selecting the State or Province** P. 59

If there is more than one intersection, you are prompted to select the intersection. If the two streets that you have selected do not intersect, no intersection is entered.

Map Input

🗺️ DEST button ▶ **DEST Menu 2** ▶ **Map Input**

Use the joystick to manually select an icon or a location on the map screen as the destination.

You are prompted to define the map area to display.



1. Select an item.

The following items are available:

- **Current Position:** Your current location is centered on the map.
- **City:** You are prompted to select the city.
📄 **Selecting a City** P. 60
- **State:** You are prompted to select the state.
📄 **Selecting the State or Province** P. 59

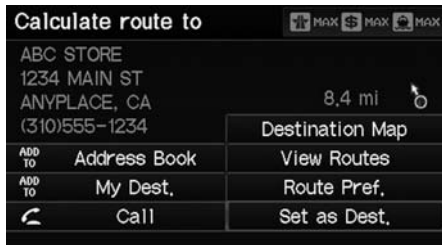
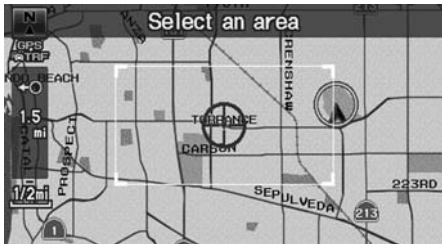

2. Scroll the map to position the cursor over your desired destination, adjusting the map scale as necessary. Press the ENTER button.
 - ▶ If the address is not the desired location, scroll the map to another location and try again.
3. Press the ENTER button again to display the route calculation menu.
 - ▶ **Calculating the Route** P. 77
4. Select Set as Dest.

▶▶ Map Input

A yellow box (shown at scales above 1/4 mile) denotes the area that can be viewed when you press the ENTER button on the current map.

Information icons are displayed at scales from 1 mile to 1/4 mile. Place/landmark icons are displayed at 1/8 mile or less. Roads are displayed at 1/4 mile or less.

If you select multiple icons within the cursor radius, you are prompted to select one of the items from a list.

▶ **Selecting a Destination on the Map** P. 109

This section describes how to calculate your route.

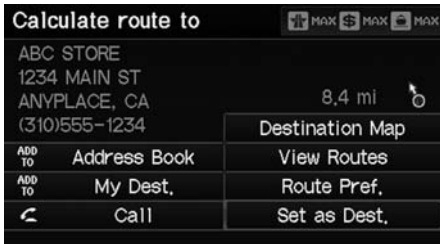

The following items are available:

- **Route Pref.:** Changes the route preferences (calculating method).
➤ **Changing the Route Preference** P. 78
- **View Routes:** Displays three different routes.
➤ **Viewing the Routes** P. 78
- **Destination Map:** Displays a map of the destination.
➤ **Calculating the Route on the Destination Map** P. 79



1. Select **Set as Dest.**

- ▶ The system calculates and displays the route line on the map screen.
➤ **Route Line** P. 82

2. Follow the route guidance to your destination.

- **Driving to Your Destination** P. 80
- ▶ The system provides you with pop-up messages if your route passes through unverified areas, avoid areas, or areas with traffic restrictions.

Calculating the Route

The current route preferences are displayed as icons on the top right of the Calculate Route screen. The straight line distance (as the crow flies, not driving distance) and direction to the destination are shown.

You cannot use voice commands while the system is calculating the route.

Add to Address Book

You can add the destination address to the address book.

➤ **Adding an Address Book Entry** P. 32

Add to My Dest.

You can add the address to the destination list.

➤ **Editing My Destination** P. 107

Call

You can place a telephone call to the destination phone number.

➤ **Bluetooth® HandsFreeLink®** P. 140

Changing the Route Preference

Change the route preference by selecting minimum or maximum driving methods.



1. Select MIN or MAX for each item.
2. Select OK.

Viewing the Routes

View three different routes to your destination.



1. Select a route on the list.
 - The travel distance and estimated travel time is displayed for each route.
 - The system calculates and displays the route line on the map screen.
2. Select OK.

➔ **Route Line** P. 82

►► Changing the Route Preference

The calculated route may not be the route you would choose. For safety reasons, the system generally applies the following rules to your route:

- Shortcuts through residential areas are avoided.
- Right turns are favored over left turns or U-turns.
- Time-restricted turns (turns prohibited at certain times of the day) are not used.

►► Viewing the Routes

It is not unusual for some calculated route options to be identical.

Calculating the Route on the Destination Map

Calculate the route from the map of the destination address.



Select **Calculate the Route**.

▶ The system calculates and displays the route line on the map screen.

➤ **Route Line** P. 82

▶▶ Calculating the Route on the Destination Map

Ⓜ "Display Destination Map" (when en route)

This section describes how to follow the route guidance to your destination, receive traffic information and choose the icons displayed on the map screen.

Viewing the Route

Map Screen

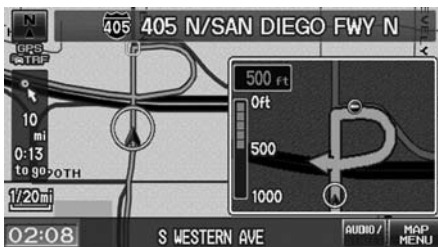

After calculating the route to your destination, the route is displayed on the map screen.

➤ **Map Screen Legend** P. 7

As you drive, the system tracks your position on the map in real time and provides guidance as you approach each guidance point on the route.

➤ Viewing the Route

🗨️ *"Display Map"*

You can change the map scale using voice control commands (e.g., say 🗨️ *"Display 2 mile scale"*).

➤ **Map Scale Commands** P. 189

You can also change the map scale by using the ZOOM button.

You can control the icons displayed on the map screen using voice control commands (e.g., say 🗨️ *"Display post office"*).

➤ **Map Display Commands** P. 188

You can obtain information about the route using voice control commands (e.g., say 🗨️ *"How long to the destination?"*).

➤ **Route Commands** P. 190

You can display the next guidance point on the map screen by saying 🗨️ *"Display Map Guide"* (when en route).

If you scroll the map while en route, the time and distance to destination indicators are replaced with an indicator showing distance from the current vehicle position.

The map screen can be viewed in single-screen or split-screen mode.

➤ **Guidance Mode** P. 90

Guidance Screen

The guidance screen offers an alternative way to view your route.



- ▶ In single-screen mode, press the MAP/GUIDE button to switch between the map and guidance screens.
- ▶ In split-screen mode, press the MAP/GUIDE button to switch between the next guidance direction and a list of guidance directions.

» Guidance Screen

A visual guide helps you check the guidance screen.

▶ **Guidance Screen** P. 8

Route Line

When driving on verified streets, the route line is light blue. The route line display changes when driving on unverified streets:



▶ If **Unverified Area Routing** is **Off**, the route line uses verified streets only (when possible). A dotted “vector line” pointing directly towards your destination is also displayed.



▶ If **Unverified Area Routing** is **On**, the route line changes to a dashed blue-pink line to indicate that the route line uses unverified streets.

Route Line

You can set **Unverified Area Routing** to **Off** to follow your own route to the destination. If **Unverified Area Routing** is **On**, be aware that unverified streets may not be displayed accurately.

▶ **Unverified Area Routing** P. 42

You can always view the entire route by simply saying  “Display entire route.”

The route line may also consist of red or orange segments when traffic information is displayed.

▶ **Map Screen Legend** P. 7

▶ **FM Traffic** P. 99

Deviating From the Planned Route

If you leave the calculated route, the system automatically recalculates a route to the desired destination based on your current location and direction.

➤ **Rerouting** P. 41



Driving Off-road

If you leave all mapped (digitized) roads, the system automatically starts displaying a series of dots (breadcrumbs) to track the path you are taking. If needed, you can follow the dots back to the mapped road you originally left.

➤ **Off-road Tracking** P. 51

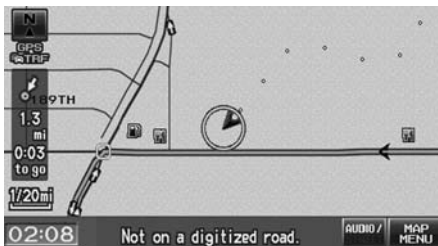

Deviating From the Planned Route

If **Rerouting** is set to **Manual** and you go off route, the system waits for you to manually initiate recalculation. Select **Recalc.**

➤ **Rerouting** P. 41

Driving Off-road

A message "Not on a digitized road." may appear when you drive half a mile away from a mapped road.

Breadcrumbs may occasionally be displayed in urban areas, such as large parking lots in shopping malls, in new subdivisions where the roads are not yet in the database, or in areas where a GPS signal is unavailable, such as in a parking garage.

Off-road tracking breadcrumbs are limited to approximately 150 miles. Breadcrumbs at the beginning of the trail are deleted if you exceed that distance.

Breadcrumbs are displayed only at 1/20, 1/8, 1/4, and 1/2 mile map scales.

Listening to Voice Guidance

MAP MENU (on map) ▶ **Voice**

As you approach each guidance point, a pop-up window is displayed on the map screen with instructions for you to follow. Voice guidance for each guidance point is also provided.

Typically, you hear three prompts:

- 1/2 mile from the guidance point (2 miles on freeway)
- 1/4 mile from the guidance point (1.2 miles on freeway)
- Just before the guidance point

To replay voice guidance, select **Voice** on the map menu.

If you select **Voice** on the map menu between guidance points, voice guidance for the next guidance point is provided.

▶▶ Listening to Voice Guidance

"Voice" (on the map screen)

You can turn voice guidance off if you prefer.

 **Display and Volume Settings** P. 22

When driving in unverified areas, the phrase "if possible" is inserted before each voice guidance prompt.

Voice on the map menu may be grayed out if the vehicle is approaching or is in an unverified area with **Unverified Area Routing** set to **Off**.

The timing of voice guidance varies depending on the type of road you are on and the distance to the next guidance point.

Displaying the Map Menu

Use the Map Menu to control the icons displayed on the screen and traffic information. You can also use the Map Menu to find locations or to cancel the route.



1. On the map screen, select **MAP MENU** (if displayed).

▶ The Map Menu is displayed on the map screen.

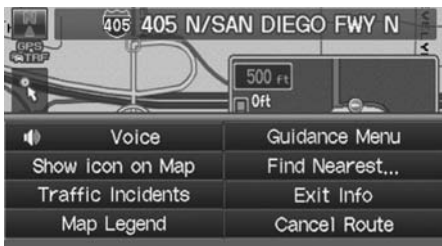

2. Select an item.

The following items are available:

- **Cancel Route:** Cancels your current route.
➤ **Canceling the Route** P. 102
- **Show icon on Map:** Selects the icons to display on the map.
➤ **Showing Icons on the Map** P. 92
- **Traffic Incidents:** Displays a list of the traffic incidents around your current location or on your current route.
➤ **FM Traffic** P. 99

Map Menu

If you scroll the map while en route, press the **MAP/GUIDE** (or **CANCEL**) button to return to the current position map screen, then select **MAP MENU**.

Traffic Incidents

You must be in or near a traffic-enabled city to receive coverage for that area. FM Traffic is available in the lower 48 states and Hawaii.

The incident icons are displayed on 5 mile (8 km) or less map scales.

➤ **Map Scale and Functions** P. 95

- **Map Legend:** Displays an overview of the map features.
 ➤ **Map Legend** P. 94
- **Guidance Menu:** Allows you to set or confirm the guidance points and freeway exits for your route.
 ➤ **Guidance Menu** P. 87
- **Find Nearest...:** Allows you to find the nearest place/landmark (e.g., nearest gas station) by specifying a category. You can then add the location to the list of destinations, set as a waypoint, or set as your destination.
 ➤ **Changing Your Destination** P. 108
- **Exit Info:** Displays a list of the freeway exits.
 ➤ **Freeway Exit Information** P. 89

Guidance Menu



MAP MENU (on map) ▶ **Guidance Menu**

Display the guidance points and freeway exits for your route, and set the display mode for the map and guidance screens.



Select an item.

The following items are available:

- **Directions:** Displays a list of the guidance points.
 **Directions** P. 88
- **Guidance Mode:** Selects the guidance display mode.
 **Guidance Mode** P. 90

■ Directions

📍 **MAP MENU** (on map) ► **Guidance Menu** ► **Directions**

Display a list of the guidance points on your route for your confirmation.



Select ▲ or ▼ to scroll through the list.

► Press the MAP/GUIDE button to return to the map screen.

» Directions

Guidance points with exit information are indicated by a 📍 (freeway exit information) icon. Select **Exit Information** to display the exit information.

➡ **Freeway Exit Information** P. 89

The route guidance information is automatically deleted when you reach your destination.

Freeway Exit Information

MAP MENU (on map) ▶ **Exit Info**

Display a list of the freeway exits for the route. You can view freeway exit information (whether the exit is near gas stations, restaurants, ATMs, etc.) and add new destinations or waypoints to the calculated route.



1. Select an exit from the list.

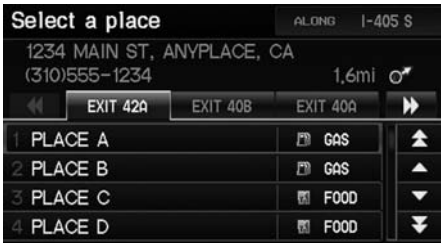

2. Select a list item.

- ▶ Select or to display information for different exits.
- ▶ The location is displayed on the Calculate Route screen.
 - **Calculating the Route** P. 77

Freeway Exit Information

"Display Freeway Exit Information"

You can scroll the map and select a (freeway exit information) icon on the map screen to display the freeway exit information. The icon is only displayed if there is exit information available.

Icons are displayed only at 1/4, 1/2, or 1 mile scale.

➤ **Showing Icons on the Map** P. 92

The route guidance information is automatically deleted when you reach your destination.

■ Guidance Mode

📍 **MAP MENU** (on map) ▶ **Guidance Menu** ▶ **Guidance Mode**

Select the display mode during route guidance: single-screen mode (default) or split-screen mode.

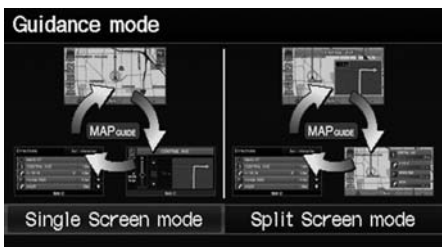

Select an option.

The following options are available:

- **Single Screen:** Displays the map and guidance screens on separate screens.

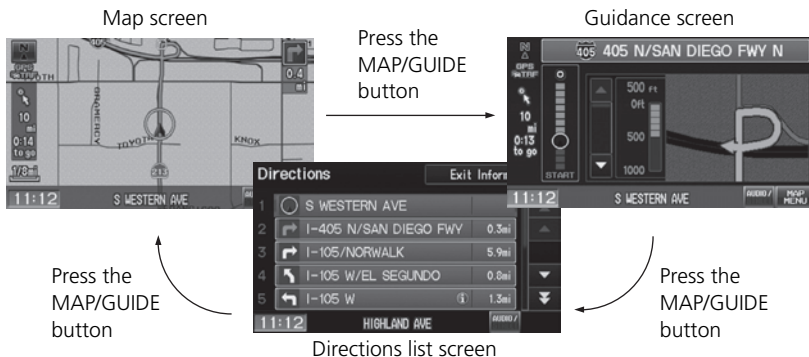

▶▶ Guidance Mode

The guidance mode can also be selected from the System Setup menu.

▶ **Routing & Guidance** P. 40

- **Split Screen:** Displays the map and guidance information simultaneously on the map screen.

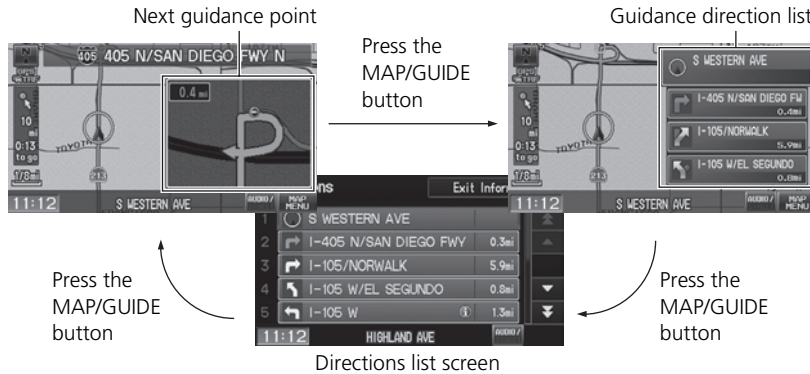

▶ Guidance Mode

Next guidance point

The next guidance point (the pop-up window) is displayed on the map screen as you approach a guidance point in the single-screen mode.

Showing Icons on the Map

MAP MENU (on map) ► Show icon on Map

The icon bar along the bottom of the screen allows you to select the icons that are displayed on the map.



Select an icon in the icon bar.

- Selecting toggles the icon display on or off.
- Repeat the procedure as necessary.

The following options are available:

- **Icon check boxes:** Displays or hides traffic and landmark icons.
 - **Map Screen Legend** P. 7
 - **FM Traffic** P. 99
- **ALL OFF:** Hides all icons.
- **Icon Options:** Fine-tunes the icon display.
 - **Fine-tuning the Icons** P. 93

►► Showing Icons on the Map

You can display or hide the icons using voice commands on the map screen (e.g., say  "Display hospital").

► **Map Display Commands** P. 188

Fine-tuning the Icons

MAP MENU (on map) ▶ Show icon on Map ▶ Icon Options

Icons in some categories can be fine-tuned to display or hide.

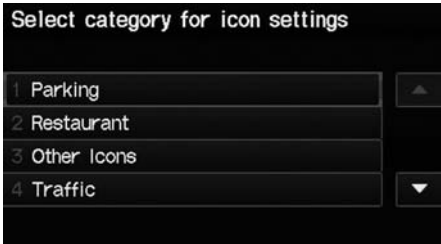

1. Select an icon category from the list (e.g., **Other Icons**).



2. Select the icons to display on the map.

▶ Selecting toggles the icon display on or off.

▶ Repeat the procedure as necessary.

3. Select **OK**.

⊗ Fine-tuning the Icons

To display the “Other Icons,” be sure to turn on **OTHER ICON** in the icon bar.

Map Legend

 **MAP MENU** (on map) ▶ **Map Legend**

See an overview of the map lines, areas, routes, traffic information, and navigation icons.



Select an item.

- ▶ The system displays the map legend.

» Map Legend

A visual guide helps you see the map legend.

 **Map Screen Legend** P. 7

 **FM Traffic** P. 99

Map Scale and Functions

The functions that are available from the map screen depend on the map scale.

Function	page	Map Scale (top: mile, bottom: metric)											
		1/20	1/8	1/4	1/2	1	2	5	15	50	150	350	1000
		80	200	400	800	1.6	3	8	24	80	240	560	1600
Icon display													
Landmark icon	7	✓	✓										
Exit info.	7			✓	✓	✓							
One-way traffic	7	✓											
Waypoint "flag"	8	✓	✓	✓	✓	✓	✓	✓	✓	✓	✓	✓	✓
Traffic incident	7	✓	✓	✓	✓	✓	✓	✓					
Map orientation													
Heading-up	97	✓	✓	✓	✓	✓							
North-up	97	✓	✓	✓	✓	✓	✓	✓	✓	✓	✓	✓	✓
Others													
Off-road tracking dots	83	✓	✓	✓	✓								
Unverified road	7	✓	✓	✓	✓	✓	✓						
Map features	7	✓	✓	✓	✓	✓	✓	✓	✓	✓	✓	✓	
Avoid areas	44	✓	✓	✓									
Traffic speed	7	✓	✓	✓	✓	✓	✓	✓					

Map Scale & Functions

You can change the map scale using voice commands on the map screen (e.g., say  "Display 2 mile scale").

 **Map Scale Commands** P. 189

You can change between miles or kilometers.

 **Basic Settings** P. 24

■ Map Icons and Functions

Display or hide all icons on the map screen, with the exception of Honda/Acura Dealer icons which are always shown.

■ Landmark icon

Type	Icon display control	Icon selectable	Icon searchable
Honda/Acura dealer	Always on	Yes	Yes
Hospital	Yes	Yes	Yes
School	Yes	Yes	Yes
ATM	Yes	Yes	Yes
Gas station	Yes	Yes	Yes
Restaurants	Yes	Yes	Yes
Post office	Yes	Yes	Yes
Grocery store	Yes	Yes	Yes
Hotel/Lodging	Yes	Yes	Yes
Police station	No icon	No	Yes
Shopping, Tourist attraction, Bank	No icon	No	Yes
Parking garage	Yes	Yes	Yes
Parking lot	Yes	Yes	Yes
Freeway exit info.	Yes	Yes	No

► Map Icons & Functions

You can display or hide the icons using voice commands on the map screen (e.g., say  "Display hospital").

► Map Display Commands P. 188

Some icons, like police stations, are not shown, but you can still locate the nearest one with the Find Nearest voice command (e.g., say  "Find nearest police station").

► Find Place Commands P. 189

Icon display control

Icons that can be displayed or hidden.

Icon selectable

Icons that can be selected as a destination using the joystick.

Icon searchable

Icons that can be searched using the  Find Nearest voice command.

■ Traffic icon

Type	Icon display control	Icon selectable	Icon searchable
Traffic speed	Yes	No	No
Traffic incident	Yes	Yes	No

■ Map Orientation

Select the map orientation icon to change the map orientation.

Map orientation icon



North-up: Displays the map with North always pointing up.

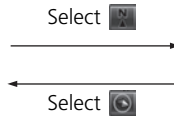

Map orientation icon



Heading-up: Displays the map so that the direction you are traveling is always pointing up.

⊗ Traffic Incident

When you use the joystick to position the cursor (round red circle) over a traffic incident icon, you can view a summary of the incident.

Press the ENTER button on the traffic incident icon to view a pop-up message describing the incident in detail.

⊗ Map Orientation

☰ "Display Heading-up" (from map screen), ☱ "Display North-up" (from map screen)

The red arrow in the symbol always points North. On scales greater than 1 mile, North-up mode is always used.

■ Current Location

Display and save your current location for future use as a destination. The address, latitude, longitude, and elevation of your current location are displayed.

■ To save your current location in the address book:



1. Select the vehicle icon on the map.
2. Select **Save**.
3. Edit the name, phone number, and category.
 - ▣ **Address Book** P. 31
4. Select **OK**.

▣ Current Location

▣ *"Display Current Location"* (on map screen)

You can also save the current location by saying
 ▣ *"Register the Current Location"*.

If you have PIN-protected your address book, enter your PIN when prompted. Select **OK**. PINs are optional.

▣ PIN Numbers P. 37

The elevation is not displayed if the system is receiving insufficient GPS information. When elevation is displayed, it may differ with roadside elevation signs by ± 100 feet or more.

Saving your current location does not change or cancel your current route.

FM Traffic

MAP MENU (on map) ▶ Traffic Incidents

View and avoid specific incidents and/or congestion on your route:

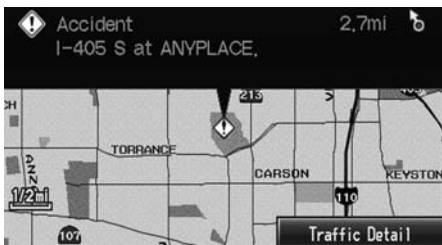

1. Select an incident from the list.
 - ▶ The system displays the map screen and the incident location.

2. Select Traffic Detail.

FM Traffic

You must be in or near a traffic-enabled city to receive coverage for that area. FM Traffic is available in the lower 48 states and Hawaii.

Automatic traffic rerouting may not provide a detour route depending on circumstances.

"Display traffic list"

You can also display traffic incidents from the INFO screen.

You can display traffic incidents and related information on the map screen using voice commands.

Map Display Commands P. 188



3. Select Avoid.

- Repeat step 1 to 3 as necessary.

4. Select Reroute.

- The system recalculates a detour route that avoids the traffic incidents.

» FM Traffic

You can choose to avoid up to 10 traffic incidents. It is not always possible for the system to calculate a route that avoids all traffic incidents or specific traffic incidents you select.

The “On Route” tab on the Traffic List screen is only available during route guidance.

You cannot select an incident to avoid from the “All” tab.

You can also detour around a traffic incident manually if you encounter an unexpected obstacle.

» **Taking a Detour** P. 102







 DEST button (when en route)

This section describes how to alter your route, add an interim “waypoint” (pit stop), choose a different destination, cancel your current destination, and continue your trip after stopping.





Select an item.

The following items are available:

- **Cancel Route:** Cancels the route guidance.
 **Canceling the Route** P. 102
- **Detour:** Calculates a detour route.
 **Taking a Detour** P. 102
- **Avoid Streets:** Avoids streets along your route.
 **Avoiding Streets** P. 102
- **Change Route Pref.:** Changes the route preferences (calculating method).
 **Changing the Route Preference** P. 78
- **Waypoint:** Sets waypoints along your route.
 **Adding Waypoints from the Route Menu** P. 104
- **My Destination:** Shows a list of waypoints. You can delete waypoints or edit the order of them.
 **Editing My Destination** P. 107

Changing Your Route

 “Display Menu”,  “Display Navigation” (when en route)

If you press the DEST button when not en route, the Destination Menu screen is displayed.

 **Entering a Destination** P. 56

Canceling the Route

📍 DEST button (when en route) ▶ **Cancel Route**

Cancel the route guidance and remove the destination and all waypoints from the destination list. The system then returns to the map screen.

Taking a Detour

📍 DEST button (when en route) ▶ **Detour**

Calculate a detour route manually. The system attempts to calculate a new route by avoiding the next 5 miles (while on a freeway) or 1 mile (while on a surface street).

Avoiding Streets

📍 DEST button (when en route) ▶ **Avoid Streets**

Select a street or streets along your route to avoid.



1. Select the street you want to avoid.

- ▶ Repeat the procedure to avoid other streets.
- ▶ Streets to be avoided are indicated with a trash icon.

» Canceling the Route

You can also cancel your route from the Map Menu.

▶ **Map Menu** P. 85

» Taking a Detour

The detour option is convenient if you encounter an unexpected obstacle such as a road closure or extremely heavy traffic congestion.

» Avoiding Streets

Avoiding certain streets is convenient if you know of road construction, road closures, or excessive traffic along the route.

You cannot choose specific streets you want to use, only those to avoid. However, you can select intersections or waypoints (places/landmarks) that the system will use in your route.

▶ **Adding Waypoints** P. 103

You can store up to 10 streets to avoid. You cannot avoid your current street or the streets of your waypoint(s) or destination (system beeps if selected).



2. Select OK.

- ▶ The system calculates a new route.

Adding Waypoints

Add up to four waypoints (pit stops) along the route to your destination.



Waypoints are displayed on the map screen as small, numbered red flags. The route follows the waypoints in the order they are listed in the destination list.

▶ Adding Waypoints

Waypoints allow you to stop for gas or food, for example, and then continue on to your destination.

Press the MAP/GUIDE button to return to the map screen without adding a waypoint at any time.

The search corridor used for adding waypoints can be adjusted.

▶ Edit Waypoint Search Area P. 46

You can delete waypoints or edit the order of waypoints in the destination list.

▶ Editing My Destination P. 107

■ Adding Waypoints from the Route Menu

📍 DEST button (when en route) ► **Waypoint**

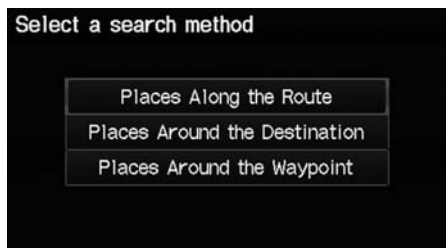

1. Select a search method to add a waypoint.

The following items are available:

- **Places Along the Route:** Searches within a “corridor” on either side of the route.
- **Places Around the Destination:** Searches in a spiral pattern around the destination.
- **Places Around the Waypoint:** Searches in a spiral pattern around the location you select.



2. Select the location when you select Places Around the Waypoint.

►► Adding Waypoints

Search method



The search corridor used for adding waypoints can be adjusted.

🔧 **Edit Waypoint Search Area** P. 46



3. Select a waypoint category (e.g., **Auto Service**).
4. Select a waypoint subcategory (e.g., **GAS STATION**).
5. Select a place.
 - The waypoint is added to the destination list.
 - The route is automatically recalculated and displayed on the map screen.

■ Adding Waypoints from the Calculate Route Screen

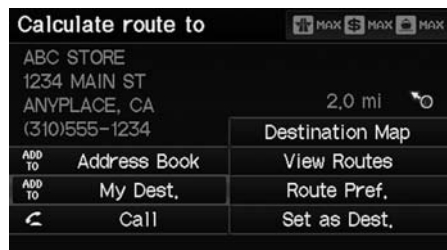

1. Select a new address or location.
2. Select ADD TO My Dest.



3. Select ▲ or ▼ to select a location in the destination list. Select OK.



4. Select OK.
 - The route is automatically recalculated and displayed on the map screen.

Editing My Destination

 DEST button (when en route) ▶ **My Destination**

Delete or edit the order of waypoints.

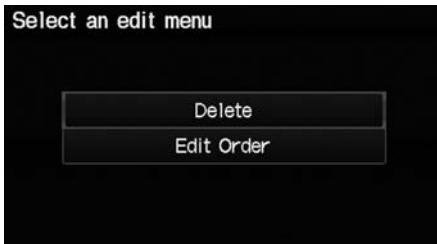

1. Select **Edit**.



▶ Select **Map** to display the destination and waypoints on the map screen.

2. Select an item.

3. Select **OK**.

▶ The route is automatically recalculated and displayed on the map screen.

The following items are available:

- **Delete**: Select a list item to delete.
- **Edit Order**: Select a list item to move, select  or  to select a new location.

There are several methods you can use to change the route destination.

Find Nearest Place

 **MAP MENU** (on map) ► **Find Nearest...**

Search for the nearest place/landmark on the map screen and set it as your destination.

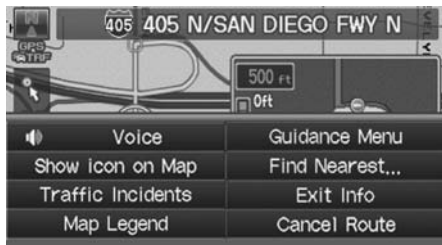

1. Select **Find Nearest...**
2. Select a category type.
3. Select a subcategory.
4. Select a place.
5. Select **Set as Dest.**
6. Select an item to set the place as a destination or add to the destination list.
 - The system calculates the route.
 - **Calculating the Route** P. 77

► Find Nearest Place

 *"Find Nearest..."* (on map screen)

The Find Nearest voice command is the fastest method of specifying a place/landmark as your destination. Many kinds of places can be found.

➤ **Find Place Commands** P. 189

Selecting a Destination on the Map

Select a new destination when en route by selecting a location on the map.



1. Scroll the map to position the cursor over your desired destination, adjusting the map scale as necessary. Press the ENTER button.
 - If the address displayed is not the desired location, press the CANCEL button and repeat the procedure.
2. Press the ENTER button again.
3. Select a place.
4. Select **Set as Dest.**
 - **Calculating the Route** P. 77

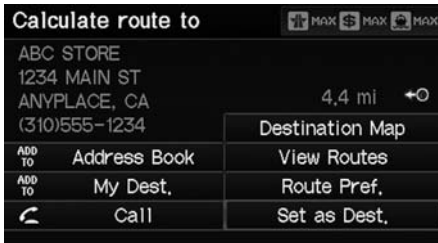

► Selecting a Destination on the Map

If there is more than one icon or street under the map cursor, you are prompted to select the item from a list.



- Select an item.
- If you select **Map Icon**, select a place.

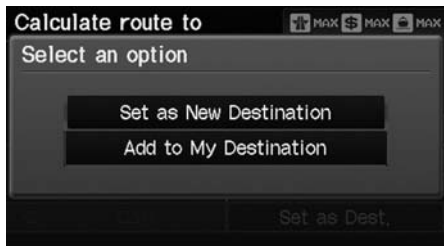

5. Select an option.

- The route is automatically recalculated and displayed on the map screen.

The following options are available:

- **Set as New Destination:** Sets the location as your new destination.
- **Add to My Destination:** Sets the location as a new waypoint.

Entering a New Destination

📍 DEST button (when en route) ► **DEST Menu 1** or **DEST Menu 2**

Enter a new destination using the Destination Menu screen even when you are en route.



1. Select a method to enter a new destination.

➤ **Entering a Destination** P. 56

- After entering a new destination, the address is displayed on the Calculate Route screen.

2. Select **Set as Dest.**

► Entering a New Destination

📍 "Display Menu", 📍 "Display Navigation"

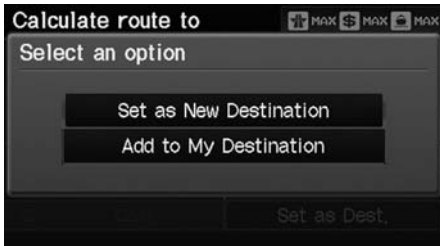

3. Select an option.

- The route is automatically recalculated and displayed on the map screen.

The following options are available:

- **Set as New Destination:** Sets the location as your new destination.
- **Add to My Destination:** Sets the location as a new waypoint.

Stop your vehicle en route (e.g., to rest, stop for gas, etc.), and then continue on your route.

If you did not complete your route, the Continue Trip screen is displayed when you restart your vehicle.

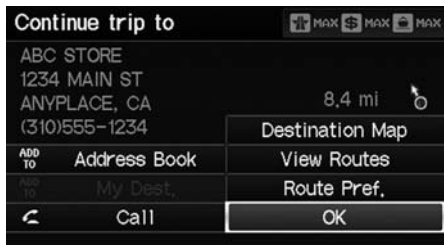

Select **OK**.

► You can continue on the same route.

- **Route Pref.:** Changes the route preferences (calculating method).
➤ **Changing the Route Preference** P. 78
- **View Routes:** Displays three different routes.
➤ **Viewing the Routes** P. 78
- **Destination Map:** Display a map of the destination.
➤ **Calculating the Route on the Destination Map** P. 79

» Resuming Your Trip

The Continue Trip screen has the same options as when you calculate a route.

➤ **Calculating the Route** P. 77

To cancel your destination, press the CANCEL button.

Add to Address Book

You can add the destination address to the address book.

➤ **Adding an Address Book Entry** P. 32

Call

You can place a phone call to the destination phone number.

➤ **Bluetooth® HandsFreeLink®** P. 140

Audio

This section describes how to operate the audio system. You can play music from a wide array of media sources, and control the audio system using the audio buttons, the touch screen, or voice control.

Audio System	114	Playing an iPod®	125	Adjusting the Sound	136
About Your Audio System	114	Selecting iPod® Mode	126	Audio Remote Controls	137
Auxiliary Input Jack	114	Audio Screen Control	127	Steering Wheel Controls	137
System Theft Protection	115	Searching for Music	128		
Playing FM/AM Radio	116	Playing a USB Flash Drive	129		
Selecting FM/AM Mode	116	Selecting USB Mode	130		
Audio Screen Control	117	Audio Screen Control	131		
Audio Menu	118	Playing Tracks in Folders	132		
Radio Data System (RDS)	119	Playing Bluetooth® Audio	133		
Playing a Disc	121	Selecting Bluetooth® Audio Mode	133		
Selecting Disc Mode	121	Switching to HFL Mode	134		
Audio Screen Control	122	Audio Screen Control	135		
Playing MP3/WMA/AAC Discs	123				
Recommended Discs	124				

About Your Audio System

The audio system features FM/AM radio. It can also play audio discs, WMA/MP3/AAC tracks, iPods®, USB flash drives, and Bluetooth® devices.

The audio system is operable from the buttons and switches on the panel, or the remote controls on the steering wheel.

➤ **Audio Remote Controls** P. 137

➤ **Audio System** P. 6

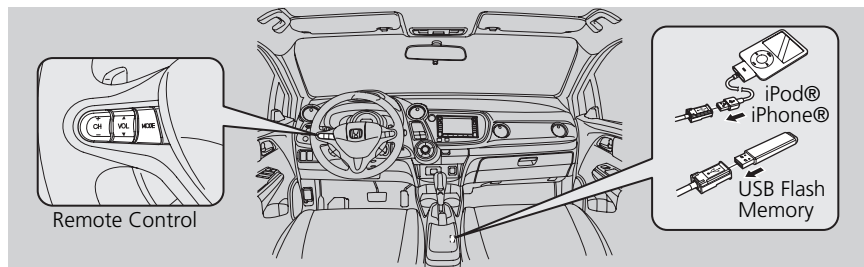

Auxiliary Input Jack

Use the jack in the console compartment to connect standard audio devices.

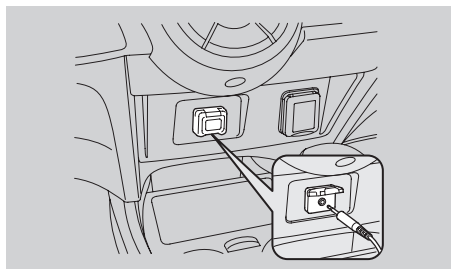

1. Open the AUX cover.
2. Connect a standard audio device to the input jack using a 1/8 inch/3.5 mm stereo miniplug.
 - ▶ The audio system automatically switches to the AUX mode.

➤ About Your Audio System

Video CDs, DVDs, and 3-inch/8-cm mini discs are not supported.

Do not leave the iPod® or USB flash drive in the vehicle. Direct sunlight and high temperatures may damage it.

iPod® and iPhone® are registered trademarks owned by Apple Inc.

You can operate the audio system by voice commands.

➤ **Audio Commands** P. 191

MP3 and AAC are standard audio compression formats. WMA is an audio compression format developed by Microsoft Corporation.



➤ Auxiliary Input Jack

To switch the mode, press any of the other audio mode buttons. You can return to the AUX mode by pressing the AUX button.

System Theft Protection

The system is disabled when it is disconnected from the power source, such as when the battery is disconnected or goes dead.

■ Reactivating the system

1. Turn the ignition switch to ON (II), and turn on the system.
 - ▶ If you turn the ignition switch to ACCESSORY (I), you will be requested to enter the security code. See step 2.
2. Enter the security code. If you do not enter the code correctly after 10 tries, leave the system for one hour before trying again, or visit a dealer to have the system reset.

⊠ System Theft Protection

Find the audio system's security code and serial number label in your Owner's Manual kit.

Do not store the label in your vehicle. If you lose the label, you must first retrieve the serial number, and then obtain the code from a dealer.

U.S. Only

You can register the security code at Honda Owners (owners.honda.com). To find information on how to retrieve the serial number and obtain the code, visit radio-navicode.honda.com.

⊠ **Entering the Security Code** P. 176

Selecting FM/AM Mode

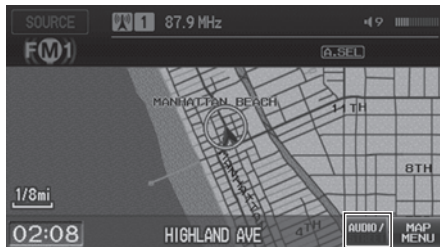

Preset keys

1. Press the FM/AM button.

- ▶ Press the FM/AM button again, if necessary, to select the frequency band (FM1, FM2, AM).
- ▶ The band and frequency are displayed.

2. Select **AUDIO/STREET** until **AUDIO** is highlighted in blue.

- ▶ The preset keys are displayed at the bottom of the screen.
- ▶ The audio information is displayed at the bottom of the screen.

3. Select the preset key.

- ▶ You can also select a station using the SEEK/SKIP button.

▶▶ Playing FM/AM Radio

 "Display audio screen"

You can control the radio using voice commands.

 **Radio Commands** P. 191

A visual guide helps you operate the audio system.

 **System Controls** P. 4

 **Basic Operation** P. 6

The ST indicator comes on the display for stereo FM broadcasts. Stereo reproduction in AM is not available.

The radio can receive the complete AM and FM bands:

AM band: 530 to 1710 kHz

FM band: 87.7 to 107.9 MHz

You can store six AM stations and 12 FM stations in the preset buttons. FM1 and FM2 let you store six stations each.

Audio Screen Control

 AUDIO button (in FM/AM mode)

Control the audio system through the navigation screen.

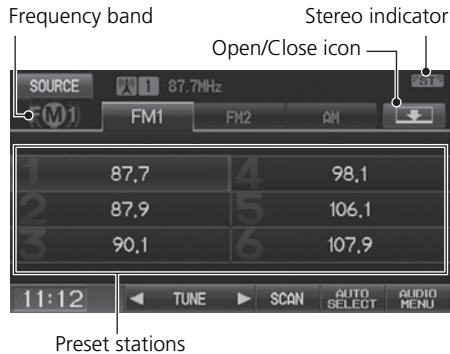

1. Select a frequency band (**AM**, **FM1**, or **FM2**).



2. Select a preset station.

▶ Touch and hold a preset key until a beep sounds to store the current station in the key.

Audio Screen Control

The A.SEL indicator comes on the display when **AUTO SELECT** is on. If you do not like the stations Auto Select has stored, you can change the frequencies stored in the preset buttons manually.

The following items are available:

- **TUNE**: Tunes the radio to the frequency you select. Select  or  to select a frequency.
- **SCAN**: Scans for stations with a strong signal in the current band and plays a 10-second sample. Select **Stop** to stop scanning and play the current selection.
- **AUTO SELECT**: Scans and automatically stores up to six AM stations and 12 FM stations with a strong signal in the preset buttons.
- **AUDIO MENU**: Sets the RDS options and sound preferences.
- **SOURCE**: Changes the source mode.
- **Open/Close icon**: Displays/hides the detailed information.

Audio Menu

🔍 AUDIO button (in FM/AM mode) ▶ **AUDIO MENU**

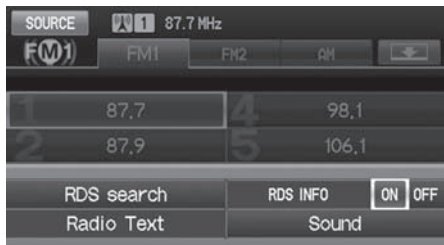

Select an item.

The following items are available:

- **RDS search**: Searches for programs by RDS category.
▶ **Searching for Programs by RDS Category** P. 119
- **Radio Text**: Displays the text information broadcast by the current RDS station.
▶ **Radio Text Display** P. 120
- **RDS INFO**: Sets whether to display the RDS Information on the screen.
▶ **RDS Info Display** P. 119
- **Sound**: Displays the sound preferences screen.
▶ **Adjusting the Sound** P. 136

Radio Data System (RDS)

Provides text data information related to your selected RDS-capable FM station.

RDS Info Display

When **RDS INFO** is set to ON, the name of the FM station is displayed. When set to OFF, the frequency of the station is displayed.

Searching for Programs by RDS Category

🔊 AUDIO button (in FM/AM mode) ▶ **AUDIO MENU** ▶ **RDS search**

Search for FM stations with a strong signal that broadcast the selected RDS category information.

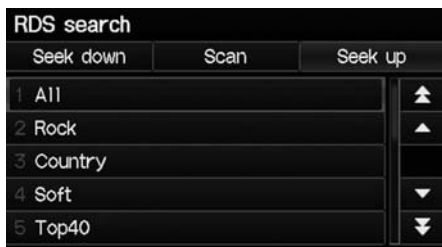

1. Select a search method (**Seek up**, **Seek down**, **Scan**).
2. Select a category.
 - ▶ Scanning for stations in that category begins. When an RDS station is found, it begins to play.
 - ▶ If there are no RDS-capable stations in the area, "NOTHING" briefly appears on the display.

■ Radio Text Display

🔑 AUDIO button (in FM/AM mode) ▶ **AUDIO MENU** ▶ **Radio Text**

Display the radio text information of the selected RDS station.

Radio text

The text is displayed
according to the
information from RDS.

▶▶ Radio Text Display

The Radio Text indicator comes on the display when the selected RDS station is broadcasting text data.

Selecting Disc Mode

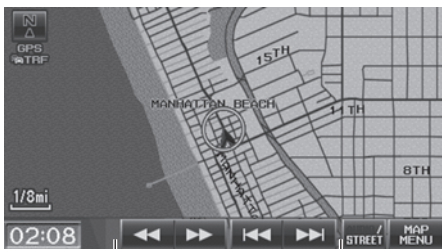
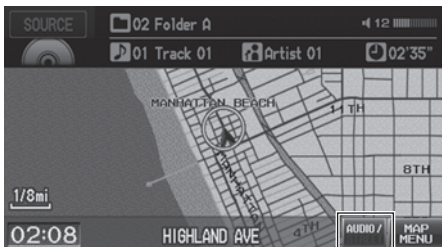

Audio control

1. Press the CD/AUX button.
2. Insert a disc into the disc slot.
 - ▶ The disc automatically begins playing.
3. Select **AUDIO/STREET** until **AUDIO** is highlighted in blue.
 - ▶ The audio information is displayed at the bottom of the screen.
4. Select **◀◀** or **▶▶** to select a track.
 - ▶ You can also select a track using the SEEK/SKIP button.
 - ▶ The track number and elapsed time are displayed on the display. Text information stored on MP3/WMA/AAC discs is also displayed.

▶ Playing a Disc

"Display audio screen"

You can control the disc using voice commands.

Disc Commands P. 192

A visual guide helps you operate the audio system.

System Controls P. 4

Basic Operation P. 6

In some cases, the name of the artist, album, or track may not appear correctly.

Do not use discs with adhesive labels. The label can cause the disc to jam in the unit.

WMA tracks protected by digital rights management (DRM) cannot be played. The audio system displays Unplayable File, then skips to the next track.

If there is a problem, you may see an error message on the display.

Error Messages P. 171

If you eject the disc but do not remove it from the slot, the system reloads the disc automatically after several seconds.

Audio Screen Control

 AUDIO button (in DISC mode)

Control the audio system through the navigation screen.

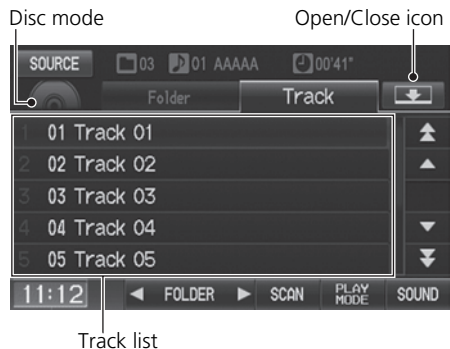

Select a track.









▶ Select the **Folder** tab to display the list of folders on MP3/WMA/AAC discs having a folder structure.

 **Playing MP3/WMA/AAC Discs**
P. 123

▶▶ Repeat and Random Play

To stop repeat- or random-play, select the current play mode button again.

The following items are available, depending on the type of disc:

- **FOLDER:** Select  or  to select a folder on MP3/WMA/AAC discs having a folder structure.
- **SCAN:**
 -  **Scan Track:** Scans all tracks on the disc (or in the selected folder) in the order they were recorded (stored) and plays a 10-second sample. Select **Stop** to stop scanning and play the current selection.
 -  **Scan Folder:** Scans the first track in each folder on the disc and plays a 10-second sample. Select **Stop** to stop scanning and play the current selection.
- **PLAY MODE:**
 -  **Random All:** Plays all tracks on the current disc in random order.
 -  **Random in Folder:** Plays all tracks in the current folder in random order.
 -  **Repeat 1 Track:** Repeats the current track.
 -  **Repeat 1 Folder:** Repeats all tracks in the current folder.

- **SOUND:** Displays the sound preferences screen.
 - ▶ **Adjusting the Sound** P. 136
- **SOURCE:** Changes the source mode.
- **Open/Close icon:** Displays/hides the detailed information.

Playing MP3/WMA/AAC Discs

 **AUDIO** button (in DISC mode) ▶ **Folder**

Change the folder on MP3/WMA/AAC discs that have tracks stored in a folder structure.

Touch to close the folder.

Folder list



Touch to open the folder.

1. Select a folder.
 - ▶ The system displays the track list.
2. Select a track.
 - ▶ The system begins playing the selected track.

▶▶ Playing MP3/WMA/AAC Discs

Folder List

- Any tracks not in a folder are automatically added to a "ROOT" folder, which is displayed at the top of the Folder List.
- If the root folder has additional folders in a lower layer, they are listed on the screen.

Back To Current Track: Displays the current track at the top of the list.

Recommended Discs

- Use only high-quality CD-R or CD-RW discs labeled for audio use.
- Use only CD-R or CD-RW discs on which the recordings are closed.
- Play only standard round-shaped discs.

The disc packages or jackets should have one of these symbols.



■ Discs with MP3, WMA, or AAC Tracks

- Some software files may not allow for audio play or text data display.
- Some versions of MP3, WMA, or AAC formats may be unsupported. If an unsupported track is found, the audio unit displays Unsupported, and then skips to the next track.

▶▶ Recommended Discs

A Dual-disc cannot play on this audio unit. If recorded under certain conditions, a CD-R or CD-RW may not play either.

Connecting an iPod®

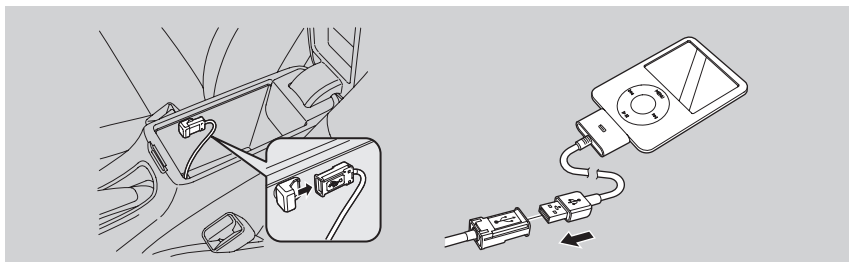

1. Unclip the USB connector in the center console and loosen the adapter cable.
2. Install the iPod® dock connector to the USB connector.

Model Compatibility

Model
iPod (5th generation)
iPod classic 80GB/160GB
iPod classic 120GB
iPod classic 160GB (launch in 2009)
iPod nano
iPod touch
iPhone 3GS
iPhone 4

Connecting an iPod®

- Do not use an extension cable with the USB adapter cable.
- Do not connect the iPod® using a hub.
- Do not use a device such as a card reader or hard disk drive, as the device or your tracks may be damaged.
- We recommend backing up your data before using the device in your vehicle.
- Displayed messages may vary depending on the device model and software version.

Your audio system may not work with all software versions of these devices.

If the audio system does not recognize the iPod®, try reconnecting it a few times or reboot the device.

Selecting iPod® Mode

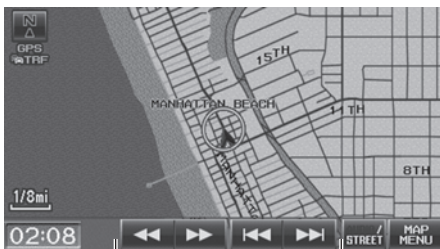
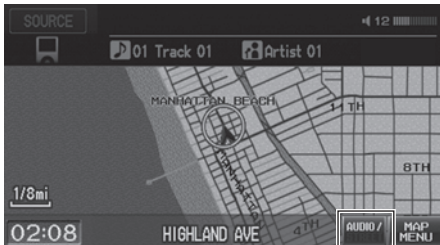

Audio control

1. Connect the iPod® to the USB adapter cable in the center console.
2. Press the CD/AUX button until you get to iPod® mode.
3. Select **AUDIO/STREET** until **AUDIO** is highlighted in blue.
 - ▶ The audio information is displayed at the bottom of the screen.
4. Select **◀◀** or **▶▶** to select a track.
 - ▶ You can also select a track using the SEEK/SKIP button.
 - ▶ The current track number is displayed.

▶▶ Playing an iPod®

"Display audio screen"

You can control the iPod® using voice commands.

iPod® Commands P. 192

A visual guide helps you operate the audio system.

System Controls P. 4

Basic Operation P. 6

In some cases, the name of the artist, album, or track may not appear correctly.

Available operating functions vary on models or versions. Some functions may not be available on the vehicle's audio system.

If there is a problem, you may see an error message on the display.

Error Messages P. 171

Audio Screen Control

 AUDIO button (in iPod® mode)

Control the audio screen through the navigation system.

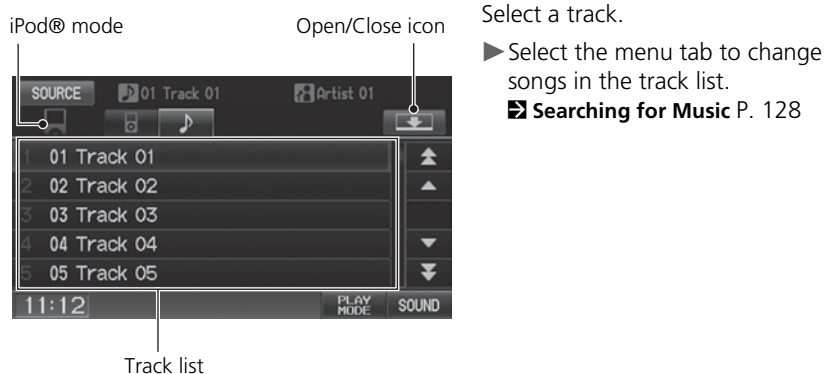

Select a track.

▶ Select the menu tab to change songs in the track list.

▶ **Searching for Music P. 128**

The following items are available:

- **PLAY MODE**

 **Shuffle All:** Plays all tracks in the track list in random order.

 **Shuffle Album:** Plays all tracks in the track list in random order by albums. Each song in an album is played in the right order and only the order of albums is randomized.

 **Repeat 1 Track:** Repeats the current track.

- **SOUND:** Displays the sound preferences screen.

▶ **Adjusting the Sound P. 136**

- **SOURCE:** Changes the source mode.

- **Open/Close icon:** Displays/hides the detailed information.

▶▶ Repeat and Shuffle Play

To stop repeat- or shuffle-play, select the current play mode button again.

Searching for Music

 AUDIO button (in iPod® mode)

Search for music using the iPod® menu.

iPod® menu tab

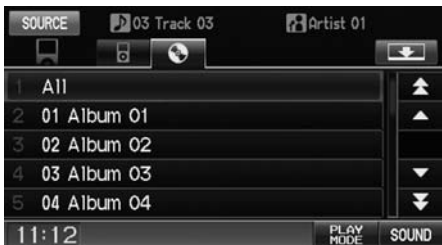
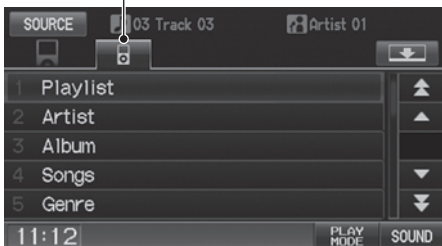

1. Select the menu tab.
2. Select a search category (e.g., Album).

3. Select an item.
 - ▶ The selection begins playing.

▶▶ Searching for Music

The order of the track list displayed if you select "All" on the iPod® menu varies depending on the iPod® model and software.

Back To Current Track: Displays the current track at the top of the list.

Connecting a USB Flash Drive

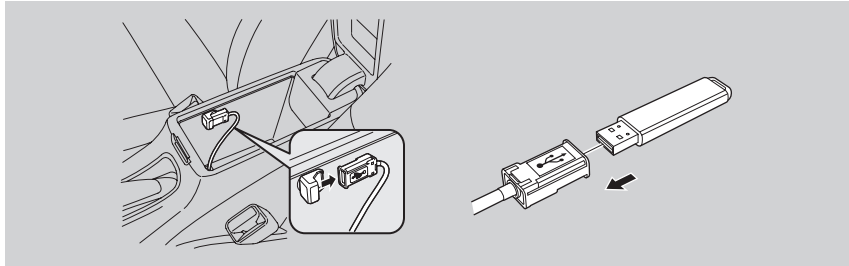

1. Unclip the USB connector in the center console and loosen the adapter cable.
2. Install the USB flash drive to the USB connector.

USB Flash Drives

Use a recommended USB flash drive of 256 MB or higher.

Some digital audio players may not be compatible.

Some USB flash drives (e.g., a device with security lockout) may not work.

Some software files may not allow for audio play or text data display.

Some versions of MP3, WMA, or AAC formats may be unsupported.

Connecting a USB Flash Drive

- Do not use an extension cable with the USB adapter cable.
- Do not connect the USB flash drive using a hub.
- Do not use a device such as a card reader or hard disk drive, as the device or your tracks may be damaged.
- We recommend backing up your data before using the device in your vehicle.

Selecting USB Mode

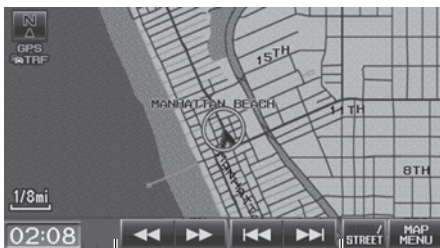

Audio control

1. Connect the USB flash drive to the USB adapter cable in the center console.
2. Press the CD/AUX button until you get to USB mode.
3. Select **AUDIO/STREET** until **AUDIO** is highlighted in blue.
 - ▶ The audio information is displayed at the bottom of the screen.
4. Select **◀◀** or **▶▶** to select a track.
 - ▶ You can also select a track using the SEEK/SKIP button.
 - ▶ The current track number is displayed.

▶▶ Playing a USB Flash Drive

🔊 “Display audio screen”

You can control the USB flash drive using voice commands.

▶ **USB Commands** P. 192

A visual guide helps you operate the audio system.

▶ **System Controls** P. 4

▶ **Basic Operation** P. 6

In some cases, the name of the artist, album, or track may not appear correctly.

Tracks on the USB flash drive are played in their stored order. This order may be different from the order displayed on your PC or device.

The audio system displays Unplayable File, and then skips to the next track when the following tracks are played:

- Tracks in WMA format protected by digital rights management (DRM)
- Tracks in unsupported format

If there is a problem, you may see an error message on the display.

▶ **Error Messages** P. 171

Audio Screen Control

 AUDIO button (in USB mode)

Control the audio screen through the navigation system.

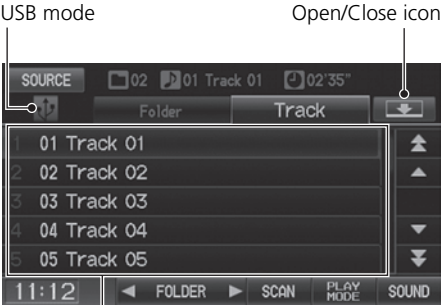

USB mode

Open/Close icon



Select a track.

▶ Select the **Folder** tab to display the folder list.

▶ **Playing Tracks in Folders** P. 132

Track list

The following items are available:

- **FOLDER:** Select  or  to select a folder.
- **SCAN:**



Scan Track: Scans all tracks in the current folder in the order they were stored and plays a 10-second sample. Select **Stop** to stop scanning and play the current selection.



Scan Folder: Scans the first track in each folder on the USB flash drive and plays a 10-second sample. Select **Stop** to stop scanning and play the current selection.

- **PLAY MODE:**
 - ▶ **Random All:** Plays all tracks on the USB flash drive in random order.
 - ▶ **Random in Folder:** Plays all tracks in the current folder in random order.
 - ▶ **Repeat 1 Track:** Repeats the current track.
 - ▶ **Repeat 1 Folder:** Repeats all tracks in the current folder.
- **SOUND:** Displays the sound preferences screen.
 - ▶ **Adjusting the Sound** P. 136
- **SOURCE:** Changes the source mode.
- **Open/Close icon:** Displays/hides the detail information.

Playing Tracks in Folders

🔊 AUDIO button (in USB mode) ▶ **Folder**

Change the folder if the tracks are stored in a folder structure.

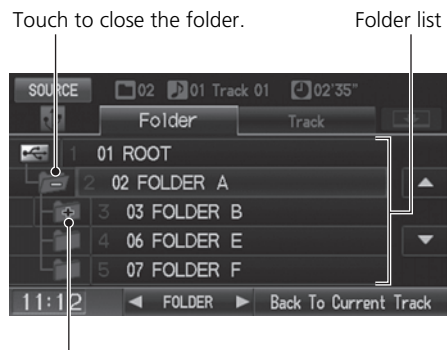

Touch to open the folder.

1. Select a folder.
 - ▶ The system displays the track list.
2. Select a track.
 - ▶ The system begins playing the selected track.

▶▶ Repeat and Random Play

To stop repeat- or random-play, select the current play mode button again.

▶▶ Playing Tracks in Folders

Folder List

- Any music tracks not in a folder are automatically added to a "ROOT" folder, which is displayed at the top of the Folder List.
- If the root folder has additional folders in a lower layer, they are listed on the screen.

Back To Current Track: Displays the current track at the top of the list.

Your audio system allows you to listen to music tracks stored on your *Bluetooth*-compatible phone.

This function is available when the phone is linked to the vehicle's *Bluetooth*® HandsFreeLink® (HFL) system.

➤ *Bluetooth*® HandsFreeLink® P. 139

Selecting *Bluetooth*® Audio Mode

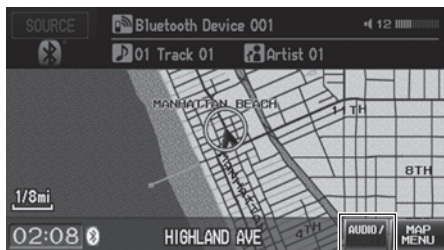

1. Make sure that your phone is on, paired, and linked to HFL.
➤ **Pairing a Phone** P. 142
2. Press the CD/AUX button until you get to *Bluetooth*® Audio mode.
▶ A *Bluetooth*® message and icon are displayed on the display and screen.
3. Select **AUDIO/STREET** until **AUDIO** is highlighted in blue.
▶ The audio information is displayed at the bottom of the screen.

➤ Playing *Bluetooth*® Audio

🗨️ "Display audio screen"

You can control the *Bluetooth*® Audio using voice commands.

➤ ***Bluetooth*® Audio Commands** P. 193

Not all *Bluetooth*-enabled phones with streaming audio capabilities are compatible. To check if your phone is compatible:

- U.S.: Visit automobiles.honda.com/handsfreelink.
- Canada: Visit www.handsfreelink.ca.
- Call HandsFreeLink customer support at (888) 528-7876.

In some states, it may be illegal to perform some data device functions while driving.

In some cases, the name of the artist, album, or track may not appear correctly.

Only one phone can be used with HFL at a time. When there are more than two paired phones in the vehicle, the first paired phone the system finds is automatically linked.

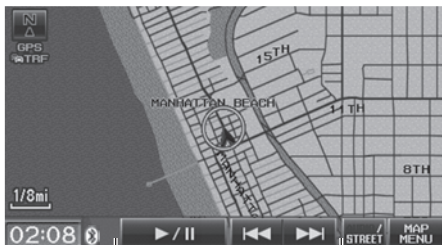

Audio control

4. Select or to select a track.
5. If necessary, follow the cell phone operating instructions for playing audio tracks.

Check the following if the phone is not recognized:

- Another HFL-compatible phone, which is not compatible for *Bluetooth*® Audio, is already connected.

Switching to HFL Mode

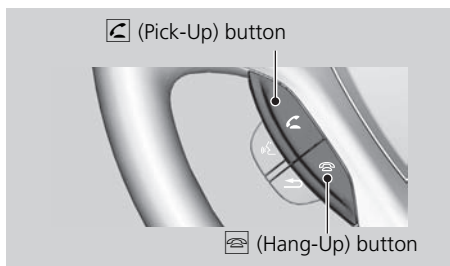

1. If you receive a call when *Bluetooth*® Audio is playing, press the (Pick-Up) button on the steering wheel to answer the call.
▶ *Bluetooth*® HandsFreeLink®
 P. 140
2. Press the (Hang-Up) button to end the call, and *Bluetooth*® Audio is resumed.

▶▶ Playing *Bluetooth*® Audio

If more than one phone is paired to the HFL system, there may be a delay before the system begins to play.

A "NO CONNECT" message may be displayed if:

- The phone is not linked to HFL.
- The phone is not turned on.
- The phone is not in the vehicle.
- An incompatible phone is connected.

Audio Screen Control

 AUDIO button (in BT mode)

Control the audio screen through the navigation system.



Bluetooth® Audio mode

Select an item.



Audio control

The following items are available:

- **GROUP:** Select  or  to select a playlist, album, genre, etc.
- **SOUND:** Displays the sound preferences screen.
 - ▶ **Adjusting the Sound** P. 136
- **SOURCE:** Changes the source mode.

Audio Screen Control

The display items vary on the connected device.

The following functions may not be available on some devices:

- Pause function
- Group selection

AUDIO button (► **AUDIO MENU**) ► **SOUND**

Adjust the sound bass, treble, fader, and balance. In addition, you can set Speed-sensitive Volume Compensation (SVC).



1. Select the tab to adjust the desired sound mode.
2. Adjust the desired level.

» Adjusting the Sound

Fader adjusts the front-to-back strength, while balance adjusts the side-to-side strength.

The **SVC** has four modes: **Off**, **Low**, **Mid**, and **High**. **SVC** adjusts the volume level based on the vehicle speed. The faster you go, the audio volume increases. As you slow down, the audio volume decreases. If you feel the sound is too loud, choose **Low**, and vice versa.

Steering Wheel Controls

Control basic audio system functions using the controls mounted on the steering wheel.

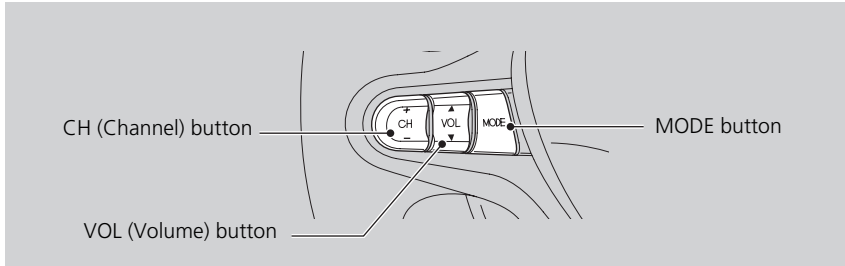

☒ SOURCE Button

DISC mode appears only when a disc is loaded.

When in AUX mode, the following are operable from the remote audio controls:

- iPod®/iPhone®/USB flash drive connected to the USB adapter cable
- *Bluetooth*® Audio (not all phones support this function)

■ MODE Button

Cycles through the audio modes as follows:

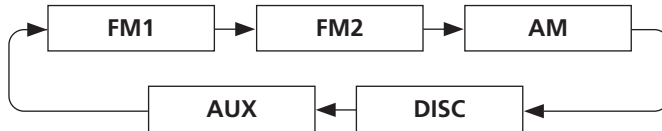

■ VOL (Volume) Button

Adjusts the volume.

- Press the ▲ (Volume) button to increase the volume.
- Press the ▼ (Volume) button to decrease the volume.

■ CH (Channel) Button

FM/AM

- Press the + (Channel) button to select the next preset station (channel).
- Press the - (Channel) button to select the previous preset station (channel).
- Press and hold the + or - button to skip to the next or previous station (channel) in the frequency.

DISC, iPod®, USB, or *Bluetooth*® Audio

- Press the + button to skip to the next track.
- Press the - button to skip to the beginning of the current track. Press the - button again to go to the beginning of the previous track.
- Press and hold the + or - button to skip up or down a folder (DISC/USB).

Bluetooth® HandsFreeLink®

This section describes how to operate *Bluetooth® HandsFreeLink®*. You can place and receive phone calls using your vehicle's audio system without handling your cell phone.

<i>Bluetooth® HandsFreeLink®</i>	140
Pairing a Phone	142
Setting Up Speed Dialing	147
Editing Phone Information	150
Phone Setup	151
Making a Call	152
Receiving a Call	155
HFL Menus	156

PHONE button

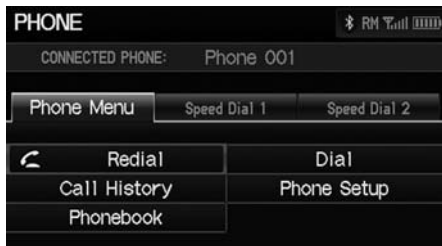

Select an item.

The following items are available:

- **Redial:** Dials the last number.
- **Call History:** Displays the call history.
 ➤ **Using Call History** P. 154
- **Phonebook:** Displays the cell phone's imported phonebook.
 ➤ **Using the Phonebook** P. 153
- **Dial:** Makes a call by entering the phone number.
 ➤ **Entering a Phone Number** P. 153
- **Phone Setup:** Sets up the HFL features.
 ➤ **Pairing a Phone** P. 142
- **Speed Dial 1, 2:** Makes a call to stored speed dial entries.
 ➤ **Using Speed Dial** P. 154
 ➤ **Setting Up Speed Dialing** P. 147

Bluetooth® HandsFreeLink®

You can control the HFL system using voice commands.

➤ **HFL Menus** P. 156



To use HFL, you need a *Bluetooth*-compatible cell phone. For a list of compatible phones, pairing procedures, and special feature capabilities:

- U.S.: Visit automobiles.honda.com/handsfreelink.
- Canada: Visit www.handsfreelink.ca.
- Call HandsFreeLink customer support at (888) 528-7876.

Voice Control Tips

- Aim the vents away from the ceiling and close the windows, as noise coming from them may interfere with the microphone.
- Press and release the  (Talk) button before giving a command. Speak clearly and naturally after a beep.
 ➤ **Voice Control Operation** P. 5
- If the microphone picks up voices other than yours, the command may be misinterpreted.
- To change the volume level, use the audio system's volume knob or the remote audio controls.

Help Features

Say  "Phone command help" or  "Help" any time to get help or hear a list of commands.

 **Voice Help** P. 13

▶▶ Bluetooth® HandsFreeLink®

Bluetooth® Wireless Technology

Bluetooth® name and logos are registered trademarks owned by *Bluetooth* SIG, Inc., and any use of such marks by Honda Motor Co., Ltd., is under license. Other trademarks and trade names are those of their respective owners.

HFL Limitations

An incoming call on HFL will interrupt *Bluetooth®* Audio when it is playing. Audio will resume when the call is ended.

Certain touchscreen functions are disabled while the vehicle is moving.

 **Limitations for Manual Operation** P. 19

Pairing a Phone

📞 PHONE button

When no *Bluetooth*-compatible phone has ever been paired to the system, the following screen appears:

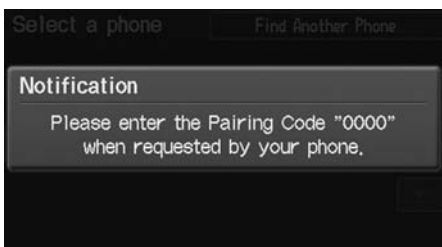

1. Select **Yes**.
2. Put your cell phone in "Discovery" or "Search" mode.
3. Select **OK**.
 - ▶ The system begins to search for your phone.
4. Select your phone in the list.
 - ▶ Select **Find Another Phone** if your phone is not found.
 - ▶ Refer to your phone manual for instructions on searching for a *Bluetooth*® device.
5. Enter the 4-digit pairing code on your phone when prompted to complete the pairing process.

▶▶ Pairing a Phone

Your *Bluetooth*-compatible phone must be paired to HFL before you can make and receive hands-free calls.

The maximum range between your phone and vehicle is about 30 feet (10 meters).

Phone Pairing Tips

- You cannot pair your phone while the vehicle is moving.
- Your phone must be in discovery or search mode when pairing the phone. Refer to your phone's manual.
- Up to six phones can be paired.
- Your phone's battery may drain faster when it is paired to HFL.
- If your phone is not ready for pairing or not found by the system within three minutes, the system will time out and returns to idle.
- The default pairing code "0000" is used unless you change the setting.

Pairing Code

You can change the pairing code setting.

🔧 **Changing the Pairing Code** P. 144

Delete a Phone

You can delete the paired phone.

🔧 **Deleting a Paired Phone** P. 145

Pairing from Phone Setup

PHONE button ▶ **Phone Setup**

Use the Phone setup screen to pair an additional *Bluetooth*-compatible phone if a phone has been previously paired to the system.

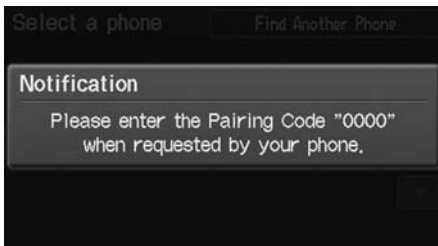

1. Select **Add/Select a Phone** under **Bluetooth setup**.
2. Select **Search**.
3. Put your cell phone in “Discovery” or “Search” mode.
4. Select **OK**.
 - ▶ The system begins to search for your phone.
5. Select your phone in the list.
 - ▶ Select **Find Another Phone** if your phone is not found.
 - ▶ Refer to your phone manual for instructions on searching for a *Bluetooth*® device.
6. Enter the 4-digit pairing code on your phone when prompted to complete the pairing process.

Pairing from Phone Setup

You can control the HFL system using voice commands.

▶ **HFL Menu** P. 156

If a prompt appears asking to connect to a phone, select **No** and proceed with step 1.

■ Changing the Pairing Code

PHONE button ▶ **Phone Setup** ▶ **Add/Select a phone**



1. Select Edit under Pairing Code.



2. Select an item.

The following items are available:

- **Random:** Uses a randomly generated pairing code.
- **Fixed:** Create your own pairing code.



3. If you select **Fixed**, enter a new pairing code. Select **OK**.

- ▶ Select **Delete** to remove the current pairing code.

Deleting a Paired Phone

PHONE button ▶ **Phone Setup** ▶ **Add/Select a phone**



1. Select **List** under **Paired Phone List**.

2. Select a phone to delete.

- ▶ The *Bluetooth*® icon indicates the currently linked phone.

Deleting a Paired Phone

When you transfer the vehicle to a third party, delete all paired phones.

Continued

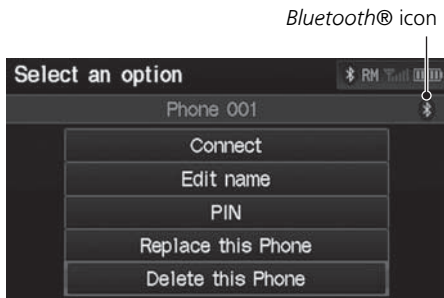

3. Select **Delete this Phone**.

4. Select **Yes**.

■ Changing the Currently Paired Phone

🔑 PHONE button ► **Phone Setup** ► **Add/Select a phone**



1. Select **List** under **Paired Phone List**.

2. Select a phone to connect.

3. Select **Connect**.

► HFL disconnects the linked phone and starts connecting to another paired phone.

▣ Changing the Currently Paired Phone

If no other phones are found or paired when trying to switch to another phone, HFL will inform you that the original phone is linked again.

Setting Up Speed Dialing

PHONE button ▶ **Speed Dial 1** or **Speed Dial 2**

Create speed dial entries with voice tags for easy calling.

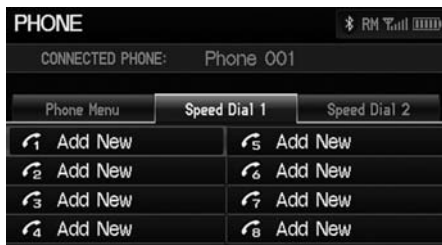

The following options are available:

- **Phonebook:** Adds a number from the imported phonebook.
- **History:** Adds a number from the last 20 numbers.
- **Phone Number:** Enters a number manually.

1. Select **Add New**.

2. Select a number entry option.

3. Select a number.

4. Select **Voice Tag**.

- ▶ Select **OK** to store the speed dial without a voice tag.

5. Follow the prompt to enter a voice tag.

Setting Up Speed Dialing

You can control the HFL system using voice commands.

▶ **HFL Menus** P. 156

Up to 15 speed dial entries can be stored per phone.

■ Registering a Voice Tag to a Speed Dial Entry

📞 PHONE button ▶ **Speed Dial 1** or **Speed Dial 2**

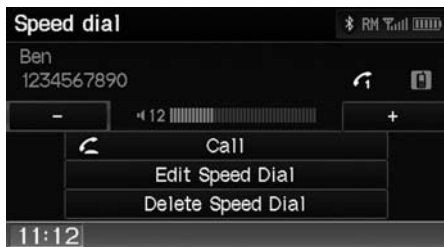

1. Select a speed dial entry.
2. Select **Edit Speed Dial**.
3. Select **Voice Tag**.



4. Follow the prompt to enter a voice tag.

▶▶ Registering a Voice Tag to a Speed Dial Entry

Voice tags allow you to call speed dial entries from any screen by saying [🗨️] *"Dial by voice tag"* and the voice tag, followed by [🗨️] *"Dial."*

- Avoid using duplicate voice tags.
- Avoid using "Home" as a voice tag.
- Avoid using voice tags that only contain numbers.
- It is easier for HFL to recognize a longer name (e.g., "John Smith" instead of "John").

▶▶ Deleting a Speed Dial Entry

1. Select **Delete Speed Dial**.
2. Select **Yes**.

Editing a Voice Tag

PHONE button ▶ **Speed Dial 1** or **Speed Dial 2**



1. Select a speed dial entry.
2. Select **Edit Speed Dial**.
3. Select **Voice Tag**.

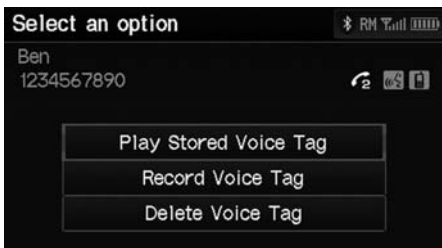

4. Select an item.

The following items are available:

- **Play Stored Voice Tag**: Plays the stored voice tag.
- **Record Voice Tag**: Stores a voice tag. Follow the prompt to enter a voice tag.
- **Delete Voice Tag**: Deletes the stored voice tag. Select **Yes**.

Editing Phone Information

PHONE button ▶ **Phone Setup** ▶ **Add/Select a phone** ▶ **List**

Edit the user name of a paired phone, and protect the phonebook and speed dial entries with a PIN.



1. Select a phone to edit.



2. Select an item.

The following items are available:

- **Connect:** Connects the selected phone to the HFL.
- **Edit Name:** Enter a name.
- **PIN:** Enter a 4-digit PIN. Re-enter to confirm. You can select **Do Not Use PIN** to remove a PIN.
- **Replace this Phone:** Deletes the selected phone and adds a new phone.
 ▶ **Pairing a Phone** P. 142
- **Delete this Phone:** Deletes the user name, call history, and phonebook.

▶▶ Editing Phone Information

You can control the HFL system using voice commands.

▶ **HFL Menus** P. 156

You can name up to six HFL users. Each can be PIN protected, and have their own phonebook, speed dial entries, and call history.

Phone Setup

PHONE button ▶ **Phone Setup**

Set HFL options and features.



1. Select an item.
2. Select OK.

The following items are available:

- **Bluetooth Setup:** Pairs your phone to the system.
 - ▶ **Pairing a Phone** P. 142
- **Bluetooth Connection:** Turns the *Bluetooth®* connection on or off.
 - On:** Connects your Bluetooth-compatible device to the system.
 - Off** (factory default): Disables the feature.
- **Auto Transfer:** Sets whether to automatically transfer a call from your phone to HFL when you enter and turn on the vehicle.
 - On** (factory default): Automatically transfers your call to HFL.
 - Off:** Disables the feature.
- **Auto Answer:** Sets whether to automatically answer an incoming call.
 - On:** Automatically connects an incoming call after about five seconds.
 - Off** (factory default): Disables the feature.
- **Volume:** Select or to adjust the receiver and ring volume. If you change the volume during a call, it is maintained at that level until you change it again.

▶ Phone Setup

You can control the HFL system using voice commands.

▶ **HFL Menus** P. 156

Making a Call



Make calls by entering a number or using the imported phonebook, call history, or speed dial entries.

- **Using the Phonebook** P. 153
- **Entering a Phone Number** P. 153
- **Using Call History** P. 154
- **Using Speed Dial** P. 154



►► Making a Call

You can control the HFL system using voice commands.

► **HFL Menus** P. 156

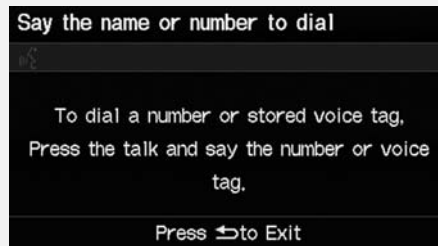
When you say  "Dial by number" or  "Dial by voice tag" on most screens, the following screen appears:



Say the phone number or the voice tag (e.g.,  "John Smith"), followed by  "Dial."

► **Registering a Voice Tag to a Speed Dial Entry** P. 148

Only one phone can be used with HFL at a time. When there are more than two paired phones in the vehicle, the first paired phone the system finds is automatically linked.

Using the Phonebook

PHONE button ▶ **Phonebook**



1. Select a name.
 - ▶ Select alphabetical tabs to display the entries in the group.
2. Select a number.
3. Select **Call** to begin dialing.

Entering a Phone Number

PHONE button ▶ **Dial**



1. Enter a phone number.
2. Select **Dial** to begin dialing.

Using the Phonebook

Up to three icons are displayed for each phonebook entry. If there are more than three numbers for an entry, "... " is displayed.



This feature is not available on all phones.

Entering a Phone Number

A command that consists of several numbers can be spoken together. For example, say "123-456-7890" at once.

■ Using Call History

PHONE button ▶ **Call History**



1. Select a call.
 - ▶ Select **All**, **Dialed**, **Received**, **Missed** to view the call history by category.
2. Select **Call** to begin dialing.

■ Using Speed Dial

PHONE button ▶ **Speed Dial 1** or **Speed Dial 2**



1. Select a speed dial entry.
2. Select **Call** to begin dialing.

» Using Call History

The call history shows the last 20 calls from your phone.

» Using Speed Dial

To make a call using speed dial, you need to create speed dial entries.

▶ **Setting Up Speed Dialing** P. 147

More Speed Dial Lists

You can make a call by using more speed dials on the other phones.

1. Select another paired phone in the list.
2. Select a speed dial entry.
3. Select **Call** to begin dialing.

If the other phone is PIN-protected, enter the PIN when prompted. Select **OK**. PINs are optional.

▶ **Editing Phone Information** P. 150

Receiving a Call

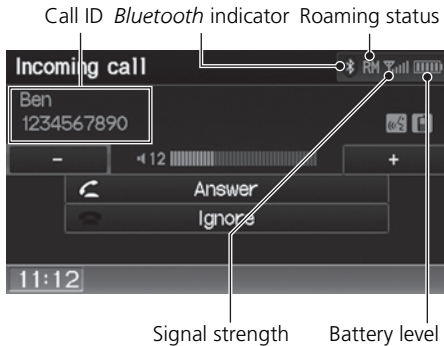

1. Press the  (Pick-Up) button to answer a call and display the Calling screen.





2. Press the  (Hang-Up) button to terminate the call.

The following options are available during a call:

- **MUTE:** Allows you to mute your voice.
- **Touch Tones** (available on some phones): Allows you to send numbers or names during a call. This is useful when you call an automated phone system.
- **Transfer Call:** Allows you to transfer a call from HFL to your phone, or from your phone to HFL.

Receiving a Call

An incoming call notification appears on the navigation screen, and you hear an audible ring tone.

If your phone has Call Waiting, press the  button to put the original call on hold and answer the incoming call. To return to the original call, press the  button again. If you want to hang up the original call and answer the new call, press the  button.

To change the volume level of HFL, use the audio system volume knob or the steering wheel volume controls.

Some phones may send battery, signal strength, and roaming status information to the screen.

Phonebook

Displays the cell phone's imported phonebook.

▶ **Using the Phonebook** P. 153

HFL Menu

Use HFL when the vehicle's ignition is in the ACCESSORY (I) or ON (II) position.

You can operate HFL by voice when on the PHONE screen. Below is the flow chart showing available voice commands.

» HFL Menu



To use HFL, you must first pair your *Bluetooth*-compatible cell phone to the system while the vehicle is parked.

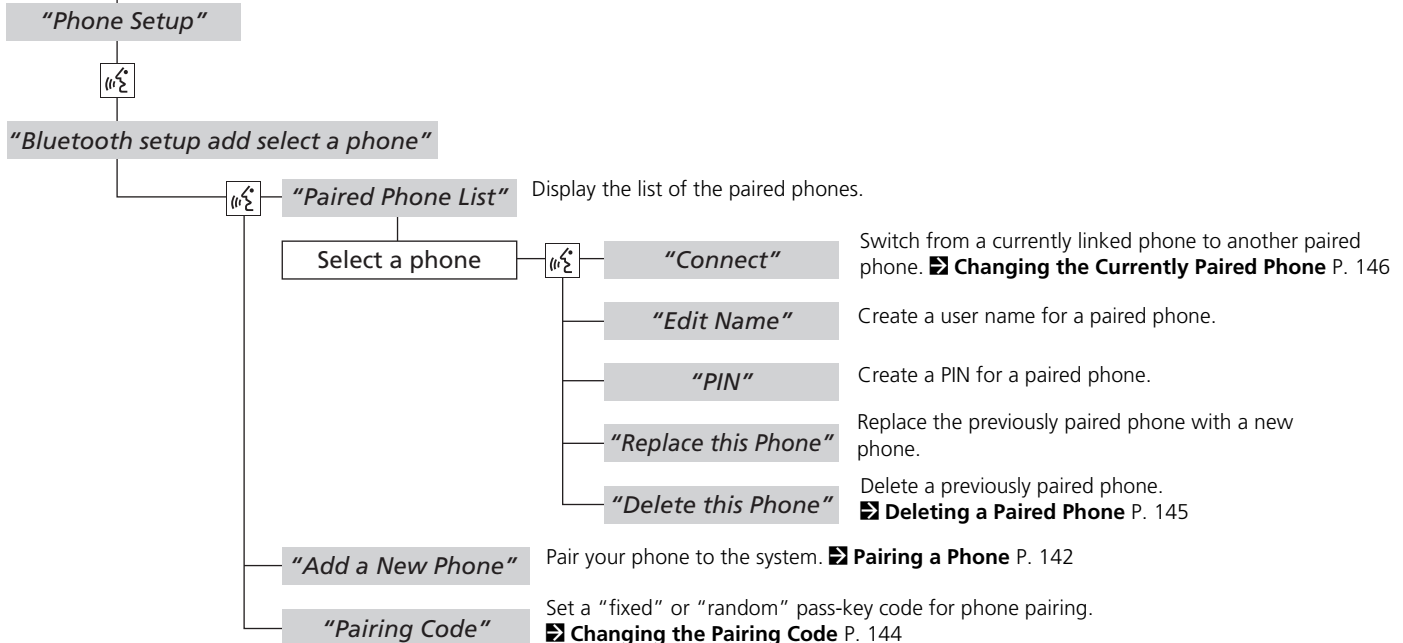

 Press the  (Pick-Up) button to display the PHONE screen.

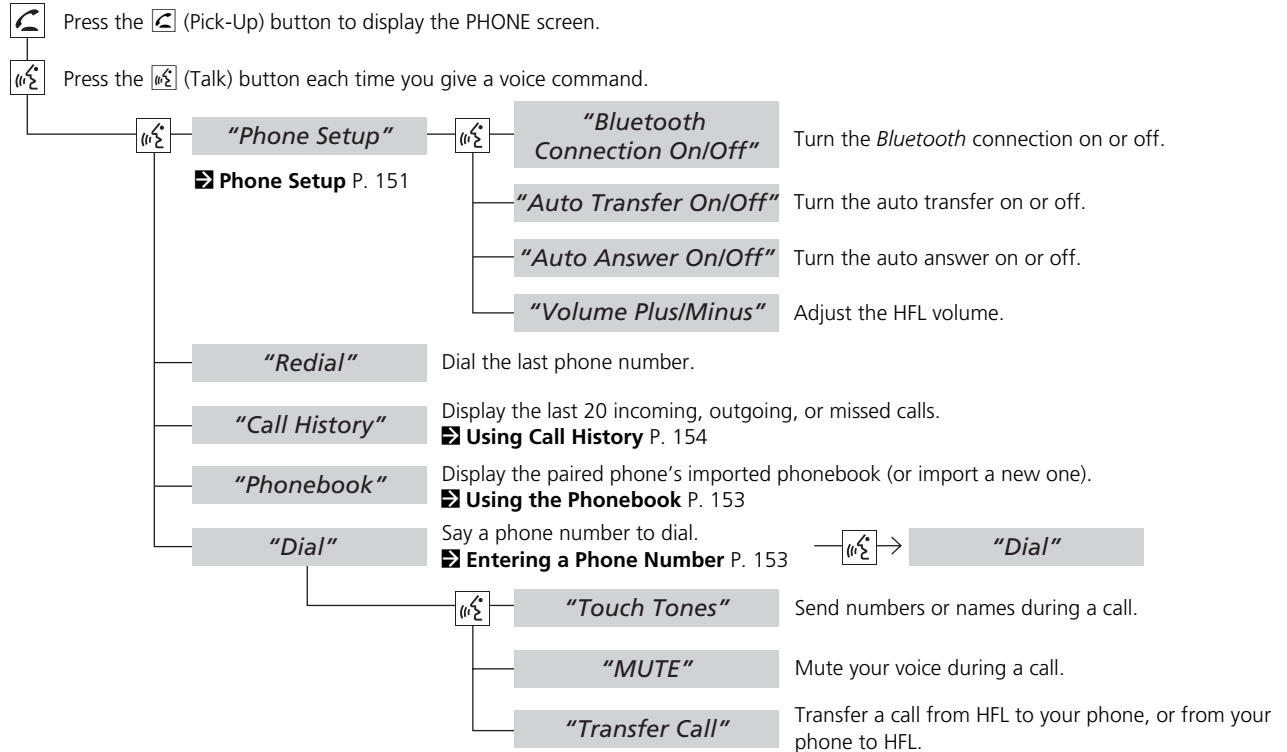
 Press the  (Talk) button each time you give a voice command.





 Press the  (Pick-Up) button to display the PHONE screen.

 Press the  (Talk) button each time you give a voice command.

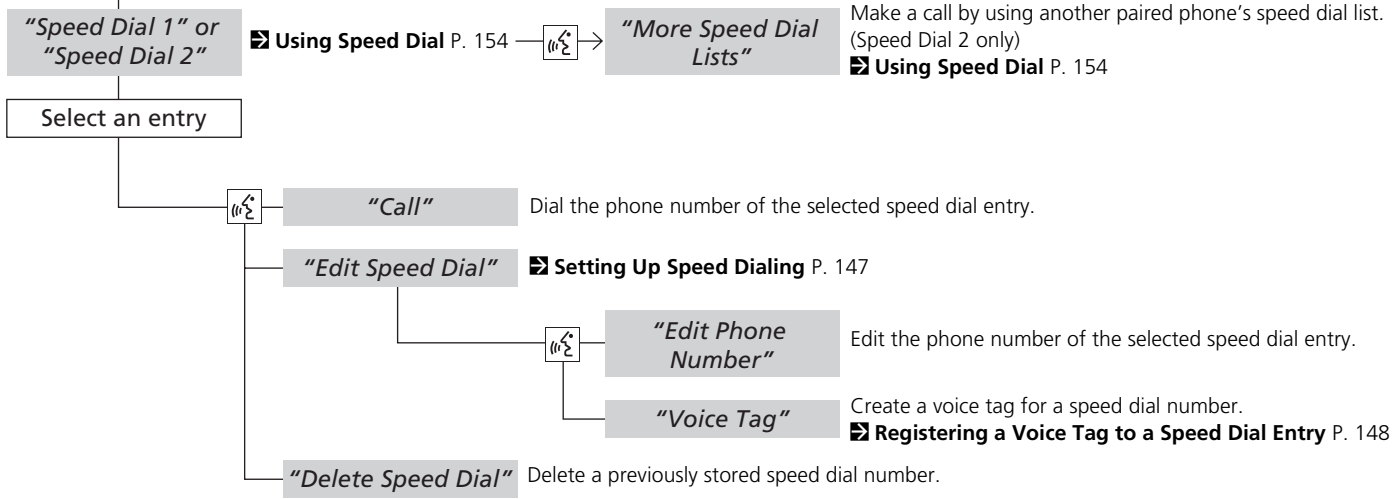

Bluetooth® HandsFreeLink®

Other Features

This section describes the useful functions incorporated into the navigation system.



Trip Computer	160
Information Functions	161
System/Device Information	161
Map Update	161
Rearview Camera	162

INFO button ► Trip Computer

View the distance traveled and average fuel consumption.



Select an item.

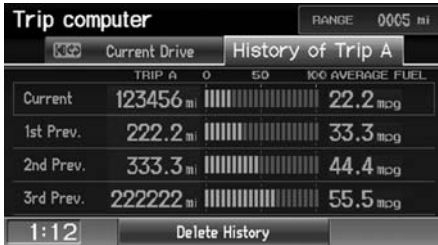

The following items are available:

- **Current Drive:** Displays the current trip information.
- **History of Trip A:** Displays information for three previous histories. The information is stored every time you reset Trip A.
- **Delete History:** Deletes the trip information. Select **Yes**.

» Trip Computer

Displays the following trip information:

- **Instant Fuel:** The current estimated instant fuel economy.
- **Average Fuel:** The average fuel economy since the last key cycle.
- **1st, 2nd, 3rd Prev.:** The previous average fuel consumption.
- **RANGE:** The estimated distance you can travel on the fuel remaining in the tank.

These values are estimates only.

System/Device Information

INFO button ► **System/Device Information**

View database, software, device, and vehicle identification information.



Map Update

INFO button ► **Map Update**

Update the map database.



System/Device Information

You will need this information when ordering a map update.

► **Obtaining Navigation Update Data** P. 181

Map Update

When you order a map update, it is mailed to you on a USB flash drive.

► **Obtaining Navigation Update Data** P. 181

Rearview Camera

Your vehicle is equipped with a rearview camera. When you shift into Reverse, the rear view is displayed on the navigation system screen. The edge of the bumper and parking guide lines are also displayed.

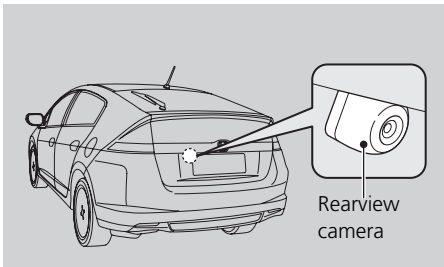

To turn the guide lines on or off, press and hold the CANCEL button until the guide lines turn on or off.

Press the ZOOM IN/OUT button to adjust the screen brightness.

Screen display

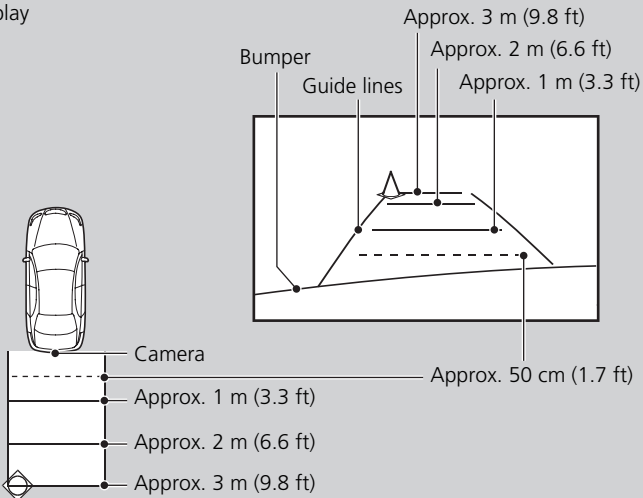

» Rearview Camera

Always keep the camera lens clean and unobstructed. The rearview camera has a lens that makes distances appear different than they actually are. Always take care when reversing, and look behind you for obstacles.

Navigation controls are disabled when in Reverse.

If you turn the guide lines off, they remain off until you turn them back on.





Adjusting the brightness for the rearview camera display does not affect the brightness for the navigation screen.

Troubleshooting



Troubleshooting	164
Map, Voice, Entering Destinations	164
Traffic	166
Guidance, Routing	166
Update, Coverage, Map Errors	168
Display, Accessories	168
Rearview Camera	169
Miscellaneous Questions	169
Error Messages	171
Navigation System	171
Disc Player	172
iPod®	173
USB Flash Drive	174

Map, Voice, Entering Destinations

Problem	Solution
The Startup Confirmation screen is displayed every time I start the car.	This is normal. The Startup Confirmation screen reminds you and your guest drivers to always operate the navigation system in a safe manner. If you do not select OK at startup, voice commands will not work.
The navigation system reboots by itself (returns to the opening screen).	A reboot can be caused by extreme temperatures or shock from bumpy roads, and does not necessarily indicate a problem. If this happens frequently, please see your dealer.
How do I specify a destination when an entered city or street could not be found?	<ul style="list-style-type: none"> • Try entering the street first. Some cities are lumped in with a major metro area. In rural “unverified” areas or new subdivisions, streets may be missing or only partially numbered. • Try selecting the destination directly from the map.  Map Input P. 75
Why do some letters become grayed out when I enter an address?	As you enter each letter in an address or a place/landmark, the navigation system looks in the database to see what letters are possible and grays out letters that do not apply.
How do I delete Personal Addresses, Previous Destinations, or the Home Address?	<ol style="list-style-type: none"> 1. Press the INFO button. Select Setup > Personal Information to display the types of information. 2. Select the type of address to delete. 3. Select Delete.
I cannot hear the navigation system voice.	Press the INFO button. Select Setup and check that Volume is not set to Off .  Display and Volume Settings P. 22
The voice control system is having difficulty recognizing my voice commands.	<ul style="list-style-type: none"> • Check that the vents are not blowing air onto the microphone on the ceiling, the vehicle is as quiet as possible, and you are using the correct command when speaking.  Voice Recognition P. 21 • Say  “<i>Help</i>” on any screen to see a list of the applicable voice commands.
The navigation system pronunciation of street names in the guidance command or destination address sounds strange.	The basic guidance phrases use a studio-recorded voice, but street names are pronounced using a machine-generated voice. Consequently, the name may be mispronounced or sound strange at times.









Problem	Solution
I cannot give voice commands.	Make sure you selected "OK" at the Startup Confirmation screen. ➤ Start-up P. 18
I cannot select an option on the touch screen.	To prevent driver distraction, certain touch screen functions and features are limited or inoperable while the vehicle is moving. Use voice commands, or pull over to proceed.
The screen is bright when I drive at night.	<ol style="list-style-type: none"> 1. Check that the nighttime dashboard brightness control is not set to maximum. 2. Press the INFO button. Select Setup > Other > Color > Map. Set the Night color to Black for the best contrast. ➤ Switching Display Mode Manually P. 27
The screen is dark when I drive during the day.	Press the INFO button. Select Setup > Other > Color > Map . Set the Day color to White for the best contrast. ➤ Switching Display Mode Manually P. 27
How do I change or remove my PIN?	<ol style="list-style-type: none"> 1. Press the INFO button. Select Setup > Personal Information > PIN Number > GO Home 1 PIN or GO Home 2 PIN or Address Book PIN. 2. Enter your existing PIN. You then have the choice to change or remove the PIN. ➤ PIN Numbers P. 37
I have forgotten my PIN. How do I reset the PIN for Home or the PIN for personal addresses (User 1 or User 2)?	Your dealer must reset the PIN for you.
Why is Call grayed out on the Calculate Route screen?	Your phone is not paired to <i>Bluetooth</i> ® HandsFreeLink® or, if paired, your phone is in use.

Traffic

Problem	Solution
<p>My FM Traffic is missing or is not displaying properly. What is wrong?</p>	<p>Verify the following:</p> <ul style="list-style-type: none"> • FM Traffic relies on a clear FM signal. If signal strength is low, traffic data may not be available. • Check the traffic icon on the icon bar, and the icon options for traffic. <ul style="list-style-type: none"> ▶ Showing Icons on the Map P. 92 • It is possible that there is a temporary technical problem with your metropolitan area traffic. You can call Honda Automobile Customer Service to see if there is an outage. <ul style="list-style-type: none"> ▶ Honda Automobile Customer Service Contact Information P. 180 • If the situation persists, see your Honda dealer for assistance.

Guidance, Routing

Problem	Solution
<p>The navigation system does not route me the same way I would go or the same way as other mapping systems.</p>	<p>The navigation system attempts to generate the optimal route. You can change the route preferences used when calculating a route.</p> <ul style="list-style-type: none"> ▶ Changing the Route Preference P. 78
<p>The street I'm on is not shown on the map screen.</p>	<p>The mapping database is constantly undergoing revision. You can access the most recent information on the internet.</p> <ul style="list-style-type: none"> ▶ Map Coverage P. 181
<p>The vehicle position icon is not following the road and the "GPS icon" text in the upper left hand corner of the screen is white or missing.</p>	<ul style="list-style-type: none"> • Check that the GPS antenna (located in the dashboard) is not blocked. For best reception, remove items from the dashboard, such as radar detectors, cell phones, or loose articles. • Metallic tinting or other aftermarket devices can interfere with the GPS reception. Please consult your dealer. <ul style="list-style-type: none"> ▶ GPS System P. 178

Problem	Solution
The blue highlighted route and voice guidance stopped or turned into a blue/pink dashed line before I got to my destination.	Your route has entered an unverified area.  Unverified Area Routing P. 42
How do I stop the map from rotating as I drive along?	Select the map orientation icon on the map screen, or say  "Display north-up" to change the map orientation.
Sometimes, I cannot select between the North-up and Heading-up map orientations.	The Heading-up map orientation can only be shown in the lower scales (1/20 - 1 mile scales).  Map Scale and Functions P. 95
The "time to destination" display sometimes increases even though I am getting closer to my destination.	If your speed reduces due to slower traffic, the navigation system updates the "time to destination" based on your actual road speed to give you a better estimate of arrival time.
The vehicle position icon on the map "lags" a short distance behind, especially when I arrive at an intersection.	This is normal. The navigation system is unaware of the width of intersections. Large differences in vehicle position can indicate a temporary loss of the GPS signal.  GPS System P. 178
The screen is showing white dots as I drive along.	These dots are called "breadcrumbs." These are displayed if Off-road Tracking is set to On and you drive more than 1/2 mile off mapped roads.  Off-road Tracking P. 51
How do I remove the white dots ("breadcrumbs") from my screen?	Press the INFO button. Select Setup > Other > Vehicle , and set Off-road Tracking to Off , then return to the map.  Off-road Tracking P. 51
A road that I selected to avoid is being used when routing.	When you "draw" your area to avoid, make sure to select sections of roads that include at least one intersection.  Avoiding Streets P. 102
My elevation (shown when I display the current position) seems to fluctuate even though my elevation has not changed.	This is normal. The elevation can vary ±100 feet due to GPS calculation errors.  GPS System P. 178

Problem	Solution
My elevation is missing on the “current position” screen.	The elevation is only displayed if the GPS antenna can receive signals from at least four satellites. Try moving the vehicle into an open area. The elevation is also not displayed if the calculated elevation is zero or below sea level.

Update, Coverage, Map Errors

Problem	Solution
My city is not part of a fully verified detailed coverage area.	The mapping database is constantly undergoing revision. You can access the most recent information on the internet. ➤ Map Coverage P. 181
Does the navigation system work outside North America?	The navigation system contains maps for the 50 U.S. states, Canada, and Puerto Rico. The navigation system will not work in Mexico or other countries. ➤ Map Coverage P. 181
Can I play video DVDs in my navigation system?	No. The navigation system is designed only to read music discs. If you experience any problems that you cannot resolve, please contact your dealer.
How do I report errors I find in the database?	Minor errors are bound to occur in a large database. If you encounter major errors, see ➤ Reporting Errors P. 180

Display, Accessories

Problem	Solution
The display appears dim when starting the car in really cold weather.	This is normal. The display will become brighter after a few minutes.

Rearview Camera

Problem	Solution
When I shift gears, the rearview camera image display is delayed.	This is normal. When shifting into or out of Reverse, you may experience a delay while the screen image switches between the navigation screen and the rearview camera image.
The rearview camera image is too dark or too bright. How do I adjust the brightness?	While the camera image is displayed, press the ZOOM IN/OUT button to adjust the brightness. This adjustment does not affect the navigation screen brightness settings.

Miscellaneous Questions



Problem	Solution
My clock frequently changes forward and backward by one hour.	The clock setting is automatically updated based on your GPS location. If you live and work on the boundary between two time zones, you can turn off this feature. ☒ Clock Adjustment P. 47
The clock changes even when I am not driving near a time zone boundary.	The time zone boundaries are only approximated in the navigation system. Depending on the geography of the time zone boundary, the switch to a different zone can be erratic. ☒ Clock Adjustment P. 47
My state does not observe daylight saving time. How do I turn off this feature?	Press the INFO button. Select Setup > Other > Clock Adjustment > Clock Adjustment , and set Auto Daylight to Off . ☒ Clock Adjustment P. 47
Daylight saving time has started, but the navigation system did not change time even though Auto Daylight is set to ON.	The automatic daylight saving time feature does not work in regions where the daylight saving time system has not been adopted.
The navigation system automatic daylight feature is not switching the navigation system clock on the correct dates.	Press the INFO button. Select Setup > Other > Clock Adjustment > Clock Adjustment , and set Auto Daylight to On . Note that the automatic daylight feature does not work in regions where the daylight saving time system has not been adopted. ☒ Clock Adjustment P. 47

Problem	Solution
The navigation system clock switched by one hour for no apparent reason.	You may be driving near a time zone boundary.  Clock Adjustment P. 47
My battery was disconnected or went dead, and the navigation system is asking for a code.	Your vehicle comes with a label in the Owner's Manual kit that includes the system's security code and serial number. You should keep this label in a safe place outside your vehicle. If you cannot find it, contact your dealer.
How do I change the interface language?	Press the INFO button. Select Setup > Other > Language , and set the language to English, Français, or Español .

Navigation System

Error Message	Solution
The display temperature is too high! For protection, the display will shut down.	This message appears briefly when the display temperature is too high. The navigation system turns off until the display cools down. The system turns back on automatically when the display cools down.
The navigation system is unable to start due to excessive heat. The system will start after the system cools.	The navigation system has difficulty accessing to the map database when the temperature is high. The navigation system starts up automatically when the SD module cools down.
Route has not been completed. Please try again from a different location.	This message appears when you are on a route to or from a new area that is not in the database. Try planning a different route to or from a different location. If the error persists or is shown for a wide area, see your dealer.
Destination is not in this database version. Please set from map.	The destination was not found in the database. Try another destination nearby, or select the destination from the map using the joystick. If the error persists or is shown for a wide area, see your dealer.
No POI found...	

Disc Player

Error Message	Cause	Solution
Bad Disc Please Check Owners Manual	Servo error	<ul style="list-style-type: none"> • Press the  (Eject) button and remove the disc, and check that the error message is cleared. • Check that the disc is not damaged or deformed, and insert the disc again. <p> Recommended Discs P. 124</p> <ul style="list-style-type: none"> • If the error message reappears, press the  button, and pull out the disc. • Insert a different disc. If the new disc plays, there is a problem with the first disc. • If the error message repeats, or the disc cannot be removed, contact your dealer. Do not try to force the disc out of the player.
	Mechanical error	
Mecha Error	Mechanical error	
Check Disc	Focus error	
	Disc violates copyright Disc not supported	
	Load error	
Unsupported	Appears when an unsupported disc is inserted.	<ul style="list-style-type: none"> • If it appears when a supported disc is inserted, reinsert the disc.
Unplayable File	Appears when the tracks on the disc are DRM or an unsupported format.	<ul style="list-style-type: none"> • This error message appears for about three seconds, then plays the next song.
	The system cannot read the track(s).	<ul style="list-style-type: none"> • Check the tracks on the disc. There is a possibility that the tracks have been damaged.
Heat Error	High temperature	<ul style="list-style-type: none"> • Turn the audio system off and allow the player to cool down until the error message is cleared.

iPod®

Error Message	Cause	Solution
Unsupported	Appears when an unsupported iPod®/iPhone® is connected.	<ul style="list-style-type: none"> • Update the iPod®/iPhone® software to the latest version. • If it appears when a supported iPod®/iPhone® is connected, reconnect the iPod®/iPhone®.
Connect Retry	Appears when the iPod®/iPhone® cannot be authenticated.	Reconnect the iPod®/iPhone®.
No Data	Appears when there are no tracks in the iPod®/iPhone®.	Store tracks in the iPod®/iPhone®.
Bad Use Device Please Check Owners Manual	Appears when the overcurrent protection feature of the system stops supplying power to USB because an incompatible iPod®/iPhone® is connected.	Disconnect the iPod®/iPhone®. Turn the audio system off, and turn it on again. Do not reconnect the iPod®/iPhone® that caused the error.
USB Error	Appears when the internal USB error occurs.	Try a different iPod®/iPhone®.

USB Flash Drive

Error Message	Cause	Solution
Unsupported	Appears when an unsupported device is connected.	If it appears when a supported device is connected, reconnect the device.
Unplayable File	Appears when the tracks in the USB flash drive are DRM or an unsupported format.	This error message appears for about three seconds, then plays the next song.
	The system cannot read the track(s).	Check the tracks in the USB flash drive. There is a possibility that the tracks have been damaged.
No Data	Appears when the USB flash drive is empty or there are no tracks in MP3, WMA, or AAC format in the drive.	Save tracks in MP3, WMA, or AAC format in the USB flash drive.
Bad Use Device Please Check Owners Manual	Appears when the overcurrent protection feature of the system stops supplying power to USB because an incompatible device is connected.	Disconnect the device. Turn the audio system off, and turn it on again. Do not reconnect the device that caused the error.
USB Error	Appears when the Internal USB ROM error occurs.	Try a different USB flash drive.

Reference Information

System Initialization	176	Visiting Your Dealer	180
Entering the Security Code	176	Map Coverage	181
Acquiring GPS Information	176	Obtaining Navigation Update Data	181
Startup Confirmation Screen	177	Traffic Information	182
Map Matching	177	Operation in Alaska, Hawaii, Canada, and Puerto Rico	182
System Limitations	178	Legal Information	183
GPS System	178	END-USER TERMS	183
Address Calculation	178	As required by the FCC	185
Database	178		
Customer Assistance	180		
Resolving Problems	180		
Reporting Errors	180		
Honda Automobile Customer Service Contact Information	180		

The navigation system must be initialized if power to the navigation system is interrupted for any reason (e.g., the battery was disconnected).

Entering the Security Code

Find the navigation system's security code and serial number label in your Owner's Manual kit. Do not store the label in your vehicle. If you lose the label, you must first retrieve the serial number, and then obtain the code. You can find out about your serial number and security code from a dealer.

Enter Code		
-		
1	2	3
4	5	6
7	8	9
	0	
Delete		OK

1. Turn the ignition switch to ON (II), and turn on the audio system.
 - ▶ If you turn the ignition switch to ACCESSORY (I), you will be requested to enter the security code. See step 2.
2. Enter the security code.
 - ▶ If you do not enter the security code correctly after 10 tries, leave the system for one hour before trying again, or visit a dealer to have the system reset.

NOTE:

In the U.S., you can register the security code on Honda Owners (owners.honda.com.). To find information on how to retrieve the serial number and obtain the code, visit radio-navicode.honda.com.

Acquiring GPS Information

Depending on the length of time the power was interrupted, your system may require GPS initialization.

The navigation system lost power and is acquiring its location from the GPS satellites. This usually takes less than 10 minutes.

- * Start the engine.
- * Park the vehicle in an open area away from trees, power lines, and tall buildings.
- * Remove loose articles, cell phones, or electrical accessories located near the GPS antenna.
- * If this screen is displayed repeatedly when starting the vehicle, see your dealer.

If initialization is not necessary, the system proceeds directly to the Startup Confirmation screen.

If the system fails to locate a sufficient number of satellites to locate your position within 10 minutes, the following screen is displayed.

Something is interfering with the system's ability to acquire its location. Check the following:

- * The vehicle must be in an open area with a clear view of the sky.
- * Remove sources of GPS interference like metallic window tint above antenna, or electrical items near antenna (see owner's manual for details).
- * Check GPS antenna cable connection.
- * Restart the engine and repeat the GPS acquire procedure. If the problem persists, see your dealer.

OK

If you are experiencing GPS reception problems:

▶ **GPS System P. 178**

Startup Confirmation Screen

The Startup Confirmation screen is displayed when initialization has successfully completed. It is displayed every time you start your vehicle. Select **OK** to continue.

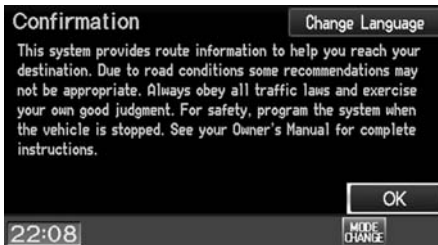

NOTE:

"OK" cannot be selected using a voice command.

Map Matching

Map matching is the process of using the acquired GPS information to locate your position on the map screen. If you are on a mapped road, the name of the road is displayed along the bottom of the map screen when map matching is completed. Do not enter a destination until the road name is displayed.

The system may initially show your location on a different street (e.g., in urban areas where streets are close together), may show an incorrect elevation, or may delay the display of the vehicle position icon at intersections. This is normal; the system will correct itself while you drive.

GPS System

The signals received from the GPS satellites are extremely weak (less than a millionth of the strength of a local FM station) and require an unobstructed view of the sky. The GPS antenna is located in the dashboard. The signal reception can easily be interrupted or interfered with by the following:

- Metallic window tint on the front or side windows
- Cell phones, PDAs, or other electronic devices docked in a cradle or lying loose on the dashboard
- Remote starters or “hidden” vehicle tracking systems mounted near the navigation unit
- Audio electronic devices mounted near the navigation unit
- Trees, tall buildings, freeway overpasses, tunnels, or overhead electrical power wires

The GPS is operated by the U.S. Department of Defense. For security reasons, there are certain inaccuracies built into the GPS for which the navigation system must constantly compensate. This

can cause occasional positioning errors of up to several hundred feet.

Address Calculation

The destination icon shows only the approximate location of a destination address. This occurs if the number of possible addresses is different from the number of actual addresses on a block. For example, the address 1425 on a 1400 block with 100 possible addresses (because it is followed by the 1500 block) will be shown a quarter of the way down the block by the system. If there are only 25 actual addresses on the block, the actual location of address 1425 would be at the end of the block.

Database

The digitized map database reflects conditions as they existed at various points in time before production. Accordingly, your database may contain inaccurate or incomplete data or information due to the passage of time, road construction, changing conditions, or other causes.

For example, some places/landmarks may be missing when you search the database because the name was misspelled, the place was improperly categorized, or a place/landmark is not yet in the database. This is also true for police stations, hospitals, and other public institutions. Do not rely on the navigation system if you need law enforcement or hospital services. Always check with local information sources.

In addition, the map database contains verified and unverified areas. Unverified streets may be missing from the map, in the wrong location, or have an incorrect name or address range. A message will warn you if your route includes unverified streets. Exercise additional caution when driving in unverified areas.

The database does not include, analyze, process, consider, or reflect any of the following categories of information:

- Neighborhood quality or safety
- Population density
- Availability or proximity of law enforcement
- Emergency, rescue, medical, or other assistance
- Construction work, zones, or hazards
- Road and lane closures
- Legal restrictions (such as vehicular type, weight, load, height, and speed restrictions)
- Road slope or grade
- Bridge height, width, weight, or other limits
- Traffic facilities safety
- Special events

- Pavement characteristics or conditions

Every effort has been made to verify that the database is accurate. The number of inaccuracies you experience increases the longer you go without obtaining an updated map database.

🗲 **Obtaining Navigation Update Data**

P. 181

We assume no liability for any incident that may result from an error in the program, or from changed conditions not noted above.

Resolving Problems

If you run into a specific issue that you cannot resolve, consult the following help resources:

- For navigation system issues:
 - **Troubleshooting** P. 164There are also FAQs available online at *automobiles.honda.com*.
- For questions regarding *Bluetooth® HandsFreeLink®*:
 - **Bluetooth® HandsFreeLink®** P. 140
- For traffic-related issues:
 - **Traffic** P. 166
- For reporting issues with the database or places/landmarks:
 - **Reporting Errors** P. 180
- Call Honda Automobile Customer Service.
 - **Honda Automobile Customer Service Contact Information** P. 180

Reporting Errors

You can help to improve database accuracy by reporting any errors you encounter.

- Report errors in freeways and main “verified” roads shown in black on the map at *<http://mapreporter.navteq.com/dur-web-external/>*.
- Please do not report errors in purple “unverified” roads. Maps for these areas are provided for reference only.
 - **Unverified Area Routing** P. 42
- Please do not report errors in places/landmarks, such as changes in business names. Information about points of interest are constantly being updated. An updated database is available for purchase, usually in the fall of each year.
 - **Obtaining Navigation Update Data** P. 181
- For vehicle position icon errors, screen error messages, or other GPS-related errors:
 - **Troubleshooting** P. 164
 - **System Limitations** P. 178

Honda Automobile Customer Service Contact Information

Honda Navi

American Honda Motor Co., Inc.

Honda Customer Service
Mail Stop 500-2N-7E
1919 Torrance Blvd.

Torrance, CA 90501-2746

Tel: (800) 999-1009

Fax: (310) 783-3273

Visiting Your Dealer

If you have a question that you cannot resolve using the available help resources, you can consult your dealer. Please identify the specific issue (e.g., error occurs when you enter a specific address, when driving on a certain road, or just when it’s cold) so that the service technician can refer the issue to the factory so that a solution can be found. Be patient, the service technician may be unfamiliar with your specific issue.

Map Coverage

The navigation system provides map coverage for the contiguous United States, Alaska, Hawaii, Canada, and Puerto Rico. The map coverage consists of accurately mapped (verified) metropolitan areas and a less accurate (unverified) rural database. Note that unverified areas are constantly being reviewed and converted to verified areas each year.

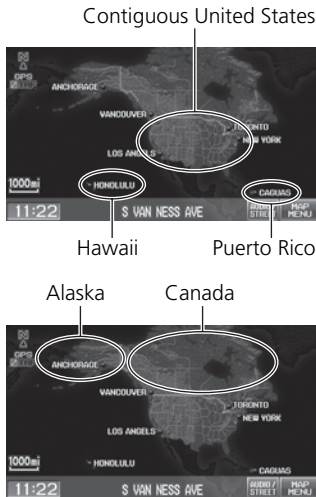

Map coverage update information is available from Honda Automobile Customer Service or online at www.hondanavi.com.

To find navigation system update information:

1. Visit www.hondanavi.com.
2. Enter your vehicle model and model year.
3. Click Map Coverage to display a list of verified coverage areas on the most recent update.
4. Click Map Coverage Details to display a PDF document with a full listing of all coverage areas.

▶ Adobe® Reader® is required for viewing and printing the Portable Document Format (PDF) documents. To download the latest version of Adobe Reader, visit <http://get.adobe.com/reader/>.

Obtaining Navigation Update Data

Honda is continually expanding the scope of the navigation system. Navigation system software upgrades may be made available periodically, usually in the fall of each year.

To purchase an updated data file:

1. Obtain your vehicle's VIN number and the System/Device Information.
▶ **System/Device Information** P. 161
2. Call the Honda Navigation Disc Fulfillment Center at (888) 291-4675, or order online at www.hondanavi.com.

Update data is not available from your dealer. However, the dealer may assist you in obtaining an update data for you out of courtesy. There is no program for free updates.

Traffic Information

- Continuously updated traffic information is available in major metropolitan areas across the 48 contiguous states and Hawaii.
- Visit automobiles.honda.com/traffic for a complete listing of coverage areas and other information.

Operation in Alaska, Hawaii, Canada, and Puerto Rico

■ Map Coverage

All roads displayed on the map screens are verified roads. Information in this manual relating to “unverified” roads or areas is not applicable.

■ Address and Place Entry Screens

Entering a destination address or place/landmark on another island may result in a screen caution message. This is because there are no ferry routes between islands in the database.

END-USER TERMS

The data ("Data") is provided for your personal, internal use only and not for resale. It is protected by copyright, and is subject to the following terms and conditions which are agreed to by you, on the one hand, and NAVTEQ North America, LLC ("NT") and its licensors (including their licensors and suppliers) on the other hand.

© 2010 NAVTEQ. All rights reserved.

This data includes information taken with permission from Canadian authorities, including © Her Majesty the Queen in Right of Canada, © Queen's Printer for Ontario, © Canada Post Corporation, GeoBase®, © The Department of Natural Resources Canada. All rights reserved.

NAVTEQ holds a non-exclusive license from the United States Postal Service® to publish and sell ZIP+4® information.

©United States Postal Service® 2010. Prices are not established, controlled or approved by the United States Postal Service®. The following trademarks and registrations are owned by the USPS: United States Postal Service, USPS, and ZIP+4.

TERMS AND CONDITIONS

Personal Use Only. You agree to use this Data for the solely personal, non-commercial purposes for which you were licensed, and not for service bureau, time-sharing or other similar purposes. Accordingly, but subject to the restrictions set forth in the following paragraphs, you may copy this Data only as necessary for your personal use to (i) view it, and (ii) save it, provided that you do not remove any copyright notices that appear and do not modify the Data in any way. You agree not to otherwise reproduce, copy, modify, decompile, disassemble or reverse engineer any portion of this Data, and may not transfer or distribute it in any form, for any purpose, except to the extent permitted by mandatory laws. Multi-disc sets may only be transferred or sold as a complete set as provided by NT and not as a subset thereof.

Restrictions. Except where you have been specifically licensed to do so by NT, and without limiting the preceding paragraph, you may not (a) use this Data with any products, systems, or applications installed or otherwise connected to or in communication with vehicles, capable of

vehicle navigation, positioning, dispatch, real time route guidance, fleet management or similar applications; or (b) with or in communication with any positioning devices or any mobile or wireless-connected electronic or computer devices, including without limitation cellular phones, palmtop and handheld computers, pagers, and personal digital assistants or PDAs.

Warning. The Data may contain inaccurate or incomplete information due to the passage of time, changing circumstances, sources used and the nature of collecting comprehensive geographic data, any of which may lead to incorrect results.

No Warranty. This Data is provided to you "as is," and you agree to use it at your own risk. NT and its licensors (and their licensors and suppliers) make no guarantees, representations or warranties of any kind, express or implied, arising by law or otherwise, including but not limited to, content, quality, accuracy, completeness, effectiveness, reliability, fitness for a particular purpose, usefulness, use or results to be obtained from this Data, or that the Data or server will be uninterrupted or error-free.

Disclaimer of Warranty: NT AND ITS LICENSORS (INCLUDING THEIR LICENSORS AND SUPPLIERS) DISCLAIM ANY WARRANTIES, EXPRESS OR IMPLIED, OF QUALITY, PERFORMANCE, MERCHANTABILITY, FITNESS FOR A PARTICULAR PURPOSE OR NON-INFRINGEMENT. Some States, Territories and Countries do not allow certain warranty exclusions, so to that extent the above exclusion may not apply to you.

Disclaimer of Liability: NT AND ITS LICENSORS (INCLUDING THEIR LICENSORS AND SUPPLIERS) SHALL NOT BE LIABLE TO YOU: IN RESPECT OF ANY CLAIM, DEMAND OR ACTION, IRRESPECTIVE OF THE NATURE OF THE CAUSE OF THE CLAIM, DEMAND OR ACTION ALLEGING ANY LOSS, INJURY OR DAMAGES, DIRECT OR INDIRECT, WHICH MAY RESULT FROM THE USE OR POSSESSION OF THE INFORMATION; OR FOR ANY LOSS OF PROFIT, REVENUE, CONTRACTS OR SAVINGS, OR ANY OTHER DIRECT, INDIRECT, INCIDENTAL, SPECIAL OR CONSEQUENTIAL DAMAGES ARISING OUT OF YOUR USE OF OR INABILITY TO USE THIS INFORMATION, ANY DEFECT IN THE INFORMATION, OR THE BREACH OF THESE TERMS OR CONDITIONS, WHETHER IN AN

ACTION IN CONTRACT OR TORT OR BASED ON A WARRANTY, EVEN IF NT OR ITS LICENSORS HAVE BEEN ADVISED OF THE POSSIBILITY OF SUCH DAMAGES. Some States, Territories and Countries do not allow certain liability exclusions or damages limitations, so to that extent the above may not apply to you.

Export Control. You agree not to export from anywhere any part of the Data provided to you or any direct product thereof except in compliance with, and with all licenses and approvals required under, applicable export laws, rules and regulations.

Entire Agreement. These terms and conditions constitute the entire agreement between NT (and its licensors, including their licensors and suppliers) and you pertaining to the subject matter hereof, and supersedes in their entirety any and all written or oral agreements previously existing between us with respect to such subject matter.

Governing Law. The above terms and conditions shall be governed by the laws of the State of Illinois, without giving effect to (i) its conflict of laws provisions, or (ii) the United Nations Convention for

Contracts for the International Sale of Goods, which is explicitly excluded. You agree to submit to the jurisdiction of the State of Illinois for any and all disputes, claims and actions arising from or in connection with the Data provided to you hereunder.

Government End Users. If the Data is being acquired by or on behalf of the United States government or any other entity seeking or applying rights similar to those customarily claimed by the United States government, this Data is a “commercial item” as that term is defined at 48 C.F.R. (“FAR”) 2.101, is licensed in accordance with this End User License Agreement, and each copy of the Data delivered or otherwise furnished shall be marked and embedded as appropriate with the following “Notice of Use,” and shall be treated in accordance with such Notice:

NOTICE OF USE

CONTRACTOR (MANUFACTURER/
SUPPLIER) NAME: NAVTEQ
CONTRACTOR (MANUFACTURER/
SUPPLIER) ADDRESS: 425 West Randolph
St., Chicago, Illinois 60606

This Data is a commercial item as defined
in FAR 2.101 and is subject to the End
User License Agreement under which this
Data was provided.

© 2010 NAVTEQ - All rights reserved.

If the Contracting Officer, federal government agency, or any federal official refuses to use the legend provided herein, the Contracting Officer, federal government agency, or any federal official must notify NAVTEQ prior to seeking additional or alternative rights in the Data.

As required by the FCC

1) This device complies with Part 15 of the FCC Rules and Canadian RSS-210/RSS-Gen. Operation is subject to the following two conditions: (1) this device may not cause harmful interference, and (2) this device must accept any interference received, including interference that may cause undesired operation.

2) The FCC requires the user to be notified that any changes or modifications made to this device that are not expressly approved by the party responsible for compliance may void the user's authority to operate the equipment.

3) This product emits radio frequency energy, but the radiated output power of this device is far below the FCC and IC radio frequency exposure limits. This equipment complies with FCC and IC RF radiation exposure limits set forth for an uncontrolled environment. Nevertheless, the device should be used in such a manner that the potential for human contact with the antenna during normal operation is minimized.



Voice Commands

Voice Commands	188
Global Commands	188
Navigation Commands	188
Climate Control Commands	190
Audio Commands	191
Cellular Phone Commands	193
Main Setup Screen Commands	193
On-Screen Commands	194
Spelling Assistance	194
List of Categories	197

Global Commands

The system accepts these commands on any screen.

Help (displays available commands for current screen)

Display map (equivalent to MAP)

Display menu (equivalent to DEST)

Display information (equivalent to INFO)

Display audio screen (equivalent to AUDIO)

Back (equivalent to  (Back))

Cancel (equivalent to CANCEL)

What is today's date?

What time is it?

Navigation Commands

The system accepts these commands on a map/guidance screen.

General Commands

Display menu (if en route, displays the Route screen)

Display navigation (if en route, displays the Route screen)

Display map

Display map guide (when en route, shows the next guidance point)

Display information (or Information)

Display audio screen

Display Traffic List

Cancel

Backward (or Back)

What time is it?

What is today's date?

Help (reads list of General and Map Display Commands)

Map Display Commands

Display current location (shows current latitude, longitude, and elevation)

Display/Hide (specify icon type):

ATM

gas station

restaurant

post office

grocery store

lodging (hotel, motel)

parking garage

parking lot

school

hospital

freeway exit information

traffic

traffic speeds

traffic icons

Go home 1

Go home 2

Register the current location (stores current location in the Address Book)

Map Scale Commands

Display north up

Display heading up

Display zoom in

Display zoom out

Display (specify scale):

1/20 mile (80 m) scale

1/8 mile (200 m) scale

1/4 mile (400 m) scale

1/2 mile (800 m) scale

1 mile (1600 m) scale

2 mile (3 km) scale

5 mile (8 km) scale

15 mile (24 km) scale

50 mile (80 km) scale

150 mile (240 km) scale

350 mile (560 km) scale

1000 mile (1600 km) scale

Max zoom in

Max zoom out

Find Place Commands

Find nearest (specify place):

Auto service center

ACURA dealers

HONDA dealers

Gas station

Hydrogen station

Auto parts & electronics shop

Auto repair & maintenance shop

Car wash & detailing shop

Motorcycle dealers

Other car dealers

Roadside assistance

Banking center

ATM

Bank

Check cashing

Community

Business

City hall

Civic center

Convention center

Court house

Higher education

Library

Post office

School

Emergency room

Hospital

Police station

Veterinarian

Lodging

Bed & breakfast

Hotel

Leisure center

Amusement park

Golf course

Historical monument

Marina

Movie theater

Museum

Park

Performing arts

Sports complex

Tourist attraction

Restaurant

American restaurant

Californian restaurant

Chinese restaurant

Coffee shop

Continental restaurant

Fast food restaurant

French restaurant

German restaurant

Greek restaurant

Ice cream shop
Indian restaurant
Italian restaurant
Japanese restaurant
Korean restaurant
Mexican restaurant
Pizza
Seafood restaurant
Thai restaurant
Vegetarian restaurant
Vietnamese restaurant
Other restaurant
Shopping area
Accessory store
Book store
Clothing store
Furniture store
Grocery store
Home improvement store
Mall
Office supply store
Pharmacy
Pet food store
Sewing store
Shoe store
Sporting goods store
Toy store
Travel center

Airport
Automobile club
Bus station
Camping
Commuter rail station
Ferry terminal
Named place
Park & ride
Parking garage
Parking lot
Rental car agency
Rest area
Ski area
Tourist information
Train station
Travel agency
Truck stop

Route Commands

The system accepts these commands when a route is set.

How long to the destination?
How far to the destination?
Display destination map
Display entire route

Climate Control Commands

The system accepts these commands on most screens.

Climate control automatic (maintains selected temperature)
Climate control off
Air conditioner on
Air conditioner off
Climate control defrost on
Climate control defrost off
Rear defrost on
Rear defrost off
Climate control fresh air
Climate control recirculate
Climate control vent
Climate control bi-level (vent and floor)
Climate control floor
Climate control floor and defrost
Fan speed up
Fan speed down
Fan speed # (#: 1 to 7)
Temperature # degrees (#: 57 to 87 °F)
Driver temperature # degrees (#: 57 to 87 °F)
Temperature up
Temperature down

Temperature max hot
Temperature max cold
Driver temperature max hot
Driver temperature max cold

Audio Commands

The system accepts these commands on most screens.

*Audio**
Audio on
Audio off

* This command toggles the function on and off, so the command may not match your intended action.

NOTE:

Audio volume levels cannot be controlled using voice control.

Radio Commands

*Radio**
Radio on
Radio off
Radio select FM1
Radio select FM2
Radio select AM
Radio tune to # FM (#: frequency, e.g., 95.5)
Radio tune to # AM (#: frequency, e.g., 1020)
Radio seek up
Radio seek down
Radio next station

Radio preset # (#: 1 to 6)
Radio FM preset # (#: 1 to 6)
Radio FM1 preset # (#: 1 to 6)
Radio FM2 preset # (#: 1 to 6)
Radio AM preset # (#: 1 to 6)
*Radio auto select**
*Radio scan**

* These commands toggle the function on and off, so the command may not match your intended action.

■ Disc Commands

DISC play

DISC play track # (#: 1 to 30)

DISC skip forward

DISC skip back

*DISC track random**

*DISC track repeat**

*DISC track scan**

DISC folder up

DISC folder down

*DISC folder random**

*DISC folder repeat**

*DISC folder scan**

DISC normal play (cancels random, repeat, or scan play mode, resumes normal play mode)

- * These commands toggle the function on and off, so the command may not match your intended action.

■ USB Commands

USB play

USB play track # (#: 1 to 30)

USB skip forward

USB skip back

*USB track random**

*USB track repeat**

*USB track scan**

USB folder up

USB folder down

*USB folder random**

*USB folder repeat**

*USB folder scan**

USB normal play (cancels random, repeat, or scan play mode, resumes normal play mode)

- * These commands toggle the function on and off, so the command may not match your intended action.

■ iPod® Commands

iPod play

iPod play track # (#: 1 to 30)

iPod skip forward

iPod skip back

*iPod track shuffle**

*iPod album shuffle**

*iPod track repeat**

iPod normal play (cancels repeat or shuffle play mode, resumes normal play mode)

- * These commands toggle the function on and off, so the command may not match your intended action.

Bluetooth® Audio Commands

Bluetooth audio play
Bluetooth audio skip forward
Bluetooth audio skip back
Bluetooth audio pause
Bluetooth audio resume

NOTE:

Bluetooth® Audio commands may not work on some phones or Bluetooth® audio devices.

AUX Commands

AUX play (or Auxiliary play)

Cellular Phone Commands

The system accepts these commands only on the PHONE screen.

Redial
Call History
Phonebook
Dial
Phone Setup
Phone Menu
Speed Dial 1
Speed Dial 2
More Speed Dial Lists

These commands can be made from any screen.

Dial (Call) by number
Dial (Call) by voice tag

Main Setup Screen Commands

The system accepts these commands on the Main Setup screen.

Brightness up
Brightness down
Brightness minimum/min.
Brightness maximum/max.
Contrast up
Contrast down
Contrast minimum/min.
Contrast maximum/max.
Black level up
Black level down
Black level minimum/min.
Black level maximum/max.
Volume up
Volume down
Volume minimum/min.
Volume maximum/max.
Volume off
Guidance prompts normal
Guidance prompts maximum/max
Guidance prompts minimum/min

On-Screen Commands

The system accepts these commands on any screen. There are over 100 on-screen commands. Say what is written on the screen to activate that selection. For lists, you can say the list item number to select that item.

Next/Previous (get to another page)

Right/Left (get to another tab)

*Up/Down** (get to another page)

Return

OK (excluding Startup Confirmation screen)

Delete

* While driving, you can scroll down the list up to three pages.

Spelling Assistance

The voice control system can also recognize phonetic alphabet input for numbers, letters, accented letters, punctuation marks, and symbols.

NOTE:

When selecting letters using the voice control system, a confirmation box may pop up to confirm the entry.



Say ...	Say ... or Number ...
1	One
2	Two
3	Three
4	Four
5	Five
6	Six
7	Seven
8	Eight
9	Nine
0	Zero

Letters



Say ...	Or say...
A	Alpha/Apple
B	Bravo/Boy
C	Charlie
D	Delta/Dog
E	Echo/Edward
F	Foxtrot/Frank
G	Golf/George
H	Hotel/Henry
I	India/Igloo
J	Juliet/John
K	Kilo/King
L	Lima/Larry
M	Mike/Mary
N	November/Nancy

Say ...	Or say...
O	Oscar
P	Papa/Paul
Q	Quebec/Queen
R	Romeo/Robert
S	Sierra/Sam
T	Tango/Tom
U	Uniform/Uncle
V	Victor
W	Whiskey/William
X	X-ray
Y	Yankee/Yellow
Z	Zulu/Zebra

Accented Letters



Say ...	Say ... or Symbol ...
À	A grave
Â	A circumflex
Ä	A umlaut
Ç	C cedilla
È	E grave
É	E acute
Ê	E circumflex
Ë	E umlaut
Ì	I grave
Î	I circumflex
Ï	I umlaut
Ò	O circumflex
Ù	U grave
Û	U circumflex

Say ...	Say ... or <i>Symbol ...</i>
Ü	U umlaut

■ Symbols



Say ...	Say ... or <i>Symbol ...</i>
@	At sign
^	Caret
*	Asterisk
_	Underscore
`	Back quote
,	Comma
.	Dot





Say ...	Say ... or <i>Symbol ...</i>
?	Question mark
:	Colon
;	Semicolon
+	Plus
-	Hyphen
!	Exclamation point
"	Double quote
#	Pound
\$	Dollar
%	Percent
&	Ampersand
'	Apostrophe
(Open parenthesis
)	Close parenthesis
~	Tilde
/	Slash
<	Less than
>	Greater than
{	Open brace
}	Close brace
↵	Enter

List of Categories

Auto Service		Lodging		Shopping	
All Types (Auto Service)	Car Wash & Detailing	All Types (Lodging)	Hotel/Motel	All Types (Shopping)	Mall/Department Store
Honda Dealers*	Motorcycle Dealers	Bed & Breakfast		Accessories/Jewelry	Office Supplies/Electronics
Acura Dealers*	Other Car Dealers	Leisure		Auto Parts & Electronics	Pet Food/Supplies
Gas Station*	Parking Garage/House	All Types (Leisure)	Museum	Books/Music/Video	Pharmacy/Drug Store
Hydrogen Station	Parking Lot	Amusement Park	Park/Recreation Area	Clothing/Shoes/Bags	Sewing/Linen
Auto Parts & Electronics	Rental Car Agency	Golf Course	Performing Arts	Furniture/Home Furnishing	Sporting Goods
Auto Repair & Maintenance	Roadside Assistance	Historical Monument	Sports Complex	Groceries/Supermarket	Toys/Arts/Crafts
Banking		Marina	Tourist Attraction	Home Improvement	
All Types (Banking)	Check Cashing/Money Transfer	Movie Theater		Travel	
ATM*		Restaurant		All Types (Travel)	Parking Garage/House
Bank		All Types (Restaurant)*	Indian	Airport	Parking Lot
Community		American	Italian	Automobile Club	Rental Car Agency
All Types (Community)	Court House	Café/Coffee Shop	Japanese	Bed & Breakfast	Rest Area
Business	Higher Education	Californian	Korean	Bus Station	Ski Area
City Hall	Library	Chinese	Mexican	Camping	Tourist Attraction
Civic/Community Center	Post Office	Continental	Pizza	Commuter Rail Station	Tourist Information
Convention/Exhibition Center	School	Fast Food	Seafood	Ferry Terminal	Train Station
Emergency		French	Thai	Hotel/Motel	Travel Agency
All Types (Emergency)	Roadside Assistance	German	Vegetarian	Named Place	Truck Stop/Plaza
Hospital*	Veterinarian	Greek	Vietnamese	Park & Ride	
Police Station		Ice Cream/Dessert	Other		

* Stored in "Fav. Subcategory" by factory default.

Symbols

 (Back) Button	5, 20
 (Display Mode) Button	27
 (Hang-Up) Button	5, 155
 (Pick-Up) Button	5, 155, 156
 (Talk) Button	5, 20

A

A.SEL (Auto Select)	117
Add to Address Book	77, 112
Add to Dest. List	77, 106, 110, 111
Address	
Editing Address Book	33
Editing Avoid Area	45
Setting Destination	58
Address Book	
Editing Address Book	31
Setting Destination	63
Address Book PIN	37
Adjust Time	48
Advanced (Place Category)	67
Audio	113
Basic Operation	6
Remote Control	137
Sound Setup	136
Voice Commands List	191
AUDIO Button	4
Audio Menu	
Bluetooth® Audio	135
FM/AM Radio	118
Auto Answer	151
Auto Daylight	47
Auto Service (Place Category)	67

Auto Time Zone	47
Auto Transfer	151
AUX	
Input Jack	114
Voice Commands List	193
Avoid Streets	102

B

Banking (Place Category)	67
Basic Settings	24, 25
Black Level	22
Bluetooth Setup	151
Bluetooth Connection	151
<i>Bluetooth® Audio</i>	
Playing	133
Voice Commands List	193
<i>Bluetooth® HandsFreeLink®</i>	139
Editing Phone Info	150
Making a Call	152
Pairing a Phone	142
Phone Setup	151
Receiving a Call	155
Setting Speed Dials	147
Brightness	22, 27

C

Call	
Calculate Route Screen	77, 112
Call History	154
Cancel Route	102

Category

Editing Address Book	33
Place Category List	197
Setting Destination	67
CD/AUX Button	6, 121, 126, 130, 133
CH (Channel) Button	138
Change Language	18
Change Route Preference	78
Change State	59
City	60
City Vicinity	
Setting Destination	68
Clear All Speed Dial	54
Clock Adjustment	47
Adjust Time	48
Auto Daylight	47
Auto Time Zone	47
Clock Format	47
Resetting	48
Clock Format	47
Clock Type	49
Color	25
Map Color	26
Menu Color	26
Community (Place Category)	67
Connect (Phone)	150
Continue Trip	112
Contrast	22
Coordinate	73
Correct Vehicle Position	52
Current Location	98
Current Position	
Editing Address Book	33
Setting Destination	75

D

Day Mode	
Map Color	26
Menu Color	26
Switching Display Mode	27
Delete this Phone	145
DEST Button	
Changing Route	101
Entering a Destination	56
DEST Menu 1	56
DEST Menu 2	56
Destination Map	79
Detour	102
Dial	153
Directions	88
Disc	
Playing	121
Voice Commands List	192
Display Voice Command Tips	24

E

Edit Avoid Area	44
Edit Speed Dial	147
Edit Waypoint Search Area	46
Emergency (Place Category)	67
Error Messages	171
Disc Player	172
iPod®	173
Navigation System	171
USB Flash Drive	174
Exit Info	89

F

Favorite Subcategory	69
Find Nearest...	108
FM/AM Button	6, 116
FM/AM Radio	
Playing	116
Voice Commands List	191
Folder List	
Disc	123
USB Flash Drive	132

G

Go Home 1	10
Go Home 1 PIN	37
Go Home 2	10
Go Home 2 PIN	37
Guidance Menu	87
Directions	88
Exit Info	89
Guidance Mode	90
Guidance Mode	90
Guidance Prompts	23

H

Heading-up	97
Home Address 1	10, 36
Home Address 2	10, 36
Honda Customer Services	180

I

Icon Option	93
Intersection	74
iPod®	
Connecting, Disconnecting	125
Playing	125
Voice Commands List	192

K

Keyboard Layout	24
-----------------	----

L

Language	29
Leisure (Place Category)	67
Lodging (Place Category)	67

M

Map Color	26
Map Input	
Editing Avoid Area	45
Setting Destination	75
Map Legend	7, 94
Map Menu	85
Map Screen	80
Icon	7, 92, 96
Orientation	97
Scale	95
Map Update	
Checking Version	161
Obtaining Update Data	181
Viewing Update Status	161

MAP/GUIDE Button	8, 90	Phone Setup	140	Reset Clock Settings	48
Menu (DEST Menu 1)	56	Phonebook		Reset Factory Default	53
Menu (DEST Menu 2)	56	Making a Call	152	Restaurant (Place Category)	67
Menu (Route)	101	PIN Numbers		Route (Menu)	101
Menu Color	26	Personal Info	37	Route Pref.	78
MODE Button	137	Phone	150	Routing & Guidance	40
Music Search		Place Category			
iPod®	128	Editing Address Book	33		
Mute	155	Place Category List	197		
My Destination		Setting Destination	67		
Adding Waypoint	103	Place Name			
Editing	107	Editing Address Book	33		
		Setting Destination	65, 68		
N		Place Phone No.			
Night Mode		Editing Address Book	33		
Map Color	26	Setting Destination	72		
Menu Color	26	Previous Destination			
Switching Display Mode	27	Deleting	39		
North-up	97	Editing Address Book	33		
		Setting Destination	64		
O		R			
Off-road Tracking		Radio			
Driving	83	FM/AM	116		
Setting	51	Random (Pairing Code)	144		
		RDS Search	119		
P		Read Radio Text	120		
Pair Phone	142	Rearview Camera	162		
Pairing Code	144	Recalculation	41, 83		
Personal Information	30	Repeat			
Phone		iPod®	127		
Voice Commands List	193	USB Flash Drive	132		
PHONE Button	4	Replace this Phone	150		
		Rerouting	41		
				S	
				Scan	
				Disc	122
				FM/AM Radio	117
				USB Flash Drive	131
				Search by Keyword	68
				Security PIN Code	176
				SEEK/SKIP Button	4
				Shopping (Place Category)	67
				Show icon on Map	92
				Single Screen	90
				Sort by Distance to Travel	68
				Sound Setup	136
				Speed Dial	
				Making a Call	154
				Registering	147
				Split Screen	91
				Street	61
				System/Device Information	161
				T	
				Touch Tones	155
				Traffic Detail	99
				Traffic Rerouting	99
				Transfer Call	155
				Travel (Place Category)	67

Trip Computer 160
 Tune
 FM/AM Radio 117

U

Units (mile or km) 24
 Unverified Area Routing 42
 Update System Software
 Finding Update Information 181
 Obtaining Update Data 181
 USB Flash Drive
 Connecting, Disconnecting 129
 Playing 129
 Voice Commands List 192

V

Vehicle 50
 Correct Vehicle Position 52
 Off-road Tracking 51
 Verbal Reminder 25
 View Area Map 44
 View Routes 78
 Voice
 Map Menu 84
 Voice Commands
 Basic Operation 9
 Help 13
 Voice Commands List 188
 Voice Control System 20
 Voice Control Operation
 Basic Operation 5
 Voice Recognition Tutor 24

Voice Tag 148
 Editing 149
 Registering 148
 VOL (Volume) Button 138
 VOL  (Volume/Power) Knob 6
 Volume 22
 Guidance 22
 Phone 151

W

Waypoint
 Adding 103
 Deleting, Ordering 107

Z

ZOOM IN/OUT Button 4, 95