

OWNERS INSTALLATION MANUAL SWIM SPAS

REVISED 2014/08



www.pdcspas.com

PDC SPAS OWNER'S MANUAL



CONGRATULATIONS ON CHOOSING A QUALITY PDC SWIM SPA FOR YOUR BACKYARD RELAXATION!

PLEASE READ THE OWNER'S MANUAL COMPLETELY BEFORE INSTALLING AND USING YOUR NEW SWIM SPA. THE PURPOSE OF THIS MANUAL IS TO PROVIDE YOU WITH SAFETY, OPERATIONAL AND INSTALLATION INFORMATION WHICH WILL ALLOW YOU THE FULLEST ENJOYMENT OF THIS FINE PRODUCT.

AT THE TIME OF PRINTING, THIS MANUAL WAS DEEMED AS ACCURATE AS POSSIBLE. PDC SPAS RESERVES THE RIGHT TO CHANGE PRODUCT IN AN EFFORT TO ENHANCE AND IMPROVE, WITHOUT PRIOR NOTICE. TO BE AWARE OF ANY OF THESE POSSIBLE CHANGES, LOG ON TO WWW.PDCSPAS.COM, REFERRING TO THE CUSTOMER CARE SECTION, OR CONTACT YOUR RETAILER DIRECTLY.

OWNERSHIP INFORMATION

NAME _____

ADDRESS _____

INSTALLATION DATE ____ / ____ / ____

MODEL NAME _____

SERIAL # _____

RETAILER NAME _____

RETAILER PHONE NUMBER _____

SERVICE TECHNICIAN CONTACT INFO _____

SERIAL # LOCATION

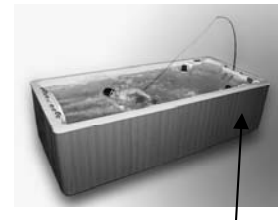

THE SERIAL NUMBER CAN BE FOUND INSIDE THE SPA SKIRTING ON THE FIBERGLASS UNDER THE TOPSIDE CONTROL.

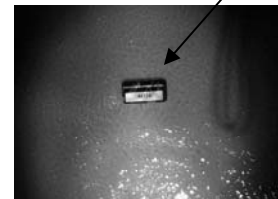

IMMEDIATELY UPON DELIVERY REGISTER YOUR HOT TUB ON THE PDC SPAS WEB SITE WWW.PDCSPAS.COM

THIS INFORMATION IS VERY IMPORTANT TO ENSURE WARRANTY COVERAGE AND RECEIVE INFORMATION FOR POSSIBLE PRODUCT UPDATES.

SAVE THIS MANUAL FOR FUTURE REFERENCE !



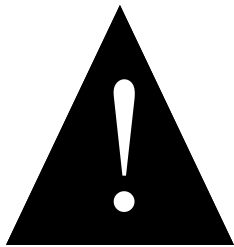

WARNING!

**REPLACE ALL
SAFETY SUCTION COVERS
EVERY 7 YEARS.**

**REPLACE WITH SIMILAR
VGB APPROVED FITTINGS
AT SAME OR HIGHER
FLOW RATINGS.**

**REPLACEMENT
APPLIES TO
ALL SWIM SPA MODELS.**

! DANGER



**NO DIVING - NO JUMPING
DIVING OR JUMPING INTO THE SWIM SPA MAY
CAUSE PARALYSIS, PERMANENT INJURY OR
DEATH.**

HOW TO PREVENT DIVING/JUMPING ACCIDENTS

- Swim Spa is shallow water depth, it is classified as Non-Diving & No Jumping
- Never Dive or Jump into Swim Spa Under Any Circumstances
- Never Walk, Stand or Sit on Top Rail of Swim Spa as Surfaces are Slippery
- Do Not Utilize Sliding Equipment with this Swim Spa
- Do Not Utilize Diving Equipment with this Swim Spa

HOW TO PREVENT CHILD DROWNING ACCIDENTS

- Children Must be Closely & Constantly Supervised When Using This Pool/Aquatic Fitness System
- Children Must Not Be Allowed in the Swim Spa Area Without a Responsible Adult Being Present
- All Gates & Spa Covers Must Be in Place & Locked When the Swim Spa is Not Being Used or When a Responsible Adult is Not Present
- All Portable Ladders and Stairs Must Be Removed or Secured to Prevent Entry to the Swim Spa When Not In Use
- Limited Access Ladders Must Be Removed or Latched in the Upraised Position When Not In Use

HOW TO PREVENT OTHER ACCIDENTS

- Do Not Swim Alone
- Always have a Responsible Adult Present Who is Capable of Helping the Swim Spa User in Case of an Accident, Injury or Other Emergency Situation
- Non Swimmers Should Always Be Closely Supervised & Should Wear an Approved Flotation Device

**DO NOT REMOVE WARNING LABEL FROM SPA.
ALWAYS ATTACH & LOCK YOUR COVER AFTER USE**

TABLE OF CONTENTS



IMPORTANT SAFETY INSTRUCTIONS WARNINGS, INSTRUCTIONS FOR ALL SWIM SPA MODELS	1-6
SWIM SPA USE LABELS LOCATION AND REFERENCE	7
SWIM SPA PARTS IDENTIFICATION	8-11
FX SERIES SPAS SPECIFICATIONS	12-21
SWIM SPA INSTALLATION SWIM SPA LOCATION CONSIDERATIONS, INDOORS AND OUTDOORS GENERAL LOCATION CONSIDERATIONS INSTALLATION INSTRUCTIONS INSTALLING THE THERMAL COVER	22,23 24 25 26
WIRING INSTALLATION WIRING RECOMMENDATIONS U.S. –STATE-SIDE GUIDELINES EXPORT, IN.XM CE PLATFORM EXPORT, IN. XE CE PLATFORM DUAL HEATER	27 28 29, 30 31 32, 33
INITIAL START-UP GENERAL GUIDELINES	34
OPERATION SYSTEMS IN.K 600 CONTROL IN.K 450 CONTROL	35-37 38, 39
AQUAFLEX TETHERED EXERCISE SYSTEM	40
WATER CHEMISTRY GUIDELINES	41-43
MAINTENANCE RECOMMENDATIONS	44-46
WINTERIZING YOUR HOT TUB	47
TROUBLESHOOTING	48
RECORDS OF SWIM SPA CARE	49



PLASTIC DEVELOPMENT COMPANY, INC.
75 PALMER INDUSTRIAL ROAD
WILLIAMSPORT, PA 17701 USA
570-323-3060 TEL 570-323-8485 FAX
WWW.PDCSPAS.COM

SAFETY INSTRUCTIONS



YOU NOW OWN A HIGH QUALITY PDC SWIM SPA BUILT FOR YEARS OF ENJOYMENT AND RELAXATION. IT IS OF PRIME IMPORTANCE THAT YOU UNDERSTAND THE OPERATION OF YOUR SWIM SPA AND ENJOY IT WITH SAFETY IN MIND. YOU SHOULD READ THIS MANUAL THOROUGHLY AND UNDERSTAND ALL OF THE SAFETY PRECAUTIONS. USING YOUR SWIM SPA WITHIN THESE GUIDELINES ASSURES YEARS OF FUN AND RELAXATION GAINED FROM ADDING A PDC SWIM SPA TO YOUR LIFESTYLE.

WARNING

THIS UNIT IS A PROFESSIONAL-GRADE PRODUCT. A KNOWLEDGE OF CONSTRUCTION TECHNIQUES, PLUMBING AND ELECTRICAL INSTALLATION ACCORDING TO CODES ARE REQUIRED FOR PROPER INSTALLATION AND USER SATISFACTION. IT IS RECOMMENDED THAT A LICENSED CONTRACTOR PERFORM THE INSTALLATION. WARRANTY IS VOIDED FOR IMPROPER INSTALLATION RELATED ISSUES.

SAVE THESE INSTRUCTIONS

INCLUDED WITH THIS MANUAL IS A SAFETY SIGN THAT IS TO BE POSTED NEAR THE SWIM SPA WHERE ALL OCCUPANTS CAN EASILY READ. THIS SIGN IS INTENDED FOR YOU AND YOUR GUEST'S PROTECTION, SAFETY AND TO ASSURE THEIR SWIM SPA ENJOYMENT. TAKE THE TIME TO POINT OUT THE LOCATION OF THE SIGN AND INDICATE THE IMPORTANCE OF THE PRECAUTIONS.

ADHERE THE SIGN WITH SCREWS OR ANOTHER MANNER OF PERMANENT ADHESION. SHOULD YOU REQUIRE ADDITIONAL COPIES OR REPLACEMENTS, SIMPLY CONTACT THE FACTORY DIRECTLY OR YOUR NEAREST RETAILER.

SAFETY INSTRUCTIONS



READ AND FOLLOW ALL IMPORTANT SAFETY INSTRUCTIONS

WHEN INSTALLING AND USING THIS EQUIPMENT BASIC SAFETY PRECAUTIONS SHOULD ALWAYS BE TAKEN TO REDUCE THE RISK OF ELECTRICAL SHOCK, TO ENSURE SAFE USAGE, AND TO SAFEGUARD THE USER'S HEALTH.

READ AND FOLLOW ALL INSTRUCTIONS!!

THIS UNIT IS A PROFESSIONAL-GRADE PRODUCT. A KNOWLEDGE OF CONSTRUCTION TECHNIQUES, PLUMBING AND ELECTRICAL INSTALLATION ACCORDING TO CODES ARE REQUIRED FOR PROPER INSTALLATION AND USER SATISFACTION. IT IS RECOMMENDED THAT A LICENSED CONTRACTOR PERFORM THE INSTALLATION. WARRANTY IS VOIDED FOR IMPROPER INSTALLATION RELATED ISSUES.

IT IS THE RESPONSIBILITY OF THE HOME OWNER TO ENSURE THAT ALL USERS OF THE SWIM SPA ARE ADEQUATELY INFORMED OF ALL PRECAUTIONS.

USE THE SWIM SPA ONLY AS DESCRIBED IN THIS MANUAL. THE SWIM SPA IS INTENDED FOR HOME USE ONLY. DO NOT USE THE SWIM SPA IN A COMMERCIAL OR RENTAL SETTING. ALL WARRANTIES WILL BE VOIDED.

GROUND ALL METAL ELECTRICAL EQUIPMENT

- A GREEN COLORED TERMINAL OR A TERMINAL MARKED G, GR, GROUND, OR GROUNDING, IS LOCATED INSIDE THE SUPPLY TERMINAL BOX OR COMPARTMENT. THIS TERMINAL MUST BE CONNECTED TO THE GROUNDING MEANS PROVIDED IN THE ELECTRIC SUPPLY SERVICE PANEL, USING A CONTINUOUS COPPER WIRE EQUIVALENT IN SIZE TO THE CIRCUIT CONDUCTORS SUPPLYING THIS EQUIPMENT. *ACCORDING TO, BUT NOT LIMITED TO: NEC, NFPA 70, SECTION 680.40, UL 1563.
- AT LEAST TWO LUGS MARKED "BONDING LUGS" ARE PROVIDED ON THE EXTERNAL SURFACE OR ON THE INSIDE OF THE SUPPLY TERMINAL BOX OR COMPARTMENT. CONNECT THE LOCAL COMMON BONDING GRID (HOUSEHOLD GROUND) IN THE AREA OF THE SWIM SPA TO THESE TERMINALS, USING AN INSULATED OR BARE COPPER CONDUCTOR NOT SMALLER THAN No. 6 AWG.
- ALL FIELD-INSTALLED METAL COMPONENTS SUCH AS RAILS, LADDERS, DRAINS OR SIMILAR HARDWARE LOCATED WITHIN 5 FEET OF THE SWIM SPA OR HOT TUB MUST BE BONDED TO THE EQUIPMENT GROUNDING BUS WITH COPPER CONDUCTORS NOT SMALLER THAN No. 6 AWG.
- ALL METAL SURFACES WITHIN 5 FEET OF THE SWIM SPA MUST BE BONDED TO THE HOME BONDING GRID.

GROUND FAULT CIRCUIT INTERRUPTER PROTECTION (OR EQUIVALENT; RCD, FOR EXPORT INSTALLS)

- ALL PDC SPAS ARE PERMANENTLY INSTALLED UNITS. **GROUND FAULT CIRCUIT INTERRUPTER PROTECTION IS REQUIRED.** ALL SWIM SPA EQUIPMENT SYSTEMS MUST BE PROTECTED BY A CLASS A GROUND FAULT CIRCUIT INTERRUPTER (GFCI) OR EQUIVALENT; RCD, FOR EXPORT INSTALLS. A GROUND FAULT CIRCUIT INTERRUPTER TYPE CIRCUIT BREAKER (NOT SUPPLIED) MUST BE INSTALLED IN THE HOME PANEL BOX BY A LICENSED ELECTRICIAN WHEN MAKING WIRE CONNECTION TO THE SWIM SPA SUPPORT PACK EQUIPMENT.

DANGER: RISK OF ELECTRICAL SHOCK:

- INSTALL THE SWIM SPA AT LEAST FIVE FEET (1.52 M) FROM ALL UNGROUNDED (UNBOUNDED) METAL SURFACES.
- GROUND FAULT CIRCUIT INTERRUPTER PROTECTION OF THE HOME POWER SUPPLY TO THE SWIM SPA IS NECESSARY. YOUR ELECTRICIAN SHOULD EXPLAIN HOW IT WORKS. (SEE SWIM SPA MAINTENANCE)
- DO NOT PERMIT ANY ELECTRIC APPLIANCE, SUCH AS A LIGHT, TELEPHONE, RADIO OR TELEVISION, WITHIN FIVE FEET (1.52 M) OF A SWIM SPA. KEEP ELECTRICAL APPLIANCES AND EXTENSION CORDS AWAY FROM THE SWIM SPA. WATER IS A CONDUCTOR OF ELECTRICITY.

DANGER: RISK OF ACCIDENTAL DROWNING.

- EXTREME CAUTION MUST BE EXERCISED TO PREVENT UNAUTHORIZED ACCESS BY CHILDREN. TO AVOID ACCIDENTS, ENSURE THAT CHILDREN CANNOT USE A SWIM SPA UNLESS THEY ARE SUPERVISED AT ALL TIMES.

SAFETY INSTRUCTIONS



DANGER: TO REDUCE THE RISK OF DROWNING:

1. NEVER USE THE SWIM SPA ALONE.
2. CHILDREN SHOULD NOT USE THE SWIM SPA UNLESS THEY ARE SUPERVISED BY AN ADULT
3. KEEP PETS AWAY FROM THE SWIM SPA AT ALL TIMES.
4. ALWAYS REPLACE AND LOCK THE SWIM SPA COVER WHEN THE SWIM SPA IS NOT IN USE.

DANGER: TO REDUCE THE RISK OF DROWNING

- **PROLONGED IMMERSION IN THE SWIM SPA MAY CAUSE HYPERTHERMIA. THE CAUSES, SYMPTOMS AND EFFECTS OF HYPERTHERMIA MAY BE DESCRIBED AS FOLLOWS: HYPERTHERMIA OCCURS WHEN THE INTERNAL TEMPERATURE OF THE BODY REACHES A LEVEL SEVERAL DEGREES ABOVE THE NORMAL BODY TEMPERATURE OF 98.6 °F (37°C). THE SYMPTOMS OF HYPERTHERMIA INCLUDE AN INCREASE IN THE INTERNAL TEMPERATURE OF THE BODY, DIZZINESS, LETHARGY, DROWSINESS, AND FAINTING. THE EFFECTS OF HYPERTHERMIA INCLUDE:**
 1. FAILURE TO PERCEIVE HEAT
 2. FAILURE TO RECOGNIZE THE NEED TO EXIT THE SWIM SPA
 3. UNAWARENESS OF IMPENDING HAZARD
 4. FETAL DAMAGE IN PREGNANT WOMEN
 5. PHYSICAL INABILITY TO EXIT THE SWIM SPA
 6. UNCONSCIOUSNESS RESULTING IN THE DANGER OF DROWNING

DANGER: RISK OF INJURY

- **DO NOT REMOVE THE SUCTION FITTINGS. THE SUCTION FITTING IN THIS SWIM SPA IS SIZED TO MATCH THE SPECIFIC WATER FLOW CREATED BY THE PUMP. SHOULD THE NEED ARISE TO REPLACE THE SUCTION FITTING OR THE PUMP, BE SURE THAT THE FLOW RATES ARE COMPATIBLE. NEVER OPERATE THE SWIM SPA IF THE SUCTION FITTING IS BROKEN OR MISSING. NEVER REPLACE A SUCTION FITTING WITH ONE RATED LESS THAN THE FLOW RATE MARKED ON THE ORIGINAL SUCTION FITTING.**

DANGER: RISK OF ACCIDENTAL DROWNING

- **KEEP HAIR AND BODY PARTS AWAY FROM THE SUCTION GUARD. DO NOT ALLOW LONG HAIR TO FLOAT FREELY IN THE WATER; LONG HAIR SHOULD BE RESTRAINED WITH A BATHING CAP. TO REDUCE THE RISK OF DROWNING FROM HAIR OR BODY ENTRAPMENT, INSTALL A SUCTION FITTING (S) WITH A MARKED FLOW RATE IN GALLONS PER MINUTE THAT EQUALS OR EXCEEDS THE FLOW RATE MARKED ON THE EQUIPMENT ASSEMBLY, IF REPLACEMENT OF SUCTION FITTINGS BECOMES NECESSARY.**

WARNING

- **GROUND FAULT CIRCUIT INTERRUPTER PROTECTION (GFCI) OR EQUIVELANT; RCD, FOR THE SWIM SPA SHOULD BE TESTED PRIOR TO EACH USE BY THE HOMEOWNER. WITH THE SWIM SPA IN OPERATION, PUSH THE "TEST" BUTTON ON THE GFCI CIRCUIT BREAKER AT THE PANEL BOX. THE SWIM SPA SHOULD SHUT DOWN IMMEDIATELY. NOW RESET THE GFCI. THE SWIM SPA SHOULD RETURN TO NORMAL OPERATION. IF THE GFCI FAILS TO OPERATE IN THIS MANNER, THERE EXISTS A POSSIBILITY OF ELECTRICAL SHOCK. APPROVED TESTING APPLIES FOR EXPORT PROTECTION DEVICES, I.E. RCD.**
- **DISCONTINUE SWIM SPA OPERATION BY DISCONNECTING THE POWER SOURCE AND NOTIFY A QUALIFIED ELECTRICIAN FOR IDENTIFICATION AND CORRECTION OF THE PROBLEM.**

WARNING

- **TO REDUCE THE RISK OF INJURY, DO NOT PERMIT CHILDREN TO USE THIS PRODUCT UNLESS THEY ARE CLOSELY SUPERVISED AT ALL TIMES.**

SAFETY INSTRUCTIONS



WARNING: TO REDUCE THE RISK OF INJURY

- **THE WATER IN A SWIM SPA SHOULD NEVER EXCEED 104°F (40° C). WATER TEMPERATURES BETWEEN 100° F (38° C) AND 104° F (40° C) ARE CONSIDERED SAFE FOR A HEALTHY ADULT. LOWER WATER TEMPERATURES ARE RECOMMENDED FOR EXTENDED USE (EXCEEDING 10 TO 15 MINUTES) AND FOR YOUNG CHILDREN. NEVER EXERCISE OR SWIM IN WATER ABOVE 90°F (32°C).**
- **EXCESSIVE WATER TEMPERATURES HAVE A HIGH POTENTIAL FOR CAUSING FETAL DAMAGE DURING THE EARLY MONTHS OF PREGNANCY. PREGNANT OR POSSIBLY PREGNANT WOMEN SHOULD LIMIT SWIM SPA TEMPERATURES TO 100° F (38° C).**
- **BEFORE ENTERING A SWIM SPA, THE USER SHOULD MEASURE THE WATER TEMPERATURE WITH AN ACCURATE THERMOMETER SINCE THE TOLERANCE OF WATER TEMPERATURE REGULATING DEVICES MAY VARY AS MUCH AS 5° F (3°C).**
- **THE USE OF ALCOHOL, DRUGS, OR MEDICATION BEFORE OR DURING SWIM SPA USE MAY LEAD TO UNCONSCIOUSNESS WITH THE POSSIBILITY OF DROWNING.**
- **PERSONS SUFFERING FROM OBESITY OR WITH A MEDICAL HISTORY OF HEART DISEASE, LOW OR HIGH BLOOD PRESSURE, CIRCULATORY SYSTEM PROBLEMS, OR DIABETES SHOULD CONSULT A PHYSICIAN BEFORE USING A SWIM SPA.**
- **ALWAYS CONSULT WITH A PHYSICIAN PRIOR TO BEGINNING ANY EXERCISE REGIMEN . DO NOT OVEREXERT YOURSELF. TAKE FREQUENT BREAKS.**
- **PERSONS USING MEDICATION SHOULD CONSULT A PHYSICIAN BEFORE USING A SWIM SPA SINCE SOME MEDICATION MAY INDUCE DROWSINESS WHILE OTHER MEDICATION MAY AFFECT HEART RATE, BLOOD PRESSURE, AND CIRCULATION.**
- **ENTER AND LEAVE SWIM SPA SLOWLY AND WITH CAUTION. SURFACES AROUND SWIM SPA WILL BE WET AND SLIPPERY.**

WARNING

1. **NEVER USE THE SWIM SPA ALONE.**
2. **DO NOT BRING ANY OBJECT INTO THE SWIM SPA THAT COULD DAMAGE THE SWIM SPA SHELL.**
3. **DO NOT SIT ON SWIM SPA COVER OR PLACE OBJECTS ON IT; IT IS NOT DESIGNED TO SUPPORT WEIGHT.**
4. **REMOVE ANY WATER OR DEBRIS THAT MAY COLLECT ON THE SWIM SPA COVER.**
5. **KEEP ALL CHEMICALS AWAY FROM CHILDREN AND PETS.**
6. **THE PH AND CHEMICAL BALANCE OF THE WATER MUST BE MAINTAINED AS EXPLAINED IN THIS MANUAL. FAILURE TO DO SO MAY CAUSE INJURY TO USERS OR DAMAGE TO THE SWIM SPA, AND WILL VOID YOUR WARRANTY.**

WARNING: HEALTH CONSIDERATIONS

- **THE USE OF ALCOHOL, DRUGS, MEDICATION CAN GREATLY INCREASE RISK OF FATAL HYPERTHERMIA.**
- **INDIVIDUALS WITH INFECTIONS AND OPEN SORES OR WOUNDS SHOULD NOT USE THE SWIM SPA. BACTERIA THRIVE IN WARM AND HOT WATER. ALWAYS KEEP YOUR SWIM SPA DISINFECTED AND MAINTAIN THE PROPER CHEMICAL BALANCE.**
- **SHOWER BEFORE AND AFTER USING THE SWIM SPA. THIS WILL REMOVE ANY DEODORANT, PERSPIRATION, OR BODY OILS THAT COULD CONTAMINATE THE WATER. SHOWERING AFTER WILL REMOVE ANY RESIDUAL CHEMICALS AND ANY BACTERIA THAT MAY HAVE BEEN IN THE SWIM SPA.**

SAFETY INSTRUCTIONS



- **DO NOT USE THE SWIM SPA IMMEDIATELY AFTER STRENUOUS EXERCISE.**
- **IF YOU FEEL PAIN OR DIZZINESS AT ANY TIME WHILE USING THE SWIM SPA, DISCONTINUE USE AND CONTACT A PHYSICIAN.**

WARNING: TO REDUCE THE RISK OF INJURY

- **IT IS ESPECIALLY IMPORTANT FOR PERSONS OVER THE AGE OF 35 OR PERSONS WITH PRE-EXISTING HEALTH PROBLEMS, SUCH AS OBESITY, HEART DISEASE, HIGH BLOOD PRESSURE, CIRCULATORY PROBLEMS, OR DIABETES TO CONSULT THEIR PHYSICIAN BEFORE USING THE SWIM SPA.**
- **THE SWIM SPA JETS PRODUCE A STREAM OF WATER WITH RELATIVELY HIGH PRESSURE. PROLONGED EXPOSURE OF A LOCALIZED AREA OF THE BODY MAY CAUSE BRUISES TO THE SKIN.**
- **NEVER INSERT ANY OBJECT INTO ANY OPENING.**
- **DO NOT USE BREAKABLE CONTAINERS IN OR NEAR THE SWIM SPA.**

WARNING: ELECTRICAL CONSIDERATIONS

- **FOR CONTROLS OTHER THAN UNDERWATER LIGHTING CIRCUITS: A GROUND FAULT CIRCUIT INTERRUPTER (OR EQUIVALENT FOR EXPORT INSTALLS) MUST BE PROVIDED IF THIS DEVICE IS USED TO CONTROL AN UNDERWATER LIGHTING FIXTURE. THE CONDUCTORS ON THE LOAD SIDE ON THE GROUND FAULT CIRCUIT INTERRUPTER SHALL NOT OCCUPY CONDUIT, BOXES, OR ENCLOSURES CONTAINING OTHER CONDUCTORS UNLESS THE ADDITIONAL CONDUCTORS ARE ALSO PROTECTED BY A GROUND FAULT CIRCUIT INTERRUPTER (OR EQUIVALENT FOR EXPORT INSTALLS).**
- **THE ELECTRICAL SUPPLY FOR THIS PRODUCT MUST INCLUDE A SUITABLY RATED SWITCH OR CIRCUIT BREAKER TO OPEN ALL UNDERGROUND SUPPLY CONDUCTORS TO COMPLY WITH SECTION 422-20 OF THE U.S. NATIONAL ELECTRIC CODE. THE DISCONNECTING MEANS MUST BE READILY ACCESSIBLE TO THE TUB OCCUPANT BUT INSTALLED AT LEAST 5 FT (1.5 M) FROM THE SWIM SPA WATER.**

WARNING: FOR SWIM SPAS WITH AUDIO / VIDEO COMPONENTS

1. **CAUTION - RISK OF ELECTRIC SHOCK. DO NOT LEAVE COMPARTMENT DOOR OPEN.**
2. **CAUTION - RISK OF ELECTRIC SHOCK. REPLACE COMPONENTS ONLY WITH IDENTICAL COMPONENTS; AND,**
3. **DO NOT OPERATE THE AUDIO/VIDEO CONTROLS WHILE INSIDE THE SWIM SPA.**
4. **WARNING - PREVENT ELECTROCUTION. DO NOT CONNECT ANY AUXILIARY COMPONENTS (FOR EXAMPLE CABLE, ADDITIONAL SPEAKERS, HEADPHONES, ADDITIONAL AUDIO/VIDEO COMPONENTS, ETC.) TO THE SYSTEM.**
5. **THESE UNITS ARE NOT PROVIDED WITH AN OUTDOOR ANTENNAE; WHEN PROVIDED, IT SHOULD BE INSTALLED IN ACCORDANCE WITH ARTICLE 810 OF THE U.S. NATIONAL ELECTRICAL CODE, ANSI/NFPA 70.**
6. **DO NOT SERVICE THIS PRODUCT YOURSELF AS OPENING OR REMOVING COVERS MAY EXPOSE YOU TO DANGEROUS VOLTAGE OR OTHER RISK OF INJURY. REFER ALL SERVICING TO QUALIFIED SERVICE PERSONNEL.**
7. **WHEN THE POWER SUPPLY CONNECTION OR POWER SUPPLY CORD(S) ARE DAMAGED; IF WATER IS ENTERING THE AUDIO/VIDEO COMPARTMENT OR ANY ELECTRICAL EQUIPMENT COMPARTMENT AREA; IF THE PROTECTIVE SHIELDS OR BARRIERS ARE SHOWING SIGNS OF DETERIORATION; OR IF THERE ARE SIGNS OF OTHER POTENTIAL DAMAGE TO THE UNIT, TURN OFF THE UNIT AND REFER SERVICING TO QUALIFIED SERVICE PERSONNEL.**
8. **THIS UNIT SHOULD BE SUBJECTED TO PERIODIC ROUTINE MAINTENANCE (FOR EXAMPLE, ONCE EVERY 3 MONTHS) TO MAKE SURE THAT THE UNIT IS OPERATING PROPERLY.**

SAFETY INSTRUCTIONS**ADDITIONAL SAFETY CONSIDERATIONS**

- **INSTALL THE SWIM SPA TO PROVIDE DRAINAGE FOR COMPARTMENTS OF ELECTRICAL COMPONENTS.**
- **FOR FLOOR RECESSED SWIM SPAS: INSTALL TO PERMIT ACCESS FOR SERVICING FROM ABOVE OR BELOW THE FLOOR. SWIM SPA EQUIPMENT MUST BE INSTALLED BELOW WATER LEVEL.**
- **WHEN PLANNING YOUR SWIM SPA INSTALLATION SITE, PREPARE FOR THE UNLIKELY EVENT OF RAPID SWIM SPA DRAINAGE.**
- **DO NOT PLACE SWIM SPA IN DIRECT SUNLIGHT WHILE UNIT IS EMPTY OR WHEN SEALED IN SHIPPING MATERIALS. EXCESSIVE HEAT BUILD MAY CAUSE DAMAGE TO SWIM SPA AND VOID WARRANTY.**
- **WHEN INSTALLING SWIM SPA, ALLOW AMPLE SPACE FOR FUTURE SERVICING, NOTING LOCATION OF ALL SUPPORT EQUIPMENT PER THE MODEL SPECIFICATIONS.**

SAVE THESE INSTRUCTIONS



PDC SPAS
75 PALMER INDUSTRIAL ROAD
WILLIAMSPORT, PA 17701 USA
570-323-3060 TEL 570-323-8485 FAX
WWW.PDCSPAS.COM

SWIM SPA USE LABELS



A CABINET PANEL WARNING AND DANGER SIGNS

FOR YOUR REFERRAL AND CONVENIENCE, A WEATHER RESISTANT WARNING SIGN HAS BEEN MOUNTED ON THE CABINET SIDE OF YOUR PORTABLE SWIM SPA. BECOME FAMILIAR WITH THE PRECAUTIONS AND EXERCISE SAFETY AND CARE WHILE ENJOYING YOUR SWIM SPA. NOTIFY THE FACTORY OR YOUR RETAILER SHOULD YOU REQUIRE ADDITIONAL SIGNS OR REPLACEMENTS.

ENCLOSED WARNING AND DANGER SIGNS FOR POSTING

LOCATE THE WEATHER RESISTANT SIGN ENCLOSED WITH THIS MANUAL INTENDED FOR PERMANENT POSTING IN AN AREA NEAR THE SWIM SPA VISIBLE TO ALL SWIM SPA OCCUPANTS. NOTIFY THE FACTORY OR YOUR RETAILER SHOULD YOU REQUIRE ADDITIONAL SIGNS OR REPLACEMENTS.



A PROPERTY DAMAGE SUSTAINED

WARNING: READ ALL INSTRUCTIONS BEFORE USING THE SWIM SPA. PDC SPAS ASSUMES NO RESPONSIBILITY FOR PERSONAL INJURY OR BY OR THROUGH THE USE OF THIS PRODUCT.

SAVE THIS MANUAL, SIGNS, AND INSTRUCTIONS FOR FUTURE REFERENCE.

SWIM SPA PARTS IDENTIFICATION



SWIM SPA PART TERMINOLOGY AND DESCRIPTION

HYDRO-JETS: THE WALL FITTINGS AROUND THE INSIDE PERIMETER OF THE SWIM SPA WHICH MIX WATER WITH AIR TO PRODUCE LOCALIZED THERAPY, IN A STRAIGHT STREAM, CIRCULAR MOTION, OR IN RANDOM PATTERNS FOR MASSAGE IN THE LOUNGE AND CONTOURED SEATING AREAS.



SWIM JET: THIS IS A LARGE POWERFUL JET THAT IS DESIGNED TO MOVE WATER AT A HIGH FLOW RATE. THE JET CAN BE ADJUSTED TO DIRECT THE WATERFLOW ACCORDING TO THE USER'S PREFERENCE.

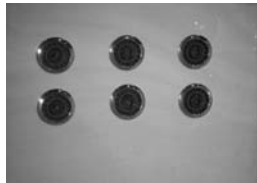

ULTRA MESSAGE SELECTOR: (DIVERTER VALVE) LOCATED ON SWIM SPA LIP. TURN TO ADJUST PUMP POWER TO SELECTED JETS WHICH ENHANCES WATER ACTION THROUGH THOSE JETS BY DECREASING WATER ACTION THROUGH OTHERS. BE SURE THAT NO SAND OR PARTICLES ARE BROUGHT INTO THE SWIM SPA AS THEY WILL CAUSE THE DIVERTER TO SEIZE UP. IT IS BEST TO TURN THE DIVERTER VALVE ONLY WHEN THE PUMP IS TURNED OFF.



AIR CONTROLS: FITTINGS MOUNTED ON THE LIP OF SWIM SPA THAT CONTROL THE AMOUNT OF OUTSIDE AIR MIXED WITH THE INCOMING WATER OF THE HYDRO-JET. YOUR SWIM SPA HAS MULTIPLE AIR CONTROLS ON THE SWIM SPA LIP THAT CONTROL AIR/ WATER MIX FOR A SEGMENT OF THE JETS. WHEN NOT IN USE THE AIR CONTROLS SHOULD BE KEPT IN THE OFF POSITION.

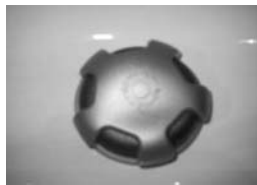

SUCTION: CIRCULAR FITTING MOUNTED ON THE VERTICAL WALL OF THE FOOTWELL AND SERVES AS AN ADDITIONAL PUMP WATER INLET. IN THE EVENT ANY DAMAGE TO THE SUCTION COVER OCCURS REPLACE IMMEDIATELY WITH A LIKE VGB APPROVED SUCTION.



SWIM SPA PARTS IDENTIFICATION



SWIM SPA PART TERMINOLOGY AND DESCRIPTION

FILTER: YOUR SWIM SPA IS EQUIPPED WITH SKIM FILTERS. THEY ASSURE OPTIMUM WATER FILTERING AND EASE OF CLEANING AT SPA SIDE. REVIEW THE MAINTENANCE SECTION OF THIS MANUAL FOR FILTER CARTRIDGE CLEANING AND REPLACEMENT



OZONE JETS: ALL SWIM SPAS ARE EQUIPPED WITH OZONE JETS FOR SANITATION. THE FILTER CYCLE SHOULD CIRCULATE 16-24 HOURS DAILY FOR PROPER OZONATION. USE THE PROGRAMMABLE ELECTRONIC CONTROL CENTER TO PROGRAM THIS OPERATION.



OZONATOR: YOUR OZONATOR WILL OPERATE IN CONJUNCTION WITH YOUR FILTRATION SYSTEM. OZONE IS A GAS THAT KILLS BACTERIA.



SLIDE VALVES: VALVES ARE USED TO SHUT OFF THE WATER FLOW TO THE HEATER, CIRCULATION PUMP, SECONDARY PUMP, AND FITNESS PUMPS FOR SPECIFIC SERVICE PROBLEMS.



SUPPORT PACK: THE CONTROL SYSTEM OPERATES ALL FUNCTIONS OF THE SWIM SPA. MAKE SURE YOUR ELECTRICIAN CONNECTS THE POWER SUPPLY ACCORDINGLY TO ALL NATIONAL ELECTRIC CODE, AND SHOWS YOU HOW TO TEST THE GFCI CIRCUIT BREAKER (NOT SUPPLIED).



SWIM SPA PARTS IDENTIFICATION



SWIM SPA PART TERMINOLOGY AND DESCRIPTION

TOPSIDE CONTROL:

USED TO CONTROL ALL SWIM SPA FUNCTIONS. THE TOPSIDE IS USED TO CONTROL THE WATER TEMPERATURE, PUMPS, SPA LIGHT, PROGRAMMABLE FILTRATION CYCLES, AND FUNCTIONS. THE TOPSIDE WILL ALTERNATE BETWEEN THE WATER TEMPERATURE AND THE TIME, AS WELL AS DISPLAY ERROR CODES RELATING TO SERVICE NEEDS.



PARTNER CONTROL:

AN ADDITIONAL CONTROL TO ALLOW THE USER TO OPERATE THE MAIN SWIM SPA FUNCTIONS.



HEATER:

YOUR SWIM SPA IS EQUIPPED WITH A THERMOSTAT CONTROL AT THE SPA SIDE (TOPSIDE CONTROL). SET THE SWIM SPA AT THE TEMPERATURE YOU ENJOY. LEAVE THE THERMOSTAT AT THAT SETTING, AND THE SWIM SPA WILL AUTOMATICALLY MAINTAIN THE CORRECT TEMPERATURE; READY FOR YOUR ENJOYMENT ANYTIME OF THE DAY. AVOID CONSTANT RESETTING OF THE THERMOSTAT; IT IS MORE ECONOMICAL TO MAINTAIN TEMPERATURE THEN TO LET THE TEMPERATURE FALL AND RAISE. NEVER RAISE THE TEMPERATURE ABOVE 104 DEGREES. NEVER RAISE TEMPERATURE ABOVE 86 DEGREES FOR SWIMMING OR EXERCISING.



CIRCULATION PUMP:

A DUAL SPEED PUMP DESIGNED TO USE LOW SPEED FOR WATER FILTRATION AND HEATING AND A HIGH SPEED FOR HYDROTHERAPY. THE JETS ONE BUTTON ON THE TOPSIDE CONTROL WILL ACTIVATE THE CIRCULATION PUMP. THE FX219 WILL HAVE A SECOND CIRCULATION PUMP FOR THE SPA END.



SWIM SPA PARTS IDENTIFICATION



SWIM SPA PART TERMINOLOGY AND DESCRIPTION

SECONDARY PUMP:

A SINGLE SPEED SECONDARY PUMP HAS BEEN ADDED TO THE SPA END OF THE FX219 FOR ADDITIONAL ENJOYMENT



FITNESS PUMPS:

TWO SINGLE SPEED PUMPS DESIGNED FOR USE WITH THE SWIM JETS. BUTTON 2 AND BUTTON 3 WILL ACTIVATE THE FITNESS PUMPS.

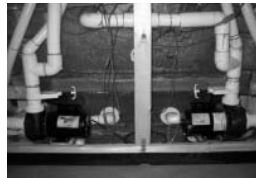

MOTION GLOW:

LOW VOLTAGE UNDERWATER SWIM SPA LIGHT, WITH VARYING SHADES OF A COLOR WASH, CONTROLLED AT THE SPASIDE CONTROL PANEL. CHOOSE ROTATION OF COLOR OR STATIONARY COLOR OF YOUR CHOICE.

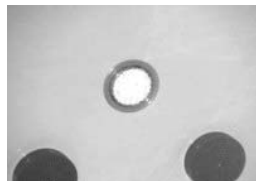

LED LIGHTING:

AS AN OPTIONAL FEATURE, LED PINPOINT LIGHTS ILLUMINATE THE VALVES AND CONTROLS AND SPECIFIC POSITIONS ON THE LIP OF THE SWIM SPA SHELL, ACCENTING WITH COLOR OPTIONS OF ROTATING COLORS OR A STATIONARY COLOR OF YOUR SELECTION.



SWIM SPA SPECIFICATIONS—FX14 MODEL



GENERAL rev. 2011/01

Seating Capacity	3 seats, 2 RX6, fitness area
Shell Material	Acrylic
Dimensions (Domestic)	168" x 91.5" x 54.5"
Dimensions (Export)	427 cm. x 232 cm x 138 cm.
Water Capacity	2000 Gallons (7,571 liters)
Dry Weight	1,575 lbs. (714 kg.)
Skirt Material	Permawood™ (slate/mahogany)
Water Flow	647 GPM

WATER SYSTEM** (photo ref.)

Water Treatment System	OZ	Ozonator
Filter (50 sq. ft.)	F	2
Side Valves		6
Synergy Jet	S	6
Large Euro Jet w/ Eyeball	E	26
Mega'ssage Jet	G	10
Ozone Jet	O	2
Diverter Valves	V	2
Safety Suction	U	8
Air Control	I	8
Spa Light	L	2

SPECIAL FEATURES

Spa Pillows	1
Motion Glow™ Light	Standard
Stainless Steel Jetting	Standard
Allure Lighting	Optional
SoundStream™ SE Audio	Optional*

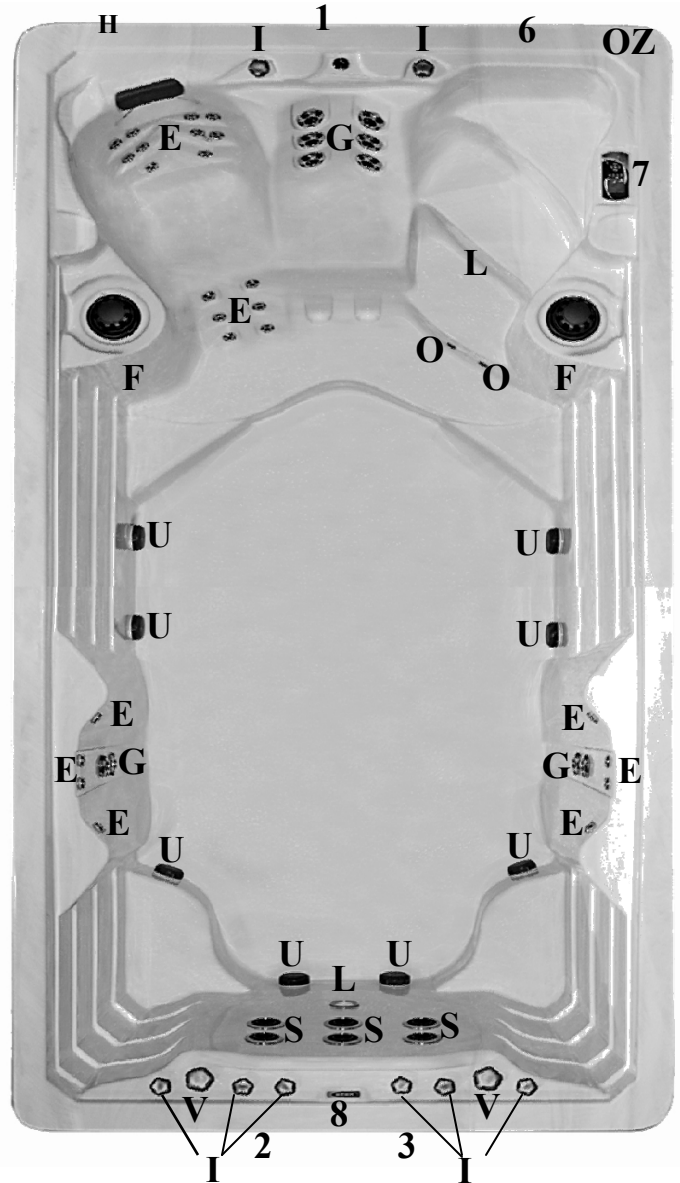

ELECTRICAL SYSTEM

Pump Information	Reference Number	Domestic (60Hz)	Export (50Hz)
Spa Pump peak (continuous) HP	1	4.0 (2.0) HP	4.0 (2.0) HP
Spa Pump #1 peak (continuous) HP	2	6.0 (3.0) HP	6.0 (3.0) HP
Spa Pump #2 peak (continuous) HP	3	6.0 (3.0) HP	6.0 (3.0) HP
Electronics			
Electrical Can	6	Gecko XM Series	Gecko XM Series
Voltage		240	230/400
Amperage		50	1x32
Heater	H	4.0 KW	3.8 KW
Operation System			
Main Spa Side Control	7	Gecko 600 Series	Gecko 600 Series
Secondary Spa Side Control	8	Gecko 100 Series	Gecko 100 Series

** Not every jet is referenced. Each type of jet is noted for ease of identification. *Note location of audio components prior to install. Equipment location relates to slimline design. All specifications are accurate at time of print. Manufacturer reserves the option to change product without prior notice. Dimensions are approximate.

SWIM SPA SPECIFICATIONS—FX14-NJ MODEL



GENERAL

rev. 2011/01

Seating Capacity	3 seats
Shell Material	Acrylic
Dimensions (Domestic)	168" x 91.5" x 54.5"
Dimensions (Export)	427 cm. x 232 cm x 138 cm.
Water Capacity	2000 Gallons (7,571 liters)
Dry Weight	1,575 lbs. (714 kg.)
Skirt Material	Permawood™ (slate/mahogany)
Water Flow	647 GPM

WATER SYSTEM** (photo ref.)

Water Treatment System	OZ	Ozonator
Filter (50 sq. ft.)	F	2
Side Valves		2
Synergy Jet	S	0
Large Euro Jet w/ Eyeball	E	18
Mega'ssage Jet	G	6
Ozone Jet	O	2
Diverter Valves	V	0
Safety Suction	U	2
Air Control	I	2
Spa Light	L	2

SPECIAL FEATURES

Spa Pillows	1
Motion Glow™ Light	Standard
Stainless Steel Jetting	Standard
Allure Lighting	Optional
SoundStream™ SE Audio	Optional*

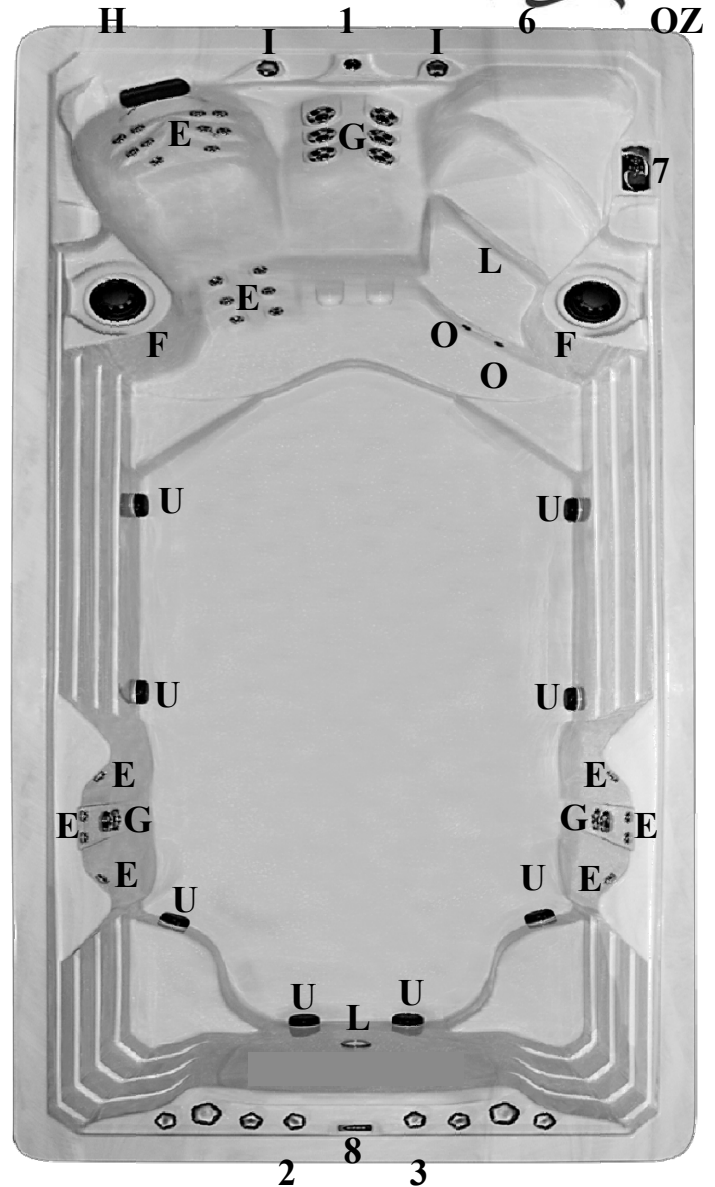

ELECTRICAL SYSTEM

Pump Information	Reference Number	Domestic (60Hz)	Export (50Hz)
Spa Pump peak (continuous) HP	1	4.0 (2.0) HP	4.0 (2.0) HP
Electronics			
Electrical Can	6	Gecko XM Series	Gecko XM Series
Voltage		240	230/400
Amperage		50	1x32
Heater	H	4.0 KW	3.8 KW
Operation System			
Main Spa Side Control	7	Gecko 600 Series	Gecko 600 Series

** Not every jet is referenced. Each type of jet is noted for ease of identification. *Note location of audio components prior to install. Equipment location relates to slimline design. All specifications are accurate at time of print. Manufacturer reserves the option to change product without prior notice. Dimensions are approximate.

SWIM SPA SPECIFICATIONS—FX15 MODEL



GENERAL

rev. 2011/01

Seating Capacity	3 seats, 2 RX6, fitness area
Shell Material	Acrylic
Dimensions (Domestic)	180" x 91.5" x 54.5"
Dimensions (Export)	457 cm. x 232 cm. x 138 cm.
Water Capacity	2,140 Gallons (8,101 liters)
Dry Weight	1,645 lbs (746 kg)
Skirt Material	Permawood™ (slate/mahogany)
Water Flow	647 GPM

WATER SYSTEM**

(photo ref.)

Water Treatment System	OZ	Ozonator
Filter (50 sq. ft.)	F	2
Side Valves		6
Synergy Jet	S	6
Large Euro Jet w/ Eyeball	E	26
Mega'ssage Jet	G	10
Ozone Jet	O	2
Diverter Valves	V	2
Safety Suction	U	8
Air Control	I	8
Spa Light	L	2

SPECIAL FEATURES

Spa Pillows	1
Motion Glow™ Light	Standard
Stainless Steel Jetting	Standard
Allure Lighting	Optional
SoundStream™ SE Audio	Optional*

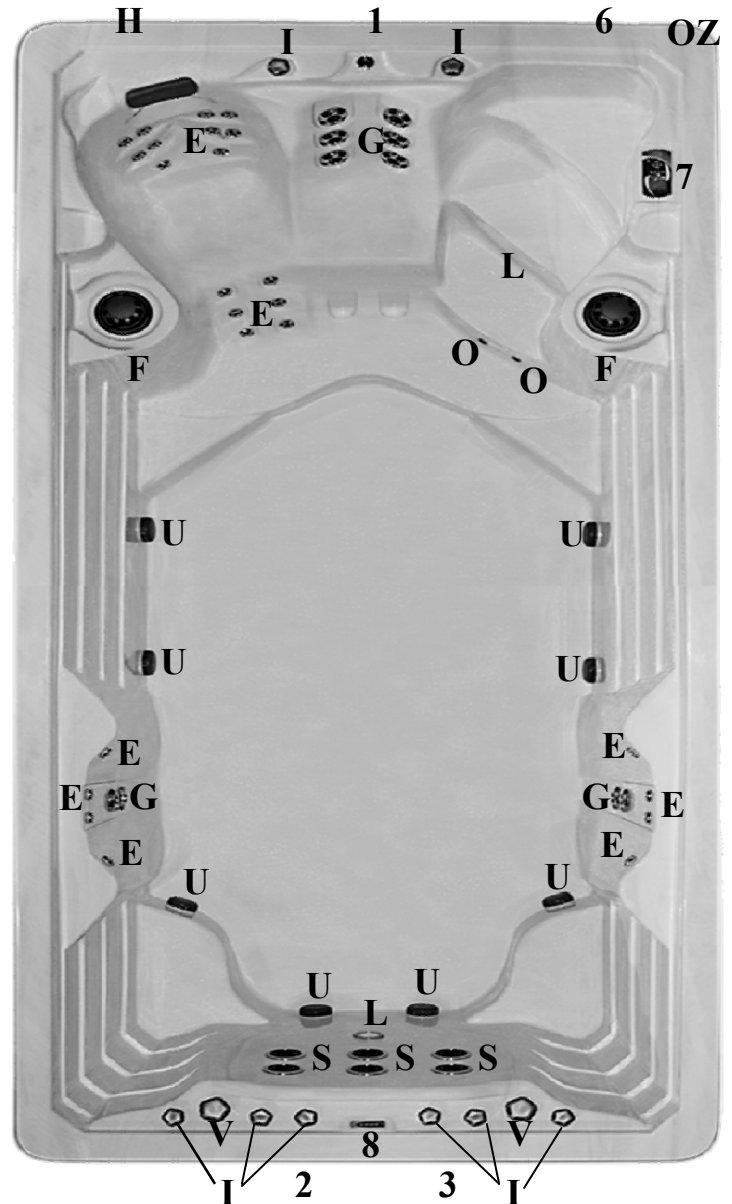

ELECTRICAL SYSTEM

Pump Information	Reference Number	Domestic (60Hz)	Export (50Hz)
Spa Pump peak (continuous) HP	1	4.0 (2.0) HP	4.0 (2.0) HP
Spa Pump #1 peak (continuous) HP	2	6.0 (3.0) HP	6.0 (3.0) HP
Spa Pump #2 peak (continuous) HP	3	6.0 (3.0) HP	6.0 (3.0) HP
Electronics			
Electrical Can	6	Gecko XM Series	Gecko XM Series
Voltage		240	230/400
Amperage		50	1x32
Heater	H	4.0 KW	3.8 KW
Operation System			
Main Spa Side Control	7	Gecko 600 Series	Gecko 600 Series
Secondary Spa Side Control	8	Gecko 100 Series	Gecko 100 Series

** Not every jet is referenced. Each type of jet is noted for ease of identification. *Note location of audio components prior to install. Equipment location relates to slimline design. All specifications are accurate at time of print. Manufacturer reserves the option to change product without prior notice. Dimensions are approximate.

SWIM SPA SPECIFICATIONS—FX15-NJ MODEL



GENERAL rev. 2011/01

Seating Capacity	3 seats
Shell Material	Acrylic
Dimensions (Domestic)	180" x 91.5" x 54.5"
Dimensions (Export)	457 cm. x 232 cm. x 138 cm.
Water Capacity	2,140 Gallons (8,101 liters)
Dry Weight	1,645 lbs (746 kg)
Skirt Material	Permawood™ (slate/mahogany)
Water Flow	647 GPM

WATER SYSTEM** (photo ref.)

Water Treatment System	OZ	Ozonator
Filter (50 sq. ft.)	F	2
Side Valves		2
Synergy Jet	S	0
Large Euro Jet w/ Eyeball	E	18
Mega'ssage Jet	G	6
Ozone Jet	O	2
Diverter Valves	V	0
Safety Suction	U	2
Air Control	I	2
Spa Light	L	2

SPECIAL FEATURES

Spa Pillows	1
Motion Glow™ Light	Standard
Stainless Steel Jetting	Standard
Allure Lighting	Optional
SoundStream™ SE Audio	Optional*

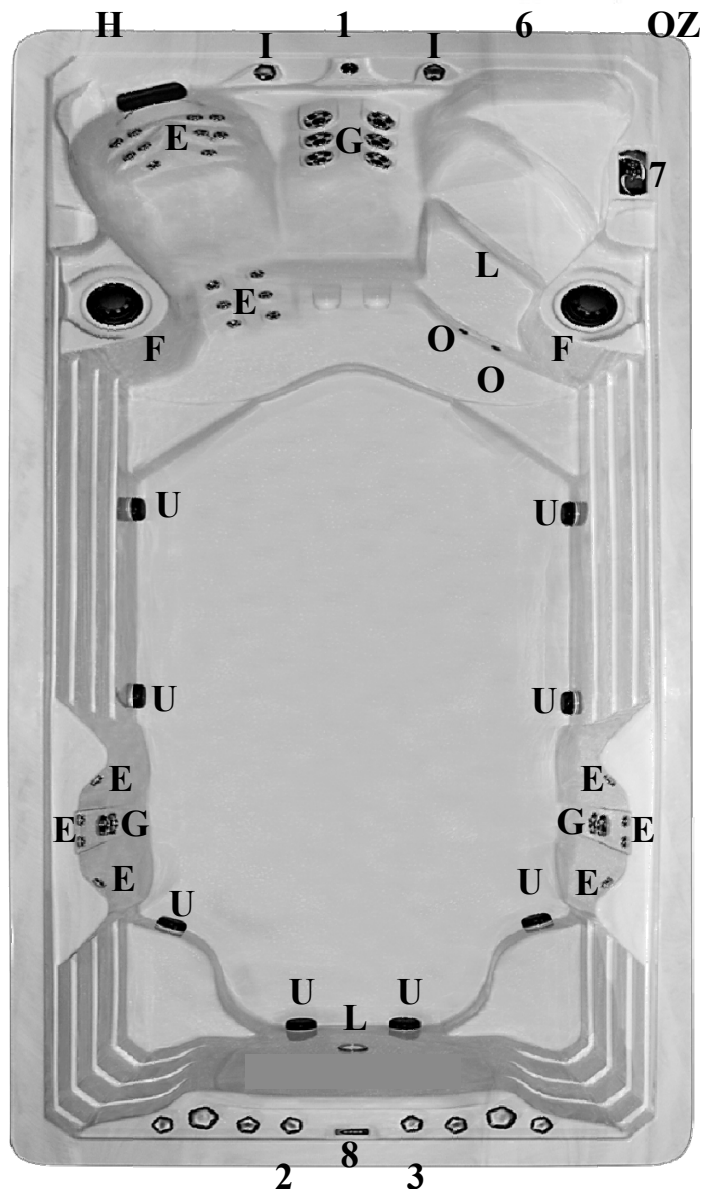

ELECTRICAL SYSTEM

Pump Information	Reference Number	Domestic (60Hz)	Export (50Hz)
Spa Pump peak (continuous) HP	1	4.0 (2.0) HP	4.0 (2.0) HP
Electronics			
Electrical Can	6	Gecko XM Series	Gecko XM Series
Voltage		240	230/400
Amperage		50	1x32
Heater	H	4.0 KW	3.8 KW
Operation System			
Main Spa Side Control	7	Gecko 600 Series	Gecko 600 Series

** Not every jet is referenced. Each type of jet is noted for ease of identification. *Note location of audio components prior to install. Equipment location relates to slimline design. All specifications are accurate at time of print. Manufacturer reserves the option to change product without prior notice. Dimensions are approximate.

SWIM SPA SPECIFICATIONS—FX17 MODEL



GENERAL rev. 2011/01

Seating Capacity	3 seats, 2 RX6, fitness area
Shell Material	Acrylic
Dimensions (Domestic)	203.5" x 91.5" x 54.5"
Dimensions (Export)	517 cm. x 232 cm. x 138 cm.
Water Capacity	2,420 Gallons (9,161 liters)
Dry Weight	1,784 lbs (809 kg)
Skirt Material	Permawood™ (slate/mahogany)
Water Flow	647 GPM

WATER SYSTEM** (photo ref.)

Water Treatment System	OZ	Ozonator
Filter (50 sq. ft.)	F	2
Side Valves	6	
Synergy Jet	S	6
Large Euro Jet w/ Eyeball	E	26
Mega'ssage Jet	G	10
Ozone Jet	O	2
Diverter Valves	V	2
Safety Suction	U	8
Air Control	I	8
Spa Light	L	2

SPECIAL FEATURES

Spa Pillows	1
Motion Glow™ Light	Standard
Stainless Steel Jetting	Standard
Allure Lighting	Optional
SoundStream™ SE Audio	Optional*

ELECTRICAL SYSTEM

Pump Information	Reference Number	Domestic (60Hz)	Export (50Hz)
Spa Pump peak (continuous) HP	1	4.0 (2.0) HP	4.0 (2.0) HP
Spa Pump #1 peak (continuous) HP	2	6.0 (3.0) HP	6.0 (3.0) HP
Spa Pump #2 peak (continuous) HP	3	6.0 (3.0) HP	6.0 (3.0) HP
Electronics			
Electrical Can	6	Gecko XM Series	Gecko XM Series
Voltage		240	230/400
Amperage		50	1x32
Heater	H	4.0 KW	3.8 KW
Operation System			
Main Spa Side Control	7	Gecko 600 Series	Gecko 600 Series
Secondary Spa Side Control	8	Gecko 100 Series	Gecko 100 Series

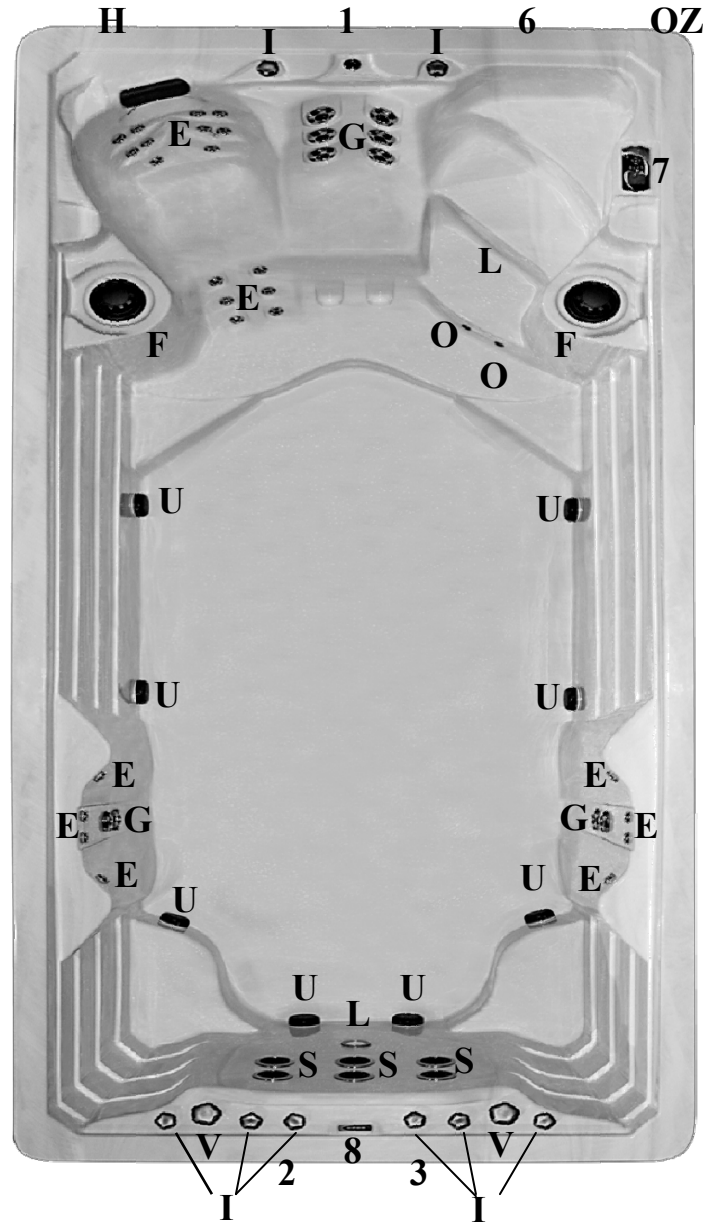

** Not every jet is referenced. Each type of jet is noted for ease of identification. *Note location of audio components prior to install. Equipment location relates to slimline design. All specifications are accurate at time of print. Manufacturer reserves the option to change product without prior notice. Dimensions are approximate.

SWIM SPA SPECIFICATIONS—FX17-NJ MODEL



GENERAL

rev. 2011/01

Seating Capacity	3 seats
Shell Material	Acrylic
Dimensions (Domestic)	203.5" x 91.5" x 54.5"
Dimensions (Export)	517 cm. x 232 cm. x 138 cm.
Water Capacity	2,420 Gallons (9,161 liters)
Dry Weight	1,784 lbs (809 kg)
Skirt Material	Permawood™ (slate/mahogany)
Water Flow	647 GPM

WATER SYSTEM**

(photo ref.)

Water Treatment System	OZ	Ozonator
Filter (50 sq. ft.)	F	2
Side Valves		2
Synergy Jet	S	0
Large Euro Jet w/ Eyeball	E	18
Mega'ssage Jet	G	6
Ozone Jet	O	2
Diverter Valves	V	0
Safety Suction	U	2
Air Control	I	2
Spa Light	L	2

SPECIAL FEATURES

Spa Pillows	1
Motion Glow™ Light	Standard
Stainless Steel Jetting	Standard
Allure Lighting	Optional
SoundStream™ SE Audio	Optional*

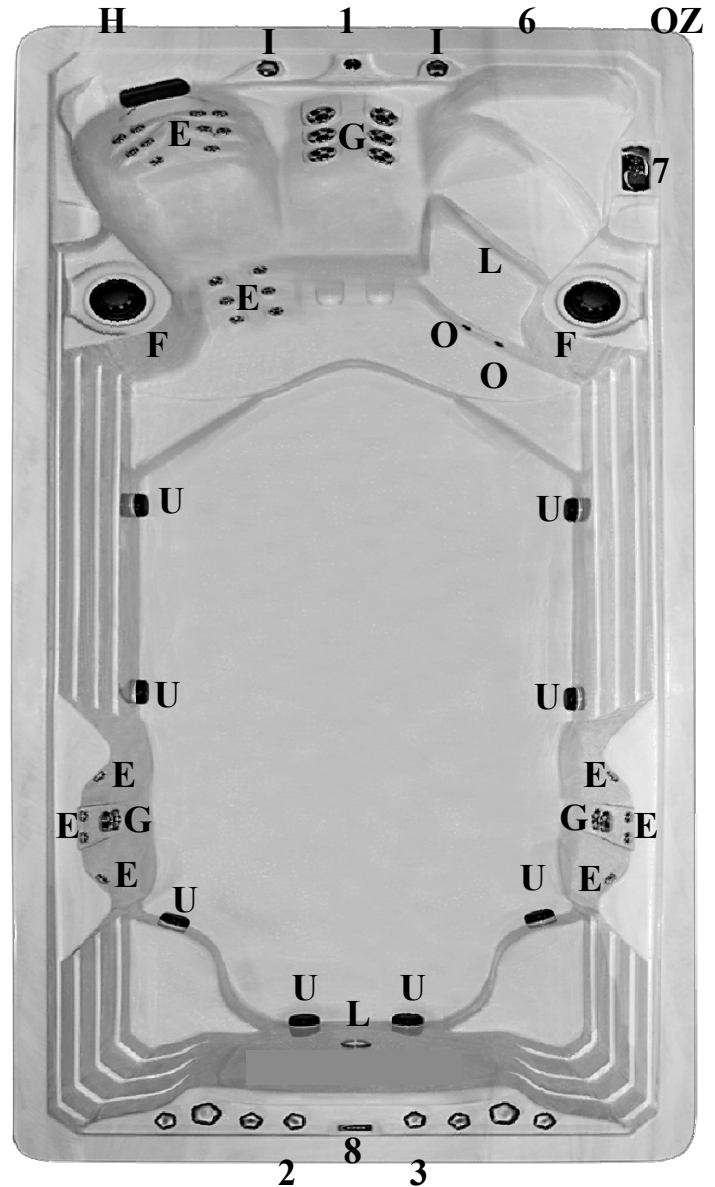

ELECTRICAL SYSTEM

Pump Information	Reference Number	Domestic (60Hz)	Export (50Hz)
Spa Pump peak (continuous) HP	1	4.0 (2.0) HP	4.0 (2.0) HP
Electronics			
Electrical Can	6	Gecko XM Series	Gecko XM Series
Voltage		240	230/400
Amperage		50	1x32
Heater	H	4.0 KW	3.8 KW
Operation System			
Main Spa Side Control	7	Gecko 600 Series	Gecko 600 Series

** Not every jet is referenced. Each type of jet is noted for ease of identification. *Note location of audio components prior to install. Equipment location relates to slimline design. All specifications are accurate at time of print. Manufacturer reserves the option to change product without prior notice. Dimensions are approximate.

SWIM SPA SPECIFICATIONS—FX219 MODEL



GENERAL

rev. 2011/01

Seating Capacity	8 seats, 2 RX6, fitness area
Shell Material	Acrylic
Dimensions (Domestic)	227" x 91.5" x 54.5"
Dimensions (Export)	578 cm. x 232 cm. x 138 cm.
Water Capacity	2,425 Gallons (9,186 liters)
Dry Weight	2,174 lbs (986 kg)
Skirt Material	Permawood™ (slate/mahogany)
Water Flow	1,038 GPM



* see following page for full diagram

WATER SYSTEM** (photo ref.)

Water Treatment System	OZ	Ozonator
Filter (50 sq. ft.)	F	3
Side Valves		10
Mega Swirl Jet	A	3
Synergy Jet	S	6
Large Euro Jet w/ Eyeball	E	42
Mega'ssage Jet	G	18
Shower Head Jet	SH	2
Ozone Jet	O	4
Diverter Valves	V	2
Safety Suction	U	12
Air Control	I	11
Spa Light	L	3

SPECIAL FEATURES

Spa Pillows	3
Motion Glow™ Light	Standard
Stainless Steel Jetting	Standard
Allure Lighting	Optional
SoundStream™ SE Audio	Optional*

ELECTRICAL SYSTEM

Pump Information	Reference Number	Domestic (60Hz)	Export (50Hz)
Spa End Pump #1 peak (continuous) HP	1	2.0 (1.0) HP	2.0 (1.0) HP
Spa End Pump #2 peak (continuous) HP	2	4.0 (2.0) HP	4.0 (2.0) HP
Swim Spa Seating Pump (continuous) HP	3	4.0 (2.0) HP	4.0 (2.0) HP
Swim Pump #1 peak (continuous) HP	4	6.0 (3.0) HP	6.0 (3.0) HP
Swim Pump #2 peak (continuous) HP	5	6.0 (3.0) HP	6.0 (3.0) HP
Electronics			
Electrical Can (spa end)	6	Gecko XE Series	Gecko XE Series
Voltage (spa end)		240	240
Amperage (spa end)		50	1x32
Heater (spa end)	H1	4.0 KW	3.8 KW
Electrical Can (swim end)	7	Gecko XM Series	Gecko XM Series
Voltage (swim end)		240	230/400
Amperage (swim end)		50	1 x 32
Heater (swim end)	H2	4.0 KW	3.8 KW
Operation System			
Main Spa Side Control (spa end)	8	Gecko 450 Series	Gecko 450 Series
Main Spa Side Control (swim end)	9	Gecko 600 Series	Gecko 600 Series
Secondary Spa Side Control	10	Gecko 100 Series	Gecko 100 Series

** Not every jet is referenced. Each type of jet is noted for ease of identification. *Note location of audio components prior to install. Equipment location relates to slimline design. All specifications are accurate at time of print. Manufacturer reserves the option to change product without prior notice. Dimensions are approximate.

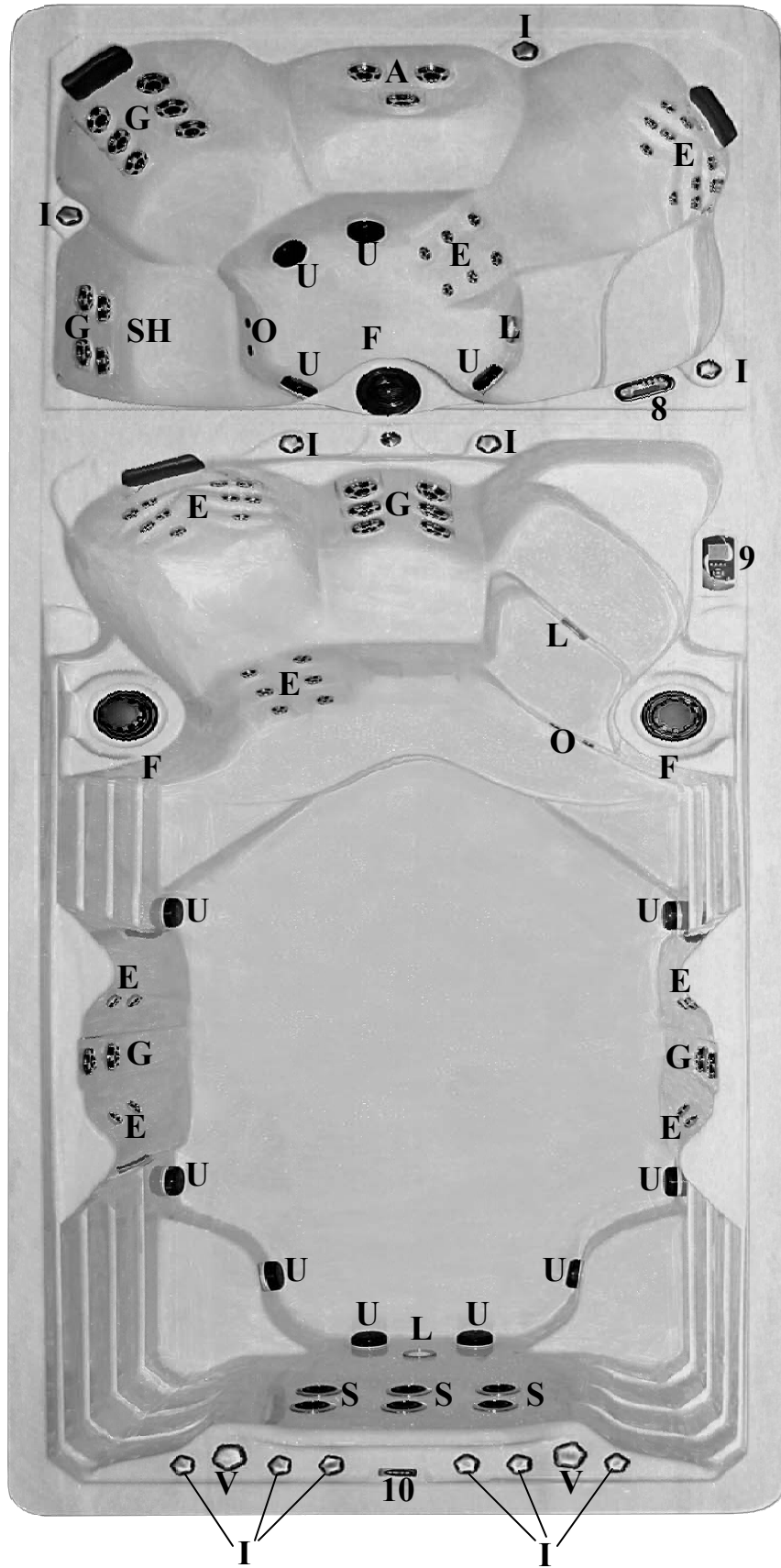

SWIM SPA SPECIFICATIONS—FX219-NJ MODEL**GENERAL**

rev. 2011/01

Seating Capacity	8 seats
Shell Material	Acrylic
Dimensions (Domestic)	227" x 91.5" x 54.5"
Dimensions (Export)	578 cm. x 232 cm. x 138 cm.
Water Capacity	2,425 Gallons (9,186 liters)
Dry Weight	2,174 lbs (986 kg)
Skirt Material	Permawood™ (slate/mahogany)
Water Flow	1,038 GPM



* see following page for full diagram

WATER SYSTEM** (photo ref.)

Water Treatment System	OZ	Ozonator
Filter (50 sq. ft.)	F	3
Side Valves		6
Mega Swirl Jet	A	3
Synergy Jet	S	0
Large Euro Jet w/ Eyeball	E	34
Mega'ssage Jet	G	18
Shower Head Jet	SH	2
Ozone Jet	O	4
Diverter Valves	V	0
Safety Suction	U	6
Air Control	I	5
Spa Light	L	3

SPECIAL FEATURES

Spa Pillows	3
Motion Glow™ Light	Standard
Stainless Steel Jetting	Standard
Allure Lighting	Optional
SoundStream™ SE Audio	Optional*

ELECTRICAL SYSTEM

Pump Information	Reference Number	Domestic (60Hz)	Export (50Hz)
Spa End Pump #1 peak (continuous) HP	1	2.0 (1.0) HP	2.0 (1.0) HP
Spa End Pump #2 peak (continuous) HP	2	4.0 (2.0) HP	4.0 (2.0) HP
Swim Spa Seating Pump (continuous) HP	3	4.0 (2.0) HP	4.0 (2.0) HP
Electronics			
Electrical Can (spa end)	6	Gecko XE Series	Gecko XE Series
Voltage (spa end)		240	240
Amperage (spa end)		50	1x32
Heater (spa end)	H1	4.0 KW	3.8 KW
Electrical Can (swim end)	7	Gecko XM Series	Gecko XM Series
Voltage (swim end)		240	240
Amperage (swim end)		50	1 x 32
Heater (swim end)	H2	4.0 KW	3.8 KW
Operation System			
Main Spa Side Control (spa end)	8	Gecko 450 Series	Gecko 450 Series
Main Spa Side Control (swim end)	9	Gecko 600 Series	Gecko 600 Series

** Not every jet is referenced. Each type of jet is noted for ease of identification. *Note location of audio components prior to install. Equipment location relates to slimline design. All specifications are accurate at time of print. Manufacturer reserves the option to change product without prior notice. Dimensions are approximate.

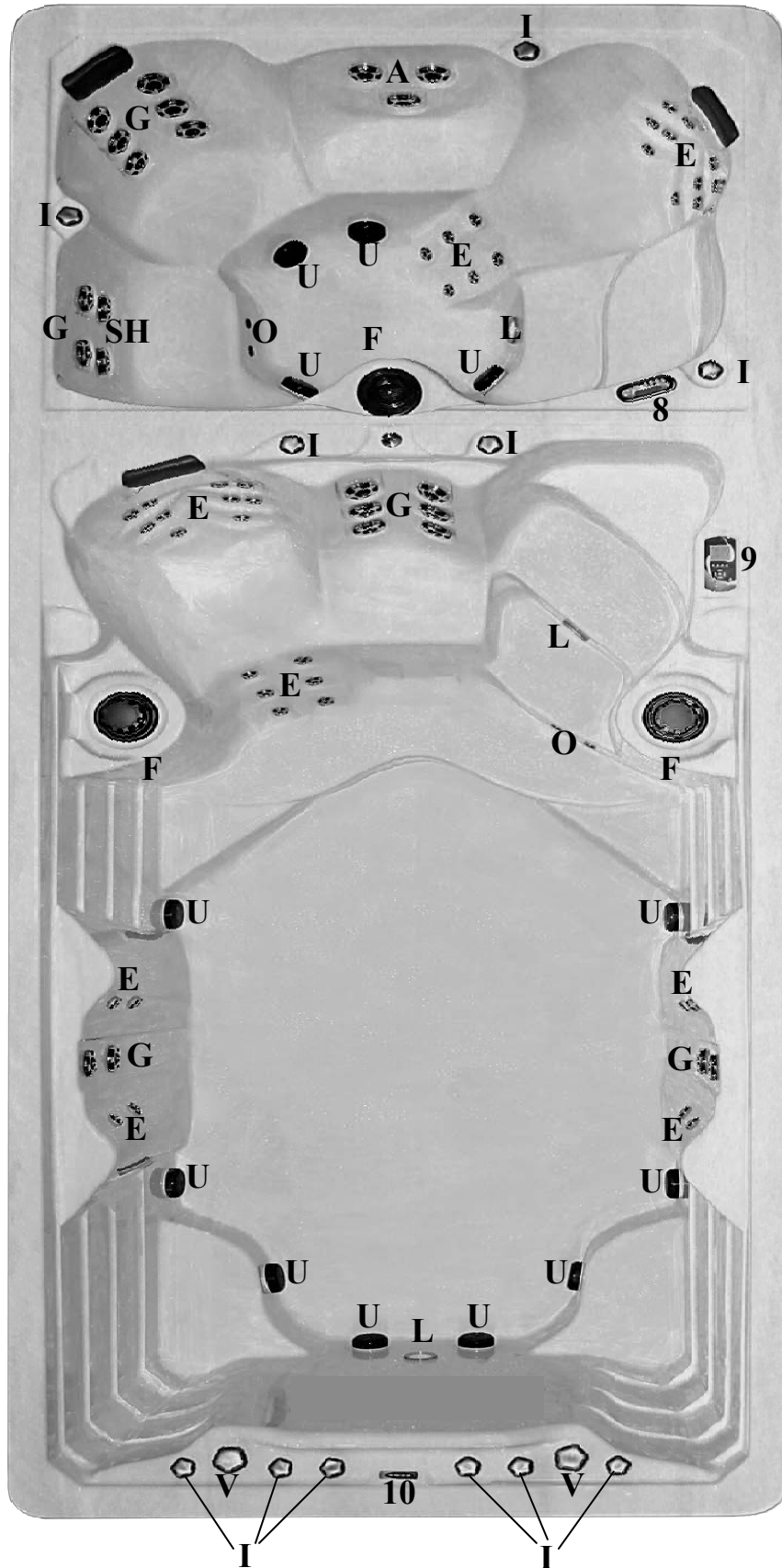

SWIM SPA INSTALLATION



INSTALLATION GUIDELINES

THE LOCATION OF YOUR SWIM SPA IS AN IMPORTANT FACTOR IN GUARANTEEING YOUR MAXIMUM SPA ENJOYMENT. GENERALLY, MOST SPAS ARE INSTALLED OUTDOORS WITH NO CONCERNS REGARDING MOISTURE ACCUMULATION, WATER SPILL-OVER, ETC. WHICH ARE CONSIDERATIONS FOR THOSE LOCATED INSIDE.

OUTDOOR INSTALLATION CONSIDERATIONS

1. LOCAL ELECTRICAL AND PLUMBING CODES.
2. CONSIDER LOCAL CODES PERTAINING TO FENCING, ENCLOSURES, WALLS, ELECTRICAL AND PLUMBING.
YOU WILL NEED TO ENSURE THAT YOUR SWIM SPA IS AN ADEQUATE DISTANCE FROM POWER LINES, BOTH ABOVE GROUND AND UNDERGROUND. YOUR SWIM SPA WILL ALSO NEED TO BE CHILDPROOFED.
3. VIEW FROM HOUSE FOR AESTHETICS AND SUPERVISORY NEEDS.
4. DISTANCE FROM HOUSE FOR WINTERTIME SOAKING.
5. NIGHTTIME LIGHTING.
6. LOCATE THE SWIM SPA WITH AN AWARENESS TO SUNLIGHT EXPOSURE, VIEWS, ACCESS, PROPERTY LINES, LIGHTING, WIND DIRECTION, SHIELDING, SEPTIC TANKS, PLANTS, TREES. (CHEMICALS IN THE SWIM SPA WATER SPLASHED FROM YOUR SWIM SPA MAY DAMAGE NEARBY PLANT LIFE.)
7. CONSIDER THE LOCATION OF THE NEAREST BATHROOM.
8. IF YOUR SWIM SPA IS TO BE LOCATED ON A SECOND STORY, BE POSITIVE SUPPORT IS ADEQUATE.
CALL YOUR BUILDER AND A STRUCTURAL ENGINEER.
9. AREA FOR PLACEMENT OF SUPPORT EQUIPMENT WHERE ADEQUATE SPACE WILL BE NEEDED TO GAIN ACCESS TO COMPONENTS FOR MAINTENANCE AND GENERAL SERVICING.
10. BE SURE TO NOTE ANY OTHER CONSIDERATIONS, SUCH AS AESTHETICS OR PRIVACY CONCERNS, THAT MAY AFFECT THE SAFETY OR ENJOYMENT OF USING THE SWIM SPA.
11. PROVIDE ADEQUATE DRAINAGE AWAY FROM THE EQUIPMENT AND ADEQUATE ELEVATION TO ALLOW DRAINING BY SIPHON, IF SHOULD BE REQUIRED.
12. LOCATION OF ELECTRICAL SUPPLY. 120/240 VOLT SYSTEMS REQUIRE HARD WIRE INSTALLED FROM THE ELECTRICAL SOURCE TO THE SWIM SPA SUPPORT PACK TERMINAL. ALL EQUIPMENT MUST BE GROUND FAULT CIRCUIT PROTECTED (NOT SUPPLIED) AT THE POWER SOURCE. ALL ELECTRICAL WIRING OF THE SWIM SPA SUPPORT EQUIPMENT MUST COMPLY WITH THE NATIONAL ELECTRIC CODE.
13. LOCATIONS AT LEAST 5 FT (1.52 M) FROM ALL METAL SURFACES. (A SWIM SPA MAY BE INSTALLED WITHIN 5 FEET OF METALS SURFACES PROVIDING EACH METAL SURFACE IS PERMANENTLY CONNECTED BY A No. 6AWG (8.4 MM²) COPPER CONDUCTOR ATTACHED TO THE WIRE CONNECTOR ON THE TERMINAL BOX PROVIDED FOR THIS PURPOSE.) ALL INSTALLATIONS MUST COMPLY WITH ARTICLE 680 OF THE U.S. NATIONAL ELECTRIC CODE AND ANSI/NFPA 70-1984.
14. PLACE THE SWIM SPA ON A FIRM, LEVEL SURFACE THAT WILL NOT SHIFT.

SWIM SPA INSTALLATION**INSTALLATION GUIDELINES****INDOOR INSTALLATION CONSIDERATIONS**

1. LOCAL ELECTRICAL AND PLUMBING CODES.
2. VENTILATION FANS AND/OR DEHUMIDIFIERS SHOULD BE PROVIDED TO HANDLE THE HIGH HUMIDITY DEVELOPED BY YOUR SWIM SPA. WALLS, CEILING AND WOOD TRIM SHOULD BE RESISTANT, ALSO.
3. CHEMICALS WILL VAPORIZE FROM THE WATER AND MAY CAUSE AN ODOR AND POSSIBLY CORROSION TO CERTAIN HOME HARD-WARE. NEVER STORE CHEMICALS INSIDE THE SWIM SPA CABINET.
4. DURING THE NORMAL USE OF THE SWIM SPA, WATER WILL ESCAPE THE SWIM SPA VESSEL. NEVER PLACE THE SWIM SPA ON OR OVER ANY MATERIAL WHICH MAY BE DAMAGED BY THIS WATER OR THE CHEMICALS WITHIN THE WATER. KEEP DAMAGEABLE MATERIALS FAR ENOUGH AWAY FROM THE SWIM SPA TO AVOID WATER DAMAGE, EVEN IF THE SPA SHOULD LOSE ALL ITS WATER.
5. CONSIDER AND PREPARE FOR THE UNLIKELY EVENT OF RAPID SWIM SPA DRAINAGE. IF PLACEMENT OF THE SWIM SPA IS PERMANENT, YOU MAY WISH TO PROVIDE FLOOR DRAINS TO ACCOMMODATE DRAINING, ETC. ALWAYS LEAVE ROOM ALL AROUND THE SWIM SPA FOR EASY ACCESS IN CASE REPAIRS ARE NECESSARY.
6. CONSIDER AND PREPARE FOR THE UNLIKELY EVENT OF SWIM SPA REMOVAL.
7. READ 7-14 IN THE OUTDOOR INSTALLATIONS INFORMATION.
8. DO NOT SET SWIM SPA ON FINISHED FLOOR WITHOUT A WATERPROOF BARRIER PROTECTION UNDERNEATH.
9. THE SWIM SPA SHOULD HAVE ACCESS TO A POWER SOURCE CAPABLE OF SUPPLYING 240 VOLTS AC POWER. IT MUST BE WIRED DIRECTLY INTO A GROUNDED CIRCUIT WITH A GROUND FAULT CIRCUIT INTERRUPTER (G.F.C.I.)OR EQUIVALENT RCD (NOT SUPPLIED), FOR EXPORT INSTALLS. NO OTHER APPLIANCES SHOULD BE ON THE SAME CIRCUIT.
10. THE SWIM SPA SHOULD BE CLOSE TO A SOURCE OF WATER.
11. BE SURE THAT THE LOCATION YOU CHOOSE IS STABLE. IT MUST BE ABLE TO SUPPORT THE WEIGHT OF THE SWIM SPA WHEN IT IS FILLED WITH WATER, PLUS THE WEIGHT OF THE OCCUPANTS. THE SWIM SPA MAY WEIGH UP TO 26,000 LBS (11,793 KG.) WHEN IT IS FILLED WITH WATER.
12. DO NOT USE THE SWIM SPA ABOVE A FINISHED LIVING AREA, DUE TO THE RISK OF WATER DAMAGE.
13. THE SWIM SPA IS NOT DESIGNED FOR IN-FLOOR INSTALLATION. HOWEVER, IT IS COMPATIBLE WITH A DECK SYSTEM THAT IS BUILT FLUSH WITH THE TOP OF THE SPA, PROVIDED YOU LEAVE ACCESS FOR SERVICE.
14. BE SURE TO NOTE ANY OTHER CONSIDERATIONS, SUCH AS AESTHETICS OR PRIVACY CONCERNS, THAT MAY AFFECT THE SAFETY OR ENJOYMENT OF USING THE SWIM SPA.

WARNING:

THIS IS A PROFESSIONAL GRADE PRODUCT.
 A KNOWLEDGE OF CONSTRUCTION TECHNIQUES, PLUMBING AND ELECTRICAL
 INSTALLATION ACCORDING TO CODES ARE REQUIRED FOR PROPER INSTALLATION
 AND USER SATISFACTION. WE RECOMMEND THAT A LICENSED CONTRACTOR
 PERFORM THE INSTALLATION. OUR WARRANTY DOES NOT COVER
 IMPROPER INSTALLATION-RELATED PROBLEMS.

SWIM SPA INSTALLATION



GENERAL LOCATION CONSIDERATIONS

REVIEW OUTDOOR INSTALLATIONS AND INDOOR INSTALLATIONS PRIOR TO CHOOSING YOUR SWIM SPA LOCATION. YOUR SWIM SPA SHOULD BE PLACED ON A LEVEL CONCRETE PAD OR ON A DECK DESIGNED TO SUPPORT 26,000 LBS (11,793 KG.). DO NOT PLACE THE SWIM SPA ON A DIRT SURFACE OR DIRECTLY ON THE GROUND. ONCE YOU HAVE A LOCATION SELECTED, THERE ARE SEVERAL ISSUES YOU SHOULD CONSIDER IN PREPARING THE SITE FOR THE SWIM SPA INSTALLATION.

A FLAT, LEVEL SURFACE THAT IS STRONG ENOUGH TO SUPPORT YOUR SWIM SPA IS REQUIRED. ONCE YOUR SWIM SPA IS FILLED, IT HAS CONSIDERABLE WEIGHT. MAKE CERTAIN THE LOCATION YOU CHOOSE CAN SUPPORT A MINIMUM OF 200 LBS (91 KG) PER SQUARE FOOT LOAD, PER RECOMMENDED GUIDELINES. STRUCTURAL DAMAGE TO THE SWIM SPA RESULTING FROM THE INCORRECT INSTALLATION OF PLACEMENT ON INADEQUATE FOUNDATION IS NOT COVERED IN THE SWIM SPA'S LIMITED WARRANTY.

MOST UNITS ARE INSTALLED OUTSIDE, ON GROUND LEVEL, ON EITHER A CONCRETE PAD OR A WOODEN DECK. IF THE SWIM SPA IS NOT ON GROUND LEVEL, HAVE A BUILDER DETERMINE IF THE SUPPORT IS ADEQUATE. A REINFORCED CONCRETE SLAB SHOULD BE AT LEAST FOUR INCHES THICK WITH THE REINFORCING MESH OR ROD ATTACHED TO A BOND WIRE.

MAKE SURE YOUR DIMENSIONS ARE CORRECT AS YOU PREPARE THE SITE FOR YOUR NEW HOT TUB. CLICK ON-TO THE WEB SITE (WWW.PDCSPAS.COM) OR CALL YOUR RETAILER FOR DIMENSIONS OF THE MODEL YOU HAVE CHOSEN. ALLOW A PERIMETER OF THE CHOSEN GROUND SURFACE TO EXTEND BEYOND THE SWIM SPA ITSELF TO PROVIDE A CLEAN AREA FOR USERS TO GET IN AND OUT OF THE SWIM SPA.

THE SWIM SPA LOCATION AND THE SWIM SPA ITSELF MUST BE LEVEL BEFORE FILLING WITH WATER.

SHOULD YOUR SWIM SPA SITE BE A WOODEN DECK, THIS PROVIDES A CLEAN AREA WITH WEATHER AND ROT RESISTANT QUALITIES, IF A PRESSURE-TREATED TYPE LUMBER IS USED. CONSIDER THE LOAD REQUIREMENTS AND CONSULT A BUILDER TO DETERMINE IF YOUR DECK IS OF ADEQUATE STRENGTH.

IF INSTALLING YOUR HOT TUB BELOW GRADE, CONSIDER ADEQUATE DRAINAGE FOR RUN-OFF AND THE UNLIKELY EVENT OF RAPID SWIM SPA DRAINAGE.

ALLOW ADEQUATE SPACE TO ACCESS THE EQUIPMENT BEHIND THE FOUR ACCESS PANELS ON THE SWIM SPA CABINET. REVIEW THE PAGES IN THIS MANUAL REFERENCING SWIM SPA MODEL SPECIFICATIONS FOR THE LOCATION OF THE SUPPORT EQUIPMENT FOR THE MODEL YOU HAVE CHOSEN.

LEAVE AMPLE ACCESS TO THE GFCI CIRCUIT BREAKER FOR TESTING, ETC.

A QUICK DISCONNECT (MANUAL DISCONNECT) OR GFCI IS TO BE INSTALLED BETWEEN 5 - 15 FT (1.5-4.6 M) OF THE SPA AND WITHIN THE LINE OF SIGHT FROM THE HOT TUB. CONSIDER WHERE THIS CAN BE LOCATED WHEN SELECTING AND PREPARING THE SPA SITE. ALL WIRING MUST COMPLY WITH THE U.S. NATIONAL ELECTRIC CODE.

SWIM SPA INSTALLATION**INSTALLATION INSTRUCTIONS**

ONCE THE SWIM SPA IS IN ITS FINAL LOCATION PERFORM THE FOLLOWING STEPS.

1. CONSULT THE SPECIFICATION SHEET FOR YOUR SPECIFIC SWIM SPA TO LOCATE THE SKIRT PANEL THAT WILL NEED TO BE REMOVED SO THE ELECTRICAL CAN BE HOOKED UP TO THE SUPPORT PACK.
2. CONSULT THE SPECIFICATION SHEET TO LOCATE ALL THE PUMPS FOR YOUR SPECIFIC MODEL, THEN REMOVE THE NECESSARY SKIRT PANELS. BE SURE ALL PUMP AND HEATER UNIONS ARE SECURE. EACH PUMP HAS 2 UNIONS AND THE HEATER ALSO HAS 2 UNIONS. THE UNIONS OF A NEWLY DELIVERED SWIM SPA MAY HAVE LOOSENED DURING TRANSPORTATION. WHILE CHECKING THE UNIONS ALSO CHECK THE SLIDE VALVES ARE IN THE UP POSITION AND THE LOCK IS INSTALLED. REFER TO PICTURE BELOW.



3. INSPECT THE SWIM SPA FOR ANY DIRT OR PARTICLES THAT MAY HAVE GOTTEN ON THE SURFACE AFTER THE PLASTIC WAS REMOVED FOR THE SWIM SPA. YOU MAY NEED TO WIPE THE SWIM SPA OUT WITH A SOFT DAMP SPONGE.
4. ENSURE YOUR WATER SOURCE IS SAFE FOR HOT TUB USE. WATER MAY CONTAIN MINERALS THAT MAY CAUSE STAINS OR DEPOSITS. WATER WITH HIGH MINERAL COUNT, SUCH AS IRON OR COPPER, MAY DISCOLOR THE WATER ONCE A SANITIZER IS ADDED.
5. LET THE WATER RUN OUT OF YOUR GARDEN HOSE FOR SEVERAL MINUTES BEFORE FILLING THE SWIM SPA. THIS WILL FLUSH OUT STAGNANT WATER IN THE LINE THAT MAY CAUSE BACTERIA.
6. BEGIN FILLING THE SWIM SPA. WE RECOMMEND FILLING THE SWIM SPA UNTIL THE HIGHEST JETS ARE COVERED. DURING THE FILLING PROCESS PERIODICALLY CHECK THE UNIONS TO ENSURE THEY ARE TIGHT AND NO WATER IS LEAKING OUT.
7. ONCE THE SWIM SPA IS FILLED TURN THE CIRCUIT BREAKER ON. THE SPA WILL TURN ON AND START THE CIRCULATION PUMP TO FIND THE CURRENT WATER TEMPERATURE.
8. IT MAY BE NECESSARY TO BLEED AIR FROM THE PUMP OR PUMPS ON YOUR SWIM SPA, IF AFTER START UP YOUR SWIM SPA PUMPS DO NOT OPERATE. DUE TO THE NATURE OF WATER FLOW AND HYDRO-THERAPY PUMPS, PLEASE BE ADVISED THAT AIR LOCKING OF PUMPS MAY OCCUR. PDC SPAS HAS TAKEN MEASURES TO REDUCE THE POSSIBILITY OF THIS, BUT IT STILL MAY OCCUR, ESPECIALLY AFTER REFILLING A SWIM SPA. THIS IS NOT A SERVICE COVERED UNDER WARRANTY. TO RELIEVE AN AIRLOCK SITUATION, LOOSEN THE PUMP UNION ON THE DISCHARGE SIDE OF THE PUMP. YOU MAY POSSIBLY HEAR AIR COME OUT WHEN UNION IS LOOSENED, AFTER A FEW SECONDS TIGHTEN THE UNION. TURN THE PUMP ON TO SEE IF PROPER JET FLOW HAS BEEN ACHIEVED. IF PROPER JET FLOW HAS NOT BEEN ACHIEVED REPEAT PROCESS.
9. ADJUST WATER CHEMISTRY ACCORDING TO THE INSTRUCTIONS PROVIDED IN WATER CHEMISTRY GUIDELINES SECTION. THE SWIM SPA WATER WILL HEAT APPROXIMATELY 1– 2 DEGREES AN HOUR. TIMES MAY VARY.

SWIM SPA INSTALLATION



INSTALLING THE THERMAL COVER

REMOVE THE SWIM SPA COVER FROM THE BOX AND PLACE IT ON THE SWIM SPA. PULL DOWN ONE OF THE STRAPS ON THE SWIM SPA COVER AND HOLD LATCH AGAINST THE CABINET SIDE PANEL. TO POSITION THE LOCK CORRECTLY, HAVE A SECOND PERSON HOLD THE STRAP TIGHT ON THE OPPOSITE SIDE OF THE SWIM SPA COVER. THE SWIM SPA COVER MUST BE TIGHT. DO NOT PLACE THE LATCH OVER THE GROOVES OF THE CABINET FINISH. REMOVE THE LATCH FROM THE LOCK, ATTACH THE LOCK TO THE CABINET SIDE PANEL WITH THREE #4 SCREWS PROVIDED. ATTACH THE OTHER THREE LOCKS TO THE CABINET IN THE SAME MANNER.

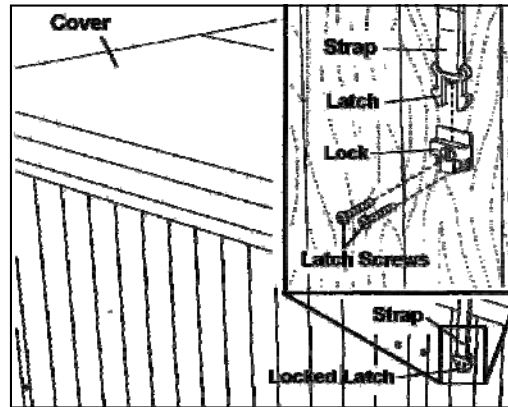

TO SECURE THE HOT TUB COVER, SNAP THE LATCHES ON THE SWIM SPA COVER INTO THE LOCKS ON THE CABINET SIDE PANEL. TO LOCK THE COVER IN PLACE, INSERT THE KEY AND TURN IT CLOCKWISE 1/4 TURN. TO UNLOCK THE LATCHES, INSERT THE KEY AND TURN IT COUNTERCLOCKWISE 1/4 TURN. ALWAYS KEEP THE COVER LOCKED WHEN THE SWIM SPA IS NOT IN USE. KEEP THE KEYS IN A SAFE PLACE, OUT OF THE REACH OF CHILDREN.

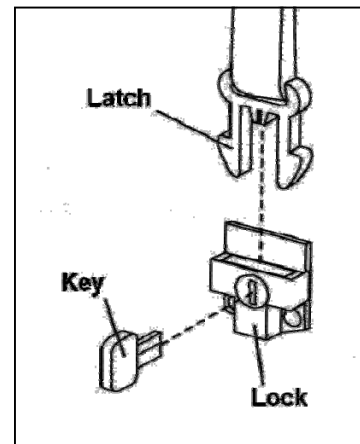

WIRING INSTALLATION



WIRING GUIDELINES

ALL EQUIPMENT MODELS ARE 120/240 VOLT, 60 CYCLE FOR STATE-SIDE, U.S. INSTALLATIONS, AND 50 HZ FOR EXPORT, CE, INSTALLATIONS.

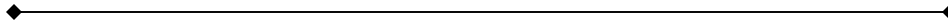

- ALL SWIM SPAS MUST BE PERMANENTLY CONNECTED.
- ALL SWIM SPA SUPPORT SYSTEMS ARE MULTIPLE SUPPLY CIRCUITS.
- ALL SWIM SPA SYSTEMS REQUIRE THE INSTALLATION OF A GROUND FAULT CIRCUIT INTERRUPTER PROTECTOR (GFCI) OR EQUIVALENT; RCD, FOR EXPORT INSTALLS, AT THE POWER SOURCE (NOT SUPPLIED) BY A QUALIFIED ELECTRICIAN IN ACCORDANCE WITH ALL CODES AND REGULATIONS. REFER TO TYPICAL G.F.C.I. INSTALLATION ON FOLLOWING PAGE.
- PRIOR TO EACH USE, TESTING OF THE GFCI (OR EQUIVALENT) IS REQUIRED. REFER TO THE MAINTENANCE SECTION OF THIS MANUAL FOR INSTRUCTIONS.
- ALL SWIM SPA SUPPORT EQUIPMENT MUST BE BONDED (GROUNDED) TO THE PRESSURE CONNECTOR LOCATED WITHIN THE CONTROL PANEL, AS WELL AS THE BONDING TERMINAL LOCATED ON THE OUTSIDE OF THE CONTROL PANEL. (see wiring schematic below)
- DISCONNECT ALL ELECTRICAL SUPPLIES AND CONTACT A QUALIFIED TECHNICIAN BEFORE SERVICING.
- ALL SWIM SPA INSTALLATIONS ARE TO BE PERFORMED BY A LICENSED ELECTRICIAN AND IN ACCORDANCE WITH ALL LOCAL AND NATIONAL CODES.

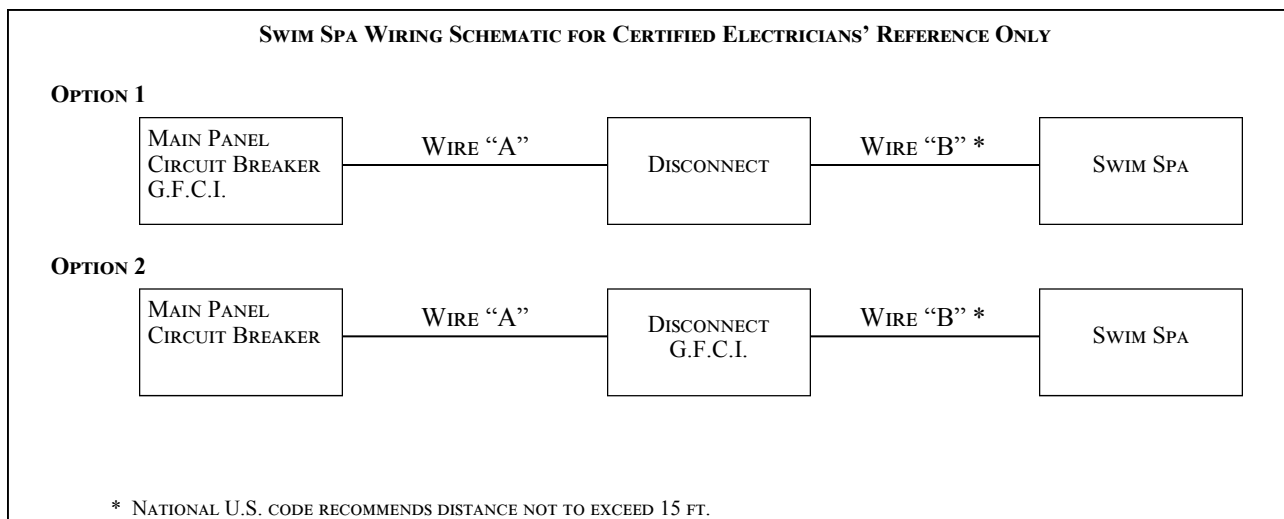

WIRING INSTALLATION—STATE-SIDE GUIDELINES**WIRING GUIDELINES - STATE-SIDE (U.S. INSTALLATIONS)****ATTENTION ELECTRICIAN:**

ALL PDC SWIM SPA UNITS MUST BE INSTALLED WITH AN APPROVED G.F.C.I. IN ACCORDANCE WITH ALL APPLICABLE CODES. INSTALLATION OF G.F.C.I. VARIES AMONG THOSE MANUFACTURERS. FOLLOW EACH MANUFACTURER'S GUIDELINES TO ENSURE PROPER OPERATION AND PROTECTION OF SWIM SPA OCCUPANTS. THIS DIAGRAM IS A "TYPICAL" INSTALLATION TO BE USED ONLY AS A REFERENCE FOR THE INSTALLING ELECTRICIAN.

**TYPICAL INSTALLATION BREAKER BOX
CLASS A 50 AMP, 120/240 VOLT, GFCI**

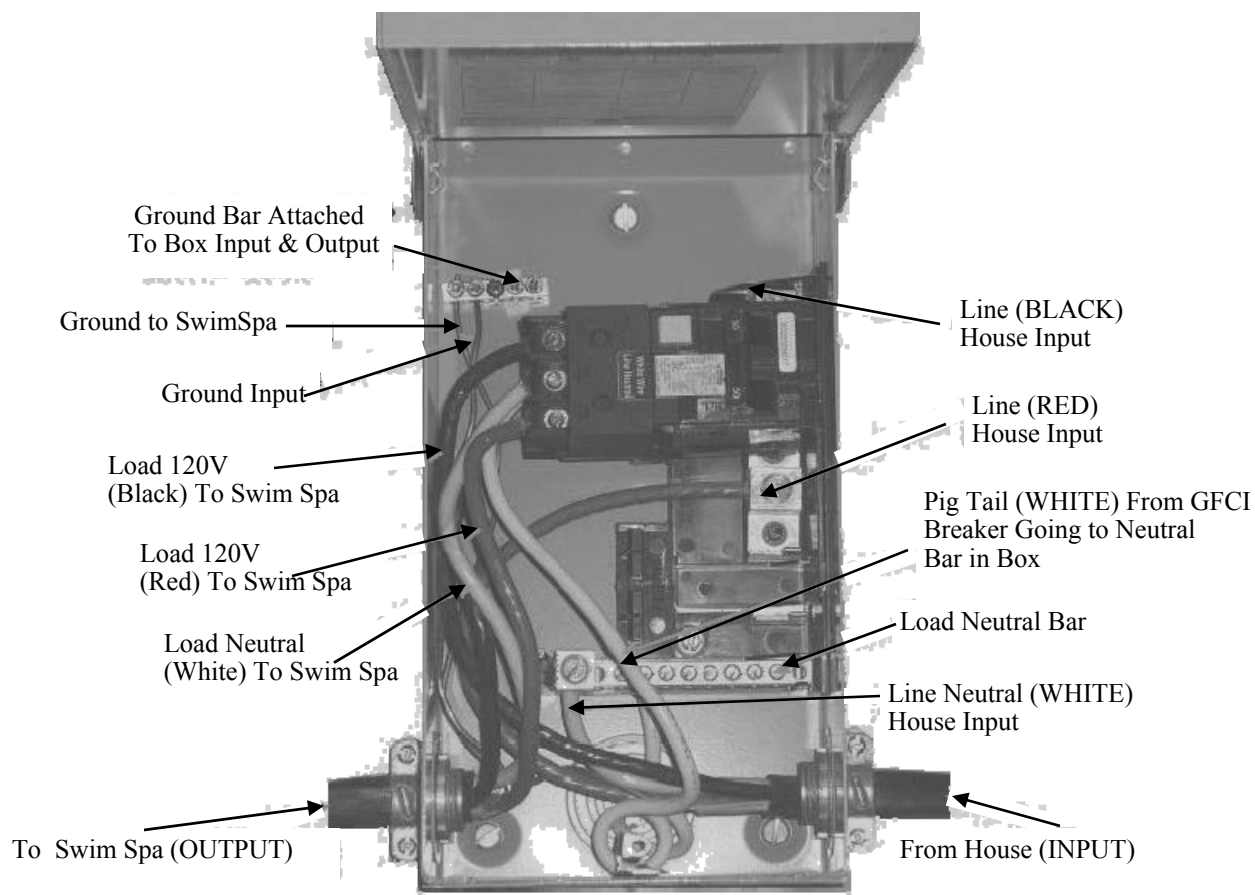

TO BE NOTED: Installation of this GFCI Circuit Breaker, including ampere sizing and choice of qualified electrician in accordance with the National Electrical Code, and all applicable federal, state and local codes and regulations in effect at the time of installation.

TO BE NOTED: The white neutral wire from the back of the GFCI Circuit Breaker **MUST** be connected to an incoming Line Neutral. The internal mechanism of the GFCI requires this Neutral connection for proper GFCI function.

**IMPORTANT: 6 GAUGE COPPER WIRE MUST BE USED
TEST GFCI MONTHLY AND PRIOR TO EACH USE.**

WIRING INSTALLATION—EXPORT GUIDELINES IN.XM CE



INSTALLATION GUIDELINES for IN.XM CE

ALL INSTALLATIONS AND CONNECTIONS ARE TO BE PERFORMED BY A QUALIFIED, LICENSED ELECTRICIAN ONLY AND IN ACCORDANCE WITH LOCAL REGULATIONS. IDENTIFY THE CORRECT CE PLATFORM ON THE SWIM SPA UNIT, IN ACCORDANCE WITH THE HOME'S ELECTRICAL OUTPUT, AND FOLLOW THE GUIDELINES BELOW. ENSURE POWER IS TURNED OFF PRIOR TO MAKING ANY ELECTRICAL CONNECTIONS.



Warning!

This product must always be connected to a circuit protected by a residual-current device (RCD) having a rated operating residual-current not exceeding 30 mA. Proper wiring of the electrical service box, RCD and in.xm.ce terminal block is essential! Check your electrical code for local regulations. Only copper wire should be used, never aluminum.



Standard with 600 Series control

IN.XM PLATFORM CONTROL CENTER

1 x 230 V ~ (1 x 32A) single phase,
or
1 x 230 V ~ (2 x 16A) dual phase,
or
1 x 230 V ~ (3 x 16A) three phase



450 Series control



WHEN INSTALLING THE IN.XM.CE POWER BOX WE RECOMMEND THE FOLLOWING:

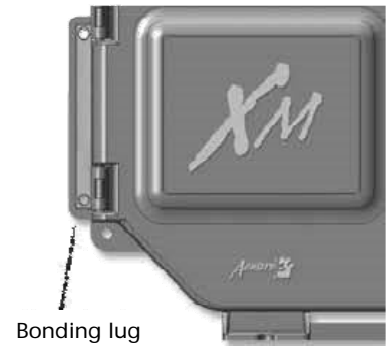

Bonding lug

To install the wiring for the in.xm.ce spa control, you'll need a Phillips screwdriver, a 14 mm (9/16") nut driver or a flat screwdriver. Loosen the 2 screws of the spa pack door and open it. Remove 200 mm (8") of cable insulation. Strip away 25 mm (1") of each wire insulation. Pull the cable through the cutout of the box and use an IEC certified plastic bushing that will maintain the IPX5 rating. Also, the power cord must be in accordance with the national electrical code of the country in which it's to be installed and must maintain IPX5 rating. Make sure that only the uncut sheathing is clamped at this opening. Push the color-coded wires into the terminals as indicated on the sticker, use the 14mm (9/16") wrench or flat screwdriver to tighten the bolts on the terminals. After making sure wire connections are secure, push them back into the box and close the door. Tighten the 2 screws of the spa pack door.

Connect the bonding conductor to the bonding lug on the left side of the in.xm.ce spa pack (a grounded electrode conductor shall be used to connect the equipment grounding conductors).

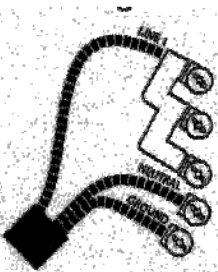

1x230 V ~ (1x32A)
Single phase

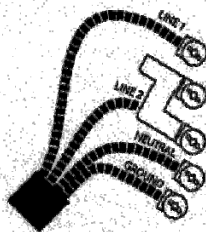

1x230 V ~ (2x16A)
Dual phase

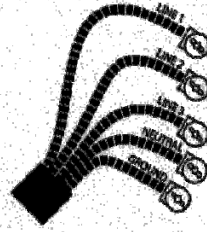

1x230 V ~ (3x16A)

An IEC certified bushing that will maintain the IPX5 rating must be used. The power cord must be in accordance with the national electrical code of the country in which the in.xm.ce is to be installed.

Dual phase system: two electrical phases out of a three-phase power system. It's important to note that on a polyphase power system, all electrical phases must share the same neutral.

Make sure all accessories are linked to the bonding connector and connected to the pack. Electrical connections should be made only by qualified personnel and in accordance with local regulations.

WIRING INSTALLATION—EXPORT GUIDELINES IN.XM CE

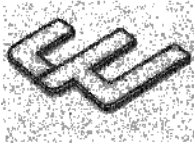

Case 1 Single-phase 1 x 230 VAC (32 A max)

The installation of electrical circuit jumpers is needed in certain input supply configurations.

Use uncut jumper as supplied in the case of an input supply wiring,

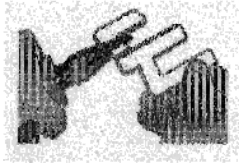

Case 2 Dual-phase 1 x 230 VAC (2 x 16 A max)

For this input supply wiring, you will need to cut off a portion of jumper piece. Proceed as follows:

Use pliers to firmly hold upper half of the metal jumper, then break off other half.

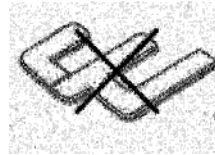

Case 3 Three-phase 1 x 230 VAC (3 x 16 A max)

Please note that in a three-phase system, no jumper installation is required.

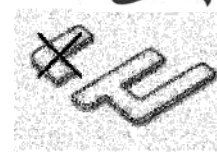

Important!
Safely dispose of the discarded portion in accordance with the local waste disposal legislation in force.

POWERING UP the IN.XM CE



Bonding lug

Make sure all accessories are linked to the bonding connector and connected to pack.

Make sure the spa pack door is closed.

Turn on the breaker.

It is important to specify the phase configuration setting at the power supply: single phase (1P), dual phase (2P), or three phase (3P) (see configuration below)

LOW LEVEL CONFIGURATION	SWIM SPA COMPONENT			
	PUMP1	PUMP2	PUMP3	BLOWER
LL1	X			
LL2	X	X		
LL3	X	X	X	
LL4	X	X	X	X

NOTE: Low level programming (LL) has been factory preset. In the course of setting the incoming power should “LL” be shown on screen, there should be no changes made to this setting. Immediately exit the LL menu by pushing the select button. If the LL configuration was changed, refer to chart above to review proper LL settings.

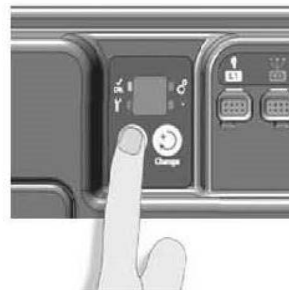
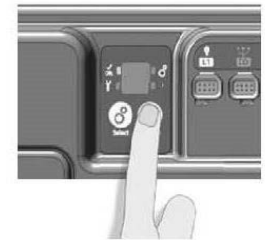

Press **Select** button to select proper phase configuration setting. The in.scan display will show “xP”, with “X” representing the number of phases of the electric power system.

RCD	Br
1X32A	1P
2X16A	2P
3X16A	3P

Use **Change** button to go from one parameter to the next.

Press **Select** button again to make the correct selection.

All receptacles will match the corresponding female connection on the spa pack.

No connections should remain unplugged. Use blank plugs to fill unused connectors.

CONFIGURING the IN.XM CE

Description: Phase setting appears (P) at power up. Press **Change** button to choose proper phase setting. Press **Select** button to lock in proper phase. Breaker setting appears (BR). Press **Change** button to choose proper breaker setting. **Select** button is used to access the phase configuration setting menu (short press) as well as the low level programming menu (press and hold for 5 seconds). Subsequent presses will save changes and display the next option available or exit automatically if it was the last one. Use **Change** button to change the parameters displayed. Note: this procedure has to be performed after every learning mode.

Setting the Learning Mode: The in.xm.ce pack has the ability to verify and “learn” the current consumption of every output connected to it. If an output is replaced, a new learning must be done. Follow these simple steps.

Press and hold **Select** button for 5 seconds to activate low level programming. Once activated, the display shows “LL” ad, I succession, the current preset low level configuration selected.

Press **Change** button repeatedly to select the same preset low level configuration again.

Press **Select** to confirm. You will exit menu automatically. The in.xm.ce will then reset. After resetting, the system starts a “learning sequence” in which each individual output is activated and its peak current displayed and saved.

Note: if unusual current readings, e.g. 4 to 6 amps are detected on high speed of any pump, all pumps must be primed, learning mode restarted.

WIRING INSTALLATION—EXPORT GUIDELINES IN.XE CE



INSTALLATION GUIDELINES for IN.XE CE

ALL INSTALLATIONS AND CONNECTIONS ARE TO BE PERFORMED BY A QUALIFIED, LICENSED ELECTRICIAN ONLY AND IN ACCORDANCE WITH LOCAL REGULATIONS. IDENTIFY THE CORRECT CE PLATFORM ON THE SWIM SPA UNIT, IN ACCORDANCE WITH THE HOME'S ELECTRICAL OUTPUT, AND FOLLOW THE GUIDELINES BELOW. ENSURE POWER IS TURNED OFF PRIOR TO MAKING ANY ELECTRICAL CONNECTIONS.

Warning! This product must always be connected to a circuit protected by a residual-current device (RCD) having a rated operating residual-current not exceeding 30 mA. Proper wiring of the electrical service box, RCD and in.xe.ce terminal block is essential! Check your electrical code for local regulations. Only copper wire should be used, never aluminum.



IN.XE PLATFORM CONTROL CENTER

1 x 230 V ~ (1 x 32A) single phase,
or
1 x 230 V ~ (2 x 16A) dual phase

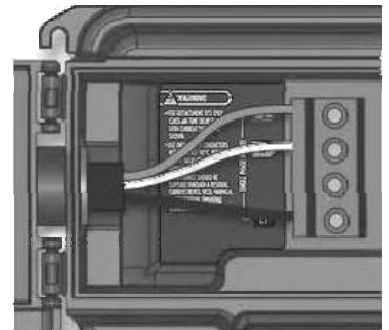
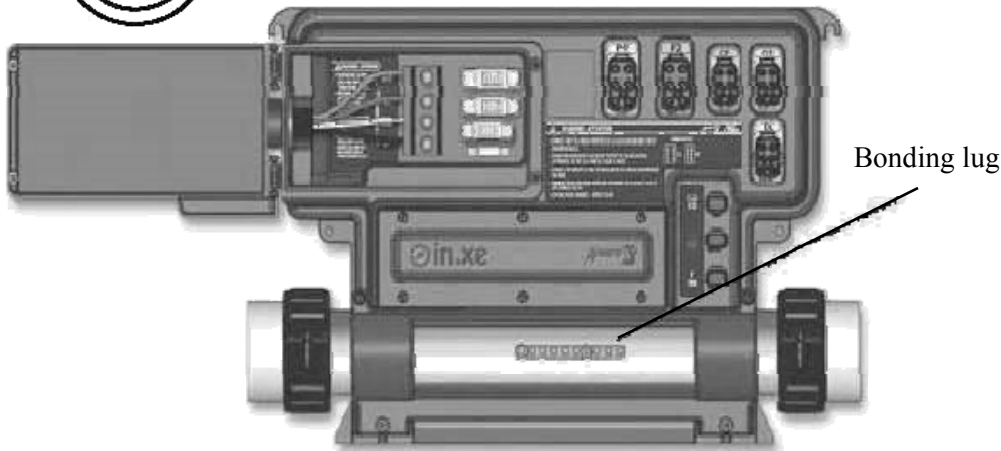

In.XE CE 230 V ~ Single phase ONLY

Correct wiring of the electrical service box, RCD protection device, and pack terminal block is essential!

Contact qualified, licensed electrician.

IN.XE.CE ELECTRICAL SPECIFICATIONS:

- Input rating: 230 V ~ nominal
- (Single phase input Only; multi-phase not supported)
- 32 A absolute maximum, 50 Hz nominal.

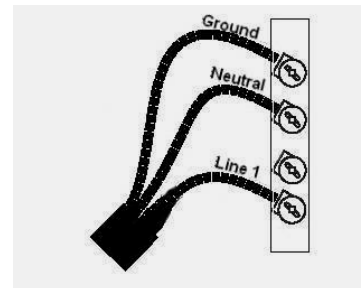

WIRING INSTALLATION



INSTALLATION GUIDELINES FOR DUAL HEATER INSTALLATIONS MODELS FX14-DH, FX15-DH, FX17-DH

ALL INSTALLATIONS AND CONNECTIONS ARE TO BE PERFORMED BY A QUALIFIED, LICENSED ELECTRICIAN ONLY AND IN ACCORDANCE WITH LOCAL REGULATIONS. IDENTIFY THE CORRECT CE PLATFORM ON THE SWIM SPA UNIT, IN ACCORDANCE WITH THE HOME'S ELECTRICAL OUTPUT, AND FOLLOW THE GUIDELINES BELOW. ENSURE POWER IS TURNED OFF PRIOR TO MAKING ANY ELECTRICAL CONNECTIONS.



Warning!

This product must always be connected to a circuit protected by a residual-current device (RCD) having a rated operating residual-current not exceeding 30 mA. Proper wiring of the electrical service box, RCD and in.xe.ce terminal block is essential! Check your electrical code for local regulations. Only copper wire should be used, never aluminum.

THE FOLLOWING INFORMATION IS FOR DUAL HEATER INSTALLATIONS FOR BOTH NORTH AMERICAN AND INTERNATIONAL.

THE DUAL HEATER OPTION MAKES USE OF TWO SEPARATE XE SUPPORT PACKS. THE ADDITION OF A SECOND SUPPORT PACK AND HEATER WILL ALLOW FOR FASTER HEATING OF THE WATER IF DESIRED.

THE TWO SEPARATE SUPPORT PACKS ARE CONNECTED TOGETHER VIA A COMMUNICATIONS CABLE. THEY MAKE USE OF THE 600 SERIES GECKO MAIN CONTROL AS WELL AS THE 100 SERIES PARTNER CONTROL

THE DUAL HEATER OPTION WILL REQUIRE A SEPARATE SERVICE FOR EACH SPA PACK (MASTER AND SLAVE). PLEASE REFER TO THE DIAGRAMS BELOW. PLEASE CONSULT YOUR RETAILER IF THERE ARE ANY QUESTIONS ABOUT THE DUAL HEATER OPTION.

BELOW ARE THE SPECIFICATION FOR THE DUAL HEATER EQUIPMENT SYSTEM

Dual Heater Equipment Specifications	Domestic (60 Hz)	Export (50 Hz)
Master Spa Pack	Gecko XE Series	Gecko XE Series
Voltage	240V	240
Amperage	50A	1x32
Circulation Pump	2.0 (1.0) HP	2.0 (1.0) HP
Heater	4.0 Kw	3.8 Kw
Slave Spa Pack	Gecko XE Series	Gecko XE Series
Voltage	240V	240V
Amperage	50A	1x32
Fitness Pump	6.0 (3.0) HP	6.0 (3.0) HP
Fitness Pump	6.0 (3.0) HP	6.0 (3.0) HP
Heater	4.0 Kw	3.8 Kw

Note- The dual heater option will require running two separate electrical supply lines one for each spa pack. All equipment must be ground fault circuit protected (GFCI not supplied) at the power source. All electrical wiring of the spa support equipment must comply with the National Electric Code.

WIRING INSTALLATION



**INSTALLATION GUIDELINES FOR DUAL HEATER INSTALLATIONS
MODELS FX14-DH, FX15-DH, FX17-DH**

ALL INSTALLATIONS AND CONNECTIONS ARE TO BE PERFORMED BY A QUALIFIED, LICENSED ELECTRICIAN ONLY AND IN ACCORDANCE WITH LOCAL REGULATIONS. IDENTIFY THE CORRECT CE PLATFORM ON THE SWIM SPA UNIT, IN ACCORDANCE WITH THE HOME'S ELECTRICAL OUTPUT, AND FOLLOW THE GUIDELINES BELOW. ENSURE POWER IS TURNED OFF PRIOR TO MAKING ANY ELECTRICAL CONNECTIONS.

Warning! This product must always be connected to a circuit protected by a residual-current device (RCD) having a rated operating residual-current not exceeding 30 mA. Proper wiring of the electrical service box, RCD and in.xe.ce terminal block is essential! Check your electrical code for local regulations. Only copper wire should be used, never aluminum.

THE SUPPORT PACKS ON THE DUAL HEATER OPTION ARE PLUMBED INLINE, AS SHOWN HERE.

Swim spa installation scheme

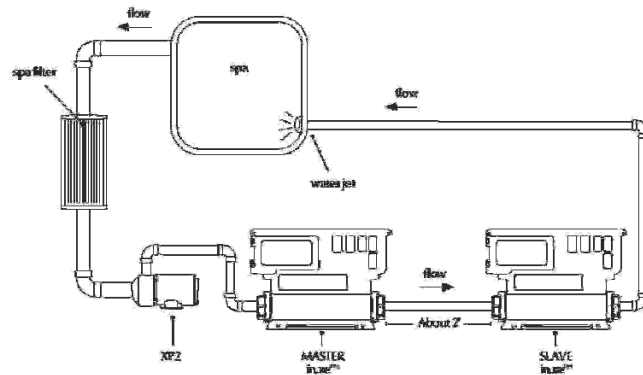

BELOW YOU WILL FIND SAMPLE WIRING DIAGRAMS. THESE DIAGRAMS WILL SHOW AN EXAMPLE OF HOW THE TWO SPA PACK SHOULD BE WIRED. THERE IS AN EXAMPLE FOR NORTH AMERICA AS WELL AS INTERNATIONAL.

Electrical wiring North American model in.xe.ce - 2 breakers

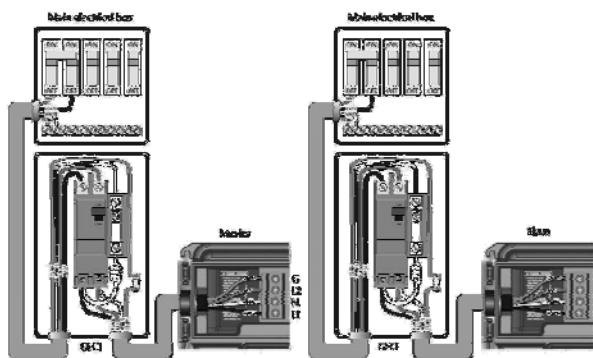

Electrical wiring European model in.xe.ce - dual phases

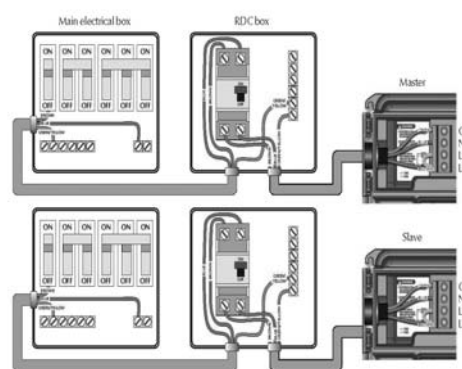

WARNING: THIS WIRING DIAGRAM IS FOR REFERENCE USE ONLY. ALL EQUIPMENT MUST BE GROUND FAULT CIRCUIT PROTECTED AT THE POWER SOURCE (GFCI NOT SUPPLIED). ALL ELECTRICAL WIRING OF THE SWIM SPA SUPPORT EQUIPMENT MUST COMPLY WITH THE NATIONAL ELECTRIC CODE AND ANSI/NFPA.

INITIAL START-UP



GENERAL GUIDELINES

1. BE SURE THAT THE POWER IS TURNED OFF AT THE MAIN CIRCUIT BREAKER.
2. CAUTION: ELECTRIC HEATER ELEMENT MUST BE FULLY SUBMERGED IN WATER BEFORE BEING ENERGIZED.
3. FILL SWIM SPA TO THE RECOMMENDED LEVEL, ASSURING ALL SUCTION OUTLETS ARE COVERED WITH WATER.
4. MAKE SURE VALVES ON THE SUCTION AND RETURN SIDES OF THE SWIM SPA PUMP ARE OPEN TO ALLOW WATER TO FLOW TO AND FROM THE SWIM SPA AND SWIM SPA SUPPORT SYSTEM.
5. TURN POWER "ON" AT MAIN CIRCUIT BREAKER.
6. PRESS JET / PUMP BUTTON TO ACTIVATE CYCLE.
7. TURN ALL AIR REGULATOR KNOBS TO "OFF" POSITION.
8. WHEN THE SYSTEM HAS FULLY PRIMED, ALL THE JETS SHOULD BE FREELY ROTATING AND FREE OF EXCESS AIR; EXCEPT THE JETS ATTACHED TO OZONE, IF THIS OPTION IS INCLUDED ON THE SYSTEM. ALLOW THE SYSTEM TO OPERATE FOR FIVE MINUTES IN THIS POSITION.
9. SET THE THERMOSTAT TO THE DESIRED TEMPERATURE TO BEGIN HEATING THE SWIM SPA WATER. THE INDICATOR ICON ON THE SPA SIDE CONTROL WILL BE ON WHEN THE SWIM SPA IS HEATING.
10. THE ECONOMICAL, GRADUAL HEATING OF THE WATER TAKES PLACE OVER A NUMBER OF HOURS, DEPENDING UPON THE SIZE OF THE SWIM SPA, SIZE OF THE HEATER AND THE RECOMMENDED USE OF A PDC SWIM SPA COVER. WHEN THE DESIRED TEMPERATURE IS REACHED, NOT OVER 104°F (40°C). LEAVE THE THERMOSTAT AT THIS SETTING, THE TEMPERATURE WILL AUTOMATICALLY BE MAINTAINED. RE-CHECK WATER TEMPERATURE WITH AN ACCURATE THERMOMETER BEFORE ENTERING THE SWIM SPA.
11. SET THE FILTRATION PROGRAM TO DESIRED SETTING PER INSTRUCTIONS FOUND IN THE CONTROL CENTER SECTION OF THIS MANUAL.
12. CHEMICALLY TREAT THE SWIM SPA WATER. READ THE SECTION ON WATER CHEMISTRY MAINTENANCE AND FOLLOW INSTRUCTIONS ON CONTAINER OF ANY PRODUCT USED.
13. COVER THE SWIM SPA WITH THERMAL COVER TO MAINTAIN TEMPERATURE AND LOCK FOR SAFETY.

OPERATION SYSTEMS -600 SERIES CONTROL



WARNING: READ ALL INSTRUCTIONS BEFORE USING THE SWIM SPA. PDC Spas, PDC International assumes no responsibility for personal injury or property damage sustained by or through the use of this product. When installing and using this equipment basic safety precautions should always be taken to reduce risk of electrical shock, ensure safe usage, and safeguard the user's health.

In.K 600 Series Control

Standard control on FX Swim Spas.



In.K 100 Partner Control (optional)

This control offers convenience of spa operation at a second location. Operates pumps 1, 2, 3 and light.



Window and Icons

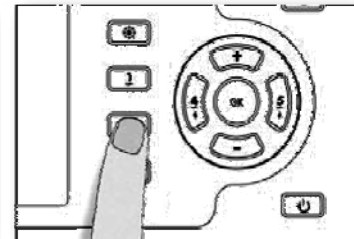
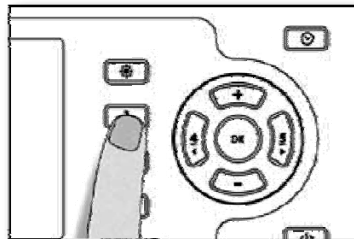
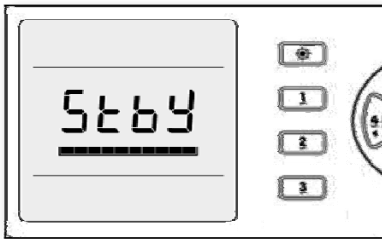
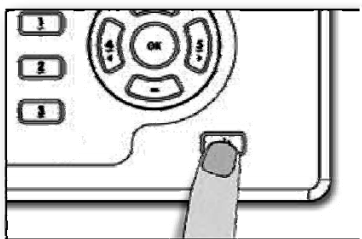
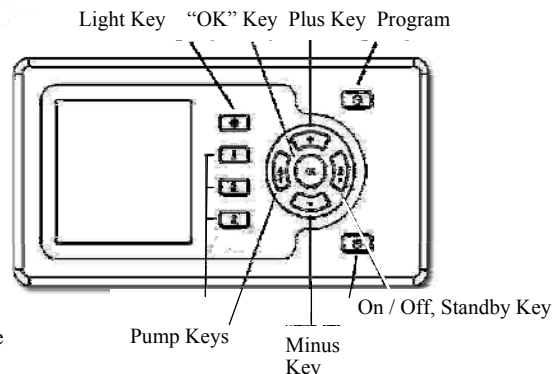
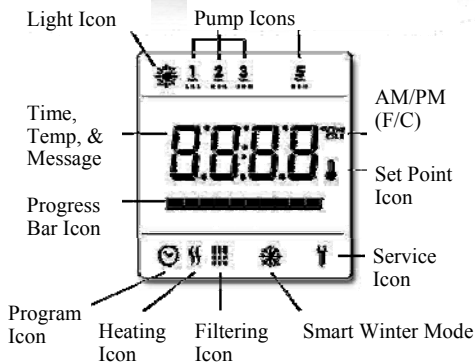

On / Off Key

Standby Mode: This mode allows you to stop all outputs and automatic functions with the exception of the heat request for 30 minutes. To enter the standby mode, press and release On/Off key. The display will toggle between the "Stby" message and the water temp. Press the On/Off key again to restart the system before the

expiration of the 30 minute delay. The spa light will flash a few seconds before the end of the 30 minutes to warn the system is about to resume.

** Pump will stay turned on if there is a request for more heat.*

Pump 1 key

Press **Pump 1** key to turn Pump 1 on at low speed. Press a second time to turn pump to high speed. Another press turns pump off.

A built-in timer automatically turns pump off after 20 minutes, unless pump has been manually deactivated first.

Pump 2 key

Press **Pump 2** key to turn Pump 2 on at low speed. Press a second time to turn pump to high speed (with a dual speed pump). Press another time to turn pump off.

A built-in timer automatically turns pump off after 20 minutes, unless pump has been manually deactivated first.

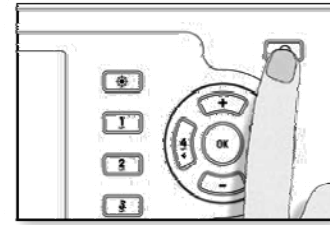
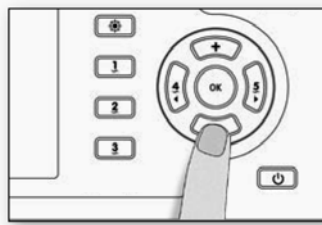
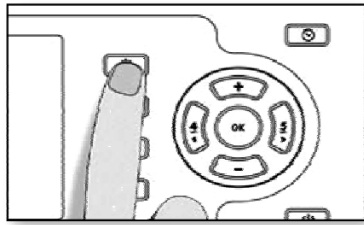
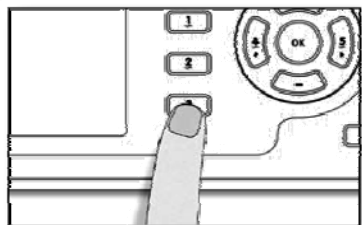

Pump 3 key

Press **Pump 3** key to turn Pump 3 on at high speed.

Press a second time to turn pump off.

A built-in timer automatically turns pump off after 20 minutes, unless pump has been manually deactivated first.

Light key

Press **Light** key to turn light on.

Press a second time to turn light off. Repeatedly turning on/off key toggles between color selections.

A built-in timer automatically turns light off after 2 hours, unless it has been manually deactivated first.

+ / - keys

Use (+) or (-) key to set desired water temperature. The temperature setting will be displayed for 5 seconds to confirm your new selection.

The "set point" icon indicates the display shows the desired, NOT the current water temperature.

Program key

Use **Program** key to display time or enter Programming menu by pressing, holding key.

In Programming mode, the following parameters can be set: time, filter cycle's start time, duration, frequency, and the choice of temp. display units.

OPERATION SYSTEMS -600 SERIES CONTROL

PDC
spas

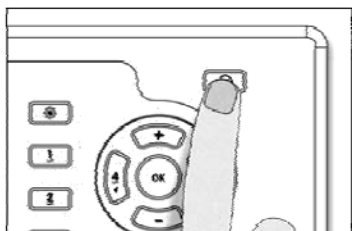

Setting the time

Enter Programming mode by holding Prog. key pressed down for 3 sec. The display will show the current time setting.

Setting hour: Use (+) or (-) key to change hour setting (AM/PM).

Setting minutes: Press **Ok** key. Use (+) or (-) key to change minutes setting.

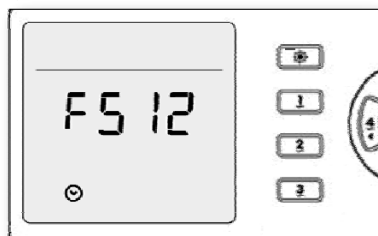

Setting filter cycle start time

To program the filter cycle, enter these parameters: start time, duration and frequency. During a filter cycle, pumps run for one minute to purge the plumbing, then Pump 1 low speed runs for the programmed number of hours.

Press **Ok** key a second time. The display will show FSxx, with "xx" representing the starting hour. Use (+) or (-) key to change setting

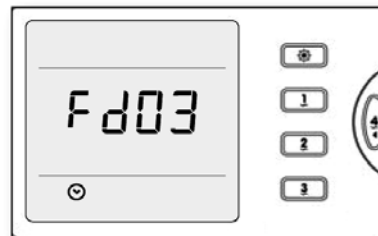

Setting filter cycle duration

Press **Ok** key a third time.

The display will show Fdxx, with "xx" representing the duration in hours. Use (+) or (-) key to change setting (0-12 hours).

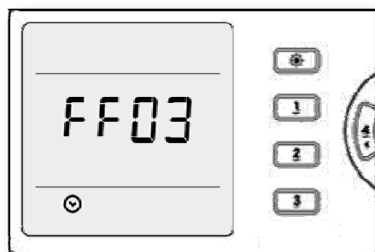

Filter cycle frequency

Press **Ok** key a fourth time.

The display will show FFxx, with "xx" representing the number of filter cycles per day (up to 4).

Use (+) or (-) key to change setting.

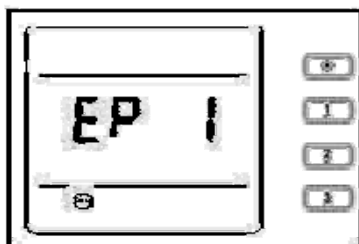

Setting Economy Mode

This allows a lower water temp by 20° F below the actual set point during a certain period of the day.

The display will show EPx, "x" representing the state of the programmed economy, (0=disable, 1=enable). Use the Up or Down key to set the program economy to enable or disable. Use the Program or OK key to jump to the next parameter, economy start (ES)



Setting Economy Start Time

The display will show ESxx, "xx" representing the hour at which the economy mode will become active. Use the Up or Down key to adjust the hour. Use the Program or OK key to jump to the next parameter, economy end time (EE).

When the Economy mode is ON, the display will toggle between the "Econ" message and the water temp.

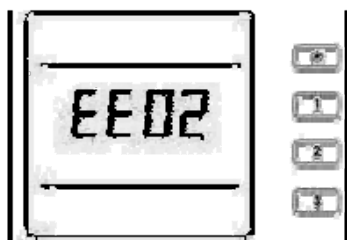

Setting Economy End Time

The display will show EExx, "xx" representing the hour at which the system will resume its normal operation. Use the Up or Down key to adjust the hour.

Use the Program or OK key to jump to the next parameter, temp unit (tu).



Setting Temperature Unit

Water temperature can be displayed in either Fahrenheit (°F) or Celsius (°C).

- Press **Ok** key a fifth time.
- The display will show either °F or °C.
- Use (+) or (-) key to change setting.
- Press **Ok** key a last time to go back to normal mode.

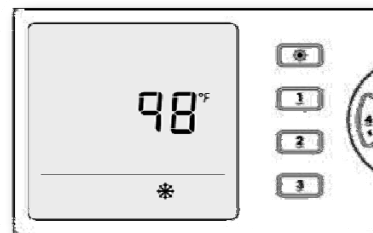

Smart Winter Mode

Our Smart Winter Mode protects system from the cold by turning pumps on several times a day to prevent water from freezing in pipes.

Cooldown

While performing these tasks, the heater is not allowed to turn on and its icon flashes. Heater is not allowed to come on throughout the cool down period of the element.

OPERATION SYSTEMS -600 SERIES CONTROL
In.K 600 Series Control
 Standard control on FX Swim Spas

Manual Economy Mode

This allows energy savings by regulating the water temp 20° F below the actual set point. To enter the manual economy mode, press for 5 seconds on the On/Off key. The display will toggle between the "Econ" message and the water temp.

Press for 5 seconds again on the On/Off key to exit the manual economy mode.

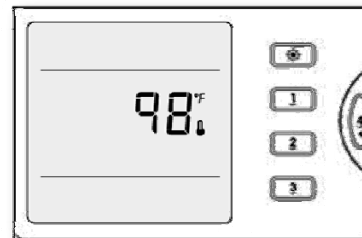
Water temperature regulation

In a regulation cycle, the system first generates water flow through the heater housing and the plumbing to ensure accurate water temperature readings and avoiding heater activation in dry conditions.

After verifying pump activation and taking a water temperature reading if required, system automatically turns heater on to reach and maintain water temperature at Set Point.

Light icon: The "Light" icon lights up when the light is on.

Pumps icon: The "Pump" indicator numbers light up and their icons become animated when pumps are on.

Smart winter mode icon: The "SWM" icon automatically turns on when freeze protection is active. It flashes while system purges the spa plumbing.

Filter Cycle icon: The "Filter Cycle" icon lights up when filter cycle is on. It flashes when filtering is suspended.

Heater icon: The "Heater" icon lights up when the heater is on.

Program icon: The "Program" icon lights up when Programming.

Progress bar: A visual indication of the time remaining before an equipment is turned off or before the end of the standby mode.

Set Point icon: The "Set Point" icon automatically turns on when set point setting menu is activated. (SP displayed). It flashes when:

- 1-there is a call for heat and heater has not started yet,
- 2-heater has just turned off and element is cooling down or,
- 3-if system is performing a check flow

Service icon: A problem has been detected. Do not enter the water! Spa service is required.

OPERATION SYSTEMS - 450 SERIES CONTROL



WARNING: READ ALL INSTRUCTIONS BEFORE USING THE SWIM SPA. PDC Spas, PDC International assumes no responsibility for personal injury or property damage sustained by or through the use of this product. When installing and using this equipment basic safety precautions should always be taken to reduce risk of electrical shock, ensure safe usage, and safeguard the user's health.



In.K 450 Series Control
FX Swim Spa

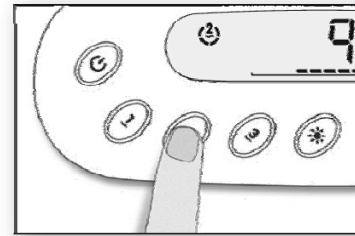
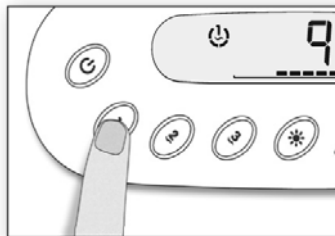
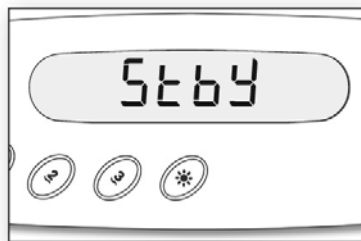
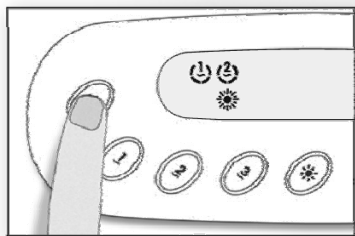
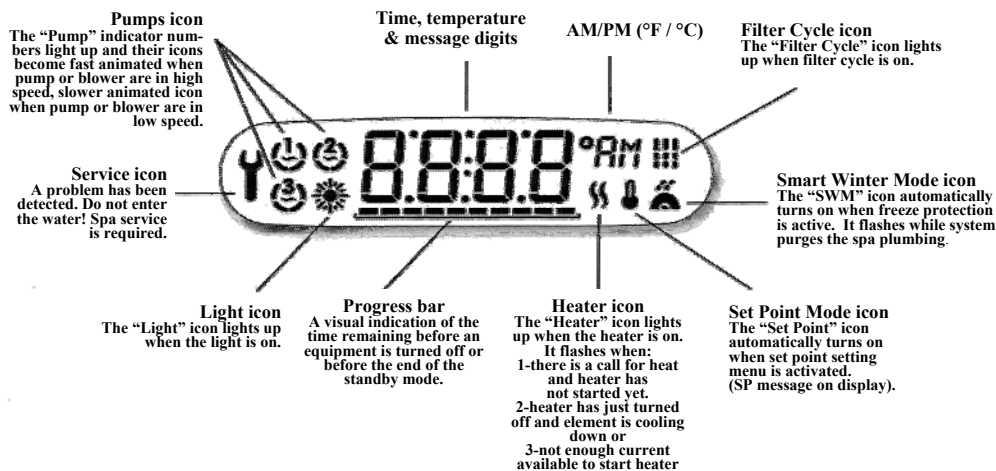

On/Off key

This mode allows you to stop all outputs including all automatic functions such as filter cycle, heat request and smart winter mode. Purge for 30 minutes to perform quick spa maintenance. When active, the display will toggle between the "OFF" message, clock and water temperature.

In order to restart the system before the expiration of the 30 minute delay, make a short press on the "ON/OFF" key. The spa light will flash a few seconds before the end of the 30 minutes to warn you the system is about to resume normal operation.

Pump 1 key

Press **Pump 1** key to turn Pump 1 on at low speed. Press a second time to turn pump to high speed (with a dual speed pump). A third time turns pump off. A built-in timer automatically turns pump off after 20 minutes, unless pump has been manually deactivated first.

Pump 2 key

Press **Pump 2** key to turn Pump 2 on at low speed. Press a second time to turn pump to high speed (with a dual speed pump). Pressing a third time turns pump off. A built-in timer automatically turns pump off after 20 minutes, unless pump has been manually deactivated first.

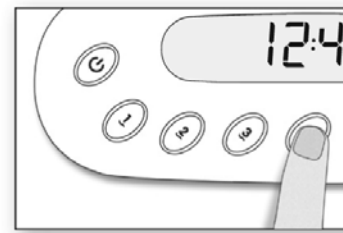
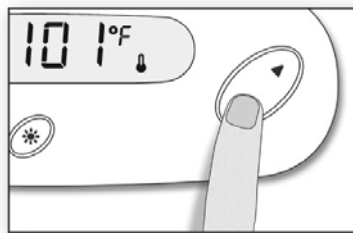
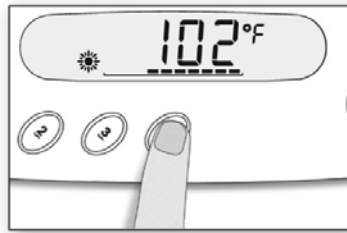
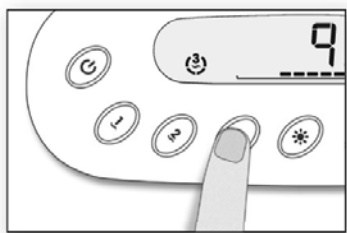

Pump 3/ Blower key

Press **Pump 3/Blower** key to turn Pump 3/Blower on. Press a second time to turn pump off. A built-in timer automatically turns pump off after 20 minutes, unless pump has been manually deactivated first.

Light key

Press **Light** key to turn light on / light off. A built-in timer automatically turns light off after 2 hours, unless it has been manually deactivated first.

Up / Down keys

Press **Up** or **Down** key to set desired water temperature. The temperature setting will be displayed for 5 seconds to confirm your new selection. The "Set Point" icon indicates that the display shows the desired temperature, NOT the current water temperature.

Program key

Use **Program** key to display time or enter Programming menu by pressing and holding key. In Programming mode, these parameters can be set: time, filter cycle start time, filter cycle duration, filter cycle frequency, temperature unit. Note: Light key used as Program key if key not present.

OPERATION SYSTEMS - 450 SERIES CONTROL



In.K 450
Series Control
FX Swim Spa

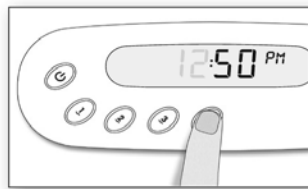

Setting the time

Enter Programming mode by holding Prog. Key pressed down for 3 sec. Display will show current time setting.

Setting the hour: Use Up or Down arrows to change the your setting (AM/PM).

Setting the minutes: Press Program Key a second time. Use **Up** or **Down** key to change minutes setting.

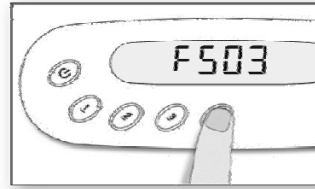

Setting filter cycle start time

To program the filter cycle, you must enter these parameters; the start time, duration and frequency. During a filter cycle, pumps run for one minute to purge plumbing, then Pump 1 runs for the programmed number of hours. Press Prog. Key a third time. The display will show FSxx, with "xx" representing starting hour. Use Up or Down key to change setting.

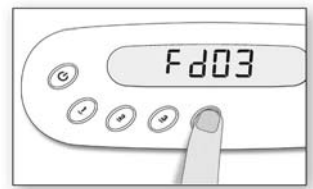

Setting filter cycle duration

Press Prog. key a fourth time. The display will show Fdxx, with "xx" representing the duration in hours.

Use Up or Down key to change setting.

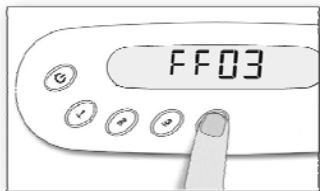

Filter cycle frequency

Press Prog. key a fifth time. The display will show FFxx, with "xx" representing the number of filter cycles per day (up to 4). Use Up or Down key to change setting.

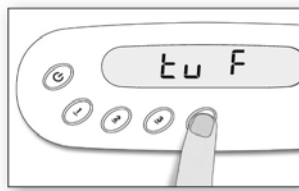

Setting temperature unit

Water temperature can be displayed in either Fahrenheit ("F") or Celsius ("C"). Press Prog. Key a sixth time. Display shows either "F" or "C".

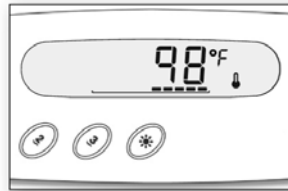

Water temperature regulation

In a regulation cycle, system first generates water flow through the heater housing and the plumbing, to ensure accurate water temperature readings, and avoiding heater activation in dry conditions. After verifying pump activation and taking water temperature reading if required, system automatically turns heater on to reach and maintain water temp at Set Point.



Smart Winter Mode

Smart Winter Mode protects your system from the cold by turning pumps on several times a day to prevent water from freezing in pipes.

Cooldown

While performing these tasks, heater is not allowed to turn on and it's icon flashes. Also, heater is not allowed to come on throughout cool down period of heater element.



Economy Mode

This mode allows you to lower the temperature set point of the spa by 20 degrees F (11 C) during a certain period of the day. To enable the economy mode: press and hold On/Off key for 10 seconds.

While the economy mode is enabled the display will toggle between "Eco" and the water temperature. Once the system goes back to normal mode the display will show "noE".

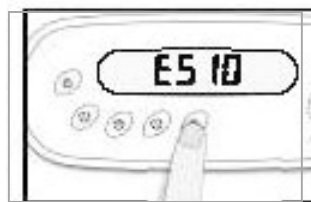

Setting economy start time

Press Prog. Key seven times. The display will show ESxx, with "xx" representing the starting hour.

Use up or down key to change settings.

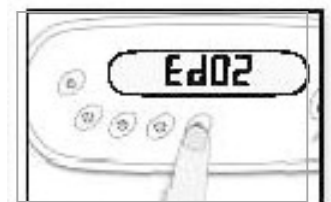

Setting Economy duration

Press and hold light key until the display shows Edxx, with "xx" representing the duration in hours. (default is 2 hrs.) Use up or down key to change settings. 0= no filtration

24= continuous filtration
Not recommended to set to "0"

AQUAFLEX TETHERED EXERCISE SYSTEM



AQUAFLEX

YOUR PDC SWIM SPA COMES STANDARD WITH THE AQUAFLEX TETHERED EXERCISE SYSTEM. WITH THIS SYSTEM YOU CAN TRANSFORM YOUR SWIM SPA IN A NEARLY STRESS FREE, IMPACT FREE TRAINING ENVIRONMENT.

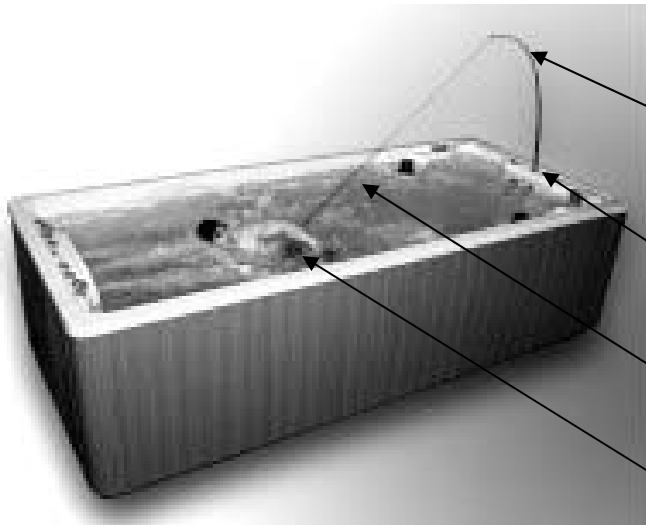

AQUAFLEX COMPONENTS



AquaFlex
Resistance Pole



Pole Mount



Tether Adjuster



Belt Assembly

USING YOUR AQUAFLEX TETHERED EXERCISE SYSTEM

USING THE AQUAFLEX IS AS EASY AS FOLLOWING A FEW SIMPLE DIRECTIONS.

1. TAKE THE AQUAFLEX FROM THE TRAVEL CASE.
2. EXTEND THE TELESCOPING AQUAFLEX TO ITS FULL LENGTH.
3. PLACE END OF AQUAFLEX INTO STAINLESS STEEL POLE MOUNT LOCATED ON THE LIP OF THE SWIM SPA.
4. TAKE THE BELT ASSEMBLY AND PUT IT AROUND YOU WAIST.
5. USE THE TETHER ADJUSTER TO LENGTHEN OR SHORTEN THE TETHER AS NEEDED
6. TAKE A FEW SAMPLE STROKES TO MAKE SURE FURTHER TETHER ADJUSTMENTS ARE NOT NEEDED.
7. WHEN DONE EXERCISING TAKE AQUAFLEX OUT OF THE SWIM SPA AND RETURN IT TO ITS CASE FOR STORAGE.

WATER CHEMISTRY GUIDELINES**WATER CHEMISTRY MAINTENANCE**

IMPROPER USE OF SWIM SPA CHEMICALS MAY BE DANGEROUS AND COULD DAMAGE YOUR HOT TUB AND ITS COVER. SINCE THIS DAMAGE IS NOT COVERED BY YOUR WARRANTY; IT IS EXTREMELY IMPORTANT TO TAKE PRECAUTIONS WHEN USING THESE PRODUCTS. ONLY USE CHEMICALS AND CLEANING AGENTS DESIGNED FOR SWIM SPAS. DAMAGE RESULTING FROM THE USE OF NON-RECOMMENDED CHEMICALS AND/OR CLEANING AGENTS IS NOT COVERED UNDER THE WARRANTY. FOLLOWING THE PROCEDURES IN THIS GUIDE WILL MAKE THE MAINTENANCE AND CARE OF YOUR SWIM SPA SIMPLE AND ECONOMICAL.

AVOID USING ANY BIGUANIDE OR COPPER-BASED ALGAEICIDE WITH YOUR SWIM SPA. USE OF THESE PRODUCTS IS NOT RECOMMENDED BY PDC SPAS AND MAY VOID YOUR WARRANTY.

PROPER HANDLING OF CHEMICALS

1. KEEP ALL CHEMICALS OUT OF THE REACH OF CHILDREN
2. ALWAYS KEEP LIDS ON CHEMICALS WHEN NOT IN USE AND STORE THEM IN A COOL, DRY LOCATION AWAY FROM DIRECT SUNLIGHT.
3. DO NOT STORE CHEMICALS WITHIN THE INTERIOR OF THE SWIM SPA'S CABINET.
4. DO NOT INTERCHANGE CAPS OR MEASURING SCOOPS FOR DIFFERENT TYPES OF CHEMICALS.
5. DO NOT SMOKE AROUND CHEMICALS. SOME CAN EMIT HIGHLY FLAMMABLE FUMES.
6. IN CASE OF CONTACT OR IF A CHEMICAL IS SWALLOWED, CALL A DOCTOR OR LOCAL POISON CONTROL CENTER. IF A DOCTOR IS REQUIRED, BRING THE CHEMICAL CONTAINER WITH YOU SO THE DOCTOR CAN DETERMINE THE APPROPRIATE TREATMENT.
7. NEVER USE SWIMMING POOL CHEMICALS IN YOUR SWIM SPA. THEY MAY VOID YOUR WARRANTY.
8. NEVER MIX CHEMICALS OR CHEMICAL SOLUTIONS DIRECTLY WITH EACH OTHER.
9. ALWAYS ADD CHEMICALS TO WATER WHEN MIXING THEM. NEVER ADD WATER TO CHEMICALS.

REMEMBER!:

1. BEFORE USING CHEMICALS, READ THE LABELS AND FOLLOW DIRECTIONS CAREFULLY.
2. ALWAYS ADD THE CHEMICALS DIRECTLY TO THE SWIM SPA WATER, EITHER IN A SUITABLE FEEDER, DISTRIBUTED OVER THE SURFACE OF THE WATER, OR Poured INTO THE WATER, PREFERABLY WITH THE PUMP ON.
3. NEVER ADD CHEMICALS TO THE SWIM SPA WHILE PEOPLE ARE USING IT.
4. THE BOTTOM LINE TO PROPER WATER MAINTENANCE IS TO ADHERE TO A REGULAR SCHEDULE OF TESTING CHEMICAL LEVELS AND MAINTAINING THEM.

WATER CHEMISTRY GUIDELINES**WATER CHEMISTRY MAINTENANCE****pH CONTROL:**

CHEMICALLY BALANCED WATER DEPENDS PRIMARILY ON:

1. THE AMOUNT OF ACID OR BASE IN THE WATER (pH),
2. THOSE CHEMICALS THAT HELP MAINTAIN OR STABILIZE pH (TOTAL ALKALINITY) AND,
3. THOSE CHEMICALS THAT CAUSE SCALING (CALCIUM HARDNESS). DESCRIBED AS A MEASURE OF RELATIVE ACIDITY OR ALKALINITY OF WATER, pH IS MEASURED ON A NUMBER SCALE FROM 0 - 14. THE MID-POINT, 7, IS SAID TO BE PRECISELY NEUTRAL, ABOVE WHICH ALKALINITY BECOMES PROGRESSIVELY GREATER AND BELOW WHICH ACIDITY BECOMES PROGRESSIVELY GREATER. PROPERLY BALANCED SPA WATER SHOULD HAVE A pH BETWEEN 7.2-7.8, A TOTAL ALKALINITY OF 75-150 PPM AND AN OPTIMUM RANGE OF 100-400 PPM OF CALCIUM HARDNESS. WITHIN THESE LIMITS, YOUR SANITIZING CHEMICALS AND FILTERING FUNCTIONS WILL BE MOST EFFECTIVE. TEST KITS ARE AVAILABLE TO MEASURE THE pH AND SHOULD BE REPLACED ON AN AT LEAST ANNUAL BASIS TO ASSURE ACCURACY.

DISINFECTION:

THE HIGH TEMPERATURE AND INCREASED VELOCITY OF THE WATER, AS WELL AS THE HEAVY BATHER LOADS, ALL CONTRIBUTE TO THE ORGANIC CONTAMINATION OF SWIM SPA WATER. IT IS VERY IMPORTANT TO MAINTAIN AN EFFECTIVE RESIDUAL OF SANITIZING AGENT, TO SHOCK TREAT AT PERIODIC INTERVALS AND, IF NEEDED, TO CONTROL ALGAE GROWTH.

BROMINE IS THE BEST-SUITED SANITIZER FOR SWIM SPA WATER. ALTHOUGH CHLORINE IS POPULAR AS A SWIMMING POOL SANITIZER, THE HIGH TEMPERATURES AND AERATION OF A SWIM SPA GREATLY ACCELERATE CHLORINE LOSS. FREE CHLORINE REACTS WITH ORGANIC MATERIALS TO FORM COMBINED CHLORINE, WHICH IS A POOR DISINFECTANT THAT CAUSES OFFENSIVE ODORS AND OFTEN CAUSES EYE BURN. BROMINE IS SIMILAR TO CHLORINE, ALTHOUGH IN THE FREE AND COMBINED FORM IT IS AN EFFECTIVE SANITIZING AGENT AND CAUSES NO OFFENSIVE ODOR OR EYE BURN. IT IS EASIER TO MAINTAIN A BROMINE RESIDUAL THAN CHLORINE AND IT IS EFFECTIVE OVER A WIDER pH RANGE THAN CHLORINE.

THE TEST FOR BROMINE SHOULD READ 1 PPM IN A RESIDENTIAL SWIM SPA. DEPENDING UPON BATHER LOAD, AMOUNT OF USAGE, TYPE OF WATER, ULTRAVIOLET EXPOSURE, ETC., THE AMOUNT OF CHEMICALS NEEDED WILL VARY. ON A WEEKLY BASIS, A "SHOCK" TREATMENT SHOULD BE USED TO DESTROY ORGANIC CONTAMINATION NOT READILY DESTROYED BY NORMAL ADDITIONS OF THE SANITIZING AGENT. THIS IS ACCOMPLISHED BY USING A POWERFUL, LONG-LASTING OXIDIZING AGENT CAPABLE OF DESTROYING THE ORGANIC CONTAMINANTS SO THE SANITIZER CAN BE EFFECTIVE IN KILLING BACTERIA.

I

CONTACT YOUR CHEMICAL SUPPLIER FOR THE BEST "SHOCKING" AGENT IN CONJUNCTION WITH THE LINE OF CHEMICALS BEING USED. FOR SWIM SPAS INSTALLED OUTSIDE AND DIRECTLY IN SUN LIGHT, ALGAE GROWTH MAY BE A PROBLEM. IF THIS OCCURS, CONTACT YOUR RETAILER OR CHEMICAL MANUFACTURER FOR ADVICE ON THE BEST AGENT AVAILABLE TO HANDLE THIS PROBLEM.

WATER CHEMISTRY GUIDELINES (CONT'D.)**WATER CHEMISTRY MAINTENANCE (cont'd.)****OZONE:**

YOUR SWIM SPA IS EQUIPPED WITH OZONE AS THE SANITIZING AGENT. THIS UTILIZES ULTRAVIOLET LIGHT AND OFFERS A "HANDS-FREE" ROUTINE TO SPA WATER CARE. THE pH MUST BE MAINTAINED AND SHOCKING MAY BE NEEDED AFTER HEAVY BATHER LOADS. WITH THE USE OF OZONE, THE PERIODIC DRAINING MAY BE NEEDED LESS FREQUENTLY, AND THE BROMINE ODOR NO LONGER AN ISSUE. IT IS SUGGESTED THAT 24-HOUR CIRCULATION IS REQUIRED TO EFFECTIVELY SANITIZE THE WATER, AND A CHLORINE SHOCK USED PERIODICALLY. CONTACT YOUR CHEMICAL SUPPLIER FOR MORE INFORMATION.

1. THERE IS NO TEST KIT AVAILABLE TO TEST OZONE PRESENCE IN SWIM SPA WATER, ALTHOUGH A 24-HOUR CIRCULATION PERIOD IS RECOMMENDED FOR CLEAN, CLEAR WATER. A CLEAN, "AFTER RAIN" SMELL WILL BE PRESENT WHEN YOU OPEN YOUR SWIM SPA COVER AS AN INDICATOR THAT THE OZONE IS DOING IT'S JOB. YOUR UNIT FEATURES A OZONE INDICATOR LIGHT ON THE TOP SIDE OF THE SPA CABINET INDICATING OZONE OPERATION, EVERLITE.
2. A PROPER pH MUST BE MAINTAINED AND A ROUTINE BROMINE OR CHLORINE SHOCK IS SUGGESTED.
3. THE OZONE SYSTEM WITH YOUR SWIM SPA HAS AN EVERLITE INDICATOR MOUNTED ON THE CORNER OF THE SPA CABINET. THIS EMITS A BLUE LIGHT WHEN THE OZONE UNIT IS FUNCTIONING. EVERLITE WILL ONLY BE LIT WHEN UNIT IS IN FILTRATION CYCLE. REFER TO CONTROL INFORMATION AND ICON CHART FOR FURTHER INSTRUCTIONS.

BASIC WATER CHEMISTRY CHART

PROBLEM	DESCRIPTION	CAUSE	REMEDY
Green Algae	Green Water Green spots on surface Slippery surface	Low ozone, bromine, or chlorine levels Low algaecide levels	Superchlorinate Brush spa; removing algae Vacuum swim spa; removing algae Increase oxidizer residual
Black Algae	Black spots on spa surface	Low oxidizer levels Low algaecide levels.	Superchlorinate Brush swim spa; removing algae Vacuum swim spa; removing algae Increase oxidizer residual
Unpleasant Odor, Burning Eyes	Chlorine-like odor. Burning sensation in eyes.	Combined chlorine and/or pH out of balance	Superchlorinate. Balance pH to 7.2-7.6
Colored Water	Water in newly-filled spa turns black, blue, or brown when treated with ozone	Copper, iron, or manganese in water being oxidized by chlorine or ozone	Adjust pH to 7.2-7.6 Run filter continuously Vacuum settled material Use sequestering agent for prevention
Hard Water	Cloudy water Scaling	Excessive hardness of makeup water or building up of dissolved minerals in the water caused by continued use of spa chemicals.	Clean filter Filter continuously Adjust pH to 7.2-7.6 Use scale inhibitor Dilute with makeup water

MAINTENANCE RECOMMENDATIONS



TESTING THE G.F.C.I. (EQUIVALENT RCD FOR EXPORT INSTALLATIONS)

GROUND FAULT CIRCUIT INTERRUPTER (G.F.C.I.) PROTECTION FOR THE SWIM SPA SHOULD BE TESTED PRIOR TO EACH USE BY THE HOMEOWNER. WITH THE SWIM SPA IN OPERATION, PUSH THE "TEST" BUTTON ON THE G.F.C.I. BREAKER AT THE PANEL BOX. THE SPA SHOULD SHUT DOWN IMMEDIATELY. NOW RESET THE G.F.C.I. THE SWIM SPA SHOULD RETURN TO NORMAL OPERATION. IF THE G.F.C.I. FAILS TO OPERATE IN THIS MANNER, THERE EXISTS A POSSIBILITY OF ELECTRICAL SHOCK.

DISCONTINUE SWIM SPA OPERATION BY TURNING OFF POWER AND DISCONNECTING THE POWER SOURCE AND NOTIFY A QUALIFIED ELECTRICIAN FOR IDENTIFICATION AND CORRECTION OF THE PROBLEM.

BASIC SWIM SPA MAINTENANCE

THERE IS SOME BASIC MAINTENANCE THAT WILL NEED TO BE PERFORMED ON YOUR SWIM SPA. BY FOLLOWING THE BASIC MAINTENANCE SUGGESTIONS YOU WILL INSURE THAT YOUR SPA PROVIDES YEARS OF SERVICE. THESE BASIC MAINTENANCE PROCEDURES ARE NOT COVER UNDER WARRANTY.

CLEANING SWIM SPA JETS

MOST OF THE JETS IN YOUR SWIM SPA ARE ABLE TO BE TURNED ON OR OFF. OVER TIME THEY MAY BECOME DIFFICULT TO TURN. WHEN THIS HAPPENS IT WILL BE NECESSARY TO REMOVE THE JET AND CLEAN ANY GRIT OR DEBRIS FROM THE JET BODY. TO REMOVE THE JET YOU WILL NEED TO TURN THE FACE OF IT COUNTER CLOCKWISE UNTIL IT STOPS. NEXT CONTINUE TO TURN THE JET COUNTER CLOCKWISE AS YOU PULL ON THE FACE. THE JET WILL THEN PULL AWAY FROM THE JET BODY. CLEAN JET BODY WITH CLOTH TO REMOVE ALL DEBRIS FROM THE JET BODY.

TO CLEAN THE JET BARRELS YOU CAN SOAK THEM OVERNIGHT IN WHITE VINEGAR. ONCE THE JET HAS SOAKED OVERNIGHT RINSE THOUGHLY WITH WATER.

TO REINSERT THE JET BARREL INTO THE JET BODY SIMPLY PUT THE BARREL BACK INTO THE BODY AND PUSH WHILE TURNING CLOCKWISE.

CLEANING DIVERTER VALVES

DUE TO MINERAL DEPOSITS, GRIT, AND SAND THAT MAY GET INTO THE INTERNAL PARTS OF THE DIVERTER VALVE, IT MAY BECOME HARD TO TURN OR LOCK UP COMPLETELY. IN THE EVENT THIS HAPPENS IT WILL BE NECESSARY TO REMOVE THE HANDLE, CAP, AND PUCK TO CLEAN OUT THE DIVERTER VALVE. FOLLOW THE STEPS BELOW TO CLEAN OUT THE DIVERTER VALVE.

1. TURN OFF POWER TO SWIM SPA.
2. REMOVE HANDLE AND LOOSEN DIVERTER VALVE CAP. IF THAT CAP CAN NOT BE REMOVED BY HAND YOU MAY NEED TO USE A WRENCH. BEFORE YOU PLACE A WRENCH ON THE CAP COVER IT FIRST WITH A CLEAN RAG. 3. PULL THE CAP OFF OF THE DIVERTER VALVE. THE PUCK MAY OR MAY NOT COME OUT WITH THE LID. YOU MAY NEED TO PULL THE PUCK OUT OF THE BODY WITH A PAIR OF PLYERS.
4. WIPE DOWN THE PUCK AS WELL AS THE DIVERTER BODY TO REMOVE ALL GRIT AND DEBRIS.
5. PLACE THE PUCK BACK INTO THE DIVERTER BODY. CHECK THE LARGE ORING TO MAKE SURE IT IS SEATED CORRECTLY ON TOP OF THE DIVERTER HOUSING.
6. CHECK THE TWO STEM ORINGS TO MAKE SURE THEY ARE BOTH IN THE CENTER OF THE LID BEFORE REINSTALLING AND TIGHTENING THE LID.
7. REINSTALL THE HANDLE AND TURN THE POWER BACK ON.

DRAINING YOUR SWIM SPA

THE WATER IN YOUR SWIM SPA SHOULD BE CHANGED EVERY 6 MONTHS.

PERMA-WOOD CABINET:

YOUR SWIM SPA IS CONSTRUCTED FROM A WOOD ALTERNATIVE MATERIAL DESIGNED TO BE DURABLE, TOUGH, AND VIRTUALLY MAINTENANCE-FREE. IT MAY REQUIRE PERIODIC CLEANING WITH A NON-ABRASIVE CLEANER.

MAINTENANCE RECOMMENDATIONS



THE SPA SURFACE

TO PRESERVE THE SHEEN OF YOUR SWIM SPA'S SURFACE, CLEAN AND SANITIZE THE ACRYLIC SURFACE WITH RUBBING ALCOHOL. AVOID USING ABRASIVE CLEANSERS. IF YOU ARE NOT CERTAIN AS TO THE SUITABILITY OF A PARTICULAR CLEANSER, CONSULT YOUR DEALER. DO NOT USE SOAP, AS IT CAN CAUSE SUDSING.

THE COVER

USING THE OPTIONAL INSULATING SWIM SPA COVER ANYTIME THE SWIM SPA IS NOT IN USE WILL SIGNIFICANTLY REDUCE YOUR OPERATING COSTS, HEAT-UP TIME AND MAINTENANCE REQUIREMENTS. TO PROLONG THE LIFE OF THE COVER, HANDLE IT WITH CARE AND CLEAN IT REGULARLY USING MILD SOAP AND WATER. PERIODIC TREATMENTS WITH A VINYL CONDITIONER WILL HELP PROTECT AGAINST DETERIORATION CAUSED BY UV RAYS FROM THE SUN. NEVER ALLOW ANYONE TO STAND OR SIT ON THE COVER, AND AVOID DRAGGING IT ACROSS ROUGH SURFACES. KEEP COVER LOCKED WHEN NOT IN USE.

THE FILTER

SWIM SPA WATER FILTRATION BEGINS AS SOON AS THE FLOW IS STEADY THROUGH THE PUMP. THE TOP LOAD SKIM FILTER ASSURES OPTIMUM CLEANING CAPACITY. AS THE FILTER CARTRIDGE REMOVES DIRT FROM THE WATER, THE ACCUMULATED DEBRIS WILL CAUSE A RESISTANCE TO FLOW. WHEN THIS IS NOTICED, ALONG WITH CLOUDY WATER, CLEAN OR REPLACE THE FILTER ELEMENT AS NOTED BELOW.

1. SHUT OFF POWER AT THE MAIN OR SUB PANEL.
2. REMOVE THE FILTER HOUSING TOP BY PULLING UP THE RAISED PORTIONS OF THE FILTER TOP.
3. LIFT THE SKIMMER BASKET OUT OF THE FILTER CANISTER.
4. REMOVE THE FILTER FROM THE CANISTER.
5. REPLACE WITH CLEAN FILTER (REVIEW ABOVE FOR CLEANING RECOMMENDATIONS.)
6. PLACE SKIMMER BASKET BACK IN FILTER CANISTER.
7. PLACE FILTER TOP ONTO FILTER CANISTER AND TURN CLOCKWISE UNTIL TOP STOPS.

MAINTENANCE RECOMMENDATIONS



PERIODIC SWIM SPA WATER DRAINING

AFTER A CERTAIN TIME, YOU MAY FIND THAT THE ADDITION OF CHEMICALS WILL NOT CLARIFY OR ELIMINATE ODORS IN THE SWIM SPA. THIS IS AN INDICATION THAT THE WATER NEEDS TO BE DRAINED AND REPLACED. GENERALLY, DEPENDING UPON BATHER LOAD AND WATER CHEMISTRY MAINTENANCE, THIS MAY NEED DONE EVERY 3 MONTHS. WITH THE USE OF OZONE, THIS MAY NEED DONE LESS FREQUENTLY.

1. REDUCE SET TEMPERATURE TO 59°F (15°C).
2. TURN OFF ALL POWER.
3. DUE TO THE PHYSICAL SIZE OF THE SWIM SPA, WE RECOMMEND DRAINING YOUR SWIM SPA WITH A SUBMERSIBLE SUMP PUMP. DRAINING YOUR SWIM SPA WITH A CONVENTIONAL SPA DRAIN IS NOT A REASONABLE OPTION.
4. CLEAN CARTRIDGE FILTER AS NOTED PREVIOUSLY IN THIS SECTION REGARDING MAINTENANCE RECOMMENDATIONS.
5. CLEAN SWIM SPA SHELL WITH NON-SUDSING CLEANSER.
6. FOLLOW INSTRUCTION UNDER START-UP.

PLUMBING CARE

ALL SWIM SPAS ARE PLUMBED WITH PLASTIC JETS, PIPES AND FITTINGS WHICH ARE GLUED TOGETHER. THESE PLASTIC PARTS AND THEIR MANY GLUE JOINTS ARE SUBJECTED TO HARSH TREATMENT. EVERY SWIM SPA IS TESTED WITH WATER TO ASSURE THERE ARE NO LEAKS WHEN IT LEAVES THE FACTORY; HOWEVER, SOMETIMES SWIM SPAS DEVELOP A LEAK CAUSED BY SHIPPING VIBRATION. OVER THE YEARS, YOUR SWIM SPA IS SUBJECTED TO MANY HOT-COLD CYCLES AND THE HIGH PRESSURE GENERATED BY THE POWERFUL JET PUMP, WHICH TOGETHER STRESSES THE PIPES AND JOINTS. PDC SWIM SPAS ARE DESIGNED TO BE OWNER SERVICEABLE WITH EASY-ACCESS PANELS ON ALL 4 SIDES OF THE SWIM SPA WHICH ALLOW QUICK AND THOROUGH INSPECTION AND REPAIR OF THE PLUMBING SYSTEM. SHOULD A LEAK OCCUR, FOLLOW THESE INSTRUCTION TO MAKE THE REPAIR.

1. REMOVE SIDE PANEL TO LOCATE LEAK. MARK THE LEAK WITH A MARKING PEN.
2. TURN OFF ALL POWER. DRAIN SWIM SPA BELOW LEAK, ALLOW PLASTIC PARTS TO DRY.
3. CONTACT QUALIFIED SERVICE TECHNICIAN TO REPAIR PLUMBING.

REPLACING THE LIGHT BULB

IF THE UNDERWATER LIGHT BULB SHOULD BURN OUT YOU WILL NEED TO REMOVE THE ACCESS PANEL TO REPLACE IT. BE SURE THE POWER IS "OFF". LOCATE THE LIGHT HOUSING, USING THE FINGER HOLES ON THE REFLECTOR PULL THE REFLECTOR OFF OF THE SPA LIGHT HOUSING. TO REPLACE THE BULB, PULL THE OLD BULB FROM THE REFLECTOR AND INSERT NEW ONE. REPLACE THE REFLECTOR BY LINING UP THE TABS ON THE REFLECTOR WITH THE SLOTS ON THE LIGHT HOUSING AND PRESS IN. REPLACE CABINET PANEL AND TURN SPA BACK ON.



WINTERIZING YOUR SWIM SPA



IF YOUR SWIM SPA IS TO BE USED DURING THE WINTER MONTHS IN COLD CLIMATE WHERE THE DANGER OF FREEZING EXISTS, CERTAIN PRECAUTIONS SHOULD BE TAKEN TO AVOID DAMAGE. AN INCREASED CIRCULATION CYCLE, AND USE OF A RIGID FOAM COVER ARE SUGGESTED. CONTACT YOUR DEALER FOR ADVICE.

MANY SWIM SPA OWNERS FIND THAT OUTDOOR WINTERTIME SOAKING IS QUITE ENJOYABLE, AND PDC CERTAINLY SUGGESTS THE USE OF A SWM SPA YEAR-ROUND, ALTHOUGH CERTAIN SITUATIONS DO REQUIRE CLOSING THE UNIT FOR THE WINTER MONTHS (I.E., VACATION HOMES). IF THE SWIM SPA WILL NOT BE USED FOR A PERIOD OF TIME, PERFORM THE FOLLOWING WINTERIZING PROCEDURES:

1. TURN THE SPA OFF AT THE CIRCUIT BREAKER.
2. OPEN ALL AIR CONTROLS AND JETS.
3. DRAIN THE SWIM SPA.
4. REMOVE FILTERS.
5. REMOVE THE SKIRT PANELS TO GAIN ACCESS TO THE EQUIPMENT.
6. CLEAR WATER FROM THE SUCTION AND RETURN LINES OF EACH PUMP USING A WET/DRY VACUUM. YOU MUST USE A WET/DRY VACUUM IN ORDER TO ENSURE THAT THE LINES ARE CLEARED OF ALL REMAINING WATER.
7. USING THE BLOWER SIDE OF A WET/DRY VACUUM TO BLOW THROUGH ALL SUCTION AND RETURN LINES TO ENSURE ALL WATER IS OUT OF THE LINES.
8. REMOVE DRAIN PLUGS FROM PUMPS, AND REPLACE ONCE ALL WATER HAS DRAINED OUT.
9. LOCATE THE HEATER AND OPEN THE HEATER UNIONS BLOW ALL WATER OUT OF LINES AND REATTACHE THE HEATER UNIONS.
10. REPLACE THE SKIRT PANELS.
11. USE THE WET VACUUM TO VACUUM OUT ALL JETS, SUCTION FITTINGS, AND FILTERS AS WELL AS ALL REMAINING WATER IN SWIM SPA VESSEL.
12. YOU MAY WISH TO USE A NON-TOXIC RV TYPE ANTIFREEZE TO GUARANTEE FREEZE PREVENTION. BE SURE TO READ THE MANUFACTURER'S INSTRUCTIONS AND REMOVE ALL ANTI-FREEZE BEFORE THE NEXT SWIM SPA USE.
13. COVER THE SWIM SPA WITH A WATERPROOF RIGID COVER TO PROTECT IT FROM RAIN, SNOW, ICE, AND WIND.

NOTE: THE SWIM SPA IS SUBJECT TO FREEZING IN COLD WEATHER. YOU MUST FOLLOW THESE PROCEDURES DURING A POWER FAILURE OR IF THE SWIM SPA IS NOT OPERATING PROPERLY IN ORDER TO PREVENT YOU HOT TUB FROM FREEZING.

NOTE: DURING THE COLD WEATHER SEASON, YOU SHOULD INSPECT YOUR OUTDOOR SWIM SPA EVERY DAY TO INSURE IT IS RUNNING PROPERLY. IF YOU DETECT A PROBLEM AND THE TEMPERATURE IS DROPPING, CONTACT YOUR RETAILER FOR IMMEDIATE SERVICE. IT IS THE CUSTOMER'S RESPONSIBILITY TO FOLLOW THE PROCEDURES LISTED ABOVE IN ORDER TO PREVENT A FREEZE UP.

TROUBLESHOOTING

A GOOD GENERAL RULE IS TO VISUALLY INSPECT YOUR SWIM SPA AND EQUIPMENT AREA FREQUENTLY. IF ANYTHING LOOKS BROKEN, WORN, OR INCORRECT, CONTACT YOUR ELECTRICIAN OR SPA RETAILER. A SIMPLE REPAIR MAY PREVENT AN INJURY OR MORE SERIOUS PROBLEMS REQUIRING EXPENSIVE REPAIRS. IF YOUR SWIM SPA IS NOT OPERATING, CHECK THE FOLLOWING:

1. ALL EQUIPMENT IS IN-OPERATIVE

- CHECK POWER SOURCE G.F.C.I. BREAKER. (OR EQUIVALENT)
- CHECK TO ASSURE SPA HAS DEDICATED CIRCUIT.
- CHECK THE “TEST” AND “RESET” BUTTONS ON G.F.C.I. (OR EQUIVALENT)
- CHECK INTERNAL FUSES.

2. PUMP DOES NOT WORK

- CHECK ALL ITEMS ABOVE.
- CHECK FILTER; CLEAN OR REPLACE CARTRIDGE.
- CHECK FOR BLOCKAGES (RESTRICTIONS) AT SUCTIONS, SKIMMER AND PUMP.
- PUSH “PUMP” BUTTON(S) TO CHECK IF HIGH SPEED IS FUNCTIONING, ON A DUAL-SPEED PUMP.

3. INADEQUATE JET ACTION

- MAKE SURE JETS ARE TURNED ON.
- MAKE SURE AIR CONTROLS ARE OPEN.
- CHECK FOR RESTRICTIONS (BLOCKAGES) IN JETS AND/OR MAIN SKIMMER AND PUMP.
- CHECK WATER LEVEL.
- PUSH “PUMP” BUTTON(S) TO CHECK IF HIGH SPEED IS FUNCTIONING ON A DUAL-SPEED PUMP.
- CHECK TO BE SURE THE ULTRA MESSAGE SELECTOR (DIVERTER VALVE) IS IN CENTER

POSITION.

4. NO HEAT

- CHECK ALL STEPS UNDER PART “1”.
- CHECK TEMPERATURE SETTINGS.
- CHECK FOR CLOGGED FILTER ELEMENT AND OTHER RESTRICTIONS.
- CHECK WATER LEVEL.
- CHECK IF PUMP IS RUNNING.

5. NO LIGHT

- CHECK “LIGHT” BUTTON.
- CHECK G.F.C.I. (OR EQUIVALENT) “TEST” AND “RESET” BUTTONS.

6. WATER IS CLOUDY

- INCREASE CIRCULATION CYCLE.
- TEST WATER CHEMISTRY.
- CLEAN/REPLACE FILTER CARTRIDGE.

7. PUMPS HAVE STARTED FOR 1 MINUTE SEVERAL TIMES

- THIS IS A FEATURE OF THE SMART WINTER MODE PROTECTING YOUR SWIM SPA FROM THE COLD BY TURNING PUMPS ON FOR 1 MINUTE SEVERAL TIMES A DAY TO PREVENT FREEZING IN PIPES.

IF ABOVE CHECKS DO NOT SOLVE THE PROBLEM, CONTACT A QUALIFIED SERVICE TECHNICIAN.

RECORDS AND CONTACT INFORMATION



ELECTRICIAN

COMPANY NAME _____
CONTACT NAME _____
ADDRESS _____
PHONE, E-MAIL ADDRESS _____

BUILDER, MASON

COMPANY NAME _____
CONTACT NAME _____
ADDRESS _____
PHONE, E-MAIL ADDRESS _____

SERVICE TECHNICIAN

COMPANY NAME _____
CONTACT NAME _____
ADDRESS _____
PHONE, E-MAIL ADDRESS _____

GENERAL NOTES

! SAVE THIS MANUAL FOR FUTURE REFERENCE !

*PDC Spas
75 Palmer Industrial Road
Williamsport, Pennsylvania 17701
USA*

*1.800.451.1420 tel
1.570.323.8485 fax
www.pdcspas.com
www.pdcspasinternational.com*



*75 Palmer Industrial Road
Williamsport, Pennsylvania 17701
USA*

*1.800.451.1420 tel
1.570.323.8485 fax
www.pdcspas.com www.pdcspasinternational.com*