

MAGNUSON

SUPERCHARGERS

Installation Instructions for:
Intercooled Supercharger System
2015-2017 6.2L Direct Injection
Cadillac Escalade



Step-by-step instructions for installing the best in supercharger systems.

*** PREMIUM GASOLINE FUEL REQUIRED ***



ATTENTION!
Your **MAGNUSON SUPERCHARGER** kit is sensitive to corrosion!
Use only the vehicle manufacturer recommended coolant for your engine in the intercooler system as well.

Magnuson Products LLC
1990 Knoll Drive, Bldg A, Ventura, CA. 93003
(805) 642-8833
magnusonsuperchargers.com

INSTALLATION MANUAL

Magnuson Products
Intercooled Supercharger System
GM 6.2L DI Liter Engines

Please take a few moments to review this manual thoroughly before you begin work: Make a quick parts check to make certain your kit is complete (see shipper parts list in this package). If you discover shipping damage or shortage, please call your dealer immediately. Take a look at exactly what you are going to need in terms of tools, time, and experience. Review our limited warranty with care. When unpacking the supercharger kit DO NOT lift the supercharger assembly by the black plastic bypass actuator. This is pre-set from the factory and can be altered if used as a lifting point!

Caution: Relieve the fuel system pressure before servicing fuel system components in order to reduce the risk of fire and personal injury. After relieving the system pressure, a small amount of fuel may be released when servicing the fuel lines or connections. In order to reduce the risk of personal injury, cover the regulator and fuel line fittings with a shop towel before disconnecting. This will catch any fuel that may leak out. Place the towel in an approved container when the job is complete.

This supercharger system requires the use of only premium gasoline fuel, 91 octane or better. It is NOT compatible with E85, Ethanol, or Flex fuels.

Magnuson Products recommend that you run a minimum of one (1) tank of premium fuel through your vehicle prior to installation of the system to prevent any possible damage that may occur due to running the supercharged engine on lower octane fuel. **DO NOT add octane booster to existing fuel in your vehicle.**

Magnuson Products Supercharger systems are designed for engines and vehicles in “GOOD” mechanical condition. Magnuson Products recommend that a basic engine system “Health Check” be performed prior to the installation of this supercharger system. Be sure to check for any pending or actual OBDII codes and fix/repair any of the stock systems/components causing these codes. If there are codes prior to the installation they will be there after the installation.

Magnuson Products also recommend the following services to be performed on your vehicle before starting and running the vehicle post supercharger system installation:

- Fuel Filter change
 - Engine oil and oil filter change using the vehicle manufacturer’s specified products
- NOTE: It is VERY IMPORTANT to use the factory specified oil viscosity. The original equipment manufacturer has selected this grade of oil to work with your other engine systems such as hydraulic chain tensioners and variable cam controls. Deviation from this specification may cause these systems to fail or not function properly. Please refer to your owner’s manual for the recommended oil viscosity for your engine and application.
- On newer vehicles not requiring new spark plugs it is important to verify the spark plug air gap.

On older vehicles Magnuson Products recommend these additional services to be performed:

- New spark plugs with the air gap set at the factory specifications OR new specifications if required by the installation manual.
- Engine coolant system pressure test and flush and refill.

NOTE: YOU MUST USE THE GM SPECIFIED COOLANT MIXTURE!

Non “Magnuson Approved” calibrations or “tuning” will Void ALL warranties and CARB certification.

Tools Required

- Safety glasses
- Metric wrench set
- 1/4", 3/8", and 1/2" drive metric socket set (standard and deep)
- 3/8" and 1/2" drive foot pound and inch pound torque wrenches
- 1/2" breaker bar (for tensioner)
- Phillips, flat and Torx head screwdrivers
- Plastic and steel pry bar
- Pliers, cutters, metal pick, and funnel

IMPORTANT

NOTES:

1. For the purpose of these instructions, all references to left hand side or right hand side shall be interpreted as if being seated in the driver seat of the vehicle.
2. It is **IMPORTANT** to utilize 91 Octane gasoline or better with your supercharger system. Before starting this installation, on an empty tank, fill your tank to full with 91 Octane gasoline or better.
3. Never add Octane booster to your fuel. If you have used Octane Booster in the past, replace your spark plugs and check your O2 sensor before completing your supercharger install.
4. Your supercharger system is sensitive to corrosion. Use only the OEM recommended coolant mixture for your supercharger system as well as your engine.
5. Please remember to follow all safety rules that apply when working, including:
 - Wear eye protection at all times
 - Do not work on a hot engine
 - Be careful around fuel – use shop towels to catch any spills and dispose of towels properly

Contact Information:

Magnuson Products LLC
1990 Knoll Drive, Bldg A
Ventura, CA 93003

Sales/Technical Support Line: (805) 642-8833
Website: www.magnusonsuperchargers.com
Email: sales@magnusonproducts.com

Table of Contents

Section 1: Tuning Vehicle Computer and Initial Steps	5
Section 2: Remove Factory Intake Manifold and Accessories	6
Section 3: Remove Fascia/Grille and Install Low Temperature Radiator	12
Section 4: Initial Plumbing and Pump Install for Charge Air Cooler	28
Section 5: Remove Drive Belt and Prepare Supercharger	33
Section 6: Install Supercharger	38
Section 7: Install Drive Belt, Finish Plumbing and Wiring of Intercooler System	40
Section 8: Install Air Quality Control and System Monitoring Devices	44
Section 9: Coolant Fill, Replacing Fascia/Grille and Testing	50

Section 1: Tuning Vehicle Computer and Initial Steps

1. If your kit came with the SCT tuner follow the provided SCT instructions for uploading the new tune to your vehicle. If your kit did not come with an SCT tuner you will have to use HP Tuners or equivalent to load your calibration.

2. Your Intercooler system is sensitive to corrosion. It's very important to use the OEM recommended coolant mixture in your supercharger system as well.

3. Your system requires the use of minimum 91 Octane gasoline fuel. This system is not compatible with E85 fuel.

4. Loosen the nut shown with an arrow to disconnect the negative battery terminal. Cap or cover the terminal to protect against accidental contact with the battery post.

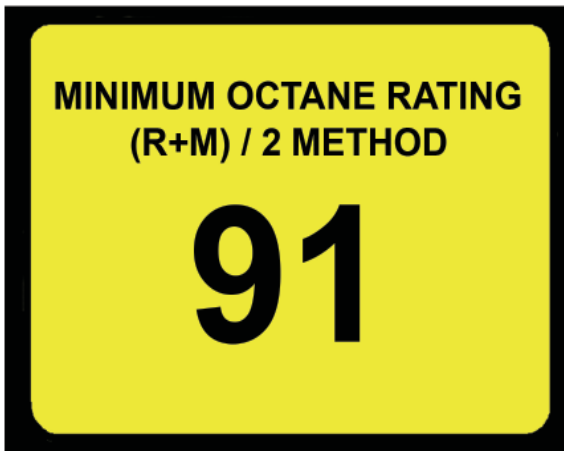

Section 2: Remove Factory Intake Manifold and Accessories

5. Pull up at front of beauty cover shown and then towards front of vehicle to remove.



6. Depress the gray locking tab to release the PCV vent hose coming from the valve cover at the air plenum on both sides of the engine. Remove these two hoses for later reinstallation.



7. Loosen the clamp at the air box securing the air plenum in position.



8. Using an 8mm nut driver or a flat blade screwdriver, loosen the clamp at the throttle body.





9. Remove the air intake plenum from the vehicle. This will not be reused.



10. Remove bolt securing bracket in location shown.



11. Remove bracket shown. This will not get reused.



12. Disconnect the ETC connector from the throttle body. Depress the locking tab and pull the connector free.



13. Disconnect the alternator control sensor plug from the alternator.



14. Pull the four “tree” tab wire loom mounting anchors from the holes in the right, and left side of the intake manifold.



15. Unplug the electrical connector from the MAP sensor. Release blue locking tab first.



16. Use a pick tool to move the blue lock tab over from the inside if you can't get it to disengage with your finger from the outside.

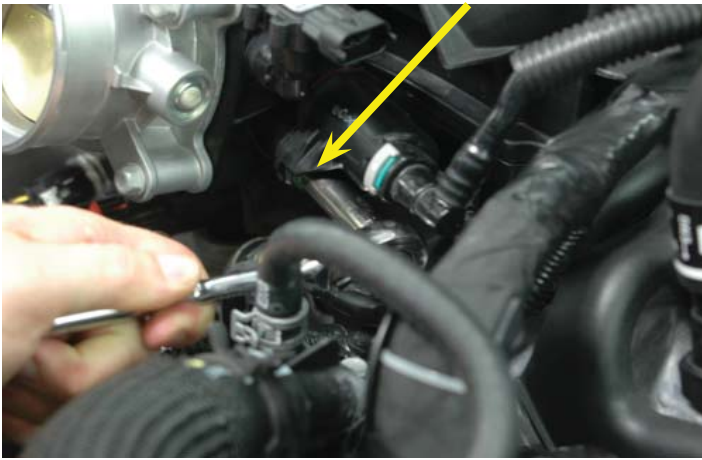

17. Use a 10mm socket wrench to remove the EVAP Solenoid from the intake manifold. This is located just behind the throttle body on the left side, below the MAP Sensor.



18. With the EVAP Solenoid free you can now remove the electrical connection by pressing the release tab and unplugging.



19. With the EVAP Solenoid free, you can now easily disconnect the EVAP tube from the Solenoid by pressing the gray release tab and pulling free. Save the EVAP Solenoid, and its fastener, for a later step.



20. Remove the PCV hose from the valley cover on the left side below the throttle body. Disconnect it at the locations shown.



21. Use a 10mm socket wrench to remove the ten bolts securing the OEM intake manifold to the heads. The intake manifold is now ready for final removal from the vehicle.



22. Pull the intake manifold forward a bit to gain access to the wiring harness "tree" anchors that hold the harness to the back of the intake manifold. Use a screwdriver or tree clamp remover to unplug these trees from the OEM intake manifold.



23. This image shows the location of the four tree connectors on the back of the intake manifold.

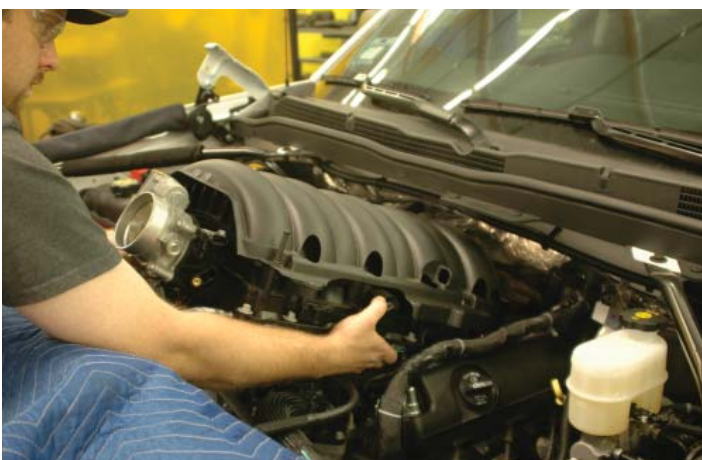

24. Pull the OEM intake manifold out of the vehicle and set aside. Parts will be used from this assembly. Gaskets, and throttle body will be reused.



25. Remove the valley cover foam insulating blanket from the vehicle. This cover will be re-used.



26. Use a shop vacuum to clean off the heads being careful not to allow any debris to fall into the exposed intake ports.



27. Use Simple Green or equivalent cleaner to wipe the surfaces of the head intake ports.



28. Use tape or clean shop towels to cover over your intake ports. It's important to keep these ports clean and avoid any debris falling into the exposed openings.

Section 3: Remove Fascia/Grille and Install Low Temperature Radiator

29. Remove 14 push pin rivets from the top of the radiator cover by prying up on the center pin to release the spreaders, then pry up on the outer ring and pull the push pins free. Remove the cover and set aside for later reinstall.



30. Remove 8 bolts holding the top of the fascia/grille to the sub frame using a 10mm wrench.



31. Apply strips of painters tape along both sides of the seam at the forward, lower fascia connection to the upper fender to protect the paint from scratching.



32. Follow owner's manual directions to raise vehicle, and remove front wheels.





33. Use a 7mm wrench to remove the four bolts (there may only be two bolts for the 2016-17 model) at the front of the inside plastic wheel well to fascia connection on each side of the vehicle.



34. In the fender well (on each side of the vehicle facing up), use a 7mm socket wrench to remove the bolt from the fascia to fender.

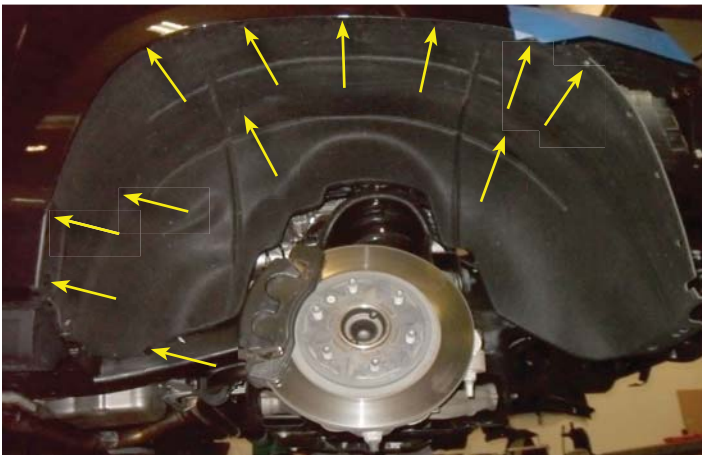

35. Remove 12 fasteners in wheel well with a T15 driver.

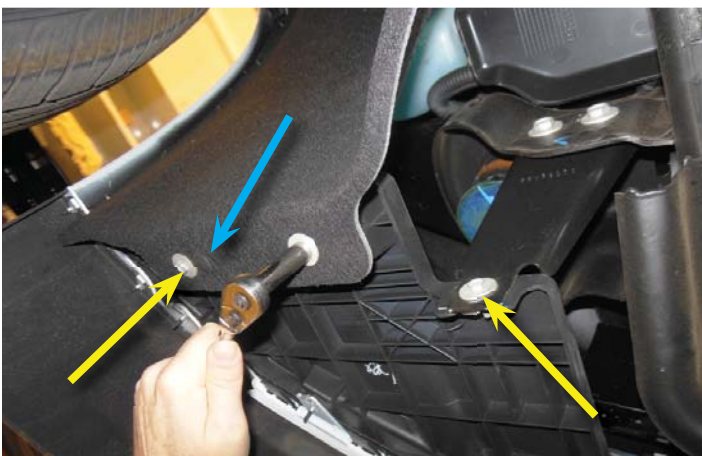

36. From below the vehicle, there are eight 10 mm bolts (four on each side) holding the bottom of the fascia/grille to the stand-off sub frame and wheel well. Three from one side are shown in this picture. Remove these eight bolts. Also remove the plastic button fasteners on both sides indicated with a blue arrow here.



37. These are the other two bolts that need to be removed. Now remove the wheel well covers on both sides.



38. This picture shows the interior wheel well removed completely. There are three bolts holding the plastic retaining clip to the upper fender well mounting bracket. This clip locks the lower fascia connection in position. Remove these three bolts using a 7mm wrench to allow the lower section to be pulled free.



39. Carefully pull out on the side lower fender connection to ensure it is free.



40. Lever up on the top of the fascia to release the two clips on either side of the hood release to allow the front top section to be pulled out just a bit.

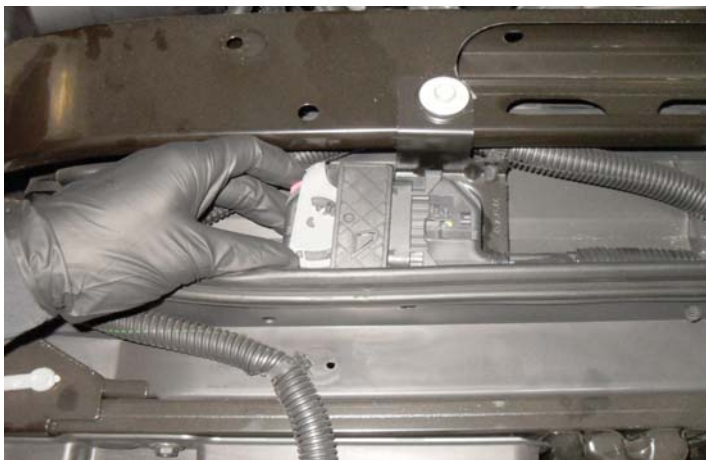

41. Remove the electrical connection for the front wiring harness.



42. Use a plastic pry bar to remove cable tie shown.



43. From the underside of the vehicle you will find two release tabs that will be pressed with a screwdriver while the bumper fascia is pulled away. Remove the front fascia by pulling towards the front of the vehicle.



44. It will require two people to safely remove the fascia, and store it in a safe place.

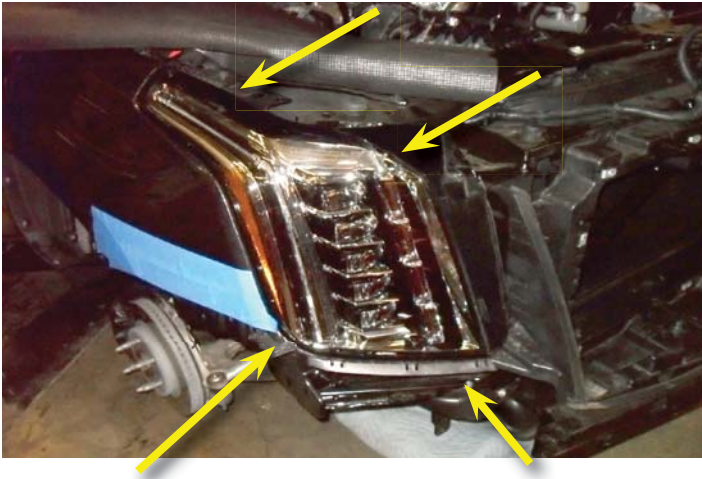

45. Use a 10mm wrench to remove the four bolts mounting the headlight to the framework on the right hand side of the vehicle.



46. Pull out slightly on the metal body panel to release the headlight.



47. Slide the headlight forward to remove from the vehicle.



48. Disconnect the headlight connector and set the headlight aside for re-installation later.

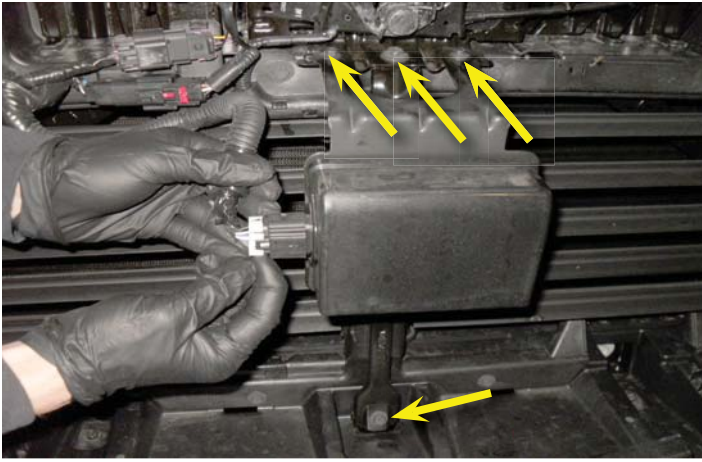

49. Disconnect the wiring from the sonar unit. Use a 7mm and 10mm wrench to remove the four bracket fasteners holding the sonar in place. **If you have a 2016-17 model refer to the next step.**



50. On a 2016-17 model the sonar unit is located under the crash bar (shown with a red arrow) and therefore does not need to be removed. Therefore you only need to remove two bolts (shown with yellow arrows) to remove the center brace.



51. Unplug the two wiring harnesses shown.



52. Pry away the connection for the two harnesses from the last step.

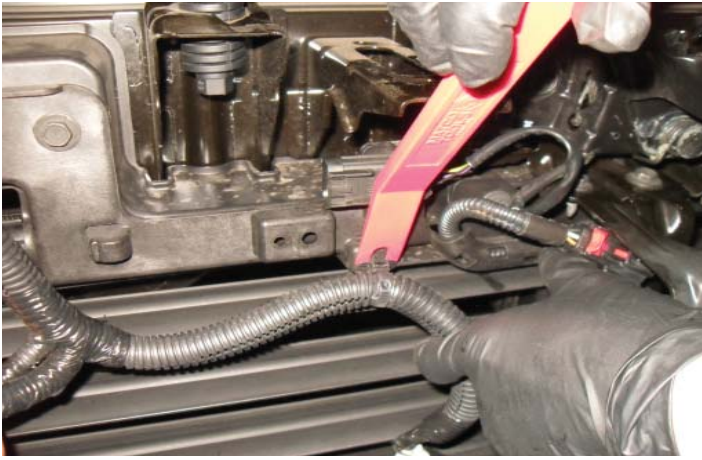

53. Pry away the wiring harness at location shown.



54. Mark the location of two hood latch fasteners to allow proper alignment during reinstall.



55. Use a 13mm wrench to remove the two hood latch fasteners marked in last step.



56. Pry harness assembly from location shown.



57. Squeeze tabs to remove cable housing from hood latch.

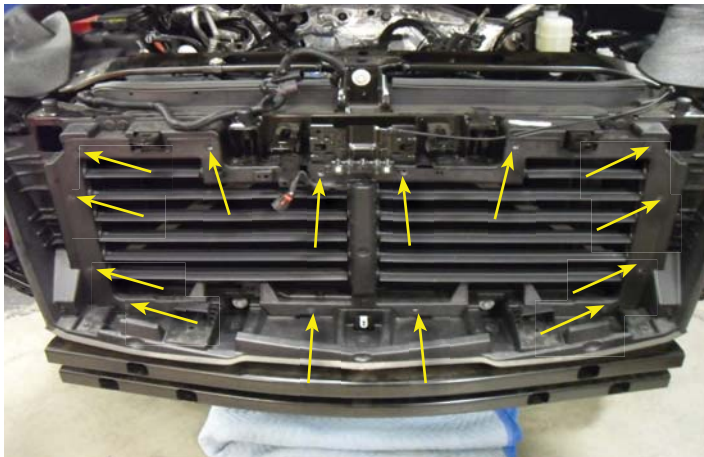

58. Use 10mm wrench to remove 14 fasteners from perimeter of louver assembly.



59. Pull out on louver assembly to release tab shown.



60. Remove louver assembly from vehicle.



61. Front radiator area shown after louver removal.



62. Remove the two upper radiator mounting bolts using a 13mm socket.



63. Remove the two upper-forward, diagonal fender-brace bars using a 10mm wrench.



64. Disconnect the airbox MAF plug from the airbox on the right side of the vehicle. Pull the "tree" clip from the mounting hole in the airbox disconnecting the harness to the airbox.



65. The hoses going to the radiator overflow tank can be disconnected. This is not absolutely necessary but does make the job a bit easier. Connect the two hoses together using a coupling (hose mender), or plug them with a plug or dowel and tuck out of the way. Again, this is not absolutely necessary.



66. Pull the factory airbox from the vehicle, there are no screws anchoring the airbox in place, locating pins push through grommets, a firm pull will disconnect. Set the airbox aside for installation in a later step.



67. Remove the three (each side) upper radiator cross-frame support brace bolts using a 10mm wrench. These are all accessible only from below the support brace. Use a flathead screwdriver or a push rivet removal tool to un-snap the top rivets of the rubber air deflector on the right side to ease access.



68. Remove the cross-frame support brace center bolt using a 13mm wrench.

69. Remove bracket at harness location shown.



70. Pull the cross-frame support brace from the vehicle and set aside for re-install in a later step.



71. Use a pick tool to help release connections at upper radiator shroud.



72. Pull up on the upper radiator shroud to unsnap it from the retaining slots. There may be a clip on either side a few inches below the top. Disengage while pulling up from the top. Set aside for re-install later.

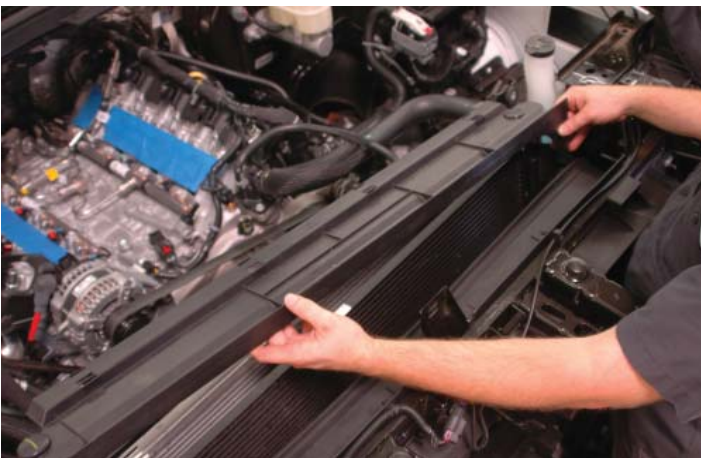



73. Unclip harness anchor from shroud.



74. Slide the provided low temperature radiator (LTR) assembly into the space created by pushing the radiator assembly top section toward the rear of the vehicle. The mounting brackets should be pointing forward, and the hose barbs on the right side of the vehicle. Be careful to not damage the existing radiator or the LTR.

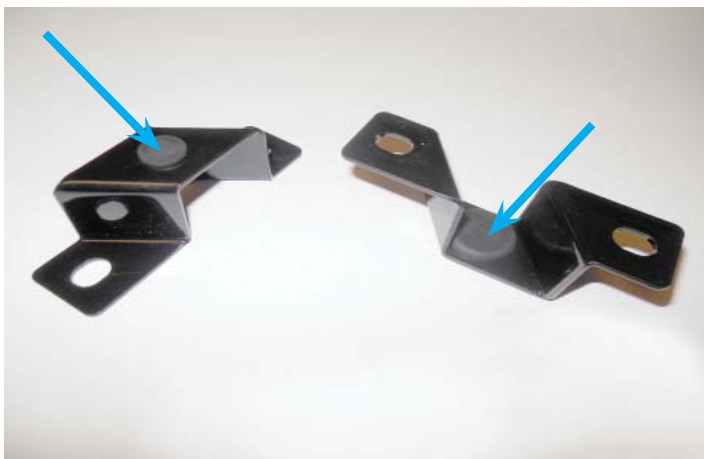

75. Install the provided grommets in the channel holes on the provided LTR mounting bracket.

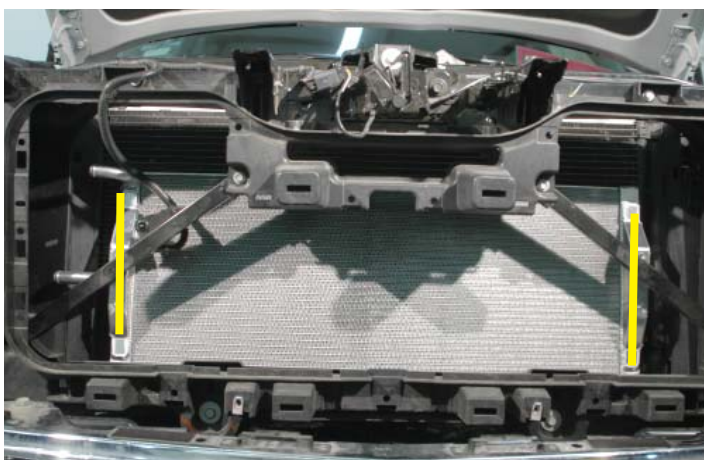

76. The LTR should now be resting on the bottom tray forward of the radiator. Center the unit and use the mounting bracket holes to align and place the mounting brackets on the "A-Frame" in front of the radiator.

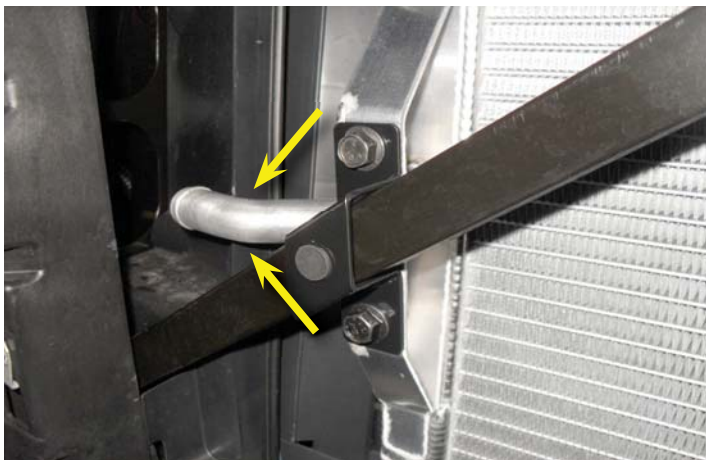

77. Here is a close-up of the LTR mounting brackets temporarily mounted in place. Mark the areas where the upper and lower hose spigots interfere with plastic shield. Then remove the brackets to free the LTR.



78. Cut areas marked in previous step (highlighted in yellow). Make the horizontal slot cuts first. Cut roughly half the distance to the edge.



79. Now use a utility knife to score the plastic for the vertical cuts. Score the vertical mark (shown in yellow) two times. Then bend the piece back and forth. It should cleanly snap off.

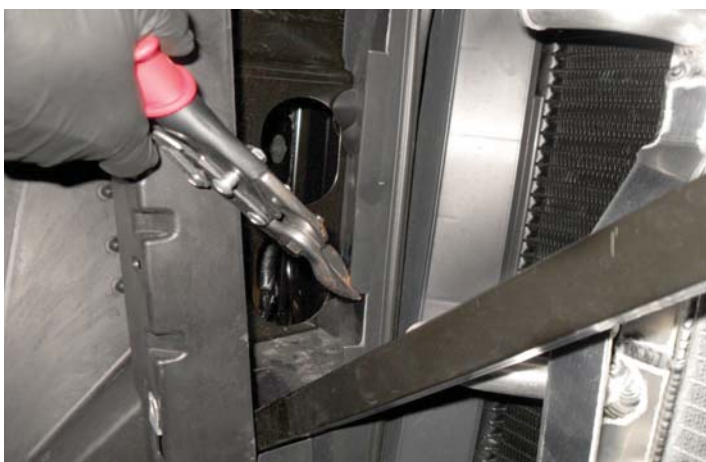

80. Trim sharp corners away.

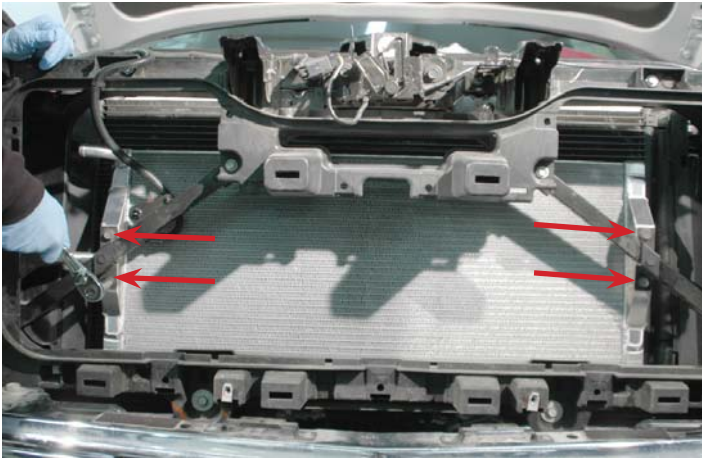

81. Attach the mounting brackets to the LTR mounting flange using the supplied bolts and a 12mm wrench. **Do not tighten until you have aligned the LTR to be level, cross checking against the existing horizontal lines of the A/C condenser.** Secure in place when you've got proper alignment.

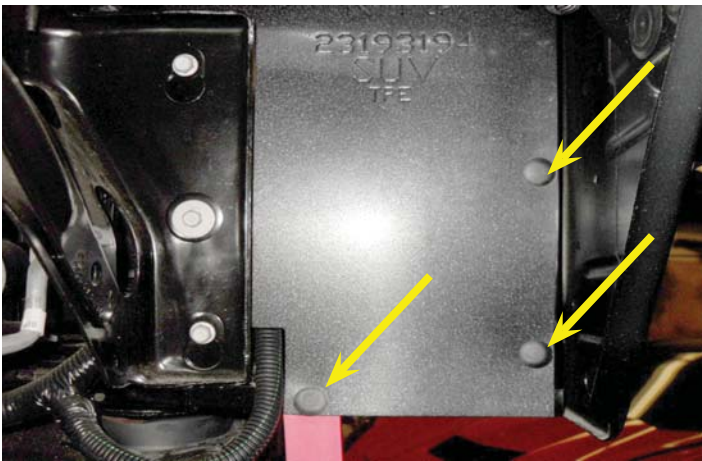

82. At the bottom behind the right headlight shield there are three push pins holding the fiber shield to the bottom of the framework. Pry these three pins out of the holes for modification of the fiber shield.

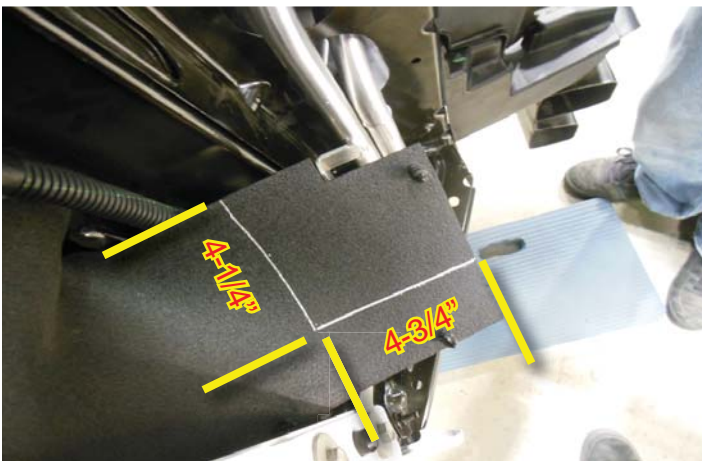

83. Pull the shield up and mark as shown in this picture. Cut this section of the headlight shield off for intercooler plumbing access.



84. Tuck the headlight shield back in place, and press the supplied edge grip seal over the bottom of the headlight opening as shown in this picture.

85. Remove the one 10mm nut and two 13mm bolts indicated, set aside for later re-installation.

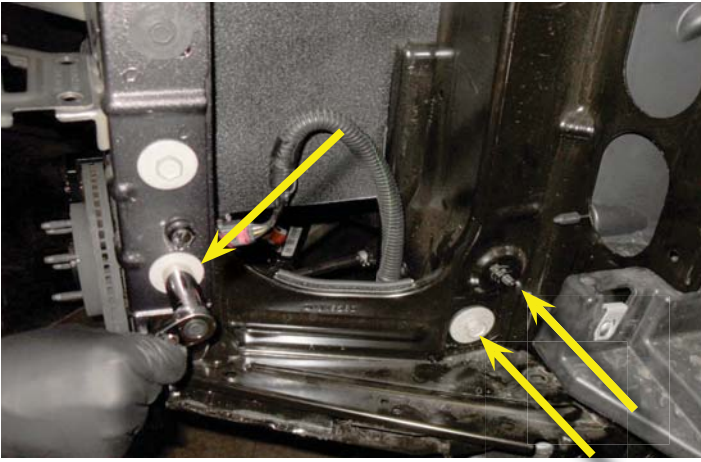

86. Here are the coolant hard lines showing their relative location and orientation.

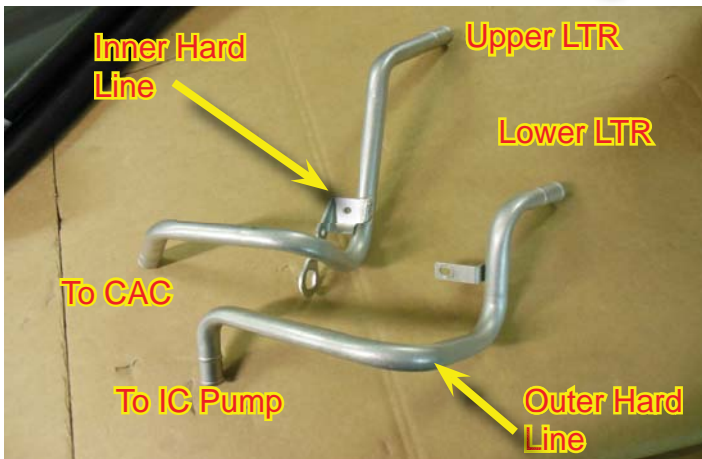

87. Place the upper end of the inner hard line through the top hole on the side of the radiator mounting frame as shown.



88. Rotate the bottom end through the opening behind the headlight, and loosely fasten using the OEM bolt and nut removed earlier.





89. Orient the hard line so that it is parallel with the side of the radiator mounting flange and secure in position.



90. Slide the lower end of the outer hard line through the headlight opening and rotate the upper section into the lower hole of the radiator mounting frame as shown.

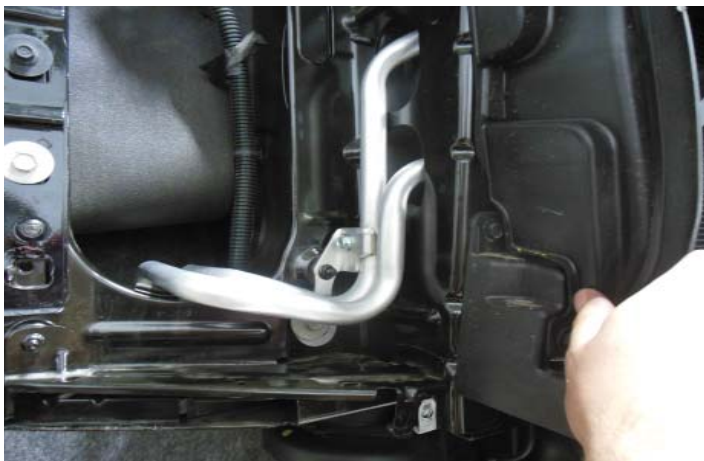

91. Secure the second hard line to the first hard line bracket using the provided M6 x 12mm long bolt.



92. Loosely install the supplied hardline support bracket using the OEM bolt with the 13mm head. Make sure the bracket cradles the hardline, then install the hardline cap with cap head screw, and spacer. Install the washer, then the nylock nut, to the underside of the cap screw finger tight. When everything is aligned, secure in place.



93. Replace the upper radiator shroud by snapping into place.



94. Replace the upper radiator cross-frame brace and secure with the OEM mounting bolts.



95. Replace the upper radiator mounting bolts. Secure in place through vibration dampers.



Section 4: Initial Plumbing and Pump Install for Charge Air Cooler

96. Attach the supplied reservoir mounting bracket to the reservoir with the provided bolts and secure using a 10mm wrench.

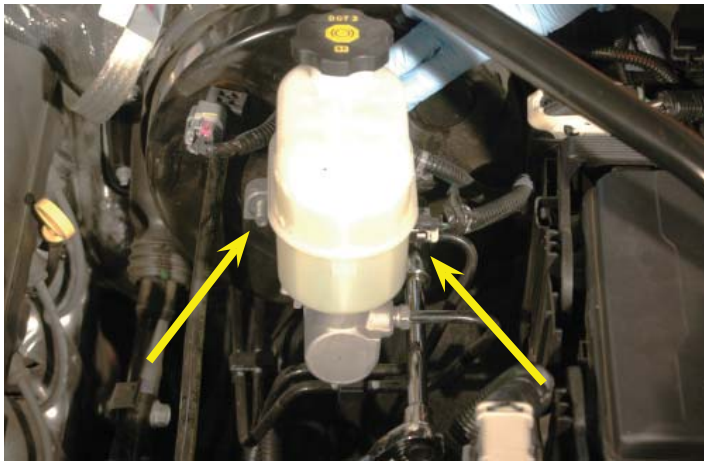

97. Remove the two nuts holding the master cylinder to the brake booster canister using a 15mm socket.



98. Replace the nuts incorporating the reservoir assembly. Torque to 25 ft-lbs. Verify your torque wrench settings.

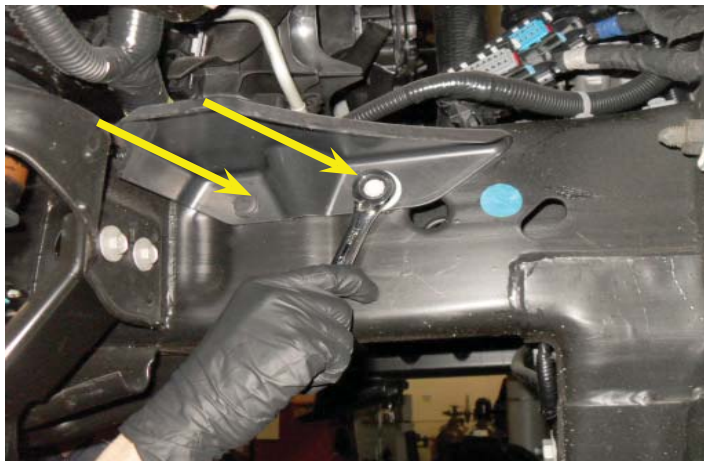

99. Use a 13mm wrench to remove the bolt, and pry out the push pin rivet to remove the plastic splash shield on the left hand side frame rail by the bumper support bracket, directly below the ECM which was removed earlier. This shield and hardware will not be reused.

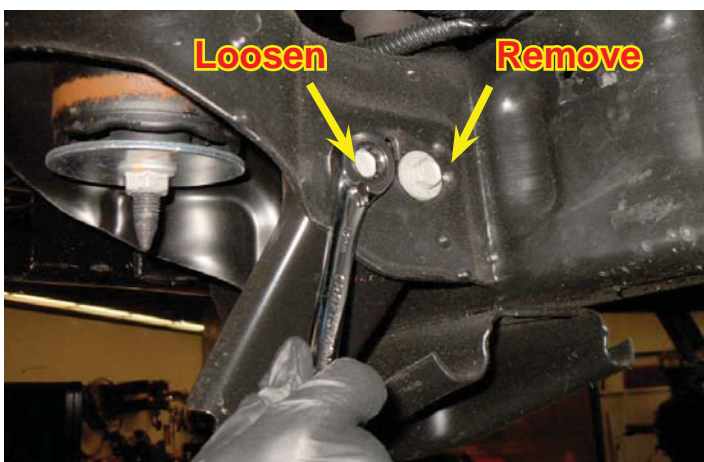

100. Use a 13 mm socket, or wrench to remove the right hand side mounting bolt on the left hand side bumper support bracket at the frame, adjacent to the plastic guard just removed. Loosen the left hand side bolt on the same bumper support bracket.



101. Disconnect the wiring harness mounting clip from the hole on the top of the frame rail above the bumper mounting bracket, and below the ECM.



102. Use a provided zip tie to anchor the harness to the existing black brake hard line, which runs parallel to the frame rail.



103. Use a 12mm socket to mount the intercooler pump to the supplied bracket as shown. The discharge barb of the pump should be perpendicular to the bracket mount. The base of the pump should be flush with the rear Adel clamp.



104. Engage the slot of the pump bracket on the loosened bolt of the bumper support bracket on the frame rail. Replace the removed bolt incorporating the remaining hole of the intercooler pump mounting bracket. The pump discharge barb should be above the frame rail pointing to the right hand side of the vehicle. Secure the bolts using a 15mm wrench.

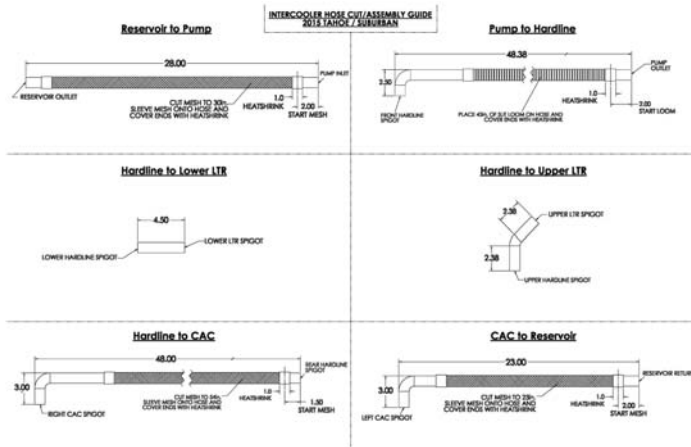

105. Refer to the expanded diagram at the end of the instruction manual to prepare your inter-cooler system plumbing hoses for install. When measuring the mesh sleeve make sure it is in a relaxed state.

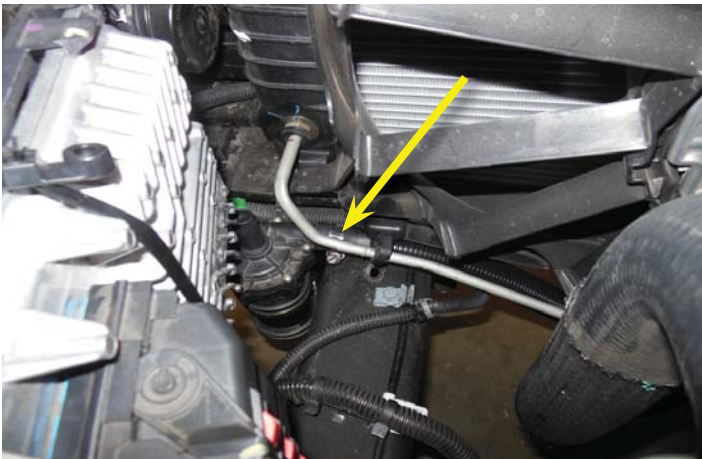

106. Install the “pump to hardline” hose using a provided worm gear clamp on the pump discharge hose barb. Place the clamp as shown with the screw pointing upwards, and just below the trans cooler hardline.



107. Route the hose over to the right hand side of the vehicle, anchor to the existing wiring harness using provided zip-ties.



108. Connect the free end of the hose to the outer hard line hose barb below the tray of the air-box using a provided spring clamp. Ensure the hose clamp sits past the lower barb on the hardline. This holds true for all hose to barb connections. Aim the clamp “fingers” toward the front of the vehicle.

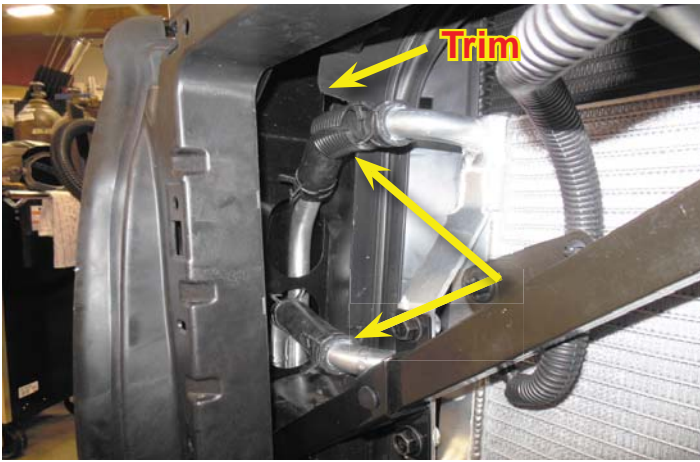

109. Connect the two “hard line to Low Temperature Radiator (LTR) hose sections” between the LTR and the two hard lines installed earlier using the provided spring clamps. Lightly apply Lubri-plate grease to inside of hose to ease installation. Install a section of the provided split loom over the upper hose to protect from chaffing. **NOTE: Check trimmed plastic in areas indicated to ensure they do not contact the hoses.**



110. Connect long end of the 90 degree “reservoir to pump inlet hose” to the reservoir using a provided worm gear clamp. It’s important to utilize only worm gear clamps on both reservoir spigots.



111. Route the short end of the 90 degree “reservoir to pump inlet hose” forward and down to connect to the intercooler pump inlet hose barb using a provided spring clamp.

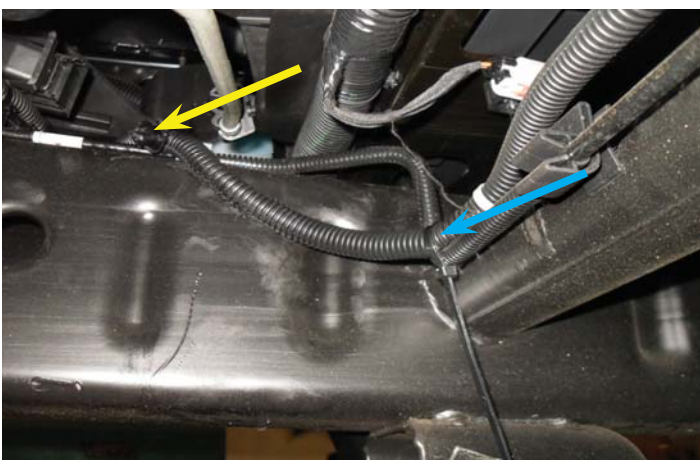

112. Install the new wire tie at location shown with blue arrow. The yellow arrow indicates the location of the wire tie installed in step #102.

Section 5: Remove Drive Belt and Prepare Supercharger

113. Take the OEM insulator removed earlier, and cut away sections highlighted in yellow.



114. Cut away the entire portion of the corner shown with cross-hashed lines in left hand.



115. Undercut the portion to the right before cutting out.



116. Trimmed insulator shown.





117. Install trimmed insulator from last step into manifold valley.



118. Remove the OEM drive belt by springing the tensioner using a ½" breaker bar or socket wrench, if necessary utilize a piece of pipe to extend the lever length. This belt will NOT be reused.



119. Remove the left alternator mounting bolt shown using a 15mm wrench.



120. Loosen the other alternator support bolt shown.

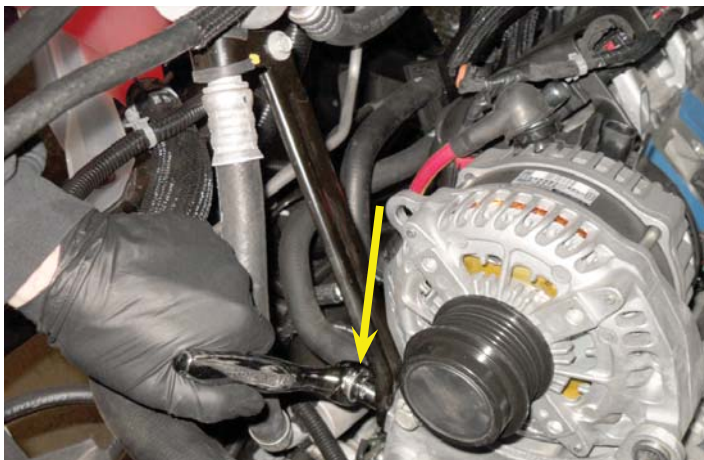

121. Remove the bracket located next to the alternator it will be re-attached later.



122. Pry alternator up to rotate it out of the way.



123. Alternator shown rotated out of the way.

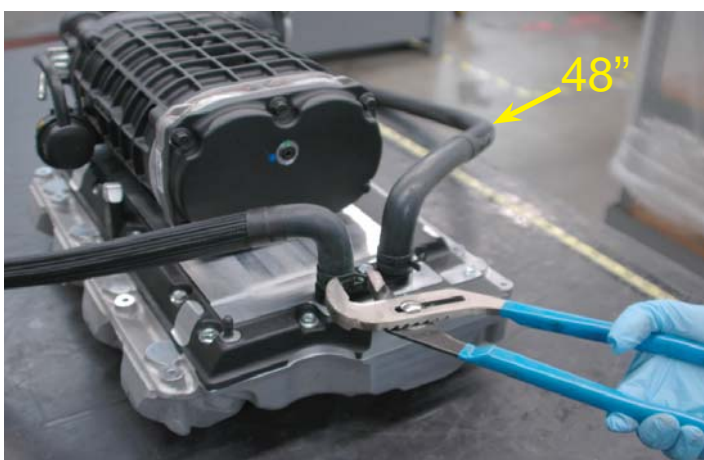

124. Connect the short leg of the cut/assembled 23" x 3" x 3/4" 90° elbow hose to the left hand side charge air cooler hose barb at the back of the supercharger assembly. Secure in place with a provided spring clamp. Connect the cut/assembled 48" x 3" x 3/4" 90° elbow hose to the right hand side charge air cooler hose barb at the back of the supercharger assembly. Secure in place with a provided clamp. The hoses route toward their respective sides as shown.



125. Remove intake gaskets from the OEM intake manifold. Inspect for damage, and replace as necessary. These will be reused.



126. Remove the throttle body from the OEM intake manifold using a 10mm wrench. These four fasteners will not be reused.



127. Install the throttle body adaptor plate with the four 16mm long socket cap screws, and torque to 106 in-lbs. Install the throttle body gasket removed earlier in the groove of the supercharger inlet. If the throttle body adaptor provided has a gasket you will not need to use the old one.



128. Install the OEM throttle body on the supercharger inlet using a 10mm wrench and torque to 106 in-lbs using the supplied 40mm long M6 fasteners.

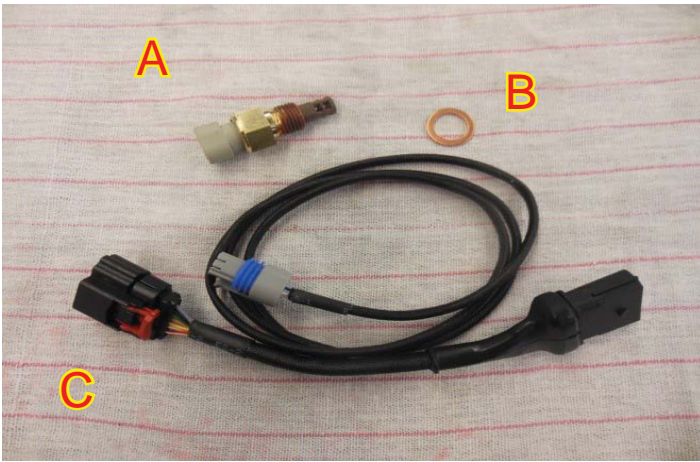

129. You should have the 3 parts shown to the left. (A) IAT sensor, (B) crush washer and (C) MAF/IAT breakout. To complete the installation of the sensor you will need a 19mm (or $\frac{3}{4}$ ") deep socket and a torque wrench capable of 175in-lbs (~15ft-lbs).

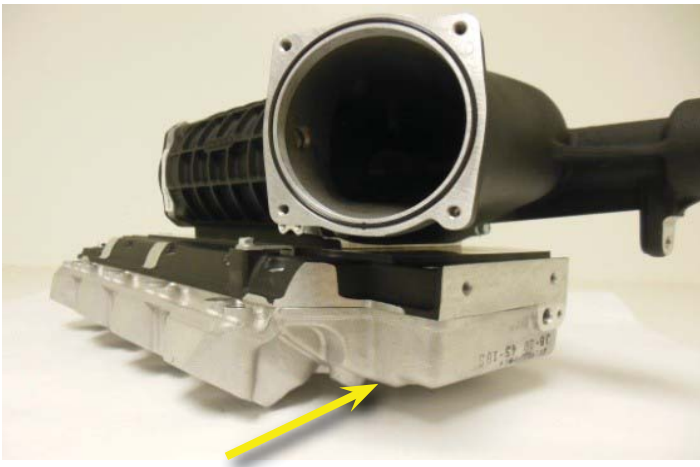

130. Prior to installing the supercharger, you will need to install the IAT sensor. Once the sensor is installed, be careful not to set the supercharger on a flat surface directly over the IAT sensor. **The plastic connector sits below the surface of the runners and can be damaged if subjected to the weight of the supercharger.** It is best to perform this installation on a bench and let the front of the supercharger hang over the edge slightly so the sensor will not get crushed.



131. It is very critical that the crush washer sits between the brass sensor housing and the aluminum manifold. This will ensure there is an air tight seal between the sensor and manifold. Begin by placing the crush washer over the brass threads the IAT sensor; then thread the sensor into the manifold by hand until snug.



132. Once the sensor is snug to the crush washer, set your torque wrench to 175in-lbs (~15ft-lbs). With a 19mm (or $\frac{3}{4}$ ") deep socket attached to your torque wrench, torque the sensor down. ***Note: Take care when installing the sensor into your socket so it does not get damaged. When flipping the supercharger right side up be careful not to crush the sensor.**

Section 6: Install Supercharger

133. Remove the factory EVAP hose from behind the left side cylinder. Squeeze the connector clip to release the clip and pull free.

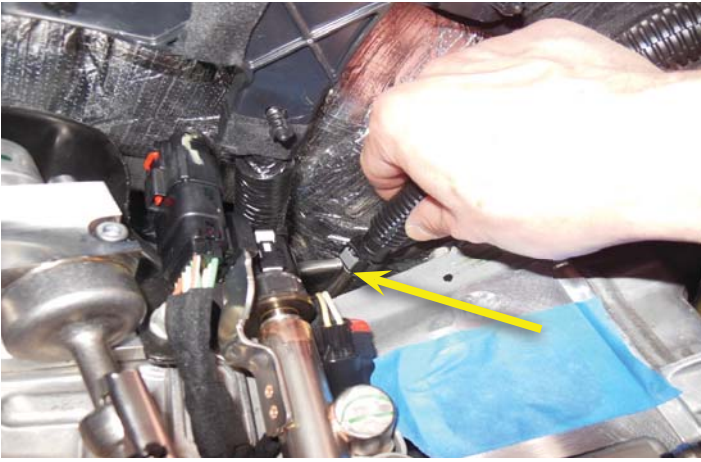

134. Connect the gray end of the new provided EVAP hose shown to the location where the factory EVAP hose was just removed (shown with a yellow arrow). Remove the bolt holding the fuel injection line in place (shown with a green arrow) to allow clearance while the supercharger is being installed. This bolt will be reinstalled after the supercharger is mounted.



135. Remove the tape or rags covering the intake ports on the heads. Be careful to not allow any debris to fall into the exposed ports.



136. Wipe clean with lacquer thinner, alcohol, or some other non-petroleum based solvent.

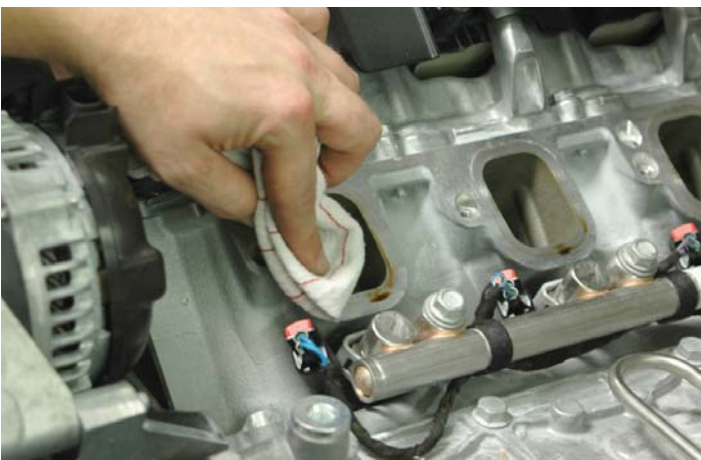



137. Clean the OEM gaskets removed from the intake manifold earlier, and install them in the grooves on the bottom of the supercharger intake manifold. If you find any damaged gaskets you will need to replace them with GM replacement parts. The tab will line up with the slot on the outside edge.



138. Spray a thin film of non-petroleum based lubricant, such as silicone spray or mild dish-washing detergent, on the port mounting surfaces to facilitate aligning. With the help of an assistant, carefully place the supercharger assembly into position.



139. Apply blue Loctite 242 to the ten provided 75mm long supercharger mounting bolts. Install supercharger mounting bolts and torque in position to 106 in-lbs using a 10mm wrench. Follow the torque order given at the back of the book. At this point also reinstall the bolt holding the fuel injection line to the left side of the engine that was removed earlier.



140. Plug the IAT end of the MAF/IAT breakout harness (Shown in step #129) into the sensor. This can be done after the installation of the supercharger (as shown), or you can pre-install the harness and take extra precaution to not damage the connector during supercharger installation. For now run the harness behind the alternator. The routing will be finished at a later step.

Section 7: Install Drive Belt, Finish Plumbing and Wiring of Intercooler System

141. Rotate the alternator back to its original position. Place the supplied idler pulley on the idler standoff. Install the supplied idler standoff assembly with the supplied new bolt into the left alternator mount. Torque the bolt to 25 ft.-lbs.

NOTE: Due to casting variances, there are shims supplied. Once the vehicle is running it may be necessary to shim the idler pulley so it is centered on the belt.

142. Torque the other alternator bolt to 25 ft.-lbs. Re-attach the bracket adjacent to the bolt just torqued.

143. Install the provided accessory drive belt using the belt routing diagram at the back of this installation manual.

144. Route the hose from the right hand side of the charge air cooler forward, down, and connect to the remaining hardline hose barb below the airbox using a provided spring clamp. Make sure it routes behind the heater hoses attached to the firewall.





145. Secure the hose along its path with a few provided zip-ties. Keep it away from the exhaust manifold.



146. Connect the right hand side of the charge air cooler at the location indicated with an arrow.



147. Connect the left side hose coming from the supercharger charge air cooler to the upper-rear hose barb on the intercooler reservoir using a provided worm gear clamp.



148. Install the provided fuse in the charge air cooler pump wiring harness fuse holder, replace the cap.



149. To install your intercooler pump harness bracket, begin by removing the two nuts with a 13mm socket where the left hand (driver side) inner fender meets the firewall. This will be behind the fuse center, below the hood hinge. Place the supplied pump harness bracket onto the studs and use the factory nuts to secure in place.

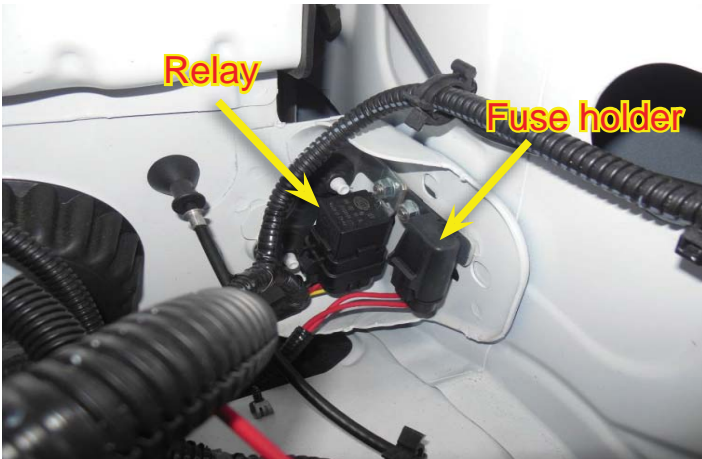

150. Place the relay on the stud closest to the firewall and secure with a supplied M6 nut, using a 10mm socket. Use the remaining supplied M6 nut to secure the fuse holder to the bracket. Make sure to route the wires to the fuse holder as shown, so that they do not rub on the sheet metal below.



151. Route the plug from the wiring harness down to the inside of the fuse center, along the existing wiring harness and plug into the intercooler pump connector where shown with yellow arrow. Secure harness with cable tie in location shown with blue arrow.

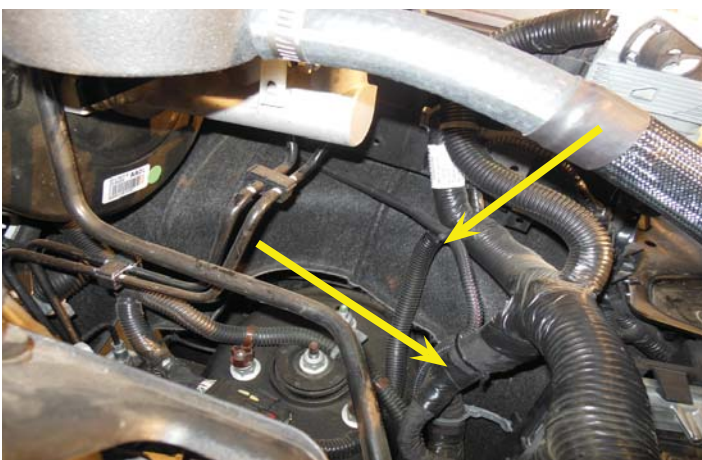

152. Secure the pump harness to the existing harness using the provided cable ties.



153. Remove the fuse center cover by pressing the release tabs and lifting up.



154. Cut a small slot in the back lip of the fuse center tray where shown with blue arrow. This will allow the yellow wire from the relay to pass into the fuse box.



155. Remove the fuse number 74 (labeled: ECM IGN) from the slot in the fuse center. Connect the fuse tap end of the yellow wire from the inter-cooler wiring harness to one leg of the fuse just removed.



156. Replace the fuse in slot number 74 (labeled: ECM IGN) with the fuse tap installed on one leg. Press the yellow wire down into the slot you created earlier.



157. Replace the cover on the fuse center engaging the snaps. The lid should NOT be crimping down on the yellow wire.

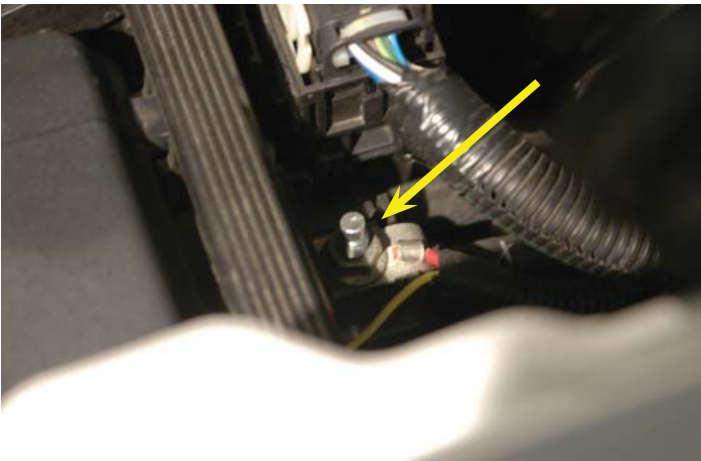

158. Flip the cover open at the back of the fuse center. Remove the nut of the positive lead using a 13mm wrench. Replace the nut incorporating the eyelet terminal on the red wire from the inter-cooler wiring harness.

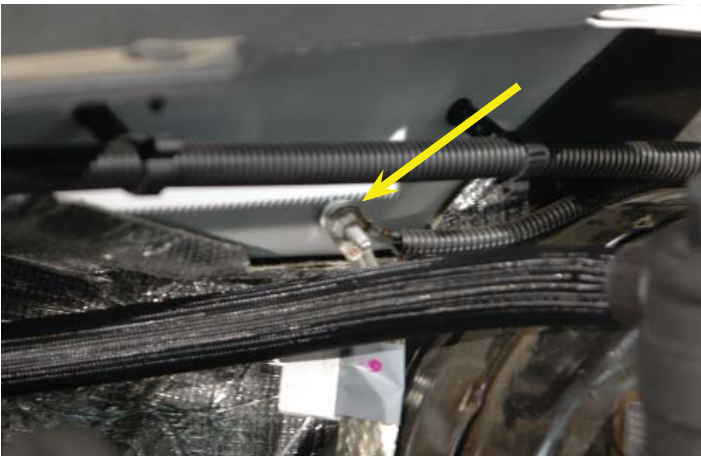

159. Connect the black ground wire eyelet terminal to the existing grounding bolt at the firewall on the left hand side, just above and inside the brake booster canister.



Section 8: Install Air Quality Control and System Monitoring Devices

160. Connect the factory EVAP plug to the EVAP extension harness connector on the left hand side of the engine.



161. Mount the OEM EVAP solenoid to the provided mounting bracket using the factory mounting bolt and provided spacer using a 10mm wrench as shown. Washer may not be on original bolt. Add blue Loctite 242 to bolt before installing. **The black spacer should sit between the solenoid and bracket.**



162. Mount the EVAP solenoid bracket assembly to the left side boss on the supercharger lid using the provided 16mm long M6 bolt and secure in place with a 10mm wrench. Torque to 106 in-lbs.



163. Connect the extended EVAP solenoid plug to the EVAP sensor. Secure the extension harness to the coil pack harness with a few of the provided zip-ties.



164. Connect the provided 10" x 3/8" PCV hose between the EVAP solenoid and the supercharger inlet hose barb. No clamps are required. Adjust hose length to prevent rubbing on supercharger bolt head. If necessary adjust hose length to prevent rubbing on supercharger bolt head.



165. Connect the free end of the hose installed in step #134 to the rear barb on the EVAP solenoid. Make sure both connections on the hose are secure.

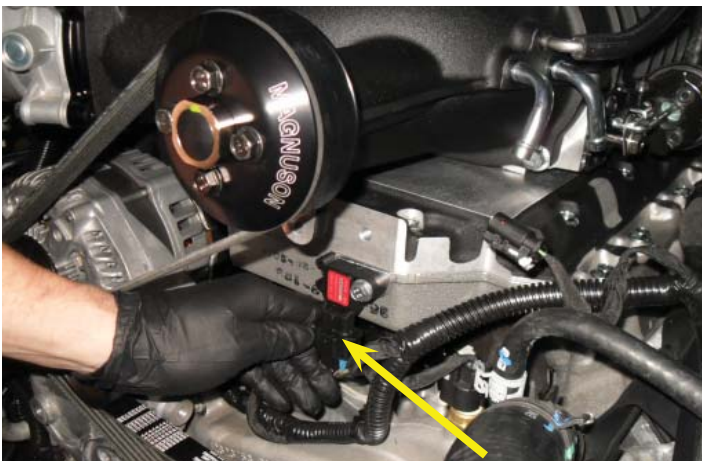

166. Connect the factory MAP harness plug to the provided MAP sensor.

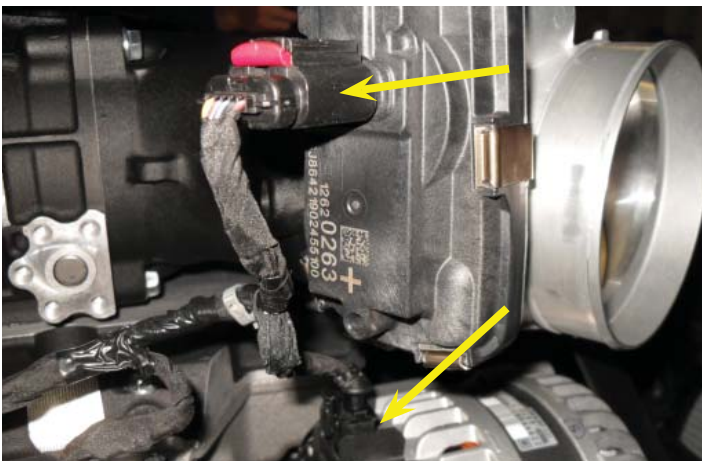

167. Connect the throttle body plug to the throttle body. Connect the alternator wire plug to the receptacle on the alternator. Some tape removal on the harness may be needed to allow the connection between throttle body, and alternator.



168. Replace the factory air box by pressing into position until the unit snaps in place. Push the wire loom mounting "tree" back into the hole on the back side flange of the air box.

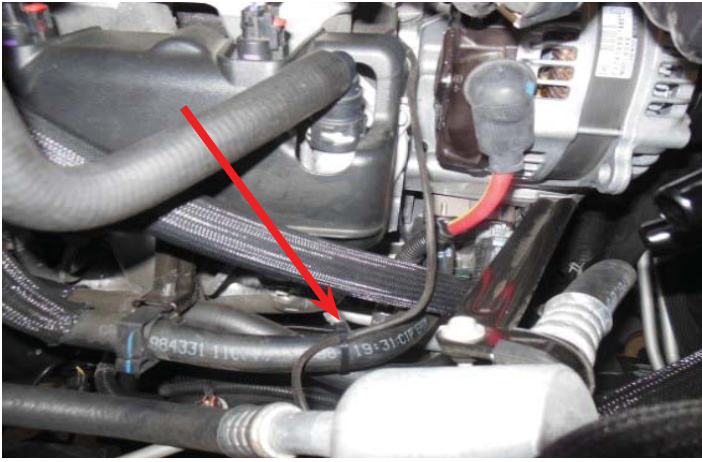

169. Route the MAF/IAT breakout from behind the alternator. Make sure the harness is not pinched or caught by the alternator. Use a tie wrap to secure the harness to the factory heater hose as shown by the red arrow to the left.

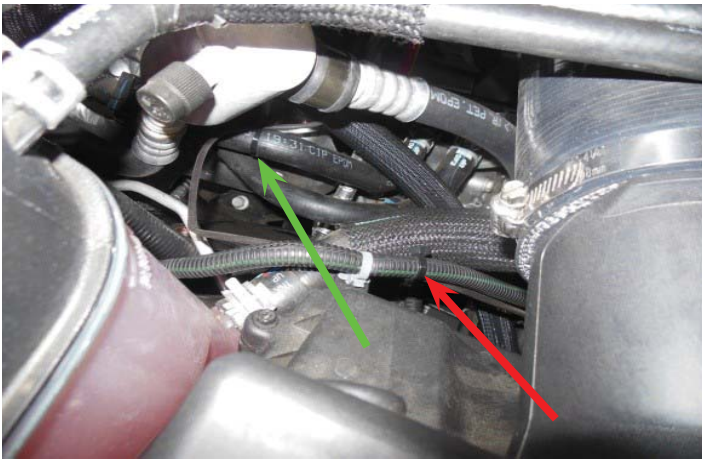

170. Continue to pass the harness to the right underneath the AC line. Secure the MAF/IAT breakout harness with another tie wrap to the factory MAF harness as shown by the red arrow to the right. ***Note: The green arrow is a reference to the tie wrap installed in the previous step.**



171. Pass the MAF/IAT breakout harness underneath the MAF tube of the air box lid. Connect the male end of the provided MAF/IAT breakout harness to the factory plug. You can now plug the female end of the provided MAF/IAT breakout into the factory MAF sensor. Ensure that all connections have clicked into place, and slide the red locking tab(s) back into place. Use two more tie wraps to secure the MAF/IAT breakout as shown by the red arrows to the left.



172. Clean up your wiring adding zip-ties as needed to secure the wiring.

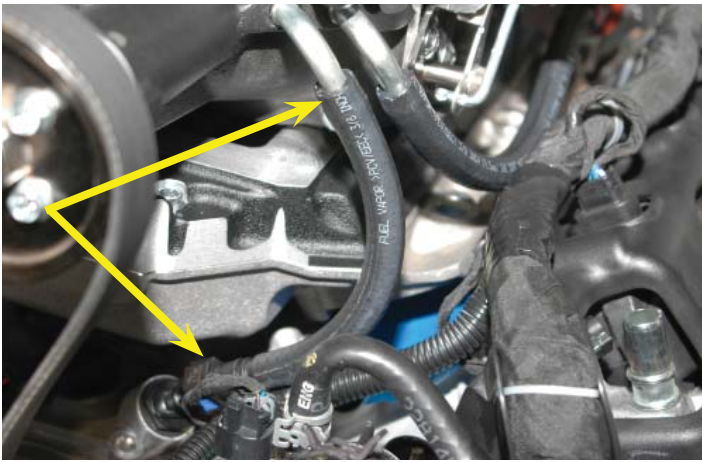

173. Connect the provided PCV hose with the blue quick connect to the PCV fitting in the valley cover. Connect the free end to the remaining barb on the supercharger inlet.

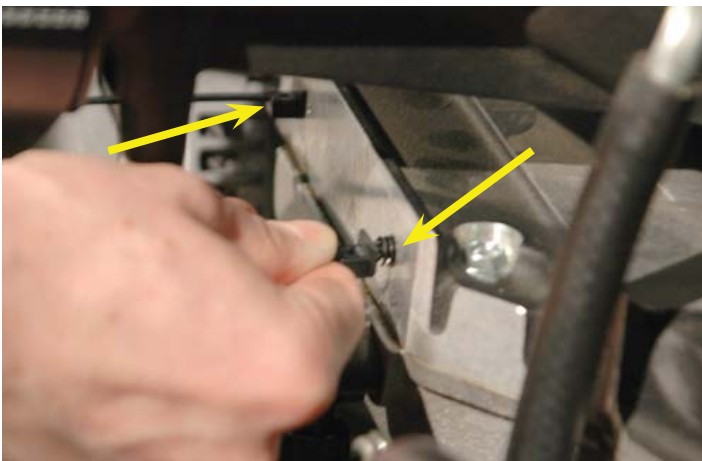

174. Push the two provided zip-tie "tree" connectors into the two threaded holes in the front of the supercharger intake manifold. The flat part of the connector should be pointing up.



175. Slide the provided 8" section of split loom over the PCV hose and anchor in place at each end using two 1" pieces of the provided heat shrink as shown.



176. Connect the 90° hose barb on the uncovered side of the PCV hose to the left hand side front of the valve cover hose barb. Route the hose under the supercharger inlet toward the right hand side of the vehicle. The split loom covered section of the hose should be on the right hand side above the alternator.

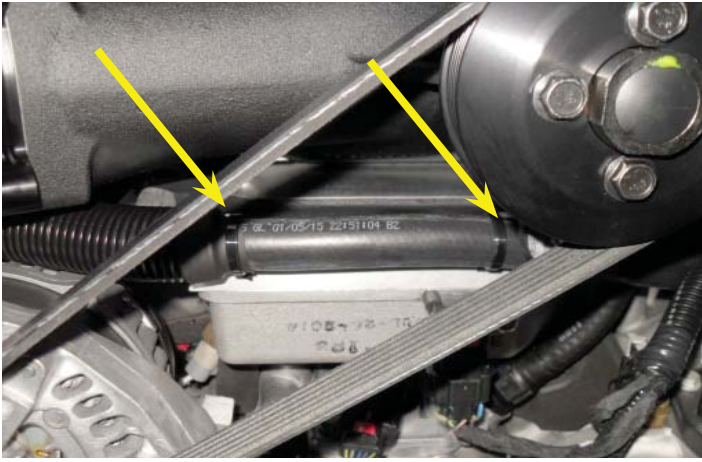

177. Anchor the PCV hose to the front of the supercharger intake manifold using the installed zip-tie tree mounts.



178. Gather the rubber duct shown. Loosen hose clamps to prepare for install. The left side clamp will be taken off completely to install duct over throttle body.



179. Install the rubber duct from previous step on the air box. Apply Lubriplate grease to the side near the throttle body to ease installation.



180. Install rubber duct onto throttle body side. Then install hose clamp around connection. Make sure duct tabs line up with throttle body indicated with arrow.



181. Tighten the hose clamps on both sides.

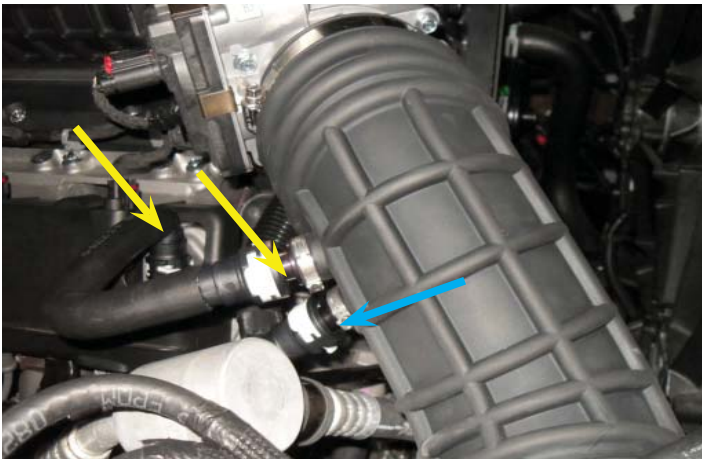

182. Connect the free end of the PCV hose from the left hand side front valve cover hose barb onto the lower hose barb of the air tube (Indicated with a blue arrow). Connect the provided 90° PCV hose between the hose barb on the right hand side front of the valve cover and the remaining upper hose barb of the air tube as shown with yellow arrows.



183. If you disconnected the reservoir overflow hoses earlier, reconnect using the OEM clamps.



Section 9: Coolant Fill, Replacing Fascia/Grille and Testing

184. Re-connect the battery negative terminal using a 10mm socket wrench.



185. Fill the charge air cooler system with the vehicle manufacturer recommended coolant mixture. Have an assistant temporarily key vehicle on to turn the pump on. Key vehicle off after 5 seconds. Fill reservoir full again and continue this process until fluid is circulating. At this time check engine and supercharger for any leaks.



186. After you have filled your intercooler system, and verified the connections are leak free, reinstall headlights, fascia, and grille following steps shown in Section 3 in reverse order.

Vehicle Testing

Start the vehicle for 5 seconds and shut off, once again check for fuel leaks and fan-supercharger belt alignment. You may need to shim the idler that you installed to center it on the belt. Check radiator and charge air cooler reservoir and top off as necessary.

Test drive vehicle for the first few miles under normal driving conditions. **Do not perform any wide open throttle runs.** Listen for any noises, vibrations, engine misfire or anything that does not seem normal. The supercharger does have a slight whining noise under boost conditions, which is normal. Check & bleed the charge air cooler reservoir as needed.

After the initial test drive gradually work the vehicle to wide open throttle runs, listen for any engine detonation (pinging). If engine detonation is present let up on the throttle immediately. Most detonation is caused by low octane gasoline still in the tank.

If you have questions about your vehicles performance, please check with your installation facility.

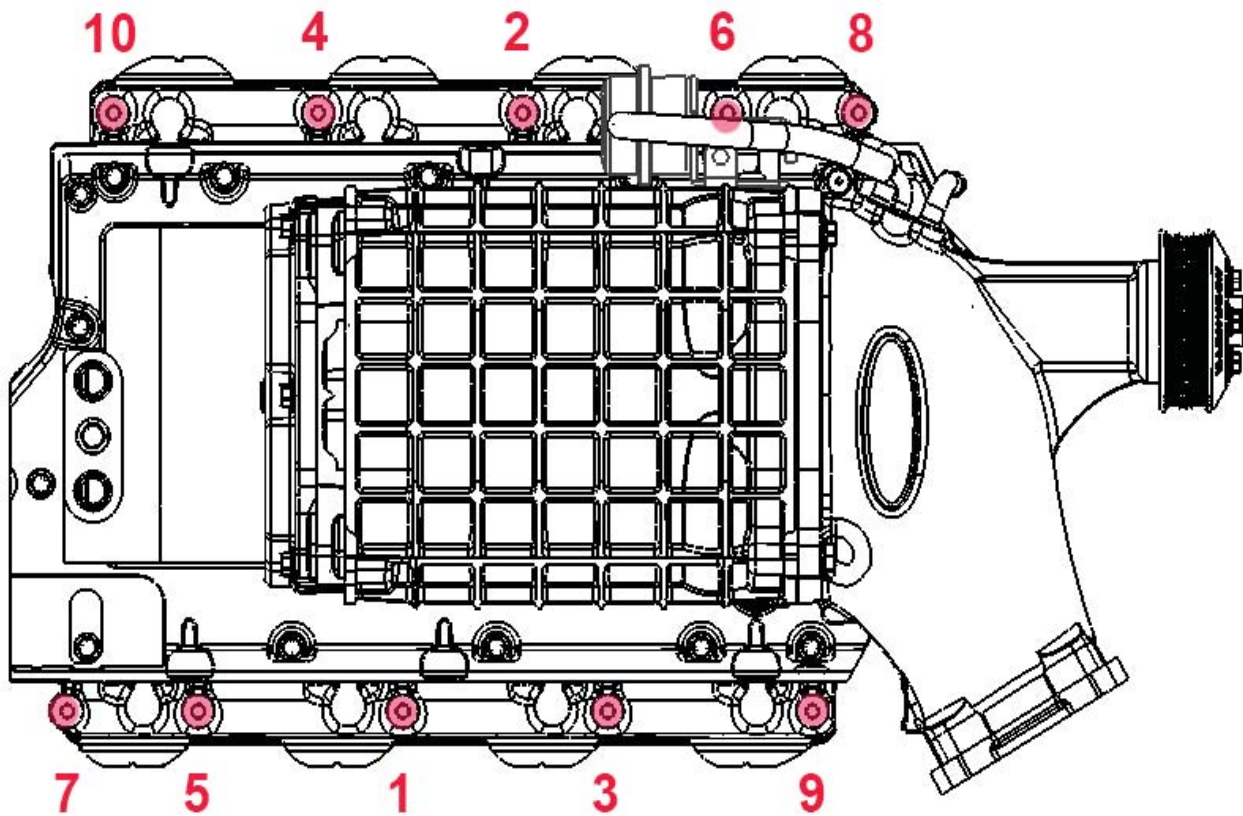

Supercharger Torque
Order Diagram

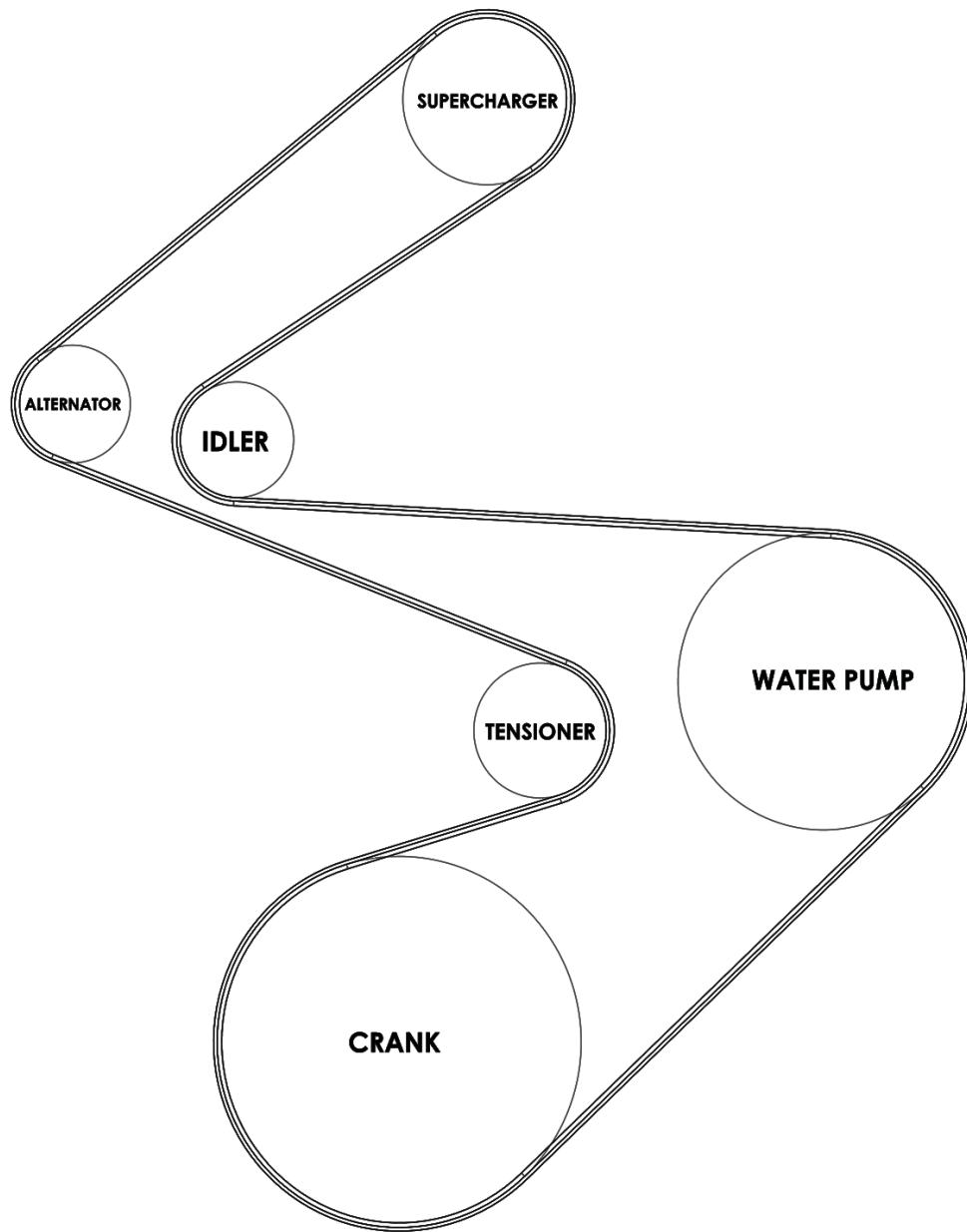

Belt Routing Diagram

Reservoir to Pump

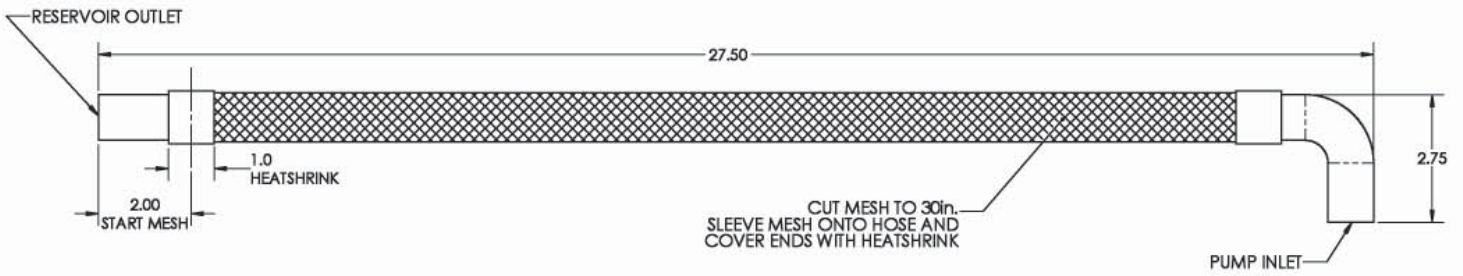

Hardline to Lower LTR

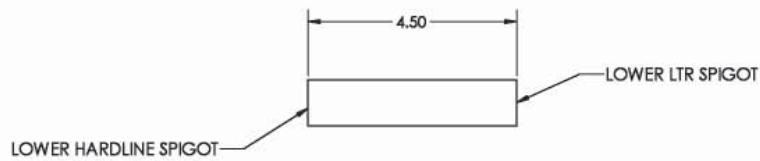

Hardline to CAC

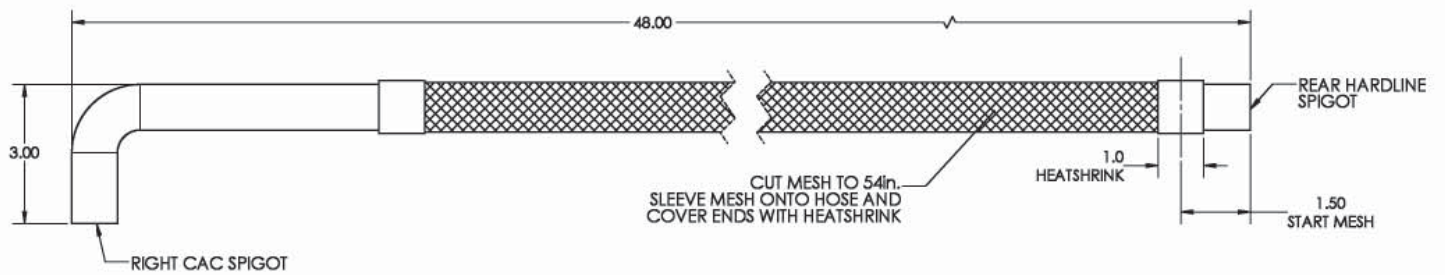

Pump to Hardline

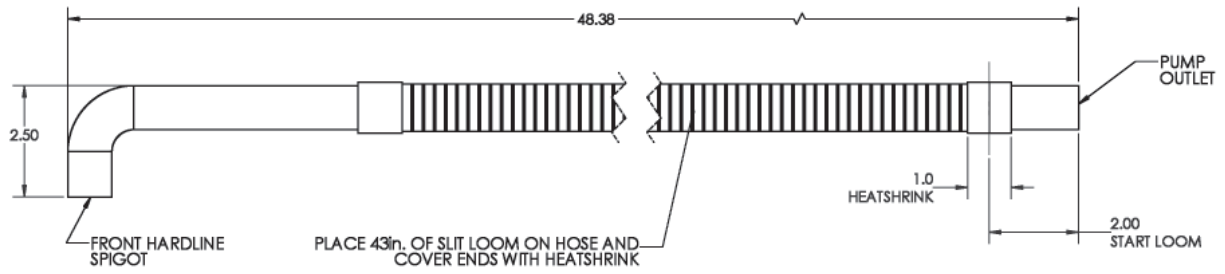

Hardline to Upper LTR

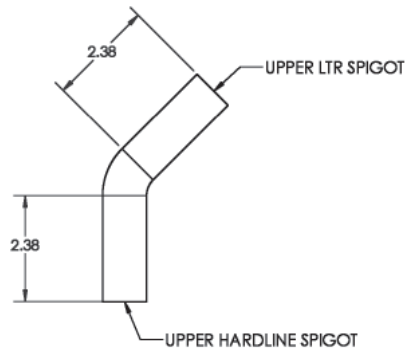

CAC to Reservoir

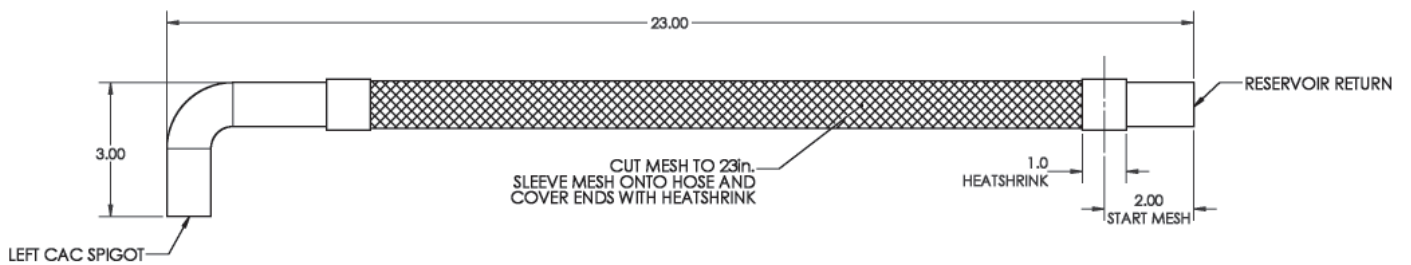



NOTE: This vehicle IS NOT compatible with E85 fuel. You can use only premium gasoline fuel 91 Octane or better. Ethanol is NOT compatible with the engine after supercharger install.



Please enjoy your "Magna Charged"
performance responsibly!

MAGNUSON
SUPERCHARGERS