



Innovation  
that excites

## 2015 FRONTIER®

### WELCOME TO THE 2015 NISSAN FRONTIER® DIGITAL BROCHURE

Full of images, feature stories, and all the specification and trim level information you need to help select your Frontier.®

[Click here](#) to sign up for news and updates on the 2015 Nissan Frontier.®



BROCHURE REFLECTS MY15 PRODUCT INFORMATION. Please check back soon for the 2016 Brochure.



## WHAT IF\_ TOUGH WAS ALWAYS ON CALL?

Got a major to-do list? No problem. With Frontier,<sup>®</sup> you've got a partner that's up to the biggest challenges. It's a mid-size truck with full-size attitude and plenty of engine muscle and towing capacity<sup>1</sup> to get the job done. A fully boxed ladder frame and advanced off-road technology come standard, so no matter what you're doing, you can do it easily. King Cab<sup>®</sup> or Crew Cab, there's room for work and play. And with the Desert Runner<sup>®</sup> or PRO-4X<sup>®</sup> models, you choose when to cut a trail from the highway to the hills. The 2015 Nissan Frontier.<sup>®</sup>



Nissan Frontier<sup>®</sup> PRO-4X<sup>®</sup> King Cab<sup>®</sup> shown in Lava Red.

<sup>1</sup>See Nissan Towing Guide and Owner's Manual for proper use.





Nissan Frontier® SV V6 King Cab\* shown in Night Armor with accessory Splash Guards.



**WORKS UNTIL YOU SAY WHEN.**



Nissan Frontier<sup>®</sup> SL Crew Cab shown in Night Armor with optional equipment and accessory Splash Guards.



# NISSAN KNOWS THAT FOUR WALLS ARE STRONGER THAN THREE.

That's why Frontier® features a full-length, fully boxed ladder frame instead of the 3-sided, open C-shape rails found on some other trucks. The frame is built with super-high-tensile-strength steel in strategic areas for enhanced structural rigidity. This rugged material is stronger than conventional steel for increased torsional stiffness that helps deliver improved performance, on- and off-road. And it's the perfect foundation to build upon with our advanced technology.



FULLY BOXED FRAME



CONVENTIONAL C-RAIL

**Anti-lock Braking System (ABS)** rapidly pumps the brakes during hard braking to help keep your wheels from locking up, helping you steer around an obstacle.

**Electronic Brake force Distribution (EBD)** senses additional weight, whether it's a full cargo bed or a full tank of gas, and sends extra force to the rear brakes.

**Brake Override Technology.** Standard on every Frontier®, it's designed to help slow down your vehicle and bring it to a stop in an emergency. It works by overriding accelerator input and reducing engine power when the accelerator and brake pedals are applied simultaneously.

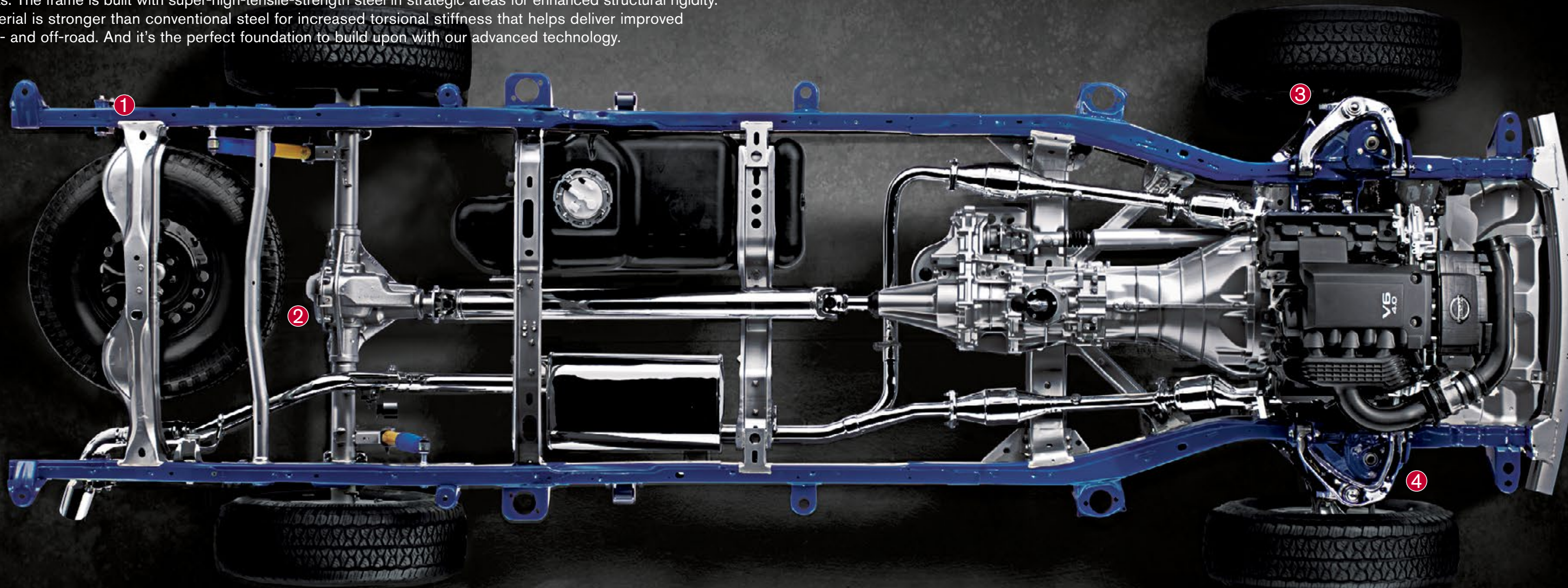

- ① Overslung rigid leaf-spring rear suspension
- ② Available heavy-duty Dana® rear axle

- ③ 4-wheel vented disc brakes with Anti-lock Braking System (ABS)
- ④ Steel double-wishbone front suspension



**Vehicle Dynamic Control (VDC).** Also known as electronic stability control, VDC monitors driver inputs and vehicle motion and helps compensate for oversteer or understeer to help keep you on your steered path.<sup>1,2</sup>

**Active Brake Limited Slip (ABLS).** To help keep your wheels from spinning, Frontier® offers ABLS. This system senses when a wheel begins to slip, then automatically brakes the slipping wheel and sends additional power to the wheel (or wheels on 4x4 models) with the best traction.<sup>2</sup>

Some components have been chrome-plated or painted for display purposes only. <sup>1</sup>VDC, which should remain on when driving except when freeing the vehicle from mud or snow, cannot prevent accidents due to abrupt steering, carelessness, or dangerous driving techniques. <sup>2</sup>Standard on all models. Dana® is a registered trademark of Dana Corporation.



## CAPABILITY IS IN YOUR CORNER.

Power – either you've got it, or you don't. And with Frontier,<sup>®</sup> you've got it in a big way. With an available 4.0-liter V6 engine packing 261 horsepower, your V6 is chomping at the bit. And with a massive, best-in-class 281 lb-ft of torque,<sup>1</sup> you can tow or haul just about anything you need to bring along.<sup>2</sup> Maybe it's because we're a company that loves to compete – off-road, on the racetrack, even in the showroom. But wherever we win, we're happy to share the prize with you.

# 261

HORSEPOWER

# 281

LB-FT OF TORQUE

# 6,500

LBS. MAX TOWING<sup>2</sup>



**V6 power.** The available 24-valve 4.0-L V6 works its magic with advanced technology, including a lightweight aluminum engine block, advanced valve timing system, variable intake, and race-bred friction-reducing technology.

**A 4-cylinder that feels like a 6.** Frontier<sup>®</sup> also offers a 2.5-L 4-cylinder that pumps out 152 horsepower, 171 lb-ft of torque, and features a compact balancer system to deliver the smoothness of a V6.

**Gear up.** You can harness the 4-cylinder's power through a 5-speed manual transmission or an available 5-speed automatic. The V6 is available with either a 6-speed manual or 5-speed automatic transmission.

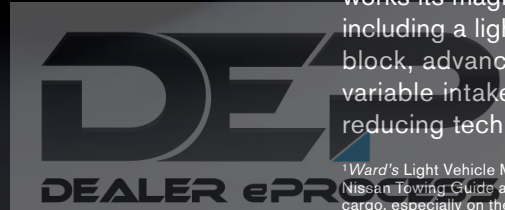

<sup>1</sup>Ward's Light Vehicle Market Segmentation. 2015 Frontier<sup>®</sup> vs. 2015 Small Pickup Class. <sup>2</sup>King Cab<sup>®</sup> 4x2 models with V6. 7-pin connector trailer wire harness and tow hitch receiver required, both sold separately. See Nissan Towing Guide and Owner's Manual for proper use. Cargo shown for display purposes only. Cargo and load capacity limited by weight and distribution. Always secure all cargo. Heavy loading of the vehicle with cargo, especially on the roof, will affect the handling and stability of the vehicle.



## SHAKE UP SOME SAND.

Looking for some major attitude? The Desert Runner® trim serves it up with looks that thrill. Amp up your cool factor with 16" 6-spoke aluminum-alloy wheels, a satin chrome grille, and details like fog lights and a body-color rear bumper. Bilstein® off-road performance shocks and 265/75R16 mud- and snow-rated all-terrain tires maximize your potential. And a unique bedside decal tops it off – just before you leave them in the dust.

**DESERT RUNNER®**

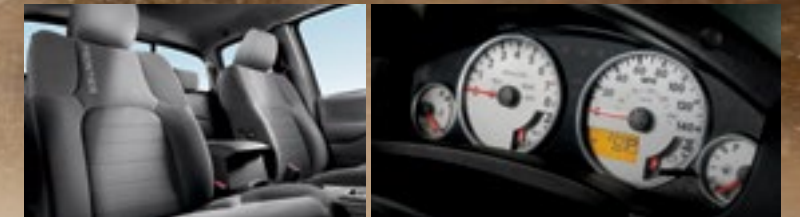

**Dialed in.** Get a new perspective inside as well with high-visibility white-faced gauges and unique embroidered sport cloth front seats, including an 8-way adjustable driver's seat. Endure even the longest trek with a USB input for your iPod® and steering wheel-mounted audio controls!

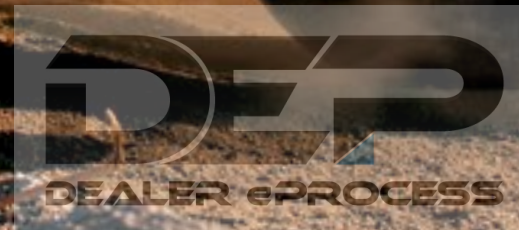

Nissan Frontier® Desert Runner® King Cab® shown in Glacier White with accessory Splash Guards.



## TREAT 'EM LIKE PEBBLES.

The ultimate off-road Frontier,<sup>®</sup> the PRO-4X.<sup>®</sup> Exhibit championship form with unrivaled gear, including Bilstein<sup>®</sup> off-road performance shocks, an electronic locking rear differential, 4-wheel Active Brake Limited Slip (ABLS), skid plates, and 265/75R16 mud- and snow-rated all-terrain tires. Add in 16" 6-spoke aluminum-alloy wheels, fog lights, and an exclusive interior, and you've got a winning combination, inside and out.

**PRO-4X**<sup>®</sup>



**Hill start assist.** When starting on steep hills from a stop, hill start assist will help keep you from rolling backwards. It holds brake pressure for a few seconds, allowing you time to switch from the brake pedal to the accelerator.

**Hill descent control.** When driving down a steep grade in 4WD, hill descent control can help. Just push the button, ease your foot from the accelerator, and this system automatically maintains speed and brake pressure to help provide a controlled descent.

**Electronic locking rear differential.** When 4x4 mode just isn't enough, push the button to activate the electronic locking rear differential. This ultimate off-road feature delivers equal power to both rear wheels to boost traction and help keep your truck moving forward. When engaged, it works in conjunction with the 4-wheel Active Brake Limited Slip (ABLS). So while the locking rear differential keeps the rear wheels powered to move you ahead, ABLS helps give you the traction you need up front to help maintain steering control.





# NISSAN UTILI-TRACK® SYSTEM INNOVATION THAT'S GOT A GRIP.

Wouldn't it be cool if you could put the submission hold on cargo? The available Utili-track® Channel System on Frontier® gives you choices few other trucks can match.<sup>1</sup> Just about any type of cargo you can think of, this system is fully equipped to help keep it secured tightly. Five channels, four cleats, and a lot of thought about how people really use their trucks have created a system that's simple, rugged, and offers near-infinite possibilities.



## LOADS OF ACCESSORIES

There's also a full line of available accessories to help you get even more out of Utili-track®, including a Sliding Tool Box,<sup>2</sup> a Sliding Bed Divider, and a Sliding Bed Extender.

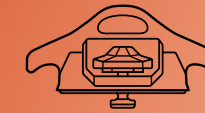

## 4 CLEATS

Frontier's four heavy-duty forged aluminum cleats easily slide in the channels for unmatched flexibility to tie things down – and the strength to hold them.

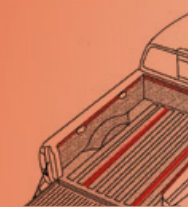

## 5 CHANNELS

Unmatched versatility comes in the form of five channels – including two channels in the floor, a feature few competitors can match. And since you can lock the cleat anywhere along the rail, Frontier® makes sure you find the best position to secure whatever you bring along.



## SPRAY-ON BEDLINER

Adding to the incredible versatility of the bed, the available spray-on bedliner is applied at the factory – so you know it's done right. Fade- and weather-resistant, it's a rugged, non-skid surface that adheres directly to the bed to help prevent rusting and protect the truck's bed.

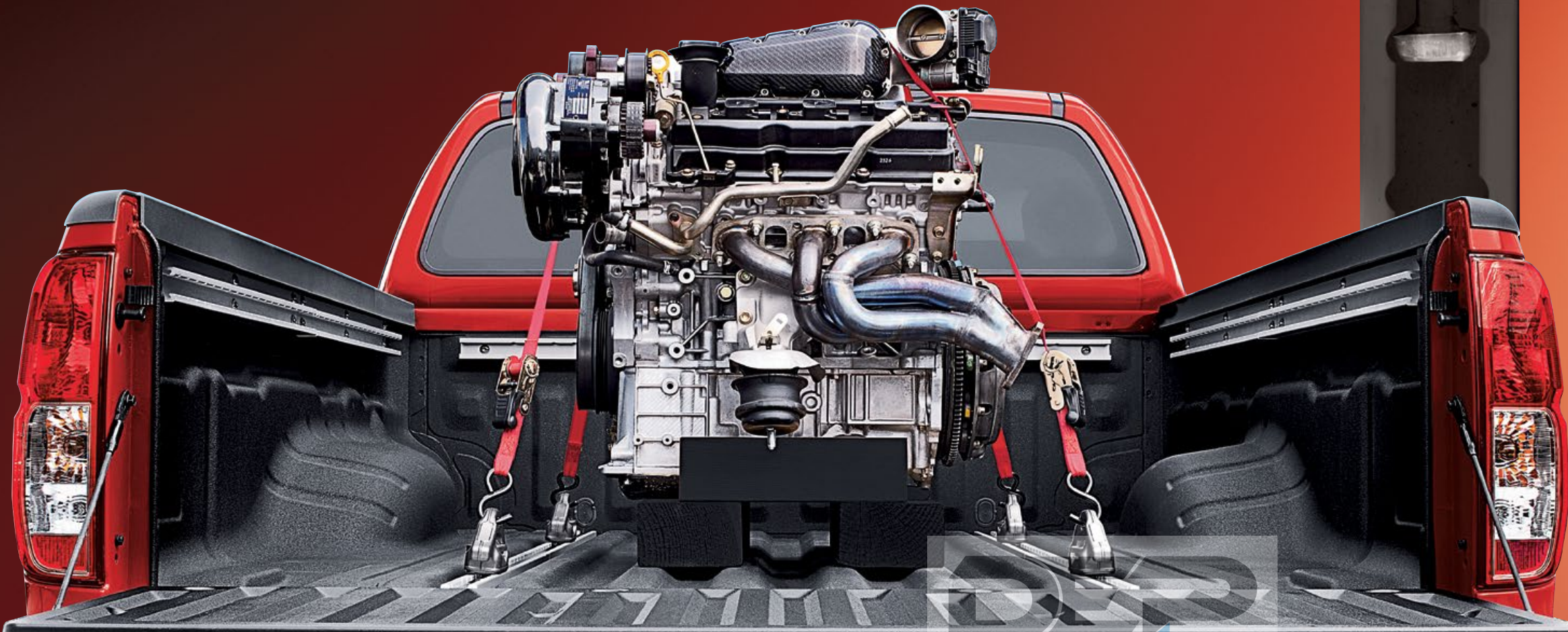

DEALER ePROCESS

<sup>1</sup>Cargo shown for display purposes only. Cargo and load capacity limited by weight and distribution. Always secure all cargo. Heavy loading of the vehicle with cargo, especially on the roof, will affect the handling and stability of the vehicle. <sup>2</sup>Tool Box Tray shown in photo is sold separately. See your Nissan dealer for more information.





## BRING YOUR CAVE ALONG WITH YOU.



Comfort, entertainment, cup holders – they’re all here. Whether on the job or on the go, Frontier® gives you everything you need to make the space yours. A great-looking interior plus an available sporty, leather-wrapped steering wheel with cruise control and audio adjustments – all the better to crank up the available Rockford Fosgate®-powered audio system, which features 10 speakers,<sup>1</sup> including subwoofers. The available<sup>2</sup> Bluetooth® Hands-free Phone System lets you make and take calls with your hands on the wheel and listen to calls through the audio system’s speakers.<sup>3</sup> Available Dual Zone Automatic Temperature Control (ATC) lets you and your passenger set your own climates. With this level of comfort and convenience, when you get where you’re headed, you might not want to get out.



Nissan Frontier® PRO-4X® Crew Cab shown in Graphite Leather with optional equipment.

<sup>1</sup>Crew Cab only. <sup>2</sup>Standard on all models except Frontier S King Cab® with manual transmission. <sup>3</sup>Availability of specific features is dependent upon the phone's Bluetooth® support. Please refer to your phone Owner's Manual for details. Bluetooth® word mark and logos are owned by Bluetooth SIG, Inc., and any use of such marks by Nissan is under license. Rockford Fosgate® is a registered trademark of Rockford Corporation.





## IT'S LIKE HAVING EYES IN THE BACK OF YOUR TRUCK.

What if you had some help seeing objects directly behind you? The available RearView Monitor automatically activates whenever you're in Reverse, helping you line up your approach to a trailer.<sup>1</sup> Now that's handy. Plus, the available Rear Sonar System beeps when it senses a nearby object while backing up and increases in frequency the closer you get to help you maneuver in tight spaces.<sup>2</sup>

<sup>1</sup>Parking aid/convenience feature. Cannot completely eliminate blind spots. May not detect every object and does not warn of moving objects. Always check surroundings and turn to look behind you before moving vehicle. <sup>2</sup>The Sonar System is a convenience, not a substitute for proper parking and/or backing procedures. Always check that it is safe to do so before moving vehicle. May not detect every object.





# NissanConnect<sup>SM</sup> YOUR WORLD, AT YOUR FINGERTIPS.

With available NissanConnect<sup>SM</sup> with Mobile Apps, your Frontier<sup>®</sup> becomes your smartphone's best friend. Which means no more separation anxiety for you. Because now your own hand-picked music, Facebook<sup>®</sup>, latest tweets, and more all come along for the ride, working seamlessly together through your smartphone and Frontier<sup>®</sup>'s available color monitor.<sup>1</sup>



Your Frontier<sup>®</sup> also keeps you in the loop with the available Nissan Navigation System (featuring voice recognition),<sup>2</sup> hands-free text messaging assistant,<sup>3</sup> Bluetooth<sup>®</sup> hands-free calling and streaming audio,<sup>4</sup> plus an iPod<sup>®</sup>/USB input.<sup>5</sup>

For the full story on NissanConnect<sup>SM</sup> with Mobile Apps, go to [bit.ly/frontierconnect15](http://bit.ly/frontierconnect15)

<sup>1</sup>Driving is serious business. Only use NissanConnect<sup>SM</sup> services when safe to do so. Subscription Agreement required. Compatible smartphone required. Not all app features are available for all models. Some apps have late availability. May require dealer service visit or software upgrade to activate. Never program while driving. GPS mapping may not be detailed in all areas or reflect current road status. Cellular network not available in all areas. Cellular network, apps, and services, including Google<sup>®</sup> services, are provided by independent companies not within Nissan's control and may require subscription and owner consent to activate. Should provider terminate/restrict service, service may be terminated without notice or liability to Nissan and/or its agents. Nissan not responsible for any equipment or app replacement/upgrades, or associated costs, that may be required for continued operation. Terms and conditions of Subscription Agreement apply. 36-month trial period starts on vehicle sale date; subsequently a paid subscription is required at the then current rate (excludes Pandora<sup>®</sup>). Standard text rates and/or data usage may apply. See retailer and check [www.NissanUSA.com/connect](http://www.NissanUSA.com/connect) for details. <sup>2</sup>Never program while driving. GPS mapping may not be detailed in all areas or reflect current road status. <sup>3</sup>Use the text messaging feature after stopping your vehicle in a safe location. If you have to use the feature while driving, exercise extreme caution at all times so full attention may be given to vehicle operation. Compatible smartphone required. Standard text rates and/or data usage may apply. <sup>4</sup>Availability of specific features is dependent upon the phone's Bluetooth<sup>®</sup> support. Please refer to your phone Owner's Manual for details. Bluetooth<sup>®</sup> word mark and logos are owned by Bluetooth SIG, Inc., and any use of such marks by Nissan is under license. <sup>5</sup>Driving is serious business and requires your full attention. If you have to use the connected device while driving, exercise extreme caution at all times so full attention may be given to vehicle operation. iPod<sup>®</sup> is a registered trademark of Apple, Inc. All rights reserved. iPod<sup>®</sup> not included. The App Store<sup>®</sup> logo is a registered trademark of Apple, Inc. All rights reserved. Facebook<sup>®</sup> is a registered trademark of Facebook, Inc. Google<sup>®</sup> and the Google<sup>®</sup> Play logo are registered trademarks of Google Inc. iHeartRadio<sup>®</sup> is a trademark of iHeart Media. Pandora<sup>®</sup> is a registered trademark of Pandora Media. The Sirius<sup>®</sup>, XM<sup>®</sup>, and SiriusXM<sup>®</sup> names and all related marks and logos are trademarks of Sirius XM Radio Inc.

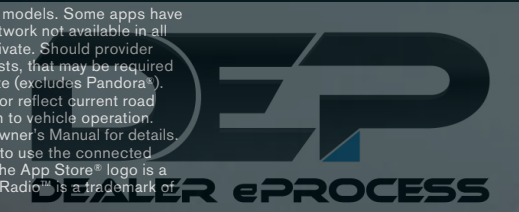





## LOAD IT ALL IN THE CREW CAB.

**Frontier® Crew Cab.** Space or comfort? Why not both? Forward-hinged doors make for easy entry, and a 60/40 split rear bench allows seating for five and folds easily to create a large, flat surface. Or you can flip up the rear-seat cushions for more storage room. There's also an under-seat storage tray that's removable for even greater versatility.

FOLDS FLAT



FLIPS UP



Nissan Frontier® SL Crew Cab shown in Steel Leather.





**GO WIDE WITH THE KING CAB.®**

**Frontier® King Cab.®** Smart design means rear doors that give your passengers easy access to the cabin. And with no B-pillars, you also get a huge opening for larger-than-life items. The two rear seats face forward or flip up and out of the way to reveal a wide open space for cargo.<sup>1</sup>



Nissan Frontier® PRO-4X® King Cab® shown in Graphite Steel Cloth.

<sup>1</sup>Cargo and load capacity limited by weight and distribution. Always secure all cargo. Heavy loading of the vehicle with cargo, especially on the roof, will affect the handling and stability of the vehicle.



## KEEP IT UNDER WRAPS.

When it comes to keeping your cabin tidy and your gear safe from prying eyes, Frontier® gives you some smart options, including (1) a multi-level center console, (2) removable storage under the rear seats, and (3) a big, dual-level glove compartment.<sup>1</sup>

<sup>1</sup>See Specifications section for availability. Cargo shown for display purposes only. Cargo and load capacity limited by weight and distribution. Always secure all cargo. Heavy loading of the vehicle with cargo, especially on the roof, will affect the handling and stability of the vehicle.

**DEALERS**  
**DEALER ePROCESS**





# NISSAN SAFETY SHIELD® PHILOSOPHY

## INNOVATION THAT LOOKS OUT FOR YOU.

Wouldn't it be cool if you had the confidence you need for every part of your drive? The Nissan Safety Shield® is a comprehensive approach to safety that guides the engineering and development of every vehicle we make.

### MONITOR

Smart technologies help monitor conditions. Like an available rearview camera that helps you see something directly behind you or a system that helps ensure you're travelling on properly inflated tires.

- Tire Pressure Monitoring System<sup>1</sup>
- Available Automatic On/Off Headlights
- Available RearView Monitor<sup>2</sup>
- Available Rear Sonar System<sup>3</sup>

### RESPOND

Whether you need to hit the brakes hard or maneuver around an unexpected obstacle, these standard technologies help you respond to a potentially harmful situation.

- Vehicle Dynamic Control helps you maintain your steered path.<sup>4</sup>
- Traction Control System helps reduce wheelspin in low-traction situations.
- Anti-lock Braking System helps you maintain steering control around obstacles while braking heavily.
- Electronic Brake force Distribution sends extra force to the rear brakes when you have additional weight of passengers or cargo in the back.
- Brake Assist helps apply maximum braking force if it detects hard braking and senses you are in an emergency situation.<sup>5</sup>

### PROTECT

When a collision is unavoidable, Nissan's Zone Body construction helps absorb the impact while the advanced seat belt and air bag systems help protect passengers.

- Six Standard Air Bags<sup>6</sup>
- LATCH System (Lower Anchors and Tethers for Children)

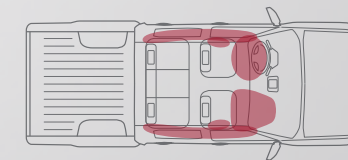

**Six Standard Air Bags<sup>6</sup>** Nissan Advanced Air Bag System has dual-stage supplemental front air bags with seat belt and occupant-classification sensors.<sup>6</sup> Additionally, Frontier has front seat-mounted side-impact supplemental air bags,<sup>6</sup> and roof-mounted curtain side-impact supplemental air bags with rollover sensor.<sup>6</sup>



**Available RearView Monitor** Whether you're hitching to a trailer or fitting in to a tight parking space, it's like an extra pair of eyes where you need them most.<sup>2</sup>

**snug+kids.** Nissan safety engineers have dedicated thousands of hours to evaluating hundreds of child restraints in Nissans. The result: An industry first, The Snug Kids® Child Safety Seat Fit Guide. This guide lists child seats that fit the rear seats of Nissan vehicles, as well as offers invaluable tips on correct installation. Look for the latest Fit Guide at [NissanUSA.com/SnugKids](http://NissanUSA.com/SnugKids).

Looking for the right CRS for your Nissan? Click the button to see how Snug Kids® can help, or go to [bit.ly/NissanSnugKids](http://bit.ly/NissanSnugKids)



<sup>1</sup>TPMS is not a substitute for regular tire pressure checks. <sup>2</sup>Parking aid/convenience feature. Cannot completely eliminate blind spots. May not detect every object and does not warn of moving objects. Always check surroundings and turn to look behind you before moving vehicle. <sup>3</sup>The Sonar System is a convenience, not a substitute for proper parking and/or backing procedures. Always check that it is safe to do so before moving vehicle. May not detect every object. <sup>4</sup>VDC, which should remain on when driving except when freeing the vehicle from mud or snow, cannot prevent accidents due to abrupt steering, carelessness, or dangerous driving techniques. <sup>5</sup>Brake Assist is only an aid to assist the driver and is not a collision warning or avoidance device. It is the driver's responsibility to be in control of the vehicle at all times. <sup>6</sup>Air bags are only a supplemental restraint system; always wear your seat belt. Even with the occupant-classification sensor, rear-facing child restraints should not be placed in the front-passenger's seat. All children 12 and under should ride in the rear seat properly secured in child restraints, booster seats, or seat belts according to their size. And please see your King Cab® Owner's Manual for specific information about the safest way to secure a child restraint in a Frontier® King Cab.® Air bags will only inflate in certain accidents; see your Owner's Manual for more details. Inflated air bags shown for illustration purposes only, actual coverage area may differ. Air bags deflate after deployment.



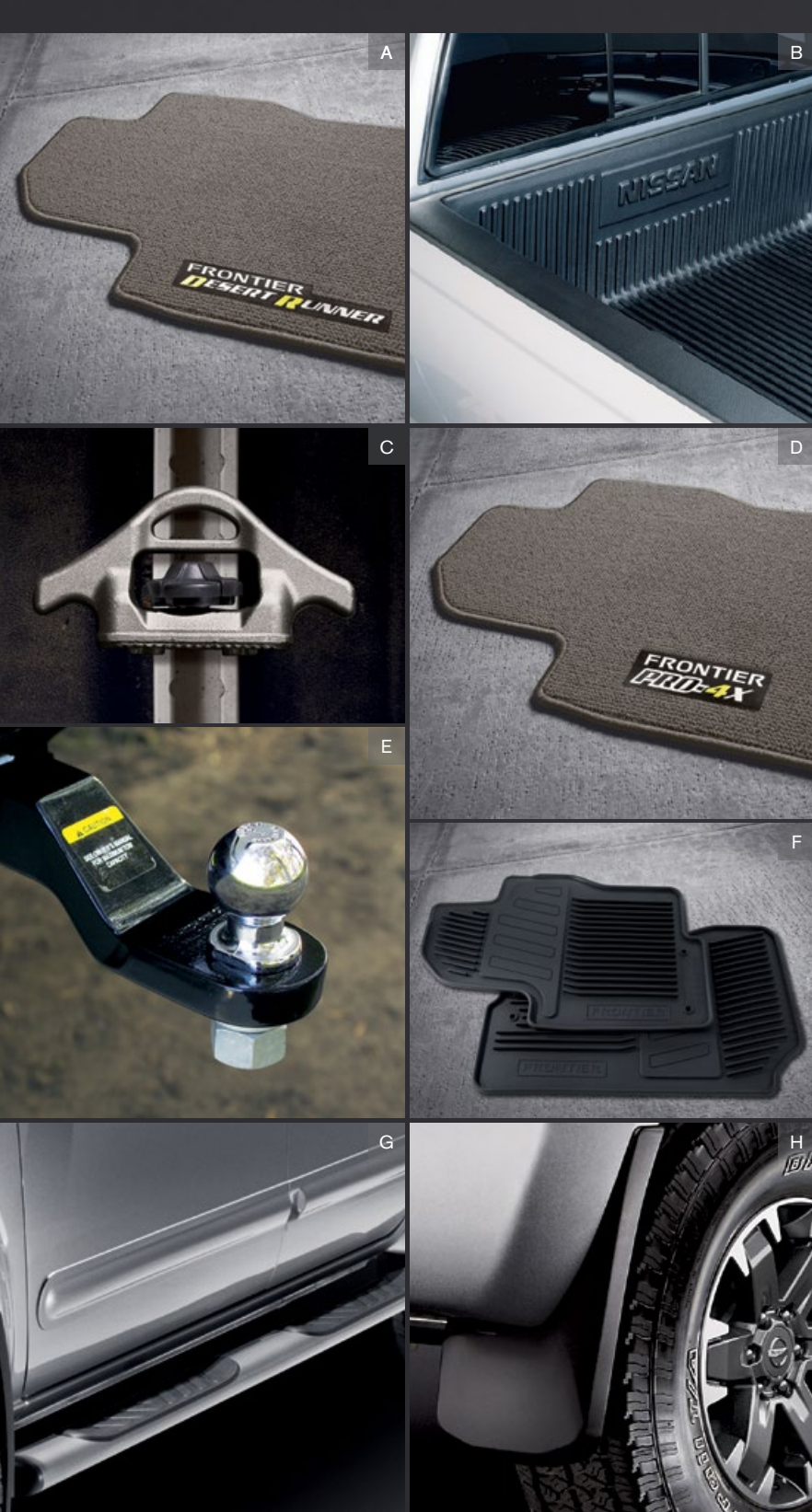

## GENUINE NISSAN ACCESSORIES.

Every Genuine Nissan Accessory is custom-fit, custom-designed and durability-tested. Each one is backed by Nissan's 3-year/36,000-mile (whichever occurs first) limited warranty (if installed by dealer at the time of purchase)<sup>1</sup>, and can be financed when installed by dealer at time of purchase.

- A. **Desert Runner<sup>®</sup> Carpeted Floor Mats**  
Shield your carpet and show your pride.
- B. **Bed Rail Caps<sup>2</sup>**  
Protect your bed rails from a battering.
- C. **Tie-down Cleat<sup>3</sup>**  
Make the most of your Utili-track<sup>®</sup> Channel System.
- D. **PRO-4X<sup>®</sup> Carpeted Floor Mats**  
It's the ultimate Frontier.<sup>®</sup> Treat it right.
- E. **Hitch Ball, Class III<sup>4</sup>**  
Ready for towing up to 5,000 lbs.
- F. **All-season Floor Mats**  
Don't let the muck mess up your truck.
- G. **Body Side Moldings and Step Rails**  
Protect your doors and get a lift (sold separately).
- H. **Splash Guards**  
Show that puddle who's boss.

# STEP UP YOUR GAME.

For more information and to shop online for Frontier<sup>®</sup> Genuine Nissan Accessories, go to [bit.ly/frontier\\_estore](http://bit.ly/frontier_estore)



Click the button to see short videos on Genuine Nissan Accessories in action, or go to [bit.ly/frontier\\_gnavideos](http://bit.ly/frontier_gnavideos)



<sup>1</sup>Genuine Nissan Accessories are covered by Nissan's Limited Warranty on Genuine Nissan Replacement Parts, Genuine NISMO<sup>®</sup> S-Tune Parts, and Genuine Nissan Accessories for the longer of 12 months/12,000 miles (whichever occurs first) or the remaining period under the 3-year/36,000-mile (whichever occurs first) Nissan New Vehicle Limited Warranty. Terms and conditions apply. See Warranty Information Booklet for details. <sup>2</sup>Image may not reflect actual product. <sup>3</sup>Cargo and load capacity limited by weight and distribution. Always secure all cargo. Heavy loading of the vehicle with cargo, especially on the roof, will affect the handling and stability of the vehicle. <sup>4</sup>See Nissan Towing Guide and Owner's Manual for proper use.



Nissan Frontier<sup>®</sup> PRO-4X<sup>®</sup> Crew Cab with PRO-4X<sup>®</sup> Luxury Package shown in Brilliant Silver with PRO-4X<sup>®</sup> Graphics Package, Fog Lights (standard on PRO-4X<sup>®</sup>), Tow Hook (standard on PRO-4X<sup>®</sup>), Splash Guards (standard on PRO-4X<sup>®</sup>), Hood Protector, and Side-window Deflectors.



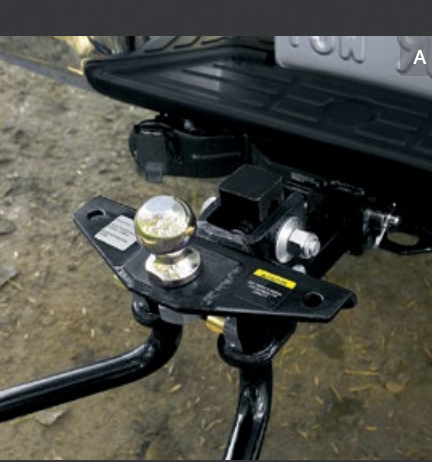

Along with the other hard-working accessories listed below, you'll find a full line of available accessories designed specifically to work with the available unique system of channels and cleats in Frontier's incredibly versatile Utili-track® system.<sup>1</sup>

**A. Weight-distributing Hitch Ball Mount, Class IV<sup>2,3</sup>**  
Tow big or go home.

**B. Sliding Bed Divider<sup>1</sup>**  
Divide and conquer. Works perfectly with Utili-track® system.

**C. Sliding Tool Box<sup>4</sup>**  
Slide it forward when you're on the move. Slide it back for easy access on the job.

**D. Non-sliding Tool Box**  
Like a treasure box for your tools.

**E. Bedliner<sup>3</sup>**  
Because your bed takes a beating.

**F. Tow Hook<sup>2</sup>**  
Extra strength for sticky situations.

**G. Bed Tent**  
It's your truck! It's your campsite! It's both!

**H. Sliding Bed Extender<sup>1</sup>**  
Ideal for the long haul.



Click the button to see short videos on Genuine Nissan Accessories in action, or go to [bit.ly/frontier\\_gnavideos](http://bit.ly/frontier_gnavideos)

<sup>1</sup>Cargo shown for display purposes only. Cargo and load capacity limited by weight and distribution. Always secure all cargo. Heavy loading of the vehicle with cargo, especially on the roof, will affect the handling and stability of the vehicle. <sup>2</sup>See Nissan Towing Guide and Owner's Manual for proper use. <sup>3</sup>Image may not reflect actual product. <sup>4</sup>Tool Box Tray shown in photo is sold separately. See your Nissan dealer for more information.



**Nissan Frontier® PRO-4X® Crew Cab** with PRO-4X® Luxury Package shown in Brilliant Silver with PRO-4X® Graphics Package, Sliding Bed Extender, Sliding Tool Box, Splash Guards (standard on PRO-4X®), and Side-window Deflectors.



## CHOOSE YOUR TRIM LEVEL

### S KING CAB\* CREW CAB

- 2.5-liter 4-cylinder engine
  - 5-speed manual transmission
  - 15" Steel wheels with 235/75R15 mud- and snow-rated all-season tires<sup>1</sup>
  - Active Brake Limited Slip (ABLS)
  - 4-wheel Anti-lock Braking System (ABS)
  - Full-length, fully boxed ladder frame
  - AM/FM/CD audio system<sup>2</sup>
  - Air conditioning<sup>2</sup>
  - Bluetooth® Hands-free Phone System<sup>2,3</sup>
  - Illuminated steering wheel-mounted audio controls<sup>2</sup>
  - Cruise control<sup>2</sup>
  - Rear access doors
  - Second-row under-seat storage
  - Vehicle Dynamic Control (VDC)
  - Tire Pressure Monitoring System (TPMS)
  - Six standard air bags
- Crew Cab adds:**
- 261-hp 4.0-liter DOHC 24-valve V6 engine
  - 6-speed manual transmission
  - Four full-size doors with seating for five
  - 16" Steel wheels with P265/70R16 mud- and snow-rated all-season tires



### SV 4-CYL. / V6 KING CAB\* CREW CAB CREW CAB LONG BED

- SV 4-cylinder includes S equipment plus:**
- 16" Aluminum-alloy wheels with P265/70R16 mud- and snow-rated all-season tires<sup>1</sup>
  - Body-color front bumper
  - Bed rail caps
  - NissanConnect™ with Mobile Apps
  - Hands-free text messaging assistant<sup>4</sup>
  - AM/FM/CD audio system with 5.0" color display
  - SiriusXM® Satellite Radio<sup>5</sup>
  - USB connection port for iPod® interface and other compatible devices
- SV V6 includes SV 4-cyl. equipment plus:**
- 4.0-liter DOHC 24-valve V6
  - 6-speed manual transmission
- Crew Cab adds:**
- Four full-size doors with seating for five

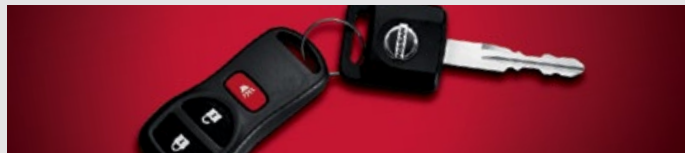

### DESERT RUNNER® KING CAB\* CREW CAB

- Includes SV 4-cyl. equipment plus:**
- 4.0-liter DOHC 24-valve V6
  - 5-speed automatic transmission
  - 16" Aluminum-alloy wheels
  - P265/75R16 mud- and snow-rated all-terrain tires<sup>1</sup>
  - Bilstein® off-road performance shocks
  - Fog lights and satin chrome grille
  - Body-color rear bumper
  - Multi-function trip computer
  - 8-way manual driver's seat
  - White-faced gauges
  - Frontier® embroidered cloth seat trim
- Crew Cab adds:**
- Four full-size doors with seating for five



### PRO-4X® KING CAB\* CREW CAB

- Includes SV V6 equipment plus:**
- Bilstein® off-road performance shocks
  - Electronic locking rear differential
  - Clutch start/cancel (MT only)
  - Skid plates
  - 16" Aluminum-alloy wheels
  - P265/75R16 mud- and snow-rated all-terrain tires<sup>1</sup>
  - Automatic on/off headlights and fog lights
  - Utili-track® Channel System
  - Factory-applied spray-on bedliner
  - Satin chrome grille and body-color rear bumper
  - PRO-4X® bedside decal
  - SiriusXM® Traffic and Travel Link<sup>5S</sup>
  - Nissan Navigation System with 5.8" color touch-screen monitor and voice recognition<sup>6</sup>
  - RearView Monitor and Rear Sonar System
  - Auto-dimming rearview mirror
  - Multi-function trip computer
  - Dual Zone Automatic Temp. Control
  - PRO-4X® embroidered cloth seat trim
  - 8-way manual driver's seat
  - Heated front seats
  - White-faced gauges
  - Leather-wrapped steering wheel
- Crew Cab adds:**
- Four full-size doors with seating for five
  - Rockford Fosgate®-powered audio system

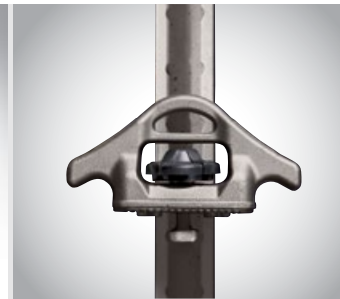

### SL CREW CAB CREW CAB LONG BED

- Includes SV V6 equipment plus:**
- 5-speed automatic transmission
  - 18" Aluminum-alloy wheels
  - P265/60R18 mud- and snow-rated all-season tires<sup>1</sup>
  - Automatic on/off headlights and fog lights
  - Utili-track® Channel System
  - Factory-applied spray-on bedliner
  - Chrome outside mirrors and door handles
  - Step rails and body side moldings
  - SiriusXM® Traffic and Travel Link<sup>5S</sup>
  - Nissan Navigation System with 5.8" color touch-screen monitor and voice recognition<sup>6</sup>
  - Rockford Fosgate®-powered audio system
  - RearView Monitor and Rear Sonar System
  - Dual Zone Automatic Temp. Control
  - Auto-dimming rearview mirror with HomeLink® Universal Transceiver
  - Leather-appointed seats
  - 8-way power adjustable driver's seat
  - 4-way power adjustable front-passenger's seat
  - Leather-wrapped steering wheel



#### KEY AVAILABLE PACKAGES:

- Preferred Package (S King Cab® with manual transmission only)
- Value Truck Package (SV V6 only)
- Luxury Package (PRO-4X® Crew Cab only)
- Moonroof Package (SL only)

<sup>1</sup>Image may not reflect actual product. <sup>2</sup>Standard on Frontier® S King Cab® with automatic transmission and Frontier® S Crew Cab models only. Available for Frontier® S King Cab® with manual transmission in the S Preferred Package. <sup>3</sup>Availability of specific features is dependent upon the phone's Bluetooth® support. Please refer to your phone Owner's Manual for details. Bluetooth® word mark and logos are owned by Bluetooth SIG, Inc., and any use of such marks by Nissan is under license. <sup>4</sup>Use the text messaging feature after stopping your vehicle in a safe location. If you have to use the feature while driving, exercise extreme caution at all times so full attention may be given to vehicle operation. Compatible smartphone required. Standard text rates and/or data usage may apply. <sup>5</sup>Required SiriusXM® Satellite Radio, SiriusXM® Traffic and Travel Link® subscriptions sold separately after trial period. Installation costs, one-time activation fee, other fees and taxes will apply. SiriusXM® Traffic available in select markets. Services available only to those 18 or older in the 48 contiguous states and D.C. Fees and programming subject to change. Subscriptions governed by Customer Agreement available at [siriusxm.com](http://siriusxm.com). ©2014 Sirius XM Radio Inc. Sirius® XM® and all related marks and logos are trademarks of Sirius XM Radio Inc. <sup>6</sup>Never program while driving. GPS mapping may not be detailed in all areas or reflect current road status. <sup>7</sup>Driving is serious business. Only use NissanConnect™ services when safe to do so. Subscription Agreement required. Compatible smartphone required. Not all app features are available for all models. Some apps have late availability. May require dealer service visit or software upgrade to activate. Never program while driving. GPS mapping may not be detailed in all areas or reflect current road status. Cellular network not available in all areas. Cellular network, apps, and services, including Google® services, are provided by independent companies not within Nissan's control and may require subscription and owner consent to activate. Should provider terminate/restrict service, service may be terminated without notice or liability to Nissan and/or its agents. Nissan not responsible for any equipment or app replacement/upgrades, or associated costs, that may be required for continued operation. Terms and conditions of Subscription Agreement apply. 36-month trial period starts on vehicle sale date; subsequently a paid subscription is required at the then current rate (excludes Pandora®). Standard text rates and/or data usage may apply. See retailer and check [www.NissanUSA.com/connect](http://www.NissanUSA.com/connect) for details. Bilstein® is a registered trademark of ThyssenKrupp Bilstein GmbH. HomeLink® is a registered trademark of Johnson Controls Technology Company. iPod® is a registered trademark of Apple, Inc. All rights reserved. iPod® not included. Rockford Fosgate® is a registered trademark of Rockford Corporation.



# CHOOSE YOUR COLOR

You've decided which Frontier® you want, now here comes the best part: deciding what it's going to look like. Choose your favorite color and then pick from the available interiors based on the model of your choice.

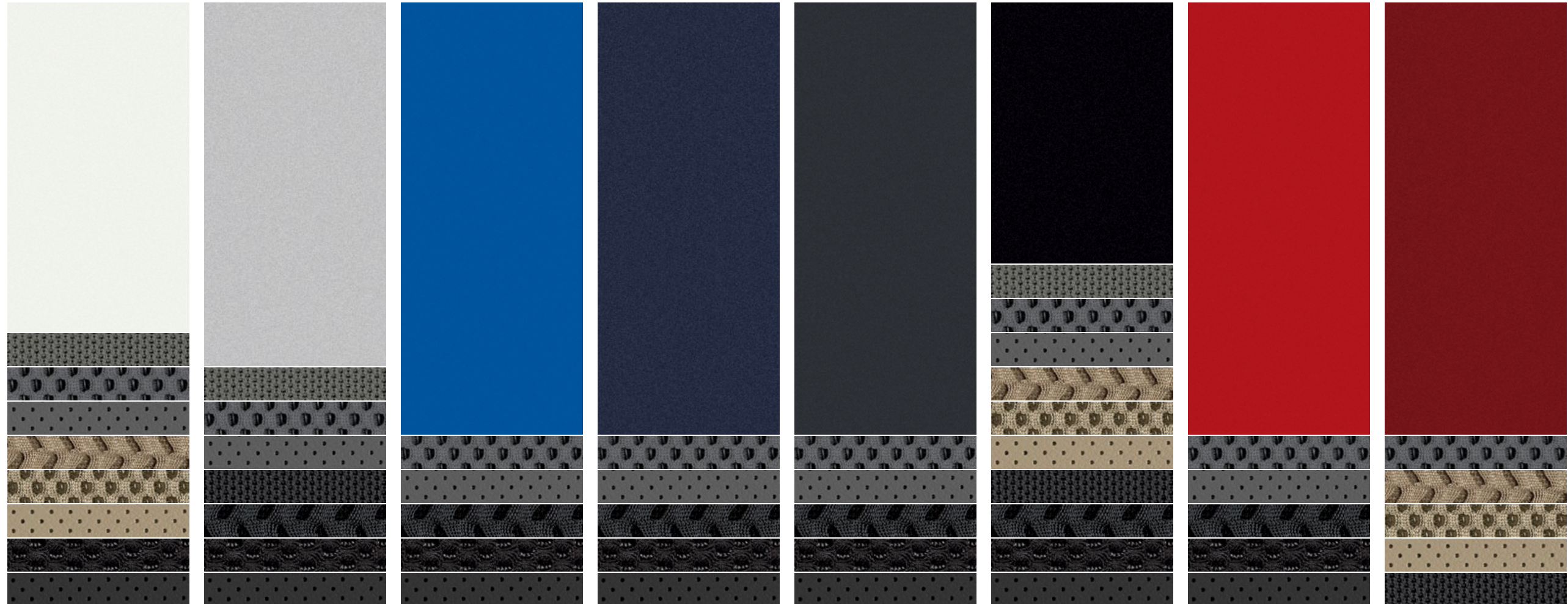

Glacier White QAK

Brilliant Silver K23

Metallic Blue B17

Arctic Blue Metallic RBG

Night Armor K26

Super Black KH3

Lava Red EAF

Cayenne Red NAH

■ Standard  
 □ Part of PRO-4X® Luxury Package

Nissan has taken care to ensure that the color swatches presented here are the closest possible representations of actual vehicle colors. Swatches may vary slightly due to viewing light or screen quality. Please see the actual colors at your local Nissan dealer.

	S	SV	DESERT RUNNER®	PRO-4X®	SL
STEEL CLOTH	■	■ <sup>1</sup>			
STEEL LEATHER					■
BEIGE CLOTH		■			
BEIGE LEATHER					■
GRAPHITE CLOTH					■
GRAPHITE STEEL CLOTH			■	■	
GRAPHITE LEATHER				□ <sup>1</sup>	

	S	SV	DESERT RUNNER®	PRO-4X®	SL
STEEL CLOTH	■	■ <sup>1</sup>			
STEEL LEATHER					■
BEIGE CLOTH		■			
BEIGE LEATHER					■
GRAPHITE CLOTH					■
GRAPHITE STEEL CLOTH			■	■	
GRAPHITE LEATHER				□ <sup>1</sup>	

	S	SV	DESERT RUNNER®	PRO-4X®	SL
STEEL CLOTH			■ <sup>1</sup>		
STEEL LEATHER					■
BEIGE CLOTH					
BEIGE LEATHER					■
GRAPHITE CLOTH					■
GRAPHITE STEEL CLOTH			■	■	
GRAPHITE LEATHER				□ <sup>1</sup>	

	S	SV	DESERT RUNNER®	PRO-4X®	SL
STEEL CLOTH			■ <sup>1</sup>		
STEEL LEATHER					■
BEIGE CLOTH					
BEIGE LEATHER					■
GRAPHITE CLOTH					■
GRAPHITE STEEL CLOTH			■	■	
GRAPHITE LEATHER				□ <sup>1</sup>	

	S	SV	DESERT RUNNER®	PRO-4X®	SL
STEEL CLOTH			■ <sup>1</sup>		
STEEL LEATHER					■
BEIGE CLOTH					
BEIGE LEATHER					■
GRAPHITE CLOTH					■
GRAPHITE STEEL CLOTH			■	■	
GRAPHITE LEATHER				□ <sup>1</sup>	

	S	SV	DESERT RUNNER®	PRO-4X®	SL
STEEL CLOTH			■ <sup>1</sup>		
STEEL LEATHER					■
BEIGE CLOTH					
BEIGE LEATHER					■
GRAPHITE CLOTH					■
GRAPHITE STEEL CLOTH			■	■	
GRAPHITE LEATHER				□ <sup>1</sup>	

	S	SV	DESERT RUNNER®	PRO-4X®	SL
STEEL CLOTH			■ <sup>1</sup>		
STEEL LEATHER					■
BEIGE CLOTH					
BEIGE LEATHER					■
GRAPHITE CLOTH					■
GRAPHITE STEEL CLOTH			■	■	
GRAPHITE LEATHER				□ <sup>1</sup>	

	S	SV	DESERT RUNNER®	PRO-4X®	SL
STEEL CLOTH			■ <sup>1</sup>		
STEEL LEATHER					■
BEIGE CLOTH					
BEIGE LEATHER					■
GRAPHITE CLOTH					■
GRAPHITE STEEL CLOTH			■	■	
GRAPHITE LEATHER				□ <sup>1</sup>	



<sup>1</sup>Crew Cab only. <sup>2</sup>King Cab® only.



CHOOSE YOUR FABRIC



STEEL  
CLOTH  
S King Cab®



BEIGE  
CLOTH  
SV King Cab®



BEIGE  
CLOTH  
SV Crew Cab



GRAPHITE STEEL  
CLOTH  
Desert Runner® / PRO-4X® models



BEIGE  
LEATHER  
SL Crew Cab



GRAPHITE  
CLOTH  
S King Cab



GRAPHITE  
CLOTH  
SV King Cab®



STEEL  
CLOTH  
S Crew Cab / SV Crew Cab



GRAPHITE  
LEATHER  
PRO-4X® Crew Cab



STEEL  
LEATHER  
SL Crew Cab



# SPECIFICATIONS

Engine	S KC/CC 4x2/4x4	SV KC 4x2	SV V6 KC/CC 4x2/4x4	DR KC/CC 4x2	PRO-4X <sup>®</sup> KC/CC 4x4	SL CC 4x2/4x4
<b>QR25DE – 2.5-liter DOHC 16-valve 4-cylinder</b>	<sup>1</sup>					
— Horsepower – 152 hp @ 5,200 rpm						
— Torque – 171 lb-ft @ 4,400 rpm						
<b>VQ40DE – 4.0-liter DOHC 24-valve V6</b>	<sup>2</sup>					
— Horsepower – 261 hp @ 5,600 rpm						
— Torque – 281 lb-ft @ 4,000 rpm						
Emissions – Tier 2, Bin 5 (Fed); — LEV2 – ULEV (CA)						
Continuously Variable Valve Timing — Control System (CVTCS) on intake valves						
Variable Intake System						
Nissan Direct Ignition System with — platinum-tipped spark plugs						
Electronic drive-by-wire throttle						

Drivetrain	S KC/CC 4x2/4x4	SV KC 4x2	SV V6 KC/CC 4x2/4x4	DR KC/CC 4x2	PRO-4X <sup>®</sup> KC/CC 4x4	SL CC 4x2/4x4
5-speed manual transmission	<sup>1</sup>					
6-speed manual transmission	<sup>2</sup>					
5-speed automatic transmission	<input type="checkbox"/>	<input type="checkbox"/>	<input type="checkbox"/>		<input type="checkbox"/>	
Dana <sup>®</sup> 44 rear axle	<sup>2, 3</sup>		<sup>3</sup>			
Switch-operated 2-speed transfer case — (4x4 models only)	<sup>2</sup>					
Electronic locking rear differential						
Clutch start/cancel <sup>3</sup>						
Hill descent control – 4x4 only <sup>4</sup>	<sup>2</sup>					
Hill start assist – 4x4 only <sup>4</sup>	<sup>2</sup>					

Brakes	S KC/CC 4x2/4x4	SV KC 4x2	SV V6 KC/CC 4x2/4x4	DR KC/CC 4x2	PRO-4X <sup>®</sup> KC/CC 4x4	SL CC 4x2/4x4
4-wheel vented disc brakes						
4-wheel Anti-lock Braking System (ABS)						
Electronic Brake force Distribution (EBD)						

Suspension/Steering	S KC/CC 4x2/4x4	SV KC 4x2	SV V6 KC/CC 4x2/4x4	DR KC/CC 4x2	PRO-4X <sup>®</sup> KC/CC 4x4	SL CC 4x2/4x4
Independent double-wishbone front suspension						
Overslung multi-leaf rear suspension with solid axle						

- Standard
- Optional
- Part of S Preferred Package
- Part of SV V6 Value Truck Package
- Part of PRO-4X<sup>®</sup> Luxury Package
- Part of SL Moonroof Package

Suspension/Steering (continued)	S KC/CC 4x2/4x4	SV KC 4x2	SV V6 KC/CC 4x2/4x4	DR KC/CC 4x2	PRO-4X <sup>®</sup> KC/CC 4x4	SL CC 4x2/4x4
Bilstein <sup>®</sup> off-road performance shock absorbers						
Front stabilizer bar						
Engine-speed-sensitive power steering						

Wheels/Tires	S KC/CC 4x2/4x4	SV KC 4x2	SV V6 KC/CC 4x2/4x4	DR KC/CC 4x2	PRO-4X <sup>®</sup> KC/CC 4x4	SL CC 4x2/4x4
15" x 7" 6-spoke steel wheels	<sup>1</sup>					
16" x 7" 6-spoke steel wheels	<sup>2</sup>					
16" x 7" 6-split spoke aluminum-alloy wheels						
16" x 7" 6-spoke aluminum-alloy wheels						
18" x 7.5" 6-spoke aluminum-alloy wheels						
235/75R15 mud- and snow-rated all-season tires	<sup>1</sup>					
P265/70R16 mud- and snow-rated all-season tires	<sup>2</sup>					
P265/75R16 mud- and snow-rated all-terrain tires						
P265/60R18 mud- and snow-rated all-season tires						
Full-size spare tire						

Exterior Features	S KC/CC 4x2/4x4	SV KC 4x2	SV V6 KC/CC 4x2/4x4	DR KC/CC 4x2	PRO-4X <sup>®</sup> KC/CC 4x4	SL CC 4x2/4x4
Skid plates (oil pan, fuel tank, 4x4 transfer case)						
Automatic on/off headlights						
Fog lights						
Roof rack with crossbars						
Step rails						
Body-color side moldings						
Front tow hook – 4x4 only	<sup>2</sup>					
Splash guards						
Chrome grille						
Satin chrome grille						
Upper body-color/lower black front bumper — and chrome rear bumper						
Body-color front bumper and chrome rear bumper						
Body-color front and rear bumpers						
Chrome front and rear bumpers						
Black door handles and outside mirrors						
Body-color door handles and outside mirrors						
Chrome door handles and outside mirrors						
Dual power outside mirrors						
Heated outside mirrors						

Exterior Features (continued)	S KC/CC 4x2/4x4	SV KC 4x2	SV V6 KC/CC 4x2/4x4	DR KC/CC 4x2	PRO-4X <sup>®</sup> KC/CC 4x4	SL CC 4x2/4x4
Power sliding glass moonroof						
Sliding rear window						
Rear privacy glass						
Rear Sonar System						
Tow hitch receiver, Class IV <sup>5</sup>						
Long Bed						
Utili-track <sup>®</sup> Channel System with 4 tie-down cleats						
Factory-applied spray-on bedliner						
Locking tailgate and cargo bed light						
Tailgate spoiler						
Bed rail caps						
Sliding bed extender						

Comfort/Convenience	S KC/CC 4x2/4x4	SV KC 4x2	SV V6 KC/CC 4x2/4x4	DR KC/CC 4x2	PRO-4X <sup>®</sup> KC/CC 4x4	SL CC 4x2/4x4
Nissan Navigation System with 5.8" color touch-screen — monitor and voice recognition						
NissanConnect <sup>SM</sup> with Mobile Apps						
SiriusXM <sup>®</sup> Traffic and Travel Link <sup>6</sup>						
RearView Monitor						
Bluetooth <sup>®</sup> Hands-free Phone System <sup>7</sup>						
Hands-free text messaging assistant <sup>9</sup>						
Air conditioning						
Dual Zone Automatic Temperature Control (ATC)						
In-cabin microfilter						
Power door locks, remote keyless entry, and windows — with driver's window one-touch auto-down						
HomeLink <sup>®</sup> Universal Transceiver						
Cruise control						
Variable intermittent windshield wipers						
Auto-dimming rearview mirror, digital compass and — outside temperature display						
Front map lights						
Three 12-volt DC power outlets (two on S)						
Multi-function trip computer						
Voltage and oil pressure gauges						
Sun visors with vanity mirrors and extension						
Sun visors with illuminated vanity mirrors and extension						



<sup>1</sup>King Cab<sup>®</sup> only. <sup>2</sup>Crew Cab only. <sup>3</sup>Manual transmission only. <sup>4</sup>Automatic transmission only. <sup>5</sup>Subject to vehicle tow/payload capacity. See Nissan Towing Guide and Owner's Manual for proper use. <sup>6</sup>Required SiriusXM<sup>®</sup> Satellite Radio, SiriusXM<sup>®</sup> Traffic and Travel Link<sup>®</sup> are subscriptions sold separately after trial period. Installation costs, one-time activation fee, other fees and taxes will apply. SiriusXM<sup>®</sup> Traffic available in select markets. Services available only to those 18 or older in the 48 contiguous states and D.C. Fees and programming subject to change. Subscriptions governed by Customer Agreement available at [siriusxm.com](http://siriusxm.com). ©2014 Sirius XM Radio Inc. Sirius<sup>®</sup> XM<sup>®</sup> and all related marks and logos are trademarks of Sirius XM Radio Inc. <sup>7</sup>Availability of specific features is dependent upon the phone's Bluetooth<sup>®</sup> support. Please refer to your phone Owner's Manual for details. Bluetooth<sup>®</sup> word mark and logos are owned by Bluetooth SIG, Inc., and any use of such marks by Nissan is under license. <sup>8</sup>Standard on Frontier<sup>®</sup> S King Cab<sup>®</sup> with automatic transmission and Frontier<sup>®</sup> S Crew Cab models. <sup>9</sup>Use the text messaging feature after stopping your vehicle in a safe location. If you have to use the feature while driving, exercise extreme caution at all times so full attention may be given to vehicle operation. Compatible smartphone required. Standard text rates and/or data usage may apply. <sup>10</sup>31.5° on Desert Runner.<sup>11</sup> 32.6° on PRO-4X.<sup>12</sup> 22.6° on Desert Runner.<sup>13</sup> 23.3° on PRO-4X.<sup>14</sup> 7-pin connector trailer wire harness and tow hitch receiver required, both sold separately. Bilstein<sup>®</sup> is a registered trademark of ThyssenKrupp Bilstein GmbH. Dana<sup>®</sup> is a registered trademark of Dana Corporation. HomeLink<sup>®</sup> is a registered trademark of Johnson Controls Technology Company. iPod<sup>®</sup> is a registered trademark of Apple, Inc. All rights reserved. iPod<sup>®</sup> not included. Rockford Fosgate<sup>®</sup> is a registered trademark of Rockford Corporation.



SPECIFICATIONS (CONTINUED)

Comfort/Convenience (continued)	S KC/CC 4x2/4x4	SV KC 4x2	SV V6 KC/CC 4x2/4x4	DR KC/CC 4x2	PRO-4X <sup>®</sup> KC/CC 4x4	SL CC 4x2/4x4
Tilt steering column	2					
Second-row under-seat storage						
Eight beverage holders and door storage pockets						
Overhead console with sunglasses storage	P <sup>8</sup>					
Driver's seatback pocket	2		2	2		
First aid kit						

Seating/Appointments	S KC/CC 4x2/4x4	SV KC 4x2	SV V6 KC/CC 4x2/4x4	DR KC/CC 4x2	PRO-4X <sup>®</sup> KC/CC 4x4	SL CC 4x2/4x4
4-way manual driver's seat						
8-way manual driver's seat						
8-way power adjustable driver's seat					L	
4-way manual front-passenger's seat						
4-way power adjustable front-passenger's seat					L	
Driver's seat adjustable lumbar support						
Forward-facing rear flip-up seat	1		1	1	1	
60/40 Split flip-up rear bench seat	2		2	2	2	
Rear fold-down center armrest					L	
Cloth seat trim						
Frontier <sup>®</sup> embroidered cloth seat trim						
PRO-4X <sup>®</sup> embroidered cloth seat trim						
PRO-4X <sup>®</sup> embroidered leather-appointed seats					L	
Leather-appointed seats						
White contrast interior stitching						
Heated front seats			VT			
Leather-wrapped steering wheel						
Chrome vent accents						
White-faced gauges with satin chrome bezels						
Carpeted floor mats			VT			

Audio/Entertainment	S KC/CC 4x2/4x4	SV KC 4x2	SV V6 KC/CC 4x2/4x4	DR KC/CC 4x2	PRO-4X <sup>®</sup> KC/CC 4x4	SL CC 4x2/4x4
AM/FM/CD audio system	P <sup>8</sup>					
AM/FM/CD audio system with 5.0" color display						
Rockford Fosgate <sup>®</sup> -powered audio system					2	
Illuminated steering wheel-mounted audio controls	P <sup>8</sup>					
MP3/WMA CD playback capability	P <sup>8</sup>					

Audio/Entertainment (continued)	S KC/CC 4x2/4x4	SV KC 4x2	SV V6 KC/CC 4x2/4x4	DR KC/CC 4x2	PRO-4X <sup>®</sup> KC/CC 4x4	SL CC 4x2/4x4
Radio Data System (RDS)	P <sup>8</sup>					
Four speakers	1					
Six speakers	2		VT <sup>1</sup>	2		
Ten speakers, including subwoofers					2	
Auxiliary audio input jack	P <sup>8</sup>					
USB connection port for iPod <sup>®</sup> interface and other compatible devices						
SiriusXM <sup>®</sup> Satellite Radio <sup>6</sup>						
Streaming audio via Bluetooth <sup>®</sup> wireless technology <sup>7</sup>						

Safety/Security	S KC/CC 4x2/4x4	SV KC 4x2	SV V6 KC/CC 4x2/4x4	DR KC/CC 4x2	PRO-4X <sup>®</sup> KC/CC 4x4	SL CC 4x2/4x4
Nissan Advanced Air Bag System with dual-stage supplemental front air bags with seat belt and occupant-classification sensors						
Driver and front passenger seat-mounted side-impact supplemental air bags						
Roof-mounted curtain supplemental air bags for side-impact and rollover head protection for outboard occupants						
Vehicle Dynamic Control (VDC) with Traction Control System (TCS)						
Active Brake Limited Slip (ABLS)						
3-point ALR/ELR passenger seat belt system (ELR for driver)						
Front-seat Active Head Restraints						
Front seat belts with pretensioners and load limiters						
LATCH System (Lower Anchors and Tethers for CHildren)						
Zone Body construction with front and rear crumple zones						
Hood-buckling creases and energy-absorbing steering column						
Pipe-style steel side-door guard beams						
Tire Pressure Monitoring System (TPMS)						
Nissan Vehicle Immobilizer System						
Vehicle Security System			VT			

PACKAGES

P S Preferred Package (King Cab <sup>®</sup> Manual Transmission Only)
AM/FM/CD audio system with Radio Data System and MP3/WMA CD playback capability
Auxiliary audio input jack
Air conditioning
Bluetooth <sup>®</sup> Hands-free Phone System <sup>7</sup>
Cruise control and illuminated steering wheel-mounted audio controls
Front map lights and overhead compartment with sunglasses storage

VT SV V6 Value Truck Package
RearView Monitor and Rear Sonar System
Dual Zone Automatic Temperature Control (ATC)
Six speakers (King Cab <sup>®</sup> only)
Auto-dimming rearview mirror, digital compass, and outside temperature display
Factory-applied spray-on bedliner
Utili-track <sup>®</sup> Channel System with 4 tie-down cleats
Fog lights
Vehicle Security System
Heated front seats, carpeted floor mats, and in-cabin microfilter
Sliding bed extender
Tow hitch receiver, Class IV <sup>5</sup>

L PRO-4X <sup>®</sup> Luxury Package (Crew Cab Only)
PRO-4X <sup>®</sup> embroidered leather-appointed seats
8-way power adjustable driver's seat
4-way power adjustable front-passenger's seat
Heated outside mirrors
Rear fold-down center armrest
Power sliding glass moonroof
Roof rack with crossbars

M SL Moonroof Package
Power sliding glass moonroof
This package is standard on Long Bed models.





DIMENSIONS/CAPACITIES/WEIGHTS/MPG

**Dimensions – Inches**

Exterior	King Cab®	Crew Cab Standard/Long Bed
Wheelbase	125.9	125.9/139.9
Overall length	205.5	205.5/219.4
Overall width	72.8	72.8
Overall height	68.7 – 69.7	70.1 – 73.9
Track width	61.8	61.8
Bed length	73.3	59.5/73.3
Bed width	61.4	61.4
Bed height	18.0	18.0

Vehicle clearance	King Cab®	Crew Cab
Ground clearance at rear differential	8.7" – 10.1"	9.8" – 10.1"
Angle of approach; V6 models	– 4x2 30.5° <sup>10</sup> – 4x4 31.5° <sup>11</sup>	30.5° <sup>10</sup> 31.5° <sup>11</sup>
Angle of departure; V6 models	– 4x2 22.1° <sup>12</sup> – 4x4 22.6° <sup>13</sup>	22.1° <sup>12</sup> 22.6° <sup>13</sup>
Break-over angle; V6 models	19.5° – 20.6°	19.5° – 20.6°

Interior – Inches (front/rear)	King Cab®	Crew Cab
Head room without moonroof	39.7/38.3	40.0/38.7
Leg room	42.4/25.4	42.4/33.6
Hip room	55.8/55.0	55.6/58.0
Shoulder room	58.3/54.9	58.3/58.3

**Maximum Payload – Lbs.**

4-cylinder	S	SV
<b>King Cab® – 4x2</b>		
Manual transmission	953	928
Automatic transmission	913	916

V6	S	SV	DESERT RUNNER®	PRO-4X®	SL
<b>King Cab® – 4x2</b>					
Manual transmission	–	1,471	–	–	–
Automatic transmission	–	1,449	1,435	–	–

King Cab® – 4x4	S	SV	DESERT RUNNER®	PRO-4X®	SL
Manual transmission	–	1,303	–	1,210	–
Automatic transmission	–	1,381	–	1,194	–

**Dimensions – Inches**

V6	S	SV	DESERT RUNNER®	PRO-4X®	SL
<b>Crew Cab – 4x2</b>					
Manual transmission	1,434	1,344	–	–	–
Automatic transmission	1,458	1,458	1,321	–	1,195

Crew Cab – 4x4	S	SV	DESERT RUNNER®	PRO-4X®	SL
Manual transmission	1,227	1,156	–	1,064	–
Automatic transmission	1,362	1,378	–	1,049	1,236

Crew Cab Long Bed – 4x2	S	SV	DESERT RUNNER®	PRO-4X®	SL
Automatic transmission	–	1,290	–	–	1,195

Crew Cab Long Bed – 4x4	S	SV	DESERT RUNNER®	PRO-4X®	SL
Automatic transmission	–	1,160	–	–	1,104

**Maximum Towing – Lbs.<sup>14</sup>**

	King Cab®	Crew Cab
4-cylinder – 4x2	3,500	–
V6 – 4x2 (4x4)	6,500 (6,300)	6,300 (6,100)

**Capacities**

	King Cab®	Crew Cab
Seating capacity	4	5
Interior passenger volume (cu. ft.)	87.7	101.1
Fuel tank (gals.)	21.1	21.1

**Curb Weights – Lbs.**

4-cylinder	S	SV
<b>King Cab® – 4x2</b>		
Manual transmission	3,699	3,751
Automatic transmission	3,753	3,763

V6	S	SV	DESERT RUNNER®	PRO-4X®	SL
<b>King Cab® – 4x2</b>					
Manual transmission	–	4,210	–	–	–
Automatic transmission	–	4,132	4,156	–	–

**Curb Weights – Lbs. (continued)**

V6	S	SV	DESERT RUNNER®	PRO-4X®	SL
<b>King Cab® – 4x4</b>					
Manual transmission	–	4,379	–	4,382	–
Automatic transmission	–	4,301	–	4,398	–

Crew Cab – 4x2	S	SV	DESERT RUNNER®	PRO-4X®	SL
Manual transmission	4,248	4,320	–	–	–
Automatic transmission	4,263	4,247	4,270	–	4,411

Crew Cab – 4x4	S	SV	DESERT RUNNER®	PRO-4X®	SL
Manual transmission	4,430	4,502	–	4,526	–
Automatic transmission	4,446	4,429	–	4,542	4,579

Crew Cab Long Bed – 4x2	S	SV	DESERT RUNNER®	PRO-4X®	SL
Automatic transmission	–	4,379	–	–	4,534

Crew Cab Long Bed – 4x4	S	SV	DESERT RUNNER®	PRO-4X®	SL
Automatic transmission	–	4,555	–	–	4,711

**2015 EPA Fuel Economy Estimates**

City/Hwy/Combined	4-cylinder	V6
Manual transmission – 4x2 (4x4)	19/23/21 (N/A)	17/22/19 (16/21/18)
Automatic transmission – 4x2 (4x4)	17/23/19 (N/A)	16/22/18 (15/21/17)

Actual mileage may vary with driving conditions – use for comparison only. N/A – Not applicable.

**King Cab®**

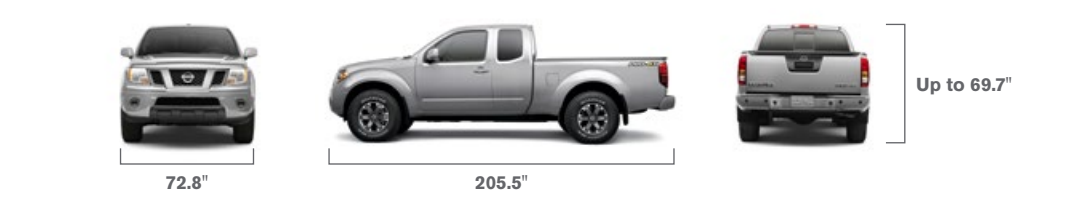

**Crew Cab**





## BUYING/OWNING



**Nissan Motor Acceptance Corporation.** Whether you're buying or leasing, you'll find attractive rates and flexible terms to make your purchase more accessible.

**College Grad Program.** Ask about our special new vehicle pricing available to individuals up to two years after graduation.

**Active and Reserve US Military Program.** Ask about eligibility for our fixed discount on new vehicle pricing available to those serving our country.

**New Vehicle Limited Warranties.** Protection for your new Nissan includes 3-year/36,000-mile (whichever occurs first) basic coverage and 5-year/60,000-mile (whichever occurs first) powertrain coverage. Terms, conditions, and exclusions apply. See Warranty Information Booklet for complete details.

**Security+Plus.\*** For additional peace of mind, a variety of extended service plans lets you tailor the coverage to your driving habits.

**Maintenance+Plus.\*** This extended plan ensures your Nissan will receive up to 17 different services and over 33 different inspection items at each visit, using the most up-to-date diagnostic equipment available.

**Genuine Nissan Parts.** When it comes time for service, any necessary replacement parts will be made using Genuine Nissan new or remanufactured parts, or Nissan-approved parts. And they're the only parts to carry Nissan's factory-backed limited warranty.

**Nissan Mobility Assist.** This program offers reimbursements toward the purchase and installation of certain mobility assistance products for program-eligible Nissans. Go to [NissanUSA.com/mobility](http://NissanUSA.com/mobility) for more info.

Nissan's environmental action plan focuses on several key areas. Increasing production of Zero Emission vehicles, including the 100% electric LEAF.<sup>®</sup> Improving fuel efficiency through our PUREDRIVE™ measures. And reducing the environmental impact of manufacturing, as seen at our energy-efficient, low-emissions paint plant in Tennessee. For more information, log on to [NissanUSA.com/green](http://NissanUSA.com/green)



At [NissanUSA.com](http://NissanUSA.com), you'll find virtual product demonstrations, a way to "build your own Nissan," a dealer locator, and more information about key Nissan support services. Or if you'd prefer, call **1-800-NISSAN-3** for answers to specific questions about Frontier<sup>®</sup> or any other Nissan vehicle. The Nissan names, logos, product names, feature names, and slogans are trademarks owned by or licensed to Nissan Motor Co. Ltd. and/or its North American subsidiaries. **Tread Lightly!<sup>®</sup> Please. Always wear your seat belt, and please don't drink and drive.** ©2014 Nissan North America, Inc.

This brochure is intended for general descriptive and informational purposes only. It is subject to change and does not constitute an offer, representation or warranty (express or implied) by Nissan North America, Inc. Interested parties should confirm the accuracy of any information in this brochure as it relates to a vehicle directly with Nissan North America, Inc., before relying on it to make a purchase decision. Nissan North America, Inc., reserves the right to make changes, at any time, without prior notice, in prices, colors, materials, equipment, specifications, and models and to discontinue models or equipment. Due to continuous product development and other pre- and post-production factors, actual vehicle, materials and specifications may vary from this brochure. Some vehicles shown with optional equipment. See the actual vehicle for complete accuracy. Availability and delivery times for particular models or equipment may vary. Specifications, options and accessories may differ in Hawaii, U.S. territories and other countries. For additional information on availability, options or accessories, see your Nissan dealer or contact Nissan North America, Inc.



Sign up for the latest news and updates on the 2015 Nissan Frontier.<sup>®</sup>

or visit [NissanUSA.com/frontier](http://NissanUSA.com/frontier)

Los folletos de Nissan también están disponibles en español.

Para descargar el PDF, visita:

[NissanUSA.com/folletos-espanol](http://NissanUSA.com/folletos-espanol)

And follow Nissan on:



Facebook<sup>®</sup> is a registered trademark of Facebook, Inc. Twitter<sup>®</sup> is a registered trademark of Twitter, Inc. YouTube<sup>®</sup> is a registered trademark of Google Inc.