

2017 CAN-AM SPYDER



RIDING GEAR, ACCESSORIES & GENUINE PARTS

CANAMSPYDER.COM

# SPYDER®



**ski-doo LYNX SEA-DOO EVINRUDE ROTAX Can-am**

219201177 - US



2017 RIDING GEAR,  
ACCESSORIES  
& GENUINE PARTS

**can-am** 



# IT'S TIME TO GET IN THE SPYDER LANE.

Inspiration, imagination, and all that's possible - they're what drive us. Our Can-Am Spyder is proof that we never sit still, and our accessories, riding gear, and sportswear speak volumes about our commitment to endlessly enhancing the experience for all. And it all starts here... more than 120 pages filled with ideas and possibilities.

We've gone farther to include everyone who wakes up mornings hoping to climb aboard their Can-Am Spyder. We're always listening to the countless Can-Am Spyder enthusiasts who help power our innovation, inspiring us to create newer, more compelling products.

Designed for men and women alike, we've got something for every rider geared towards whatever destination you call your own. If it's comfort and fashion you're looking for, or simply want the ultimate in fit, function, style or performance it's all here. Easy to understand, and easier than ever to love.

Add our exclusive 4U Guide to complete accessory customization and it's clear: this is going to be an unforgettable year of exploration and exhilaration.

This is the place where you begin to make our Can-Am Spyder yours. We may build it, but it's fueled by your imagination.

Welcome to the all-new, all yours, ultra-enhanced Can-Am Spyder experience.

Visit us online at [store.spyder.brp.com](https://store.spyder.brp.com) or visit your preferred dealer and start enhancing your Can-Am Spyder experience.

<b>RIDING GEAR</b>	<b>2</b>	<b>SPYDER F3 ACCESSORIES</b>	
Men's & Ladies' Jackets	4	UFit System	58
Jackets Technology	12	U-FIT	59
Jackets - Regular Size	14	Handlebars	59
Jackets - Plus Size	17	Brake & Shifter Linkages	60
Rain Gear	20	Footboards	61
Technical Wear	21	U-FUNCTION	62
Helmets & Accessories	22	Seats & Backrests	62
Communication Systems	28	Windshields & Wind Protection	64
Footwear	30	Cargo & Storage	66
Protective Guards	30	Lights & Electrical Accessories	71
Bags	31	U-STYLE	73
Gloves	32	Wheels	73
		Fenders	74
<b>SPORTSWEAR</b>	<b>34</b>	Custom Accessories	75
Mens'	40	Decals	76
Ladies'	42	U-PERFORMANCE	77
Go Fas Racing Team	44	Shocks	77
		Silencers	79
<b>BRP LIMITED WARRANTY</b>	<b>46</b>		
<b>SIZING CHART</b>	<b>47</b>	<b>SPYDER RT ACCESSORIES</b>	
		U-FIT	84
<b>ACCESSORIES</b>	<b>48</b>	Handlebars	84
4U Guide	50	U-FUNCTION	85
		Seats & Backrests	85
<b>CUSTOMIZED VEHICLES</b>		Windshields & Wind Protection	86
F3-S	54	Cargo & Storage	88
F3-S	55	Lights & Electrical Accessories	90
F3-T	56	U-STYLE	92
F3 Limited	57	Wheels	92
RT-S	82		
RT Limited	83		
		<b>Fenders</b>	<b>93</b>
		Custom Accessories	94
		U-PERFORMANCE	96
		Shocks & Silencers	96
		<b>SPYDER RS &amp; ST ACCESSORIES</b>	
		U-FUNCTION	99
		Seats & Backrests	99
		Windshields & Wind Protection	99
		Cargo & Storage	101
		Lights & Electrical Accessories	102
		U-STYLE	104
		Wheels	104
		Fenders	106
		Custom Accessories	107
		U-PERFORMANCE	108
		Shocks	108
		Silencers	109
		<b>CAN-AM FREEDOM TRAILER</b>	
		Can-Am Freedom Trailer	110
		Trailer Accessories	112
		<b>COVERS</b>	<b>114</b>
		<b>PARTS</b>	<b>117</b>
		<b>OILS &amp; MAINTENANCE</b>	<b>118</b>

# RIDING GEAR

---



## LIFE'S BETTER WITHOUT LIMITS.

---

Look beyond the horizon, to all of those unseen, unexplored destinations that never seem to stop calling you. Listen to your heart and head out... anywhere. In fact, the farther the better.

Don't just live your dreams; ride them - intensely, completely and without hesitation.

When you're one with your Can-Am Spyder, then anywhere you're headed is home.

# JACKETS

Discover our all-new jackets collection.  
Go to: [store.spyder.brp.com/video](https://store.spyder.brp.com/video)



JAMES LEATHER JACKET 440674

SHAUN PLUS MESH JACKET 440738  
JAMES LEATHER JACKET 440674



VERONICA LEATHER JACKET 440737

VERONICA LEATHER JACKET 440737  
BLAKE LEATHER JACKET 440673



Free spirit, wanderer, adventurer, pioneer. It's great to be one, but better to be all. Some days it feels as if you invented freedom, and others where you'll give everything up to live it for one more moment. Make that moment, and every one that follows it yours.

# LOOK AS GOOD AS YOU RIDE.

KATE MESH JACKET 440736  
BLAKE LEATHER JACKET 440673



MEN'S CRUISE PLUS JACKET 440751  
NICKY PLUS JACKET 440679  
RUSSELL MESH JACKET 440676



HANNA JACKET 440735



NICKY PLUS JACKET 440679

COOPER PLUS JACKET 440753



RUSSELL MESH JACKET 440676  
LADIES' CRUISE PLUS JACKET 440752  
MEN'S VOYAGER JACKET 440641



BLAKE LEATHER JACKET 440673



HANNA PLUS JACKET 440754

JAMES LEATHER JACKET 440674  
HANNA JACKET 440735  
NICKY PLUS JACKET 440679  
BRUCE PLUS JACKET 440678



VERONICA LEATHER JACKET 440737  
BRUCE PLUS JACKET 440678



KATE MESH JACKET 440736  
NICKY PLUS JACKET 440679



EMMA PLUS MESH JACKET 440739  
BRUCE PLUS JACKET 440678

# FIND THE RIGHT JACKET

## WHICH JACKET SUITS YOU BEST?

Hit the road in style, your style. There's a Can-Am jacket that fits you in every way and is loaded with the features you want. Whether you choose mesh jackets for keeping cool, leather jackets for their classic look, or ultra-durable nylon for serious road trips, we've got you covered. They're all available in a range

of regular and plus sizes, for men and women, and are designed to work with our exclusive weather-beating rain gear. All you have to do is choose, and we've made that easier than ever. Whatever your destination - and whatever your riding style - you can be sure we've got a jacket that suits you perfectly.



USE THIS GUIDE TO FIND THE FEATURES YOU WANT BY LOOKING FOR THE CORRESPONDING SYMBOL AMONG OUR EXTENSIVE COLLECTION OF JACKETS.



**100% WATERPROOF**  
To keep dry in all conditions.



**WATER RESISTANT**  
To keep dry in light rain conditions or during short rides.



**WINDPROOF**  
To protect from air infiltration.



**REMOVABLE INSULATED LINING**  
To adapt to the current temperature. Wear when cold, remove when warm.



**POCKETS FOR REMOVABLE PROTECTORS**  
Pouches to insert removable protectors.



**ADJUSTED FIT**  
Fits closer to the body.



**RELAXED FIT**  
Looser fit for relaxed riding position.



**RPM**



**RPM MAX**

## HIGH PERFORMANCE GEAR WITH RPM TECHNOLOGY

Critical seams and logos are sealed, so water can't enter through potential openings.



100% of seams and logos are sealed, so water can't enter through potential openings.

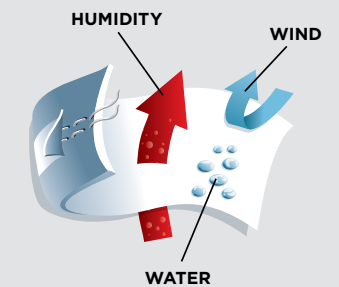

**RPM & RPM MAX** coatings keep wind and air out and still allows perspiration to escape.





REGULAR SIZE COLLECTION



### COOPER & HANNA JACKETS

#### FEATURES

- Teflon-treated highly wear-resistant fabric.
- Shaped sleeves.
- Critical seams sealed.
- Chest and back ventilation (Hanna Jacket).
- Underarm ventilation (Cooper Jacket).
- Multi-adjustable biceps, forearms, wrists and waist openings.
- Reflective back collar.
- May require rain suit in heavy rain conditions.

Shell: Nylon  
Insulation: Polyester

#### BENEFITS

- Outstanding ventilation, lightweight for extra comfort.
- Breathable to keep you dry.
- Excellent flexibility and rider fit.
- Wind and water protection.
- Ultra-durability and wear resistance.
- Convenience, good practicality, and nighttime visibility.



**COOPER JACKET**  
440671 · S, M, MT, L, LT, XL, XLT, 2XL, 3XL · Khaki (05), Black (90)  
\$259.99



**HANNA JACKET**  
440735 · XS, S, M, L, XL, 2XL · Khaki (05), Black (90)  
\$259.99



## TEXTILE

▶ See more of our textile jackets.  
Go to: [store.spyder.brp.com/video](https://store.spyder.brp.com/video)

### MEN'S & LADIES' CRUISE JACKETS



#### FEATURES

- Teflon-treated highly wear-resistant fabric.
- Shaped sleeves.
- Action pleat gussets at back armhole for extra comfort and ease of movement.
- Critical seams sealed.
- Chest and back ventilation.
- Multi-adjustable biceps, wrists and waist openings.
- Reflective details at back.
- May require rain suit in heavy rain conditions.

Shell: Nylon, Other Fabric  
Insulation: Polyester

#### BENEFITS

- Outstanding ventilation, lightweight for extra comfort.
- Breathable to keep you dry.
- Excellent flexibility and rider fit.
- Wind and water protection.
- Ultra-durability and wear resistance.
- Convenience, good practicality, and nighttime visibility.



**MEN'S CRUISE JACKET**  
440733 · S, M, L, XL, 2XL, 3XL · Grey (09) · Black (90)  
\$259.99



**LADIES' CRUISE JACKET**  
440734 · XS, S, M, L, XL, 2XL · Grey (09) · Black (90)  
\$259.99



## MESH

▶ See our mesh jackets in action.  
Go to: [store.spyder.brp.com/video](https://store.spyder.brp.com/video)

### RUSSELL & KATE MESH JACKETS

#### FEATURES

- Made of highly breathable mesh.
- No collar.
- Adjustable waist, biceps, forearms and sleeves openings.
- Shaped sleeves.
- 3M' reflective details at back.

Shell: Polyester, Nylon  
Insulation: Polyester

#### BENEFITS

- Lightweight comfort with outstanding breathability.
- Excellent flexibility and rider fit.
- Convenience, practicality, and nighttime visibility.



**RUSSELL MESH JACKET**  
440676 · S, M, L, XL, 2XL, 3XL · Black (90)  
\$199.99



**KATE MESH JACKET**  
440736 · XS, S, M, L, XL, 2XL · Black (90)  
\$199.99



# LEATHER

▶ Watch our video of the 2017 leather jackets lineup.  
Go to: [store.spyder.brp.com/video](http://store.spyder.brp.com/video)

## JOSH, JAMES, BLAKE & VERONICA LEATHER JACKETS



### FEATURES

- Full grain distressed vintage cowhide leather.
- Shaped sleeves.
- Chest and back ventilation (James and Blake Leather Jackets).
- Arms and back ventilation (Veronica Leather Jacket).
- Tartan cotton lining.
- Men's Shell: Cow Leather
- Ladies' Shell: Cow Leather, Nylon, Other Fabric
- Insulation: Cotton

### BENEFITS

- Flexible for better comfort and ease of movement.
- Stylish, eye-catching design.
- Convenience and practicality.



**NEW JOSH LEATHER JACKET**  
440740 · S, M, L, XL, 2XL, 3XL · Black (90)  
**\$349.99**



**JAMES LEATHER JACKET**  
440674 · S, M, L, XL, 2XL, 3XL · Brown (04)  
**\$549.99**



**BLAKE LEATHER JACKET**  
440673 · S, M, L, XL, 2XL, 3XL · Black (90)  
**\$549.99**



**VERONICA LEATHER JACKET**  
440737 · XS, S, M, L, XL, 2XL, 3XL · Black (90)  
**\$549.99**



PLUS SIZE COLLECTION

# TEXTILE

▶ See more of our textile jackets.  
Go to: [store.spyder.brp.com/video](http://store.spyder.brp.com/video)

## MEN'S & LADIES' CRUISE PLUS JACKETS



### FEATURES

- Teflon-treated highly wear-resistant fabric.
- Shaped sleeves.
- Action pleat gussets at back armhole for extra comfort and ease of movement.
- Critical seams sealed.
- Chest, biceps and back ventilation.
- Adjustable biceps openings.
- Reflective back collar.
- May require rain suit in heavy rain conditions.
- Shell: Nylon, Other Fabric
- Insulation: Polyester

### BENEFITS

- Outstanding ventilation and extra roominess, for comfort.
- Breathable to keep you dry.
- Excellent flexibility and rider fit.
- Wind and water protection.
- Ultra-durability and wear resistance.
- Convenience, good practicality, and nighttime visibility.



**NEW MEN'S CRUISE PLUS JACKET**  
440751 · L PLUS, XL PLUS, 2XL PLUS, 3XL PLUS, 4XL PLUS, 5XL PLUS · Black (90)  
**\$299.99**



**NEW LADIES' CRUISE PLUS JACKET**  
440752 · M PLUS, L PLUS, XL PLUS, 2XL PLUS, 3XL PLUS · Black (90)  
**\$299.99**



## MEN'S & LADIES' VOYAGER JACKETS



### FEATURES

- Parka style jacket.
- Teflon HT-treated highly wear-resistant fabric.
- Shaped sleeves.
- Action pleat gussets at back armhole for extra comfort and ease of movement.
- All seams sealed.

- Multi-adjustable biceps, forearms and waist.
  - Chest, shoulder and back ventilation.
  - 3M reflective details.
  - May require rain suit in heavy rain conditions.
- Shell: Nylon  
Insulation: Polyester

### BENEFITS

- Outstanding ventilation and extra roominess, for comfort.
- Keeps you dry and warm all day.
- Excellent flexibility and rider fit.
- Wind and water protection.
- Ultra-durability and wear resistance.
- Convenience, good practicality, and nighttime visibility.



#### MEN'S VOYAGER JACKET

440641 · S, M, L, XL, 2XL, 3XL, 4XL, 5XL  
Black (90)  
**\$349.99**



#### LADIES' VOYAGER JACKET

440642 · XS, S, M, L, XL, 2XL, 3XL, 4XL, 5XL  
Black (90)  
**\$349.99**

## BRUCE PLUS & NICKY PLUS JACKETS



### FEATURES

- Teflon-treated highly wear-resistant fabric.
- Shaped sleeves.
- Action pleat gussets at back armhole for extra comfort and ease of movement.
- Critical seams sealed.
- Chest and back ventilation.

- Multi-adjustable biceps, forearms, wrists and waist openings.
  - Reflective back collar.
  - May require rain suit in heavy rain conditions.
- Shell: Nylon  
Insulation: Polyester

### BENEFITS

- Outstanding ventilation and extra roominess, for comfort.
- Breathable to keep you dry.
- Excellent flexibility and rider fit.
- Wind and water protection.
- Ultra-durability and wear resistance.
- Convenience, good practicality, and nighttime visibility.



#### BRUCE PLUS JACKET

440678 · S PLUS, M PLUS, L PLUS, XL PLUS, 2XL PLUS, 3XL PLUS, 4XL PLUS, 5XL PLUS  
Khaki (05) · Black (90)  
**\$299.99**



#### NICKY PLUS JACKET

440679 · XS PLUS, S PLUS, M PLUS, L PLUS, XL PLUS, 2XL PLUS, 3XL PLUS, 4XL PLUS, 5XL PLUS  
Beige (02) · Black (90)  
**\$299.99**

## COOPER PLUS & HANNA PLUS JACKETS



### FEATURES

- Teflon-treated highly wear-resistant fabric.
- Shaped sleeves.
- Action pleat gussets at back armhole for extra comfort and ease of movement.
- Critical seams sealed.
- Underarm ventilation (Cooper Plus Jacket).

- Chest, biceps and back ventilation (Hanna Plus Jacket).
  - Multi-adjustable biceps, forearms, wrists and waist openings.
  - Reflective back collar.
  - May require rain suit in heavy rain conditions.
- Shell: Nylon  
Insulation: Polyester

### BENEFITS

- Outstanding ventilation and extra roominess, for comfort.
- Breathable to keep you dry.
- Excellent flexibility and rider fit.
- Wind and water protection.
- Ultra-durability and wear resistance.
- Convenience, good practicality, and nighttime visibility.



#### NEW COOPER PLUS JACKET

440753 · L PLUS, XL PLUS, 2XL PLUS, 3XL PLUS, 4XL PLUS, 5XL PLUS · Khaki (05), Black (90)  
**\$299.99**



#### NEW HANNA PLUS JACKET

440754 · M PLUS, L PLUS, XL PLUS, 2XL PLUS, 3XL PLUS · Khaki (05), Black (90)  
**\$299.99**

## MESH



## SHAUN PLUS & EMMA PLUS MESH JACKETS



### FEATURES

- Made of highly breathable mesh.
- No collar.
- Shaped sleeves.
- Action pleat gussets at back armhole for extra comfort and ease of movement.

- Adjustable waist, biceps and sleeves openings.
  - 3M reflective details at back.
- Shell: Polyester, Nylon  
Insulation: Polyester

### BENEFITS

- Outstanding breathability and extra roominess, for comfort.
- Excellent flexibility and rider fit.
- Convenience, practicality, and nighttime visibility.



#### NEW SHAUN PLUS MESH JACKET

440738 · L PLUS, XL PLUS, 2XL PLUS, 3XL PLUS, 4XL PLUS, 5XL PLUS · Black (90)  
**\$249.99**



#### NEW EMMA PLUS MESH JACKET

440739 · M PLUS, L PLUS, XL PLUS, 2XL PLUS, 3XL PLUS · Black (90)  
**\$249.99**

# RAIN GEAR



## RAIN JACKET

- Made of waterproof and windproof Teflon-treated light PVC nylon.
  - Balaclava hood, sewn into the jacket, for use under the helmet while riding, to avoid water infiltration during a downpour.
  - Back ventilation for moisture evacuation.
  - Shaped sleeves.
  - Two Velcro® waist pockets with flap.
  - Reflective details at front and back.
  - Jacket folds into back pocket.
  - To wear over riding jacket, order one size up or try it on over your riding jacket to ensure it fits.
- Shell: Waterproof Nylon  
440568  
XS, S, M, L, XL, 2XL, 3XL  
Black (90)  
**\$99.99**



## RAIN PANTS

- Elasticized waist.
  - Velcro-hemmed wideside leg gusset for slipping pants on while wearing boots.
  - Elastic at bottom leg to prevent pants from riding up.
  - Folds into jacket's back pocket for easy traveling.
  - To wear the pants over clothes, order one size up or try them on over your clothes to ensure they fit.
  - Ladies: order one size smaller.
- Shell: Waterproof Nylon  
441501  
XS, S, M, L, XL, 2XL, 3XL  
Black (90)  
**\$59.99**



# TECHNICAL WEAR



## CAN-AM TECHNICAL JACKET

- Soft shell combines light insulation, breathability and weatherproofing.
  - 4-way stretch fabric.
  - Also ideal for wearing as an insulating first layer on cold days.
  - Reflective details.
  - 2 hand pockets with YKK® water-resistant zipper.
  - Back venting.
  - Pre-shaped sleeves.
  - Adjustment at hem.
- Polyester, Spandex  
Men's - 453755 - S, M, L, XL, 2XL, 3XL - Black (90)  
Ladies' - 453754 - XS, S, M, L, XL, 2XL - Black (90)  
**\$99.99**



Men's



Ladies'

## HEATED VEST LINER

- Insulated, durable, stretchable and water-resistant shell with wind-blocking layer.
  - Flexible heating panels, 2 heating elements at chest and 2 at lower back.
  - Rechargeable lithium battery, up to 5 hours of heating time.
  - Built-in control panel at chest.
  - Easy access battery pouch.
  - Very high safety level with integrated circuit protection and UL certification.
  - 1 lithium-ion battery and 1 wall charger included.
  - Vehicle charger sold separately (4880600090).
- 440645 - XS, S, M, L, XL, 2XL, 3XL - Black (90)  
**\$159.99**



## LITHIUM-ION BATTERY VEHICLE CHARGER

- Allows lithium-ion battery recharging on the vehicle.
- 4880600090  
**\$29.99**



## LITHIUM-ION BATTERIES FOR HEATED VEST LINER

- Sold in pairs.
  - Replacement part.
- 4880590001  
**\$39.99**



## NECK WARMER

- Provides breathable and windproof performance.
- 60% Polyester, 30% Nylon, 10% Spandex  
447410 - One size - Black (90)  
**\$29.99**

# HELMETS & ACCESSORIES



Learn everything about the technology built into the Can-Am helmets by Nolan. Go to: [store.spyder.brp.com/video](https://store.spyder.brp.com/video)

## WHEREVER YOU GO IS THE DESTINATION.

CAN-AM N21 DURANGO OPEN FACE HELMET 448481

CAN-AM N104 ABSOLUTE MODULAR HELMET 448496



CAN-AM N40 FULL CROSSOVER HELMET 448419



CAN-AM N21 DURANGO OPEN FACE HELMET 448481



## OPEN FACE HELMET

### CAN-AM N21 DURANGO OPEN FACE HELMET

**FEATURES**

- Minimalist retro design.
- Super-strong lightweight Lexan® polycarbonate shell.
- Replaceable anti-scratch inner visor.
- Fully removable, washable liner.
- Microlock® quick-release chin strap.
- Complete with protective storage pouch.
- ECE version not available in North America.

**BENEFITS**

- Superior quality and great look.
- High-impact resistance and comfort.
- Good visibility and practicality.
- Anti-bacterial, anti-fungal and moisture wicking for added comfort and hygiene.
- Added safety and convenience.

DOT ECE22.05

Shell: Lexan Polycarbonate



**NEW CAN-AM N21 DURANGO OPEN FACE HELMET**

448481 - DOT  
448482 - ECE  
S, M, L, XL, 2XL, 3XL - Matte Black (93)  
**\$234.99**

## CROSSOVER HELMETS

### CAN-AM N40 FULL CROSSOVER HELMET

**FEATURES**

- **N-Com® B5 Communication System-ready.**
- Super-strong lightweight, aerodynamically-tuned polycarbonate shell with integrated spoiler.
- Exclusive Crossover technology.
- Optically-correct UV400 face shield protects the entire face while offering a large eye port and can be changed in seconds.
- Exclusive Vision Protection System (VPS) features a scratch-resistant, antifogging, sunshield that raises or lowers in an instant.
- Innovative AirBooster® multi-vent airflow system.
- Fully removable, washable Clima-Comfort® liner, adjustable cheek pads.
- Velour-padded chinstrap with Microlock2 quick-release retention system.
- Removable protective chin guard with air intake.
- Includes all necessary accessories: peak, chin guard plugs, side covers and helmet storage pouch.
- ECE version not available in North America.

Shell: Lexan Polycarbonate

**BENEFITS**

- Improved performance, stability and excellent high-impact resistance.
- Ultra-convenient accessory addition or replacement, maintenance, and customization.
- Added safety, exceptional field of vision and convenience.
- Protection against sun, glare, and condensation.
- Exceptional ventilation for improved temperature control.
- Anti-bacterial, anti-fungal and moisture wicking for added comfort and hygiene.
- Convenience and comfort.
- Wind noise reduction.

DOT ECE22.05



### ONE HELMET, EIGHT LOOKS

QUICK-CHANGE ACCESSORIES ALLOW YOU TO CUSTOMIZE THE LOOK AND FEATURES FOR EVERY RIDE.



**CAN-AM N40 FULL CROSSOVER HELMET**

448419 - DOT  
448505 - ECE  
XS, S, M, L, XL, 2XL - White (01), Black (90),  
**NEW** Matte Black (93)  
**\$294.99**



## CAN-AM N44 EVO CROSSOVER HELMET

### FEATURES

- **N-Com B5 Communication System-ready.**
- **NEW** redesigned fully removable, washable Climat-Comfort liner.
- 6-in-1 design, super-strong lightweight, aerodynamically-tuned Lexan polycarbonate shell with integrated spoiler.
- Exclusive Crossover technology.
- Optically-correct UV400 face shield with 3-position vent protects the entire face while offering a large eye port and can be changed in seconds.

- Exclusive Vision Protection System (VPS) feature a scratch-resistant, antifogging, sunshield that raises or lowers in an instant.
- Innovative AirBooster multi-vent airflow system and hot air extractor.
- Velour-padded chinstrap with Microlock2 quick-release retention system and adjustable cheek pads.
- Includes all necessary accessories: pinlock antifog insert, peak, side covers, chin guard plugs and helmet storing pouch.

Shell: Lexan Polycarbonate

### BENEFITS

- Improved performance, stability and excellent high-impact resistance.
- Ultra-convenient accessory addition or replacement, maintenance and customization.
- Added safety, exceptional field of vision, and convenience.
- Protection against sun, glare and condensation.
- Exceptional ventilation for unsurpassed temperature control in hot weather.
- Antibacterial, antifungal and moisture wicking for added comfort and hygiene.
- Safety, comfort and wind noise reduction.

**DOT**

## ONE HELMET, SIX LOOKS

QUICK-CHANGE ACCESSORIES ALLOW YOU TO CUSTOMIZE THE LOOK AND FEATURES FOR EVERY RIDE.



**NEW** CAN-AM N44 EVO CROSSOVER HELMET  
448495 · XS, S, M, L, XL, 2XL, 3XL · Matte Black (93)  
\$394.99



## MODULAR HELMET

### CAN-AM N104 ABSOLUTE MODULAR HELMET

#### FEATURES

- **N-Com B5 Communication System-ready.**
- **NEW** removable, washable and redesigned monobloc cheek pads with integrated chin straps.
- **NEW** Eyewear Adaptive system marked with red inserts on comfort padding.
- Super-strong lightweight, aerodynamically-tuned Lexan polycarbonate shell with integrated spoiler.
- Optically-correct UV400 face shield with 3-position vent protects the entire face while offering a large eye port and can be changed in seconds.
- Pivoting chin bar.

- Exclusive Vision Protection System (VPS) feature a scratch-resistant, antifogging, sunshield that raises or lowers in an instant.
- Eyewear compatible.
- Innovative AirBooster multi-vent airflow system and chin bar vents.
- Fully removable, washable Clima-Comfort liner and cheek pads.
- Velour-padded chinstrap with Microlock2 quick-release retention system and dual-action Centromatic® release system and chin curtain.
- Complete with Pinlock antifog insert, wind protector with reflective panel and helmet storing pouch.

Shell: Lexan Polycarbonate

#### BENEFITS

- Improved performance, stability and excellent high-impact resistance.
- Added safety, exceptional field of vision, convenience and versatility.
- Protection against sun, glare and condensation.
- Exceptional ventilation for improved temperature control.
- Antibacterial, antifungal and moisture wicking for added comfort and hygiene.
- Comfort, wind noise reduction and performance.

**DOT**



**CAN-AM N104 ABSOLUTE MODULAR HELMET**  
448496 · XS, S, M, L, XL, 2XL, 3XL  
Black (90),  
**NEW** White (01)  
\$454.99



## ENHANCE THE EXPERIENCE.

Get your message across around every curve, into any headwind, and in the noisiest traffic with our in-helmet communications systems. A lot happens when convenience, comfort and cutting-edge technology come together to create effortless communication. Whether you're out for an hour or in it for the long haul our systems ride with you, letting you stay in touch in almost any driving condition.



**NOLAN N-COM B5 COMMUNICATION SYSTEM FOR CAN-AM N40, N44 & N104 HELMETS - SINGLE PACK**  
4484240090  
**\$319.99**

### FEATURES

- Designed by Nolan to install easily and to integrate perfectly into Can-Am helmets by Nolan.
- Exclusive N-Com modular communication system delivers freedom, flexibility and impressive expandability.
- Excellent audio quality at any speed with long-ride comfort.
- Enjoy conversations with passengers, other riders, listen to music via your MP3 player, use your smartphone, or operate and interact with your GPS unit - even while the device is charging.
- Fully ECE/ONU 2205 compliant.

# COMMUNICATION SYSTEMS

USE THIS CHART TO FIND THE COMMUNICATION SYSTEM THAT FITS YOUR NEEDS.

	<b>NOLAN N-COM B5</b> 4484240090	<b>SENA 20S</b> 4482070090 (SINGLE PACK) 4482080090 (DUAL PACK)	<b>SENA SMH10</b> 4477140090 (SINGLE PACK) 4477150090 (DUAL PACK)
<b>FEATURES</b>			
Bluetooth	<b>4.1</b>	<b>4.1</b>	<b>3.0</b>
Intercom Distance	<b>500 M (0.3 MI)</b>	<b>2000 M (1.2 MI)</b>	<b>900 M (1 MI)</b>
Universal Intercom*	✓	✓	✓
Intercom Connections*	<b>6-WAY**</b>	<b>8-WAY**</b>	<b>4-WAY**</b>
Cell Phone and/or GPS and/or MP3 Player Compatible	✓	✓	✓
Advance Noise Control	✓	✓	✓
FM Radio	✓	✓	-
Voice Command	✓	✓	-
Helmet Integration	<b>FULLY INTEGRATED</b> (NOLAN'S HELMETS: N40, N44 & N104)	<b>EXTERNAL</b> (UNIVERSAL MOUNTING)	<b>EXTERNAL</b> (UNIVERSAL MOUNTING)

\*Can be connected via Bluetooth to intercom systems of other brands.  
\*\*Way means number of person who can talk together.



**SENA 20S BLUETOOTH COMMUNICATION SYSTEM - SINGLE PACK**  
4482070090  
**\$299.99**

**SENA 20S BLUETOOTH COMMUNICATION SYSTEM - DUAL PACK**  
4482080090  
**\$549.99**

**SENA SMH10 BLUETOOTH COMMUNICATION SYSTEM**  
Single Pack  
4477140090  
**\$209.99**  
Dual Pack  
4477150090  
**\$379.99**

### FEATURES

- Super-versatile, water-resistant multi-function Bluetooth communication, navigation and music system designed for outdoor and vehicle sound environment use.
- Driver-to-passenger and driver-to-driver communication at a range over 1.2 miles (2 km).
- Up to 12-hour talk and 10-day stand-by time on a single charge - permits simultaneous charge & play.
- 4-way conference, smartphone, intercom-to-phone connection, GPS and mp3 music playback via AVRCP operation, or easy-adjust manual operation with exclusive jog dial.
- Voice-prompt feedback, clear and natural sound quality, individual volume control for each audio source, fully-integrated audio booster delivers optimal sound level - fully firmware-upgradeable.
- Complete with integrated microphone, wired microphone, wired boom microphone, speakers, plus mp3, earbud and GPS ports.

### FEATURES

- Sufficient sound level with integrated audio booster.
- Crystal clear and natural sound quality.
- Individual volume control for each audio source.
- Stereo music by 3.5 mm audio cable.
- Water-resistant for use in inclement weather.
- Up to 12 hours talk time, 10 days stand-by time.
- Can be used while charging on road trips.
- Firmware upgradeable.



# FOOTWEAR

## SPYDER RT RIDING BOOTS

- Perfect for rain or cold weather.
- Water-repellent leather.
- Hipora® waterproof, windproof and breathable membrane with 100% polyester lining padded with open cell foam for better comfort.
- 3M Scotchlite reflective detail on back.
- High-tech rubber composite sole.
- Sole structure offering a good grip under all conditions.
- Molded nylon shin guard backed with shock absorbing material.
- Molded nylon ankle guard.
- Injected thermoplastic polyurethane toe pad for shifting gears.
- Techno GI® thermoplastic toe cap.
- Pre-formed orthopedic vibration-absorbing sole.
- Anti-crush tempered steel shank.
- Anti-twist sole.



Leather, Polyurethane  
**444208 · 7, 8, 9, 10, 11, 12, 13 · Black (90)**  
 See p. 47 for European footwear equivalencies.  
**\$179.99**

## ULTRALIGHT SOCKS

- Warm and comfortable moisture-wicking for dry feet at all times.
  - Extreme resistance to cold and active management of perspiration moisture.
  - Dri-release® wool combines latest-generation ease of care of synthetic fabric and look of natural fiber.
  - Elastic ankle and arch support.
- 42% Polyester, 34% Polyamide Nylon, 16% Polypropylene, 6% Merino Wool, 2% Elastane  
**286340 · S/M, L/XL · Black (90)**  
**\$9.99**



## CAN-AM RIDING BOOTS

- Can-Am branded 8-inch high lace-up style with gusseted tongue to protect against water and debris, and a soft padded collar for superior riding comfort.
  - VIBRAM® Bifida® technical rubber outsoles deliver comfort and excellent traction while riding.
  - Water-repellent COSMO® Hydroguard® membrane.
  - Internal steel toe caps, and external scuff-resistant TPU toe protectors.
  - Double heavy-duty stitching in critical stress areas.
  - Extra-durable anti-abrasion laces.
- Leather  
**444197 · 7, 8, 9, 10, 11, 12, 13 · Black (90)**  
 See p. 47 for European footwear equivalencies.  
**\$184.99**



## THERMAL SOCKS

- Socks for extreme cold.
  - Same thickness as competing thermal socks, but lighter, warmer and better moisture-wicking performance.
  - Thermolite® hollow-core fibers deliver new generation of warmth-comfort fusion.
  - Elastic ankle and arch support.
  - Fully cushioned shin segment.
- 50% Polyester Thermolite, 32% Polyamide Nylon, 13% Merino Wool, 3% Acrylic, 2% Elastane  
**286341 · S/M, L/XL · Black (90)**  
**\$19.99**



# PROTECTIVE GUARDS



## RETRO REFLECTIVE ARMBAND

- To wear on bicep over a jacket to be more visible.
  - Velcro attachment.
  - Meets France retro-reflective equipment legislation.
- Polyester, Spandex, Polyurethane  
**453674 · One size Hi-Vis Yellow (26)**  
**\$9.99**



## REMOVABLE BACK PROTECTOR

- High shock absorbing performance.
  - Maximal comfort.
  - Can be inserted in most Can-Am Spyder jacket inside pouches for extra protection.
- Viscoelastic Polyurethane Foam  
**447321 · S, L, XL · Black (90)**  
**\$24.99**



## REMOVABLE ELBOW, KNEE OR SHOULDER PROTECTORS

- Same protectors for elbow, knee or shoulder.
  - Can be inserted in most Can-Am Spyder riding gear inside pouches for extra protection.
  - Sold in pairs.
- Viscoelastic Polyurethane Foam  
**Men's 447313 · One size Black (90)**  
**\$24.99**
- Ladies' 447322 · One size Black (90)**  
**\$24.99**

# BAGS

## NEW SHAD BACKPACK E-83

- Semi-rigid exterior.
  - Secure storage in 2 zippered main compartments.
  - Zippered inner pocket with padded compartments.
  - Adjustable waist and chest straps.
  - Cushioned carry handle.
  - Cover for any helmet size. Adjustable to backpack with 4 metal buckles.
- 219400729 · Black**  
**\$149.99**



## DENIM URBAN BACKPACK

- Casual bag for day-to-day travel.
  - Adjustable padded shoulders straps.
  - Organizer panel inside front zippered pocket.
  - Zippered large main storage.
  - Comfortable and easy to carry.
  - Casual stylishness.
  - Convenience, security, roominess.
- Cotton, Polypropylene, Spandex, Polyurethane, PVC  
**4692780079 · Denim Blue**  
**\$29.99**



## CAN-AM SPYDER CARRIER DRY BACKPACK BY OGIO

- Waterproof rolltop design.
  - Made of 420-denier nylon for greater durability.
  - Dual-density foam shoulder strap and adjustable sternum strap.
  - Quick-access front pocket.
  - Organizer panel with 2 zippered pockets inside.
  - Laptop and tablet sleeves.
  - 360-degree reflective details.
  - Removable high visibility liner.
  - Dimensions: H 20.5" x W 10.5" x D 6.75" (52 cm x 27 cm x 17 cm).
  - Capacity: 1600 cu. in. (26 L).
- Polyester  
**4695490090 · Black**  
**\$139.99**



## CAN-AM SPYDER CARRIER BACKPACK BY OGIO

- Padded interior laptop compartment fits most 17" (43 cm) laptops.
  - Integrated iFom® foam panels keep electronics and other valuables protected.
  - Padded iPad® / tablet / e-reader sleeve.
  - Very large main compartment.
  - Comfortable padded back panel.
  - Adjustable ergonomic shoulder strap.
  - Zippered fleece-lined pocket for valuables.
  - Dual side beverage / accessory holders.
  - Dimensions: H 19" x W 13" x D 7.5" (48 cm x 33 cm x 19 cm).
- Polyester  
**4478700090 · Black**  
**\$79.99**



## CAN-AM SPYDER CARRIER HELMET BAG BY OGIO

- Oversized helmet bag for all helmet brands and sizes.
  - Integrated iFom foam panels and fleece inner surface provide ultimate protection.
  - Protective closure insert prevents scratches from zippers.
  - Easy-access oversized external pocket for goggles.
  - Outer zippered accessory pocket.
  - Durable reinforced bottom.
  - Dimensions: H 11" x W 13" x D 7.5" (28 cm x 33 cm x 19 cm).
- Polyester  
**4478710090 · Black**  
**\$49.99**



## CAN-AM HELMET CASE

- Carrying strap.
  - Inner compartment for helmet accessories.
  - H 16" x W 11" x D 13" (41 cm x 28 cm x 33 cm).
- Polyester  
**4476780090 · Black**  
**\$29.99**



# GLOVES



Hot Weather



All Weather



Cold Weather



## MECHANIC GLOVES

- Multizone padded palm reduces hand fatigue from shock and vibration.
- Pre-curved design for improved fit.
- Double Clarino® layer at palm and thumb for extra durability and increased comfort.

Shell: Nylon, Polyester, Polyurethane, Spandex

446267 · S, M, L, XL, 2XL, 3XL

Black (90)

\$39.99



## BOULEVARD HALF LEATHER GLOVES

- Perforated leather gloves.
- Snap tab wrist adjustment.
- Light padding at upper palm.
- Inner fingers with grips to help release gloves.
- Short cuff.

Shell: Cow Leather, Polyester

446270 · S, M, L, XL, 2XL, 3XL

Black (90)

\$34.99



Men's

Magnesium (24)



Black (90)

Ladies'



Charcoal Grey (07)



## SUMMER MESH GLOVES

- Pre-curved design for improved fit.
- Perforated Clarino palm.
- Double Clarino layer at palm and thumb for extra durability and increased comfort.

Men's Shell: Nylon, Polyurethane, Spandex, Polyester  
Ladies' Shell: Nylon, Polyurethane, Polyester, Neoprene, Lycra

Men's

446205 · M, L, XL

Magnesium (24), Black (90)

\$34.99

Ladies'

446232 · XS, S, M, L, XL, 2XL

Charcoal Grey (07)



Men's



## RESPIRATOR GLOVES

- Perforated leather gloves.
- Shaped fingers.
- Silicone® palm print for a better grip.

Shell: Leather, Nylon, Polyurethane

Men's

446230 · S, M, L, XL, 2XL, 3XL

Black (90)

\$69.99



Ladies'



## NEW BLAKE LEATHER GLOVES

- Fine grade leather.
- Fit perfectly to offer warmth and protection for mild weather.
- Suede forefinger to wipe visor.
- Padded palm for comfort during longer rides.

Shell: Cow Leather

446290 · M, L, XL, 2XL, 3XL

Black (90)

\$49.99



## TECH PLUS GLOVES

- Leather palm with Kevlar® thread stitching.
- Outdry® technology membrane.
- Waterproof and windproof.
- X-STATIC® mesh liner for antibacterial and moisture management.
- PrimaLoft Gold® insulation at top of hand.
- Leather padded knuckles for better protection.
- Shaped and articulated fingers for maximum grip control.
- Adjustable gauntlet to be worn over or under the jacket.

Shell: Nylon, Polyester

Insulation: Polyester, XT2

446269 · XS, S, M, L, XL, 2XL

Black (90)

\$159.99



See the features of the Tech Plus Gloves.  
Go to: [store.spyder.brp.com/video](http://store.spyder.brp.com/video)



## DAYBREAK GLOVES

- Insulated gloves.
- Waterproof, windproof and breathable membrane.
- Synthetic leather at palm with pigskin reinforcement and Kevlar thread stitching.
- Wool blend lining.
- Shaped fingers.

Shell: Polyester, Nylon, Leather

Insulation: Polyester

Men's

446271

S, M, L, XL, 2XL, 3XL

Black (90)

\$74.99

Ladies'

446272

XS, S, M, L, XL, 2XL

Black (90)



Men's



Ladies'



## VSS LEATHER GLOVES

- Hipora® waterproof, windproof and breathable insert.
- Reinforced and padded palm.
- Shaped fingers.
- Articulated and padded knuckle-joint system.
- Silicone palm print for better grip.

Shell: Leather

Men's

446204 · S, M, L, XL, 2XL

Magnesium (24), Black (90)

Ladies'

446216 · S, M, L, XL

White (01), Black (90)

\$89.99



Men's

Magnesium (24)



Black (90)



Ladies'

White (01)



Black (90)



## NEW VERONICA LEATHER GLOVES

- Fine grade leather.
- Fit perfectly to offer warmth and protection for mild weather.
- Suede forefinger to wipe visor.
- Padded palm for comfort during longer rides.

Shell: Cow Leather

446291 · S, M, L, XL, 2XL

Black (90)

\$49.99



# SPORTSWEAR

JESS LONG SLEEVE T-SHIRT 453823  
DISTRICT JACKET 453734  
JAMES T-SHIRT 453738



SAY HELLO  
TO THE NEW YOU.

You're unique. You always knew that the journey was the destination and it didn't matter who got there first as long as you enjoyed the ride. Confidence, determination and fearlessness have gotten you far, dont stop now.

JOSH T-SHIRT 453806



RIDE T-SHIRT 453826



CALIBER V NECK T-SHIRT 453794  
SIGNATURE T-SHIRT 453590  
JESS T-SHIRT 453743  
RIDE T-SHIRT 453826

JOSH T-SHIRT 453806



JULIA T-SHIRT 453809



SLEEVELESS TOP 453764  
COOPER LONG SLEEVE T-SHIRT 453820



CAN-AM ROADSTER T-SHIRT 453732  
JESS T-SHIRT 453743

CAN-AM ROADSTER T-SHIRT 453732



ORIGINAL T-SHIRT 286402



"BLING" T-SHIRT 453817



JAMES T-SHIRT 453738  
 JULIA T-SHIRT 453809  
 COOPER LONG SLEEVE T-SHIRT 453820

# SHIRTS & TEES

## DISTRICT JACKET

- Cotton canvas casual jacket.  
100% Cotton  
453733  
S, M, L, XL, 2XL, 3XL  
Khaki (05)  
**\$129.99**



## CAN-AM LONG SLEEVE T-SHIRT

48% Nylon, 38% Polyester, 14% Spandex  
453802  
S, M, L, XL, 2XL, 3XL  
Black (90)  
**\$59.99**



## COOPER LONG SLEEVE T-SHIRT

- Front print with vintage look.  
100% Cotton  
453820  
S, M, L, XL, 2XL, 3XL  
Khaki (05), Black (90),  
**\$34.99**



## COOPER T-SHIRT

100% Cotton  
453739  
S, M, L, XL, 2XL, 3XL  
Khaki (05), Black (90)  
**\$24.99**



## JOSH T-SHIRT

100% Cotton  
453806  
S, M, L, XL, 2XL, 3XL  
Brown (04), Black (90)  
**\$24.99**



## SIGNATURE T-SHIRT

100% Cotton  
453590  
S, M, L, XL, 2XL, 3XL  
White (01), Charcoal Grey (07)  
**\$19.99**



## RELAX T-SHIRT

100% Cotton  
453687  
S, M, L, XL, 2XL, 3XL  
Grey (09), Ice (38)  
**\$24.99**



## CALIBER POLO

- UV protection.  
66% Interlock, 34% PES mini-R  
453824  
S, M, L, XL, 2XL, 3XL  
Black (90)  
**\$49.99**



## JAMES T-SHIRT

100% Cotton  
453738  
S, M, L, XL, 2XL, 3XL  
Beige (02), Khaki (05)  
**\$24.99**



## RUSSELL T-SHIRT

- Spyder F3 print.  
100% Cotton  
453737  
S, M, L, XL, 2XL, 3XL  
Blue (80), Black (90)  
**\$24.99**



## CAN-AM ROADSTER T-SHIRT

- Spyder ST print.  
100% Cotton  
453732  
S, M, L, XL, 2XL, 3XL  
Red (30), Navy (89), Black (90)  
**\$24.99**



## CLYDE T-SHIRT

- Spyder F3 print at back.  
100% Cotton  
453741  
S, M, L, XL, 2XL, 3XL  
Beige (02), Khaki (05)  
**\$24.99**



Back



## RIDE T-SHIRT

- Can-Am Spyder RT vehicle print at front.  
100% Cotton  
453826  
S, M, L, XL, 2XL, 3XL  
Khaki (05), Black (90)  
**\$24.99**



## ORIGINAL T-SHIRT

100% Cotton  
286402  
S, M, L, XL, 2XL, 3XL  
Heather Grey (27), Ice (38), Black (90)  
**\$24.99**



## LONG SLEEVE ORIGINAL T-SHIRT

100% Cotton  
286415  
S, M, L, XL, 2XL, 3XL  
Heather Grey (27), Ice (38), Black (90)  
**\$34.99**



# BANDANAS

## BANDANA

- Light and comfortable.  
- Multiple wear options.  
80% Polyester, 20% Cotton  
447763  
One size  
Red (30), Black with graphics (94)  
**\$9.99**



# CAPS

## ORIGINAL CAP

- Adjustable back strap.  
100% Cotton  
286401  
One size  
Beige (02), Orange (12), Black (90)  
**\$21.99**



## CALIBER CAP

- Stretchable by rear elastic.  
97% Polyester, 3% Spandex  
447999  
S/M, L/XL  
White (01), Red (30), Black (90)  
**\$24.99**



## CRUISE CAP

- Adjustable back strap.  
- Embossed logo on synthetic leather on front panel.  
85% Acrylic, 15% Wool  
448321  
One size  
Black (90), Grey (09)  
**\$24.99**



## CLASSIC CAP

- Adjustable back strap.  
72% Polyester, 23% Rayon, 5% Spandex  
286210  
One size  
Black (90)  
**\$19.99**



## BLAKE CAP

- Stretchable by rear elastic.  
- Print inside visor.  
97% Cotton, 3% Spandex  
448200  
S/M, L/XL  
Beige (02), Black (90)  
**\$24.99**



## CLYDE CAP

- Adjustable back strap.  
100% Cotton  
448201  
One size  
Brown (04), Black (90)  
**\$24.99**



## JACK CAP

- Adjustable back strap.  
100% Cotton  
448202  
One size  
Black (90)  
**\$24.99**





**"BLING" T-SHIRT**

- V-neck tee.  
95% Cotton, 5% Spandex  
453817  
XS, S, M, L, XL, 2XL  
Heather Grey (27)  
Black (90)  
**\$24.99**



**JESS T-SHIRT**

- Spyder F3 print.  
100% Cotton  
453743  
XS, S, M, L, XL, 2XL  
Brown (04), Light Blue (81),  
**\$24.99**



**JESS LONG SLEEVE T-SHIRT**

- V-neck tee.  
- Large print at front.  
95% Cotton, 5% Spandex  
453823  
XS, S, M, L, XL, 2XL  
Heather Grey (27)  
Black (90)  
**\$34.99**



**JANE T-SHIRT**

95% Cotton, 5% Spandex  
453745  
XS, S, M, L, XL, 2XL  
Beige (02), Brown (04)  
**\$24.99**



**ORIGINAL T-SHIRT**

95% Cotton, 5% Spandex  
286403  
XS, S, M, L, XL, 2XL  
Heather Grey (27),  
Ice (38), Black (90)  
**\$25.99**



**CAPS**

**JANE CAP**

- Adjustable back strap.  
100% Cotton  
448322  
One size  
Black (90), Grey (09)  
**\$19.99**



**BANDANAS & TUBES**

**BANDANA**

- Light and comfortable.  
- Multiple wear options.  
80% Polyester, 20% Cotton  
447763  
One size  
Red (30), Raspberry (39)  
Black with graphics (94)  
**\$9.99**



**TUBE**

- Multipurpose, stretchable and comfortable scarf.  
- 12 different configurations: bandana, neck warmer, headband and much more.  
- Protects from sun, wind, dust and cold.  
100% Polyester  
453748  
One size  
Red (30), Light Blue (81),  
Black with graphics (94)  
**\$14.99**



**SHIRTS & TEES**

**DISTRICT JACKET**

- Cotton canvas casual jacket.  
100% Cotton  
453734  
XS, S, M, L, XL, 2XL  
Khaki (05)  
**\$129.99**



**JULIA T-SHIRT**

95% Cotton, 5% Spandex  
453809  
XS, S, M, L, XL, 2XL  
Blue (80), Black (90)  
**\$24.99**



**SLEEVELESS TOP**

95% Cotton, 5% Polyester  
453764  
XS, S, M, L, XL, 2XL  
Black (90)  
**\$29.99**



**CALIBER V NECK T-SHIRT**

- UV protection.  
66% Interlock, 34% PES mini-R  
453794  
XS, S, M, L, XL, 2XL  
White (01), Black (90)  
**\$39.99**



**GLAM T-SHIRT**

95% Cotton, 5% Spandex  
453805  
XS, S, M, L, XL, 2XL  
White (01), Pink (36)  
**\$24.99**



**CAN-AM AUTHENTIC T-SHIRT**

95% Cotton, 5% Spandex  
453808  
XS, S, M, L, XL, 2XL  
White (01)  
**\$24.99**





**GO FAS RACING TEAM POLO**

- Short sleeve polo.
- Embroidered sponsor patches.
- Can-Am logos on front and back.
- Red numbering on left sleeve.
- 100% Polyester



**Men's**  
286634 - S, M, L, XL, 2XL, 3XL - White (01), Yellow (10), Black (90)  
**\$34.99**

**Ladies'**  
• Feminine cut.  
286635 - XS, S, M, L, XL, 2XL - White (01)  
**\$34.99**



**GO FAS RACING TEAM CAP**

- Can-Am logo on front.
- Embroidered sponsor patches.
- Kappa logo on side.
- White and red numbering on peak.
- 100% Polyester
- 286641 - One size
- Yellow (10), Black (90)
- \$19.99**

**GO FAS RACING TEAM HOODIE**

- Full-zip hooded fleece with long sleeves.
- Sponsor patches.
- Can-Am logos on front and back.
- White and red numbering on left sleeve.
- 60% Cotton, 40% Polyester



**Men's**  
286638  
S, M, L, XL, 2XL, 3XL  
Black (90)  
**\$64.99**

**Ladies'**  
286639  
XS, S, M, L, XL, 2XL  
White (01)  
**\$64.99**



**GO FAS RACING TEAM JACKET**

- Mix of embroidered and printed sponsor patches.
- Can-Am logos on front and back.
- White and red numbering on left sleeve.
- 58% Cotton, 38% Polyester, 4% Elasthane
- 286640
- S, M, L, XL, 2XL, 3XL
- Black (90)
- \$79.99**



**GO FAS RACING TEAM TECHNICIAN SHIRT**

- Short sleeve shirt.
- Embroidered sponsor patches.
- Can-Am logos on front and back.
- White and red numbering on left sleeve.
- Chest pocket.
- 58% Cotton, 38% Polyester, 4% Elasthane
- 286636
- S, M, L, XL, 2XL, 3XL
- Yellow (10), Black (90)
- \$49.99**



**GO FAS RACING TEAM JERSEY**

- Long sleeve jersey with mesh inserts.
- Embroidered sponsor patches.
- Can-Am logo on front.
- Kappa logo on sleeves.
- 100% Polyester
- 286637
- S, M, L, XL, 2XL, 3XL
- Yellow (10), Green (70), Blue (80)
- \$49.99**



**GO FAS RACING TEAM T-SHIRT**

- Short sleeve t-shirt.
- Embroidered sponsor patches.
- Can-Am logos on front and back.
- White and red numbering on left sleeve and back.
- 100% Cotton
- 286632
- S, M, L, XL, 2XL, 3XL
- Yellow (10), Black (90)
- \$25.99**



**LADIES' GO FAS RACING TEAM T-SHIRT**

- Short sleeve t-shirt.
- Feminine cut.
- Can-Am logo on front.
- White and red numbering on sleeve and front.
- 100% Cotton
- 286633
- XS, S, M, L, XL, 2XL
- Yellow (10), Black (90)
- \$25.99**





IF WE SELL IT, WE STAND BY IT.

# BRP LIMITED WARRANTY\*

FOR NEW PARTS, ACCESSORIES AND RIDING GEAR.

1 YEAR LIMITED WARRANTY\*\*

 GENUINE BRP PARTS AND ACCESSORIES installed by you or your authorized BRP dealer

 AFTERMARKET PRODUCTS SOLD BY BRP

 RIDING GEAR

4 YEAR LIMITED WARRANTY\*\*

 HELMETS



GET ALL THE DETAILS FROM YOUR CAN-AM SPYDER DEALER

\* Purchased at an authorized BRP dealership / distributor or on a BRP-authorized online store. Other exclusions may apply, see complete limited warranty or contact your Can-Am Spyder authorized dealer.  
 \*\* Unless otherwise stipulated or required by law.  
 This limited warranty does not apply to factory installed accessories. This limited warranty does not apply on Evinrude parts and accessories.  
 This limited warranty is effective as of March 1st 2016.

## HOW TO MEASURE

For best results, have someone else take measurements. Measure body in underwear. Tape must be snug but not tight. If measurements fall between two sizes, order the larger size.

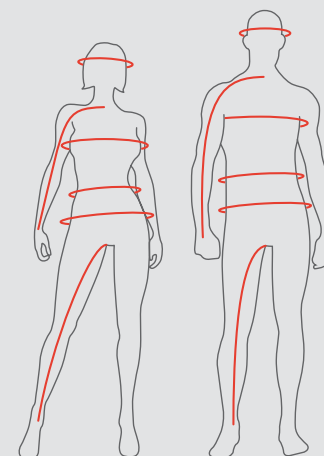

**HEAD**  
 Around your head, from the center of the forehead, above the ears and over the natural bump at the back of the head.

**CHEST/BUST**  
 Measure under your arms, around the fullest part of your chest.

**WAIST**  
 Measure around your natural waistline, keeping one finger between the tape and body.

**HIPS**  
 Across the fullest part of the seat.

**INSEAM**  
 Without shoes, from crotch to the floor.

**ARM LENGTH**  
 Let hands down the side in a slightly bent position. Measure from center back neck bone, along shoulder point and elbow, to bottom of wrist bone.

**GLOVES**  
 Measure palm width.

## WHAT CODE REPRESENTS YOUR SIZE?

1. Find your size.
2. The corresponding code is THE CODE you use to complete the part number on your order.  
 Example: 440 227\_\_90  
 Size: M = Code 06  
 Therefore 440 227 06 90

For tall sizes, look for the "T" next to the size. Example: "MT" stands for Medium Tall.

<b>CODE</b>	00	02	04	06	07	09	10	73	12	13	14	16	18	88	72	91	27	28	29	30	31	32	33
<b>SIZE</b>	OS	XS	S	M	MT	L	LT	L/XL	XL	XLT	2XL	3XL	4XL	5XL	S/M	M/L	7	8	9	10	11	12	13
<b>CODE</b>	60		61		62		63		64		65		66		67		68						
<b>SIZE</b>	XS PLUS		S PLUS		M PLUS		L PLUS		XL PLUS		2XL PLUS		3XL PLUS		4XL PLUS		5XL PLUS						

### MEN'S REGULAR · 5'8" - 6'0"

TOP & BOTTOM	XS	S	M	L	XL	2XL	3XL
Chest (in)	33-35	35-37	37-40	40-44	44-48	48-52	52-56
Waist (in)	27-29	29-31	31-34	34-38	38-42	42-46	46-50
Hips (in)	33-35	35-37	37-40	40-44	44-48	48-52	52-56
Arm length (in)	30	31	32	33	34	35	35
Inseam (in)	31	31½	32	32	32	32	32½

### MEN'S TALL · 6'1" - 6'4"

TOP	MT	LT	XLT
Chest (in)	37-40	40-44	44-48
Waist (in)	31-34	34-38	38-42
Hips (in)	37-40	40-44	44-48
Arm length (in)	33½	34½	35½
Inseam (in)	34	34	34

### MEN'S PLUS SIZE · 5'8" - 6'0"

BRUCE, SHAUN PLUS, COOPER PLUS, MEN'S CRUISE PLUS	S PLUS	M PLUS	L PLUS	XL PLUS	2XL PLUS	3XL PLUS	4XL PLUS	5XL PLUS
<b>VOYAGER</b>	S	M	L	XL	2XL	3XL	4XL	5XL
Chest (in)	38-40	40-43	43-47	47-51	51-55	55-59	59-62	62-66
Waist (in)	35-37	37-40	40-44	44-48	48-52	52-56	56-59	59-68
Hips (in)	38½-40½	40½-43½	43½-47½	47½-51½	51½-55½	55½-59½	59½-62½	62½-71½
Arm length (in)	31	32	33	34	35	35	36	36

### LADIES' REGULAR · 5'4" - 5'8"

TOP & BOTTOM	XS	S	M	L	XL	2XL	3XL
Chest (in)	32-34	34-36	36-39	39-42	42-45	45-49	49-53
Waist (in)	24-26	26-28	28-30	30-34	34-37	37-41	41-45
Hips (in)	34-36	36-38	38-40	40-44	44-47	47-51	51-55
Arm length (in)	31	31	31½	32	32½	33	34
Inseam (in)	30	30	30	30	30	30½	30½

### LADIES' PLUS SIZE · 5'4" - 5'8"

NICKY, EMMA PLUS, HANNA PLUS, LADIES' CRUISE PLUS	XS PLUS	S PLUS	M PLUS	L PLUS	XL PLUS	2XL PLUS	3XL PLUS	4XL PLUS	5XL PLUS
<b>VOYAGER</b>	XS	S	M	L	XL	2XL	3XL	4XL	5XL
Chest (in)	35-37	37-39	39-42	42-45	45-48	48-52	52-56	56-60	60-64
Waist (in)	28-30	30-32	32-34	34-38	38-41	41-45	45-49	49-53	53-57
Hips (in)	37-39	39-41	41-43	43-47	47-50	50-54	54-58	58-62	62-66
Arm length (in)	31	31	31½	32	32½	33	34	34	35

### REMOVABLE BACK PROTECTORS

	MEN'S JACKET SIZES	LADIES' JACKET SIZES
S	S and M	XS to L
L	L to 2XL	XL to 5XL
XL	3XL to 5XL	-

### MEN'S GLOVES

	S	M	L	XL	2XL	3XL
Inches	3	3¾	3¾	4¼	4½	5½

### LADIES' GLOVES

	XS	S	M	L	XL	2XL
Inches	2¼	2½	3	3¼	3½	4½

### HELMETS

	XS	S	S/M	M	M/L	L	XL	2XL	3XL
Head circumference (in)	20¾-21¼	21¾-22	22¾	22¾-22¾	22¾	23¾-23¾	24-24¾	24¾-25½	25½-25¾

### CAN-AM SPYDER RT RIDING BOOTS

SIZE US	7	8	9	10	11	12	13
<b>SIZE EU</b>	<b>40</b>	<b>41</b>	<b>42</b>	<b>43</b>	<b>44</b>	<b>45</b>	<b>46</b>
Foot length (in)	10.0	10.2	10.5	10.7	11.0	11.3	11.5
Foot length (cm)	25.3	26.0	26.7	27.3	28.0	28.7	29.3

### CAN-AM RIDING BOOTS

SIZE US	7	8	9	10	11	12	13
<b>SIZE EU</b>	<b>39.5</b>	<b>41.0</b>	<b>42.5</b>	<b>44.0</b>	<b>45.5</b>	<b>47.0</b>	<b>48.5</b>
Foot length (in)	9.8	10.2	10.6	11.0	11.4	11.8	12.2
Foot length (cm)	25.0	26.0	27.0	28.0	29.0	30.0	31.0

# ACCESSORIES

---



LOOK BEYOND  
THE ORDINARY.

---





## UNIQUE BEGINS WITH U

**Create a Can-Am Spyder that's as unique as you are.  
Our exclusive 4U Guide is the key to kick starting your customization.  
Choose and cruise. As easy as 1-2-3-4.**

**We created the 4U Guide, your personal guide to customization. It's based on you - your needs, your riding style, your personality and preferences - so the accessories you choose will be the right ones.**

**These 4 questions will help you better understand your needs and really make this guide work for you in selecting accessories.**

**1. Is your Can-Am Spyder adjusted to your body?**

Run through our U-Fit section and find what handlebar and footpeg positions fit you best.

**2. Does your Can-Am Spyder have all the accessories you need?**

Would you like to reduce the wind flow to your face? Are you riding solo or 2-up? Do you need more storage space? Check out our U-Function section and make your vehicle better suited for you.

**3. Does your Can-Am Spyder truly express your personality?**

Are you looking for a sportier attitude? Or a more luxurious look with chrome accessories? Discover our custom accessories in the U-Style section.

**4. Do you want to unleash the power and handling of your Can-Am Spyder?**

Are you looking for a deeper more guttural sound? A cushier ride? Find what you need in our U-Performance section.

**The 4U Guide is the simplest way to create a Can-Am Spyder that's truly a reflection of you. We've thought of everything including compatibility and fit with accessories. The 4U Guide makes choosing accessories simpler, more practical, and easier to understand. Now nothing stops U.**



### U-FIT

Now you can tailor your Can-Am Spyder to fit you like a dream. Tweak and adjust the fit that lets you truly connect with your ride. It's all about comfort and enjoying every stretch and curve of the road to freedom.

UFIT SYSTEM  
HANDLEBARS  
BRAKE & SHIFTER LINKAGES  
FOOTBOARDS



### U-FUNCTION

Every outing is different and that's part of the fun. Customize your Can-Am Spyder for the way you usually ride, and thanks to our easy-to-add or -remove integrated accessories, you can adjust as you need. Is it a solo or 2-up trip today? Stripped down or fully loaded? It's your journey—do it your way.

SEATS & BACKRESTS  
WINDSHIELDS & WIND PROTECTION  
CARGO & STORAGE  
LIGHTS & ELECTRICAL ACCESSORIES



### U-STYLE

Personalization speaks volumes about who you are, and our custom accessories let you say it with added sophistication and style. Don't just embrace your inner self, make a statement.

WHEELS  
FENDERS  
CUSTOM ACCESSORIES  
DECALS



### U-PERFORMANCE

Unleash the untapped power and handling of your Can-Am Spyder with our performance-boosting accessories. Because freedom means you get to choose how you travel your road.

SHOCKS  
SILENCERS



# SPYDER F3 ACCESSORIES



AKRAPOVIČ STRAIGHT SHOT SILENCER 219400514



SHAD® SADDLEBAGS FOR CAN-AM 219400721



CANNONBALL SEAT 219400497

Let our customized versions of these Can-Am Spyder F3 serve as inspiration for creating your own! **How would you build yours?**

## F3-S SPEEDWAY INSPIRED LOOK



▶ Watch & learn more about all the featured accessories.  
Go to: [store.spyder.brp.com/video](https://store.spyder.brp.com/video)

### U-FUNCTION

- 1 AUXILIARY LIGHTS P. 71

### U-STYLE

- 2 LOW BROW FRONT FENDERS P. 74
- 3 SIGNATURE LIGHT P. 76
- 4 BOBBER KIT P. 75
- 5 15" BLADE MAG WHEELS P. 73

### U-PERFORMANCE

- 6 FOX FACTORY SERIES 1.5 PODIUM R FRONT SHOCKS (NOT VISIBLE ON THE IMAGE ABOVE) P. 78
- 7 AKRAPOVIČ SINISTER SILENCER P. 79
- 8 FOX ADJUSTABLE REAR SHOCK (NOT VISIBLE ON THE IMAGE ABOVE) P. 77

You're a click away from a custom Can-Am Spyder. Go to: [www.can-am.brp.com/spyder](https://www.can-am.brp.com/spyder) > Build & Price

## F3-S BREAK FREE INSPIRED LOOK



▶ Watch & learn more about all the featured accessories.  
Go to: [store.spyder.brp.com/video](https://store.spyder.brp.com/video)

### U-FIT

- 1 DRIVER FOOTBOARDS P. 61

### U-FUNCTION

- 2 BLUE RIDGE WINDSHIELD P. 64
- 3 SHAD SADDLEBAGS FOR CAN-AM P. 67
- 4 CANNONBALL SEAT P. 63
- 5 DETACHABLE DRIVER BACKREST P. 63
- 6 AUXILIARY LIGHTS P. 71
- 7 GARMIN ZUMO 590 GPS P. 72
- 8 GARMIN ZUMO GPS HOLDER P. 72

### U-PERFORMANCE

- 9 FOX FACTORY SERIES 2.0 PODIUM RC2 REAR SHOCK P. 78
- 10 AKRAPOVIČ STRAIGHT SHOT SILENCER (NOT VISIBLE ON THE IMAGE ABOVE) P. 79

You can finance all your accessories with the purchase and financing of your Can-Am Spyder F3. Ask your Can-Am Spyder dealer for all the details.

Looking to personalize your Spyder F3 Limited?  
Here is one of countless possibilities.

## F3 LIMITED WEEKEND ESCAPE INSPIRED LOOK



## F3-T URBAN CRUISER INSPIRED LOOK

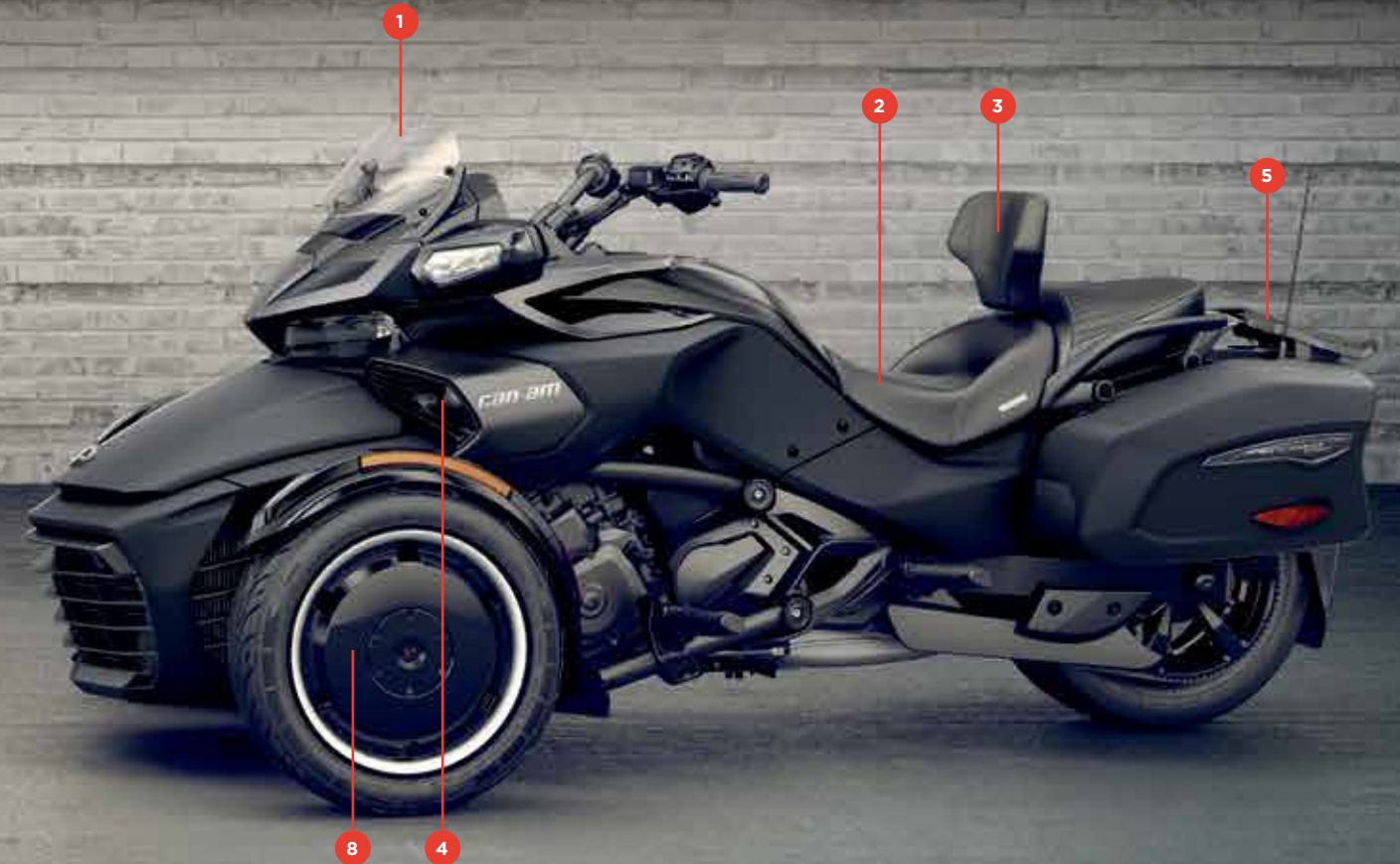

▶ Watch & learn more about all the featured accessories.  
Go to: [store.spyder.brp.com/video](https://store.spyder.brp.com/video)

▶ Watch & learn more about all the featured accessories.  
Go to: [store.spyder.brp.com/video](https://store.spyder.brp.com/video)

### U-FUNCTION

- |                              |       |                                  |       |
|------------------------------|-------|----------------------------------|-------|
| 1 AUXILIARY LIGHTS           | P. 71 | 6 DELUXE SADDLEBAGS LINERS       | P. 68 |
| 2 TALL BOY WINDSHIELD        | P. 65 | (NOT VISIBLE ON THE IMAGE ABOVE) |       |
| 3 PASSENGER ARMRESTS         | P. 63 | 7 TOP CASE INNER BAG             | P. 69 |
| 4 TOP CASE RACK              | P. 69 | (NOT VISIBLE ON THE IMAGE ABOVE) |       |
| 5 DETACHABLE DRIVER BACKREST | P. 63 |                                  |       |

### U-PERFORMANCE

- |                                       |       |                                  |        |
|---------------------------------------|-------|----------------------------------|--------|
| 8 FOX ADJUSTABLE FRONT SHOCKS         | P. 77 | 10 TRAILER HITCH                 | P. 112 |
| (NOT VISIBLE ON THE IMAGE ABOVE)      |       | (NOT VISIBLE ON THE IMAGE ABOVE) |        |
| 9 AKRAPOVIČ SPORT TOURING 3C SILENCER | P. 79 |                                  |        |

### TRAILER

- 10 TRAILER HITCH (NOT VISIBLE ON THE IMAGE ABOVE)

### U-FUNCTION

- |                              |       |                                  |       |
|------------------------------|-------|----------------------------------|-------|
| 1 LOW BOY WINDSHIELD         | P. 65 | 6 DELUXE SADDLEBAGS LINERS       | P. 68 |
| 2 VINYL COAST-TO-COAST SEAT  | P. 62 | (NOT VISIBLE ON THE IMAGE ABOVE) |       |
| 3 DETACHABLE DRIVER BACKREST | P. 63 | 7 FRONT CARGO BAG                | P. 68 |
| 4 AUXILIARY LIGHTS           | P. 71 | (NOT VISIBLE ON THE IMAGE ABOVE) |       |
| 5 REAR TAIL RACK             | P. 70 |                                  |       |

### U-STYLE

- 8 15" BONNEVILLE DISH WHEELS P. 73

### U-PERFORMANCE

- 9 AKRAPOVIČ SPORT TOURING 3C SILENCER (NOT VISIBLE ON THE IMAGE ABOVE) P. 79

You're a click away from a custom Can-Am Spyder. Go to: [www.can-am.brp.com/spyder](https://www.can-am.brp.com/spyder) > Build & Price

You can finance all your accessories with the purchase and financing of your Can-Am Spyder F3. Ask your Can-Am Spyder dealer for all the details.



# YOUR CAN-AM SPYDER. YOUR FIT.

All Spyder F3 models feature our exclusive UFit system so you can customize an exact fit based on your height or preferred riding style. Choose from five footpeg positions and five handlebar options to optimize your fit and comfort. Find your perfect Spyder fit at [UFITSYSTEM.COM](http://UFITSYSTEM.COM) or visit your dealer to test drive and ask about the showroom fit tool.

## CHOOSE FROM 5 HANDLEBAR OPTIONS

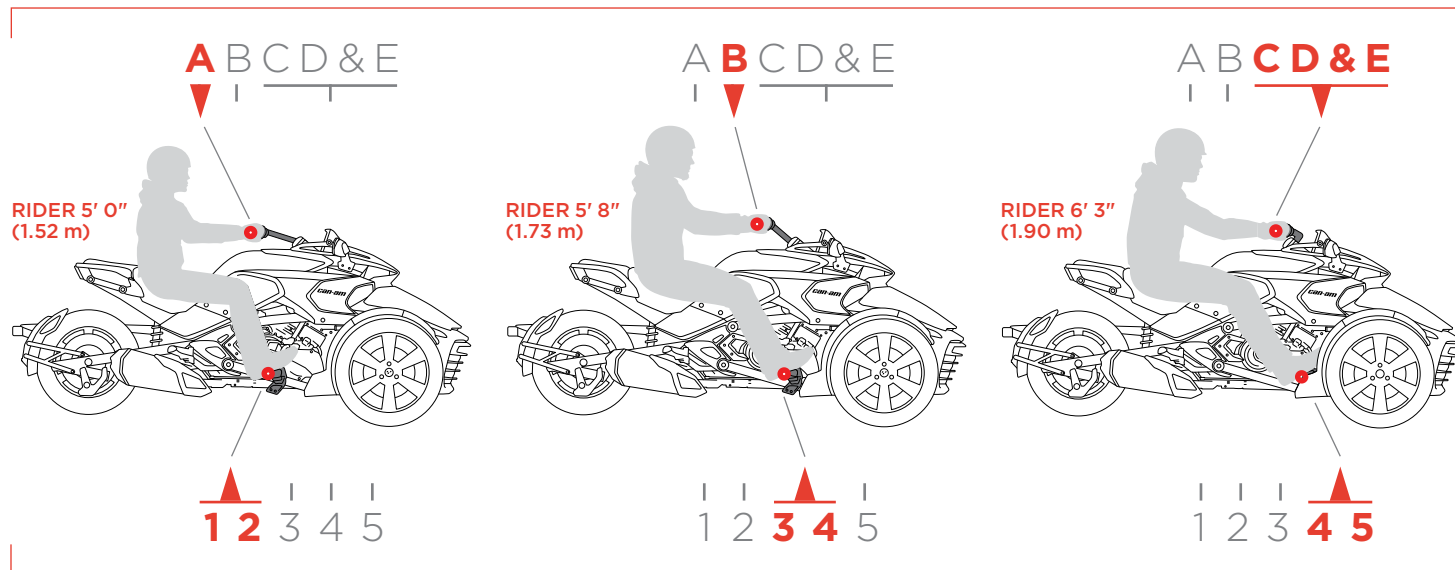

## CHOOSE FROM 5 FOOTPEG POSITIONS



## HANDLEBARS U-FIT SYSTEM

### SHORT REACH HANDLEBAR · POSITION A

- Part of the UFit System.
- Perfect for shorter riders with pegs positions 1 or 2.

All Spyder F3 models

- 219400545 · Chrome (Clamp Kit included) **\$449.99**
- 219400546 · Carbon Black **\$149.99**



### STOCK HANDLEBAR · POSITION B

- Part of the UFit System.
- Same shape and reach as the stock handlebar with a chrome finish.
- Fits best with pegs positions 3 or 4.

All Spyder F3 models

- 219400547 · Chrome (Clamp Kit included) **\$449.99**



### LONG REACH HANDLEBAR · POSITION C

- Part of the UFit System.
- The longer reach causes the torso to lean forward, bringing the riding position closer to the console.
- Perfect for taller riders with pegs positions 4 or 5.

All Spyder F3 models

- 219400548 · Chrome (Clamp Kit included) **\$449.99**
- 219400549 · Carbon Black **\$149.99**



### ATTITUDE HANDLEBAR · POSITION D

- Part of the UFit System.
- The shape has an impact on the driving position, leaning the torso towards the console and tilting the arm and wrist position.
- Perfect for taller riders with pegs positions 4 or 5.

All Spyder F3 models

- 219400550 · Chrome (Clamp Kit included) **\$449.99**
- 219400551 · Carbon Black **\$149.99**



### DRAG BAR · POSITION E

- Part of the UFit System.
- Race-inspired straight bar is wide and more forward for a more aggressive riding position or tall drivers.
- Perfect for taller riders with peg position 5.

All Spyder F3 models

- 219400646 · Chrome (Clamp Kit included) **\$499.99**
- 219400594 · Carbon Black **\$299.99**





**BRAKE & SHIFTER LINKAGES**



**BRAKE & SHIFTER LINKAGES**

- Part of the UFit System.
- Find the best driving position for you.
- Replace stock linkage to set pegs to different positions.

**All F3 SE6 models**

- 2 · Position 1 · 219400561
- 1 · Position 2 · 219400563
- +1 · Position 4 · 219400566
- +2 · Position 5 · 219400571

**\$29.99**

**All F3 SM6 models**

- 2 · Position 1 · 219400560
- 1 · Position 2 · 219400562
- +1 · Position 4 · 219400564
- +2 · Position 5 · 219400565

**\$49.99**



**FOOTBOARDS**



**DRIVER FOOTBOARDS**

- Replace stock pegs for additional comfort.
- Come with rubber pads and mounting hardware.
- Can be positioned with the UFit System.

**All Spyder F3 models**

■ 219400572 · Chrome

**\$549.99**

■ 219400529 · Carbon Black

**\$449.99**



**PASSENGER FOOTBOARDS**

- Replace stock pegs for additional comfort.
- Come with rubber pads and mounting hardware.

**All Spyder F3 models**

■ 219400716 · Chrome

**\$399.99**

■ 219400715 · Carbon Black

**\$299.99**





## U-FUNCTION

### SEATS & BACKRESTS



#### **NEW** LEATHER COAST-TO-COAST SEAT

- Genuine stitched-leather\* seat.
- Passenger and driver seats rain cover included.
- Installs in seconds and works with both driver and passenger backrests.
- Long-distance comfort based on our renowned coast-to-coast seat design.
- Wide, well-shaped and generously padded driver and passenger seats deliver enough comfort for a coast-to-coast ride.

\* Natural leather fades and wrinkles over time. Allow to air-dry when wet, apply leather-conditioning oil to maintain appearance. Clean with warm water, mild soap and a soft cloth. Use the included seat cover to keep your seat looking new longer.

All Spyder F3 models

■ 219400656 - Tan

**\$899.99**



#### VINYL COAST-TO-COAST SEAT

- Long-distance comfort based on our renowned coast-to-coast design.
- Wide, well-shaped and generously padded driver and passenger seats deliver enough comfort for a coast-to-coast ride.
- Installs in seconds and works with both driver and passenger backrests.

All Spyder F3 models

■ 219400602 - Black

**\$799.99**



#### **NEW** PASSENGER ARMRESTS

- Adjusts upwards, downwards, forwards, backwards, and outwards.
- Arm height provides up to 20 mm vertical adjustment.
- Fully-compatible with RAM® cup holder.
- Complete with grip for added passenger security.
- Top Case not required for installation or use.
- Recommended to install with Top Case (219400732) or Passenger Backrest (219400797 or 219400703).
- Top Case European version - 219400772.

All Spyder F3 models

■ 219400726 - Black

**\$449.99**



#### ADJUSTABLE PASSENGER BACKREST

- Dual axis adjustments for the backrest and cushion enable you to dial-in comfort and add up to 2" (50 mm) more passenger room.

Spyder F3, F3-S, F3-T

■ 219400601 - Carbon Black

**\$749.99**



#### DETACHABLE DRIVER BACKREST

- Generous width and height for superior lumbar support.
- Installs and removes in minutes.
- Tilt adjustable.
- Fits on production, Cannonball, Vinyl Coast-to-Coast and Leather Coast-to-Coast seats.
- Anti-theft feature.

All Spyder F3 models

■ 219400498 - Black

**\$459.99**



#### CANNONBALL SEAT

- 2-piece driver and passenger seats.
- Installs in minutes.
- Designed with additional padding, larger support areas and integrated comfort rear pad.
- Distinctive high-end stitching pattern.
- Driver backrest ready.

All Spyder F3 models

■ 219400497 - Black

**\$819.99**



#### DETACHABLE PASSENGER BACKREST

- Generous width and height for superior lumbar support.
- Initial installation in minutes, toolless removal in seconds.
- Anti-theft feature.
- Fits on production, Cannonball, Vinyl Coast-to-Coast and Leather Coast-to-Coast seats.
- Invisible mounting system unrecognizable when not installed.

Spyder F3, F3-S, F3-T

■ 219400703 - Black

**\$559.99**



#### PASSENGER SHORT RAIL

- Sporty looking short passenger comfort rear pad.
- Installs in minutes.
- Fits on production, Vinyl Coast-to-Coast and Leather Coast-to-Coast seats.

Spyder F3, F3-S, F3-T

■ 219400580 - Black

**\$359.99**



Can-Am Spyder accessories are subject to the same rigorous physical testing requirements as the vehicles.



## WINDSHIELDS & WIND PROTECTION

### GAUGE SPOILER

- Enhances the sporty look of the Can-Am Spyder F3.
- Made of injected tinted polycarbonate.

Spyder F3, F3-S

219400531 · Smoke

**\$169.99**

### WINDSHIELD TRIM KIT

- Dresses up accessory windshield kits with chrome center trim.
- Looks great with Windshield Trims (219400355).

Fits with Tall Boy Windshield (219400596) and Low Boy Windshield (219400504)

219400698 · Chrome

**\$29.99**



### BLUE RIDGE WINDSHIELD

- Made of clear 4.5 mm polycarbonate.
- Comes complete with supports and hardware.

Spyder F3, F3-S

219400746 · Clear

**\$409.99**

### ROUTE 129 WINDSHIELD

- Sport windshield.
- Made of 4.5 mm polycarbonate.
- Provides lower body protection.
- Comes complete with supports and hardware.

Spyder F3, F3-S

219400747 · Clear

**\$359.99**

### TALL BOY WINDSHIELD

- Mid-height windshield.
- Scratch and UV-resistant hardcoat on 5 mm polycarbonate shield.
- Windshield supports included.

Spyder F3-T, F3 Limited

219400596 · Clear

**\$399.99**

### LOW BOY WINDSHIELD

- Sporty low windshield.
- Scratch and UV-resistant 4.5 mm polycarbonate shield mounts on the stock supports.

Spyder F3-T, F3 Limited

219400504 · Smoke

**\$199.99**

# SHAD

FOR *can-am*

BRP partners with SHAD, a recognized leader in the manufacture of high-advanced motorsport bags and storage accessories.

Their designs are known to be the state-of-the-art, totally functional and of first class quality, which have earned them the prestigious international "Red Dot: Best of the Best" award in 2015.

## CARGO & STORAGE



### NEW SHAD SADDLEBAGS FOR CAN-AM

- Patented lightweight bike-specific design.
- 3-point mount.
- Waterproof, shock resistant.
- 9.5 US gallons capacity (36 L).
- Enough room for a 2XL full face helmet equipped with a communication system.
- Unique Can-Am reflector.
- Required mounting support and hardware are sold separately (219400728).
- Required mounting support for Europe (219400727).

Spyder F3, F3-S

219400721 - Black

\$469.99

### NEW SHAD SADDLEBAGS F3 RACK

(Not illustrated)

- Custom rack specially designed for mounting SHAD Saddlebags (219400721).
- Integrated red reflectors and necessary hardware for SHAD Saddlebags.

Spyder F3, F3-S

219400728 - Black

219400727 - Black - Europe (Amber reflector) EC compliant

\$249.99



### NEW SHAD SADDLEBAGS LINERS

- Designed expressly for SHAD Saddlebags (219400721) to provide extra convenience.
- Include integrated carrying handle and a shoulder strap.
- Sold in pairs.

Spyder F3, F3-S

219400731 - Black

\$94.99



### NEW SHAD REAR SEAT BAG

- 100% waterproof 3-layer (PVC-Nylon-PVC) design that's tear and abrasion resistant.
- 7.4 US gallons capacity (28 L).
- Foam-lined inner compartment for laptop or other valuables.
- Includes attachment straps.
- Converts to backpack, complete with chest strap.

All Spyder models

219400730 - Black

\$129.99



### NEW SHAD BACKPACK E-83

- Semi-rigid exterior.
- Secure storage in 2 zippered main compartments.
- Zippered inner pocket with padded compartments.
- Adjustable waist and chest straps.
- Cushioned carry handle.
- Cover for any helmet size. Adjustable to backpack with 4 metal buckles.

219400729 - Black

\$149.99



**CROSS-COUNTRY DETACHABLE SADDLEBAGS**

- Add a total of 13 US gallons (50 L) of storage space.
- Finished in high-end vinyl and with a metal chrome side hinge.
- Water-resistant and top loading, lockable with key.
- Toolless installation and removable in seconds after initial installation.
- Brackets are invisible when bags are not on.
- Bolts 250000869 needed to install 2015 Cross-Country Detachable Saddlebags (219400492 and 219400590 (EC)) on 2016 models.

**Spyder F3, F3-S**  
 ■ 219400696 - Black  
 ■ 219400697 - Black - Europe (Amber light) - EC compliant  
**\$1,330.99**



**DELUXE SADDLEBAGS LINERS**

- Complete your production saddlebags with Deluxe Saddlebags liners.
- The easiest way to carry your items from your Can-Am Spyder saddlebags, with integrated handle.

**Spyder F3-T, F3 Limited**  
 ■ 219400606 - Black  
**\$99.99**



**CROSS-COUNTRY SADDLEBAGS LINERS**

- Soft travel bags for use inside the Cross-Country Detachable Saddlebags (219400696, 219400697 EC).
- Integrated handle for easy transport.
- Sold in pairs.

**Spyder F3, F3-S**  
 ■ 219400609 - Black  
**\$69.99**



**FRONT CARGO BAG**

- Easy way to organize and tote your items in the front cargo compartment.
- Slides in and out with integrated handle and shoulder strap.

**All Spyder F3 models**  
 ■ 219400631 - Black  
**\$89.99**

**LOCK KIT FOR CROSS-COUNTRY DETACHABLE SADDLEBAGS**

- (Not illustrated)
- Replacement lock and key for Cross-Country Detachable Saddlebags (219400696), Cross-Country Detachable Saddlebags for Europe - 219400697 (EC).

**Spyder F3, F3-S (service kit)**  
 219400737  
**\$95.99**



**NEW TOP CASE WITH INTEGRATED PASSENGER BACKREST**

- Fits up to 2 full face 2XL helmets including communication system.
- Integrated passenger backrest.
- Protective rubber carpet-lined bottom.
- Quick installation and removal.
- Optional vehicle color matching side panels available.
- Available April 2017.

**Spyder F3-T with Top Case, F3 Limited 2016**  
 ■ 219400732 - Black  
 ■ 219400772 - Black - Europe - EC certified  
**\$1,499.99**



**NEW TOP CASE PANEL KIT**

- Vehicle-matched top case side panels.
- Available April 2017.

**Spyder F3-T with Top Case**  
 ■ 219400758 - Steel Black Metallic ■ 219400760 - Intense Red Pearl  
 ■ 219400759 - Pearl White ■ 219400761 - Pure Magnesium  
**\$199.99**



**NEW TOP CASE INNER BAG**

- Maximizes top case volume.
- Complete with integrate handle and shoulder strap for convenient portability.

**Spyder F3-T with Top Case, F3 Limited 2017**  
 ■ 219400748 - Black  
**\$129.99**



**NEW TOP CASE SPEAKERS AMPLIFIER KIT**

- (Not illustrated)
- Amplifier kit is required to play music through top case speakers.
- Connects to the standard front audio system.
- Includes amp harness and hardware.
- Top Case with Integrated Passenger Backrest (219400732) is required.

**Spyder F3-T with Top Case**  
 219400769  
**\$299.99**



**NEW TOP CASE RACK**

- Allows for added external storage capacity when used with netting or bungee cords.
- Sturdy stamped-aluminum construction.
- Includes integrated anchor points.

**Spyder F3-T with Top Case, F3 Limited 2017**  
 ■ 219400743 - Black  
**\$199.99**



**NEW REAR TAIL RACK**

- Robust monobloc cast-aluminum construction.
- Ideal for stowing soft bags, tents, or sleeping bags.
- Includes convenient integrated anchor points.
- Bolts securely to the vehicle frame.

**Spyder F3-T, F3 Limited 2016**

■ 219400645 - Black

**\$199.99**



**F3 MONO SEAT COWL**

- High quality injection-molded part.
- Pops into passenger seat space in seconds.
- Transforms your vehicle into sporty solo configuration.
- Adds 1.25 US gallons (4.73 L) of lockable water-resistant storage.

**Spyder F3, F3-S**

■ 219400494 - Steel Black Metallic

**\$359.99**



**URBAN RACK**

- Solid aluminum construction offering 0.9 US gallon (3.37 L) of water-resistant storage.
- Comes with net to allow users to strap additional luggage on top.
- Pops into passenger seat space in seconds.
- Anti-theft feature.

**Spyder F3, F3-S**

■ 219400493 - Carbon Black

**\$409.99**



**LIGHTS & ELECTRICAL ACCESSORIES**



**AUXILIARY LIGHTS**

- Halogen fog lamps.
- Enhance low beam light for better visibility.
- Plug-and-play with stock harness.

**All Spyder F3 models**

219400511

**\$509.99**

- Integrated ON/OFF switch.
- Not EC compliant.
- Not compatible with European vehicles.



**HEATED DRIVER GRIPS**

- Complete heating kit with one intensity setting.
- Easy installation.
- Integrated ON/OFF switch.

**Spyder F3, F3-S, F3-T**

■ 219400509 - Black

**\$219.99**



**NEW CGX2 CAMERA BY CYCLOPS GEAR**

- Capture your Can-Am Spyder moments with this 4K HD and 1080p at 60fps action camera.
- 2" LCD display screen.
- Comes with Class 10 32GB micro SD card and 9 mounts.
- Wi-Fi available to control your camera from your smart phone or tablet with the free i-Cyclops App for iOS and Android.
- Waterproof housing good for use up to 50 m underwater, plus a 2.4gh waterproof remote.

2866860090  
**\$299.99**



**F3-T FRONT RADIO SYSTEM**

- Upgrades sound, 2 woofers speakers and 2 mids (4X20 watts), USB plugs, aerial and hardware included.

**Spyder F3-T, F3 Limited 2016**  
 219400680  
**\$929.99**



**POWER OUTLET KIT**

- Recharges your electronic devices while riding (smartphone, MP3, heating gear, etc.).
- Dual port USB connectors (219400510).
- Plug-and-play kit.
- Simply connect under driver seat and use.

**Spyder RT, RS, ST, F3, F3-S**  
 219400510 - USB

· Conveniently located in front cargo bin.  
**Spyder RT, RS, ST, all Spyder F3 models**  
 219400366 - 12V  
**\$34.99**



Zumo 590 has the ability to link itself wirelessly to optional Garmin tire pressure sensors and the Garmin Virb video camera for enhanced GPS functionality.

**GARMIN' ZUMO' 590 GPS**

- Features a glove-friendly and sunlight-readable 5" (12.7 cm) dual-orientation touchscreen display.
- Offers hands-free phone control and spoken directions heard in-helmet via Bluetooth® 5 technology.
- Includes a MP3 player.
- iPod® and Pandora® compatibility.
- Allows control of music right on the display.
- Rugged and tough enough to withstand fuel spills, UV rays and harsh weather.
- Offers access to real-time weather and traffic information via the smartphone link app.
- Free lifetime map updates.
- Curvy Roads Routing allows rider to find winding roads.
- GPS Holder (219400681) sold separately.

**All Spyder models**

219400512  
 219400699 - Europe

**\$749.99**

**GARMIN ZUMO GPS HOLDER**

- Positions Garmin Zumo GPS on the center of all UFit System handlebars.
- Wiring/charging harness included.

**All Spyder F3 models**

219400681 - Black  
**\$249.99**



**NEW GARMIN ZUMO GPS HOLDER (WITHOUT HARNESS)**

(Not illustrated)

**All Spyder F3 models**

219400718  
**\$174.99**

**BOLTS KIT FOR GPS HOLDER**

(Not illustrated)

- Required to fit Garmin Zumo GPS Holder (219400718) on Drag Bars (219400646, 219400594).

**All Spyder F3 models**

219400655  
**\$19.99**



**GPS HOLDER**

- Sits high on right side handlebar for optimum visibility.
- Multidirectional adjustment to prevent sunglare and adapts to any rider.
- Harness included.

**All Spyder F3 models**

219400749  
**\$219.99**

**NEW GPS HOLDER (WITHOUT HARNESS)**

(Not illustrated)

**All Spyder F3 models**

219400717  
**\$189.99**



**U-STYLE**

**WHEELS**

**15" SHAMROCK WHEELS**

- Add personality to your Can-Am Spyder.
- Casted, painted and machined wheels.
- Sold in pairs.

**Spyder RT, RS, ST 2013 and up, all Spyder F3 models**

■ 219400500 - Deep Black  
**\$609.99**



**15" FAT 6 CHROME WHEELS**

- Same design as Spyder F3 production wheels in PVD finish.
- Sold in pairs.

**Spyder RT, RS, ST 2013 and up, all Spyder F3 models**

■ 219400589 - Chrome  
**\$719.99**



**CHROME REAR WHEEL**

- 6-spoke PVD – chrome-like powder-coat, more resistant than regular chrome – monobloc rear wheel (hub and wheel in one piece).

**Spyder RT, RS, ST 2013 and up, all Spyder F3 models**

■ 219400574 - Chrome  
**\$659.99**



**15" BONNEVILLE DISH WHEELS**

- Give your Can-Am Spyder a retro look with these 15" wheels inspired by Salt Flat racers.
- Wheel nuts are hidden behind the center cap.
- Sold in pairs.

**Spyder RT, RS, ST 2013 and up, all Spyder F3 models**

■ 219400501 - Black  
**\$599.99**



**15" BLADE MAG WHEELS**

- Unidirectional design (left and right wheel).
- Patented casting process allows a weight reduction of 2.2 lbs (1 kg) per wheel compared to stock wheels.
- Sold in pairs.

**Spyder RT, RS, ST 2013 and up, all Spyder F3 models**

■ 219400465 - Black  
**\$659.99**



**15" BLADE MAG WHEELS SERVICE KIT**

(Not illustrated)

- Replacement "blade" for wheels.
- 219400542 - Left - Brushed Aluminum
- 219400543 - Right - Brushed Aluminum

**\$24.99**



FENDERS

CHOPPED REAR FENDER

- Sleek, short fender shows off the massive Spyder F3 rear tire.
- Street legal and includes license plate holder, LED light and required hardware.
- License plate holder not compliant outside North America.

Spyder F3, F3-S  
 219400597  
 Carbon Black  
 \$429.99



LOW BROW FRONT FENDERS

- Super sleek drawn steel fenders with LED position lights integrated into the front edge.
- Includes electrical harness and required hardware.
- Sold in pairs.
- LED position lights not EC homologated.

Spyder RT, RS, ST 2013 and up, all Spyder F3 models  
 219400502  
 Carbon Black  
 \$949.99



CUSTOM ACCESSORIES



NEW BOBBER KIT\*

- Everything needed to transform a 2-up into a 1-up.
- Seat, rear fender, tail light assembly, footrest trim, license plate support, and all necessary hardware included.
- Can also accommodate any production or accessory seat.

\* - A bobbed tail increases the amount of projection from the rear tire versus a traditional fender.  
 - Laws vary state to state regarding rear fender tire coverage compliance. Please obey all applicable laws and regulations.

Spyder F3, F3-S  
 219400640 - Black  
 219400745 - Black - Europe - EC compliant  
 (Doesn't include rear fender and licence plate support.)  
 \$799.99



A bobber, originally called a 'bob-job' from the 1930s through 1990s, is a style of custom motorcycle. The typical construction includes stripping excess bodywork from a motorcycle, and shortening the rear fender, which is "bobbed" (as in bob-tail)



SUPER SPORT GRILLE

- Adds an even more muscular look with this honeycomb-styled front grille with integrated front splitter.

All Spyder F3 models  
 219400595 - Black / Can-Am Red  
 \$349.99

PULLEY COVER

- Replaces the stock plastic PTO (drive pulley) cover with a genuine chrome cover.

All Spyder F3 models  
 219400557 - Chrome  
 \$199.99



TMC COVER

- Replaces the stock plastic TMC (master cylinder) cover with a genuine chrome cover.

All Spyder F3 models  
 219400559 - Chrome  
 \$209.99





**SIGNATURE LIGHT**

- Creates an unmistakable, distinctive look.
- No switch, automatically turns on.
- Includes required wiring and hardware for Spyder F3 2016 models and up.
- Not EC compliant.

All Spyder F3 models

219400599 - White

\$169.99

**SIGNATURE LIGHT - 2015 ADAPTER KIT**

- (Not illustrated)
- Wiring harness required for installing Signature Light (219400599) on 2015 models.
  - Allows the light to automatically illuminate when the engine is running.
  - LED lights.

Spyder F3, F3-S 2015

219400636 - Black

\$39.99



**HANDLEBAR END CAPS**

- Sold in pairs.

All Spyder models

219400702 Chrome

\$41.99



**FRAME CAPS**

- Add a little bling to the frame of your vehicle.
- 4 frame caps per pack.

All Spyder F3 models

219400555 - Chrome

\$129.99



**DECALS**



**HOOD STRIPES DECAL KIT**

- Adds personality to your Can-Am Spyder F3.

All Spyder F3 models

219400711 - Can-Am Red

219400714 - Gloss White

219400713 - Matte Black

219400712 - Satin Silver

\$79.99



**F3 MONO SEAT COWL STRIPES DECAL KIT**

- Premium decals complement Hood Stripes Decal Kit.

Spyder F3, F3-S

219400661 - Can-Am Red

219400662 - Gloss White

219400663 - Matte Black

219400664 - Satin Silver

\$59.99



**REAR TAIL STRIPES DECAL KIT**

- Premium decals complement Hood Stripes Decal Kit.

Spyder F3-T, F3 Limited 2016

219400665 - Can-Am Red

219400666 - Gloss White

219400667 - Matte Black

219400668 - Satin Silver

\$49.99



**U-PERFORMANCE**

**SHOCKS**



**NEW FOX® ADJUSTABLE FRONT SHOCKS**

- Features spring-adjustable preload and wide-range externally-adjustable rebound damping for an infinite array of tuning options made to suit any riding style.
- Whether it's smooth cruising or twisting down your favorite winding road they deliver exceptional performance, comfort, and a superior quality ride.

Spyder F3-T, F3 Limited

219400733

\$849.99



**NEW FOX ADJUSTABLE REAR SHOCK**

- FOX Factory Series rear shock delivers an infinite range of set-up options.
- Anodized lightweight 6061-T6 aluminum body provides enhanced reliability and excellent performance.

Spyder F3, F3-S

219400734

\$649.99





FOX shocks have been an industry leader in high-performance shocks and racing suspensions for over 30 years.

**FOX FACTORY SERIES 1.5 PODIUM<sup>®</sup> R FRONT SHOCKS**

- Featuring spring-adjustable preload and a wide range of externally adjustable rebound damping, the PODIUM R shocks provide an infinite array of tuning options to comfortably suit your riding style.
- Whether you're out for a mellow cruise or enjoying your favorite twisty route, the PODIUM R shocks will deliver superb performance, great comfort, and an overall quality ride.

**Spyder F3, F3-S**  
219400515  
**\$849.99**



**FOX FACTORY SERIES 2.0 PODIUM RC2 REAR SHOCK**

- Provides an infinite range of options for the perfect set-up.
- Its anodized 6061-T6 aluminum body and remote aluminum reservoir make the lightweight PODIUM RC2 shock a reliable and awesome performer.

**Spyder F3, F3-S**  
219400577  
**\$969.99**



**NEW AUTOMATIC REAR AIR SUSPENSION KIT**

- Automatic suspension assures a smooth, comfortable ride.
- Includes air compressor and all required hardware.

**Spyder F3-T, F3 Limited**  
219400738  
**\$469.99**



**NEW OCCASIONAL 2-UP REAR SHOCK**

- Weight-bearing capacity designed for occasional 2-up use.

**Spyder F3, F3-S**  
219400739  
**\$199.99**



**SILENCERS**



Akrapovič was established in 1990 by Slovenian racer Igor Akrapovič who had found that during his racing career there was a distinct lack of high-quality exhaust systems on the market to the public.



**NEW AKRAPOVIČ SINISTER SILENCER**

- 3-outlet design exclusive to Can-Am.
- Finished in bold flat black carbon & stainless steel.
- Unique Akrapovič growl.
- Akrapovič Sinister Silencer Heatshield Replacement Kit available (219400766).
- Not AS certified.

**Spyder F3, F3-S**  
219400701 · Black  
**\$1,099.99**



**AKRAPOVIČ STRAIGHT SHOT SILENCER**

- Premium chromed stainless steel shell construction, end cap and heat shields.
- Not AS certified.

**Spyder F3, F3-S**  
219400514 · Chrome  
**\$1,119.99**



**AKRAPOVIČ SPORT TOURING 3C SILENCER**

- Set your ride apart with the dynamic, deep resonant sound of an Akrapovič silencer.
- Its premium titanium and carbon fiber construction is 55% lighter than stock model and it's been tested to meet the most stringent requirements.
- Not AS certified.

**Spyder RT 2016, F3-T, F3 Limited**  
219400650 · Titanium · Can / US  
219400442 · Titanium · Other countries  
**\$999.99**

**UPGRADE YOUR GROWL**

**AKRAPOVIČ SILENCERS TOP FEATURES**

- Deeper, more guttural sound than stock silencer.
- Meet the most stringent standards - EPA, CARB & EC certified.
- Maintain vehicle warranty requirements.
- Easy installation.
- Exhaust fit compatible with all BRP genuine accessories.

# SPYDER RT ACCESSORIES

# RT



AKRAPOVIČ SPORT TOURING 3C SILENCER 219400650 / OUTSIDE NORTH AMERICA: 219400442



TRI AXIS ADJUSTABLE HANDLEBAR 219400414



ADJUSTABLE DRIVER BACKREST FOR COMFORT SEAT 219400689

There are a thousand ways to trick out a Spyder RT.  
Take a look at ours and let your imagination run wild.

## RT LIMITED HIGHWAY MASTER INSPIRED LOOK



▶ Watch & learn more about all the featured accessories.  
Go to: [store.spyder.brp.com/video](https://store.spyder.brp.com/video)

### U-FIT

1 TRI AXIS ADJUSTABLE HANDLEBAR P. 84

### U-FUNCTION

2 ADJUSTABLE VENTED WINDSHIELD P. 86  
3 ADJUSTABLE SIDE WIND DEFLECTORS P. 87  
4 COMFORT SEAT P. 85  
5 ADJUSTABLE DRIVER BACKREST FOR COMFORT SEAT P. 85

6 BLUETOOTH DONGLE FOR AUDIO SYSTEM (NOT VISIBLE ON THE IMAGE ABOVE) P. 90  
7 GPS SUPPORT FOR TRI AXIS ADJUSTABLE HANDLEBAR (NOT VISIBLE ON THE IMAGE ABOVE) P. 90

### U-PERFORMANCE

8 AKRAPOVIČ SPORT TOURING 3C SILENCER P. 97

### TRAILER

9 TRAILER HITCH KIT AND CONTROL MODULE (NOT VISIBLE ON THE IMAGE ABOVE) P. 112

## RT-S COAST-TO-COAST ADVENTURE INSPIRED LOOK



▶ Watch & learn more about all the featured accessories.  
Go to: [store.spyder.brp.com/video](https://store.spyder.brp.com/video)

### U-FUNCTION

1 LOW WINDSHIELD KIT P. 86  
2 COMFORT SEAT P. 85  
3 ADJUSTABLE DRIVER BACKREST FOR COMFORT SEAT P. 85

### U-STYLE

4 15" RT FRONT WHEELS P. 93  
5 LOW BROW FRONT FENDERS P. 93

You're a click away from a custom Can-Am Spyder. Go to: [www.can-am.brp.com/spyder](https://www.can-am.brp.com/spyder) > Build & Price

You can finance all your accessories with the purchase and financing of your Can-Am Spyder RT. Ask your Can-Am Spyder dealer for all the details.



## U-FIT

### HANDLEBARS

#### TRI AXIS ADJUSTABLE HANDLEBAR

- State-of-the-art adjustable handlebar reduces fatigue and delivers comfort for all riders thanks to unlimited adjustment possibilities.
- Three different axes allow you to adjust the handlebar in terms of height, width and arm distance.
- Left and right bars are linked together and rotate simultaneously during adjustment.
- Easy Allen key adjustment system.
- Handlebar reuses existing production handgrips, comodo, electrical and clutch cables, and sits directly on the stock steering column.
- GPS Support for the Tri Axis Adjustable Handlebar (219400616) sold separately.

#### Spyder RT

219400344 - Carbon Black

\$659.99

219400414 - Chrome

\$824.99

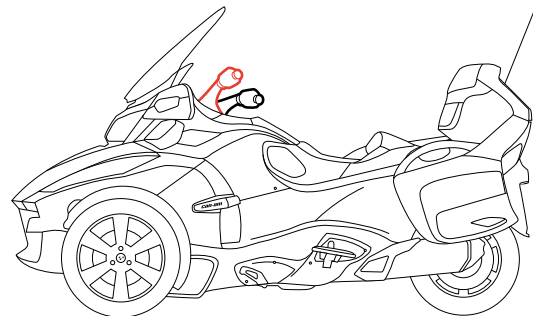

THREE DIFFERENT AXES ENABLE YOU TO ADJUST THE HANDLEBAR HEIGHT, WIDTH AND ARM DISTANCE.

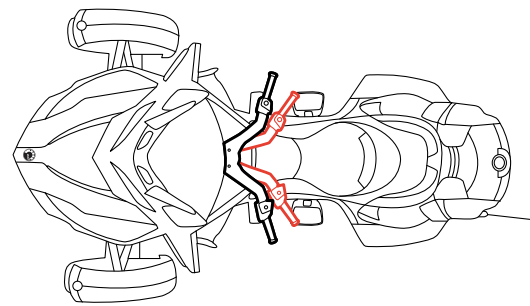

THE LEFT AND RIGHT SIDES OF THE BAR ARE LINKED SO THEY'RE ALWAYS IN SYNC.



## U-FUNCTION

### SEATS & BACKRESTS



Moving the driver's seat position back just two inches (50 mm) relaxes the knees and upper body.



#### COMFORT SEAT

- Ultra comfortable with lumbar support.
- Roomier for driver, improves comfort during long rides.
- Driver backrest ready.
- Perfect for taller riders.

#### Spyder RT

219400457 - Black

\$659.99



#### HEATED COMFORT SEAT

- Heated comfort seat with ability to slide in the driver backrest.
- The driver and passenger can choose their own heat intensity.
- Dual range Hi/Low heat setting.
- Activated through stock passenger and driver heated grip controls.

#### Spyder RT 2014 and up

219400398 - Black

\$919.99

#### ADJUSTABLE DRIVER BACKREST FOR PRODUCTION SEAT

- New tilt adjustment to suit your riding style.
- Unique patent pending plug-and-go design installs in seconds and works with all standard Spyder RT driver seats with no modifications.
- Folds forward for easy passenger seat access.

**Spyder RT 2014 and up, RT 2013 and prior with 2014 and up production seats**

219400679 - Black

\$449.99

#### ADJUSTABLE DRIVER BACKREST FOR COMFORT SEAT

- Tilt adjustment to suit your riding style.
- Unique patent pending plug-and-go design installs in seconds and works with Spyder RT driver Comfort Seats with no modification.
- Folds forward for easy passenger seat access.

**Fits with Comfort Seats: 219400457, 219400482, 219400483, 219400484**

**Fits with Heated Comfort Seats: 219400398, 219400485, 219400486, 219400487**

219400689 - Black

\$449.99

#### ADJUSTABLE DRIVER BACKREST SUPPORT - UPGRADE KIT

- Kit adds tilt adjustment to previous generation driver backrests.

**For Comfort seats**

219400682

**For production seats**

219400683

\$79.99





WINDSHIELDS & WIND PROTECTION

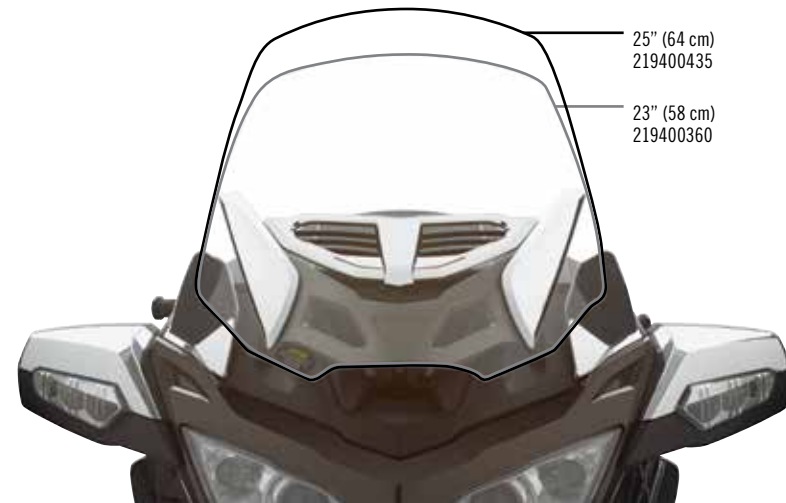

**ADJUSTABLE VENTED WINDSHIELD**

- Regulates driver frontal airflow.
- Integrated adjustable vent offers easy infinite management of horizontal slats from closed to fully opened.

**Spyder RT**  
 25" (64 cm) 23" (58 cm)  
 ■ 219400435 - Clear with chrome ■ 219400360 - Clear with chrome  
**\$409.99 \$359.99**

**VENTED WINDSHIELD**

- 2013-2014 standard windshield with openings.

**Spyder RT**  
 ■ 219400415 - Clear  
**\$309.99**



**LOW WINDSHIELD KIT**

**Spyder RT**  
 ■ 219400578 - Smoke  
**\$209.99**



YOUR CLIMATE CONTROL

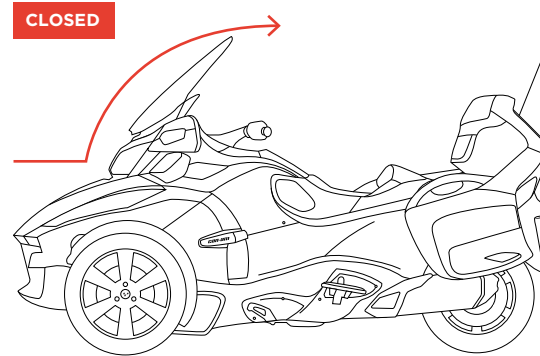
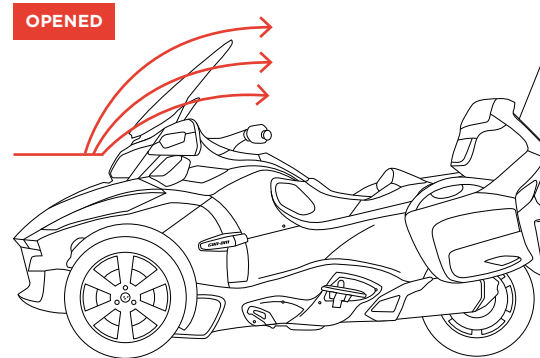

**ADJUSTABLE SIDE WIND DEFLECTORS**

- Regulate passenger and driver airflow.
- 3 preset positions (closed, parallel and inverted).
- Easy tool-less click adjustment.

**Spyder RT**  
 ■ 219400362 - Clear ■ 219400413 - Chrome  
**\$154.99 \$194.99**

3 ADJUSTABLE SIDE WIND DEFLECTORS PRESET POSITIONS

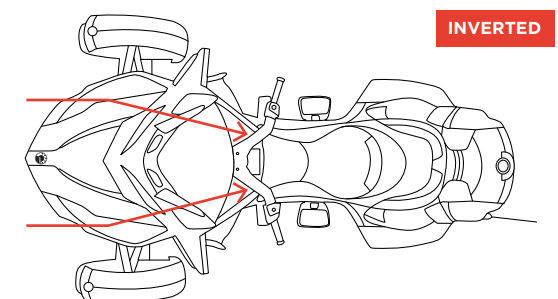
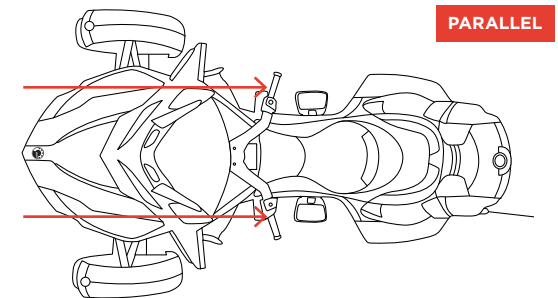
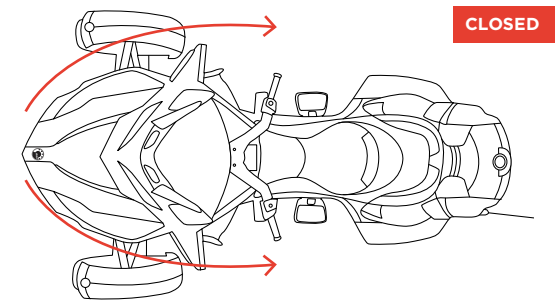

**TOURING WINDSHIELD**

- Lower and narrower design for riders looking for less wind protection than provided by the stock Spyder RT model.

**Spyder RT**  
 H 25" x W 24" (64 cm x 61 cm) H 23" x W 22" (58 cm x 56 cm)  
 ■ 219800199 - Clear ■ 219400243 - Clear  
**\$319.99 \$259.99**



## CARGO & STORAGE

### SEMI-RIGID REAR SIDE CARGO TRAVEL BAGS

- Stylish premium travel bags specifically sized to fit in rear side cargo.
- Retractable handle and shoulder straps for carrying convenience.
- Integrated pull tabs for effortless removal from cargo cavity.
- Sold in pairs.

**Spyder RT**  
 ■■■ 219400169 · Black  
**\$239.99**



### SEMI-RIGID REAR TOP CARGO TRAVEL BAG

- Stylish premium travel bag specifically sized to fit in rear top cargo.
- Retractable handle for carrying convenience.
- Integrated pull tabs for effortless removal from cargo cavity.

**Spyder RT**  
 ■■■ 219400168 · Black  
**\$109.99**



### TOP CASE MIRROR

- For rear top cargo cover.
- Folds open, locks up when not in use.
- Offers a small cargo in the top case lid.

**Spyder RT**  
 219400321  
**\$64.99**



### SOFT SIDE CARGO TRAVEL BAGS

- Soft travel bags that maximize Spyder RT rear side cargo space.
- Integrated handle for carrying convenience.
- Sold in pairs.

**Spyder RT**  
 ■■■ 219400172 · Black  
**\$59.99**



### SOFT REAR TOP CARGO TRAVEL BAG

- Soft travel bag designed to maximize rear top cargo space.
- Integrated handle for carrying convenience.
- Rear Top Cargo Shelf (219400232) recommended for installation.

**Spyder RT**  
 ■■■ 219400171 · Black  
**\$54.99**



### GLOVEBOX ORGANIZER

- Leather organizer for conveniently storing money, credit cards, cellphone, pen, important documents, etc.
- Slips easily in front center glovebox.

**Spyder RT**  
 ■■■ 708300459 · Black  
**\$44.99**



### SEMI-RIGID FRONT CARGO TRAVEL BAG

- Rolling travel bag designed to maximize available front cargo space.
- Can also double as airplane carry-on luggage.

**Spyder RT**  
 ■■■ 219400167 · Black  
**\$209.99**



### SOFT FRONT CARGO TRAVEL BAG

- Soft travel bag designed to maximize available front cargo space or stow in the Can-Am Freedom Trailer.
- Integrated handles for carrying convenience.
- Can also be used as a duffel bag.

**Spyder RT, Can-Am Freedom Trailer**  
 ■■■ 219400170 · Black  
**\$89.99**



### REAR TOP CARGO SHELF

- For supporting and organizing rear top cargo.
- Two recessed compartments to support electronic accessories.
- Can be tilted to facilitate access to lower section of cargo.

**Spyder RT**  
 ■■■ 219400232 · Black  
**\$54.99**



### FRONT CARGO LINER

- Felt insert provides finishing touch to front compartment.
- Features multiple storage pockets.
- Designed to integrate Front Cargo Light (219400623).

**Spyder RT 2012 and prior**  
 ■■■ 219400166 · Black  
**\$158.99**  
**Spyder RT 2013 and up**  
 ■■■ 219400368 · Black  
**\$134.99**



### FRONT CARGO LIGHT

- Light turns on as hood opens.

**Spyder RT**  
 219400623  
**\$49.99**



### TOP CASE MOLDED INSIDE LINER

- Felt insert for finishing touch to rear top cargo compartment.

**Spyder RT**  
 ■■■ 219400246 · Dark Grey  
**\$129.99**



**LIGHTS & ELECTRICAL ACCESSORIES**



**CELLPHONE INTERFACE KIT**

- Electrical harness tucked underneath vehicle allows you to communicate with your Bluetooth cellphone via your headset.
- Requires CB & Communication System (219400611), Entertainment Harness (219400610) and Garmin Zumo 590 GPS (219400512).

**Spyder RT 2011 and up**

219400390

**\$114.99**



**BLUETOOTH DONGLE FOR AUDIO SYSTEM**

- Allows a wireless Bluetooth connection between the vehicle's AM/FM radio (or any non-Bluetooth audio device) and the Bluetooth Communication System.
- Dual streaming to 2 Bluetooth headsets at the same time.
- Headset and AM/FM radio sold separately.

**Spyder RT, ST 2013 and up**

219400458

**\$259.99**



**GARMIN ZUMO 590 GPS**

- Features a glove-friendly and sunlight-readable 5" (12.7 cm) dual-orientation touchscreen display.
- Offers hands-free phone control and spoken directions heard in-helmet via Bluetooth 5 technology.
- Includes a MP3 player.
- iPod and Pandora compatibility.
- GPS Support sold separately (219400615/219400616).
- Allows control of music right on the display.
- Rugged and tough enough to withstand fuel spills, UV rays and harsh weather.
- Offers access to real-time weather and traffic information via the smartphone link app.
- Free lifetime map updates.
- Curvy Roads Routing allows rider to find winding roads.

**All Spyder models**

219400512

219400699 - Europe

**\$749.99**



**SATELLITE RADIO KIT**

- Receiver helps maintain radio reception everywhere.
- 150+ digital channels to choose from.
- 15 station presets for quickly tuning into your favorite programming.
- Plug-and-play system controlled via vehicle's cluster.
- Fee-based monthly subscription required.
- Entertainment Harness (219400610) required for installation.
- AM/FM Integrated Audio System (219400464) is also required for Spyder RT 2012 and prior.
- Headset sold separately.

**Spyder RT**

219400612

**\$479.99**



**NEW CGX2 CAMERA BY CYCLOPS GEAR**

- Capture your Can-Am Spyder moments with this 4K HD and 1080p at 60fps action camera.
- 2" LCD display screen.
- Comes with Class 10 32GB micro SD card and 9 mounts.
- Wi-Fi available to control your camera from your smart phone or tablet with the free i-Cyclops App for iOS and Android.
- Waterproof housing good for use up to 50 m underwater, plus a 2.4gh waterproof remote.

2866860090

**\$299.99**

**GPS SUPPORT FOR TRI AXIS ADJUSTABLE HANDLEBAR**

- Support for Garmin Zumo 590 GPS.
- Rotates to suit multiple adjustable handlebar settings.
- Includes casting, electric harness, rubber boot and hardware.
- GPS sold separately.

**Spyder RT**

219400616 - Carbon Black

**\$229.99**



**GPS SUPPORT FOR TRI AXIS ADJUSTABLE HANDLEBAR (WITHOUT HARNESS)**

(Not illustrated)

**Spyder RT**

219400382

**\$59.99**

**GPS SUPPORT AND HARNESS**

(Not illustrated)

- Support kit for Garmin Zumo 660.

- Includes casting, electric harness, rubber boot and hardware.

- GPS sold separately.

**Spyder RT**

219400322 - Chrome Casting

**\$229.99**

**IPOD INTEGRATION CABLE**

- Cable for hooking up an iPod (30 pin connector common to Apple devices) to top cargo's DIN connector.
- Includes 5V transformer.
- Full-feature handlebar control.
- DOT-Matrix visual interface.
- Driver volume control and playlist browser convenience through vehicle's cluster.
- An adapter may be required for latest-generation iPod or iPhone.
- Standard on Spyder RT and ST Limited packages.
- Located in the front compartment on Spyder ST and in rear compartment on Spyder RT.
- Check compatibility with your dealer.

**Spyder RT 2015 and prior, ST**

710002676

**\$71.99**



**ADJUSTABLE GPS MOUNTING KIT (FOR STOCK HANDLEBAR)**

(Not illustrated)

- Mounting kit for Garmin Zumo 590 GPS (219400512) with adjustable support that fits stock handlebar.
- Includes casting, electric harness, rubber boot and hardware.
- The support conveniently swivels to offer the right position for all riders or light conditions.
- GPS sold separately.

**Spyder RT, RS, ST**

219400615 - Carbon Black

**\$229.99**

**CB & COMMUNICATION SYSTEM**

- For staying in touch with friends across a range of 40 channels.
- Handlebar controls allow push-to-talk and adjust squelch levels for maximum performance and reception quality.
- Fully integrated system also mutes radio while in transmitting and receiving modes.
- Plug-and-play system controlled via vehicle's cluster.
- Works in conjunction with wired Communication Headset (4474380090).
- Entertainment Harness (219400610) required for installation.
- AM/FM Integrated Audio System (219400464) also required for Spyder RT 2012 and prior models.

**Spyder RT**

219400611

**\$839.99**



**CB ANTENNA REPLACEMENT KIT**

(Not illustrated)

- Includes antenna, antenna base, ground strap and wires.

**Spyder RT (service kit)**

219400317

**\$159.99**

**COMMUNICATION HEADSET (WIRED)**

- For rider and passenger. Includes headset and microphone.
- Works in conjunction with the CB & Communication System (219400611) available as an option on the Can-Am Spyder RT models.

4474380090

**\$189.99**



**PUSH-TO-TALK REMOTE FOR PASSENGER**

- Passenger communication system (wired) for use with wired headsets and microphones (4474380090).
- Provides passenger with vehicle-to-vehicle communication capabilities with push-to-talk (PTT) button.
- Works in conjunction with the CB & Communication System (219400611), available as an option on the Can-Am Spyder RT models.

4474760090

**\$79.99**

**ENTERTAINMENT HARNESS**

(Not illustrated)

- Required to install the CB & Communication System (219400611) and Satellite Radio Kit (219400612).

**Spyder RT**

219400610

**\$129.99**

**FRONT CARGO 12V POWER OUTLET KIT**

- Adds an extra 12V power outlet to your vehicle.
- Conveniently located in front cargo bin.

**Spyder RT, RS, ST, all Spyder F3 models**

219400366 - Black

- Recharges your electronic devices while riding (smartphone, MP3, heating gear, etc.).
- Dual port USB connectors.
- Plug-and-play kit.
- Simply connect under driver seat and use.

**Spyder RT, RS, ST, F3, F3-S**

219400510 - USB

**\$34.99**



**FOG LIGHTS**

(Not illustrated)

- Enhance low beam light for better visibility at ground level and on sides.
- Uniquely styled halogen fog lamps feature a 35W bulb and clear lens with a faceted inner reflector.
- Easy installation.
- Not compatible with EC homologated vehicles.
- Not EC compliant.

**Spyder RT**

219400579

**\$529.99**

**5-LED FRONT HEADLAMP ACCENT LIGHTING KIT**

(Not illustrated)

- Additional luminescence for improved visibility and more spectacular arrivals.

**Spyder RT**

219400188

**\$159.99**

**REPLACEMENT N-TOUCH COVERS FOR COMMUNICATION SYSTEM DIN CONNECTORS**

(Not illustrated)

**Spyder RT (service kit)**

219400315 - Black

**\$12.99**





# U-STYLE

## WHEELS



### 15" SHAMROCK WHEELS

- Add personality to your Can-Am Spyder.
- Casted, painted and machined wheels.
- Sold in pairs.

Spyder RT, RS, ST 2013 and up, all Spyder F3 models

■ 219400500 · Deep Black

**\$609.99**



### 15" FAT 6 CHROME WHEELS

- Same design as Spyder F3 production wheels in PVD finish.
- Sold in pairs.

Spyder RT, RS, ST 2013 and up, all Spyder F3 models

■ 219400589 · Chrome

**\$719.99**



### CHROME REAR WHEEL

- 6-spoke PVD — chrome-like powder-coat, more resistant than regular chrome — monobloc rear wheel (hub and wheel in one piece).

Spyder RT, RS, ST 2013 and up, all Spyder F3 models

■ 219400574 · Chrome

**\$659.99**

All Spyder 2012 models and prior

■ 219400575 · Chrome

**\$659.99**



### 15" 2014 RS-S MAG WHEELS

- Painted and machined.
- Sold in pairs.
- Standard on 2014 Spyder RS-S package.

Spyder RT, RS, ST 2013 and up, all Spyder F3 models

■ 219400418 · Carbon Black

**\$559.99**



### 15" RT-S FRONT WHEELS

- Premium cast aluminum 15" 12-spoke mags.
- Sold in pairs.

Spyder RT, RS, ST 2013 and up, all Spyder F3 models

■ 219400419 · Carbon Black

**\$559.99**



### 15" RT FRONT WHEELS

- 15" 12-spoke mags.
- Sold in pairs.

Spyder RT, RS, ST 2013 and up, all Spyder F3 models

■ 219400365 · Grey

**\$579.99**



### 15" RS-S & ST-S FRONT WHEELS

- Premium cast aluminum 15" 6 twin-blade spoke mags.
- Sold in pairs.

Spyder RT, RS, ST 2013 and up, all Spyder F3 models

■ 219400357 · Carbon Black

**\$559.99**



### 14" CHROME WHEELS

- Sold in pairs.

Spyder RT 2012 and prior

■ 219400256 · Chrome

**\$659.99**



### 15" BLADE MAG WHEELS

- Unidirectional design (left and right wheel).
- Patented casting process allows a weight reduction of 2.2 lbs (1 kg) per wheel compared to stock wheels.
- Sold in pairs.

Spyder RT, RS, ST 2013 and up, all Spyder F3 models

■ 219400465 · Black

**\$659.99**

### 15" BLADE MAG WHEELS SERVICE KIT

- (Not illustrated)
- Replacement "blade" for wheels.

■ 219400542

Left · Brushed Aluminum

■ 219400543

Right · Brushed Aluminum

**\$24.99**



### 14" RT SMOKED CHROME WHEEL

- Premium wheels featuring 6 spokes with uniquely rounded smooth edge design.
- Quality cast aluminum construction reduces weight without compromising strength.
- Sold in pairs.

Spyder RT 2012 and prior

■ 219400205 · Smoked Chrome

**\$629.99**



### 15" RT & ST LIMITED CHROME FRONT WHEELS

- Premium cast aluminum 15" 12-spoke mags.
- Sold in pairs.

Spyder RT, RS, ST 2013 and up, all Spyder F3 models

■ 219400420 · Chrome

**\$719.99**



### 15" RS & ST FRONT WHEELS

- 15" 6-dual-spoke mags.
- Sold in pairs.

Spyder RT, RS, ST 2013 and up, all Spyder F3 models

■ 219400417 · Grey

**\$559.99**

### WHEEL NUT KIT

- (Not illustrated)
- Pack of 6.

All Spyder models

■ 219400451 · Black

**\$24.99**

■ 219400452 · Grey

**\$29.99**

## FENDERS



You can make any year Can-Am Spyder look like the latest by simply changing the fenders.



### LOW BROW FRONT FENDERS

- Super sleek drawn steel fenders with LED position lights integrated into the front edge.
- Includes electrical harness and required hardware.
- Sold in pairs.
- LED position lights not EC homologated.

Spyder RT, RS, ST 2013 and up, all Spyder F3 models

■ 219400502 · Carbon Black

**\$949.99**



### FRONT FENDERS

- Sporty look with a slim profile and integrated position lights and reflectors.
- Front Fender Supports (219400359) are required (sold separately).
- Sold in pairs.

Spyder RT, RS, ST 2013 and up, all Spyder F3 models

■ 219400423 · Pure Magnesium

■ 219400424 · Satin Black

□ 219400467 · Pearl White

**\$259.99**



### FRONT FENDER SUPPORTS

- Supports for Front Fenders, including position lights, reflectors and hardware.
- Front Fenders sold separately.
- Sold in pairs.

Spyder RT, RS, ST

■ 219400359 · Black

**\$399.99**





CUSTOM ACCESSORIES

**WINDSHIELD SUPPORT**

· Complete with mounting hardware.

**Spyder RT**  
 ■ 219400298 · Chrome  
**\$319.99**



**MIRROR ACCENTS**

· Chrome accents to upgrade your mirrors.  
 · Sold in pairs.

**Spyder RT**  
 ■ 219400291 · Chrome  
**\$99.99**



**WINDSHIELD TRIM**

**Spyder RT**  
 ■ 219400191 · Chrome  
**\$64.99**



**AIR INTAKE TRIMS**

· Sold in pairs.  
**Spyder RT (except models with Fog Lights)**

■ 219400196 · Chrome  
**\$124.99**



**HANDLEBAR COVER**

· Complete with hardware and black center cap.

**Spyder RT**  
 ■ 219400263 · Chrome  
**\$309.99**



**UPPER WIND DEFLECTORS**

· Hardware included.  
 · Sold in pairs.

**Spyder RT**  
 ■ 219400262 · Chrome  
**\$104.99**



**HANDLEBAR END CAPS**

· Sold in pairs.

**All Spyder models**  
 ■ 219400702 · Chrome  
**\$41.99**



**LOWER WIND DEFLECTORS**

· Hardware included.  
 · Sold in pairs.

**Spyder RT**  
 ■ 219400290 · Chrome  
**\$104.99**



**DRIVER FOOTBOARDS**

· Replace stock pegs on SE5 and SE6 models.  
 · Sold in pairs.

**Spyder RT-S SE5, SE6 2013 and up**  
 ■ 219400582 · Chrome  
**\$999.99**



**PASSENGER FOOTBOARDS**

· Complete chrome passenger footboards assembled with rubber insulation pads.  
 · Mounting hardware included.  
 · Sold in pairs.

**Spyder RT**  
 ■ 219400265 · Chrome  
**\$279.99**



**BRAKE PEDAL**

· Complete with rubber pad.  
**Spyder RT 2012 and prior**  
 ■ 219400267 · Chrome  
**\$134.99**



**FOOTPEG SUPPORT CASTINGS**

· Remounting hardware included.  
 · Peg and footboard sets sold separately.  
 · Sold in pairs.

**Spyder RT 2012 and prior**  
 ■ 219400268 · Chrome  
**\$599.99**



**DRIVER FOOTPEGS**

· Chrome pegs assembled with rubber insulated pads.  
 · Mounting hardware included.  
 · Sold in pairs.

**Spyder RT**  
 ■ 219400264 · Chrome  
**\$204.99**



**SHIFT LEVER**

· Complete with rubber pad.  
**Spyder RT 2013 and prior (except Spyder RT Limited)**  
 ■ 219400266 · Chrome  
**\$104.99**



**LOWER SPOILER TRIMS**

· Sold in pairs.  
**Spyder RT 2013 and prior**  
 ■ 219400194 · Chrome  
**\$154.99**



**SIDE CAN-AM TRIMS**

· Sold in pairs.  
**Spyder RT**  
 ■ 219400195 · Chrome  
**\$84.99**



**REAR TOP CARGO TRIM**

**Spyder RT**  
 ■ 219400192 · Chrome  
**\$84.99**

**EXHAUST TIP AND HEAT SHIELD**

· Kit for custom finishing your stock exhaust system.  
 · Includes chrome end pipe, heat shield and hardware.

**Spyder RT 2012 and prior**  
 ■ 219400260 · Chrome  
**\$299.99**  
**Spyder RT, RS, ST, F3-T, F3 Limited 2016 and up**  
 ■ 219400473 · Chrome  
**\$299.99**





## U-PERFORMANCE

### SHOCKS



#### FOX ADJUSTABLE FRONT SHOCK KIT

- Velocity sensitive, bolt on suspension upgrade specially tuned for Spyder RT.
- Includes stiffer springs and adjustable preload to adapt to your riding style and reduce body roll.
- Fully serviceable and rebuildable.
- Part of the Podium Performance Series, delivers great performance and comfort.

Spyder RT 2014 and up

219400588

**\$509.99**

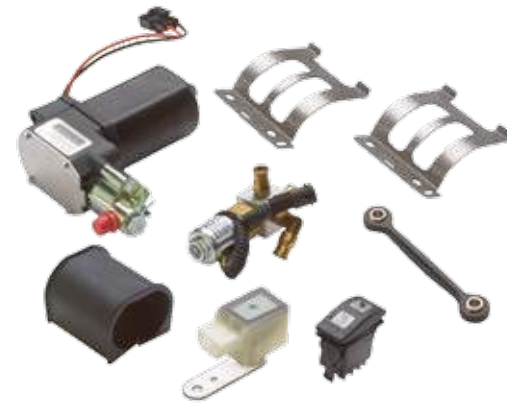

#### ADJUSTABLE AIR REAR SUSPENSION KIT

- Upgrades suspension comfort to Spyder RT-S premium automated level.
- Includes air compressor, adjustment switch and all required hardware.
- When installing this kit on model year 2010 and 2011, an ACS switch (710001960) must be ordered to have the same blue backlight.

Spyder RT 2012 and up

219400539

**\$464.99**

### SILENCERS



All Can-Am Spyder accessory exhaust systems meet all the most stringent EPA, CARB & EC standards.



#### AKRAPOVIČ SPORT TOURING SILENCER

- Not AS certified.

Spyder RT 2013, RS, ST 2013 and up (991 engine)

219400443 · Titanium

**\$919.99**



#### AKRAPOVIČ SPORT SILENCER

- Not AS certified.

Spyder RT 2013, RS, ST 2013 and up (991 engine)

219400444 · Titanium

**\$919.99**



#### AKRAPOVIČ SPORT TOURING 3C SILENCER

- Set your ride apart with the dynamic, deep resonant sound of an Akrapovič silencer.
- Its premium titanium and carbon fiber construction is 55% lighter than stock model and it's been tested to meet the most stringent requirements.
- Not AS certified.

Spyder RT 2016, F3-T, F3 Limited

219400650 · Titanium · Can / US

219400442 · Titanium · Other countries

**\$999.99**

#### AKRAPOVIČ SILENCERS TOP FEATURES

- Innovative Design. First hexagonal shaped silencers.
- The best materials. Premium titanium shell construction with carbon fiber end cap and heat shield render these silencers 55% lighter than the stock silencer.
- The unmistakable sound of Akrapovič. Deep resonant sound that you won't hear anywhere else.
- EPA, CARB and EC certified. Rigorous measurement, testing and quality control ensure silencers meet the most stringent standards.
- Exhaust fit compatible with all BRP genuine accessories.

# SPYDER RS & ST ACCESSORIES

AKRAPOVIČ SPORT SILENCER 219400444



ULTRASPORT WINDSHIELD 219400077



TOP CASE 219400476

## U-FUNCTION

### SEATS & BACKRESTS



#### COMFORT SEAT

- Premium plush styling with stitched seat skin.
- Custom saddle look and relaxed sitting position.
- Increases driver and passenger comfort and reduces tailbone pressure.
- Ideal for driving long distances.
- Sold as complete seat assembly.
- Product may differ from picture shown.

#### Spyder RS, ST

219400416 - Black

\$509.99



#### PASSENGER BACKREST

- One piece fixed passenger backrest with latest ergonomics, high and wide, providing superior lateral support.
- Removes in seconds back to original sport look.
- Rear cover included.

#### Spyder RS, ST

219400350 - Carbon Black

\$659.99

### WINDSHIELDS & WIND PROTECTION

#### SPORT TOURING WINDSHIELD

- 14" (36 cm).
- Makrolon® polycarbonate custom windshield.

#### Spyder RS

219400075 - Clear

\$189.99

#### ULTRASPORT WINDSHIELD

- 10" (25 cm).
- Makrolon polycarbonate windshield with blackened-out «V» shape profile.
- Easy installation.

#### Spyder RS

219400077 - Smoke

\$154.99

#### ULTRA TOURING WINDSHIELD KIT

- Ultra protective windshield and casting support.
- Constructed with Quantum hardcoated 4.5 mm Lexan® polycarbonate.
- Windshield design is spaced away from pod reducing backdraft pressure.
- Service Kit (219400204) is recommended to mount this windshield.

#### Spyder RS

23" (58 cm)

219400285 - Clear - Ideal for drivers under 5'10" (1.75 m).

\$289.99

25" (64 cm)

219400336 - Clear - Ideal for drivers over 5'10" (1.75 m).

\$309.99

#### ULTRA TOURING WINDSHIELD SERVICE KIT

(Not illustrated)

#### Spyder RS

219400204

\$24.99

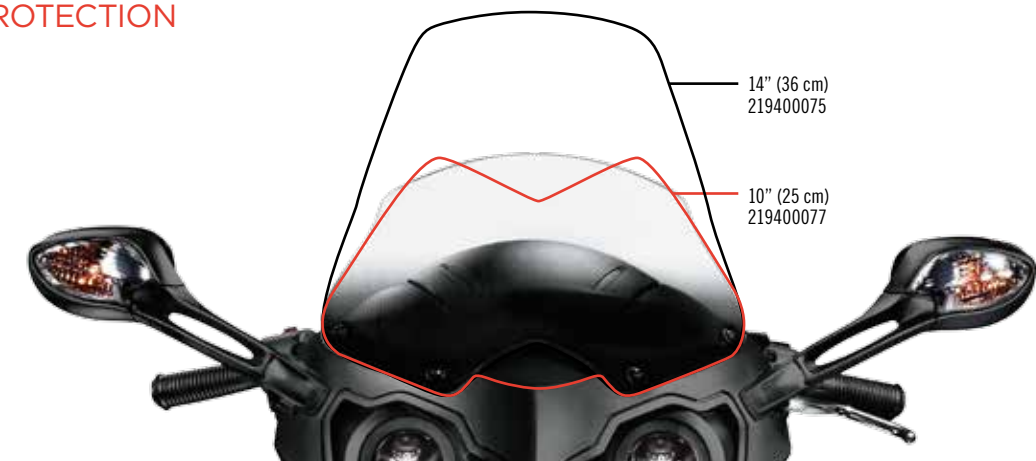



## CARGO & STORAGE

### R-35 RIGID SADDLEBAG KIT

- Provides carry-away convenience for additional luggage storage.
- Clean finish courtesy of fully integrated flush mount brackets with quick release system.
- Quick release quarter-turn system provides security and removal in minutes when saddlebags are not required.
- Side case utilizes Monokey® side fitting system.
- Opens/closes and attaches/detaches with one key and push button for ease of use.

- Volume capacity of 9 US gallons (34 L) (e.g. fits 2 Can-Am full face helmets).
- Weight capacity of 15 lbs (6.8 kg) each side.
- Dimensions W 21" x D 12" x H 15.5" (53 cm x 30 cm x 39 cm).
- Kit includes 2 saddlebags.
- Color-matched panels sold separately.
- Standard on Spyder ST Limited package.

#### Spyder RS, ST

- 219400351 - Black
  - 219400352 - Black - Europe - EC compliant
- \$1,119.99**



Unlike competing saddlebags, Can-Am Spyder saddlebags ensure you maintain your vehicle's warranty.



### R-35 SADDLEBAG PANEL KIT

- Sold in pairs.
- EC compliant.

#### Spyder RS, ST

- 219400174 - Yellow
- 219400175 - Roadster Red
- 219400178 - Full Moon Silver
- 219400222 - Pearl White
- 219400292 - Pure Magnesium

- 219400293 - Alloy Orange
- 219400375 - Can-Am Red
- 219400377 - Steel Black Metallic
- 219400461 - Circuit Yellow

**\$134.99**

### TOP CASE

- Rear luggage that mounts directly on Passenger Backrest (219400350), sold separately.
- 8.7 US gallons (33 L) capacity.
- Installs and removes in minutes.

#### Spyder ST

- 219400476 - Black

**\$509.99**



### PASSENGER SEAT BAG

- 5.9 US gallons (22.3 L) capacity.
- Durable 1200-denier nylon construction with polyurethane coating.
- For use on passenger seat, also fits in front storage compartment.

#### Spyder RS, ST

- 280000320 - Dark Grey

**\$144.99**



### R-35 SADDLEBAG REAR REFLECTOR KIT

(Not illustrated)

#### Spyder RS, ST (service kit)

219400235

**\$13.99**

### ROLLING TRAVEL BAG

- Premium bag with extendable handle.
- Fits conveniently in front storage compartment.

#### Spyder RS, ST

- 219400098 - Grey

**\$209.99**



Windshields aren't just for warmth - they play a big role in your Can-Am Spyder ST's styling.



25" (64 cm)  
219400354



15" (38 cm)  
219400353

### ULTRA TOURING WINDSHIELD

- Taller and slightly wider than stock windshield to ensure maximum wind protection.
- 5 height settings to adjust for more or less wind protection as needed.
- Service Kit (219800352) is recommended to mount this windshield.

#### Spyder ST

- 219400354 - Clear

**\$279.99**

### ULTRA TOURING WINDSHIELD SPRING SERVICE KIT

(Not illustrated)

#### Spyder ST

219800352

**\$18.99**

### SPORT WINDSHIELD

- Sporty look.
- 5 height settings to adjust for more or less wind protection than stock model.

#### Spyder ST

- 219400353 - Clear

**\$194.99**

### ULTRA SPORT POD COVER

- Sleek pod cover that provides a super sporty look by replacing the stock windshield and its adjustment mechanism.

#### Spyder ST

- 219400447 - Black

**\$119.99**



**LIGHTS & ELECTRICAL ACCESSORIES**



**GARMIN ZUMO 590 GPS**

- Features a glove-friendly and sunlight-readable 12.7 cm (5") dual-orientation touchscreen display.
- Offers hands-free phone control and spoken directions heard in-helmet via Bluetooth 5 technology.
- Includes a MP3 player.
- iPod and Pandora compatibility.
- Allows control of music right on the display.

**All Spyder models**  
 219400512  
 219400699 · Europe  
**\$909.99**

- Rugged and tough enough to withstand fuel spills, UV rays and harsh weather.
- Offers access to real-time weather and traffic information via the smartphone link app.
- Free lifetime map updates.
- Curvy Roads Routing allows rider to find winding roads.
- Adjustable GPS Mounting Kit (219400615) sold separately.



**ST RADIO KIT**

- (Not illustrated)
- Easy access handlebar controls, menu driven display. Kit includes radio module, antenna and 2 front speakers.

**Spyder ST**  
 219400521  
**\$859.99**

**WITHOUT THE FOG LIGHTS**



**WITH THE FOG LIGHTS**



**FOG LIGHTS**

- Enhance low beam light for better visibility at ground level and on sides of your vehicle.
- Uniquely styled halogen fog lamps feature a 35W bulb and clear lens with a faceted inner reflector.
- Harness included.
- Easy installation.
- Not compatible with EC homologated vehicles.
- Not EC compliant.

**Spyder RS, ST 2013 and up**  
 219400614  
**\$409.99**



**NEW CGX2 CAMERA BY CYCLOPS GEAR**

- Capture your Can-Am Spyder moments with this 4K HD and 1080p at 60fps action camera.
- 2" LCD display screen.
- Comes with Class 10 32GB micro SD card and 9 mounts.
- Wi-Fi available to control your camera from your smart phone or tablet with the free i-Cyclops App for iOS and Android.
- Waterproof housing good for use up to 50 m underwater, plus a 2.4gh waterproof remote.

2866860090  
**\$299.99**



**ADJUSTABLE GPS MOUNTING KIT (FOR STOCK HANDLEBAR)**

- Mounting kit for Garmin Zumo 590 GPS (219400512) with adjustable support that fits stock handlebar.
- Includes casting, electric harness, rubber boot and hardware.
- The support conveniently swivels to offer the right position for all riders or light conditions.
- GPS sold separately.
- Recharges your electronic devices while riding (smartphone, MP3, heating gear, etc.).

**Spyder RT, RS, ST**  
 219400615 · Carbon Black  
**\$229.99**



**FRONT CARGO 12V POWER OUTLET KIT**

- Adds an extra 12V power outlet to your vehicle.
- Conveniently located in front cargo bin.

**Spyder RT, RS, ST, all Spyder F3 models**  
 219400366 · Black

- Recharges your electronic devices while riding (smartphone, MP3, heating gear, etc.).
- Dual port USB connectors.
- Plug-and-play kit.
- Simply connect under driver seat and use.

**Spyder RT, RS, ST, F3, F3-S**  
 219400510 · USB  
**\$34.99**



**HEATED DRIVER GRIPS**

- Complete driver heating kit with variable intensity control.
- Provides extra warmth during cooler riding season.

**Spyder ST**  
 219400613  
**\$229.99**



**iPOD INTEGRATION CABLE**

- Cable for hooking up an iPod (30 pin connector common to Apple devices) to top cargo's DIN connector.
- Includes 5V transformer.
- Full-feature handlebar control.
- DOT-Matrix visual interface.
- Driver volume control and playlist browser convenience through vehicle's cluster.

**Spyder RT 2015 and prior, ST**  
 710002676  
**\$71.99**



**BLUETOOTH DONGLE FOR AUDIO SYSTEM**

- Allows a wireless Bluetooth connection between the vehicle's AM/FM radio (or any non-Bluetooth audio device) and the Bluetooth Communication System.
- Dual streaming to 2 Bluetooth headsets at the same time.
- Headset and AM/FM radio sold separately.

**Spyder RT, ST 2013 and up**  
 219400458  
**\$259.99**



**3.5 MM AUDIO PLAYER INPUT**

- 3.5 mm cable for hooking up a MP3 player to top cargo's DIN connector.
- Driver volume control convenience through vehicle's cluster.
- Located in the front compartment on Spyder ST and in rear top cargo on Spyder RT.

**Spyder RT 2015 and prior, ST**  
 710001406  
**\$36.99**



 **U-STYLE**

**WHEELS**



**15" 2014 RS-S MAG WHEELS**  
 · Painted and machined.  
 · Sold in pairs.  
 · Standard on 2014 Spyder RS-S package.  
**Spyder RT, RS, ST 2013 and up, all Spyder F3 models**  
 ■ 219400418 · Carbon Black  
**\$559.99**



**15" RT-S FRONT WHEELS**  
 · Premium cast aluminum 15" 12-spoke mags.  
 · Sold in pairs.  
**Spyder RT, RS, ST 2013 and up, all Spyder F3 models**  
 ■ 219400419 · Carbon Black  
**\$559.99**



**15" RT FRONT WHEELS**  
 · 15" 12-spoke mags.  
 · Sold in pairs.  
**Spyder RT, RS, ST 2013 and up, all Spyder F3 models**  
 ■ 219400365 · Grey  
**\$579.99**



**15" RS-S & ST-S FRONT WHEELS**  
 · Premium cast aluminum 15" 6 twin-blade spoke mags.  
 · Sold in pairs.  
**Spyder RT, RS, ST 2013 and up, all Spyder F3 models**  
 ■ 219400357 · Carbon Black  
**\$559.99**



**15" RT & ST LIMITED CHROME FRONT WHEELS**  
 · Premium cast aluminum 15" 12-spoke mags.  
 · Sold in pairs.  
**Spyder RT, RS, ST 2013 and up, all Spyder F3 models**  
 ■ 219400420 · Chrome  
**\$719.99**



**15" RS & ST FRONT WHEELS**  
 · 15" 6-dual-spoke mags.  
 · Sold in pairs.  
**Spyder RT, RS, ST 2013 and up, all Spyder F3 models**  
 ■ 219400417 · Grey  
**\$559.99**



**15" BLADE MAG WHEELS**  
 · Unidirectional design (left and right wheel).  
 · Patented casting process allows a weight reduction of 2.2 lbs (1 kg) per wheel compared to stock wheels.  
 · Sold in pairs.  
**Spyder RT, RS, ST 2013 and up, all Spyder F3 models**  
 ■ 219400465 · Black  
**\$659.99**



**15" SHAMROCK WHEELS**  
 · Add personality to your Can-Am Spyder.  
 · Casted, painted and machined wheels.  
 · Sold in pairs.  
**Spyder RT, RS, ST 2013 and up, all Spyder F3 models**  
 ■ 219400500 · Deep Black  
**\$609.99**



**15" FAT 6 CHROME WHEELS**  
 · Same design as Spyder F3 production wheels in PVD finish.  
 · Sold in pairs.  
**Spyder RT, RS, ST 2013 and up, all Spyder F3 models**  
 ■ 219400589 · Chrome  
**\$719.99**

**15" BLADE MAG WHEELS SERVICE KIT**  
 (Not illustrated)  
 · Replacement "blade" for wheels.  
 ■ 219400542 · Left · Chrome  
 ■ 219400543 · Right · Chrome  
**\$24.99**

**CHROME REAR WHEEL**  
 · 6-spoke PVD - chrome-like powder-coat, more resistant than regular chrome - monobloc rear wheel (hub and wheel in one piece).  
**Spyder RT, RS, ST 2013 and up, all Spyder F3 models**  
 ■ 219400574 · Chrome  
**All Spyder 2012 models and prior**  
 ■ 219400575 · Chrome  
**\$659.99**



**WHEEL NUT KIT**  
 (Not illustrated)  
 · Pack of 6.  
**All Spyder models**  
 ■ 219400451 · Black  
**\$24.99**  
 ■ 219400452 · Grey  
**\$29.99**



**FRONT FENDERS**

- Sporty look with a slim profile and integrated position lights and reflectors.
- Front Fender Supports (219400359) are required (sold separately).
- Sold in pairs.

**Spyder RT, RS, ST 2013 and up, all Spyder models**

- 219400423 - Pure Magnesium
- 219400424 - Satin Black
- 219400467 - Pearl White

**\$259.99**



**LOW BROW FRONT FENDERS**

- Super sleek drawn steel fenders with LED position lights integrated into the front edge.
- Includes electrical harness and required hardware.
- LED position lights not EC homologated.
- Sold in pairs.

**Spyder RT, RS, ST 2013 and up, all Spyder F3 models**

- 219400502 - Carbon Black

**\$949.99**



**SPORT REAR FENDER**

- Provides a pure sport look while showing off the massive rear tire girth for an awesome visual.
- Includes fender, lateral covers, license plate relocater and light.
- Not EC homologated.

**Spyder RS, ST**

- 219400400 - Black

**\$299.99**



**FRONT FENDER SUPPORTS**

- Supports for Front Fenders, including position lights, reflectors and hardware.
- Front Fenders sold separately.
- Sold in pairs.

**Spyder RT, RS, ST**

- 219400359 - Black

**\$399.99**



**MIRROR ACCENTS**

- Replace stock mirror accents.
- Sold in pairs.

**Spyder ST**

- 219400401 - Chrome

**\$99.99**

**EXHAUST TIP AND HEAT SHIELD**

- Kit for custom finishing your stock exhaust system.
- Includes chrome end pipe, heat shield and hardware.

**All Spyder models**

- 219400473 - Chrome

**\$299.99**



MIRROR ACCENTS

WINDSHIELD TRIMS

UPPER WIND DEFLECTORS

**UPPER WIND DEFLECTORS**

- Replace stock clear upper wind deflectors.

**Spyder ST**

- 219400386 - Chrome

**\$104.99**

**WINDSHIELD TRIMS**

- Sold in pairs.

**Spyder ST, F3, F3-S**

- 219400355 - Chrome

**\$84.99**

**HANDLEBAR END CAPS**

- Sold in pairs.

**All Spyder models**

- 219400702 - Chrome

**\$41.99**



**PROMOTIONAL STICKERS**

- Multi-use vinyl stickers.
- Ideal for showing your Can-Am Spyder colors everywhere you go.
- Sold in pack of 4.

**219400099**

**\$24.99**





## UPGRADE YOUR GROWL

### AKRAPOVIČ SILENCERS TOP FEATURES

- Innovative Design. First hexagonal shaped silencers.
- The best materials. Premium titanium shell construction with carbon fiber end cap and heat shield render these silencers 55% lighter than the stock silencer.
- The unmistakable sound of Akrapovič. Deep resonant sound that you won't hear anywhere else.
- EPA, CARB and EC certified. Rigorous measurement, testing and quality control ensure silencers meet the most stringent standards.
- Exhaust fit compatible with all BRP genuine accessories.

### SILENCERS

#### AKRAPOVIČ SPORT TOURING SILENCER

- Not AS certified.  
 Spyder RT 2013, RS, ST 2013 and up (991 engine)  
 ■ 219400443 · Titanium  
**\$919.99**



#### AKRAPOVIČ SPORT SILENCER

- Not AS certified.  
 Spyder RT 2013, RS, ST 2013 and up (991 engine)  
 ■ 219400444 · Titanium  
**\$919.99**



## U-PERFORMANCE

### SHOCKS

#### FOX ADJUSTABLE SHOCK KIT WITH SWAY BAR

- Fully adjustable gas-charged front FOX Podium 5.7" (145 mm) racing shocks.
- Kit complete with a high performance sway bar.

Spyder RS, ST 2013  
 219400409  
 Spyder RS 2011-2012  
 219400403  
**\$409.99**





# CAN-AM FREEDOM TRAILER



## PUT LONG DISTANCE WORRIES BEHIND YOU.

Advanced technology, design and bold styling come together to deliver an exceptional trailering experience - so you can head out with everything you need for as long as you want.



### CAN-AM FREEDOM TRAILER

Spyder RT, ST, F3-T, F3 Limited

000T1HA00 - Black

\$3,199.99

**"THE CAN-AM FREEDOM TRAILER IS A HANDS-DOWN WINNER IN FEATURES AND PERFORMANCE OFFERED AT THIS PRICE."**

— Fred Rau, Can-Am Spyder Ambassador and enthusiast

- Independent suspension with coil-over shocks and low trailer floor provide a stable, smooth ride.
- Can-Am Spyder RT, ST, F3-T and F3 Limited Vehicle Stability System adapt to the trailer.
- Hinged lid opens wide for easy loading.
- Lid opens with one hand and stays open with air-spring assist.
- Interior's flat bottom and optimized shape maximize capacity. Capacity: 20 ft<sup>3</sup>/566 L.
- Easily holds enough for two travellers, or two golf bags.
- The only trailer that maintains vehicle factory warranty.

**2-YEAR WARRANTY**



**TRAILER STORAGE COVER**

- 100% Polyester with integrated storage pocket.
- Product may differ from picture shown.

**Can-Am Freedom Trailer**

219400592 · Black

\$144.99

**Spyder RT-622 Trailer**

219400216 · Black

\$129.99



**TRAILER HITCH KIT AND CONTROL MODULE**

- Heavy-duty trailer hitch specifically designed for use in conjunction with Can-Am Freedom Trailer.
- Patent pending impact-absorbing mechanical design ensures maximum trailer and vehicle performance.
- Meets all stringent vehicle safety requirements.
- Integrated mud flap reduces damage from rock chips and other debris.
- Wiring components and full-function light control module included.
- Installs and removes easily.
- Only system on the market that maintains vehicle warranty requirements.

**Spyder RT**

219400432

\$529.99

**Spyder ST**

219400431

\$569.99



**FREEDOM TRAILER PREMIUM CHROME TRIMS**

- Made of high quality ABS thermoplastic.
- Contains left (1), right (1) and rear (1) trims.
- Rubber molding to protect trailer paint included.

**Can-Am Freedom Trailer**

219400587 · Chrome

\$289.99



**TRAILER HITCH**

- Heavy-duty trailer hitch specifically designed for use with Can-Am Freedom Trailer.
- Patent pending impact-absorbing mechanical design ensures maximum trailer and vehicle performance and better comfort.
- Meets all stringent vehicle safety requirements.
- Integrated mud flap reduces damage from rock chips and other debris.
- Wiring components and full-function light control module included.
- Installs and removes easily.
- Only system on the market that maintains vehicle warranty requirements.

**Spyder F3-T, F3 Limited**

219400519 · Black

\$569.99

**TRAILER TONGUE STAND**

- (Not illustrated)
- Keeps trailer leveled when not hitched to vehicle.

**Can-Am Freedom, RT-622 Trailers**

219400190 · Black

\$99.99



**4-PIN TRAILER ADAPTOR HARNESS**

- Designed to convert the trailer's electrical harness into a standard 4-pin trailer connector for automotive use.

**Can-Am Freedom, RT-622 2013-2014 Trailers**

219400437

\$79.99



**PREMIUM CARPET**

- Crafted from virtually indestructible thermoplastic.
- Computer-cut for a precision fit in your vehicle.

**Can-Am Freedom Trailer**

219400538

\$259.99



**SPARE WHEEL TIRE BAG**

- Spare tire transportation bag with integrated clipping system to secure tire in trailer.

**Can-Am Freedom, RT-622 Trailers**

219400307 · Black

\$59.99

**CAN-AM FREEDOM TRAILER STRIPE DECAL KIT**

- Premium stripe decals add a sporty look to match the Freedom Trailer to your Can-Am Spyder.

**Can-Am Freedom Trailer**

219400669 · Can-Am Red

219400671 · Gloss White

219400672 · Intense Red

219400674 · Magma Red

219400675 · Matte Black

219400676 · Pure Magnesium

219400677 · Satin Silver

219400678 · Vegas White Pearl

219400693 · Orbital Blue

\$249.99



# COVERS

## SPYDER F3

### NEW F3-T TRAILERING COVER

- Made of durable, 100% waterproof, fully-breathable 300-denier polyester.
- Easy-on / easy-off system ensures cover is secure in all trailering conditions.
- Equipped with integrated exhaust panel and no-scratch flannel windshield liner.
- Compatible with all stock and accessory seats regardless of passenger or driver backrest, passenger armrest, or windshields.
- Incompatible with top case.

**Spyder F3-T, F3 Limited 2016**

■ 219400751 - Black

**\$229.99**



### NEW F3 LIMITED TRAILERING COVER

- Made of durable, 100% waterproof, fully-breathable 300-denier polyester.
- Easy-on / easy-off system ensures cover is secure in all trailering conditions.
- Equipped with integrated exhaust panel and no-scratch flannel windshield liner.
- Compatible with all stock and accessory seats regardless of passenger or driver backrest, passenger armrest, windshield, or top case.

**F3-T (with optional top case), F3 Limited 2017**

■ 219400768 - Black

**\$249.99**



### NEW DRIVER SEAT RAIN COVER

- 100% waterproof driver-seat protection.
- Fits all stock or accessory seats.
- Compatible with Driver Backrest.
- Quick installation and removal.

**All Spyder F3 models**

■ 219400648 - Black

**\$39.99**



### OUTDOOR COVER

- Durable solution-dyed UV and mildew-resistant 100-denier polyester construction.
- Soft inner liner protects windshields up to Tall Boy Windshield (219400596).
- Compatible with F3, F3-S, F3-T with or without passenger and driver backrests.
- Also compatible with all F3 windshields.
- Incompatible with passenger armrests (219400726).

**Spyder F3-T, F3 Limited 2016**

■ 219400603 - Black

**\$259.99**



### TRAVEL COVER

- Start your morning ride with a dry, clean seat.
- Protects the top surfaces of your vehicle and stows compactly in the front compartment, making it a great road trip companion.

**Spyder F3-T, F3 Limited 2016**

■ 219400604 - Black

**\$159.99**



### NEW PASSENGER SEAT RAIN COVER

- 100% waterproof passenger-seat protection.
- Fits all stock or accessory seats.
- Compatible with Passenger Backrest and Short Rail.
- Quick installation and removal.

**All Spyder F3 models**

■ 219400649 - Black

**\$34.99**



### OUTDOOR COVER

- Durable solution-dyed UV and mildew-resistant 100-denier polyester construction.
- Inner liner protects windshield.
- Easy maintenance.

**Spyder F3, F3-S**

■ 219400495 - Black

**\$229.99**



### TRAVEL COVER

- Provides protection to vehicle's top areas.
- Stows conveniently into front bin and takes up little space.
- Easy to install and remove.

**Spyder F3, F3-S**

■ 219400496 - Black

**\$164.99**



## SPYDER RT



### NEW SEAT RAIN COVER

- 100% waterproof seat protection.
- Fits all stock or accessory seats.
- Compatible with Driver Backrest.
- Quick installation and removal.

**Spyder RT**

■ 219400722 - Black

**\$99.99**



### TRAVEL COVER

- Provides protection to vehicle's top areas (windshield, seat, top cargo).
- Stows conveniently into top cargo and takes up little space.
- Quick installation and removal.

**Spyder RT**

■ 219400199 - Black

**\$114.99**



### CUSTOM VEHICLE COVER

- Made of tough water-repellent, breathable 300-denier polyester.
- This 2-tone cover provides maximum vehicle protection while trailering or outdoor storing.
- Includes integrated exhaust panel and protective flannel windshield liner.
- Easy attach system secures cover in all trailering conditions.

**Spyder RT**

■ 219400173 - Black

**\$214.99**

## SPYDER RS & ST



### LIGHT TRAVEL COVER

- Provides vehicle's seating, handlebar and windshield areas with outdoor temporary/overnight protection.
- Compact size makes it convenient for traveling.

**Spyder RS**

■ 219400275 - Black

**\$144.99**

**Spyder RS, ST**

■ 219400449 - Black

**\$159.99**



### OUTSIDE STORAGE COVER

- Durable solution-dyed UV and mildew-resistant 100-denier polyester construction.
- Inner liner protects hood and windshield.
- Easy maintenance.
- Fits models with Ultra Touring Windshields (219400306/ 219400354) and Passenger Backrest (219400350).

**Spyder RS, ST**

■ 219400448 - Black

**\$209.99**



### INDOOR STORAGE COVER

- Soft, non-abrasive, breathable polyester construction allows condensation to escape when vehicle is in storage.
- Easy clean fabric with Scotchgard® treatment.

**Spyder RS**

■ 280000338 - Black

**\$159.99**



### TIE-DOWN KIT

- Specifically designed to secure your Can-Am Spyder while trailering.
- Attach your vehicle to 3 or 4 anchor points, depending on your trailer.
- Pack of 4.

**219400200**

**\$114.99**

# GENUINE BRP PARTS.

BY USING ORIGINAL BRP PARTS,  
YOU ARE TAKING CARE OF YOUR INVESTMENT.  
**MAKE THE RIGHT CHOICE.**



#### AIR FILTERS

- Prevent airborne contaminants from reaching your engine.
- Protect internal components against premature wear.

##### Spyder RS 2008-2012

707800188

**\$32.99**

##### Spyder RS 2013 and up, Spyder RT with 998 cc engine 2010-2013, all Spyder ST models

707800306

**\$39.99**

##### All Spyder models with 1330 engine

707800483

**\$33.99**



#### BRAKE PAD KITS

- Brembo® brake systems are considered to be the benchmark for quality and innovation, delivering the ultimate in performance, comfort, quiet, and durability.

##### Spyder 2013 and up

219800237 - Front

219800239 - Rear

**\$59.99**

- Provide excellent performance, quiet, and durability in all road conditions.

##### Spyder 2012 and prior

219800164 - Front

**\$119.99**

219800165 - Rear

**\$59.99**



#### TIRES

- Designed to work in tandem with the Can-Am Spyder innovative Vehicle Stability System to provide an ultra-stable, confident ride.

706201324 - Front - 165/55R 15

706201411 - Front - 165/65R 14

**\$94.99**

705501464 - Rear - 225/50R 15

**\$189.99**

#### YUASA® BATTERIES

- Absorbed Glass Mat (AGM) technology offers durability, electrical reliability, near maintenance-free performance, making it ideal for the Can-Am Spyder.
- Spill-proof design with the ability to hold its charge three times longer and than conventional lead-acid batteries in stand-by mode.

410922962 - 21 Amps (YTX24HL)

**\$142.99**



#### NGK® SPARK PLUGS

- NGK spark plugs are recommended by BRP and ensure your Can-Am Spyder's ROTAX engine runs smoothly and delivers optimum power at all times.
- Consistent, reliable performance make it an OEM favorite.

415129670 - MR7BI-8

**\$21.22**

219800231 - KR8Bi

**\$20.37**

278002297 - DCP-R9E

**\$3.99**

707000246 - DCP-R8E

**\$3.99**



#### DRIVE BELTS

- High-tensile strength carbon cord and HNBR rubber construction delivers impressive durability, superior flexibility and reduced noise, while resisting abrasion.
- Tooth-side fabric composed of special low-friction fiber.

##### Spyder RT 2014 and up

705501304

**\$309.99**

All Spyder F3 models

705502157

**\$309.99**



# USING THE RIGHT OIL MATTERS

The right oil delivers:

**THE BEST PERFORMANCE  
THE BEST RELIABILITY  
THE LONGEST LIFE**

It's a balancing act to deliver all three attributes – and only XPS, with its custom blend formulations and carefully matched additives, is specifically designed to do just that in a Rotax engine.



**“THE BEST OIL IS THE OIL THAT WAS SPECIFICALLY DESIGNED FOR THE ENGINE, WITHOUT COMPROMISING THE ENGINE.”**

Mischa Zimmermann  
Project Leader Engine Development, BRP



### DOES ONE OIL FIT ALL?

Our efficient, high-output engines place strong demands on engine oil. At BRP, we treat oil like an actual mechanical part that is developed concurrently with our latest high-performance engine technology.

### XPS 4-STROKE OILS

**Fact:** XPS 4-stroke oils are BRP engineer-certified for unmatched lubrication, the right torque and friction transfer characteristics for Spyder's manual and semi-auto clutches, the right viscosity to best protect our engines from startup to operating temperatures, and they all have extra corrosion protection to better safeguard your engine when stored or when riding in harsh conditions. Also, XPS has been proven to withstand the Rotax 1330 ACE 9,300-mile (15,000 km) extended drain interval.

### WHY CHOOSE XPS 4-STROKE ENGINE OILS INSTEAD OF LOWER-COST ALTERNATIVES?

BRP engineers and experts like Mischa Zimmermann have proven repeatedly that other brands of oil don't meet the high standards BRP desires for Spyder engines.

- Each vehicle manufacturer establishes their own lubrication standards and test criteria to validate OEM oil – this means XPS achieves a much higher standard than a typical powersports or motorcycle oil.
- Even oil that is more expensive than XPS will not have the same custom-matched engine and tuned clutch performance for Rotax engines and transmissions. Other oil – even premium aftermarket motorcycle oil – has caused premature clutch wear.
- Our oil is tested on the whole lineup of vehicles and engines we manufacture – not just one or two models. Our specific testing includes real world test miles to ensure XPS meets our performance requirements as opposed to relying only on generalized, minimum specifications that most aftermarket oil brands use.

### AREN'T THERE OTHER HIGH QUALITY OILS ON THE MARKET?

Yes. But no other oil is designed as an actual mechanical part during engine development like XPS. Your satisfaction matters.

 FIND OUT WHY OIL MATTERS AT [WWW.XPSLUBRICANTS.COM](http://WWW.XPSLUBRICANTS.COM)

## XPS ENGINE OILS



### XPS 4-STROKE OIL CHANGE KIT

- Ultra-convenient “all-in-one” oil-change kit saves time and money.
- Includes XPS Synthetic Blend Oil, oil filter, o-rings and washer.

SM5	SE5	SM6 & SE6
219800262	219800263	219800356



### XPS 4-STROKE SYNTHETIC OIL

- Premium synthetic base with custom additives provides unmatched lubrication and enhanced corrosion protection.
- Provides easier starting in cold temperature and enhanced cold start protection.

293600112 - 1 quart (946 ml)  
293600115 - 1 US gallon (3.785 L)



### XPS 4-STROKE SYNTHETIC BLEND OIL

- Specifically formulated and BRP-engineer-certified for use in your Can-Am Spyder vehicle.
- Synthetic blend with custom additives provides enhanced corrosion protection.

293600121 - 1 quart (946 ml)  
293600122 - 1 US gallon (3.785 L)

## XPS MAINTENANCE PRODUCTS



### XPS D.O.T. 4 BRAKE FLUID

- Exceeds D.O.T. 3 and 4 requirements.
- Unique low-moisture formulation providing maximum protection against vapor lock.
- Recommended for Can-Am Spyder vehicles.

293600131  
\$9.99



### XPS CARBON FREE

- XPS Carbon Free prevents problems inherent in Ethanol-blended fuels.
- Extends storage-life of fuel up to 12 months.
- Cleans fuel system while preventing corrosion and oxidation.
- Helps keep piston rings, valves and combustion chamber carbon-free to prevent difficult starting and restore peak performance.

219702533  
\$8.99



### XPS FUEL STABILIZER

- Extends fuel life by preventing fuel breakdown during storage.
- Helps prevent difficult starting, throttle hesitation and poor performance.
- Anti-corrosive, anti-oxidant formula protects fuel system and engine.
- Prevents problems inherent in ethanol-blended fuels.

413408601  
\$9.99

### XPS SYNTHETIC GREASE

- Provides optimal lubrication at temperature extremes.
- Protects against external contamination.
- Specifically formulated for use in Can-Am Spyder vehicles.
- Allows suspensions to perform regardless of conditions.

293550033 - 14 oz. (400 g)  
\$10.99



### XPS PRE-MIXED ANTIFREEZE/COOLANT

- Premixed, ready-to-use.
- Exceptional 5-year extended service life.
- Provides superior heat transfer, protection against corrosion and cavitation.
- Specifically formulated for use in Can-Am vehicles.
- Ideal as a replacement coolant in vehicles that usually use 2-year antifreeze/coolant (green).

219702685 - 5 years (orange) - 1 quart (946 ml)  
\$9.99



\* Please contact your Can-Am Spyder dealer for suggested retail prices of oil based products.



XPS CLEANERS

**XPS ROADSTER CLEANING AND DETAILING KIT**

- Everything needed for care and cleaning.
- Includes multi-surface XPS Metal Polish, degreasing XPS Roadster Wash, showroom shine XPS Spray Cleaner & Polish, super absorbent and machine washable XPS Microfiber Towels.

219702872

**\$43.99**



**XPS BRAKES & PARTS CLEANER**

- A concentrated blend of solvents with a powerful blasting spray that effectively removes grease, grime, brake fluid and other contaminants from brake components and metal parts without the need for disassembly.
- Evaporates instantly and completely, leaving no residue to hinder performance.
- Contains no ozone depleters.

219701705 - 14 oz. (400 g)

**\$7.99**



**XPS ROADSTER WASH**

- A biodegradable non-toxic cleaner that removes dirt and road grime better than any other cleaner.
- Simply spray on and rinse off.
- When used as directed, XPS Roadster Wash is safe for all roadster finishes.

219701703

**\$10.99**



**XPS METAL POLISH**

- Cleans, polishes and protects most metal surfaces, such as chrome, stainless steel, nickel, aluminum, brass, bronze, copper, platinum, magnesium and more.
- Not recommended for use on anodized or clear-coated finishes.

219701707

**\$14.99**



**XPS SPRAY CLEANER & POLISH**

- Removes dirt, grease, road grime and water marks easily and quickly.
- Non petroleum based formula will not harm plastic finishes.

219702844 - 12 oz. (340 g)

**\$9.99**



**XPS MICROFIBER TOWELS**

- The latest in high-quality detailing towels.
- Made up of extremely fine fibers, their soft surfaces have been perfected for drying and polishing painted, gel coated and hard shiny surfaces.
- They are so absorbent they hold up to seven times their weight in water.
- Machine washable means they can be used over and over again.

219701759

**\$8.99**



**XPS**

**MORE THAN JUST OIL.**



**XPS OILS AND ROTAX ENGINES. CREATED, DEVELOPED, AND CONSTANTLY EVOLVING TOGETHER TO WORK BEST TOGETHER.**

It's all about reaching optimum performance and protection, ensuring XPS oils have no equals when used in Rotax engines, and Rotax engines have no equals when they use XPS oils.

**QUALITY, INNOVATION, RELIABILITY AND PERFORMANCE GO INTO EVERY BRP VEHICLE AND INTO EVERY DROP OF XPS OIL.**

Our performance requirements exceed oil certification standards, so we set our own: Testing, and retesting our oils in every Rotax engine type under a wide range of rigorous operating conditions to make sure they work the best under all conditions.

**XPS IS THE ONLY OIL SPECIFICALLY ENGINEERED FOR ROTAX ENGINES.**

BRP's Rotax engines are the perfect embodiment of power and technology, and only highly specialized, specially engineered XPS oils can ensure they always operate at their maximum efficiency and potential.

**XPS OILS & ROTAX ENGINES. PARTNERS IN PERFORMANCE.**

# RECOMMENDED PERIODIC MAINTENANCE SCHEDULE

Going to your BRP dealership for regular maintenance servicing can prevent bigger and more expensive repairs in the long run. Just follow the recommended maintenance schedule. It was designed by experts who understand your Can-Am Spyder and know how to keep it in top form. Take care of your vehicle by maintaining it using strictly BRP and Rotax OEM or 100% Can-Am-approved parts and products. You bought the best vehicle available on the market. It deserves the best maintenance products in the world. Just match your vehicle engine type and mileage with the proper chart column to identify maintenance items to perform. Also, don't forget to do your pre-ride inspection.

SYSTEM	COMPONENT	ACTION	1330 ACE™ ENGINE				991 ENGINE			
			First Inspection 3 100 mi (5,000 km)	At 9 300 mi (15,000 km) or annually	At 19 000 mi (30,000 km)	At 28 000 mi (45,000 km)	First Inspection 600 mi (1,000 km)	At 4 600 mi (7,500 km) or annually	At 9 300 mi (15,000 km)	At 14 000 mi (22,500 km) or after 2 years
ENGINE	Oil System	Check oil level	• (1)	• (1)	• (1)	• (1)	• (2)	• (2)	• (2)	• (2)
	Oil System	Replace oil & oil filter	•	•	•	•	•	•	•	•
	Oil Tank Strainer	Inspect and clean								•
	Valves	Check and adjust clearance (more frequently if driving often at high RPM)								•
	Spark Plugs	Replace				•				•
FUEL	Fuel Filter	Replace				•				• (3)
	Throttle Body	Inspect, clean and adjust								•
	Canister	Change pre-filter				•				
	Fuel Hoses, Evaporation Lines & Canister	Check condition, replace if needed		•	•	•				•
AIR	Air Filter	Replace and clean housing (more frequently in duty or wet areas)			•			•	•	•
EXHAUST	Pipe	Replace joints and gaskets								•
	Pipe	Check gaskets condition and tighten clamping rings and joints		•	•	•				
COOLING	Coolant	Check level	•	•	•	•	•	•	•	•
	Coolant	Change engine coolant								• (4)
	Radiator, Hoses & Waterpump	Check condition, perform pressure test and check for leaks		•	•	•			•	•
HYDRAULIC SHIFTING	Oil Filter	Replace (SE6 and SE5 models only)				•		•	•	•
	Clutch Fluid	Check level (SM6 and SM5 models only, replace fluid every 2 years)	•	•	•	•	•	•	•	•
	Clutch Fluid	Replace clutch fluid (SM6 and SM5 models only)			•					•
	Reverse	Check mechanism operation	•	•	•	•	•	•	•	•
BRAKE	Parking Brake	Check operation, clean and adjust as required	•	•	•	•	•	•	•	•
	Brake Fluid	Check level (replace fluid every 2 years)	•	•	•	•	•	•	•	•
	Brake Pads & Discs	Check condition	•	•	•	•	•	•	•	•
	Brake Hoses	Check for cracks and other damages		•	•	•			•	
STEERING	Throttle Twist Grip	Inspect operation	•	•	•	•	•	•	•	•
	Throttle Cable	Lubricate							•	
	General	Check for abnormal play		•	•	•	•	•	•	•
	General	Check front tire wear, align front wheels if required	•	•	•	•	•	•	•	•
	Tie Rods	Check condition		•	•	•		•	•	•
SUSPENSION	Ball Joints	Check condition		•	•	•		•	•	•
	Front Suspension Arm Cushions	Check for cracks and other damages				•				
	Shock Absorbers	Check for leaks or other damage		•	•	•		•	•	•
	Front Wheel	Check tightening torque on wheel nuts	•	•	•	•	•	•	•	•
	Front Wheel Bearing	Check condition		•	•	•		•	•	•
DRIVE REAR	Drive Belt	Inspect condition and tension, adjust if needed	•	•	•	•	•	•	•	•
	Rear Wheel Axle Nut	Check tightening torque	•	•	•	•	•	•	•	•
	Rear Wheel Speed Sensor	Clean sensor, check sensor gap, adjust as required or each time rear wheel is loosened						•	•	•
	Rear Wheel And Sprocket	Check condition of bearings		•	•	•		•	•	•
TIRES	Front & Rear	Check pressure and adjust if needed	•	•	•	•	•	•	•	•
	Electronic Module	Check fault codes	•	•	•	•	•	•	•	•
ELECTRICAL	Pillion Rider Switch	Check operation						•	•	•
	Control & Passenger Switches	Check operation	•	•	•	•	•	•	•	•
	Lighting	Check all lights	•	•	•	•	•	•	•	•
	Brake Light Switch	Clean	•	•	•	•	•	•	•	•
	Battery	Check connection tightness, clean if needed		•	•	•		•	•	•
BODY	Panels	Check looseness	•	•	•	•	•	•	•	•
	Storage Compartment	Check operation of latches, hinges & key barrel	•	•	•	•	•	•	•	•
	Passenger Handles	Check tightening	•	•	•	•	•	•	•	•
	Footrest	Check looseness and lubricate	•	•	•	•	•	•	•	•

(1) Perform every 900 mi (1,500 km)

(2) Perform every 300 mi (500 km)

(3) Perform every 19 000 mi (30,000 km) or 5 years, whichever comes first

(4) Perform every 28 000 mi (45,000 km) or 5 years, whichever comes first

This maintenance chart applies to 2017 models. Refer to your owners manual for previous years models recommended periodic maintenance schedule, or other pre-ride and specific maintenance procedures. Owner's manual instructions prevail in any case of discrepancies between the information it contains and the one found in this maintenance chart.