

2017 F-650/750 Owner's Manual



owner.ford.com



ford.ca

2017 F-650/750 Owner's Manual



April 2016
First Printing
Owner's Manual
F-650/750
Litho in U.S.A.



HC4J19A321 AA



The information contained in this publication was correct at the time of going to print. In the interest of continuous development, we reserve the right to change specifications, design or equipment at any time without notice or obligation. No part of this publication may be reproduced, transmitted, stored in a retrieval system or translated into any language in any form by any means without our written permission. Errors and omissions excepted.

© Ford Motor Company 2016

All rights reserved.

Part Number: 20160304111232

Table of Contents

Introduction

About This Manual.....	7
Symbols Glossary.....	10
Data Recording.....	12
California Proposition 65.....	13
Perchlorate.....	13
Ford Credit.....	13
Replacement Parts Recommendation.....	13
Special Notices.....	14
Mobile Communications Equipment.....	14
Export Unique Options.....	14
Federal Highway Administration Regulation.....	15
Entering, Exiting or Climbing on This Vehicle.....	15

Environment

Protecting the Environment.....	16
Noise Pollution Control.....	16

Child Safety

General Information.....	17
Installing Child Restraints.....	18
Booster Seats.....	25
Child Restraint Positioning.....	27
Child Safety Locks.....	28

Seatbelts

Principle of Operation.....	29
Fastening the Seatbelts.....	29
Seatbelt Height Adjustment.....	33
Seatbelt Warning Lamp and Indicator Chime.....	34
Seatbelt Reminder.....	34
Child Restraint and Seatbelt Maintenance.....	36
Seatbelt Extension.....	36

Keys and Remote Controls

General Information on Radio Frequencies.....	38
Remote Control.....	38
Replacing a Lost Key or Remote Control.....	39

Doors and Locks

Locking and Unlocking.....	40
----------------------------	----

Security

Passive Anti-Theft System.....	42
--------------------------------	----

Steering Wheel

Adjusting the Steering Wheel.....	44
Audio Control.....	44
Voice Control.....	45
Cruise Control.....	45
Information Display Control.....	45

Wipers and Washers

Windshield Wipers.....	46
Windshield Washers.....	46

Lighting

General Information.....	47
Lighting Control.....	47
Instrument Lighting Dimmer.....	48
Daytime Running Lamps.....	48
Direction Indicators.....	48
Interior Lamps.....	49

Windows and Mirrors

Power Windows.....	50
Exterior Mirrors.....	51
Interior Mirror.....	53
Sun Visors.....	53

Instrument Cluster

Gauges.....	54
-------------	----

Table of Contents

Warning Lamps and Indicators.....	58
Audible Warnings and Indicators.....	61

Information Displays

General Information.....	62
Information Messages.....	64

Climate Control

Manual Climate Control.....	70
Hints on Controlling the Interior Climate.....	71
Heated Exterior Mirrors.....	72

Seats

Sitting in the Correct Position.....	73
Head Restraints.....	73
Manual Seats.....	75
Power Seats.....	76
Rear Seats.....	78
Front Seat Armrest.....	79
Rear Seat Armrest.....	80

Auxiliary Power Points

Auxiliary Power Points.....	81
-----------------------------	----

Storage Compartments

Overhead Console.....	83
-----------------------	----

Starting and Stopping the Engine

General Information.....	84
Ignition Switch.....	84
Starting a Gasoline Engine.....	85
Starting a Diesel Engine.....	86
Diesel Particulate Filter.....	87
Switching Off the Engine.....	88
Engine Idle Shutdown.....	88
Engine Block Heater.....	88

Fuel and Refueling

Safety Precautions.....	90
Fuel Quality - Gasoline.....	91
Fuel Quality - Diesel.....	92
Running Out of Fuel - Gasoline.....	95
Running Out of Fuel - Diesel.....	95
Selective Catalytic Reduction System - Diesel.....	95
Refueling - Gasoline.....	100
Refueling - Diesel.....	101
Fuel Consumption.....	102
Emission Control System - Gasoline.....	103
Emission Control System - Diesel.....	105
Fuel Tank Selector Switch.....	111

Transmission

Automatic Transmission.....	112
Power Take-Off.....	116

Rear Axle

General Information.....	117
Limited Slip Differential.....	117
Electronic Locking Differential.....	117
2-Speed Rear Axle.....	118

Brakes

General Information.....	119
Hints on Driving With Anti-Lock Brakes.....	120
Parking Brake.....	120
Full Power Brake.....	123
Air Brakes.....	123
Exhaust Brake.....	124
Trailer Brakes.....	126

Traction Control

Principle of Operation.....	130
Using Traction Control - Vehicles With: Air Brakes.....	130

Table of Contents

Using Traction Control - Vehicles With: Hydraulic Brakes.....	130	Utilizing the Mediation/Arbitration Program (Canada Only).....	157
Cruise Control		Getting Assistance Outside the U.S. and Canada.....	158
Principle of Operation.....	132	Ordering Additional Owner's Literature.....	159
Using Cruise Control.....	132	Reporting Safety Defects (U.S. Only).....	159
Driving Aids		Reporting Safety Defects (Canada Only).....	160
Steering.....	134	Fuses	
Load Carrying		Fuse Specification Chart.....	161
Load Limit.....	135	Changing a Fuse.....	169
Air Suspension.....	136	Vehicle Inspection Guide	
Towing		Vehicle Inspection Information.....	171
Towing a Trailer.....	138	Maintenance	
Recommended Towing Weights.....	139	General Information.....	180
Essential Towing Checks.....	140	Opening and Closing the Hood.....	181
Fifth Wheel Operation.....	141	Under Hood Overview - 6.8L.....	183
Driving Hints		Under Hood Overview - 6.7L Diesel.....	184
Breaking-In.....	143	Engine Oil Dipstick - 6.8L.....	185
General Driving Points.....	143	Engine Oil Dipstick - 6.7L Diesel.....	185
Economical Driving.....	144	Engine Oil Check - 6.8L.....	185
Cold Weather Precautions.....	145	Engine Oil Check - 6.7L Diesel.....	186
Driving Through Water.....	147	Changing the Engine Oil and Oil Filter.....	187
Roadside Emergencies		Changing the Coalescer Filter Element.....	188
Roadside Assistance.....	148	Oil Change Indicator Reset.....	189
Hazard Warning Flashers.....	149	Engine Coolant Check - 6.8L.....	189
Fuel Shutoff.....	149	Engine Coolant Check - 6.7L Diesel.....	194
Jump Starting the Vehicle.....	150	Automatic Transmission Fluid Check.....	198
Transporting the Vehicle.....	153	Brake Fluid Check.....	200
Customer Assistance		Power Steering Fluid Check.....	201
Getting the Services You Need.....	155	Washer Fluid Check.....	201
In California (U.S. Only).....	156	Draining the Fuel Filter Water Trap - 6.7L Diesel.....	202
The Better Business Bureau (BBB) Auto Line Program (U.S. Only).....	157		

Table of Contents

Fuel Filter - 6.8L.....	202
Changing the 12V Battery.....	203
Checking the Wiper Blades.....	205
Changing the Wiper Blades.....	205
Adjusting the Headlamps.....	205
Removing a Headlamp.....	207
Changing a Bulb.....	207
Bulb Specification Chart.....	208
Changing the Engine Air Filter - 6.8L.....	209
Changing the Engine Air Filter - 6.7L Diesel.....	210
Changing the Engine-Mounted and Diesel Fuel Conditioner Module Fuel Filters.....	214
Electrical System Inspection.....	217
Air Induction System Inspection.....	217
Exhaust System Inspection.....	218
Brake System Inspection.....	219
Axle Inspection.....	222
Steering System Inspection.....	222
Suspension System Inspection.....	223
Frame and Tow Hook Inspection.....	223
Rear Axle Fluid Check.....	223
Spring U-Bolt Check.....	224
Vehicle Care	
General Information.....	225
Cleaning Products.....	225
Cleaning the Exterior.....	226
Waxing.....	227
Cleaning the Engine.....	227
Cleaning the Windows and Wiper Blades.....	228
Cleaning the Interior.....	228
Cleaning the Instrument Panel and Instrument Cluster Lens.....	229
Repairing Minor Paint Damage.....	229
Cleaning the Alloy Wheels.....	230
Vehicle Storage.....	230

Wheels and Tires

Tire Care.....	233
Using Snow Chains.....	247
Changing a Road Wheel.....	248
Technical Specifications.....	250

Capacities and Specifications

Engine Specifications - 6.8L.....	252
Engine Specifications - 6.7L Diesel.....	252
Motorcraft Parts - 6.8L.....	254
Motorcraft Parts - 6.7L Diesel.....	255
Vehicle Identification Number.....	256
Vehicle Certification Label.....	257
Transmission Code Designation.....	257
Capacities and Specifications - 6.8L.....	258
Capacities and Specifications - 6.7L Diesel.....	263

Audio System

General Information.....	272
Audio Unit - Vehicles With: AM/FM.....	273
Audio Unit - Vehicles With: AM/FM/CD/SYNC.....	274
Satellite Radio.....	277
Audio Input Jack.....	279
USB Port.....	279

SYNC™

General Information.....	281
Using Voice Recognition.....	283
Using SYNC™ With Your Phone.....	285
Using SYNC™ With Your Media Player.....	297
SYNC™ Troubleshooting.....	306

Accessories

Auxiliary Switches.....	312
-------------------------	-----

Table of Contents

Ford Protect

Ford Protect.....314

Scheduled Maintenance

General Maintenance Information.....316

Normal Scheduled Maintenance.....323

Special Operating Conditions Scheduled
Maintenance.....328

Scheduled Maintenance Record.....338

Appendices

End User License Agreement.....348

Introduction

ABOUT THIS MANUAL

Thank you for choosing Ford. We recommend that you take some time to get to know your vehicle by reading this manual. The more that you know about your vehicle, the greater the safety and pleasure you will get from driving it.

WARNING



Driving while distracted can result in loss of vehicle control, crash and injury. We strongly recommend that you use extreme caution when using any device that may take your focus off the road. Your primary responsibility is the safe operation of your vehicle. We recommend against the use of any hand-held device while driving and encourage the use of voice-operated systems when possible. Make sure you are aware of all applicable local laws that may affect the use of electronic devices while driving.

Note: Always use and operate your vehicle in line with all applicable laws and regulations.

Note: Pass on this manual when selling your vehicle. It is an integral part of your vehicle.

Note: Your vehicle's powertrain control systems can detect and store information about vehicle modifications that increase horsepower and torque output such as whether or not performance-enhancing powertrain components commonly referred to as performance chips have been used. This information will stay in the system's memory and cannot be erased even if the modification is removed. Ford Motor Company, Ford of Canada, Ford of Mexico and service or repair facilities can retrieve this information when servicing your vehicle. Ford Motor Company may use this information to determine if your warranty covers any needed repairs.

Note: Some aftermarket products may cause severe engine/transmission and/or exhaust system damage; refer to your warranty information for more information.

Your new diesel engine will feel, drive and function somewhat differently than a gasoline engine. Therefore it is very important that you read and thoroughly familiarize yourself and others operating the vehicle with this guide. There is a special procedure for turning off the diesel engine. See **Starting a Diesel Engine** (page 86). It is important to read and understand this material in order to maintain the best service life for your engine.

Ford may discontinue models or change specifications without any notice and without incurring obligations.

Note: Either Ford Motor Company or an authorized Ford dealer may have originally sold this incomplete vehicle to a vehicle modifier who upfitted it. As a result, some of the options and features on this vehicle may differ from what we describe in this manual.

This manual may qualify the location of a component as left-hand side or right-hand side. The side is determined when facing forward in the seat.

Introduction



E154903

A Right-hand side.

B Left-hand side.

Warnings

WARNING



Throughout this guide, you will find warnings identified by the warning symbol. Warnings remind you to be especially careful to reduce the risk of personal injury.

Diesel Engine Information

The diesel engine fuel system is a pressurized two-stage filtration system and consists of:

- A frame-mounted Fuel and Water Separator primary filter with an electric fuel pump and water drain
- An engine-mounted secondary fuel filter
- A fuel injector for each cylinder (8 total)
- A high-pressure fuel pump
- A high-pressure fuel rail for each cylinder bank (2 total)
- Numerous high-pressure pipes from the high-pressure pump to the rails, and rails to the injectors

The fuel and water separator removes both water and impurities from the fuel. The engine-mounted filter filters finer impurities from the diesel fuel. The engine-mounted fuel filter and the frame-mounted fuel filter should be changed at the recommended service interval or when indicated by the information display **LOW FUEL PRESSURE** message. See **Scheduled Maintenance** (page 316).

The fuel and water separator should be drained at regular intervals (recommended at every oil change) or when indicated by the information display and water in fuel indicator light. See **Fuel Quality** (page 92).

Proper fuel filter maintenance and prompt water draining when the water in fuel light illuminates is essential to prevent injection equipment damage. Ignoring the water in fuel light or the information display message **WATER IN FUEL DRAIN FILTER** can cause your vehicle to go into a reduced power mode.

A frame-mounted electric fuel pump located inside the fuel and water separator draws fuel from the fuel tank to provide pressurized fuel to the engine. The fuel pump contains a pressure relief valve for overpressure protection in the event of restricted flow.

The fuel injection system is controlled through the powertrain control module.

Engine Protection Mode

Ford diesel engines are equipped with engine protection and emission control systems. These systems monitor critical temperatures and pressures, and modify engine operation accordingly. These modified engine performance characteristics are normal.

Introduction

If these modified engine performance characteristics persist for an extended period and either the service engine soon or powertrain malfunction, reduced power, electronic throttle control light is illuminated, have the system checked by an authorized dealer.



Service engine soon



Powertrain malfunction, reduced power, electronic throttle control

Diesel Lubrication System

It is important to change the engine oil at the recommended service intervals or when indicated by the information display to maintain oil viscosity. Extending the oil and filter change interval beyond the recommended interval can negatively affect engine performance, fuel economy and engine life. See **Engine Oil Check** (page 186).

Engine and secondary cooling system

The cooling system contains a primary cooling loop to cool the engine and a secondary cooling loop to cool the transmission, charge air, and fuel. The coolant serves three primary purposes: to provide heat transfer, freeze point protection, and corrosion protection using additives.

Vehicles with diesel engines typically are used to carry heavy loads and accumulate mileage rapidly. These two factors may cause the additives in the coolant to wear out in a shorter time. You can find more information about coolant additives and coolant change intervals in the coolant chapter. See **General Maintenance Information** (page 316). Operating the engine with insufficient coolant or coolant additive can cause severe engine damage.

Selective catalytic reduction system

Your vehicle is equipped with a selective catalytic reduction system designed to reduce emission levels of nitrogen oxides from the exhaust of your diesel engine. This system relies on the use of Diesel Exhaust Fluid (DEF) that you must replenish at certain intervals. Failure to maintain proper DEF levels or if the DEF becomes contaminated will result in vehicle speed limitations or result in your vehicle entering an idle-only mode. See **Selective Catalytic Reduction System** (page 95).

Minor Troubleshooting Guide

If the engine won't crank

WARNING



Battery posts, terminals and related accessories contain lead and lead compounds. Wash hands after handling.

Turn on the headlights. If the lights are dim, do not go on at all or when the ignition is turned to the start position, the lights become dim or go out, the battery connections may be loose or corroded, or the battery may be discharged. If there is a clicking or stuttering sound coming from the engine compartment when you turn the key to the start position, this may also indicate a loose or corroded battery connection.

Check the battery connections at the battery posts, cable connection to the engine grounding point and at the starter connection.

If you suspect a discharged battery, have it checked and corrected.

Introduction

- The gearshift lever must be in **P** (Park) or **N** (Neutral) in order for the starter to operate.
- Try operating the starter switch several times. This operation may clean potentially corroded contacts or make the switch temporarily operable until you can reach the dealer.
- If all electrical connections are tight and you need assistance to start, See **Jump Starting the Vehicle** (page 150).

If engine cranks but won't start

Prolonged starter cranking (in excess of 10 seconds) could cause damage to the starter motor or the high-pressure fuel pump.

- Check the fuel gauge. You may be out of fuel. If the gauge shows that there is fuel in the tank, the trouble may be in the electrical system or the fuel system. If equipped with an auxiliary tank, be sure that the tank control switch is set for the tank with fuel and not on an empty tank.
- Leaving your ignition key turned on for over two minutes without starting may make starting difficult because the glow plugs will cease activation. Reset the system by turning the ignition key to off and then back to on again.

Note: *If the system is out of fuel and the engine will not start, do not continue cranking the engine. Continued cranking can damage the high-pressure fuel pump.*

If the engine runs hot

The following could cause the engine to overheat:

- Lack of coolant
- Dirty cooling system.
- Plugged radiator fins, A/C condenser and/or oil cooler
- Malfunctioning fan drive

- Driving with frozen coolant
- Sticking thermostat
- Overloading or pulling heavy trailers during hot weather
- Grill or radiator air blockage
- Slipping or missing drive belt
- Plugged or very dirty air filter

If fuses burn out

WARNING



Replacement fuses and circuit breakers must always be the same rating as the original equipment shown. Never replace a fuse or circuit breaker with one of a higher rating. Higher rated fuses or circuit breakers could allow circuit overloading in the event of a circuit malfunction, resulting in severe vehicle damage or personal injury due to fire.

Burned-out or blown fuses usually indicate an electrical short-circuit, although a fuse may occasionally burn out from vibration. Insert a second fuse. If this fuse immediately burns out and you cannot locate the cause, return your vehicle to your dealer for a circuit check. See **Changing a Fuse** (page 169).

Selective catalytic reduction system speed limit and idle-only modes

If the vehicle's speed is limited or in an idle-only mode, the selective catalytic reduction system may be limiting the vehicle's functions due to low or contaminated DEF. Check the DEF. See **Selective Catalytic Reduction System** (page 95).

SYMBOLS GLOSSARY

These are some of the symbols you may see on your vehicle.

Introduction



Safety alert



See Owner's Manual



Air conditioning system



Anti-lock braking system



Avoid smoking, flames or sparks



Battery



Battery acid



Brake fluid - non petroleum based



Brake system



Cabin air filter



Check fuel cap



Child safety door lock or unlock



Child seat lower anchor



Child seat tether anchor



Cruise control



Do not open when hot



Engine air filter



Engine coolant



Engine coolant temperature



Engine oil



Explosive gas



Fan warning



Fasten seatbelt



Front airbag



Front fog lamps



Fuel pump reset



Fuse compartment



Hazard warning flashers



Heated rear window



Heated windshield

Introduction



Interior luggage compartment release



Jack



Keep out of reach of children



Lighting control



Low tire pressure warning



Maintain correct fluid level



Note operating instructions



Panic alarm



Parking aid



Parking brake



Power steering fluid



Power windows front/rear



Power window lockout



Service engine soon



Side airbag



Shield the eyes



Stability control



Windshield wash and wipe

DATA RECORDING

Service Data Recording

Service data recorders in your vehicle are capable of collecting and storing diagnostic information about your vehicle. This potentially includes information about the performance or status of various systems and modules in the vehicle, such as engine, throttle, steering or brake systems. In order to properly diagnose and service your vehicle, Ford Motor Company, Ford of Canada, and service and repair facilities may access or share among them vehicle diagnostic information received through a direct connection to your vehicle when diagnosing or servicing your vehicle. Additionally, when your vehicle is in for service or repair, Ford Motor Company, Ford of Canada, and service and repair facilities may access or share among them data for vehicle improvement purposes. For the United States only (if equipped), if you choose to use the SYNC Vehicle Health Report, you consent that certain diagnostic information may also be accessed electronically by Ford Motor Company and Ford authorized service facilities, and that the diagnostic information may be used for any purpose. See **SYNC™** (page 281).

Introduction

CALIFORNIA PROPOSITION 65

WARNINGS



Some constituents of engine exhaust, certain vehicle components, certain fluids contained in vehicles and certain products of component wear contain or emit chemicals known to the State of California to cause cancer and birth defects or other reproductive harm.



Battery posts, terminals and related accessories contain lead and lead compounds, chemicals known to the State of California to cause cancer and reproductive harm. Batteries also contain other chemicals known to the State of California to cause cancer. Wash your hands after handling.

PERCHLORATE

Certain components in your vehicle such as airbag modules, seatbelt pretensioners and remote control batteries may contain perchlorate material. Special handling may apply for service or vehicle end of life disposal.

For more information visit:

Web Address
www.dtsc.ca.gov/hazardouswaste/perchlorate

FORD CREDIT

US Only

Ford Credit offers a full range of financing and lease plans to help you acquire your vehicle. If you have financed or leased your vehicle through Ford Credit, thank you for your business.

We offer a number of convenient ways for you to contact us and help to manage your account.

Call 1-800-727-7000.

For more information about Ford Credit and access to the Account Manager, go to www.fordcredit.com.

REPLACEMENT PARTS RECOMMENDATION

We have built your vehicle to the highest standards using quality parts. We recommend that you demand the use of genuine Ford and Motorcraft parts whenever your vehicle requires scheduled maintenance or repair. You can clearly identify genuine Ford and Motorcraft parts by looking for the Ford, FoMoCo or Motorcraft branding on the parts or their packaging.

Scheduled Maintenance and Mechanical Repairs

One of the best ways for you to make sure that your vehicle provides years of service is to have it maintained in line with our recommendations using parts that conform to the specifications detailed in this Owner's Manual. Genuine Ford and Motorcraft parts meet or exceed these specifications.

Collision Repairs

We hope that you never experience a collision, but accidents do happen. Genuine Ford replacement collision parts meet our stringent requirements for fit, finish, structural integrity, corrosion protection and dent resistance. During

Introduction

vehicle development we validate that these parts deliver the intended level of protection as a whole system. A great way to know for sure you are getting this level of protection is to use genuine Ford replacement collision parts.

Warranty on Replacement Parts

Genuine Ford and Motorcraft replacement parts are the only replacement parts that benefit from a Ford Warranty. The Ford Warranty may not cover damage caused to your vehicle as a result of failed non-Ford parts. For additional information, refer to the terms and conditions of the Ford Warranty.

SPECIAL NOTICES

New Vehicle Limited Warranty

For a detailed description of what is covered and what is not covered by your vehicle's New Vehicle Limited Warranty, refer to the **Warranty Guide** that is provided to you along with your Owner's Manual.

Special Instructions

For your added safety, your vehicle is fitted with sophisticated electronic controls.

MOBILE COMMUNICATIONS EQUIPMENT

WARNING



Driving while distracted can result in loss of vehicle control, crash and injury. We strongly recommend that you use extreme caution when using any device that may take your focus off the road. Your primary responsibility is the safe operation of your vehicle. We recommend against the use of any hand-held device while driving and encourage the use of voice-operated systems when possible. Make sure you are aware of all applicable local laws that may affect the use of electronic devices while driving.

Using mobile communications equipment is becoming increasingly important in the conduct of business and personal affairs. However, you must not compromise your own or others' safety when using such equipment. Mobile communications can enhance personal safety and security when appropriately used, particularly in emergency situations. Safety must be paramount when using mobile communications equipment to avoid negating these benefits. Mobile communication equipment includes, but is not limited to, cellular phones, pagers, portable email devices, text messaging devices and portable two-way radios.

EXPORT UNIQUE OPTIONS

For your particular global region, your vehicle may be equipped with features and options that are different from the features and options that are described in this Owner's Manual. A market unique supplement may be supplied that complements this book. By referring to the market unique supplement, if provided, you can properly identify those features,

Introduction

recommendations and specifications that are unique to your vehicle. This Owner's Manual is written primarily for the U.S. and Canadian Markets. Features or equipment listed as standard may be different on units built for Export. **Refer to this Owner's Manual for all other required information and warnings.**

FEDERAL HIGHWAY ADMINISTRATION REGULATION

Regulations such as those issued by the Federal Highway Administration or issued pursuant to the Occupational Safety and Health Act (OSHA), and state and local laws and regulations may require additional equipment for the way you intend to use your vehicle. It is the responsibility of the registered owner to determine the applicability of such laws and regulations to your intended use for the vehicle, and to arrange for the installation of required equipment. The dealer has information about the availability of equipment which can be ordered for your vehicle.

ENTERING, EXITING OR CLIMBING ON THIS VEHICLE

WARNING



Do not carry items while entering, exiting or climbing. Make sure you keep a firm grip. Always face the vehicle step and handle system while climbing up and down. Do not climb behind the cab unless you have three point contact with a step and handle system at all times.

You must be careful and deliberate to minimize the possibility of personal injury from a slip and fall when entering, exiting or climbing on your vehicle. Always use the steps and assist handles before climbing. Do not skip any steps or assist handles. Use three point contact at all times with at least two feet and one hand or two hands and one foot firmly placed during all phases of entering, exiting or climbing. Always keep your shoe soles and hands clean. Keep the steps and assist handles free of snow, ice, oil, grease, substances or debris. Be sure to take extra care in bad weather. Avoid wearing thick gloves. Always perform trailer hook-up while standing on the ground.

Environment

PROTECTING THE ENVIRONMENT

You must play your part in protecting the environment. Correct vehicle usage and the authorized disposal of waste, cleaning and lubrication materials are significant steps toward this aim.

NOISE POLLUTION CONTROL

In order to keep to the federal exterior noise regulations, your vehicle may be equipped with noise emission items. Depending on your vehicle configuration, it may have all or some of the following items:

Air Intake System

Inspect the air cleaner. Do not alter its location. Do not alter inlet and outlet piping.

Body

Inspect wheel well splash shields, cab shields and under hood insulation for deterioration, dislocation and orientation.

Cooling System

- Inspect the fan for blade damage. If you find any damage, replace with the recommended parts. Inspect for fan-to-shroud interference and any damage to shroud, such as cracks and holes.
- Do not change fan ratio or alter fan spacer dimensions and positions.
- Inspect fan clutch for proper operation. Make sure the fan is disengaged when cooling of the engine is not required.
- Inspect radiator shutters (if equipped) for proper operation. The shutters should be open during normal operating temperatures.

Engine

Valve covers and block covers damp-out engine mechanical noise. If they need replacing, make sure to replace them with the recommended parts. Check for mechanical isolations.

Transmission Enclosure

Inspect for cracks, holes and tears. Clean any deposits, such as oil, dirt and stones.

Exhaust System

- Inspect for leaks at various joint connections and loose clamps.
- Perform a visual inspection for cracks or holes in the muffler and tail pipe.
- Always use the recommended replacement parts.
- Do not change the tail pipe elbow or offset tail pipe orientation from the standard position as originally received.
- To avoid abnormal changes in vehicle sound levels, it is necessary for the owner to perform inspections and necessary maintenance at specified intervals. See **Scheduled Maintenance** (page 316).

Child Safety

GENERAL INFORMATION

See the following sections for directions on how to properly use safety restraints for children.

WARNINGS



Always make sure your child is secured properly in a device that is appropriate for their height, age and weight. Child safety restraints must be bought separately from your vehicle. Failure to follow these instructions and guidelines may result in an increased risk of serious injury or death to your child.



All children are shaped differently. The National Highway Traffic Safety Administration and other safety organizations, base their recommendations for child restraints on probable child height, age and weight thresholds, or on the minimum requirements of the law. We recommend that you check with a NHTSA Certified Child Passenger Safety

WARNINGS

Technician (CPST) to make sure that you properly install the child restraint in your vehicle and that you consult your pediatrician to make sure you have a child restraint appropriate for your child. To locate a child restraint fitting station and CPST, contact NHTSA toll free at 1-888-327-4236 or go to www.nhtsa.dot.gov. In Canada, contact Transport Canada toll free at 1-800-333-0371 or go to www.tc.gc.ca to find a Child Car Seat Clinic in your area. Failure to properly restrain children in child restraints made especially for their height, age and weight, may result in an increased risk of serious injury or death to your child.



On hot days, the temperature inside the vehicle can rise very quickly. Exposure of people or animals to these high temperatures for even a short time can cause death or serious heat related injuries, including brain damage. Small children are particularly at risk.

Child Safety

Recommendations for Safety Restraints for Children

Child	Child size, height, weight, or age	Recommended restraint type
Infants or toddlers	Children weighing 40 lb (18 kg) or less (generally age four or younger).	Use a child safety seat (sometimes called an infant carrier, convertible seat, or toddler seat).
Small children	Children who have outgrown or no longer properly fit in a child safety seat (generally children who are less than 4 ft. 9 in. (1.45 m) tall, are greater than age four and less than age 12, and between 40 lb (18 kg) and 80 lb (36 kg) and upward to 100 lb (45 kg) if recommended by your child restraint manufacturer).	Use a belt-positioning booster seat.
Larger children	Children who have outgrown or no longer properly fit in a belt-positioning booster seat (generally children who are at least 4 ft. 9 in. (1.45 m) tall or greater than 80 lb (36 kg) or 100 lb (45 kg) if recommended by child restraint manufacturer).	Use a vehicle seatbelt having the lap belt snug and low across the hips, shoulder belt centered across the shoulder and chest, and seatback upright.

- You are required by law to properly use safety seats for infants and toddlers in the United States and Canada.
- Many states and provinces require that small children use approved booster seats until they reach age eight, a height of 4 feet 9 inches (1.45 meters) tall, or 80 lb (36 kg). Check your local and state or provincial laws for specific requirements about the safety of children in your vehicle.
- When possible, always properly restrain children 12 years of age and under in a rear seating position of your vehicle. Accident statistics suggest that children are safer when properly restrained in the rear seating positions than in a front seating position.

INSTALLING CHILD RESTRAINTS

Child Seats



E142594

Child Safety

Use a child safety seat (sometimes called an infant carrier, convertible seat, or toddler seat) for infants, toddlers, or children weighing 40 pounds (18 kilograms) or less (generally age four or younger).

Using Lap and Shoulder Belts

WARNINGS



Airbags can kill or injure a child in a child restraint. Properly restrain children 12 and under in the rear seat whenever possible.



Depending on where you secure a child restraint, and depending on the child restraint design, you may block access to certain seatbelt buckle assemblies and LATCH lower anchors, rendering those features potentially unusable. To avoid risk of injury, make sure occupants only use seating positions where they are able to be properly restrained.

When installing a child safety seat with combination lap and shoulder belts:

- Use the correct seatbelt buckle for that seating position.
- Insert the belt tongue into the proper buckle until you hear a snap and feel it latch. Make sure the tongue is securely fastened in the buckle.
- Keep the buckle release button pointing up and away from the safety seat, with the tongue between the child seat and the release button, to prevent accidental unbuckling.
- Place the vehicle seat upon which the child seat will be installed in the upright position.
- This vehicle does not require the use of a locking clip.

Perform the following steps when installing the child seat with combination lap and shoulder belts:

Note: *Although the child seat illustrated is a forward facing child seat, the steps are the same for installing a rear facing child seat.*



E142528

1. Position the child safety seat in a seat with a combination lap and shoulder belt.



E142529

2. Pull down on the shoulder belt and then grasp the shoulder belt and lap belt together.

Child Safety



E142530

3. While holding the shoulder and lap belt portions together, route the tongue through the child seat according to the child seat manufacturer's instructions. Be sure the belt webbing is not twisted.



E142875

5. To put the retractor in the automatic locking mode, grasp the shoulder portion of the belt and pull downward until all of the belt is pulled out.
6. Allow the belt to retract to remove slack. The belt will click as it retracts to indicate it is in the automatic locking mode.
7. Try to pull the belt out of the retractor to make sure the retractor is in the automatic locking mode (you should not be able to pull more belt out). If the retractor is not locked, unbuckle the belt and repeat Steps 5 and 6.

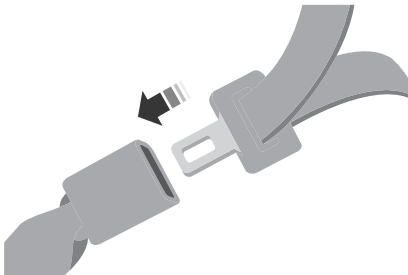

E142531

4. Insert the belt tongue into the proper buckle (the buckle closest to the direction the tongue is coming from) for that seating position until you hear a snap and feel the latch engage. Make sure the tongue is latched securely by pulling on it.



E142533

8. Remove remaining slack from the belt. Force the seat down with extra weight, for example, by pressing down or kneeling on the child restraint while pulling up on the shoulder belt in order to force slack from the belt. This is

Child Safety

necessary to remove the remaining slack that will exist once the extra weight of the child is added to the child restraint. It also helps to achieve the proper snugness of the child seat to your vehicle. Sometimes, a slight lean toward the buckle will help to remove remaining slack from the belt.

9. Attach the tether strap (if the child seat is equipped).

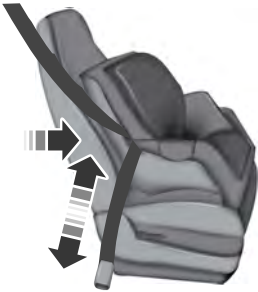

E142534

10. Before placing the child in the seat, forcibly move the seat forward and back to make sure the seat is securely held in place.

To check this, grab the seat at the belt path and attempt to move it side to side and forward and back. There should be no more than 1 inch (2.5 centimeters) of movement for proper installation.

We recommend checking with a NHTSA Certified Child Passenger Safety Technician to make certain the child restraint is properly installed. In Canada, check with Transport Canada for referral to a Child Car Seat Clinic.

Using Cinch Tongue Lap and Shoulder Belts (All Front Center, Super Cab and Crew Cab Rear Center Positions)

WARNINGS

 Airbags can kill or injure a child in a child restraint. Never place a rear-facing child restraint in front of an active airbag. If you must use a forward-facing child restraint in the front seat, move the seat upon which the child seat is installed all the way back.

 Always use both lap and shoulder seatbelts in the Regular Cab center seating position if applicable.

The belt webbing below the tongue is the lap portion of the combination lap and shoulder belt, and the belt webbing above the tongue is the shoulder belt portion of the combination lap and shoulder belt.



E142528

1. Position the child safety seat in the front center seat.

Child Safety



E162708

2. Slide the tongue up the webbing.



E142530

3. While holding both shoulder and lap portions next to the tongue, route the tongue and webbing through the child seat according to the child seat manufacturer's instructions. Be sure that the belt webbing is not twisted.

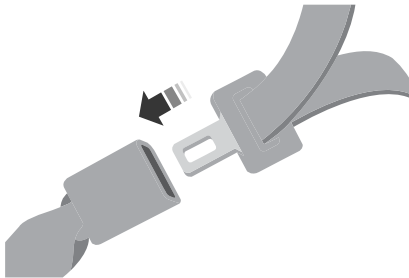

E142531

4. Insert the belt tongue into the proper buckle (the buckle closest to the direction the tongue is coming from) for that seating position until you hear a snap and feel the latch engage. Make sure the tongue is latched securely by pulling on it.



E142533

5. While pushing down with your knee on the child seat pull up on the shoulder belt portion to tighten the lap belt portion of the combination lap and shoulder belt.
6. Allow the seatbelt to retract and remove any slack in the belt to securely tighten the child safety seat in the vehicle.
7. Attach the tether strap (if the child seat is equipped).



E142534

Child Safety

- Before placing the child in the seat, forcibly move the seat forward and back to make sure the seat is securely held in place. To check this, grab the seat at the belt path and attempt to move it side to side and forward and back. There should be no more than 1 inch (2.5 centimeters) of movement for proper installation.
- Check from time to time to be sure that there is no slack in the lap and shoulder belt. The shoulder belt must be snug to keep the lap belt tight during a crash.

We recommend checking with a NHTSA Certified Child Passenger Safety Technician to make certain the child restraint is properly installed. In Canada, check with Transport Canada for referral to a Child Car Seat Clinic.

Using Lower Anchors and Tethers for Children (LATCH)

The LATCH system is composed of three vehicle anchor points: two lower anchors where the vehicle seatback and seat cushion meet (called the seat bight) and one top tether anchor behind that seating position. Your vehicle is not equipped with the lower anchor points in the seat bight. For this vehicle, use the vehicle seatbelt and upper tether to secure a child seat.

F-Series Regular Cab

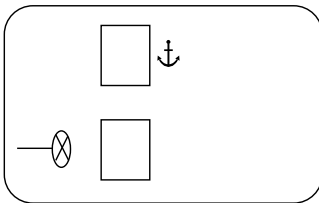

Using Tether Straps

Many forward-facing child safety seats include a tether strap which extends from the back of the child safety seat and hooks to an anchoring point called the top tether anchor. Tether straps are available as an accessory for many older safety seats. Contact the manufacturer of your child seat for information about ordering a tether strap, or to obtain a longer tether strap if the tether strap on your safety seat does not reach the appropriate top tether anchor in the vehicle.

The passenger seats of your vehicle may have built-in tether strap anchors behind the seats as described below.

The tether strap anchors in your vehicle are in the following positions (shown from top view):

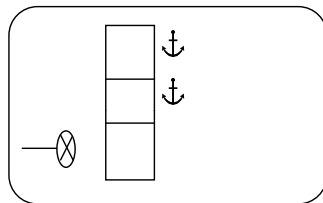

E162709

Child Safety

F-Series Crew Cab

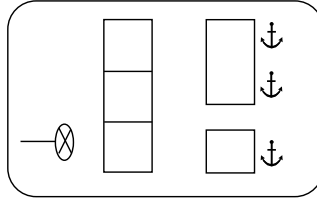
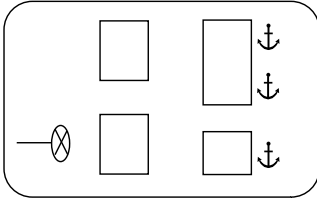

E162711

Attach the tether strap only to the appropriate tether anchor as shown. The tether strap may not work properly if attached somewhere other than the correct tether anchor.

Once you install the child safety seat using the seatbelt, you can attach the top tether strap.

Tether Strap Attachment

1. Route the child safety seat tether strap over the back of the seat.

Note: For vehicles with adjustable head restraints, route the tether strap under the head restraint and between the head restraint posts, otherwise route the tether strap over the top of the seat back. If the top of the safety seat hits the head restraint, raise the head restraint to let the child seat fit further rearward.

2. Locate the correct anchor for the selected seating position.
3. You may need to pull the seatback forward to access the tether anchors. Make sure the seat is locked in the upright position before installing the child seat.

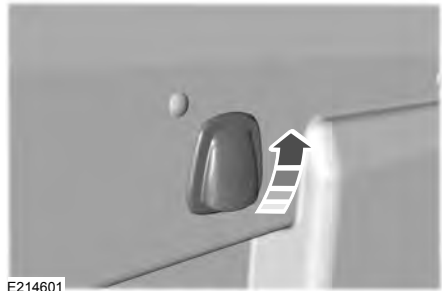

4. Remove the tether cover.

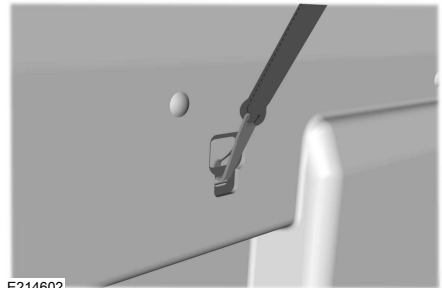

5. Clip the tether strap to the anchor as shown.

Child Safety

If the tether strap is clipped incorrectly, the child safety seat may not be retained properly in the event of a crash.

6. Tighten the child safety seat tether strap according to the manufacturer's instructions.

If you do not anchor the safety seat properly, the risk of a child being injured in a crash greatly increases.

If your child restraint system has a tether strap and the child restraint manufacturer recommends its use, we also recommend its use.

BOOSTER SEATS

WARNING



Never place, or allow a child to place, the shoulder belt under a child's arm or behind the back because it reduces the protection for the upper part of the body and may increase the risk of injury or death in a crash.

Use a belt-positioning booster seat for children who have outgrown or no longer properly fit in a child safety seat (generally children who are less than 4 feet 9 inches (1.45 meters) tall, are greater than age four (4) and less than age twelve (12), and between 40 pounds (18 kilograms) and 80 pounds (36 kilograms) and upward to 100 pounds (45 kilograms) if recommended by your child restraint manufacturer). Many state and provincial laws require that children use approved booster seats until they reach age eight, a height of 4 feet 9 inches (1.45 meters) tall, or 80 pounds (36 kilograms).

Booster seats should be used until you can answer YES to ALL of these questions when seated without a booster seat:

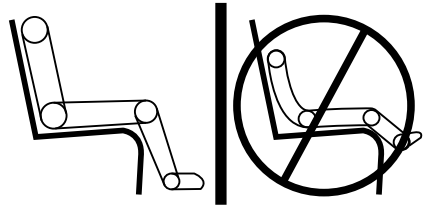

E142595

- Can the child sit all the way back against their vehicle seat back with knees bent comfortably at the edge of the seat cushion?
- Can the child sit without slouching?
- Does the lap belt rest low across the hips?
- Is the shoulder belt centered on the shoulder and chest?
- Can the child stay seated like this for the whole trip?

Always use booster seats in conjunction with your vehicle lap and shoulder belt.

Types of Booster Seats



E68924

- Backless booster seats

Child Safety

If your backless booster seat has a removable shield, remove the shield. If a vehicle seating position has a low seat back or no head restraint, a backless booster seat may place your child's head (as measured at the tops of the ears) above the top of the seat. In this case, move the backless booster to another seating position with a higher seat back or head restraint and lap and shoulder belts, or consider using a high back booster seat.



E70710

- High back booster seats

If, with a backless booster seat, you cannot find a seating position that adequately supports your child's head, a high back booster seat would be a better choice.

Children and booster seats vary in size and shape. Choose a booster that keeps the lap belt low and snug across the hips, never up across the stomach, and lets you adjust the shoulder belt to cross the chest and rest snugly near the center of the shoulder. The following drawings compare the ideal fit (center) to a shoulder belt uncomfortably close to the neck and a shoulder belt that could slip off the shoulder. The drawings also show how the lap belt should be low and snug across the child's hips.



E142596

Child Safety





E142597

If the booster seat slides on the vehicle seat upon which it is being used, placing a rubberized mesh sold as shelf or carpet liner under the booster seat may improve this condition. Do not introduce any item thicker than this under the booster seat. Check with the booster seat manufacturer's instructions.

CHILD RESTRAINT POSITIONING

WARNINGS

 Airbags can kill or injure a child in a child seat. Never place a rear-facing child seat in front of an active airbag. If you must use a forward-facing child seat in the front seat, move the vehicle seat upon which the child seat is installed all the way back. When possible, all children age 12 and under should be properly restrained in a rear seating position. If all children cannot be seated and restrained properly in a rear seating position, properly restrain the largest child in the front seat.

 Always carefully follow the instructions and warnings provided by the manufacturer of any child restraint to determine if the restraint device is appropriate for your child's size, height, weight, or age. Follow the child restraint manufacturer's instructions and warnings

WARNINGS

provided for installation and use in conjunction with the instructions and warnings provided by your vehicle manufacturer. A safety seat that is improperly installed or utilized, is inappropriate for your child's height, age, or weight or does not properly fit the child may increase the risk of serious injury or death.

 Never let a passenger hold a child on his or her lap while your vehicle is moving. The passenger cannot protect the child from injury in a crash, which may result in serious injury or death.

 Never use pillows, books, or towels to boost a child. They can slide around and increase the likelihood of injury or death in a crash.

 Always restrain an unoccupied child seat or booster seat. These objects may become projectiles in a crash or sudden stop, which may increase the risk of serious injury.

 Never place, or allow a child to place, the shoulder belt under a child's arm or behind the back because it reduces the protection for the upper part of the body and may increase the risk of injury or death in a crash.

Child Safety

WARNINGS



To avoid risk of injury, do not leave

WARNINGS

children or pets unattended in your vehicle.

Recommendations for attaching child safety restraints for children

Restraint Type	Combined child and seat weight	Use any attachment method as indicated below by X				
		LATCH (lower anchors and top tether anchor)	LATCH (lower anchors only)	Safety belt and top tether anchor	Safety belt and LATCH (lower anchors and top tether anchor)	Safety belt only
Rear facing child seat	Up to 65 lb (29.5 kg)					X
Rear facing child seat	Over 65 lb (29.5 kg)					X
Forward facing child seat	Up to 65 lb (29.5 kg)			X		
Forward facing child seat	Over 65 lb (29.5 kg)			X		

Note: The child seat must rest tightly against the vehicle seat upon which it is installed. It may be necessary to lift or remove the head restraint. See **Head Restraints** (page 73).

CHILD SAFETY LOCKS (If Equipped)

When these locks are set, the rear doors cannot be opened from the inside.



E162719

The childproof locks are located on the rear edge of each rear door. You must set the lock separately for each door.

Move the lock control up or down to engage or disengage the childproof lock.

Seatbelts

PRINCIPLE OF OPERATION

WARNINGS



Always drive and ride with the seat backrest upright and the lap belt snug and low across the hips.



To reduce the risk of injury, make sure children sit where they can be properly restrained.



Never let a passenger hold a child on his or her lap while your vehicle is moving. The passenger cannot protect the child from injury in a crash which may result in serious injury or death.



All occupants of the vehicle, including the driver, should always properly wear their safety belts, even when an airbag supplemental restraint system is provided. Failure to properly wear your safety belt could seriously increase the risk of injury or death.



It is extremely dangerous to ride in a cargo area, inside or outside of a vehicle. In a crash, people riding in these areas are more likely to be seriously injured or killed. Do not allow people to ride in any area of your vehicle that is not equipped with seats and safety belts. Be sure everyone in your vehicle is in a seat and using a safety belt properly.



In a rollover crash, an unbelted person is significantly more likely to die than a person wearing a safety belt.



Each seating position in your vehicle has a specific safety belt assembly which is made up of one buckle and one tongue that are designed to be used as a pair. 1) Use the shoulder belt on the outside shoulder only. Never wear the shoulder belt under the arm. 2) Never swing the safety belt around your neck over the inside shoulder. 3) Never use a single belt for more than one person.

WARNINGS



When possible, all children 12 years old and under should be properly restrained in a rear seating position. Failure to follow this could seriously increase the risk of injury or death.



Safety belts and seats can become hot in a vehicle that has been closed up in sunny weather; they could burn a small child. Check seat covers and buckles before you place a child anywhere near them.



Front and rear seat occupants, including pregnant women, should wear safety belts for optimum protection in an accident.

All seating positions in this vehicle have lap and shoulder safety belts. All occupants of the vehicle should always properly wear their safety belts, even when an airbag supplemental restraint system is provided.

The safety belt system consists of:

- Lap and shoulder safety belts.
- Shoulder safety belt with automatic locking mode, (except driver safety belt).
- Height adjuster at the front outboard seating positions.
- Safety belt pretensioner at the front outboard seating positions.



- Safety belt warning light and chime.

FASTENING THE SEATBELTS

The front outboard and rear safety restraints in the vehicle are combination lap and shoulder belts.

Seatbelts

Using the Seatbelt with Cinch Tongue (Front Center and Rear Center Seats Only)

The cinch tongue will slide up and down the belt webbing when the belt is stowed or while putting seatbelts on. When the lap and shoulder seatbelts are buckled, the cinch tongue will allow the lap portion to be shortened, but pinches the webbing to keep the lap portion from getting longer. The cinch tongue is designed to slip during a crash, so always wear the shoulder belt properly and do not allow any slack in either the lap or shoulder portions.

Before you can reach and latch a lap and shoulder belt having a cinch tongue into the buckle, you may have to lengthen the lap belt portion of it.



E142587

1. Insert the belt tongue into the proper buckle (the buckle closest to the direction the tongue is coming from) until you hear a snap and feel it latch. Make sure you securely fasten the tongue in the buckle.

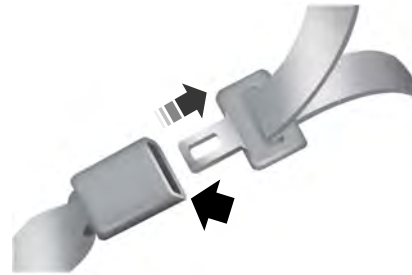

E142588

2. To unfasten, press the release button and remove the tongue from the buckle.



E162708

1. To lengthen the lap belt, pull some webbing out of the shoulder belt retractor.
2. While holding the webbing below the tongue, grasp the tip (metal portion) of the tongue so that it is parallel to the webbing and slide the tongue upward.
3. Provide enough lap belt length so that the tongue can reach the buckle.

Seatbelts

Fastening the Cinch Tongue

WARNING



Always drive and ride with your seatback upright and the lap belt snug and low across the hips.

1. Pull the lap and shoulder belt from the retractor so that the shoulder belt portion of the seatbelt crosses your shoulder and chest.
2. Be sure the belt is not twisted. If the belt is twisted, remove the twist.
3. Insert the belt tongue into the proper buckle for your seating position until you hear a snap and feel it latch.
4. Make sure the tongue is securely fastened to the buckle by pulling on the tongue.

While you are fastened in the seatbelt, the lap and shoulder belt with a cinch tongue adjusts to your movement. However, if you brake hard, turn hard, or if your vehicle receives an impact of 5 mph (8 km/h) or more, the seatbelt will become locked and help reduce your forward movement.

Lap Belts

WARNING



Always drive and ride with your seatback upright and the lap belt snug and low across the hips.

The front center lap belt does not adjust automatically.



E208768

Insert the tongue into the correct buckle (the buckle closest to the direction the tongue is coming from). To lengthen the belt, turn the tongue at a right angle to the belt and pull across your lap until it reaches the buckle. To tighten the belt, pull the loose end of the belt through the tongue until it fits snugly across the hips.

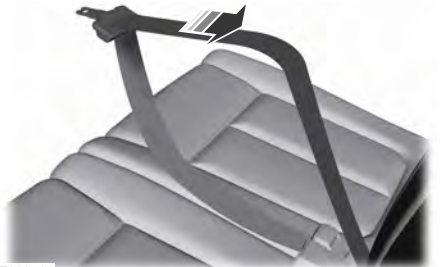

E208769

Shorten and fasten the belt when not in use.

Seatbelts

Using Seatbelts During Pregnancy

WARNING



Always ride and drive with your seatback upright and the seatbelt properly fastened. The lap portion of the seatbelt should fit snug and be positioned low across the hips. The shoulder portion of the seatbelt should be positioned across the chest. Pregnant women should also follow this practice. See the following figure.

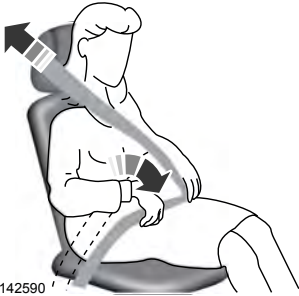

E142590

Pregnant women should always wear their seatbelt. Position the lap belt portion of a combination lap and shoulder belt low across the hips below the belly and worn as tight as comfort will allow. Position the shoulder belt to cross the middle of the shoulder and the center of the chest.

Seatbelt Locking Modes

WARNINGS



After any vehicle crash, the seatbelt system at all passenger seating positions must be checked by an authorized dealer to verify that the automatic locking retractor feature for child seats is still functioning properly. In addition, all seatbelts should be checked for proper function.

WARNINGS



The belt and retractor must be replaced if the seatbelt assembly automatic locking retractor feature or any other seatbelt function is not operating properly when checked by an authorized dealer. Failure to replace the belt and retractor assembly could increase the risk of injury in crashes.

The safety restraints in the vehicle are combination lap and shoulder belts. The driver seatbelt has the first type of locking mode. The front outboard passenger and rear outboard seat seatbelts have both types of locking modes described as follows:

Vehicle Sensitive Mode

This is the normal retractor mode, which allows free shoulder belt length adjustment to your movements and locking in response to vehicle movement. For example, if the driver brakes suddenly or turns a corner sharply, or the vehicle receives an impact of about 5 mph (8 km/h) or more, the combination seatbelts will lock to help reduce forward movement of the driver and passengers.

In addition, the retractor is designed to lock if you pull the webbing out too quickly. If this occurs, let the belt retract slightly and pull the webbing out again in a slow and controlled manner.

Automatic Locking Mode

In this mode, the shoulder belt automatically prelocks. The belt still retracts to remove any slack in the shoulder belt. The automatic locking mode is not available on the driver seatbelt or optional front center or rear center seatbelt.

Seatbelts

When to Use the Automatic Locking Mode

Use this mode any time a child safety seat, except a booster, is installed in passenger front or rear seating positions. You should properly restrain children 12 years old and under in a rear seating position whenever possible. See **Child Safety** (page 17).

How to Use the Automatic Locking Mode



E142591

1. Buckle the combination lap and shoulder belt.
2. Grasp the shoulder portion and pull downward until you pull the entire belt out.
3. Allow the belt to retract. As the belt retracts, you will hear a clicking sound. This indicates the seatbelt is now in the automatic locking mode.

How to Disengage the Automatic Locking Mode

Unbuckle the combination lap and shoulder belt and allow it to retract completely to disengage the automatic locking mode and activate the vehicle sensitive (emergency) locking mode.

Energy Management Feature

- This vehicle has a seatbelt system with an energy management feature at the front outboard seating positions to help further reduce the risk of injury in the event of a head-on crash.
- The front outboard seatbelt systems have a retractor assembly that is designed to pay out webbing in a controlled manner. This feature is designed to help reduce the belt force acting on the occupant's chest.

SEATBELT HEIGHT ADJUSTMENT

WARNING



Position the safety belt height adjuster so that the belt rests across the middle of your shoulder. Failure to adjust the safety belt properly could reduce the effectiveness of the safety belt and increase the risk of injury in a crash.

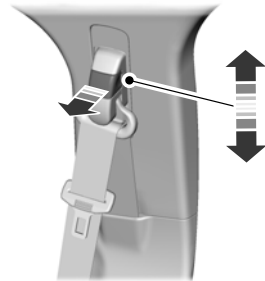

E145664

Adjust the height of the shoulder belt so the belt rests across the middle of your shoulder.

To adjust the shoulder belt height:

1. Pull the button and slide the height adjuster up or down.

Seatbelts

2. Release the button and pull down on the height adjuster to make sure it is locked in place.

SEATBELT WARNING LAMP AND INDICATOR CHIME



This lamp illuminates and an audible warning will sound if the driver's safety belt has not been fastened when the vehicle's ignition is turned on.

Conditions of operation

If...	Then...
The driver's safety belt is not buckled before the ignition switch is turned to the on position...	The safety belt warning light illuminates 1-2 minutes and the warning chime sounds 4-8 seconds.
The driver's safety belt is buckled while the indicator light is illuminated and the warning chime is sounding...	The safety belt warning light and warning chime turn off.
The driver's safety belt is buckled before the ignition switch is turned to the on position...	The safety belt warning light and indicator chime remain off.

SEATBELT REMINDER

Belt-Minder™

This feature supplements the safety belt warning function by providing additional reminders that intermittently sound a tone and illuminate the safety belt warning light when you are in the driver seat and the safety belt is unbuckled.

Seatbelts

If...	Then...
You buckle your safety belt before you switch the ignition switch on or less than 1-2 minutes elapse after you switch the ignition on...	The Belt-Minder feature will not activate.
You do not buckle your safety belt before your vehicle has reached at least 6 mph (9.7 km/h) and 1-2 minutes elapse after you switch the ignition on...	The Belt-Minder feature activates, the safety belt warning light illuminates and a warning tone sounds for six seconds every 25 seconds, repeating for about five minutes or until you buckle the safety belt.
The safety belt for the driver is unbuckled for about one minute while the vehicle is traveling at least 6 mph (9.7 km/h) and more than 1-2 minutes elapse after you switch the ignition on...	The Belt-Minder feature activates, the safety belt warning light illuminates and a warning tone sounds for six seconds every 25 seconds, repeating for about five minutes or until you buckle the safety belt.

Deactivating and Activating the Belt-Minder Feature (Driver Only)

WARNING



While the system allows you to deactivate it, this system is designed to improve your chances of being safely belted and surviving an accident. We recommend you leave the system activated for yourself and others who may use the vehicle. To reduce the risk of injury, do not deactivate or activate the system while driving the vehicle.

Read Steps 1 - 4 thoroughly before proceeding with the programming procedure.

Deactivate or activate the system by performing the following procedure:

Before following the procedure, make sure that:

- The parking brake is set.
- The transmission is in park (P) (if equipped) or neutral (N).
- The ignition is off.

- All vehicle doors are closed.
 - The driver safety belt is unbuckled.
 - The parking lamps and headlamps are off.
1. Turn the ignition on. Do not start the engine.
 2. Wait until the safety belt warning light turns off (about one or two minutes). You must complete Steps 3–5 within 60 seconds after the safety belt warning light turns off. If not completed, you must repeat the procedure.
 3. Buckle then unbuckle the safety belt three times at a moderate speed, ending with the safety belt in the unbuckled state. After Step 4, the safety belt warning light turns on for three seconds.
 4. Within seven seconds of the light turning on, buckle then unbuckle the safety belt.

Seatbelts

- This will switch the feature off for the seating position if it is currently on.
- This will switch the feature on for the seating position if it is currently off.

The safety belt warning light flashing four times per second for three seconds provides confirmation of disabling Belt-Minder.

The following sequence provides confirmation of enabling Belt-Minder:

- The safety belt warning light flashing four times per second for three seconds.
- The safety belt warning light turning off.
- The safety belt warning light flashing four times per second for three seconds.

After receiving confirmation, the procedure is complete.

CHILD RESTRAINT AND SEATBELT MAINTENANCE

Inspect the vehicle safety belts and child safety seat systems periodically to make sure they work properly and are not damaged. Inspect the vehicle and child seat safety belts to make sure there are no nicks, tears or cuts. Replace if necessary. All vehicle safety belt assemblies, including retractors, buckles, front safety belt buckle assemblies, buckle support assemblies (slide bar-if equipped), shoulder belt height adjusters (if equipped), shoulder belt guide on seat back (if equipped), child safety seat LATCH and tether anchors, and attaching hardware, should be inspected after a crash. Read the child restraint manufacturer's instructions for additional inspection and maintenance information specific to the child restraint.

Ford Motor Company recommends that all safety belt assemblies in use in vehicles involved in a crash be replaced. However, if the crash was minor and an authorized dealer finds that the belts do not show damage and continue to operate properly, they do not need to be replaced. Safety belt assemblies not in use during a crash should also be inspected and replaced if either damage or improper operation is noted.

Properly care for safety belts. See **Vehicle Care** (page 225).

SEATBELT EXTENSION

WARNINGS



Persons who fit into the vehicle's seatbelt should not use an extension. Unnecessary use could result in serious personal injury in the event of a crash.



Only use extensions provided free of charge by Ford Motor Company dealers. The dealer will provide an extension designed specifically for this vehicle, model year and seating position. The use of an extension intended for another vehicle, model year or seating position may not offer you the full protection of your vehicle's seatbelt restraint system.



Never use seatbelt extensions to install child restraints.



Do not use a seatbelt extension with an inflatable seatbelt.



Do not use extensions to change the fit of the belt across the torso, over the lap or to make the seatbelt buckle easier to reach.

Seatbelts

If, because of body size or driving position, it is not possible to properly fasten the seatbelt over your lap and shoulder, an extension that is compatible with the seatbelts is available free of charge from Ford Motor Company dealers. Only Ford seatbelt extensions made by the original equipment seatbelts manufacturer should be used with Ford seatbelts. Ask your authorized dealer if your extension is compatible with your Ford vehicle restraint system.

Keys and Remote Controls

GENERAL INFORMATION ON RADIO FREQUENCIES

This device complies with Part 15 of the FCC Rules and with Industry Canada license-exempt RSS standard(s). Operation is subject to the following two conditions: (1) This device may not cause harmful interference, and (2) This device must accept any interference received, including interference that may cause undesired operation.

Note: Changes or modifications not expressly approved by the party responsible for compliance could void the user's authority to operate the equipment. The term **IC** before the radio certification number only signifies that Industry Canada technical specifications were met.

The typical operating range for your transmitter is approximately 33 feet (10 meters). Vehicles with the remote start feature will have a greater range. One of the following could cause a decrease in operating range:

- weather conditions
- nearby radio towers
- structures around the vehicle
- other vehicles parked next to your vehicle

The radio frequency used by your remote control can also be used by other short distance radio transmissions, for example amateur radios, medical equipment, wireless headphones, remote controls and alarm systems. If the frequencies are jammed, you will not be able to use your remote control. You can lock and unlock the doors with the key.

Note: Make sure to lock your vehicle before leaving it unattended.

Note: If you are in range, the remote control will operate if you press any button unintentionally.

Note: The remote control contains sensitive electrical components. Exposure to moisture or impact may cause permanent damage.

REMOTE CONTROL

Integrated Keyhead Transmitters

(If Equipped)



E163046

Use the key blade to start your vehicle and unlock or lock the driver door from outside your vehicle. The transmitter portion functions as the remote control.



E163047

Note: Your vehicle's keys came with a security label that provides important vehicle key cut information. Keep the label in a safe place for future reference.

Replacing the Battery

Note: Refer to local regulations when disposing of transmitter batteries.

Note: Do not wipe off any grease on the battery terminals or on the back surface of the circuit board.

Keys and Remote Controls

Note: Replacing the battery does not delete the transmitter from the vehicle. The transmitter should operate normally.

The remote control uses one coin-type three-volt lithium battery CR2032 or equivalent.

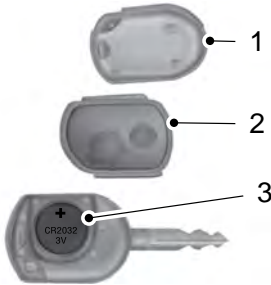

E163048

1. Twist a thin coin in the slot of the transmitter near the key ring to remove the battery cover.
2. Carefully peel up the rubber gasket from the transmitter. It may come off with the battery cover.
3. Remove the old battery.
4. Insert the new battery. Refer to the instructions inside the transmitter for the correct orientation of the battery. Press the battery down to make sure it is fully in the housing.
5. Reinstall the rubber gasket.
6. Snap the battery cover back onto the transmitter.

Car Finder



Press the button twice within three seconds. The horn sounds and the direction indicators flash. We recommend you use this method to locate your vehicle, rather than using the panic alarm.

Sounding a Panic Alarm

Note: The panic alarm only operates when the ignition is off.



Press the button to activate the alarm. Press the button again or switch on the ignition on to deactivate it.

REPLACING A LOST KEY OR REMOTE CONTROL

Replacement keys or remote controls can be purchased from an authorized dealer. Authorized dealers can program remote controls for your vehicle. See **Passive Anti-Theft System** (page 42).

Doors and Locks

LOCKING AND UNLOCKING

You can use the power door lock control or the remote control to lock and unlock your vehicle.

Power Door Locks (If Equipped)

The power door lock control is on the driver and front passenger door panels.

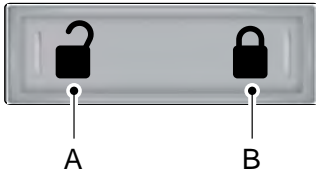

E163049

- A Unlock
- B Lock

Remote Control (If Equipped)

Unlocking the Doors (Two-Stage Unlock)



Press the button to unlock the driver door.

Press the button again within three seconds to unlock all doors. The turn signals will flash.

Press and hold both the lock and unlock buttons on the remote control for four seconds to disable or enable two-stage unlocking. Disabling two-stage unlocking allows all vehicle doors to unlock with one press of the button. The turn signals will flash twice to indicate a change to the unlocking mode. The unlocking mode applies to the remote control and keyless entry keypad.

Locking the Doors



Press the button to lock all the doors. The turn signals will illuminate.

Press the button again within three seconds to confirm that all the doors are closed. The doors will lock again, the horn will sound and the turn signals will illuminate if all the doors are closed.

Mislock

If any door is open or if the hood is open on vehicles with an anti-theft alarm or remote start, the horn will sound twice and the lamps will not flash.

Smart Unlocks (If Equipped)

This feature helps to prevent you from locking yourself out of your vehicle if your key is still in the ignition.

When you open the driver door and lock your vehicle with the power door lock control, all the doors will lock then unlock if your key is still in the ignition.

You can still lock your vehicle with the key in the ignition by:

- using the manual lock on the door
- locking the driver door with a key
- using the keyless entry keypad
- using the lock button on the remote control

Autolock and Autounlock (If Equipped)

The autolock feature will lock all the doors when:

- all doors are closed, and
- the ignition is on, and
- you shift into any gear putting your vehicle in motion, and
- your vehicle attains a speed greater than 12 mph (20 km/h).

Doors and Locks

The autolock feature will unlock all the doors when:

- autolock has locked the doors
- you stop the vehicle and switch the ignition off or to accessory mode, and
- you open the driver door within 10 minutes.

Note: *The doors will not autounlock if you have electronically locked them before opening the driver door.*

Enabling or Disabling

You can enable or disable these features in the information display or your authorized dealer can do it for you. See **General Information** (page 62).

Note: *You can enable or disable the autolock and autounlock features independently of each other.*

Illuminated Entry

The interior lamps and select exterior lamps will illuminate when you unlock the doors with the remote entry system.

The illuminated entry system will turn off the lights if:

- the ignition is on
- you press the remote control lock button, or
- after 25 seconds of illumination.

The dome lamp will not turn on if the control is set to the off position.

The lights will not turn off if:

- you turn them on with the dimmer control, or
- any door is open.

Battery Saver

The battery saver turns off the interior lamps 30 minutes after you switch the ignition off if a door is open and the dome lamp switch is on. It turns off the interior lamps after 10 minutes if the dome lamp switch is off.

Security

PASSIVE ANTI-THEFT SYSTEM (If Equipped)

Note: *The system is not compatible with non-Ford aftermarket remote start systems. Use of these systems may result in engine starting problems and a loss of security protection.*

Note: *Metallic objects, electronic devices or a second coded key on the same key chain may result in vehicle starting problems, especially if they are too close to the key when starting your vehicle. Prevent these objects from touching the coded key when starting your vehicle. Switch the ignition off, move all objects on the key chain away from the coded key and restart your vehicle if a problem occurs.*

Note: *Do not leave a duplicate coded key in your vehicle. Always take your keys and lock all doors when leaving your vehicle.*

SecuriLock®

The system helps prevent the engine from starting unless you use a coded key programmed to your vehicle. Using the wrong key may prevent your vehicle from starting. A message may appear in the information display.

If you are unable to start your vehicle with a coded key, it is not operating correctly. A message may appear in the information display.

Automatic Arming

The system arms when you switch the ignition off.

Automatic Disarming

The system disarms when you switch the ignition on with a coded key.

Replacement Keys

Note: *Your vehicle may have two integrated keyhead transmitters.*

The integrated keyhead transmitter functions as a programmed ignition key that operates all the locks and starts your vehicle, as well as a remote control.

If your programmed transmitters or standard SecuriLock coded keys are lost or stolen and you do not have an extra coded key, you will need to have your vehicle towed to an authorized dealer. You need to erase the key codes from your vehicle and program new coded keys.

Store an extra programmed key away from your vehicle in a safe place. Contact an authorized dealer to purchase additional spare or replacement keys.

Programming a Spare Key

Note: *You can program a maximum of six keys to your vehicle.*

You can program your own integrated keyhead transmitter or standard SecuriLock coded keys to your vehicle. This procedure programs both the vehicle immobilizer keycode and the remote control to your vehicle.

Only use integrated keyhead transmitters or standard SecuriLock keys.

You must have two previously programmed coded keys and the new unprogrammed key readily accessible. Contact an authorized dealer to have the spare key programmed if two previously programmed keys are not available.

Read and understand the entire procedure before you begin.

1. Insert the first previously programmed coded key into the ignition.
2. Switch the ignition from off to on. Keep the ignition on for at least 3 seconds, but no more than 10 seconds.

Security

3. Switch the ignition off and remove the first coded key from the ignition.
4. After at least 3 seconds but within 10 seconds of switching the ignition off, insert the second previously coded key into the ignition.
5. Switch the ignition from off to on. Keep the ignition on for at least 3 seconds, but no more than 10 seconds.
6. Switch the ignition off and remove the second previously programmed coded key from the ignition.
7. After at least 3 seconds but within 10 seconds of switching the ignition off and removing the previously programmed coded key, insert the new unprogrammed key into the ignition.
8. Switch the ignition from off to on. Keep the ignition on for at least six seconds.
9. Remove the newly programmed coded key from the ignition.

The doors lock then unlock to confirm that programming was successful. If you have successfully programmed the new integrated keyhead transmitter, it will start your vehicle and operate the remote entry system.

If programming was unsuccessful, wait 20 seconds and repeat Steps 1 through 8. If you are still unsuccessful, take your vehicle to an authorized dealer.

Steering Wheel

ADJUSTING THE STEERING WHEEL

WARNING

 Do not adjust the steering wheel when your vehicle is moving.

Note: Make sure that you are sitting in the correct position. See **Sitting in the Correct Position** (page 73).



E183047

1. Unlock the steering column.
2. Adjust the steering wheel to the desired position.



E183049

3. Lock the steering column.

AUDIO CONTROL (If Equipped)

You can operate the following functions with the control:

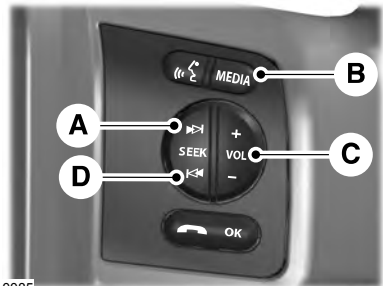

E210085

- A Seek up or next.
- B Media.
- C Volume up and down.
- D Seek down or previous.

Steering Wheel

Media

Press repeatedly to scroll through available audio modes.

Seek, Next or Previous

Press the seek button to:

- Tune the radio to the next or previous stored preset.
- Play the next or the previous track.

Press and hold the seek button to:

- Tune the radio to the next station up or down the frequency band.
- Seek through a track.

VOICE CONTROL (If Equipped)

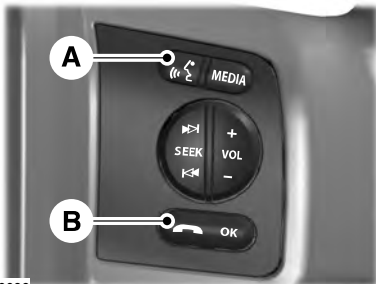

E210086

- A Voice recognition.
- B Answer or end call.

CRUISE CONTROL



E163053

See **Cruise Control** (page 132).

INFORMATION DISPLAY CONTROL



E163054

See **Information Displays** (page 62).

Wipers and Washers

WINDSHIELD WIPERS

Note: Fully defrost the windshield before switching on the windshield wipers.

Note: Make sure you switch off the windshield wipers before entering a car wash.

Note: Clean the windshield and wiper blades if they begin to leave streaks or smears. If that does not resolve the issue, install new wiper blades.

Note: Do not operate the wipers on a dry windshield. This may scratch the glass, damage the wiper blades or cause the wiper motor to burn out. Always use the windshield washers before wiping a dry windshield.

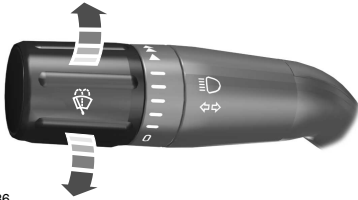

E213986

Rotate the end of the control:

- Away from you to increase the wiper speed.
- Toward you to decrease the wiper speed.

WINDSHIELD WASHERS

Note: Do not operate the wipers on a dry windshield. This may scratch the glass, damage the wiper blades or cause the wiper motor to burn out. Always use the windshield washer before wiping a dry windshield.

Note: Do not operate the washers when the washer reservoir is empty. This may cause the washer pump to overheat.

Press the end of the stalk to activate the washer.

- A brief press causes a single wipe without washer fluid.
- A quick press and hold causes the wipers to swipe three times with washer fluid.
- A long press and hold activates the wipers and washer fluid for up to 10 seconds.



E213988

Lighting

GENERAL INFORMATION

Condensation in Lamp Assemblies

Exterior lamps have vents to accommodate normal changes in air pressure.

Condensation can be a natural by-product of this design. When moist air enters the lamp assembly through the vents, there is a possibility that condensation can occur when the temperature is cold. When normal condensation occurs, a fine mist can form on the interior of the lens. The fine mist eventually clears and exits through the vents during normal operation.

Clearing time may take as long as 48 hours under dry weather conditions.

Examples of acceptable condensation are:

- The presence of a fine mist (no streaks, drip marks or large droplets).
- A fine mist covers less than 50% of the lens.

Examples of unacceptable condensation are:

- A water puddle inside the lamp.
- Streaks, drip marks or large droplets present on the interior of the lens.

If you see any unacceptable condensation, have your vehicle checked by an authorized dealer.

LIGHTING CONTROL



E163267

- Rotate the headlamp control clockwise to the first position to switch on the parking lamps and instrument panel lamps.
- Rotate clockwise to the second position to also switch on the headlamps.

High Beams

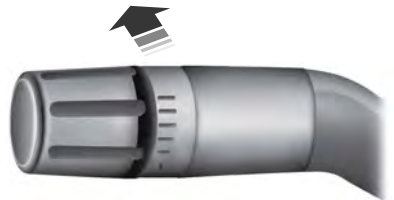

E167827

Push the lever toward the instrument panel to switch the high beams on.

Push the lever toward the instrument panel again or pull the lever towards you to switch the high beams off.

Lighting

Headlamp Flasher

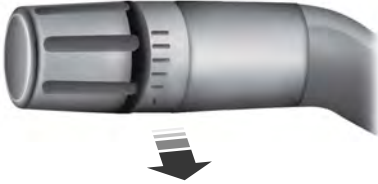

E163268

Pull the lever toward you to flash the headlamps and release the lever to switch the headlamps off.

INSTRUMENT LIGHTING DIMMER



E163270

Use to adjust the brightness of the instrument panel and all applicable lit components in the vehicle during headlamp and parking lamp operation.

- Tap the top or bottom of the control to brighten or dim all interior lit components incrementally.
- Press and hold at the first position of the top or bottom of the control until you reach the desired lighting level.

DAYTIME RUNNING LAMPS (If Equipped)

WARNING

 Always remember to switch your headlamps on in low light situations or during inclement weather. The system does not activate the tail lamps and may not provide adequate lighting during these conditions. Failure to activate your headlamps under these conditions may result in a collision.

The system turns on the headlamps with a reduced output in daylight conditions.

To switch the system on:

1. Switch on the ignition.
2. Switch the lighting control to the off or parking lamp position.

DIRECTION INDICATORS



E163272

- To operate the left direction indicator, push the lever down.
- To operate the right direction indicator, push the lever up.
- To cancel direction indicator operation manually, push the lever again in the opposite direction.

Lighting

If your vehicle is a tractor, the direction indicators may not shut off when you complete a turn. This is normal. Contact an authorized dealer if there are any questions about your vehicle's options.

INTERIOR LAMPS

Map Lamps

The map lamps are located on the overhead console. Press the controls on either side of each map lamp to switch on the lamps. The map lamps also light when:

- You open any door.
- You press any of the remote entry controls when the ignition is off.

Press the switches on either side of the dome lamp to switch on the lamps. The map lamps also light when:

- You open any door.
- You press any of the remote entry controls when the ignition is off.



E163273

Dome and Map Lamps



E163274

Windows and Mirrors

POWER WINDOWS (If Equipped)

WARNINGS



Do not leave children unattended in your vehicle and do not let them play with the power windows. They may seriously injure themselves.



When closing the power windows, you should verify they are free of obstructions and make sure that children and pets are not in the proximity of the window openings.



E163056

Note: You may hear a pulsing noise when just one of the windows is open. Lower the opposite window slightly to reduce this noise.

Press the switch to open the window.

Lift the switch to close the window.

One-Touch Up or Down (If Equipped)

Press or lift the switch fully and release it. Press or lift it again to stop the window.

Note: The window may disable for up to five minutes if you cycle it up and down repeatedly. This helps prevent damage to the motor. Normal operation resumes once the motor cools.

Restoring the One-Touch Up Function

You may lose the one-touch function if the vehicle battery is low.

Note: Perform one-touch up re-calibration with the door closed. Calibrating with the door open causes the window to bounce back continuously.

To reset the function after the battery recharges:

1. Pull the switch all the way up.
2. Hold the switch until the glass stops and continue to hold for two seconds.
3. Press the switch down and operate the window to the full down position. One-touch up is now functional.

Bounce-Back (If Equipped)

The window stops automatically while closing. It reverses some distance if there is an obstacle in the way.

Overriding the Bounce-Back Feature

WARNING



When you override the bounce-back feature, the window will not reverse if it detects an obstacle. Take care when closing the windows to avoid personal injury or damage to your vehicle.

Pull up the window switch and hold within two seconds of the window reaching the bounce-back position. The window travels up with no bounce-back protection. The window stops if you release the switch before the window closes fully.

Window Lock (If Equipped)

Press the control to lock or unlock the rear window controls.

Windows and Mirrors

EXTERIOR MIRRORS

Auxiliary Convex Mirrors



E208233

Convex mirrors are a ball-stud design for precise adjustment to maximize viewing area.

Power Exterior Mirrors (If Equipped)

WARNING



Do not adjust the mirrors when your vehicle is moving.

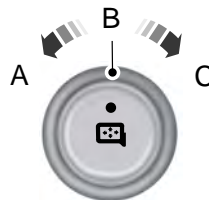

E163059

- A Left-hand mirror.
- B Off.
- C Right-hand mirror.

To adjust a mirror:

1. Rotate the control to select the mirror you want to adjust.
2. Adjust the position of the mirror.
3. Return the control to the center position to lock mirrors in place.

Foldaway Exterior Mirrors

For tight parking conditions, you can push the mirror toward the door window glass. Before driving, make sure that you fully engage the mirror in its support when returning it to its original position.

Power-Folding Mirrors (If Equipped)



E163060

1. Rotate the control so the dots line up.
2. Pull the control back to fold the mirrors in or out.

Windows and Mirrors

Note: If you repeatedly fold and unfold the mirrors several times within one minute, the system may disable to protect the motors from overheating. It resets to normal function automatically within three to five minutes.

You can also fold a mirror manually by pushing it toward the door window glass. After you manually adjust the mirror, you need to reset it.

To reset the power-folding mirror system and return it to its normal function:

- Fold the mirror manually by pushing it toward the door window glass.
- Use the power-fold control to fold and unfold the mirror two or three times. The mirror makes a sound as it resets.

Heated Exterior Mirrors (If Equipped)

See **Heated Exterior Mirrors** (page 72).

Signal Indicator Mirrors (If Equipped)

The outer portion of the appropriate mirror housing blinks when you use the direction indicator.

Clearance Lamps (If Equipped)

The lower, outer part of the mirror housings light when you switch on the headlamps or parking lamps.

Telescoping Mirrors (If Equipped)

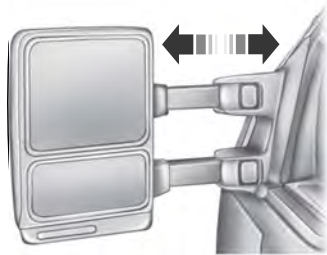

E163061

This feature lets you extend the mirror about 3 in (76 mm). It is useful when towing a trailer. You can manually pull out or push in the mirrors to the desired position.

PowerScope™ Power Telescoping Mirrors (If Equipped)

This feature lets you position both mirrors in or out at the same time. The control is on the door trim panel.

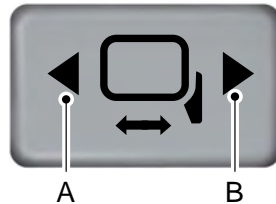

E163062

- A Telescope out.
- B Telescope in.

Windows and Mirrors

To adjust the mirrors:

- Press and hold the control.
- When you position the mirrors in or out, the motors run as long as you hold the control. The running motors allow you to make adjustments as needed.
- After positioning the mirrors, return the control to the center position to help protect the motors from overheating.

INTERIOR MIRROR (If Equipped)

WARNING



Do not adjust the mirror when your vehicle is moving.

Note: Do not clean the housing or glass of any mirror with harsh abrasives, fuel or other petroleum or ammonia-based cleaning products

You can adjust the interior mirror to your preference. Some mirrors also have a second pivot point. This lets you move the mirror head up or down and from side to side.

Pull the tab below the mirror toward you to reduce glare at night.

SUN VISORS

Slide-on-rod (If Equipped)

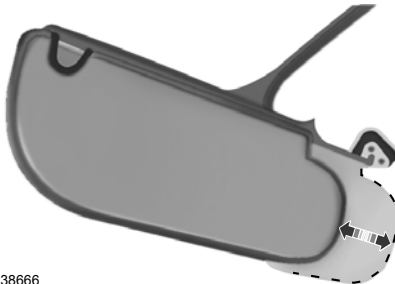

E138666

Rotate the sun visor toward the side window and extend it rearward for extra shade.

Instrument Cluster

GAUGES

Gasoline Engines

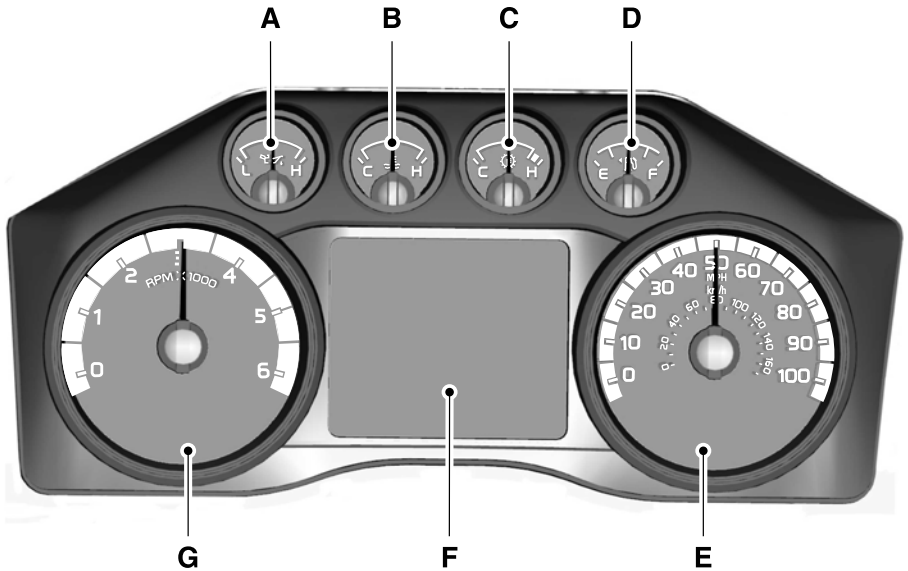

E215247

- A Engine oil pressure gauge.
- B Engine coolant temperature gauge.
- C Transmission fluid temperature gauge.
- D Fuel gauge.
- E Speedometer.
- F Information display.
- G Tachometer.

Instrument Cluster

Engine Oil Pressure Gauge

Indicates engine oil pressure. The needle should stay in the normal operating range (between L and H). If the needle falls below the normal range, stop the vehicle, switch off the engine and check the engine oil level. Add oil if needed. If the oil level is correct, have your vehicle checked by an authorized dealer.

Engine Coolant Temperature Gauge

WARNING



Never remove the coolant reservoir cap while the engine is running or hot.

Indicates engine coolant temperature. At normal operating temperature, the level indicator is in the normal range. If the engine coolant temperature exceeds the normal range, stop the vehicle as soon as safely possible, switch off the engine and let the engine cool.

Transmission Fluid Temperature Gauge

Indicates transmission fluid temperature. At normal operating temperature, the level indicator is in the normal range. If the transmission fluid temperature exceeds the normal range, stop the vehicle as soon as safely possible and verify the airflow is not restricted such as snow or debris blocking airflow through the grille.

Special operating conditions, such as snowplowing, towing or off-road use, can cause higher than normal operating temperatures. See **Special Operating Conditions Scheduled Maintenance** (page 328).

Operating the transmission for extended periods with the gauge in the higher than normal area may cause internal transmission damage. We recommend altering the severity of the driving conditions to lower the transmission temperature into the normal range. If the gauge continues to show high temperatures, contact an authorized dealer.

Fuel Gauge

Note: *The fuel gauge may vary slightly when your vehicle is moving or on a gradient.*

Switch the ignition on. The fuel gauge indicates approximately how much fuel is in the fuel tank. The arrow adjacent to the fuel pump symbol indicates on which side of your vehicle the fuel filler door is located.

The needle should move toward F when you refuel your vehicle. If the needle points to E after adding fuel, this indicates your vehicle needs service soon.

After refueling, some variability in needle position is normal:

- It may take a short time for the needle to reach F after leaving the gas station. This is normal and depends upon the slope of pavement at the gas station.
- The fuel amount dispensed into the tank is a little less or more than the gauge indicated. This is normal and depends upon the slope of pavement at the gas station.
- If the gas station nozzle shuts off before the tank is full, try a different gas pump nozzle.

Gauge Package (If Equipped)

If your vehicle is equipped with the optional gauge package, it has some or all of the following gauges:

Instrument Cluster

- **Transmission temperature gauge:** Displays the transmission fluid temperature at the transmission sump.
- **Hourmeter:** Displays the hours of engine run time.
- **Voltmeter:** Displays electrical system voltage.

Information Display

Odometer

Located in the bottom of the information display. Registers the accumulated distance your vehicle has traveled.

Trip Computer

See **General Information** (page 62).

Vehicle Settings and Personalization

See **General Information** (page 62).

Diesel Engines

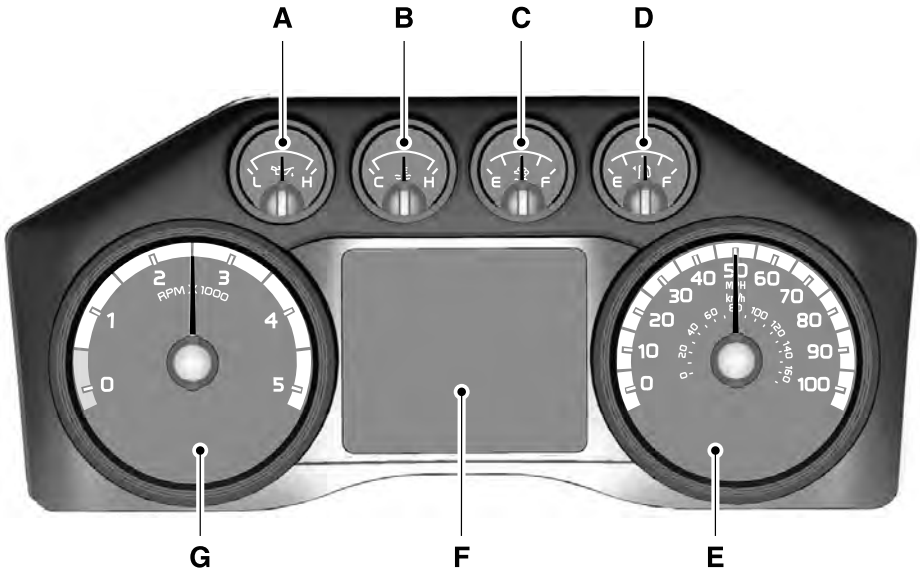

E207382

- A Engine oil pressure gauge.
- B Engine coolant temperature gauge.
- C Diesel Exhaust Fluid (DEF) gauge.

Instrument Cluster

- D Fuel gauge.
- E Speedometer.
- F Information display.
- G Tachometer.

Engine Oil Pressure Gauge

Indicates engine oil pressure. The needle should stay in the normal operating range (between L and H). If the needle falls below the normal range, stop the vehicle, switch off the engine and check the engine oil level. Add oil if needed. If the oil level is correct, have your vehicle checked by an authorized dealer.

Engine Coolant Temperature Gauge

WARNING



Never remove the coolant reservoir cap while the engine is running or hot.

Indicates engine coolant temperature. At normal operating temperature, the level indicator is in the normal range. If the engine coolant temperature exceeds the normal range, stop the vehicle as soon as safely possible, switch off the engine and let the engine cool.

Diesel Exhaust Fluid (DEF) Gauge

Indicates the fluid level in the DEF tank.

Fuel Gauge

Note: *The fuel gauge may vary slightly when your vehicle is moving or on a gradient.*

Switch the ignition on. The fuel gauge indicates approximately how much fuel is in the fuel tank. The arrow adjacent to the fuel pump symbol indicates on which side of your vehicle the fuel filler door is located.

The needle should move toward F when you refuel your vehicle. If the needle points to E after adding fuel, this indicates your vehicle needs service soon.

After refueling, some variability in needle position is normal:

- It may take a short time for the needle to reach F after leaving the gas station. This is normal and depends upon the slope of pavement at the gas station.
- The fuel amount dispensed into the tank is a little less or more than the gauge indicated. This is normal and depends upon the slope of pavement at the gas station.
- If the gas station nozzle shuts off before the tank is full, try a different gas pump nozzle.

Gauge Package (If Equipped)

If your vehicle is equipped with the optional gauge package, it has some or all of the following gauges:

- **Transmission temperature gauge:** Displays the transmission fluid temperature at the transmission sump.
- **Hourmeter:** Displays the hours of engine run time.
- **Voltmeter:** Displays electrical system voltage.

Information Display

Odometer

Located in the bottom of the information display. Registers the accumulated distance your vehicle has traveled.

Instrument Cluster

Trip Computer

See **General Information** (page 62).

Vehicle Settings and Personalization

See **General Information** (page 62).

WARNING LAMPS AND INDICATORS

The following warning lamps and indicators alert you to a vehicle condition that may become serious. Some lamps illuminate when you start your vehicle to make sure they work. If any lamps remain on after starting your vehicle, refer to the respective system warning lamp for further information.

Note: *Some warning indicators appear in the information display and function the same as a warning lamp but do not display when you start your vehicle.*

Anti-Lock Braking System



If it illuminates when you are driving, this indicates a malfunction. You continue to have the normal braking system (without ABS) unless the brake system warning lamp is also illuminated. Have the system checked by an authorized dealer.

Automatic Regeneration Control



Illuminates when you switch it off.

Battery



If it illuminates while driving, it indicates a malfunction. Switch off all unnecessary electrical equipment and have the system checked by an authorized dealer immediately.

Brake System



Indicates low brake fluid level or a brake system malfunction. Have the system checked immediately by an authorized dealer.

WARNING



Driving your vehicle with the warning lamp on is dangerous. A significant decrease in braking performance may occur. It will take you longer to stop your vehicle. Have your vehicle checked by your authorized dealer immediately.

Check Fuel Cap



Illuminates when you may not have properly installed the fuel cap. Continued driving with this light on may cause the Service engine soon warning indicator to come on.

Check Suspension (If Equipped)



Illuminates when you press the air suspension dump switch.

Cruise Control (If Equipped)



Illuminates when you switch on this feature. See **Using Cruise Control** (page 132).

Diesel Exhaust Fluid (Diesel Engine Only)



Illuminates with the key in the ON position, when the fluid is contaminated or the level falls below 1.0 gal (3.8 L). Refill the tank or, at a minimum, add at least 1.0 gal (3.8 L) in the tank.

Instrument Cluster

Diesel Particulate Filter (Diesel Engine Only)

Illuminates when the soot level in the diesel particulate filter has reached a point where it requires operator assistance. See **Diesel Particulate Filter** (page 87).

Direction Indicator



Illuminates when you switch on the left or right direction indicator or when you switch on the hazard warning flashers. If the indicators stay on or flash faster, check for a burned out bulb.

Door Ajar



Displays when the ignition is on and any door is not completely closed.

Electronic Locking Differential (if Equipped)



Illuminates when using the electronic locking differential.

Engine Oil Pressure



If it illuminates with the engine running, or when you are driving, this indicates a malfunction.

Stop your vehicle as soon as it is safe to do so and switch off the engine. Check the engine oil level.

Note: Do not resume your journey if it illuminates despite the level being correct. Have the system checked by an authorized dealer immediately.

Exhaust Brake On



The exhaust brake indicator light illuminates when you switch the exhaust brake on.

Fasten Seatbelt



Illuminates and a tone sounds to remind you to fasten your seatbelt.

High Beam



Illuminates when you switch on the high beam headlamps. It flashes when you use the headlamp flasher.

Hydromax



Illuminates to indicate normal hydromax booster reserve system activation when the engine is off and the service brake pedal is applied. This light may also illuminate momentarily if the engine is running and the driver turns the steering wheel fully in one direction while braking. If the light remains on while the engine is running, this indicates inadequate hydraulic booster pressure or reserve pump system failure. Stop the vehicle as soon as possible and seek service immediately by your authorized dealer.

Low Fuel Level (Gasoline Engine Only)



Illuminates when the fuel level is low or the fuel tank is nearly empty. Refuel as soon as possible.

Parking Brake Warning



Illuminates briefly when you switch the ignition to the on position (with the engine off). It also illuminates when you apply the parking brake. If the park brake lamp does not illuminate at these times, seek service immediately. Vehicles equipped with the power park parking brake option: If the park

Instrument Cluster

brake warning lamp begins to blink after setting the parking brake, this may indicate a failure in the parking brake system. Seek service from an authorized dealer immediately. Driving extended distances with the parking brake engaged can cause brake failure and the risk of personal injury.

Powertrain Malfunction/Reduced Power/Electronic Throttle Control (Gasoline Engine Only)



Illuminates in the event of a powertrain fault. Contact an authorized dealer as soon as possible.

Service Engine Soon



The service engine soon indicator light illuminates when you first switch on the ignition, before starting the engine, to check the bulb and to indicate whether the vehicle is ready for Inspection/Maintenance (I/M) testing.

If the service engine soon indicator light stays illuminated after you start the engine, it indicates that the On-Board Diagnostics (OBD-II) system has detected a malfunction of the vehicle emissions control system.

WARNING



Under engine misfire conditions, excessive exhaust temperatures could damage the catalytic converter, the fuel system, interior floor coverings or other vehicle components, possibly causing a fire. Have an authorized dealer service your vehicle immediately.

Traction Control (Diesel Engine Only)



Illuminates and flashes slowly if you select the Off Road or Mud/Snow mode. It illuminates and flashes rapidly during a traction control event.

Trailer Anti-Lock Brake System (ABS)



Illuminates briefly when you switch on the ignition, and only when a PLC trailer or a PLC diagnostic tool is connected. If the light fails to illuminate, remains on after you start the vehicle or continues to flash, have the system serviced immediately.

Transmission Tow/Haul (If Equipped)



Illuminates when you switch on the tow/haul feature. If the light flashes steadily, have the system serviced immediately, damage to the transmission could occur.

Two Speed Axle



The Two Speed Axle indicator comes on when you switch the low axle range on.

Wait to Start (Diesel Engine Only)



Illuminates when you switch the ignition on as part of the pre-start system. Wait until the wait to start indicator turns off before attempting to start vehicle.

Instrument Cluster

WARNING



If equipped with an air intake heater, DO NOT use ether or any other starting fluids. The use of starting fluids (ether) in an engine equipped with an air intake heater could result in damage and/or personal injury.

Water in Fuel



Illuminates when the fuel filter/water separator has a significant quantity of water in it.

If the light illuminates when the engine is running, stop the vehicle as soon as safely possible, shut off the engine, then drain the fuel filter/water separator.

Allowing water to stay in the system could result in extensive damage to, or failure of, the fuel injection system.

WARNING



Do not drain the water separator while the engine is running. Fuel may ignite if the separator is drained while the engine is running or the vehicle is moving.

AUDIBLE WARNINGS AND INDICATORS

Beltminder Warning

Sounds when a safety belt is unfastened in an occupied seat and your vehicle is moving.

Door Ajar

Sounds when a door is not fully closed and your vehicle is moving.

Headlamps On Warning Chime

Sounds when you remove the key from the ignition and open the driver's door and you have left the headlamps or parking lamps on.

Key in Ignition Warning Chime

Sounds when you open the driver's door and you have left the key in the ignition with it in the off or accessory position.

Parking Brake On Warning Chime

Sounds when you have left the parking brake on and drive your vehicle. If the warning chime remains on after you have released the parking brake, have the system checked by your authorized dealer immediately.

Information Displays

GENERAL INFORMATION

WARNING



Driving while distracted can result in loss of vehicle control, crash and injury. We strongly recommend that you use extreme caution when using any device that may take your focus off the road. Your primary responsibility is the safe operation of your vehicle. We recommend against the use of any hand-held device while driving and encourage the use of voice-operated systems when possible. Make sure you are aware of all applicable local laws that may affect the use of electronic devices while driving.

You can control various systems on your vehicle using the information display controls on the steering wheel. The information display provides the corresponding information.

Information Display Controls

- Press the INFO button to scroll through trip, outside temperature and fuel usage information.
- Press the SETUP button to scroll through various vehicle feature settings.
- Press the RESET button to choose settings, reset information and confirm messages.

Info

Press the INFO button repeatedly to cycle through the following features:

Note: *Some options may appear slightly different or not at all if the items are optional.*

INFO
TRIP A
TRIP B
XXX MILES (km) TO E
XX.X AVG MPG (L/100km)
MPG (L/km)
TIMER
EXHAUST FILTER*
TRANS TEMP
BATT. VOLTAGE
BLANK SCREEN

*Diesel engine only.

Information Displays

TRIP A/B

Registers the distance of individual journeys. Press and release the INFO button until TRIP A/B appears in the display (this represents the trip mode). Press and hold the RESET button to reset.

XXX MILES (km) TO E

This displays an estimate of approximately how far you can drive with the fuel remaining in your tank under normal driving conditions. Remember to turn the ignition off when refueling to allow this feature to detect the correct amount of added fuel.

The system calculates the distance to empty by using a running average fuel economy, which uses your recent driving history of 500 miles (800 km).

This value is not the same as the average fuel economy display. The running average fuel economy resets to a factory default value if the battery is disconnected.

XX.X AVG MPG (L/100km)

Average fuel economy displays your average fuel economy in miles per gallon or liters/100 km.

MPG (L/km)

Displays the instantaneous fuel economy as a bar graph. Your vehicle must be moving to calculate instantaneous fuel economy. You cannot reset the instantaneous fuel economy.

TIMER

Displays the trip elapsed drive time. Press and release RESET to pause the timer. Press and hold RESET to reset the timer.

EXHAUST FILTER

Displays information about the status of the exhaust filter.

System Check and Vehicle Feature Customization

Press the SETUP button repeatedly to cycle the information display through the following features:

Note: *Some options may appear slightly different or not at all if the items are optional.*

Note: *When returning to the SETUP menu and you selected a non-English language, HOLD RESET FOR ENGLISH displays to change back to English. Press and hold the RESET button to change back to English.*

SETUP		
RESET FOR SYSTEM CHECK	Press the RESET button	OIL LIFE
		ENGINE HOURS
		DEF LEVEL*
		ALL DOORS CLOSED
		CHECK BRAKE SYSTEM
OIL LIFE	HOLD RESET = NEW	
UNITS	English or Metric	

Information Displays

SETUP	
AUTO LOCK	ON or OFF
AUTO UNLOCK	ON or OFF
COURTESY WIPE	ON or OFF
REMOTE WINDOW	ON or OFF
LANGUAGE	ENGLISH / SPANISH / FRENCH

*Diesel engine only.

PRESS RESET FOR SYSTEM CHECK

The information display begins to cycle through the vehicle systems and provides a status of the item if needed.

Note: *Some systems show a message only if a condition is present.*

OIL LIFE

Displays the remaining oil life. An oil change is required whenever indicated by the information display and according to the recommended maintenance schedule. Only use recommended engine oils.

To reset the oil monitoring system to 100% after each oil change, perform the following:

1. Press and release the SETUP button to display OIL LIFE XXX% HOLD RESET = NEW.
2. Press and hold the RESET button for two seconds and release to reset the oil life to 100%.

Note: *To change oil life 100% value (if equipped with this feature) to another value, proceed to Step 3.*

3. Once OIL LIFE SET TO XXX% is displayed, release and press the RESET button to change the Oil Life Start Value. Each release and press reduces the value by 10%.

UNITS

Displays the current units English or Metric.

LANGUAGE = ENGLISH / SPANISH / FRENCH

Allows you to choose which language the message center displays.

Waiting four seconds or pressing the RESET button cycles the message center through each of the language choices.

Press the RESET button to set the language choice.

INFORMATION MESSAGES

Note: *Depending on your vehicle options and instrument cluster type, not all of the messages display or are available. Additionally, the information display may abbreviate or shorten certain messages.*

Press the RESET button to acknowledge and remove some messages from the information display. The information display automatically removes other messages after a short time.

You need to confirm certain messages before you can access the menus.

Information Displays

Diesel Messages

WARNING



When the CLEANING EXHAUST FILTER message appears in the information display, do not park near flammable materials, vapors or structures until filter cleaning is complete.

Message	Action
CHECK COOLANT ADDITIVE	The coolant additive needs checking.
CLEANING EXHAUST FILTER	Your vehicle has entered the cleaning mode. Various engine actions raise the exhaust temperature in the diesel particulate filter system to burn off the particles (exhaust soot). After the vehicle burns off the particles, the exhaust temperature returns to normal levels. This message is normal.
EXHAUST OVER-LOADED DRIVE TO CLEAN EXHAUST AT LIMIT DRIVE TO CLEAN NOW	The diesel particulate filter is full of particles (exhaust soot) and you are not operating the vehicle in a manner that allows normal cleaning. One of these messages stays on until the exhaust filter cleaning has begun, at which time the CLEANING EXHAUST FILTER message displays. We recommend you drive the vehicle above 30 mph (48 km/h) until the CLEANING EXHAUST FILTER message turns off. The diesel particulate filter continues to fill with particles (exhaust soot) if you ignore this message. The service engine soon light illuminates and engine power may be limited, if cleaning is not permitted. Your vehicle requires dealer service to restore it to full-power operation.
STOP SAFELY NOW	Your vehicle exhaust system temperature exceeds intended operating range. If this warning occurs, a chime sounds, followed by reduced engine power. The engine shuts down when your vehicle speed is below 3 mph (5 km/h). Stop the vehicle as soon as safely possible. Have the system checked by an authorized dealer.
ENGINE OIL DILUTED	The diluted engine oil needs to be changed.
ENGINE WARMING REDUCED POWER	Your vehicle will have reduced engine torque until the engine is warmed sufficiently.
ENGINE TURNS OFF IN XX SECONDS	The powertrain control module intentionally turns the engine off due to your vehicle being in the final 30 seconds of a countdown. The diesel engine shutdown for extended idling is an optional feature.
ENGINE TURNED OFF	Appears after the 30-second countdown.

Information Displays

Message	Action
ENGINE WARMING PLEASE WAIT	In extremely cold weather, typically below -15°F (-26°C) and if the engine block heater is not utilized, your engine does not respond to accelerator pedal movement for 30 seconds. This restriction allows your engine to circulate the oil properly in order to avoid engine damage.
EXHAUST FILTER DRIVE COMPLETE	Your diesel particulate filter is clean.
EXHAUST FILTER CLEANED	Your diesel particulate filter is clean.
EXHAUST CLEAN STOPPED	The manual operator commanded regeneration process has stopped.
DPF LOADING OF 50% OR GREATER	Your message center may report a DPF loading of 50% or greater on initial delivery or following service DPF re-set, this is normal.
EXHAUST FLUID RANGE XXX MI	The distance you can travel before depleting the remaining diesel exhaust fluid.
IN XX MILES, SPEED LIMITED TO XX MPH EXHAUST FLUID EMPTY	Your diesel exhaust fluid is nearing empty. Your vehicle's top speed becomes limited in the displayed distance. You must replenish the diesel exhaust fluid to resume normal operation of your vehicle.
SPEED LIMITED TO XX MPH UPON RESTART EXHAUST FLUID EMPTY	Your remaining diesel exhaust fluid has depleted. Your speed is limited upon restart. You must replenish the diesel exhaust fluid to resume normal operation of your vehicle.
SPEED LIMITED TO XX MPH EXHAUST FLUID EMPTY	The diesel exhaust fluid is empty. You must replenish the diesel exhaust fluid to resume normal operation of your vehicle.
ENGINE IDLED SOON EXHAUST FLUID EMPTY	The selective catalytic reduction system detects low exhaust fluid. The engine eventually enters into an idle-only mode. You must replenish the diesel exhaust fluid to resume normal operation of your vehicle.
ENGINE IDLED - SEE OWNER'S MANUAL EXHAUST FLUID EMPTY	A problem exists with the selective catalytic reduction system. The vehicle enters into an idle-only mode. If the exhaust fluid is empty, you must replenish the diesel exhaust fluid to resume normal operation of your vehicle.
IN XX MILES, SPEED LIMITED TO 50 MPH EXHAUST FLUID SYSTEM FAULT	The selective catalytic reduction system detects a fault. The vehicle's top speed becomes limited in the displayed distance starting at 50 mi (80 km) and count down from this point. Have the system checked by an authorized dealer.

Information Displays

Message	Action
SPEED LIMITED TO 50 MPH UPON RESTART EXHAUST FLUID SYSTEM FAULT	The selective catalytic reduction system detects a fault. The vehicle's top speed becomes limited upon restarting. Have the system checked by an authorized dealer.
SPEED LIMITED TO 50 MPH EXHAUST FLUID SYSTEM FAULT	The selective catalytic reduction system detects a fault. The vehicle's top speed is limited. Have the system checked by an authorized dealer.
ENGINE IDLED SOON EXHAUST FLUID SYSTEM FAULT SEE MANUAL	The selective catalytic reduction system detects a fault. The engine enters into an idle-only mode. Have the system checked by an authorized dealer.
ENGINE IDLED - SEE OWNER'S MANUAL EXHAUST FLUID SYSTEM FAULT	The selective catalytic reduction system detects a fault. The engine eventually enters into an idle-only mode. Press OK to override the idle mode. Have the system checked by an authorized dealer.
FUEL FILTER CHANGE REQUIRED	A fuel filter change is required.
EXHAUST OVER LIMIT SERVICE NOW	You must have your vehicle serviced by an authorized dealer if approximately two hours after the EXHAUST OVERLOADED DRIVE TO CLEAN message has displayed and you have not driven your vehicle above 30 mph (48 km/h) for at least 20 minutes to clean the diesel particulate filter. You are responsible for assuring that you operate your vehicle in a manner that allows diesel particulate filter cleaning to occur. Ignoring the EXHAUST OVER LIMIT SERVICE NOW warning message could lead to reduced drivability and customer expense, including damage to the diesel particulate filter. Your new vehicle warranty may not cover this damage.
WATER IN FUEL DRAIN FILTER SEE MANUAL	The water separator has reached a predetermined capacity and needs draining.
LOW FUEL PRESSURE	A low fuel pressure condition has occurred due to cold, low fuel level or fuel filters need to be changed.

Information Displays

Engine

Message	Action
TRANSPORT MODE CONTACT DEALER	Your vehicle is set to transport mode. The transport mode disables certain vehicle functions to prevent battery discharge.
POWER REDUCED TO LOWER ENGINE TEMP	The vehicle has reduced engine speed because fluid temperatures are at or near their max operating limits.

Fuel

Message	Action
FUEL LEVEL LOW	An early reminder of a low fuel condition.
CHECK FUEL CAP	The fuel cap may not be properly closed.

Key

Message	Action
TO DRIVE: TURN KEY TO ON	The factory equipped remote start is active. Turn your key to on to drive.

Maintenance

Message	Action
ENGINE OIL CHANGE SOON	The engine oil life is nearing its end.
OIL CHANGE REQUIRED	The oil life left reaches 0%.
BRAKE FLUID LEVEL LOW	The brake fluid level is low and the brake system needs inspection immediately.
CHECK BRAKE SYSTEM	The brake system needs servicing. If the warning stays on or continues to come on, have the system checked by an authorized dealer as soon as possible.

Information Displays

Park Brake

Message	Action
PARK BRAKE ENGAGED	The parking brake is set and your vehicle is in motion.

Climate Control

MANUAL CLIMATE CONTROL

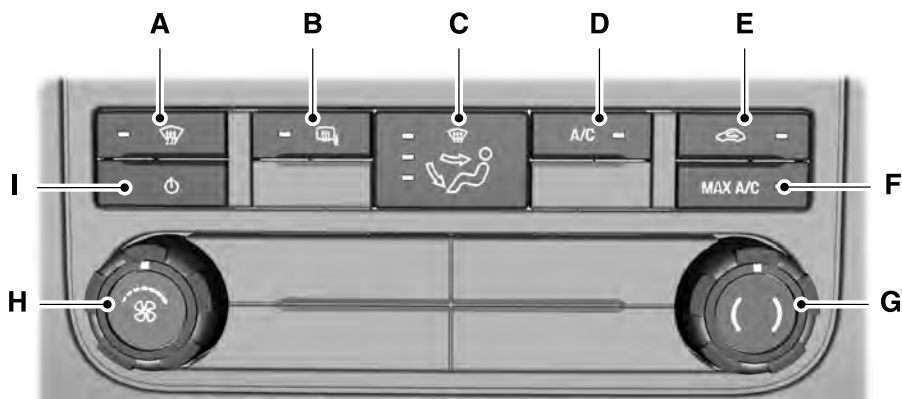

E214636

- A **Defrost:** Select to distribute air through the windshield air vents. Air distribution to the instrument panel and footwell vents turns off. You can also use this setting to defrost and clear the windshield of a thin covering of ice.
- B **Heated mirrors:** Press to switch the heated exterior mirrors on and off. See **Heated Exterior Mirrors** (page 72).
- C **Air distribution control:** Adjust to turn airflow from the windshield, instrument panel, or footwell vents on or off. You can distribute air through the following combinations: windshield, windshield/floor, panel, panel/floor, and floor.
- D **A/C:** Press to switch the air conditioning on or off. Air conditioning cools your vehicle using outside air. To improve the time to reach a comfortable temperature in hot weather, drive with the windows open until you feel cold air through the air vents.
- E **Recirculated air:** Press to switch between outside air and recirculated air. The air currently in the passenger compartment recirculates. This can reduce the time needed to cool the interior and reduce unwanted odors from entering your vehicle.
Note: Recirculated air may also turn on and off automatically in instrument panel or instrument panel and floor airflow modes during hot weather to improve cooling efficiency.
- F **MAX A/C:** Adjust for maximum cooling. Recirculated air flows through the instrument panel vents and air conditioning automatically turns on.

Climate Control

- G **Temperature control:** Controls the temperature of the air circulated in your vehicle.
- H **Fan speed control:** Adjust the volume of air circulated in the vehicle.
- I **Power:** Press to switch the system on and off. When the system is off, it prevents outside air from entering the vehicle.

HINTS ON CONTROLLING THE INTERIOR CLIMATE

General Hints

Note: *Prolonged use of recirculated air may cause the windows to fog up.*

Note: *You may feel a small amount of air from the footwell air vents regardless of the air distribution setting.*

Note: *To reduce humidity build-up inside your vehicle, do not drive with the system switched off or with recirculated air always switched on.*

Note: *To reduce fogging of the windshield during humid weather, adjust the air distribution control to the windshield air vents position.*

Note: *Do not place objects under the front seats as this may interfere with the airflow to the rear seats.*

Note: *Remove any snow, ice or leaves from the air intake area at the base of the windshield.*

Note: *To improve the time to reach comfort in hot weather, drive with the windows slightly open for 2–3 minutes after start-up or until your vehicle airs out.*

Heating the Interior Quickly

1. Adjust the fan speed to the highest speed setting.
2. Adjust the temperature control to the highest setting.

3. Select the footwell air vents using the air distribution buttons.

Recommended Settings for Heating

1. Adjust the fan speed to the center setting.
2. Adjust the temperature control to the midway point of the hot settings.
3. Select the footwell air vents using the air distribution buttons.

Cooling the Interior Quickly

1. Press the **MAX A/C** button.
2. Drive with the windows open for 2–3 minutes.

Recommended Settings for Cooling

1. Adjust the fan speed to the center setting.
2. Adjust the temperature control to the midway point of the cold settings.
3. Select the instrument panel air vents using the air distribution buttons.

Vehicle Stationary for Extended Periods During Extreme High Ambient Temperatures

1. Apply the parking brake.
2. Move the transmission selector lever to park (P) or neutral.
3. Press the **MAX A/C** button.
4. Adjust the fan speed to the lowest speed setting.

Climate Control

Side Window Defogging in Cold Weather

1. Select the instrument panel and windshield air vents positions on the air distribution control.
2. Press the **A/C** button.
3. Adjust the temperature control to the desired setting.
4. Adjust the fan speed to the highest setting.
5. Direct the instrument panel side air vents toward the side windows.
6. Close the instrument panel vents.

HEATED EXTERIOR MIRRORS

Note: *Do not remove ice from the mirrors with a scraper or adjust the mirror glass when it is frozen in place.*

Note: *Do not clean the mirror housing or glass with harsh abrasives, fuel or other petroleum-based cleaning products.*

The heated exterior mirrors will remove ice, mist and fog.

Seats

SITTING IN THE CORRECT POSITION

WARNINGS



Do not recline the seatback as this can cause the occupant to slide under the safety belt, resulting in serious injury in the event of a crash.



Do not place objects higher than the seatback to reduce the risk of serious injury in the event of a crash or during heavy braking.

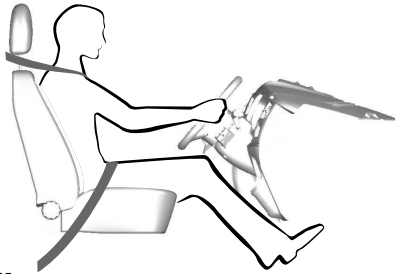

E68595

When you use them properly, the seat, head restraint, safety belt and airbags will provide optimum protection in the event of a crash.

We recommend that you follow these guidelines:

- Sit in an upright position with the base of your spine as far back as possible.
- Do not recline the seatback more than 30 degrees.
- Adjust the head restraint so that the top of it is level with the top of your head and as far forward as possible. Make sure that you remain comfortable.

- Keep sufficient distance between yourself and the steering wheel. We recommend a minimum of 10 in (25 cm) between your breastbone and the airbag cover.
- Hold the steering wheel with your arms slightly bent.
- Bend your legs slightly so that you can press the pedals fully.
- Position the shoulder strap of the safety belt over the center of your shoulder and position the lap strap tightly across your hips.

Make sure that your driving position is comfortable and that you can maintain full control of your vehicle.

HEAD RESTRAINTS

WARNINGS



Fully adjust the head restraint before you operate your vehicle. This will help minimize the risk of neck injury in the event of a crash. Do not adjust the head restraint when your vehicle is moving.



The head restraint is a safety device. Whenever possible it should be installed and properly adjusted when the seat is occupied. An improperly adjusted head restraint may not adequately protect an occupant during an impact from the rear.



Install the head restraint properly to help minimize the risk of neck injury in the event of a crash.

Note: *Adjust the seat back to an upright driving position before adjusting the head restraint. Adjust the head restraint so that the top of it is level with the top of your head and as far forward as possible. Make sure that you remain comfortable. If you are extremely tall, adjust the head restraint to its highest position.*

Seats

Front Seat Head Restraint

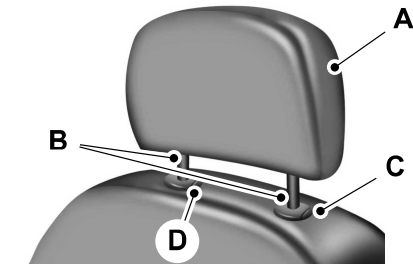

E138642

The head restraints consist of:

- A An energy absorbing head restraint.
- B Two steel stems.
- C Guide sleeve adjust and release button.
- D Guide sleeve unlock and remove button.

Adjusting the Head Restraint

Raising the Head Restraint

Pull the head restraint up.

Lowering the Head Restraint

1. Press and hold button C.
2. Push the head restraint down.

Removing the Head Restraint

1. Press and hold buttons C and D.
2. Pull the head restraint up.

Installing the Head Restraint

Align the steel stems into the guide sleeves and push the head restraint down until it locks.

Front Row Center, Outboard (Crew Cab), and Rear Seat Center (Crew Cab) Head Restraints

Note: *The SuperCab has rear outboard head restraints that are not removable and are bolted to the back wall.*

Your vehicle may have head restraints that are non-adjustable. The non-adjustable head restraints consist of:

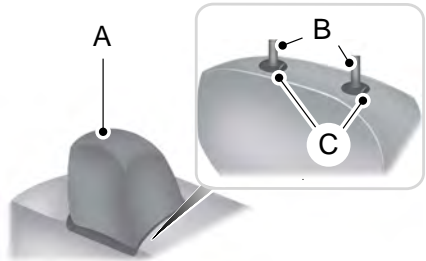

E162872

- A An energy absorbing head restraint.
- B Two steel stems.
- C Guide sleeve unlock and remove button.

Removing the Head Restraint

1. Press and hold buttons C.
2. Pull up the head restraint.

Installing the Head Restraint

Align the steel stems into the guide sleeves and push the head restraint down until it locks.

Tilting Head Restraints (If Equipped)

The front head restraints tilt for extra comfort. To tilt the head restraint, do the following:

Seats



E144727

1. Adjust the seatback to an upright driving or riding position.
2. Pivot the head restraint forward toward your head to the desired position.

After the head restraint reaches the forward-most tilt position, pivot it forward again to release it to the rearward, un-tilted position.

Note: Do not attempt to force the head restraint backward after it is tilted. Instead, continue tilting it forward until the head restraint releases to the upright position.

MANUAL SEATS (If Equipped)

WARNING



Do not adjust the driver seat or seatback when your vehicle is moving.

Moving the Seat Backward and Forward

Type 1



E162727

Type 2



E226571

Recline Adjustment

Type 1



E162728

Seats

Type 2



E208773

Tilting the Seatback Forward (Two-Passenger Bench Seat)



E208777

Lift the handle to unlock and release the seatback forward.

Manual Lumbar (If Equipped)

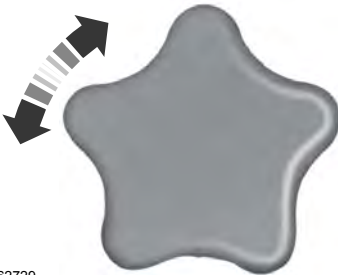



E162729

The lumbar control is on the outboard side of the seat. Turn the control to adjust your support.

POWER SEATS (If Equipped)

WARNINGS

-  Do not adjust the driver seat or seatback while your vehicle is moving. Adjusting your seatback while the vehicle is in motion may cause loss of control of the vehicle.
-  To reduce the risk of excess slack in the belt system, always adjust the seat height before fastening the seat belt.
-  Do not place cargo or any objects behind the seatback before returning it to the original position.

Seats

Air-Ride Seat

Type 1

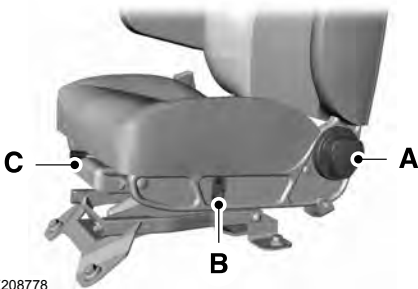

E208778

Type 2

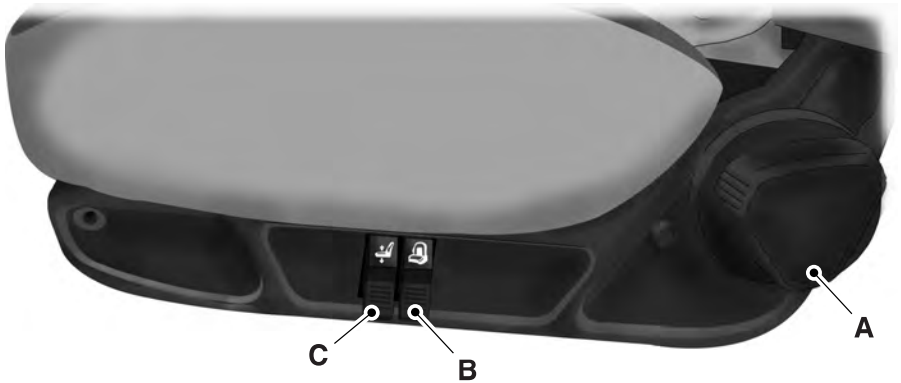

E208774

- A. Recline - Rotate the handle to adjust the angle of the seatback.
 - B. Seat height adjuster - Press the control up to raise the seat. Push the control down to lower the seat.
 - C. Seat adjuster - Lift the bar up to move the seat forward or backward. Release the bar to lock the seat in position.
-
- A. Recline - Rotate the handle to adjust the angle of the seatback.
 - B. Lumbar - Press the lever up to inflate the lumbar. Press the lever down to deflate the lumbar.
 - C. Seat height adjuster - Press the lever up to raise the seat height. Press the lever down to lower the seat height.

Seats

REAR SEATS (If Equipped)

Folding Up the Rear Seats (SuperCab)



E162737

1. Pull the control to release the seat cushion.
2. Rotate the seat cushion up until it locks into the vertical storage position.

Returning the Seat to the Seating Position

WARNING



Make sure that cargo or any objects are not trapped underneath the seat cushion before returning the seat cushion to its original position, and that the seat cushion locks into place. Failure to do so may prevent the seat from operating properly in the event of a crash, which could increase the risk of serious injury.

1. Pull the control on the side of the seat to release the seat cushion from the storage position.
2. Push the seat cushion down until it locks into the horizontal position.

Folding the Rear Seat Back (Crew Cab)

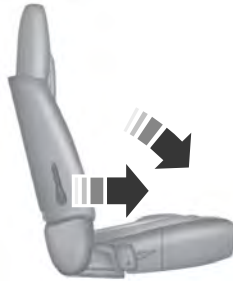

E162738

1. Pull forward on the control to fold down the seatback.
2. Pull down on the handle and lift up on the seatback to return it to the original position.

Folding up the Rear Seat Cushion

1. Pull the control to release the seat cushion.
2. Rotate the seat cushion up until it locks into the vertical storage position.

Returning the Seat to the Seating Position

WARNING



Make sure that cargo or any objects are not trapped underneath the seat cushion before returning the seat cushion to its original position, and that the seat cushion locks into place. Failure to do so may prevent the seat from operating properly in the event of a crash, which could increase the risk of serious injury.

1. Pull the control on the side of the seat to release the seat cushion from the storage position.
2. Push the seat cushion down until it locks into the horizontal position.

Seats

FRONT SEAT ARMREST



E162745

Press the button on the right-hand side of the seat and pull the seatback down to release the armrest. You can also gain access to the cupholders and seatback storage bin.



E162746

Pull up on the tab to open the storage bin
Lift up on the seatback to return it to the upright position.



E162747

If your vehicle has an under-seat storage compartment in the seat cushion, lift the latch to open the lid of the compartment. You cannot open the lid when the armrest is down.



E162748

The under-seat storage compartment has a programmable lock. Use the ignition key to program the lock to the compartment. You can power or charge electronics using the under-seat storage compartment auxiliary power point. See **Auxiliary Power Points** (page 81).

Seats

REAR SEAT ARMREST (If Equipped)

Type 1



E162744

Type 2



E208775

Fold the armrest down to use it.

Auxiliary Power Points

12 Volt DC Power Point

WARNINGS



Do not plug optional electrical accessories into the cigar lighter socket. Incorrect use of the cigar lighter can cause damage not covered by the vehicle warranty, and can result in fire or serious injury.



Do not use a power point for operating a cigar lighter. Incorrect use of the power points can cause damage not covered by the vehicle warranty, and can result in fire or serious injury.

Note: When you switch the ignition on, you can use the socket to power 12 volt appliances with a maximum current rating of 15 amps.

If the power supply does not work after you switch the ignition off, switch the ignition on.

Note: Do not hang any accessory from the accessory plug.

Note: Do not use the power point over the vehicle capacity of 12 volt DC 180 watts or a fuse may blow.

Note: Always keep the power point caps closed when not in use.

Do not insert objects other than an accessory plug into the power point. This will damage the power point and blow the fuse.

Run the vehicle for full capacity use of the power point.

To prevent the battery from running out of charge:

- Do not use the power point longer than necessary when the vehicle is not running.
- Do not leave devices plugged in overnight or when you park your vehicle for extended periods.

Locations

Power points may be in the following locations:

- On the instrument panel (two locations).
- Inside the front under-seat storage compartment.
- Inside the rear under-seat storage compartment.

110 Volt AC Power Points (If Equipped)

WARNING



Do not keep electrical devices plugged in the power point whenever the device is not in use. Do not use any extension cord with the 110 volt AC power point, since it will defeat the safety protection design. Doing so may cause the power point to overload due to powering multiple devices that can reach beyond the 150 watt load limit and could result in fire or serious injury.

Note: The power point will turn off when the ignition is switched off or the battery voltage drops below 11 volts.

Use the power point for powering electric devices that require up to 150 watts. It is on the instrument panel, center area.

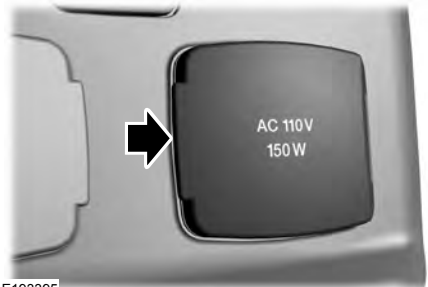

Auxiliary Power Points

Note: *Depending on your vehicle, the power point cover may open to the right or upward.*

When the indicator light on the power point is:

- On: The power point is working, the ignition is on and a device is plugged in.
- Off: The power point is off, the ignition is off or no device is plugged in.
- Flashing: The power point is in fault mode.

The power outlet temporarily turns off power when in fault mode if the device exceeds the 150 watt limit. Unplug your device and switch the ignition off. Switch the ignition back on, but do not plug your device back in. Let the system cool off and switch the ignition off to reset the fault mode. Switch the ignition back on and make sure the indicator light remains on.

Do not use the power point for certain electric devices, including:

- Cathode-ray, tube-type televisions.
- Motor loads, such as vacuum cleaners, electric saws and other electric power tools or compressor-driven refrigerators.
- Measuring devices, which process precise data, such as medical equipment or measuring equipment.
- Other appliances requiring an extremely stable power supply such as microcomputer-controlled electric blankets or touch-sensor lamps.

Storage Compartments

OVERHEAD CONSOLE (If Equipped)

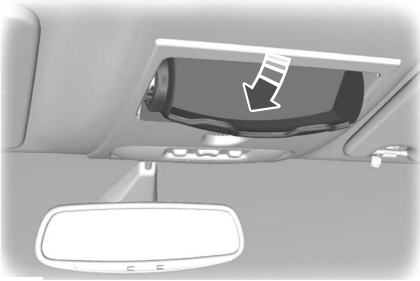

E75193

Press near the rear edge of the door to open it.

Starting and Stopping the Engine

GENERAL INFORMATION

WARNINGS



Extended idling at high engine speeds can produce very high temperatures in the engine and exhaust system, creating the risk of fire or other damage.



Do not park, idle or drive your vehicle on dry grass or other dry ground cover. The emission system heats up the engine compartment and exhaust system, creating the risk of fire.



Do not start the engine in a closed garage or in other enclosed areas. Exhaust fumes can be toxic. Always open the garage door before you start the engine.



If you smell exhaust fumes inside your vehicle, have your vehicle checked by your authorized dealer immediately. Do not drive your vehicle if you smell exhaust fumes.

If you disconnect the battery, your vehicle may exhibit some unusual driving characteristics for approximately 5 miles (8 kilometers) after you reconnect it. This is because the engine management system must realign itself with the engine. You can disregard any unusual driving characteristics during this period.

The powertrain control system meets all Canadian interference-causing equipment standard requirements regulating the impulse electrical field or radio noise.

When you start the engine, avoid pressing the accelerator pedal before and during operation. Only use the accelerator pedal when you have difficulty starting the engine.

If your vehicle is operated in a heavy snow storm or blowing snow conditions, the engine air induction may become partially clogged with snow and ice. If this occurs, the engine may experience a significant reduction in power output. At the earliest opportunity, clear all the snow and ice away from the air induction inlet.

IGNITION SWITCH

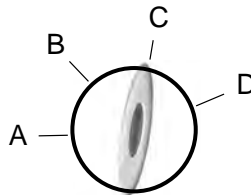

E163165

A (off) - The ignition is off.

Note: *When you switch the ignition off and leave your vehicle, do not leave your key in the ignition. This could cause your vehicle battery to lose charge.*

B (accessory) - Allows the electrical accessories, such as the radio, to operate while the engine is not running.

Note: *Do not leave the ignition key in this position for too long. This could cause your vehicle battery to lose charge.*

C (on) - All electrical circuits are operational and the warning lamps and indicators illuminate.

D (start) - Cranks the engine.

Starting and Stopping the Engine

STARTING A GASOLINE ENGINE

When you start the engine, the idle speed increases, this helps to warm up the engine. If the engine idle speed does not slow down automatically, have your vehicle checked by an authorized dealer.

Before starting the engine check the following:

- Make sure all occupants have fastened their safety belts.
- Make sure the headlamps and electrical accessories are off.
- Make sure the parking brake is on.
- Make sure the transmission is in park (P) or neutral (N).
- Turn the ignition key to the on position.

Note: *Do not touch the accelerator pedal.*

1. Fully press the brake pedal.
2. Turn the key to the start position to start the engine. Release the key when the engine starts.

Note: *The engine may continue cranking for up to 15 seconds or until it starts.*

Note: *If you cannot start the engine on the first try, wait for a short period and try again.*

Failure to Start

If you cannot start the engine after three attempts, wait 10 seconds and follow this procedure:

1. Fully press the brake pedal.
2. Fully press the accelerator pedal and hold it there.
3. Start the engine.

Stopping the Engine When Your Vehicle is Stationary

1. Shift into park (P) or neutral (N).

2. Turn the key to the off position.
3. Apply the parking brake.

Stopping the Engine When Your Vehicle is Moving

WARNING



Switching off the engine when the vehicle is still moving will result in a loss of brake and steering assistance.

The steering will not lock, but higher effort will be required. When the ignition is switched off, some electrical circuits, including air bags, warning lamps and indicators may also be off. If the ignition was turned off accidentally, you can shift into neutral (N) and re-start the engine.

1. Put the transmission into neutral (N) and use the brakes to bring your vehicle to a safe stop.
2. When your vehicle has stopped, shift into park (P) or neutral (N) and switch the ignition off.
3. Apply the parking brake.

Guarding Against Exhaust Fumes

WARNING



If you smell exhaust fumes inside your vehicle, have your vehicle checked by your authorized dealer immediately. Do not drive your vehicle if you smell exhaust fumes. Carbon monoxide is present in exhaust fumes. Take precautions to avoid its dangerous effects.

Important Ventilating Information

If you stop your vehicle and then leave the engine idling for long periods of time, we recommend that you do one of the following:

Starting and Stopping the Engine

- Open the windows at least 1 in (3 cm).
- Set your climate control to outside air.

STARTING A DIESEL ENGINE

WARNING



Operation of a diesel engine near flammable vapors in the air may cause the engine speed to increase uncontrollably and over speed. If this situation occurs, mechanical damage, fire, explosion, personal injury or death could result. Turning off the ignition key does not slow or stop the engine due to uncontrollable fueling of the engine through flammable vapors being drawn into the engine air inlet. Operation of components, for example starter, alternator, electric motors and static electricity could also ignite flammable vapors. Do not operate your vehicle in the possible presence of flammable vapors unless both a complete hazard analysis is carried out and necessary additional safety processes and/or equipment, for example vapor testing, air intake shutoff devices and ventilation are utilized. You are responsible for using those processes and/or equipment to make sure that the diesel engine and all other components on your vehicle can be operated safely under the specific conditions and hazards that may be encountered.

Read all starting instructions carefully before you start your vehicle.

Diesel Engine Fast Start Glow Plug System

The diesel engine glow system consists of:

- Eight glow plugs (one per cylinder)
- Glow Plug Control Module
- Engine Coolant Temperature sensor

- Barometric pressure sensor
- Environmental temperature sensor

The powertrain and glow plug control modules electronically control the glow plug system. After you switch the ignition on the glow plug control module immediately energizes the glow plugs. The glow plug control module using the engine coolant temperature, barometric pressure sensor and environmental temperature sensor will determine how long the glow plugs stay energized. The required time for the glow plugs to be energized decreases as the coolant temperature, barometric pressure and environmental temperature increase.

Before starting the engine, check the following:

- Make sure all occupants have fastened their safety belts.
- Make sure the headlamps and electrical accessories are off.
- Make sure the parking brake is on.
- Make sure the transmission is in park (P) or neutral (N).
- Turn the ignition key to the on position.

Note: Do not press the accelerator during starting.

Cold Weather Starting

WARNINGS



Do not use starting fluid, for example ether, in the air intake system (see air filter decal). Such fluid could cause immediate explosive damage to the engine and possible personal injury.



Do not add gasoline, gasohol, alcohol or Kerosene to diesel fuel. This practice creates a serious fire hazard and causes engine performance problems.

Starting and Stopping the Engine

We recommend using the engine block heater for starting when the ambient temperature is at or below -9°F (-23°C). See **Engine Block Heater** (page 88).

When operating in cold weather, you can use Motorcraft® cetane improvers or non-alcohol-based cetane improvers from a reputable manufacturer as needed.

Do not crank the engine for more than 10 seconds as starter damage may occur. If the engine fails to start, turn the key to the off position and wait 30 seconds before trying again.

Your vehicle may be equipped with a cold weather starting strategy that prevents severe engine damage by assisting in engine lubrication warm-up. In extremely cold ambient temperatures, this strategy activates and prevents the accelerator pedal use for 30 seconds after starting your vehicle. A message appears in the information display as your vehicle warms up. By not allowing the accelerator pedal use, the engine oil can properly lubricate the bearings preventing engine damage due to lack of proper lubrication. After the 30-second warm-up period, the accelerator pedal is operational again and a message appears informing you that your vehicle is ok to drive.

When starting the engine in extremely cold temperatures, for example -15°F (-26°C), we recommend you allow the engine to idle for several minutes before driving your vehicle.



Illuminates when you switch the ignition on as part of the pre-starting system.

1. Turn the key to the on position without turning the key to the start position. Do not start the engine until the wait to start indicator turns off.
2. When the wait to start indicator turns off, turn the key to the start position and release the key as soon as the engine starts. After starting the engine, the glow plugs may remain on for a period. If you do not start the engine before the glow plug activation time ends, you need to reset the glow plugs by turning the key to the off position.
3. After the engine starts, allow it to idle for about 15 seconds. This is to protect the engine. Do not increase engine speed until the oil pressure gauge indicates normal pressure.

DIESEL PARTICULATE FILTER

Your vehicle is equipped with a diesel particulate filter. The diesel particulate filter is an inline filter in the exhaust system that reduces carbon emissions by trapping exhaust particles before they reach the tailpipe. The diesel particulate filter looks similar to a traditional exhaust catalyst, except larger, and is part of the exhaust system under your vehicle. The filter couples to a diesel oxidation catalyst that reduces the amount of harmful exhaust emitted from the tailpipe. As soot gathers in the system, it begins to restrict the filter. Periodically, you need to clean the soot that gathers inside the filter. You can clean the soot in two different ways, passive regeneration and active regeneration. See **Emission Control System** (page 105). Both methods occur automatically and require no actions from the driver. During either one of these regeneration methods, you may notice a change in exhaust tone. At certain times, various messages related to the diesel particulate filter appear in the information displays.

Starting and Stopping the Engine

SWITCHING OFF THE ENGINE

Allow the engine to idle for three to five minutes before shutting it down. The larger the engine, the greater the need is for this idling period.

Note: *Try to limit engine idle to 10 minutes. Excessive idling reduces fuel economy.*

ENGINE IDLE SHUTDOWN (If

Equipped)

WARNING



In the event of engine shutdown, make sure your vehicle is safely off the road and the problem is resolved before returning to the road. Failure to do so may result in a crash, serious injury or death.

This feature automatically shuts down the engine when it has been idling in park (P) or neutral (N) for an extended period, depending on the setting.

When the engine idle shutdown process has started:

- A chime sounds and a message appears in the information display showing a timer counting down from 30 seconds.
- You can reset the timer by pressing the brake pedal, accelerator pedal, or by shifting into another gear.
- If you do not intervene within 30 seconds, the engine shuts down and a message appears in the information display alerting you that the engine has shut down.

- Shortly after the engine has shut down, the electrical system simulates a key off and even though the ignition is still on, the electrical system simulates a normal accessory delay period before shutting down.
- You must switch the ignition off to reset the system before restarting your vehicle.

The engine idle shutdown timer does not start if:

- The engine is operating in battery charge protect or power take-off mode.
- The exhaust emission control device is regenerating.

ENGINE BLOCK HEATER (If

Equipped)

WARNINGS



Failure to follow engine block heater instructions could result in property damage or serious personal injury.



Do not use your heater with ungrounded electrical systems or two-pronged adapters. There is a risk of electrical shock.

Note: *The heater is most effective when outdoor temperatures are below 0°F (-18°C).*

The heater acts as a starting aid by warming the engine coolant. This allows the climate control system to respond quickly. The equipment includes a heater element (installed in the engine block) and a wire harness. You can connect the system to a grounded 120-volt AC electrical source.

Starting and Stopping the Engine

We recommend that you do the following for a safe and correct operation:

- Use a 16-gauge outdoor extension cord that is product certified by Underwriter's Laboratory (UL) or Canadian Standards Association (CSA). This extension cord must be suitable for use outdoors, in cold temperatures, and be clearly marked Suitable for Use with Outdoor Appliances. Do not use an indoor extension cord outdoors. This could result in an electric shock or become a fire hazard.
- Use as short an extension cord as possible.
- Do not use multiple extension cords.
- Make sure that when in operation, the extension cord plug and heater cord plug connections are free and clear of water. This could cause an electric shock or fire.
- Make sure your vehicle is parked in a clean area, clear of combustibles.
- Make sure the heater, heater cord and extension cord are firmly connected.
- Check for heat anywhere in the electrical hookup once the system has been operating for approximately 30 minutes.
- Make sure the system is unplugged and properly stowed before starting and driving your vehicle. Make sure the protective cover seals the prongs of the block heater cord plug when not in use.
- Make sure the heater system is checked for proper operation before winter.

Using the Engine Block Heater

The engine block heater plug is on the right-hand side of the front bumper next to the recovery hook. Open the hinged, circular door and make sure the receptacle terminals are clean and dry prior to use. Clean them with a dry cloth if necessary.

The heater uses 0.4 to 1.0 kilowatt-hours of energy per hour of use. The system does not have a thermostat. It achieves maximum temperature after approximately three hours of operation. Using the heater longer than three hours does not improve system performance and unnecessarily uses electricity.

Rapid Heat Supplemental Heating System

Note: *Additional aftermarket electrical loads operated during engine warm up may affect the performance of the rapid heat supplemental heater.*

The optional rapid heat feature is an electrically powered device that provides supplemental heat during engine warm up. During initial warm up, you should use a mid to low blower speed for maximum effectiveness. When operating in automatic mode (when equipped) the climate control unit determines the appropriate blower speed for existing conditions.

Fuel and Refueling

SAFETY PRECAUTIONS

WARNINGS



Do not overfill the fuel tank. The pressure in an overfilled tank may cause leakage and lead to fuel spray and fire.



The fuel system may be under pressure. If you hear a hissing sound near the fuel filler inlet, do not refuel until the sound stops. Otherwise, fuel may spray out, which could cause serious personal injury.



Fuels can cause serious injury or death if misused or mishandled.



Gasoline may contain benzene, which is a cancer-causing agent.



When refueling always shut the engine off and never allow sparks or open flames near the fuel tank filler valve. Never smoke or use a cell phone while refueling. Fuel vapor is extremely hazardous under certain conditions. Avoid inhaling excess fumes.



Flow of fuel through a fuel pump nozzle can produce static electricity. This can cause a fire if you are filling an ungrounded fuel container.



Stop refueling after the fuel pump nozzle automatically shuts off for the second time. Failure to follow this will fill the expansion space in the fuel tank and could lead to fuel overflowing.

Observe the following guidelines when handling automotive fuel:

- Extinguish all smoking materials and any open flames before refueling your vehicle.
- Automotive fuels can be harmful or fatal if swallowed. Fuel such as gasoline is highly toxic and if swallowed can cause death or permanent injury. If swallowed, call a physician immediately, even if no symptoms are immediately apparent. The toxic effects of fuel may not be visible for hours.
- Avoid inhaling fuel vapors. Inhaling too much fuel vapor of any kind can lead to eye and respiratory tract irritation. In severe cases, excessive or prolonged breathing of fuel vapor can cause serious illness and permanent injury.
- Avoid getting fuel liquid in your eyes. If you splash fuel in your eyes, remove contact lenses (if worn), flush with water for 15 minutes and seek medical attention. Failure to seek proper medical attention could lead to permanent injury.
- Fuels can also be harmful if absorbed through the skin. If you splash fuel on your skin, clothing or both, promptly remove contaminated clothing and wash your skin thoroughly with soap and water. Repeated or prolonged skin contact with fuel liquid or vapor causes skin irritation.
- Be particularly careful if you are taking "Antabuse" or other forms of disulfiram for the treatment of alcoholism. Breathing gasoline vapors, or skin contact could cause an adverse reaction. In sensitive individuals, serious

Fuel and Refueling

personal injury or sickness may result. If you splash fuel on your skin, promptly wash your skin thoroughly with soap and water. Consult a physician immediately if you experience an adverse reaction.

Low Fuel Pressure (If Equipped)

Diesel engine vehicles have a low fuel pressure detection system.

The following are possible causes for a low fuel pressure warning message to appear in the information display:

- Cold start or during cold operation below 32°F (0°C). If the low fuel pressure message appears during a cold start or up to 10 minutes after the initial cold start, monitor the information display. If the low fuel pressure message disappears and does not re-appear after the engine has fully warmed up, waxed or gelled fuel is what most likely caused the message. Do not use alcohol based additives to correct fuel gelling. This may result in damage to the fuel injectors and systems. Use an anti-gel additive. See **Capacities and Specifications** (page 258).

Note: *The vehicle Warranty may be void if you use additives that do not meet or exceed Ford specifications. If the low fuel pressure message persistently appears after re-fueling and then disappears when the engine has fully warmed up, consider using different fuel sources.*

- Low fuel operation: If the low fuel pressure message appears when your vehicle is warm and during low fuel tank level operation (near empty), refuel your vehicle. If the message reappears after fueling, see below. If the message does not come back, the low fuel pressure condition was due to low fuel levels in the fuel tank.
- Normal operation: If the low fuel pressure message appears during normal operation when the engine is fully warm, and fuel level is not low, you must change the fuel filters regardless of the maintenance schedule interval.
- If replacement of the fuel filter does not remedy the low fuel pressure message during normal operation as defined above, take the vehicle to an authorized dealer.

FUEL QUALITY - GASOLINE

Choosing the Right Fuel

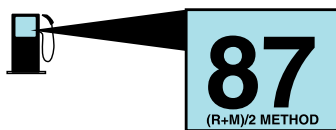

E161513

We recommend regular unleaded gasoline with a minimum pump (R+M)/2 octane rating of 87. Some fuel stations offer fuels posted as regular unleaded gasoline with an octane rating below 87, particularly in high altitude areas. We do not recommend fuels with an octane rating below 87.

Do not use any fuel other than those recommended because they could lead to engine damage that may not be covered by the vehicle Warranty.

Fuel and Refueling

Note: Use of any fuel other than those recommended can impair the emission control system and cause a loss of vehicle performance.

Do not use:

- Diesel fuel.
- Fuels containing kerosene or paraffin.
- Fuel containing more than 10% ethanol or E85 fuel.
- Fuels containing methanol.
- Fuels containing metallic-based additives, including manganese-based compounds.
- Fuels containing the octane booster additive, methylcyclopentadienyl manganese tricarbonyl (MMT).
- Leaded fuel (using leaded fuel is prohibited by law).

The use of fuels with metallic compounds such as methylcyclopentadienyl manganese tricarbonyl (commonly known as MMT), which is a manganese-based fuel additive, will impair engine performance and affect the emission control system.

Do not be concerned if the engine sometimes knocks lightly. However, if the engine knocks heavily while using fuel with the recommended octane rating, contact an authorized dealer to prevent any engine damage.

FUEL QUALITY - DIESEL

Fuel Requirements - Choosing The Right Fuel: Vehicles Operated Where Ultra Low Sulfur Diesel Fuel Is Required (United States/Canada/Puerto Rico/U.S. Virgin Islands And Other Locales)

You should use Ultra-Low Sulfur Diesel fuel (also known as ULSD) designated as number 1-D or 2-D with a maximum of 15-ppm sulfur in your diesel vehicle. You may operate your vehicle on diesel fuels containing up to 20% biodiesel, also known as B20. These fuels should meet the ASTM D975 diesel or the ASTM D7467 B6-B20 biodiesel industry specifications. Outside of North America, use fuels meeting EN590 or equivalent local market standard.

Note: *The vehicle Warranty does not cover damage caused by using an improper type of fuel or fuel additive.*

Note: *Do not blend used engine oil with diesel fuel under any circumstances. Blending used oil with the fuel will significantly increase your vehicle's exhaust emissions and reduce engine life due to increased internal wear.*



Using low sulfur diesel fuel (16-500 ppm) or high sulfur diesel fuel (greater than 500 ppm) in your diesel engine will cause certain emission components to malfunction which may also cause the service engine soon light to illuminate indicating an emissions-related concern.

Diesel fuel is adjusted seasonally for cold temperature. For best results at temperatures below 19°F (-7°C), it is recommended to use a diesel fuel which has been seasonally adjusted for the ambient conditions.

Fuel and Refueling

Fuel Requirements - Choosing The Right Fuel: Vehicles Operated Where Ultra Low Sulfur Diesel Fuel Is Not Required

For the engine to operate reliably on low-sulfur or high-sulfur diesel fuel, the engine must be a factory built high-sulfur engine (available as a dealer order option for select markets) or an ultra low sulfur diesel fuel configured engine that has been retrofitted for high-sulfur diesel fuel using Ford Motor Company dealer service parts. Failure to use retrofit components other than those available through your authorized dealer will result in coolant system damage, engine overheating, selective catalyst reduction system or diesel particulate filter damage and possible base engine damage.

Use only a diesel engine configured for use with high sulfur diesel fuel in markets with diesel fuel that has sulfur content greater than 15 ppm. Using low sulfur diesel fuel (16–500 ppm) or high sulfur diesel fuel (greater than 500 ppm) in a diesel engine designed to use only Ultra Low Sulfur Diesel fuel may result in damage to engine emission control devices and the aftertreatment system, potentially rendering the vehicle inoperable.

Vehicles with engines configured for use with high sulfur diesel fuel are only available for sale in countries where ultra low sulfur diesel fuel is generally not available or mandated by the government. Vehicles originally sold in a ultra low sulfur diesel fuel market that are subsequently exported to non- ultra low sulfur diesel fuel markets will need to be retrofitted (at the customer's expense using Ford authorized dealer service parts) in order to be reliably operated on non- ultra low sulfur diesel fuel.

Biodiesel

WARNINGS



Do not use home heating oil, agricultural fuel, raw fats and oils, waste cooking greases, biodiesel fuels greater than 20% or any diesel fuel not intended for highway use. Damage to the fuel injection system, engine and exhaust catalyst can occur if an improper fuel is used. Do not add gasoline, gasohol or alcohol to diesel fuel. This practice creates a serious fire hazard and engine performance problems.



Do not mix diesel fuel with gasoline, gasohol or alcohol. This could cause an explosion resulting in personal injury.



Do not add gasoline, gasohol or alcohol to diesel fuel. This practice creates a serious fire hazard resulting in personal injury and engine performance problems.



Do not use home heating oil or any diesel fuel not intended for highway use. Damage to the fuel injection system, engine, exhaust catalyst and diesel particulate filter can occur if an improper fuel is used. Red dye is used to identify fuels intended for agricultural and non-highway use.

You may operate your vehicle on diesel fuels containing up to 20% biodiesel, also known as B20.

Biodiesel fuel is a chemically converted product from renewable fuel sources, such as vegetable oils, animal fats and waste cooking greases.

Fuel and Refueling

To help achieve acceptable engine performance and durability when using biodiesel in your vehicle:

- Confirm the biodiesel content of the fuel to be B20 (20% biodiesel) or less
- Only use biodiesel fuel of good quality that complies with industry standards
- Follow the recommended service maintenance intervals. See

Scheduled Maintenance (page 316).

- Do not store biodiesel fuel in the fuel tank for more than 1 month
- Consider changing brands or reducing biodiesel content if you have cold temperature fuel gelling issues or a frequent LOW FUEL PRESSURE message appearing
- Do NOT use raw oils, fats or waste cooking greases

Use of biodiesel in concentrations greater than 20% may cause damage to your vehicle, including engine and/or exhaust after-treatment hardware (exhaust catalyst and particulate filter) failures. Concentrations greater than 20% can also cause fuel filter restrictions that may result in a lack of power or damage to fuel system components, including fuel pump and fuel injector failures.

SAE 5W-40 or SAE 15W-40 oil is recommended for fuels with greater than 5% biodiesel (B5). Refer to the Special operating conditions section under the Schedule Maintenance chapter for more information about oil change intervals and other maintenance when operating on biodiesel.

Look for a label on the fuel pump to confirm the amount of biodiesel contained in a diesel fuel. Biodiesel content is often indicated with the letter B followed by the percent of biodiesel in the fuel. For example, B20 indicates a fuel containing 20% biodiesel. Ask the service station attendant to confirm the biodiesel content of a diesel fuel if you do not see a label on the fuel pump.

Biodiesel fuels degrade more easily than diesel fuels not containing biodiesel and should not be stored in the fuel tank for more than 1 month. If you plan to park or store your vehicle for more than 1 month, then you should empty your vehicle fuel tank of biodiesel fuel. You should fill the tank with a pure petroleum-based diesel fuel and run your vehicle for a minimum of 30 minutes.

Note: *Degraded or oxidized biodiesel can damage fuel system seals and plastics and corrode steel parts.*

During cold weather, if you have problems operating on biodiesel, you may need to use a diesel fuel with lower biodiesel content, try another brand, or discontinue the use of biodiesel.

Diesel Fuel Additives

It should not be necessary to add any aftermarket additives to your fuel if you use a high quality diesel fuel that conforms to ASTM industry specifications. Aftermarket additives can damage the fuel injector system or engine.

Use Motorcraft® cetane booster or an equivalent cetane booster additive if you suspect fuel has low cetane. Use Motorcraft® anti-gel & performance improver or an equivalent additive if there is fuel gelling.

Fuel and Refueling

Do not use alcohol-based additives to improve cetane quality, to prevent fuel gelling or any other use. The use of alcohol additives may result in damage to the fuel injectors and system. See **Capacities and Specifications** (page 263).

The Vehicle Warranty may not cover repairs needed to correct the effects of using an aftermarket product that does not meet Ford specifications in your fuel.

RUNNING OUT OF FUEL - GASOLINE

Avoid running out of fuel because this situation may have an adverse effect on powertrain components.

If you run out of fuel:

- You may need to switch the ignition from off to on several times after refueling to allow the fuel system to pump the fuel from the tank to the engine. When restarting, cranking time takes a few seconds longer than normal. With keyless ignition, just start the engine. Crank time will be longer than usual.
- Normally, adding 1 gal (3.8 L) of fuel is enough to restart the engine. If the vehicle is out of fuel and on a steep grade, more than 1 gal (3.8 L) may be required.
- The service engine soon indicator may come on. See **Warning Lamps and Indicators** (page 58).

RUNNING OUT OF FUEL - DIESEL

Avoid running out of fuel. This allows air to enter the fuel system and may make it difficult to restart your vehicle.

If your vehicle runs out of fuel:

- Normally adding 4–5 gal (15–19 L) of fuel is enough to restart the engine. If your vehicle is out of fuel and on a steep grade, more than 5 gal (19 L) may be required.
- You must purge trapped air from the system before restarting the engine.

Purging Air From the System

Switch the ignition on for 30 seconds and then switch the ignition off. Repeat this operation six times in a row to purge any trapped air from the fuel system.

Any remaining air in the system self-purges when the engine starts. The engine may run rough or produce white smoke when air remains in the fuel system. This is normal and stops after a short period. If the engine continues to run rough, have your vehicle checked as soon as possible.

Starting the Engine

Do not crank the engine for more than 10 seconds as starter damage may occur. If the engine fails to start, switch the ignition off and wait 30 seconds before cranking the engine again. See **Starting a Diesel Engine** (page 86).

SELECTIVE CATALYTIC REDUCTION SYSTEM - DIESEL

Your vehicle may have a selective catalytic reduction system. The system helps reduce emission levels of oxides of nitrogen from the exhaust system. The system automatically injects diesel exhaust fluid into the exhaust system to enable correct selective catalytic reduction system function.

Note: *Selective catalytic reduction systems are not fitted to vehicles in markets where only high-sulfur diesel fuel is available.*

Fuel and Refueling

Diesel Exhaust Fluid Level

In order for the system to operate correctly you must maintain the diesel exhaust fluid level.

A warning message appears in the information display when the diesel exhaust fluid level is low. If a warning message appears, refill the diesel exhaust fluid tank as soon as possible. See **Information Messages** (page 64).

Filling the Diesel Exhaust Fluid Tank

WARNINGS



Keep diesel exhaust fluid out of the reach of children. Avoid contact with skin, eyes or clothing. In case of contact with your eyes, flush immediately with water and get prompt medical attention. In case of contact with your skin, clean immediately with soap and water. If you swallow any diesel exhaust fluid, drink plenty of water, call a physician immediately.



Only refill the diesel exhaust fluid tank in a well ventilated area. When you remove the diesel exhaust fluid tank filler cap or a diesel exhaust fluid container cap, ammonia vapors may escape. Ammonia vapors can be irritating to skin, eyes and mucous membranes. Inhaling ammonia vapors can cause burning to the eyes, throat and nose and cause coughing and watery eyes.

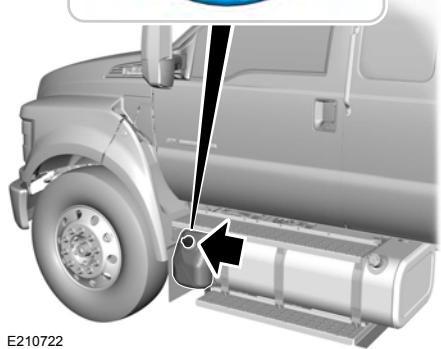

E210722

The diesel exhaust fluid tank has a blue filler cap. The tank is behind the left-hand front wheel. Fill the tank using a fluid pump at a diesel exhaust fluid filling station or a diesel exhaust fluid container. We recommend Motorcraft® diesel exhaust fluid. See **Capacities and Specifications** (page 258).

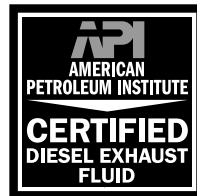

E163354

Fuel and Refueling

Only use diesel exhaust fluid that is certified by the American Petroleum Institute (API). Non-certified diesel exhaust fluid use can cause damage not covered by the vehicle Warranty.

Note: Do not put diesel exhaust fluid in the fuel tank. This can cause damage not covered by the vehicle Warranty.

You can purchase diesel exhaust fluid at an authorized dealer, most highway truck stops or you can contact roadside assistance for help in finding a retailer that sells diesel exhaust fluid. In addition, there is a government website to help you find the nearest location to purchase diesel exhaust fluid:
<http://www.discoverdef.com>.

Filling the Diesel Exhaust Fluid Tank Using a Fuel Station Pump

Filling the diesel exhaust fluid tank using a nozzle is similar to fuel fill. The nozzle shuts off automatically when the tank is full.

Filling the Diesel Exhaust Fluid Tank Using a Container

The following procedure applies to Motorcraft diesel exhaust fluid or similar fluid containers. Always follow the manufacturer's instructions.

1. Remove the diesel exhaust fluid container cap. Place the spout on to the container and tighten it until you feel a strong resistance.
2. Remove the diesel exhaust fluid tank filler cap.
3. Insert the spout in to the filler neck until the seal on the spout seats on to the filler neck. Pour the fluid in to the tank. When the tank is full the fluid will stop flowing automatically.

4. Return the container to the vertical position slightly below the diesel exhaust fluid filler neck. Allow any fluid remaining in the spout to drain back in to the container.
5. Remove the spout from the diesel exhaust fluid filler neck. Replace the diesel exhaust fluid tank cap.
6. Remove the spout from the diesel exhaust fluid container and replace the cap.

Note: If there is diesel exhaust fluid left in the container retain it for later use. The spout is re-useable. Wash the spout with clean water prior to storage. Do not use the diesel exhaust fluid spout with any other fluid.

Filling the Diesel Exhaust Fluid Tank in Cold Climates

Diesel exhaust fluid may freeze if the ambient temperature is below 12°F (-11°C). Your vehicle has a preheating system which allows diesel exhaust fluid to operate below 12°F (-11°C). If you do not use your vehicle for an extended period when the ambient temperature is below 12°F (-11°C), the fluid in the tank may freeze. If the tank is overfilled and the fluid freezes it may damage the tank. This is not covered by the vehicle warranty.

Diesel Exhaust Fluid Warning Messages and Vehicle Operations

WARNINGS



Diesel exhaust fluid must be refilled when low or replaced when contaminated or your vehicle speed becomes limited to 50 mph (80 km/h). In these conditions, drive with caution and refill diesel exhaust fluid immediately. If the diesel exhaust fluid becomes empty or contaminated and fluid is not replaced,

Fuel and Refueling

WARNINGS

your vehicle becomes limited to engine idle only once stopped. In these conditions, be cautious where you stop your vehicle because you may not be able to drive long distances or maintain highway speeds until you refill or replace the diesel exhaust fluid.



Tampering with or disabling selective catalytic reduction system results in severe vehicle performance limitation including eventual speed limiting to 5 mph (5 km/h).

The information display shows a series of messages about the amount of diesel exhaust fluid available. A systems check displays messages indicating the amount of diesel exhaust fluid available or displays a warning message indicating the approximate distance remaining as the fluid in the diesel exhaust fluid tank nears empty. See **Information Messages** (page 64).



As the diesel exhaust fluid level nears empty, the warning symbol displays and a series of tones and messages starting at 500 mi (800 km) remaining before diesel exhaust fluid is depleted. The warning symbol and messages continue until you refill the diesel exhaust fluid tank.

Continued driving without refilling results in the following actions as required by the California Air Resources Board (CARB) and the U.S. Environmental Protection Agency (EPA):

- Within a preset distance to empty, speed is limited upon vehicle restart. Prior to this occurring a message appears in the information display.
- Further vehicle operation without refilling the diesel exhaust fluid tank causes the engine to enter an idle-only condition. This only occurs upon vehicle refueling or at an extended idle. A message indicates the required actions to resume normal operation. It is required to add a minimum of 1.0 gal (3.8 L) of diesel exhaust fluid to the tank to exit the idle-only condition, but your vehicle is still in the speed-limiting mode until you refill the tank completely.

Note: For either vehicle speed limiting or idle-only condition, normal vehicle operation resumes when you refill the diesel exhaust fluid tank.

Note: When filling the diesel exhaust fluid tank from empty, there may be a short delay before detecting the increased level of fluid. The increased level detection must occur before your vehicle returns to full power.

Diesel Exhaust Fluid Guidelines and Information

- Use only diesel exhaust fluid that carries the American Petroleum Institute (API) certified diesel exhaust fluid trademark or ISO 22241.
- Do not put diesel exhaust fluid in the diesel fuel tank.
- Do not overfill the diesel exhaust fluid tank.
- Diesel exhaust fluid is corrosive.
- Do not re-use the diesel exhaust fluid container once it is emptied.

Fuel and Refueling

- Avoid spilling diesel exhaust fluid on painted surfaces, carpeting or plastic components. Immediately wipe away any diesel exhaust fluid that has spilled with a damp cloth and water. If it has already crystallized, use warm water and a sponge.
- Store diesel exhaust fluid out of direct sunlight and in temperatures between 23°F (-5°C) and 68°F (20°C).
- Diesel exhaust fluid freezes below 12°F (-11°C).
- Do not store the diesel exhaust fluid bottle in your vehicle. If it leaks it could cause damage to interior components or release an ammonia odor inside your vehicle.
- Diesel exhaust fluid is non-flammable, non-toxic, colorless and water-soluble liquid.
- The system has a diesel exhaust fluid quality sensor. Dilution of diesel exhaust fluid or use of any other liquid in the SCR system leads to a diesel exhaust fluid system fault, eventually leading to the vehicle only operating in idle-only mode.
- Do not dilute diesel exhaust fluid with water or any other liquid.
- An ammonia odor may be smelled when the cap is removed or during refill. Refill diesel exhaust fluid in a well ventilated area.

Typical Diesel Exhaust Fluid Usage When Using the Power Take Off (PTO)

Continuous PTO use—Minimal PTO use

0–7,800 mi (0–12,550 km)

Contaminated Diesel Exhaust Fluid or Inoperative Selective Catalytic Reduction System

Selective catalytic reduction systems are sensitive to contamination of the diesel exhaust fluid. Maintaining the purity of the fluid is important to avoid system malfunctions. If you remove or drain the diesel exhaust fluid tank, do not use the same fluid to refill the tank. The system has a sensor to monitor fluid quality.



A warning lamp illuminates and a message appears in the information display if the system becomes contaminated or inoperative.

Continued driving without replacing diesel exhaust fluid or having the selective catalytic reduction system repaired results in the following actions as required by the California Air Resources Board (CARB) and U.S. Environmental Protection Agency (EPA):

- Within a preset distance to empty, speed is limited upon vehicle restart. Prior to this occurring a message appears in the information display.
- Further vehicle operation without replacing contaminated diesel exhaust fluid causes the engine to enter an idle-only condition. This only occurs upon vehicle refueling, vehicle idling in park for 1 hour, or engine shutdown for 10 minutes or more and is indicated by a message in the information display indicating required actions to resume normal operation.

Fuel and Refueling

Note: For vehicle speed limiting or idle-only condition, normal vehicle operation resumes when you repair the contaminated system. To service a contaminated or inoperative system, see an authorized dealer.

REFUELING - GASOLINE

WARNINGS



Fuel vapor burns violently and a fuel fire can cause severe injuries.



Read and follow all the instructions on the pump island.



When refueling always shut the engine off and never allow sparks or open flames near the fuel tank filler valve. Never smoke or use a cell phone while refueling. Fuel vapor is extremely hazardous under certain conditions. Avoid inhaling excess fumes.



Stay outside your vehicle and do not leave the fuel pump unattended when refueling your vehicle.



Keep children away from the fuel pump; never let children pump fuel.



Wait at least 10 seconds before removing the fuel pump nozzle to allow any residual fuel to drain into the fuel tank.



Stop refueling after the fuel pump nozzle automatically shuts off for the second time. Failure to follow this will fill the expansion space in the fuel tank and could lead to fuel overflowing.



Do not remove the fuel pump nozzle from its fully inserted position when refueling.

Use the following guidelines to avoid electrostatic charge build-up when filling an ungrounded fuel container:

- Place approved fuel container on the ground.
- Do not fill a fuel container while it is in the vehicle (including the cargo area).
- Keep the fuel pump nozzle in contact with the fuel container while filling.
- Do not use a device that would hold the fuel pump handle in the fill position.

Fuel Filler Cap

WARNINGS



The fuel system may be under pressure. If you hear a hissing sound near the fuel filler inlet, do not refuel until the sound stops. Otherwise, fuel may spray out, which could cause serious personal injury.



If you do not use the correct fuel filler cap, excessive pressure or vacuum in the fuel tank may damage the fuel system or cause the fuel cap to disengage in a crash. Failure to follow this warning could result in serious personal injury.

The fuel tank has a threaded fuel filler cap.

Note: If you must replace the fuel filler cap, replace it with a fuel filler cap that is designed for your vehicle. The vehicle Warranty may be void for any damage to the fuel tank or fuel system if the correct genuine Ford, Motorcraft or other certified fuel filler cap is not used.

When refueling the vehicle fuel tank do the following.

1. When your vehicle has stopped, shift into neutral (N) or park (P).
2. Apply the parking brake and switch the ignition off.
3. Turn the fuel filler cap counterclockwise and remove it.

Fuel and Refueling

4. Refuel your vehicle as required.
5. Replace the fuel filler cap, turn it clockwise until you feel a strong resistance.

If the fuel cap warning lamp or a warning message appears in the instrument cluster, you may not have installed the fuel filler cap correctly.

If the fuel cap warning lamp remains on, at the next opportunity, safely pull off of the road, remove the fuel filler cap, align the cap properly and reinstall it. The check fuel cap warning lamp or warning message may not reset immediately. It may take several driving cycles for the indicators to turn off. A driving cycle consists of an engine start-up (after four or more hours with the engine off) followed by normal city and highway driving.

REFUELING - DIESEL

An engine that suddenly becomes noisy or operates poorly after a fuel fill could be using substandard fuel. We recommend that you purchase diesel fuel from a reputable fuel station.

Use only clean, approved containers that will prevent the entry of dirt or water whenever you store diesel fuel.

Do not store diesel fuel in a galvanized container. The fuel dissolves the zinc in the galvanized container. The zinc will then remain in the fuel. If you run the contaminated fuel through the engine, the zinc damages the fuel injectors. Engine damage caused may not be covered by the vehicle Warranty.

Fuel Filler Cap

WARNINGS



The fuel system may be under pressure. If you hear a hissing sound near the fuel filler inlet, do not refuel until the sound stops. Otherwise, fuel may spray out, which could cause serious personal injury.



If you do not use the correct fuel filler cap, excessive pressure or vacuum in the fuel tank may damage the fuel system or cause the fuel cap to disengage in a crash. Failure to follow this warning could result in serious personal injury.

The fuel tank has a threaded fuel filler cap.

Note: *If you must replace the fuel filler cap, replace it with a fuel filler cap that is designed for your vehicle. The vehicle Warranty may be void for any damage to the fuel tank or fuel system if the correct genuine Ford, Motorcraft or other certified fuel filler cap is not used.*

When refueling the vehicle fuel tank do the following.

1. When your vehicle has stopped, shift into neutral (N) or park (P).
2. Apply the parking brake and switch the ignition off.
3. Turn the fuel filler cap counterclockwise and remove it.
4. Refuel your vehicle as required.
5. Replace the fuel filler cap, turn it clockwise until you feel a strong resistance.

If the fuel cap warning lamp or a warning message appears in the instrument cluster, you may not have installed the fuel filler cap correctly.

Fuel and Refueling

If the fuel cap warning lamp remains on, at the next opportunity, safely pull off of the road, remove the fuel filler cap, align the cap properly and reinstall it. The check fuel cap warning lamp or warning message may not reset immediately. It may take several driving cycles for the indicators to turn off. A driving cycle consists of an engine start-up (after four or more hours with the engine off) followed by normal city and highway driving.

Fuel Fill Rate

Your vehicle has a fuel fill pipe that is able to accept fuel up to 20 gal (75 L) per minute from a fuel-dispensing nozzle. Pumping fuel at greater flow rates may result in premature nozzle shut-off or spit back.

Truck stops have fuel pumps and nozzles designed for larger, heavy-duty trucks. If you are refueling your vehicle at a truck stop and the nozzle shuts off repeatedly, wait 5-10 seconds, then use a slower fill rate.

FUEL CONSUMPTION

Real world fuel consumption is governed by many factors, for example driving style, high speed driving, stop-start driving, air conditioning usage, the accessories fitted, payload and towing.

- The usable capacity of the fuel tank is the amount of fuel that can be added into the tank after the gauge indicates empty.
- The advertised capacity is the total fuel tank size. See **Capacities and Specifications** (page 252). It is the combined usable capacity plus the empty reserve.
- Due to the empty reserve, you may not be able to refuel the full amount of the advertised capacity of the fuel tank even when the fuel gauge reads empty.

Empty reserve is the amount of fuel remaining in the tank after the fuel gauge indicates empty. The amount of usable fuel in the empty reserve varies and should not be relied upon to increase driving range.

Filling the Tank

For consistent results when filling the fuel tank:

- Turn the ignition off before refueling your vehicle; a temporary inaccurate reading may result if the engine is left on when refueling your vehicle.
- Use the same fill rate (low-medium-high) each time the tank is refueled.
- Allow no more than two automatic click-offs when refueling your vehicle.

Results are most accurate when the filling method is consistent.

Calculating Fuel Economy

Do not measure fuel economy during the first 900 mi (1,500 km) of driving (this is your engine's break-in period); a more accurate measurement is obtained after 1,900 mi (3,000 km).

Fuel expense, frequency of fill ups or fuel gauge readings are not accurate ways to measure fuel economy.

Fuel and Refueling

1. Fill the fuel tank completely and record the initial odometer reading.
2. Each time you fill the fuel tank, record the amount of fuel added.
3. After at least three fill ups, fill the fuel tank and record the current odometer reading.
4. Subtract your initial odometer reading from the current odometer reading.
5. Calculate fuel economy by dividing miles traveled by gallons used (For Metric: Multiply liters used by 100, then divide by kilometers traveled).

Keep a record for at least one month and record the type of driving (city or highway). This provides an accurate estimate of your vehicle's fuel economy under current driving conditions. Keeping records during summer and winter will show how temperature impacts fuel economy. In general, your vehicle will use more fuel in cold temperatures.

Conditions That Affect Fuel Economy

- Heavily loading your vehicle or towing a trailer may reduce fuel economy at any speed.
- Carrying unnecessary weight in your vehicle may reduce fuel economy.
- Adding certain accessories to your vehicle such as bug deflectors, rollbars or light bars, running boards and ski racks may reduce fuel economy.
- Using fuel blended with alcohol may lower fuel economy.
- Fuel economy may decrease with lower temperatures.
- You will get better fuel economy when driving on flat terrain than when driving on hilly terrain.

- Transmissions give their best fuel economy when operated in the top cruise gear and with steady pressure on the accelerator pedal.
- Close the windows for high-speed driving.

EMISSION CONTROL SYSTEM - GASOLINE

WARNINGS



Do not park, idle or drive your vehicle on dry grass or other dry ground cover. The emission system heats up the engine compartment and exhaust system, creating the risk of fire.



Exhaust leaks may result in entry of harmful and potentially lethal fumes into the passenger compartment. If you smell exhaust fumes inside your vehicle, have your vehicle inspected immediately. Do not drive if you smell exhaust fumes.

Your vehicle has various emission control components and a catalytic converter that enables it to comply with applicable exhaust emission standards.

To make sure that the catalytic converter and other emission control components continue to work properly:

- Use only the specified fuel listed.
- Avoid running out of fuel.
- Do not turn off the ignition while your vehicle is moving, especially at high speeds.
- Have the items listed in scheduled maintenance information performed according to the specified schedule.

The scheduled maintenance items listed in scheduled maintenance information are essential to the life and performance of your vehicle and to its emissions system.

Fuel and Refueling

If you use anything other than Ford, Motorcraft or Ford-authorized parts for maintenance replacements or for service of components affecting emission control, such non-Ford parts should be equivalent to genuine Ford Motor Company parts in performance and durability.

Illumination of the service engine soon indicator, charging system warning light or the temperature warning light, fluid leaks, strange odors, smoke or loss of engine power could indicate that the emission control system is not working properly.

An improperly operating or damaged exhaust system may allow exhaust to enter the vehicle. Have a damaged or improperly operating exhaust system inspected and repaired immediately.

Do not make any unauthorized changes to your vehicle or engine. By law, vehicle owners and anyone who manufactures, repairs, services, sells, leases, trades vehicles, or supervises a fleet of vehicles are not permitted to intentionally remove an emission control device or prevent it from working. Information about your vehicle's emission system is on the Vehicle Emission Control Information Decal located on or near the engine. This decal also lists engine displacement.

Please consult your warranty information for complete details.

On-Board Diagnostics (OBD-II)

Your vehicle has a computer known as the on-board diagnostics system (OBD-II) that monitors the engine's emission control system. The system protects the environment by making sure that your vehicle continues to meet government emission standards. The OBD-II system also assists a service technician in properly servicing your vehicle.



When the service engine soon indicator illuminates, the OBD-II system has detected a malfunction. Temporary malfunctions may cause the service engine soon indicator to illuminate. Examples are:

1. Your vehicle has run out of fuel—the engine may misfire or run poorly.
2. Poor fuel quality or water in the fuel—the engine may misfire or run poorly.
3. The fuel fill inlet may not have closed properly. See **Refueling** (page 100).
4. Driving through deep water—the electrical system may be wet.

You can correct these temporary malfunctions by filling the fuel tank with good quality fuel, properly closing the fuel fill inlet or letting the electrical system dry out. After three driving cycles without these or any other temporary malfunctions present, the service engine soon indicator should stay off the next time you start the engine. A driving cycle consists of a cold engine startup followed by mixed city and highway driving. No additional vehicle service is required.

If the service engine soon indicator remains on, have your vehicle serviced at the first available opportunity. Although some malfunctions detected by the OBD-II may not have symptoms that are apparent, continued driving with the service engine soon indicator on can result in increased emissions, lower fuel economy, reduced engine and transmission smoothness and lead to more costly repairs.

Fuel and Refueling

Readiness for Inspection and Maintenance (I/M) Testing

Some state and provincial and local governments may have Inspection/Maintenance (I/M) programs to inspect the emission control equipment on your vehicle. Failure to pass this inspection could prevent you from getting a vehicle registration.



If the service engine soon indicator is on or the bulb does not work, your vehicle may need service. See On-Board Diagnostics.

Your vehicle may not pass the I/M test if the service engine soon indicator is on or not working properly (bulb is burned out), or if the OBD-II system has determined that some of the emission control systems have not been properly checked. In this case, the vehicle is not ready for I/M testing.

If the vehicle's engine or transmission has just been serviced, or the battery has recently run down or been replaced, the OBD-II system may indicate that the vehicle is not ready for I/M testing. To determine if the vehicle is ready for I/M testing, turn the ignition key to the on position for 15 seconds without cranking the engine. If the service engine soon indicator blinks eight times, it means that the vehicle is not ready for I/M testing; if the service engine soon indicator stays on solid, it means that your vehicle is ready for I/M testing.

The OBD-II system checks the emission control system during normal driving. A complete check may take several days.

If the vehicle is not ready for I/M testing, you can perform the following driving cycle consisting of mixed city and highway driving:

1. 15 minutes of steady driving on an expressway or highway followed by 20 minutes of stop-and-go driving with at least four 30-second idle periods.
2. Allow your vehicle to sit for at least eight hours with the ignition off. Then, start the vehicle and complete the above driving cycle. The vehicle must warm up to its normal operating temperature. Once started, do not turn off the vehicle until the above driving cycle is complete.

If the vehicle is still not ready for I/M testing, you need to repeat the above driving cycle.

EMISSION CONTROL SYSTEM - DIESEL

Oxidation Catalytic Converter and Diesel Particulate Filter System (if

Equipped)

WARNING



The normal operating temperature of the exhaust system is very high. Never work around or attempt to repair any part of the exhaust system until it has cooled. Use special care when working around the diesel oxidation catalytic converter or the diesel particulate filter. The diesel oxidation catalytic converter and the diesel particulate filter heat up to very high temperatures after only a short period of engine operation and remain hot after you switch the engine off.

Your vehicle has a diesel particulate filter. The diesel particulate filter is an inline filter in the exhaust system that reduces carbon emissions by trapping exhaust particles before they reach the tailpipe. The diesel particulate filter looks similar to a traditional exhaust catalyst and is part of the exhaust system under your vehicle. The

Fuel and Refueling

filter couples to a diesel oxidation catalyst that reduces the amount of harmful exhaust emitted from the tailpipe. As soot gathers in the system, it begins to restrict the filter. The system must periodically clean the soot that gathers inside the filter. This is carried out in two ways, passive regeneration and active regeneration. Both methods occur automatically and require no actions from the driver. During either one of these regeneration methods, although you may notice a change in exhaust tone. At certain times, the information display shows various messages related to the diesel particulate filter. See **Information Messages** (page 64).

Diesel Particulate Filter Maintenance

You must properly maintain your vehicle's diesel particulate filter in order for it to function properly.

Do not disregard maintenance messages that appear in the information display. Failure to follow the instructions of an information message may degrade vehicle performance and could lead to engine damage that may not be covered by the vehicle Warranty.

Failure to perform active or operator commanded regeneration when instructed could result in a clogged diesel particulate filter. If the diesel particulate filter fills beyond the regeneration threshold, your vehicle disables the ability for active and operator commanded regeneration. This could result in irreversible damage to the diesel particulate filter requiring replacement that may not be covered by the vehicle Warranty.

Passive Regeneration

In passive regeneration, the exhaust system temperature and constituents automatically clean the filter by oxidizing the soot. Cleaning automatically occurs during normal vehicle operating conditions due to driving patterns.

Active Regeneration

Once the diesel particulate filter is full of exhaust particles, the engine control module commands the exhaust system to clean the filter through active regeneration. Active regeneration requires the engine computer to raise the exhaust temperature to eliminate the particles. During cleaning, the particles convert to harmless gasses. Once cleaned the diesel particulate filter continues trapping exhaust particles.

The regeneration process operates more efficiently when you drive your vehicle at a constant speed above 30 mph (48 km/h) and at a steady engine speed for approximately 20 minutes. The frequency and duration of regeneration fluctuates by how you drive your vehicle, outside air temperature and altitude. For most driving, regeneration frequency varies from 100–500 mi (160–805 km) between occurrences and each occurrence lasts 9–35 minutes. You can usually reduce the duration of regeneration if you maintain a constant speed above 30 mph (48 km/h).

When the engine control module detects that the diesel particulate filter is nearly full of particulates and you are not operating your vehicle in a manner to allow effective automatic regeneration, messages appear in the information display as a reminder for you to drive your vehicle in order to clean the diesel particulate filter. If you drive your vehicle in a manner to allow effective automatic regeneration, the information display

Fuel and Refueling

shows a cleaning exhaust filter message, which is the normal regeneration process. You can also choose operator commanded regeneration to clean the exhaust system at this point. See **Information Messages** (page 64).

If you are not able to drive in a manner that allows effective automatic active regeneration or you choose to perform regeneration of the diesel particulate filter while at idle, then operator commanded regeneration would need to be performed.

Operator Commanded Regeneration (If Equipped)

If your vehicle is operated with significant stationary operation, low speed drive cycles less than 25 mph (40 km/h), short drive cycles, a drive time is less than 10 - 15 minutes or the vehicle does not fully warm up, passive and active regeneration may not sufficiently clean the diesel particulate filter system. Operator commanded regeneration allows you to manually start regeneration of the diesel particulate filter at idle to clean the filter. If you are not sure whether your vehicle has this feature, contact an authorized dealer.

When to Carry Out Operator Commanded Regeneration

You can use the operator commanded regeneration feature when a message appears in the information display and you are not able to drive in a manner that allows effective automatic active regeneration or if you choose to manually start the regeneration of the diesel particulate filter manually while the vehicle is idle. See **Information Messages** (page 64).

Operator Commanded Regeneration Precautions and Safe Exhaust Position

WARNING



Failure to comply with the following instructions for Operator Commanded Regeneration may result in fire, serious injury, death or property damage.

Make sure that the louvers located at the tip of the exhaust are clear of any obstructions as they are used to introduce fresh air into the tailpipe to cool the exhaust gases as they leave the exhaust system.

Before you start operator commanded regeneration, do the following:

- Shift into park (P) and apply the parking brake on stable, level ground.
- Park your vehicle outside of any structure.
- Park your vehicle 10–15 ft (3–5 m) away from any obstructions and away from materials that can easily combust or melt, for example paper, leaves, petroleum products, fuels, plastics and other dry organic material.
- Make sure there is a minimum of 1/8 tank of fuel.
- Make sure all fluids are at proper levels.

How to Start Operator Commanded Regeneration

WARNING



Stay clear of exhaust tip during regeneration. Hot exhaust gases can burn you badly.

Fuel and Refueling

Note: You cannot use the operator commanded regeneration until the diesel particulate filter load percentage has reached 100%. The diesel particulate filter load percentage fluctuates up and down when driving your vehicle due to active and passive regenerations.

Note: During the use of operator commanded regeneration, you may observe a light amount of white smoke. This is normal.



You may not be able to use operator commanded regeneration if the service engine soon warning lamp appears in the information display

Information Display Procedure

Start with your vehicle engine and when it has reached the normal operating temperature, press the information display control button on the steering wheel. See **Information Display Control** (page 45). If a message advising that the exhaust filter is full appears in the information display, press the **OK** button to set the display to **Y**. Answer yes to this prompt and then follow the next prompts regarding exhaust position required to initiate operator commanded regeneration. Be sure to understand each prompt. If you are not sure what is being asked by each prompt, contact an authorized dealer. The display confirms the operation has started and when it has finished.

If the diesel particulate filter is near or at saturation, a message requesting permission to initiate filter cleaning appears in the information display. See **Information Messages** (page 64). Answer yes to this prompt and then follow the next prompts regarding exhaust position required to initiate operator commanded regeneration. Be sure to

understand each prompt. If you are not sure what is being asked by each prompt, contact an authorized dealer. The display confirms the operation has started and when it has finished. You can also drive to clean the filter.



When the system is at the point of oversaturation, the service engine warning lamp illuminates and a message appears in the information display. You cannot initiate filter cleaning. You must have your vehicle checked as soon as possible.

Once operator commanded regeneration starts, engine speed increases to approximately 2000–2500 rpm and the cooling fan speed increases. You will hear a change in audible sound due to engine speed and cooling fan speed increases.

It is not necessary to open the hood on the engine compartment. Once operator commanded regeneration completes, the engine speed returns to normal idling. The exhaust system remains very hot for several minutes even after regeneration is complete. Do not reposition the vehicle over materials that could burn until the exhaust system has had sufficient time to cool. Depending on the amount of soot collected by the diesel particulate filter, ambient temperature and altitude, operator commanded regeneration lasts approximately 30 minutes.

Operator Commanded Regeneration with Automatic Regeneration Control (If Equipped)

If your vehicle is operated with significant stationary operation, low speed drive cycles less than 25 mph (40 km/h), short drive cycles, drive time less than 15 minutes or the vehicle does not fully warm up, passive and active regeneration may not sufficiently clean the diesel particulate

Fuel and Refueling

filter system. You can switch off automatic regeneration until better driving conditions are available, for example steady high speed driving. You can then switch automatic regeneration back on to clean the diesel particulate filter.

Switching Automatic Regeneration Control On and Off

To switch operator commanded regeneration on and off, use the information display control on the steering wheel. See **Information Display Control** (page 45). Scroll to the exhaust cleaning message and then select **Y** or **N** to switch it On or Off.

How to Interrupt or Cancel Operator Commanded Regeneration

If you need to cancel the operator commanded regeneration, pressing the brake, accelerator or switching the engine off stops the procedure. Depending on the amount of time you allowed the operator commanded regeneration to operate, soot may not have had sufficient time to be fully eliminated, but the exhaust system and exhaust gas may still be hot. If you shut your vehicle off during operator commanded regeneration, you may notice turbo flutter. This is a normal consequence caused by shutting off a diesel engine during boosted operation and is considered normal.

Filter Service and Maintenance

Over time, a slight amount of ash builds up in the diesel particulate filter, which is not removed during the regeneration process. The filter may need to be removed for ash cleaning at approximately 120,000 mi (190,000 km) or it may need to be replaced with a new or remanufactured part. Actual mileage varies depending on engine and vehicle

operating conditions. The filter may need to be replaced with a new or remanufactured part at approximately 250,000 mi (400,000 km). Actual mileage varies depending on engine and vehicle operating conditions.



If filter service is required, the engine control system warning lamp illuminates in the information display.



If there are any issues with the diesel particulate filter system, the engine control system warning lamp and a service engine soon warning lamp illuminate to inform you that your vehicle requires service. Have your vehicle checked as soon as possible.



Resonator and Tailpipe Assembly Maintenance

Aftermarket devices or modifications to the exhaust system may reduce the effectiveness of the exhaust system as well as cause damage to the exhaust system or engine. This may also degrade vehicle performance and could lead to engine damage that may not be covered by the vehicle Warranty.

Emission Control System Laws

WARNING



Do not remove or alter the original equipment floor covering or insulation between it and the metal floor of the vehicle. The floor covering and insulation protect occupants of the vehicle from the engine and exhaust system heat and noise. On vehicles with no original equipment floor covering insulation, do not carry passengers in a manner that permits prolonged skin contact with the metal floor. Failure to follow these instructions may result in fire or personal injury.

Fuel and Refueling

In the United States, federal law and certain state laws prohibit removing or rendering the emission control system inoperative. Similar federal or provincial laws may apply in Canada. We do not recommend any vehicle modification without determining applicable law.



Tampering with emissions control system, including related sensors or the diesel exhaust fluid injection system can result in reduced engine power and the service engine soon warning lamp illuminating in the information display.

Tampering with a Noise Control System

Federal law prohibits the following acts or the causing thereof:

- The removal or rendering inoperative by any person other than for purposes of maintenance, repair or replacement of any device or element of design incorporated into any new vehicle for the purpose of noise control prior to its sale or delivery to the ultimate purchaser or while it is in use.
- The use of the vehicle after such device or element of design has been removed or rendered inoperative by any person.

Among those acts, which the United States Environmental Protection Agency may presume to constitute tampering are the acts listed below:

- Removal of hood blanket, fender apron absorbers, fender apron barriers, underbody noise shields or acoustically absorptive material.
- Tampering or rendering inoperative the engine speed governor, to allow engine speed to exceed manufacturer's specifications.

The complexity of the diesel engine makes it so the owner is discouraged from attempting to perform maintenance other than the services described in this Owner's Manual.

If you experience difficulty starting the engine, rough idling, excessive exhaust smoke, a decrease in engine performance or excess fuel consumption, perform the following checks:

- A plugged or disconnected air inlet system or engine air filter element.
- Water in the fuel filter and water separator.
- A clogged fuel filter.
- Contaminated fuel.
- Air in the fuel system, due to loose connections.
- An open or pinched sensor hose.
- Check engine oil level.
- Wrong fuel or oil viscosity for the climatic conditions.

If these checks do not help you correct the engine performance problem you are experiencing, have your vehicle checked as soon as possible.

Noise Emissions Warranty, Prohibited Tampering Acts and Maintenance

On January 1, 1978, Federal regulation became effective governing the noise emission on vehicles weighing over 10,000 lb (4,536 kg) Gross Vehicle Weight Rating. The preceding statements concerning prohibited tampering acts and maintenance, and the noise warranty found in the Warranty Guide, are applicable to complete chassis cabs over 10,000 lb (4,536 kg) Gross Vehicle Weight Rating.

Fuel and Refueling

FUEL TANK SELECTOR SWITCH (If Equipped)



E205996

Your vehicle has two fuel tanks. The fuel in each fuel tank is independently used. Use the switch on the instrument panel to select the left-hand or right-hand fuel tank. The fuel gauge indicates the remaining fuel in the selected fuel tank. See **Gauges** (page 54).

Transmission

AUTOMATIC TRANSMISSION

WARNING



Always set the parking brake fully and make sure you shift the gearshift lever to park (P). Switch the ignition off and remove the key whenever you leave your vehicle.

Understanding the Shift Positions of a 6-Speed Automatic Transmission (If Equipped)

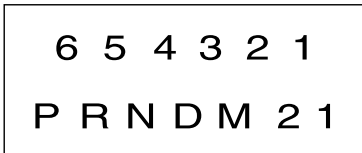

E163183

Putting your vehicle in or out of gear:

1. Fully press down the brake pedal.
2. Move the gearshift lever into the desired gear.
3. Come to a complete stop.
4. Move the gearshift lever and securely latch it in park (P) or neutral (N).

Park (P) (If Equipped)

If your transmission has a park position, this position locks the transmission and prevents the rear wheels from turning.

Reverse (R)

With the gearshift lever in reverse (R), your vehicle moves backward. Always come to a complete stop before shifting into and out of reverse (R).

Neutral (N)

With the gearshift lever in neutral (N), you can start your vehicle and it is free to roll. Hold the brake pedal down while in this position.

Drive (D)

Drive (D) is the normal driving position for the best fuel economy. The overdrive function allows automatic upshifts and downshifts through gears one through six.

M (Manual)

With the gearshift lever in manual (M), the driver can change gears up or down as desired. By moving the gearshift lever from drive position drive (D) to manual (M) you now have control of selecting the gear you desire using buttons on the shift lever. See Understanding your SelectShift Automatic™ transmission later in this section.

To return to normal drive (D) position, move the shift lever back from manual (M) to drive (D).

The transmission operates in gears one through six.

Second (2)

Transmission operates in second (2) gear only. Use second (2) gear to start-up on slippery roads.

First (1)

- Transmission operates in first (1) gear only.
- Provides maximum engine braking.
- Allows upshifts by moving gearshift lever.
- Does not downshift into first (1) gear at high speeds; allows for first (1) gear when vehicle reaches slower speeds.

Transmission

Forced downshifts

- Allowed in drive (D) with the tow/haul feature on or off.
- Press the accelerator to the floor.
- Allows transmission to select an appropriate gear.

Tow/Haul Mode

TOW HAUL To activate tow/haul, press the button on the gearshift lever once. The TOW HAUL indicator light illuminates in the instrument cluster.

The tow/haul feature:

- Delays upshifts to reduce the frequency of transmission shifting.
- Provides engine braking in all forward gears, which slows your vehicle and assists you in controlling your vehicle when descending a grade.
- Depending on driving conditions and load conditions, may downshift the transmission, slow your vehicle and control your vehicle speed when descending a hill, without pressing the accelerator pedal. The amount of downshift braking provided will vary based upon the amount you press the brake pedal.

The tow/haul feature improves transmission operation when towing a trailer or a heavy load. All transmission gear ranges are available when using tow/haul.

To deactivate the tow/haul feature and return to normal driving mode, press the button on the gearshift lever twice. The TOW HAUL light deactivates. Tow/haul also deactivates when you power down your vehicle.

WARNING



Do not use the tow/haul feature when driving in icy or slippery conditions as the increased engine braking can cause the rear wheels to slide and your vehicle to swing around with the possible loss of vehicle control.

Understanding your SelectShift™ Automatic transmission (If Equipped)

Your vehicle is equipped with a SelectShift Automatic transmission gearshift lever. SelectShift Automatic transmission gives you the ability to change gears up or down (without a clutch) as desired.



E163184

Use the buttons on the shifter to lock or unlock gears and manually select gears. Press the + button to upshift or the – button to downshift.

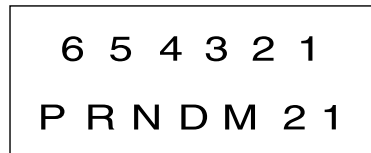

E163183

Transmission

With the gearshift lever in drive (D), press the – button to activate SelectShift. The instrument cluster indicates the available and selected gears.

All available gears display with the current gear indicated. Press the – button again to lock out gears beginning with the highest gear. Example: press the – button twice to lock out 6th and 5th gears. Only the available gears display and the transmission automatically shifts between the available gears. Press the + button to unlock gears.

By moving the gearshift lever from the drive (D) position to the manual (M) position you may now manually select the gear you desire. Only the current gear displays. Press the + button or the – button to upshift or downshift. If you press the – button at a vehicle speed that would cause an engine overspeed, the requested gear flashes then disappears and the transmission remains in the current gear.

Recommended shift speeds

Upshift according to the following chart:

Upshifts when accelerating (recommended for best fuel economy)		
Shift from:	Gasoline engines	Diesel engines
1 – 2	15 mph (24 km/h)	12 mph (19 km/h)
2 – 3	25 mph (40 km/h)	19 mph (31 km/h)
3 – 4	40 mph (64 km/h)	26 mph (42 km/h)
4 – 5	45 mph (72 km/h)	34 mph (55 km/h)
5 – 6	50 mph (80 km/h)	46 mph (74 km/h)

In order to prevent the engine from running at too low an RPM, which may cause it to stall, SelectShift still automatically makes some downshifts if it has determined that you have not downshifted in time.

Although SelectShift makes some downshifts for you, it still allows you to downshift at any time as long as the SelectShift determines that there is no damage to the engine from over-revving.

SelectShift does not automatically upshift, even if the engine is approaching the RPM limit. You must shift manually by pressing the + button.

Note: *Engine damage may occur if you rev the engine excessively and hold it without shifting.*

Automatic Transmission Adaptive Learning

This feature's design is to increase durability and provide consistent shift feel over the life of your vehicle. A new vehicle or transmission may have firm shifts, soft shifts or both. This operation is normal and does not affect function or durability of the transmission. Over time, the adaptive learning process fully updates transmission operation. Additionally, whenever you disconnect the battery or install a new battery, the system must relearn the strategy.

Transmission

Brake-Shift Interlock (if Equipped)

WARNINGS



Do not drive your vehicle until you verify that the brake lamps are working.



When doing this procedure, you need to take the transmission out of park (P) which means your vehicle can roll freely. To avoid unwanted vehicle movement, always fully set the parking brake prior to doing this procedure. Use wheels chocks if appropriate.



If the parking brake is fully released, but the brake warning lamp remains illuminated, the brakes may not be working properly. Have your vehicle checked as soon as possible.

Your vehicle is equipped with a brake-shift interlock feature that prevents the gearshift lever from moving from park (P) when the ignition is in the 3 (on) position and the brake pedal is not pressed.

If you cannot move the gearshift lever out of park (P) position with the ignition in the 4 (on) position and the brake pedal pressed, a malfunction may have occurred. It is possible that a fuse has blown or your vehicle's brake lamps are not operating properly. See **Fuse Specification Chart** (page 161).

If the fuse is not blown and the brake lamps are working properly, the following procedure allows you to move the gearshift lever from park (P):

1. Apply the parking brake. Switch the ignition key to 1 (off), then remove the key.
2. Move the steering column to the full down and full rearward position (toward the driver's seat).
3. Remove the gearshift lever boot.

4. Place fingers into hole where you removed the gearshift lever boot and pull top half of shroud up and forward to separate it from the lower half of the shroud. There is a hinge at the forward edge of the top shroud. Roll the top half of the shroud upward on the hinge point to clear the hazard flasher button, then pull straight rearward toward the driver's seat to remove.
5. Remove the top half of the shroud.
6. Remove the three fasteners under the column that secure the lower shroud half to the column.



E163185

7. Pull the lock lever into the full unlocked position and remove the lower shroud cover by pulling the lever handle through the slot in the cover.
8. Apply the brake. Gently lift the override disk and move the gearshift lever into neutral (N).

Transmission

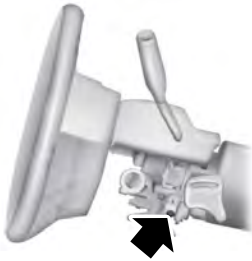

E163186

9. Start your vehicle.

Perform Steps 4 through 8 in reverse order, making sure to engage the hinge pivots between the upper and lower halves of the shroud. Keep slight pressure in the forward direction as you rotate the halves together.

If Your Vehicle Gets Stuck In Mud or Snow

Note: Do not rock your vehicle if the engine is not at normal operating temperature or damage to the transmission may occur.

Note: Do not rock your vehicle for more than a minute or damage to the transmission and tires may occur, or the engine may overheat.

If your vehicle is stuck in mud or snow, you may rock it out by shifting between forward and reverse gears, stopping between shifts in a steady pattern. Press lightly on the accelerator in each gear.

POWER TAKE-OFF (If Equipped)

Auxiliary equipment called power take-off, or PTO, is often added to the engine or transmission to operate utility equipment. Examples include a wheel-lift for tow trucks, cranes, tools for construction or tire service and pumping fluids. PTO applications draw auxiliary horsepower from the powertrain, often while the

vehicle is stationary or mobile. In the stationary condition, there is limited cooling air flow through the radiator and around the vehicle that normally occurs when a vehicle is moving. The aftermarket PTO system installer, having the most knowledge of the final application, is responsible for determining whether additional chassis heat protection or powertrain cooling is required and alerting the user to the safe and proper operation.

Your vehicle is approved for use as a Stationary Mode, SplitShaft Mode or Mobile Mode power source within the limits and operating guidelines detailed in the Ford Truck Body Builders Layout Book, found at www.fleet.ford.com/truckbbas.com and through the Ford Truck Body Builders Advisory Service. The transmission power source modes are engine specific.

Rear Axle

GENERAL INFORMATION

WARNING



Exceeding these ratings by overloading can cause component failure resulting in property damage, personal injury or death.

Fluid Temperature

If the operating temperature exceeds 250°F (121°C), the rate of axle lubrication oxidation increases and shortens the life of the lubricant and seals, requiring axle lubrication changes to become more frequent to preserve the axle. Do not consistently run extreme pressure (EP) lubricants above 250°F (121°C).

Axle Conversions

WARNING



When operating a loaded vehicle, the driver must keep all adjustable axles on the ground at all times, supporting their share of the vehicle's load. Failure to do so can overload other axles, tires, wheels, springs, steering components, brakes and frames, resulting in early component failure, loss of vehicle control, possible property damage and personal injury.

We do not recommend, or approve, performing axle conversions. However, we understand that, on occasion, others install aftermarket add-on axles on the truck chassis that allow operator control for weight transfer from other axles (such as air lift axles).

LIMITED SLIP DIFFERENTIAL

(If Equipped)

WARNING



If both wheels are not raised off the ground, the one wheel that is not raised may pull the vehicle off its support, possibly resulting in personal injury.

This axle provides added traction on slippery surfaces, particularly when one wheel is on a poor traction surface. Under normal conditions, the limited-slip axle functions like a standard rear axle. The axle may exhibit a slight noise or vibration during tight turns with low vehicle speed. This is normal behavior and indicates the axle is working.

Both wheels must be raised off the ground should it be necessary to operate one wheel with your vehicle stationary.

ELECTRONIC LOCKING DIFFERENTIAL (If Equipped)

Driver-Controlled Locking Differential

Note: *Never use the differential lock at vehicle speeds above 25 mph (40 km/h).*

Some drive axles have a driver-controlled differential lock. The differential lock can lock or unlock the differential when your vehicle is moving or stopped. When extra traction is required, the differential lock provides full power to both wheels.

When you lock the differential, your vehicle's turning radius increases (under-steer).

Take care to avoid sudden accelerations when both drive wheels are on a slippery surface.

Rear Axle

WARNING



Sudden accelerations on slippery surfaces could cause the wheels to spin, the vehicle to turn sideways on a crowned road surface or in a turn, possibly resulting in loss of vehicle control and personal injury.

Activating the Locking Differential

You can lock and unlock the differential when your vehicle is moving at a constant speed of less than 25 mph (40 km/h) and while the wheels are not slipping. Do not lock the differential when your vehicle is traveling down steep grades and when traction is minimal.

The differential lock and differential lock light automatically disengage at speeds above 25 mph (40 km/h). The differential lock remains off until either you restart your vehicle or you turn the differential lock switch off then back on.

Servicing a Vehicle with a Locking Differential

Turn the engine off and raise all drive wheels of the locker differential axle in order to prevent your vehicle from moving when servicing the wheels, tires or brakes. Axles equipped with a driver-controlled differential deliver power to both wheels even when only one wheel is on the ground.

WARNING



Failure to raise all drive wheels with this type of differential could cause the vehicle to move unexpectedly, resulting in property damage, personal injury or death.

2-SPEED REAR AXLE (If Equipped)

WARNING



Never shift a two-speed axle when descending a steep grade as this may cause loss of vehicle control and result in personal injury.

Note: Do not shift between ranges when the speed control is on.

A two-speed rear axle allows the driver to select a low range for greater pulling power and a high range for greater road speed and fuel economy. You can also use these ranges to provide extra steps between transmission shifts when driving on steep grades or fuel economy may be factors.

Axle Shifting

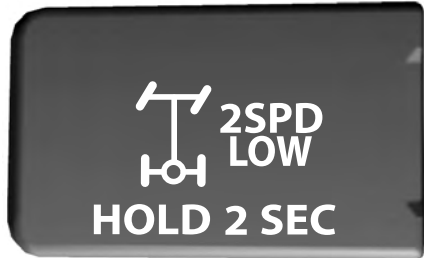

E208228

Note: Do not shift the axle to LOW when your vehicle is moving. Use LOW when you drive a fully loaded vehicle on a severe grade or in congested traffic. Use HIGH for all normal driving conditions with a lightly loaded or partially loaded vehicle.

Note: The axle is set to HIGH by default.

To shift the axle between HIGH and LOW with the vehicle stopped, place the transmission in position N, then press and hold the button for two seconds.

Brakes

GENERAL INFORMATION

WARNINGS



Do not drive with your foot resting on the brake pedal. This results in abnormally high brake temperatures, excessive lining wear and increased stopping distance.



Continuous application of the brakes causes the brakes to overheat, resulting in temporary loss of braking.

Note: Occasional brake noise is normal. If a metal-to-metal, continuous grinding or continuous squeal sound is present, the brake linings may be worn-out. Have the system checked by an authorized dealer. If your vehicle has continuous vibration or shudder in the steering wheel while braking, have it checked by an authorized dealer.

All standard equipment brakes are self-adjusting. Automatic adjustment, when required, occurs whenever you apply and release the brakes during forward or reverse operation.

Know the required stopping distances for all driving conditions you may encounter. For longer brake lining life, take full advantage of engine braking power when coming to a stop.



See **Warning Lamps and Indicators** (page 58).

Wet brakes result in reduced braking efficiency. Gently press the brake pedal a few times when driving from a car wash or standing water to dry the brakes.

If brakes do not grip well:

- Check brake adjustment.
- Check brake linings for excessive wear.
- Check system air pressure on vehicle equipped with air brakes.

- Let the brakes cool if you have been using them excessively, as in mountain driving or after several fast, high-speed stops.
- If you have been driving through deep water, gently apply the brakes several times while your vehicle is moving slowly.

Brake Over Accelerator

In the event the accelerator pedal becomes stuck or entrapped, apply steady and firm pressure to the brake pedal to slow the vehicle and reduce engine power. If you experience this condition, apply the brakes and bring your vehicle to a safe stop. Move the transmission to park (P), switch the engine off and apply the parking brake. Inspect the accelerator pedal for any interference. If none are found and the condition persists, have your vehicle towed to the nearest authorized dealer

Anti-lock Brake System

This system helps you maintain steering control during emergency stops by keeping the brakes from locking.



This lamp momentarily illuminates when you turn the ignition on. If the light does not illuminate during start up, remains on or flashes, the system may be disabled. Have the system checked by an authorized dealer.



If the system is disabled, normal braking is still effective. If the brake warning lamp illuminates when you release the parking brake, have the system checked by an authorized dealer.

Brakes



If you connect a PLC trailer with the ignition on, the trailer ABS light also illuminates. If the light fails to illuminate, if it remains on after you start the vehicle or continues to flash, have the system serviced immediately.

HINTS ON DRIVING WITH ANTI-LOCK BRAKES

Note: *When the system is operating, the brake pedal may pulse and may travel further. Maintain pressure on the brake pedal. You may also hear a noise from the system. This is normal.*

The anti-lock braking system will not eliminate the risks when:

- You drive too closely to the vehicle in front of you.
- Your vehicle is hydroplaning.
- You take corners too fast.
- The road surface is poor.

PARKING BRAKE

Hydraulic Brakes

WARNINGS



Always set the parking brake and leave your vehicle with the transmission in park (P).



When doing this procedure, you need to take the transmission out of park (P) which means your vehicle can roll freely. To avoid unwanted vehicle movement, always fully set the parking brake prior to doing this procedure. Use wheels chocks if appropriate.



Unexpected and possibly sudden vehicle movement may occur if you do not take these precautions.

WARNINGS



If the parking brake is fully released, but the brake warning lamp remains illuminated, the brakes may not be working properly. Have your vehicle checked as soon as possible.

Apply the parking brake whenever the vehicle is parked. To set the parking brake, pull the handle up until it snaps into the locked position.

When the parking brake is out of adjustment, seek service immediately.



The parking brake warning lamp in the instrument cluster illuminates, and remains illuminated (when you switch on the ignition), until you release the parking brake.



E210347

Push the palm release lever (A) on the parking brake handle (B) and push down as far as possible to release the brake. Driving with the parking brake on causes the brakes to wear out quickly and reduces fuel economy.

We recommend you not use the parking brake to stop a moving vehicle. However, if the normal brakes fail, you can use the parking brake to stop your vehicle in an emergency. Since the parking brake only applies retardation to the rear wheels, the vehicle's stopping distance increases greatly and the handling of your vehicle is adversely affected.

Brakes

Releasing Spring Manually

WARNINGS



Do not attempt to disassemble the parking brake air chamber under any circumstances as this may cause serious injury.



Block the wheels to help prevent the vehicle from moving.



Unexpected and possibly sudden vehicle movement may occur if you do not take these precautions.

If you release hydraulic pressure from the spring brake chamber, the power spring applies the brake. If the hydraulic pressure can be re-established, you must release the spring brake in order to move your vehicle.

Air Brakes

WARNING



This control is for parking only. Do not leave the vehicle unattended after setting the parking brake without placing the transmission in park (P). We recommend using wheel chocks for hilly or off-road circumstances.

If the service brakes fail to operate while your vehicle is moving, you can make an emergency stop with the parking brake. Since the parking brake only applies stopping power to the rear wheels, your vehicle's stopping distance greatly increases and the handling of your vehicle is adversely affected. Make repairs immediately to an inoperative air brake system circuit.



E210341

Pull the yellow, dash-mounted parking brake knob to apply the parking brake.



The parking brake light illuminates and remains illuminated (when you switch the ignition to the on position) until you release the parking brake.

Releasing the Parking Brake

WARNING



Hold the brake pedal down when moving the gearshift lever. If you do not hold down the brake pedal, the vehicle may move unexpectedly, resulting in property damage, personal injury or death.

Note: Read and understand the following steps and perform them whenever you prepare to drive the vehicle.

Note: The parking brake does not disengage unless sufficient system air pressure is available.

1. Press and hold the service brake pedal while the engine is running.
2. Select the appropriate drive gear.
3. Push and hold the yellow dash-mounted parking brake knob until the parking brake light turns off, then release.

Brakes

Parking Brake Light Illumination Due to Low Air Pressure

If the air pressure becomes too low at any time during vehicle operation, the parking brake may apply and the parking brake light turns on.

If the parking brake applies due to low air pressure, immediate service is required to the parking brake system.

Releasing Spring Brake with Air Pressure

The air system in all vehicles with spring-actuated rear wheel parking brakes has a valve on the governor for connection to an outside air supply. The valve lets you recharge the system with air from an outside source, releasing the spring-actuated parking brakes. Your vehicle is now ready to tow in an emergency.

You can only use an outside air source if the protected system is in operating condition. If you cannot restore air pressure in the protected air system, you must release the spring-actuated brakes manually.

Releasing Spring Manually

Do not use impact wrenches as they may damage the piston and prevent proper caging of the spring. Do not apply more than 50 lb.ft (68 Nm) to the release bolt nut.

1. Remove the stud tool and nut from the carrying pocket on the brake chamber assembly.

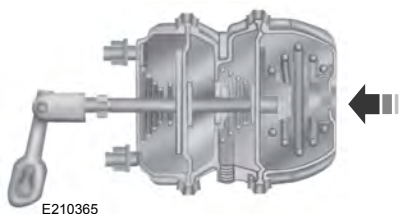

2. Remove the access plug from the end of the spring chamber.
3. Insert the release stud through the opening in the chamber and into the spring pressure plate.

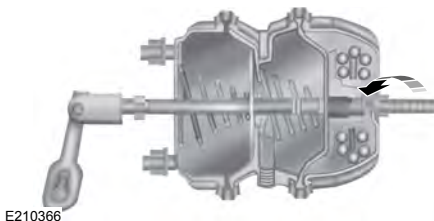

4. Turn the release stud $\frac{1}{4}$ turn to engage the stud tangs with the slot in the pressure plate. Keep the stud engaged and install the nut on the release stud.
5. Tighten the nut until the spring is fully caged and brakes released. Do not loosen or remove the release stud and nut unless you completely assemble and securely clamp the brake chamber.
6. After restoring the air pressure, unscrew and remove the release stud and install in the carrying pocket. Install the access plug.

Brakes

FULL POWER BRAKE

WARNING



If the brake warning lamp in the instrument cluster remains illuminated after engine start up, this indicates a system failure in the Full Power Brake system. Stop the vehicle safely as soon as possible and seek service immediately.

This system incorporates standard braking, an anti-lock braking system (ABS) and optional Power Park Brake into one fully integrated hydraulic brake system. With the Full Power Brake system, braking energy is stored, similar to an air brake system, resulting in faster response times and shorter stopping distances. This is accomplished using motor and pump assemblies that pressurize the system by pumping brake fluid into accumulators. This is similar to the air compressor of an air brake system pressurizing the air tanks. The system includes a master cylinder that provides the normal pedal feel and transfers the pedal force, via brake fluid, to the main components of the system.

Note: *The motor and pumps run momentarily with the ignition switch in the on or run position, or in the off position with the brake pedal pressed.*

Note: *During normal driving, you may hear the pump and motors replenishing the accumulators. This is a normal function of the system.*

AIR BRAKES

WARNINGS



Do not drive or continue to drive if the low air pressure buzzer is sounding or the brake warning light is lit. These warnings indicate that air pressure is not to normal operating level. Continued use of the vehicle could result in loss of braking ability.



Avoid repeated light application of the brake pedal. This depletes air pressure faster and could result in loss of braking capability.



Do not move the vehicle when the air pressure is insufficient because the brake system may be inoperative.

After starting the engine, give the air compressor time to build up the air pressure to 60 psi (414 kPa) before moving your vehicle.



E210336

Periodically check the air pressure gauge while driving. Pressure should range between approximately 100 psi (690 kPa) to 130 psi (896 kPa). The air compressor governor cut-in and cutout pressure settings are set at the factory and are not adjustable.

Brakes



When air pressure is insufficient (below 60 psi (414 kPa)), a warning light illuminates and a buzzer sounds when the ignition is in the on position. This may happen because excessive brake applications are depleting the system air pressure. If this condition occurs, stop driving your vehicle until the compressor has fully recharged the air system.

Select a gear ratio to help slow your vehicle before descending grades. Supplementing with brakes, as required, help to safely slow the vehicle and avoids overspeeding the engine.

Air Chamber Stroke Indication

Air chamber push rods have orange stroke indicator markers that warn when the braking system requires adjustment or repair. The painted orange indicator is on the air chamber push rod at the slack adjuster stroke dimension that requires service when visible during brake application.

A qualified service technician should perform air brake inspection and adjustment or repairs keeping to the instructions in the service manual.

Cam Brakes - Automatic Slack Adjusters

WARNING



Do not manually adjust the automatic slack adjusters to correct excessive push rod stroke as it may result in reduced brake effectiveness and a vehicle crash. Excessive push rod stroke indicates that a problem exists with the automatic adjuster, with the installation of the adjuster, or with foundation brake components that manual adjustment does not remedy. Seek service from a qualified facility for excessive push rod stroke.



E210337

Standard air brakes (cam) are equipped with automatic brake adjusters. Automatic adjustment occurs during brake applications. Inspect brakes for proper adjustment at the specified intervals. See **Scheduled Maintenance** (page 316).

Emergency Air Brake

WARNING



Do not continue to operate the vehicle with a failure of one of the brake systems. Take the vehicle to your dealer for service immediately.

All vehicles are equipped with a dual brake system. In the unlikely event of a failure of one system, the second system functions for emergency stopping. The brake pedal controls all these systems in the same manner as for normal stops.

EXHAUST BRAKE

WARNING



The exhaust brake is not recommended for use on slippery or low traction road surfaces. Under these conditions a loss of vehicle control could occur.

Brakes

Note: *Installing an exhaust or auxiliary brake does not necessarily protect the engine from exceeding maximum governed speed. Use the primary brakes to make sure the engine never exceeds maximum governed speed under any circumstance.*

Note: *Before starting the engine, make sure that the exhaust brake switch is in the off position. Do not turn the exhaust brake on until the engine has reached normal operating temperature.*

Note: *Maximum exhaust brake performance relates to the type of transmission your vehicle has.*

Note: *Engine speed has a major influence of retarding performance. When engine speed stays at the maximum allowable level, the exhaust brake operates at peak performance.*

Note: *Exhaust brakes operate effectively with automatic transmissions, but performance varies with engine speed and the gear selected by the transmission.*

An exhaust brake is an auxiliary braking system that assists, but does not replace, the primary service brake system. It helps control vehicle speed; it is not a vehicle-stopping device.



E215226

A switch on the instrument panel, in combination with the accelerator and clutch pedal, allow the operator to make maximum use of the exhaust brake in the following conditions:

- Off-highway driving.
- Mountain driving.
- Heavy traffic.
- High-speed highway driving.

To switch the brake on, push the switch up. Push the switch down to turn it off.

While approaching a steep grade, make sure that the exhaust brake switch is in the on position. The exhaust brake begins working as soon as you remove your foot from the accelerator pedal.

Before descending a hill or steep grade, always select the proper gear. If you take the transmission out of gear while descending, it is possible that you cannot select another gear because of maximum governed RPM.

Brakes

Make sure the engine speed does not exceed the maximum allowable engine RPM. Exceeding the maximum allowable engine RPM can result in damage to the engine. Apply the service brakes to reduce the engine RPM or make a slower descent by using a lower gear.

While going down the grade, use a low enough gear to descend safely with a minimum application of the service brakes. As a general guideline, use the same gear as you use to ascend the hill.

Exhaust Brake Operating Characteristics

The exhaust brake turns on when you remove your feet from both the accelerator and clutch pedals and the exhaust brake switch is in the on position. The following conditions exist if the brake is operating properly:

- A slight change in engine sound when the exhaust brake turns on.
- A smooth braking effect. Do not expect a retarding effect similar to sudden, hard application of the service brakes.
- The retarding force possibly felt acting against your body during brake application (depending on the grade and vehicle load). This force is actually preventing the vehicle from going much faster.
- Engine temperature remaining in the normal operating range.
- The tachometer showing a drop in engine RPM (depending on grade and vehicle load) during a descent.
- A decrease in road speed when applying the exhaust brake during a descent, except when your vehicle is carrying a heavy load or the grade is extremely steep. In these instances, you may need to apply the service brakes occasionally.

TRAILER BRAKES

Trailer Brake Hand Control (If Equipped)

WARNING



The hand control should never be used to apply the brakes when the tractor and trailer are parked unattended. Air may leak from the system and the vehicle could possibly move, resulting in possible property damage, personal injury or death.



E210339

The hand control is located on the right-hand side of the instrument panel. It applies the trailer service brakes, which are independent of the truck or tractor service brakes.

It operates a valve that provides gradual control of air pressure applied. When the valve is only partially applied, you can override the trailer brakes by pressing fully on the brake pedal.

To apply the trailer brakes using the hand control, move the lever downward. The further you push the lever down, the greater the air pressure is applied to the brakes. The lever remains in place until manually moved.

To release the trailer brakes, move the lever up completely.

Brakes

Trailer Air Supply and Parking Brake Modular Controls (If Equipped)



E210340

The trailer air supply valve delivers air to the trailer supply and automatically pops out, shutting off the trailer supply, if pressure decreases to approximately 35 psi (249 kPa).

Initial Charge

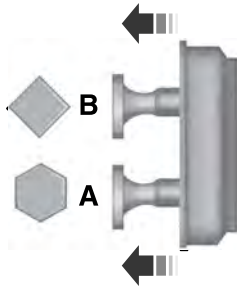

E210342

With the air system completely discharged, both knobs (A and B) are out. When the air pressure reaches 70 psi (481 kPa), the trailer air supply (A - red knob) may be pushed in and should stay in, charging the trailer air system and releasing the trailer brakes.

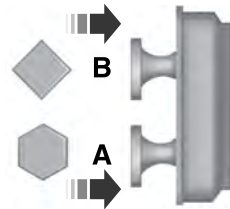
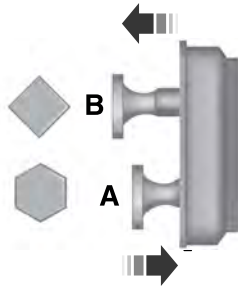

E210343

You can push in the parking brake (B - yellow knob) and supply air to the tractor spring brakes, releasing them.

Brakes

Normal Driving Position

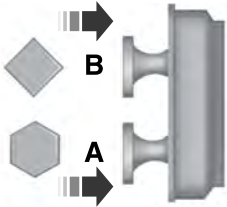

E210343

Push in both knobs (A and B) to supply air to both trailer and tractor spring brakes, releasing all brakes.

System Park

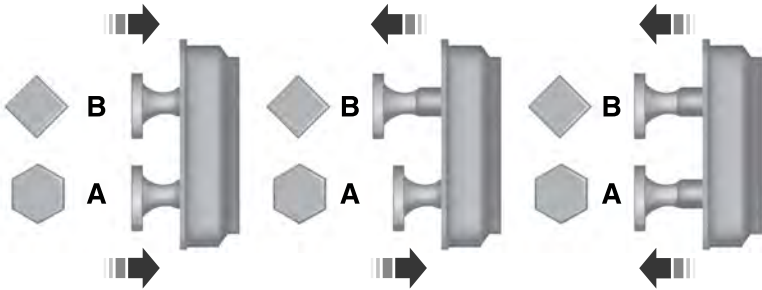

E210344

With both knobs (A and B) pushed in (normal driving position), the parking brakes for both the tractor and trailer can be applied by pulling the parking brake knob (B) out, exhausting air from the tractor spring brakes, simultaneously causing the trailer air supply valve to pop out, applying the trailer brakes.

Brakes

Trailer Charge

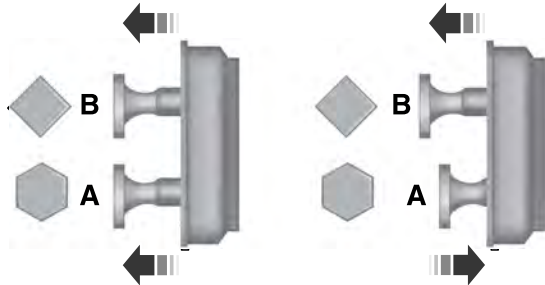

E210342

If both knobs (A and B) are out, and you want to recharge the trailer while leaving the tractor spring brakes applied, the trailer air supply (A) can be pushed in to recharge the trailer air supply line. You can also use this mode to park a combination vehicle with tractor spring brakes.

Automatic Application

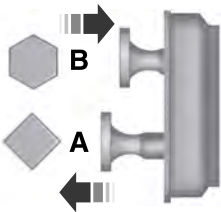

E210345

If both knobs (A and B) are pushed in and the brake system air pressure is reduced to approximately 35 psi (249 kPa), the trailer air supply (A) knob automatically pops out applying the emergency or parking brakes on the trailer. If the trailer air supply (A) knob is manually held in and the air pressure is reduced to approximately 30 psi (207 kPa), a tripper

piston within the valve moves, exhausting the trailer air supply, applying the trailer brakes. Further reduction of air pressure, while holding the trailer air supply knob in, causes the parking brake knob to pop out at 25 psi (172 kPa).

Actuation of Trailer Park (Emergency) or Tractor Bobtail Position

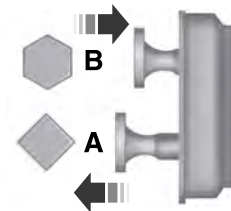

E210345

To actuate the trailer brakes only, pull out the trailer air supply (A) knob. This applies the trailer brakes whether the trailer uses emergency or spring brakes.

You can also use this mode when the tractor or truck with trailer is used during bobtail operation.

Traction Control

PRINCIPLE OF OPERATION

The traction control system helps avoid drive wheel spin and loss of traction.

If your vehicle begins to slide, the system applies the brakes to individual wheels and, when needed, reduces engine power at the same time. If the wheels spin when accelerating on slippery or loose surfaces, the system reduces engine power in order to increase traction.

Note: *The system does not apply the brakes when vehicle speed is above 25 mph (40 km/h).*

USING TRACTION CONTROL - VEHICLES WITH: AIR BRAKES

WARNING



Aggressive driving in any road conditions can cause you to lose control of your vehicle increasing the risk of severe personal injury or property damage. The occurrence of a traction control event is an indication that at least some of the tires have exceeded their ability to grip the road; this may lead to an increased risk of loss of vehicle control, vehicle rollover, personal injury and death. If you experience a severe road event, SLOW DOWN.

Use the traction control switch on the instrument panel to select Off Road or Mud/Snow traction mode.

This is beneficial when your vehicle is stuck in snow or on a slippery road surface. This mode allows excess wheel spin to dig your vehicle out and allows you to rock your vehicle.

Press the switch again to select standard traction control. The system automatically selects standard traction control at the next ignition cycle.

System Indicator Light

Note: *If the traction control light does not flash during a traction control event or stays illuminated, the system is not functioning properly. Take your vehicle to an authorized dealer for service.*

During traction control operation, the traction control light flashes rapidly and the engine does not rev-up when you press further on the accelerator. This is normal and is no reason for concern.

In Off Road or Mud/Snow mode, the traction control light illuminates and flashes slowly. If a traction event occurs in either mode, the light flashes rapidly.

USING TRACTION CONTROL - VEHICLES WITH: HYDRAULIC BRAKES

WARNING



Aggressive driving in any road conditions can cause you to lose control of your vehicle increasing the risk of severe personal injury or property damage. The occurrence of a traction control event is an indication that at least some of the tires have exceeded their ability to grip the road; this may lead to an increased risk of loss of vehicle control, vehicle rollover, personal injury and death. If you experience a severe road event, SLOW DOWN.

The system automatically turns on each time you switch the ignition on.

Use the traction control switch on the instrument panel to switch the system off or on.

If your vehicle is stuck in mud or snow, switching traction control off may be beneficial as this allows the wheels to spin.

Traction Control

Press the switch again to enable the traction control system.

System Indicator Light

Note: *If the traction control light does not flash during a traction control event or stays illuminated, the system is not functioning properly. Take your vehicle to an authorized dealer for service.*

During traction control operation, the traction control light flashes rapidly and the engine does not rev-up when you press further on the accelerator. This is normal and is no reason for concern.

When traction control is disabled, the traction control light illuminates and flashes slowly.

Cruise Control (If Equipped)

PRINCIPLE OF OPERATION

Cruise control lets you maintain a set speed without keeping your foot on the accelerator pedal. You can use cruise control when your vehicle speed is greater than 20 mph (30 km/h).

USING CRUISE CONTROL

WARNINGS



Do not use cruise control on winding roads, in heavy traffic or when the road surface is slippery. This could result in loss of vehicle control, serious injury or death.



When you are going downhill, your vehicle speed may increase above the set speed. The system will not apply the brakes but a warning displays. Failure to follow this warning could result in serious personal injury or death.

Note: Cruise control will disengage if the vehicle speed decreases more than 10 mph (16 km/h) below the set speed while driving uphill.



E210985

The cruise controls are on the steering wheel.

Switching Cruise Control On

Press and release **ON**.



The indicator displays in the instrument cluster.

Setting the Cruise Speed

1. Drive to desired speed.
2. Press and release **SET+** or **SET-**.
3. Take your foot off the accelerator pedal.

Cruise Control (If Equipped)

Changing the Set Speed

- Press and release **SET+** or **SET-**. When You select km/h as the display measurement in the information display, the set speed changes in approximately 2 km/h increments. When you select mph as the display measurement in the information display, the set speed changes in approximately 1 mph increments.
- Press the accelerator or brake pedal until you reach the desired speed. Press and release **SET+** or **SET-**.
- Press and hold **SET+** or **SET-**. Release the control when you reach the desired speed.

Canceling the Set Speed

Press and release **CNCL** or tap the brake pedal. The set speed does not erase.

Resuming the Set Speed

Press and release **RSM**.

Switching Cruise Control Off

Press and release **OFF** when the system is in stand by mode or switch the ignition off.

Note: *You erase the set speed when you switch the system off.*

Driving Aids

STEERING

To help prevent damage to the power steering system:

- Never hold the steering wheel at its furthest turning points (until it stops) for more than three to five seconds when the engine is running.
- Do not operate the vehicle with a low power steering pump fluid level (below the MIN mark on the reservoir).
- Some noise is normal during operation. If excessive, check for low power steering pump fluid level before seeking service by your dealer.
- Heavy or uneven efforts may be caused by low power steering fluid. Check for low power steering pump fluid level before seeking service by your dealer.
- Do not fill the power steering pump reservoir above the MAX mark on the reservoir, as this may result in leaks from the reservoir.

If the power steering system breaks down (or if the engine is turned off), you can steer the vehicle manually, but it takes more effort.

Operating the steering system excessively at an elevated engine RPM (>1200 rpm) for more than 2 minutes can result in steering system damage from overheating. Move the steering wheel to the full left position then full right position at idle speed, or stop using the system for 2 minutes to allow the system to cool down.

If the power steering system exhibits heavy or uneven efforts, check for the following before seeking service from your dealer:

- An improperly inflated tire.
- Overloading of front suspension.
- Uneven vehicle loading.
- Binding suspension components.

If the power steering system wanders or pulls, check for:

- An improperly inflated tire.
- Uneven vehicle loading.
- Uneven tire wear.
- Loose or worn suspension components.
- Loose or worn steering components.
- Improper vehicle alignment.
- High crosswinds.

If any steering components are serviced or replaced, install new fasteners (many are coated with thread adhesive or have prevailing torque features which may not be re-used). Never re-use a bolt or nut. Torque fasteners to specifications.

A high crown in the road or high crosswinds may also make the steering seem to wander or pull.

Load Carrying

LOAD LIMIT

WARNINGS

 Do not exceed the GVWR or the GAWR specified on the Safety Compliance Certification Label.

 Do not use replacement tires with lower load carrying capacities than the original tires because they may lower the vehicle's GVWR and GAWR limitations. Replacement tires with a higher limit than the originals do not increase the GVWR and GAWR limitations.

 Exceeding any vehicle weight rating limitation could result in serious damage to the vehicle and/or personal injury.

Every vehicle manufactured by Ford Motor Company is supplied with information on the Safety Compliance Certification Label, located on either the B-pillar or the driver's door edge, listing the maximum loading for the vehicle (GVWR), and its axle systems (GAWR) at the tire to ground interface.

Example only:

INCOMPLETE VEHICLE MANUFACTURED BY
FORD MOTOR COMPANY

DATE: XX/XX GVWR: XXXX KG (XXXX LB)
FRONT GAWR: REAR GAWR:

A SUITABLE TIRE-RIM CHOICE

XXXX KG (XXXX LB)	WITH XXXX KG (XXXX LB)	WITH
XXXXXXXXXXXXXXXXXX	TIRES XXXXXXXXXXXXXXXXX	TIRES
XXXXXX	RIMS XXXXXXXX	RIMS
AT XXXX kPa/ XXX PSI COLD	AT XXXX kPa/ XXX PSI COLD	
VIN: XXXXXXXXXXXXXXXXX		



EXT PNT:	XX	XXXXXX	RC: XX	DSO: XXXX
WB	INT TR	TP/PS	R	AXLE
XX	XX	XXX	X	XX
		XXXXXXXXXXXX	XXX	XXXX-XXXXXX-XX

E210937

Under no circumstances should your vehicle be loaded in excess of the GVWR or GAWR. It is the operator's responsibility to ensure that neither the axle capacities, spring capacities, tire capacities nor the vehicle rated GVWR is exceeded.

Unloaded or Lightly Loaded Vehicles

WARNING

 When operating empty or lightly loaded, sudden or hard braking may induce wheel lockup with loss of vehicle control and the possibility of accident and serious injury, especially on wet or slippery road surfaces.

The braking system has been designed to safely stop your vehicle when fully loaded to its GVWR.

Load Carrying

AIR SUSPENSION (If Equipped)

Note: Do not operate your vehicle without air in the suspension springs. Operating your vehicle without air in the suspension springs damages the suspension, degrades ride performance and may cause property damage.

The air suspension system automatically adjusts to different loads to maintain a constant frame height, allows for ease of vehicle loading, provides improved vehicle ride, and increased driver comfort.

Air Suspension Dump Button

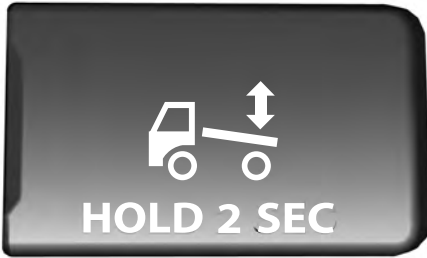

E213409

Note: The suspension dumps air when the ignition is in the accessory or on position, but fills only when the ignition is in the on position.

A button located on the instrument panel controls the system. It operates only when the ignition is in the accessory or on position and the air tanks have sufficient pressure to fill the air springs. When you turn off the ignition, the suspension remains in whatever state it was last set.

Pressing and holding the button for two seconds exhausts air from the air springs, lowering the frame for loading. Pressing and holding the button for two seconds fills the air springs so your vehicle remains at normal ride height.

System Indicator Light

The air suspension indicator light illuminates when using the button to release air pressure in the rear air springs. Never drive your vehicle when the warning lamp is illuminated and there is low (or no) air pressure in the springs.

Connecting and Disconnecting a Trailer with Air Suspension and Air Suspension Dump Button

When connecting to a trailer:

- Press and hold the button for two seconds to exhaust air from the air suspension system.
- Press and hold the button for two seconds, and then raise the landing gear after making the connection to the trailer.

When disconnecting the trailer:

- Lower the landing gear, and then press and hold the button for two seconds.
- Disconnect the brake hoses, trailer-side and rear light connectors, then pull the release lever on the fifth wheel.

You must fill the air springs before operating with a trailer or operating in the bobtail mode.

Suspension Conversions

WARNING



When operating a loaded vehicle, the driver must keep all adjustable axles on the ground at all times, supporting their share of the vehicle's load. Failure to do so can overload other axles, tires, wheels, springs, steering components, brakes and frames, resulting in early component failure, loss of vehicle control, possible property damage and personal injury.

Load Carrying

We do not recommend performing, or approve of, suspension conversions. However, we understand that, on occasion, others install aftermarket add-on suspensions on the truck chassis that allow operator control for weight transfer from other axles (such as air lift axles).

Towing

TOWING A TRAILER

WARNINGS

 Do not exceed the GVWR or the GAWR specified on the certification label.

 Towing trailers beyond the maximum recommended gross trailer weight exceeds the limit of the vehicle and could result in engine damage, transmission damage, structural damage, loss of vehicle control, vehicle rollover and personal injury.

Your vehicle may have electrical items, such as fuses or relays, related to towing. See **Fuses** (page 161).

Your vehicle's load capacity designation is by weight, not by volume, so you cannot necessarily use all available space when loading a vehicle.

Towing a trailer places an extra load on your vehicle's engine, transmission, axle, brakes, tires and suspension. Inspect these components periodically during, and after, any towing operation.

Load Placement

To help minimize how trailer movement affects your vehicle when driving:

- Load the heaviest items closest to the trailer floor.
- Load the heaviest items centered between the left and right side trailer tires.
- Load the heaviest items above the trailer axles or just slightly forward toward the trailer tongue. Do not allow the final trailer tongue weight to go above or below 10-15% of the loaded trailer weight.

When driving with a trailer or payload, a slight takeoff vibration or shudder may be present due to the increased payload weight. Additional information regarding proper trailer loading and setting your vehicle up for towing is located in another chapter of this manual. See **Load Limit** (page 135).

You can also find information in the **RV & Trailer Towing Guide** available at your authorized dealer, or online.

RV & Trailer Towing Guide Online

Website	http://www.fleet.ford.com/towing-guides/
---------	---

Towing

RECOMMENDED TOWING WEIGHTS

Vehicles with gasoline engine		
Model	Maximum GVWR lb (kg)	Maximum GCWR
F-650 Pro-Loader (Kick-Up Frame)	20500–26000 (9299–11792)	*
F-650 Pro-Loader (Straight Frame)/F- 650 Straight Frame	25600–29000 (11612–13154)	*

*Specific GCWR and maximum trailer weight applicable your vehicle is dependent on many variables including transmission capability. Check with your sales consultant for the exact rating on your vehicle.

Vehicles with diesel engine		
Model	Maximum GVWR lb (kg)	Maximum GCWR
F-650 Pro-Loader (Kick-Up Frame)	20500–26000 (9299–11792)	*
F-650 Pro-Loader (Straight Frame)/F- 650 Straight Frame	25600–29000 (11612–13154)	*
F-750	25999–37000 (11793–16783)	*

*Specific GCWR and maximum trailer weight applicable your vehicle is dependent on many variables including transmission capability. Check with your sales consultant for the exact rating on your vehicle.

Towing

ESSENTIAL TOWING CHECKS

See **Load limits** in the Load Carrying chapter for load specification terms found on the tire label and Safety Compliance label and instructions on calculating your vehicle's load.

Remember to account for the trailer tongue weight as part of your vehicle load when calculating the total vehicle weight.

Hitches

Do not use a hitch that either clamps onto the bumper or attaches to the axle. You must distribute the load in your trailer so that 10-15% of the total weight of the trailer is on the tongue.

Safety Chains

Note: *Do not attach safety chains to the bumper.*

Always connect the safety chains to the frame or hook retainers of your vehicle hitch.

To connect the safety chains, cross the chains under the trailer tongue and allow enough slack for turning tight corners. Do not allow the chains to drag on the ground.

Trailer Brakes

WARNING



Do not connect a trailer's hydraulic brake system directly to your vehicle's brake system. Your vehicle may not have enough braking power and your chances of having a collision greatly increase.

Electric brakes and manual, automatic or surge-type trailer brakes are safe if you install them properly and adjust them to the manufacturer's specifications. The trailer brakes must meet local and federal regulations.

The rating for the tow vehicle's braking system operation is at the gross vehicle weight rating, not the gross combined weight rating.

Trailer Lamps

WARNING



Never connect any trailer lamp wiring to the vehicle's tail lamp wiring; this may damage the electrical system resulting in fire. Contact your authorized dealer as soon as possible for assistance in proper trailer tow wiring installation. Additional electrical equipment may be required.

Trailer lamps are required on most towed vehicles. Make sure all running lights, brake lights, turn signals and hazard lights are working.

Before Towing a Trailer

Practice turning, stopping and backing up to get the feel of your vehicle-trailer combination before starting on a trip. When turning, make wider turns so the trailer wheels clear curbs and other obstacles.

When Towing a Trailer

- Check your hitch, electrical connections and trailer wheel lug nuts thoroughly after you have traveled 50 miles (80 kilometers).
- When stopped in congested or heavy traffic during hot weather, place the gearshift in position **P** or position **N** to aid engine and transmission cooling and to help air conditioning performance.
- Turn off the speed control with heavy loads or in hilly terrain. The speed control may turn off automatically when you are towing on long, steep grades.

Towing

- Shift to a lower gear when driving down a long or steep hill. Do not apply the brakes continuously, as they may overheat and become less effective.
- If your transmission is equipped with the Tow/Haul feature, use this feature when towing. This provides engine braking and helps eliminate excessive transmission shifting for optimum fuel economy and transmission cooling.
- Allow more distance for stopping with a trailer attached. Anticipate stops and brake gradually.

FIFTH WHEEL OPERATION

WARNINGS



Failure to follow the fifth wheel manufacturer's instructions for hooking and unhooking as well as sliding the fifth wheel could result in an accident, personal injury or death.



When the tractor and trailer are parked unattended, the trailer brake hand control should never be used to apply the brake, since air may leak from the system, allowing vehicle movement, resulting in possible property damage, personal injury or death.

Before hook-up, make sure:

- The fifth wheel jaws are fully open.
- The fifth wheel is fully tilted back to prevent body damage when the tractor is backed under a trailer.
- You block the trailer wheels and adjust and apply the trailer spring brakes. Never chase a trailer.
- The brake hoses and light cords are clear of the fifth wheel.

Hook-up

1. Back the tractor squarely under the trailer, engaging the fifth-wheel jaws on the kingpin. Always back up slowly; make sure the trailer is neither too high nor too low. Avoid backing under the trailer from an angle.
2. Connect the service and emergency brake hoses and trailer light connector.
3. Inspect the jaws of the fifth wheel to be sure they have fully closed on the trailer kingpin and the trailer plate is resting securely on the fifth wheel.
4. Make sure the coupler release lever is in the locked position.
5. Charge the trailer brake system. Set the trailer brakes, with either the hand valve or tractor protection valve. Pull against the trailer for an extra check of proper hook-up. Do not pull hard enough to damage or strain the equipment.
6. Set the tractor parking brakes and fully raise the trailer landing gear.
7. Check the operation of all trailer lights and correct any lights that may be faulty.

Un-hook

1. Try to keep the tractor and trailer in a straight line.
2. Apply the parking brakes.
3. Lower the trailer landing gear, making sure it is on solid, level ground. The weight of the trailer is to be on the landing gear.
4. Block the trailer wheels.
5. Disconnect the brake hoses and light cords. Be sure hoses and cords are clear.
6. Pull coupler release lever to disengage the fifth wheel jaws.

Towing

7. Release the tractor parking brakes.
8. Pull out from the trailer slowly, allowing the landing gear to take the load gradually.

Driving Hints

BREAKING-IN

You need to break in new tires for approximately 300 mi (480 km). During this time, your vehicle may exhibit some unusual driving characteristics.

Avoid driving too fast during the first 1,000 mi (1,600 km). Vary your speed frequently and change up through the gears early. Do not labor the engine.

Drive your new vehicle at least 500 mi (800 km) before towing a trailer. Make sure you use the specified engine oil. See **Capacities and Specifications** (page 258).

Do not add friction modifier compounds or special break-in oils during the first few thousand miles (kilometers) of operation. These additives may prevent piston ring seating.

GENERAL DRIVING POINTS

General Information

- Accelerate smoothly and evenly. Rapid acceleration increases fuel consumption without increasing engine performance.
- When approaching a hill, press the accelerator smoothly to start the incline at full power, and then shift down as needed to maintain vehicle speed.
- When going down a hill, or long steep grades, prevent overspeeding of the engine. Normally, choose the same gear to descend the hill that you use to ascend the hill. The engine governor has no control over engine speed when it is being pushed by a loaded vehicle.

- Do not operate in a gear that permits an engine speed more than the maximum governed speed or high-idle RPM (no load).
- Always shift to a lower gear at high altitudes to prevent engine smoking.

Backing Up

WARNINGS



All vehicles have blind spots. To reduce the risk of severe injury or property damage, never move your vehicle to the side or rear or change lanes without being sure your way is clear on both sides and to your rear.



To reduce the risk of the possibility of personal injury while backing up the vehicle, always be sure your vehicle's path is clear.

Before backing up your vehicle, be sure you can do so safely. If anything behind the cab limits your view, do not rely on mirrors alone to make sure that your intended path is clear. If other people are in the vicinity, have someone standing well behind your vehicle and outside of your intended path (visible through an exterior mirror) guide you as you back up.

Although OSHA or some governmental regulations may require the use of an electrical or mechanical back up alarm to warn bystanders, such an alarm does not guarantee that the intended path is clear. When in doubt, get out of your vehicle and visually check the intended path is clear. Back up slowly as to allow others time to move, if necessary.

If you install an electrical back up alarm, connect it to the backup lamp circuit.

Driving Hints

Parking

WARNING



When parking your vehicle, do not leave the transmission in gear; if the key is in the on position and the vehicle rolls, the engine could start. Failure to follow these instructions could result in an unattended vehicle moving, possibly causing personal injury or property damage.

Always use the parking brake. When parking on a grade, block the wheels and turn the front wheels to one side so that if your vehicle rolls, the front tires act against the curb to stop your vehicle. The front wheels are more effective at stopping a rolling vehicle than the rear wheels.

ECONOMICAL DRIVING

Your fuel economy is affected by several things, such as how you drive, the conditions you drive under, and how you maintain your vehicle.

You may improve your fuel economy by keeping these things in mind:

- Accelerate and slow down in a smooth, moderate fashion.
- Drive at steady speeds without stopping.
- Anticipate stops; slowing down may eliminate the need to stop.
- Close the windows for high-speed driving.
- Drive at reasonable speeds (traveling at 55 mph [88 km/h] uses 15% less fuel than traveling at 65 mph [105 km/h]).
- Keep the tires properly inflated and use only the recommended size.

- Use the recommended engine oil.
- Perform all regularly scheduled maintenance.

Avoid these actions; they reduce your fuel economy:

- Sudden accelerations or hard accelerations.
- Warm up your vehicle on cold mornings.
- Use the air conditioner or front defroster.
- Use the speed control in hilly terrain.
- Rest your foot on the brake pedal while driving.
- Carry unnecessary weight (approximately 1 mpg [0.4 km/L] is lost for every 400 lb [180 kilogram] of weight carried).
- Driving with the wheels out of alignment.

Conditions

- Adding certain accessories to your vehicle (for example bug deflectors, rollbars, light bars, running boards, ski racks or luggage racks) may reduce fuel economy.
- Using fuel blended with alcohol may lower fuel economy.
- Fuel economy may decrease with lower temperatures during the first 8–10 miles (12–16 kilometers) of driving.
- Driving on flat terrain offers improved fuel economy as compared to driving on hilly terrain.
- Transmissions give their best fuel economy when operated in the top cruise gear and with steady pressure on the gas pedal.

Driving Hints

COLD WEATHER PRECAUTIONS

Note: *Idling in cold weather does not heat the engine to its normal operating temperature. Long periods of idling, especially in cold weather, can cause a buildup of deposits which can cause engine damage.*

Changing to a lighter grade engine oil also makes starting easier under these conditions. Refer to Engine oil specifications. See **Capacities and Specifications** (page 258).

Diesel fuel is adjusted seasonally for cold temperatures. Diesel fuel which has not been properly formulated for the ambient conditions may gel which can clog the fuel filters. One indication that the fuel filter(s) may be clogged is if the engine starts, stalls after a short time, and then does not restart. If you have been using biodiesel, you may need to use a fuel with lower biodiesel content, try another brand, or discontinue using biodiesel. Do not use alcohol based additives to correct fuel gelling. This may result in damage to the fuel injectors and system. Use the proper anti-gel and performance improvement product. See **Capacities and Specifications** (page 258).

Your vehicle is equipped with a fuel and water separator that recirculates fuel from the engine to help prevent fuel filter clogging. To avoid engine fuel starvation during cold weather operation of 32°F (0°C) or below, we recommended that the fuel level in your tank should not drop below 1/4 full. This helps prevent air from entering the fuel system and stalling the engine.

Your vehicle is equipped with a selective catalyst reduction system that uses Diesel Exhaust Fluid (DEF) to operate properly. You need to replenish your vehicle's DEF at certain intervals. When filling your vehicle's DEF tank in cold weather, you must take special care to prevent damage to the tank. See **Selective Catalytic Reduction System** (page 95).

In cold weather below 32°F (0°C), the engine may slowly increase to a higher idle speed if left idling in park (P) or neutral (N).

If you operate your vehicle in a heavy snowstorm or blowing snow conditions, snow and ice can clog the engine air induction. If this occurs, the engine may experience a significant reduction in power output. At the earliest opportunity, clear all the snow or ice away from inside the air filter assembly. Remove the air cleaner cover and the pleated paper filter, leaving the foam filter in and remove any snow or ice. Make sure you install the foam filter correctly in place. Remove any debris, snow or ice on the foam filter by brushing the surface with soft brush. Once you have cleared all of the debris, reinstall the air filter and assembly.

Do not use water, solvents, or a hard brush for cleaning the foam filter.

WARNING



To reduce the risk of vehicle damage and/or personal burn injuries do not start your engine with the air filter removed and do not remove it while the engine is running.

Driving Hints

In order to operate the engine in temperatures of 32°F (0°C) or lower, read the following instructions:

- Make sure that the batteries are of sufficient size and are fully charged. Check other electrical components to make sure they are in optimum condition
- Use the proper coolant solution at the concentration recommended protecting the engine against damage from freezing
- Try to keep the fuel tank full as much as possible at the end of operation to prevent condensation in the fuel system
- Make sure you use proper cold weather engine oil and that it is at its proper level. Also, if necessary, make sure to follow the engine oil and filter change schedule found under the Special operating conditions section listed in the scheduled maintenance information
- At temperatures of -9°F (-23°C) or below, it is recommended that you use an engine block heater to improve cold engine starting
- If operating in arctic temperatures of -20°F (-29°C) or lower, consult your truck dealer for information about special cold weather equipment and precautions

The following cold weather idling guidelines are recommended:

- You can use Motorcraft® cetane improvers or non-alcohol-based cetane improvers from a reputable manufacturer as needed.
- Maintain the engine cooling system properly.

- Avoid shutting the engine down after an extensive idling period. Drive your vehicle for several miles with the engine at normal operating temperatures under a moderate load.
- Consider using an engine block heater.
- For extended idle times use an approved idle speed increase device.

Winter Operating Tips for Arctic Operation -20°F (-29°C) and Below

The following information is a guideline only and is not to be the only source of possible solutions in resolving extreme cold temperature issues.

Starting Aids

WARNING



Do not use starting fluid, such as ether, in the air intake system (see air filter decal). Such fluid could cause immediate explosive damage to the engine and possible personal injury.

The use of the factory engine block heater assists in engine starting in extreme cold ambient temperatures. See **Engine Block Heater** (page 88).

Idle Control

Your vehicle may have a factory option for a stationary elevated idle control through dash-mounted upfitter switches that allows the operator to elevate the idle rpm for extended idle periods, as well as aftermarket equipment such as PTO operation. You must configure this feature even if ordered from the factory. See your authorized dealer for required upfitting.

Driving Hints

Operation in Snow and Rain

Vehicle operation in heavy snowfall or extreme rain conditions may feed excessive amounts of snow or water into the air intake system. This could plug the air filter with snow and may cause the engine to lose power and possibly shut down.

We recommend the following actions after operating your vehicle up to 199 mi (320 km) in snowfall or extreme rain:

- **Snow:** At the earliest opportunity, open the hood and clear all the snow and ice from the air filter housing inlet (do not remove the foam filter) and reset the air filter restriction gauge.

Note: *Removal of the foam filter degrades your vehicle performance during snow and hot weather conditions.*

- **Extreme rain:** The air filter dries after about 15–30 minutes at highway speeds. At the earliest opportunity, open the hood and reset the air filter restriction gauge.

DRIVING THROUGH WATER

WARNING



Do not drive through flowing or deep water as you may lose control of your vehicle.

Note: *Driving through standing water can cause vehicle damage.*

Note: *Engine damage can occur if water enters the air filter.*

Before driving through standing water, check the depth. Never drive through water that is higher than the bottom of the wheel hubs.

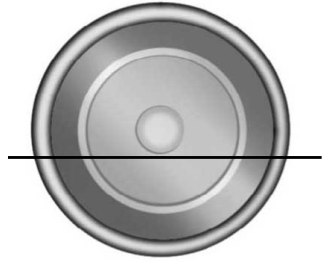

E176913

When driving through standing water, drive very slowly and do not stop your vehicle. Your brake performance and traction may be limited. After driving through water and as soon as it is safe to do so:

- Lightly press the brake pedal to dry the brakes and to check that they work.
- Check that the horn works.
- Check that the exterior lights work.
- Turn the steering wheel to check that the steering power assist works.

Operation in Standing Water

Ingestion of water into the diesel engine can result in immediate and severe damage to the engine. If driving through water, slow down to avoid splashing water into the intake. If the engine stalls, and you suspect ingestion of water into the engine, do not try to restart the engine. Consult your dealer for service immediately.

Your fuel tank vents to the atmosphere by valves on top of the tank and through the fuel cap. If water reaches the top of the tank, the valves may pull water into the fuel tank. Water in the fuel can cause performance issues and damage the fuel injection system.

Roadside Emergencies

ROADSIDE ASSISTANCE

Vehicles Sold in the United States: Getting Roadside Assistance

To fully assist you should you have a vehicle concern, Ford Motor Company offers a complimentary roadside assistance program. This program is separate from the New Vehicle Limited Warranty. The service is available:

- 24 hours a day, seven days a week.
- For the coverage period listed on the Roadside Assistance Card included in your Owner's Manual portfolio.

Roadside Assistance covers:

- A flat tire change with a good spare, if provided with the vehicle (except vehicles supplied with a tire inflation kit).
- Battery jump start.
- Lock-out assistance (key replacement cost is the customer's responsibility).
- Fuel delivery — independent service contractors, if not prohibited by state, local or municipal law, shall deliver up to 2 gal (7.6 L) of gasoline or 5 gal (18.9 L) of diesel fuel to a disabled vehicle. Roadside Assistance limits fuel delivery service to two no-charge occurrences within a 12-month period.
- Winch out — available within 100 ft (30.5 m) of a paved or county maintained road, no recoveries.
- Towing — independent service contractors, if not prohibited by state, local or municipal law, shall tow Ford eligible vehicles to an authorized dealer within 35 mi (56 km) of the disablement location or to the nearest

authorized dealer. If a member requests a tow to an authorized dealer that is more than 35 mi (56 km) from the disablement location, the member shall be responsible for any mileage costs in excess of 35 mi (56 km).

Roadside Assistance includes up to \$200 for a towed trailer if the disabled eligible vehicle requires service at the nearest authorized dealer. If the towing vehicle is operational but the trailer is not, then the trailer does not qualify for any roadside services.

Vehicles Sold in the United States: Using Roadside Assistance

Complete the roadside assistance identification card and place it in your wallet for quick reference. This card is in the owner's information portfolio in the glove compartment.

United States Ford vehicle customers who require Roadside Assistance, call 1-800-241-3673.

If you need to arrange roadside assistance for yourself, Ford Motor Company reimburses a reasonable amount for towing to the nearest dealership within 35 mi (56 km). To obtain reimbursement information, United States Ford vehicle customers call 1-800-241-3673. Customers need to submit their original receipts.

Vehicles Sold in Canada: Getting Roadside Assistance

To fully assist you should you have a vehicle concern, Ford Motor Company of Canada, Limited offers a complimentary roadside assistance program. This program is eligible within Canada or the continental United States.

Roadside Emergencies

This program is separate from the New Vehicle Limited Warranty, but the coverage is concurrent with the powertrain coverage period of your vehicle.

Canadian customers who require roadside assistance, call 1-800-665-2006.

Vehicles Sold in Canada: Using Roadside Assistance

Complete the roadside assistance identification card and place it in your wallet for quick reference.

In Canada, this card is found in the Warranty Guide in the glove compartment of your vehicle.

Vehicles Sold in Canada: Roadside Assistance Program Coverage

The service is available 24 hours a day, seven days a week.

Canadian roadside coverage and benefits may differ from the U.S. coverage.

For complete program coverage details you may contact your dealer, you can call us in Canada at 1-800-665-2006, or visit our website at www.ford.ca.

HAZARD WARNING FLASHERS

Note: *The hazard warning flashers will operate when the ignition is in any position or if the key is not in the ignition. If used when the engine is not running, the battery will lose charge. As a result, there may be insufficient power to restart your engine.*



In some models, the hazard flasher control is located on the instrument panel.

In other models, this feature is located on the steering column, just behind the steering wheel.



E161463

Use your hazard warning flashers when your vehicle is creating a safety hazard for other motorists.

- Press the flasher control and all front and rear direction indicators flash.
- Press the flasher control again to turn them off.

FUEL SHUTOFF

WARNING



Failure to inspect and, if necessary, repair fuel leaks after a collision may increase the risk of fire and serious injury. Ford Motor Company recommends that the fuel system be inspected by an authorized dealer after any collision.

Note: *When you try to restart your vehicle after a fuel shutoff, your vehicle makes sure that various systems are safe to restart. Once your vehicle determines that the systems are safe, then your vehicle will allow you to restart.*

In the event of a moderate to severe collision, your vehicle is equipped with a fuel pump shut-off feature that stops the flow of fuel to the engine. Not every impact will cause a shutoff.

Roadside Emergencies

After an accident, if the engine cranks but does not start, this switch may have been activated.



E163366

This switch is located on the passenger's side of the instrument panel. Open the front passenger door and remove the small access panel.



E163367

The switch has a red button on top of it.

To reset the switch:

1. Turn the ignition off.
2. Check the fuel system for leaks.
3. If no leaks are apparent, reset the switch by pushing in on the reset button.
4. Turn the ignition on.
5. Wait a few seconds and return the key to off.
6. Make another check for leaks.

Running Out Of DEF (Diesel Exhaust Fluid)

If your vehicle runs out of DEF, it will enter into a speed limited mode and can also enter into an idle-only mode. Normal vehicle operation will not resume until DEF is refilled. See **Selective Catalytic Reduction System** (page 95).

Contact roadside assistance for help in finding a retailer that sells DEF. See **Customer Assistance** (page 155).

JUMP STARTING THE VEHICLE

WARNINGS

 Batteries normally produce explosive gases which can cause personal injury. Therefore, do not allow flames, sparks or lighted substances to come near the battery. When working near the battery, always shield your face and protect your eyes. Always provide correct ventilation.

 Keep batteries out of reach of children. Batteries contain sulfuric acid. Avoid contact with skin, eyes or clothing. Shield your eyes when working near the battery to protect against possible splashing of acid solution. In case of acid contact with skin or eyes, flush immediately with water for a minimum of 15 minutes and get prompt medical attention. If acid is swallowed, call a physician immediately.

 Use only adequately sized cables with insulated clamps.

Preparing Your Vehicle

Do not attempt to push-start your automatic transmission vehicle.

Note: *Attempting to push-start a vehicle with an automatic transmission may cause transmission damage.*

Roadside Emergencies

Note: Use only a 12-volt supply to start your vehicle.

Note: Do not disconnect the battery of the disabled vehicle as this could damage the vehicle electrical system.

Park the booster vehicle close to the hood of the disabled vehicle, making sure the two vehicles do not touch.

Connecting the Jumper Cables

WARNINGS



Do not attach the cables to fuel lines, engine rocker covers, the intake manifold or electrical components as grounding points. Stay clear of moving parts. To avoid reverse polarity connections, make sure that you correctly identify the positive (+) and negative (-) terminals on both the disabled and booster vehicles before connecting the cables.



Do not attach the end of the positive cable to the studs or L-shaped eyelet located above the positive (+) terminal of your vehicle's battery. High current may flow through and cause damage to the fuses.



Do not connect the end of the second cable to the negative (-) terminal of the battery to be jumped. A spark may cause an explosion of the gases that surround the battery.

Note: In the illustration, the bottom vehicle represents the booster vehicle.

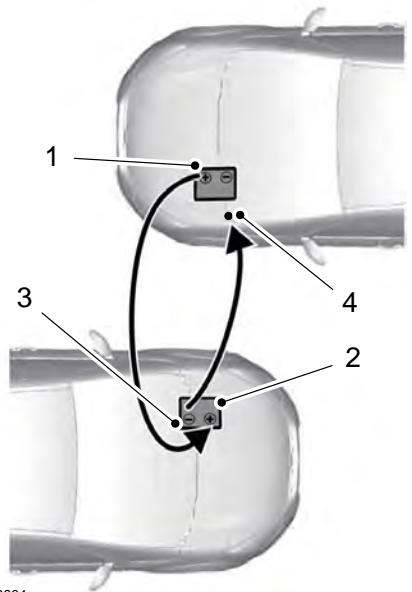

E142664

1. Connect the positive (+) jumper cable to the positive (+) terminal of the discharged battery.
2. Connect the other end of the positive (+) cable to the positive (+) terminal of the booster vehicle battery.
3. Connect the negative (-) cable to the negative (-) terminal of the booster vehicle battery.
4. Make the final connection of the negative (-) cable to an exposed metal part of the stalled vehicle's engine, away from the battery and the fuel injection system, or connect the negative (-) cable to a ground connection point if available.

Roadside Emergencies

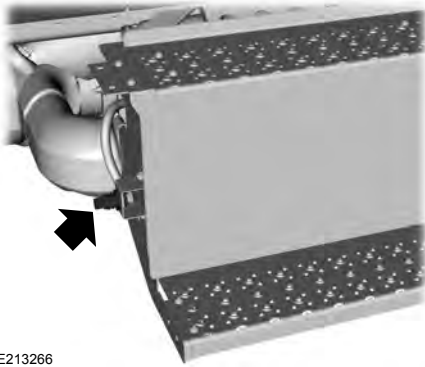

E213266

Note: There is an optional jump start terminal underneath the passenger side entry steps.

Jump Starting

1. Start the engine of the booster vehicle and rev the engine moderately, or press the accelerator gently to keep your engine speed between 2000 and 3000 RPM, as shown in your tachometer.
2. Start the engine of the disabled vehicle.
3. Once the disabled vehicle has been started, run both vehicle engines for an additional three minutes before disconnecting the jumper cables.

Removing the Jumper Cables

Remove the jumper cables in the reverse order that they were connected.

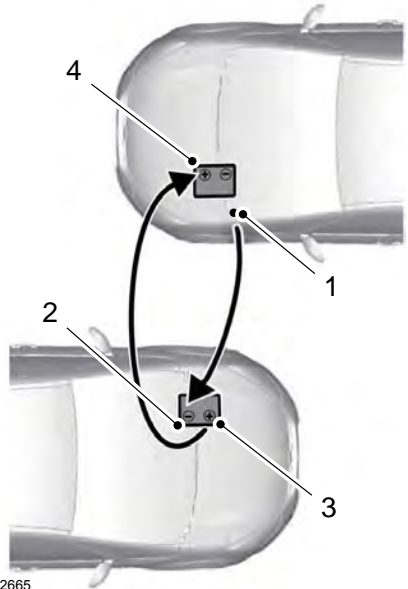

E142665

1. Remove the negative (-) jumper cable from the disabled vehicle.
2. Remove the jumper cable on the negative (-) terminal of the booster vehicle battery.
3. Remove the jumper cable from the positive (+) terminal of the booster vehicle battery.
4. Remove the jumper cable from the positive (+) terminal of the disabled vehicle battery.
5. Allow the engine to idle for at least one minute.

Roadside Emergencies

TRANSPORTING THE VEHICLE

WARNING



To reduce the risk of personal injury or property damage when manually releasing the spring brakes, block the wheels so the vehicle cannot move when you release the brakes.

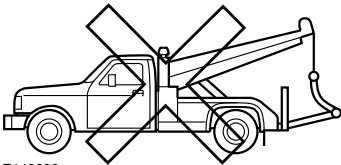
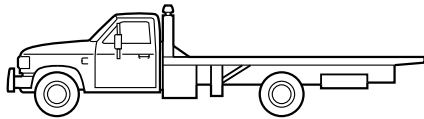
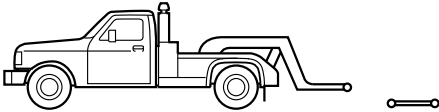

E143886

If you need to have your vehicle towed, contact a professional towing service or, if you are a member of a roadside assistance program, your roadside assistance service provider.

We recommend the use of a wheel lift and dollies or flatbed equipment to tow your vehicle. Do not tow with a slingbelt. Ford Motor Company has not approved a slingbelt towing procedure. Vehicle damage may occur if towed incorrectly, or by any other means.

Ford Motor Company produces a towing manual for all authorized tow truck operators. Have your tow truck operator refer to this manual for proper hook-up and towing procedures for your vehicle.

It is acceptable to have your two-wheel drive vehicle towed with the front wheels on the ground (without dollies) and the rear wheels off the ground.

We recommend towing a four-wheel drive vehicle with all wheels off the ground, such as using a wheel lift and dollies or flatbed equipment. However, it is acceptable to use a wheel lift to raise the rear of your vehicle so long as, depending on vehicle configuration, you perform the following before towing:

- If your vehicle is equipped with a manual-shift transfer case, make sure the front wheel hub locks are in the **FREE** position before towing.
- If your vehicle is equipped with an electronic shift-on-the-fly transfer case, make sure you turn the four-wheel drive control to the **2H** position before towing.

Note: Towing an electronic shift-on-the-fly four-wheel drive vehicle with the front wheels on the ground without disengaging the front hubs may cause damage to the automatic transmission.

Note: Towing a two-wheel drive vehicle or an electronic shift-on-the-fly four-wheel drive vehicle with the rear wheels on the ground for more than 50 miles (80 km) or faster than 35 mph (56 km/h) may cause damage to the automatic transmission.

Roadside Emergencies

Note: *Using wheel lift equipment to tow a dual rear wheel vehicle requires removing an outer rear wheel before towing.*

Customer Assistance

GETTING THE SERVICES YOU NEED

Warranty repairs to your vehicle must be performed by an authorized dealer. While any authorized dealer handling your vehicle line will provide warranty service, we recommend you return to your selling authorized dealer who wants to ensure your continued satisfaction.

Please note that certain warranty repairs require special training and equipment, so not all authorized dealers are authorized to perform all warranty repairs. This means that, depending on the warranty repair needed, you may have to take your vehicle to another authorized dealer.

A reasonable time must be allowed to perform a repair after taking your vehicle to the authorized dealer. Repairs will be made using Ford or Motorcraft® parts, or remanufactured or other parts that are authorized by Ford.

Away From Home

If you are away from home when your vehicle needs service, contact the Commercial Vehicle Center or use the online resources listed below to find the nearest authorized dealer.

In the United States:

Mailing address

Ford Motor Company
Commercial Vehicle Operations
P.O. Box 6248
Dearborn, MI 48121

Telephone

1-800-392-3673 (FORD)
(TDD for the hearing impaired:
1-800-232-5952)

Online

Additional information and resources are available online at www.fordowner.com

These are some of the items that can be found online:

- U.S. dealer locator by Dealer Name, City/State or Zip Code.
- Owner Manuals.
- Maintenance Schedules.
- Recalls.
- Ford Extended Service Plans.
- Ford Genuine Accessories.
- Service specials and promotions.

In Canada:

Mailing address

Customer Relationship Centre
Ford Motor Company of Canada, Limited
P.O. Box 2000
Oakville, Ontario L6K 0C8

Telephone

1-800-565-3673 (FORD)

Online

www.ford.ca

Twitter

@FordServiceCA (English Canada)
@FordServiceQC (Quebec)

Additional Assistance

If you have questions or concerns, or are unsatisfied with the service you are receiving, follow these steps:

1. Contact your Sales Representative or Service Advisor at your selling/servicing authorized dealer.
2. If your inquiry or concern remains unresolved, contact the Sales Manager, Service Manager or Customer Relations Manager.
3. If the inquiry or concern cannot be resolved at the dealership level, contact the Ford Commercial Vehicle Operations Hotline. Please have the following information available:

Customer Assistance

- Vehicle Identification Number.
- Your telephone number (home and business).
- The name of the authorized dealer and city where located.
- The vehicle's current odometer reading.

In some states, you must directly notify Ford in writing before pursuing remedies under your state's warranty laws. Ford is also allowed a final repair attempt in some states.

In the United States, a warranty dispute must be submitted to the BBB AUTO LINE before taking action under the Magnuson-Moss Warranty Act, or to the extent allowed by state law, before pursuing replacement or repurchase remedies provided by certain state laws. This dispute handling procedure is not required prior to enforcing state created rights or other rights which are independent of the Magnuson-Moss Warranty Act or state replacement or repurchase laws.

IN CALIFORNIA (U.S. ONLY)

California Civil Code Section 1793.2(d) requires that, if a manufacturer or its representative is unable to repair a motor vehicle to conform to the vehicle's applicable express warranty after a reasonable number of attempts, the manufacturer shall be required to either replace the vehicle with one substantially identical or repurchase the vehicle and reimburse the buyer in an amount equal to the actual price paid or payable by the consumer (less a reasonable allowance for consumer use). The consumer has the right to choose whether to receive a refund or replacement vehicle.

California Civil Code Section 1793.22(b) presumes that the manufacturer has had a reasonable number of attempts to conform the vehicle to its applicable express warranties if, within the first 18 months of ownership of a new vehicle or the first 18000 miles (29 000 km), whichever occurs first:

1. Two or more repair attempts are made on the same non-conformity likely to cause death or serious bodily injury OR
2. Four or more repair attempts are made on the same nonconformity (a defect or condition that substantially impairs the use, value or safety of the vehicle) OR
3. The vehicle is out of service for repair of nonconformities for a total of more than 30 calendar days (not necessarily all at one time).

In the case of 1 or 2 above, the consumer must also notify the manufacturer of the need for the repair of the nonconformity at the following address:

Ford Motor Company
16800 Executive Plaza Drive
Mail Drop 3NE-B
Dearborn, MI 48126

You are required to submit your warranty dispute to BBB AUTO LINE before asserting in court any rights or remedies conferred by California Civil Code Section 1793.22(b). You are also required to use BBB AUTO LINE before exercising rights or seeking remedies created by the Federal Magnuson-Moss Warranty Act, 15 U.S.C. sec. 2301 et seq. If you choose to seek redress by pursuing rights and remedies not created by California Civil Code Section 1793.22(b) or the Magnuson-Moss Warranty Act, resort to BBB AUTO LINE is not required by those statutes.

Customer Assistance

THE BETTER BUSINESS BUREAU (BBB) AUTO LINE PROGRAM (U.S. ONLY)

Your satisfaction is important to Ford Motor Company and to your dealer. If a warranty concern has not been resolved using the three-step procedure outlined earlier in this chapter in the Getting the Services you need section, you may be eligible to participate in the BBB AUTO LINE program.

The BBB AUTO LINE program consists of two parts – mediation and arbitration. During mediation, a representative of the BBB will contact both you and Ford Motor Company to explore options for settlement of the claim. If an agreement is not reached during mediation or you do not want to participate in mediation, and if your claim is eligible, you may participate in the arbitration process. An arbitration hearing will be scheduled so that you can present your case in an informal setting before an impartial person. The arbitrator will consider the testimony provided and make a decision after the hearing.

Disputes submitted to the BBB AUTO LINE program are usually decided within forty days after you file your claim with the BBB. You are not bound by the decision, and may reject the decision and proceed to court where all findings of the BBB Auto Line dispute, and decision, are admissible in the court action. Should you choose to accept the BBB AUTO LINE decision, Ford is then bound by the decision, and must comply with the decision within 30 days of receipt of your acceptance letter.

BBB AUTO LINE Application: Using the information provided below, please call or write to request a program application. You will be asked for your name and address, general information about your new vehicle, information about your warranty concerns, and any steps you have

already taken to try to resolve them. A Customer Claim Form will be mailed that will need to be completed, signed and returned to the BBB along with proof of ownership. Upon receipt, the BBB will review the claim for eligibility under the Program Summary Guidelines.

You can get more information by calling BBB AUTO LINE at 1-800-955-5100, or writing to:

**BBB AUTO LINE
3033 Wilson Boulevard, Suite 600
Arlington, Virginia 22201**

BBB AUTO LINE applications can also be requested by calling the Ford Motor Company Customer Relationship Center at 1-800-392-3673.

Note: *Ford Motor Company reserves the right to change eligibility limitations, modify procedures, or to discontinue this process at any time without notice and without obligation.*

UTILIZING THE MEDIATION/ARBITRATION PROGRAM (CANADA ONLY)

For vehicles delivered to authorized Canadian dealers. In those cases where you continue to feel that the efforts by Ford of Canada and the authorized dealer to resolve a factory-related vehicle service concern have been unsatisfactory, Ford of Canada participates in an impartial third party mediation/arbitration program administered by the Canadian Motor Vehicle Arbitration Plan (CAMVAP).

The CAMVAP program is a straight forward and relatively speedy alternative to resolve a disagreement when all other efforts to produce a settlement have failed. This procedure is without cost to you and is designed to eliminate the need for lengthy and expensive legal proceedings.

Customer Assistance

In the CAMVAP program, impartial third-party arbitrators conduct hearings at mutually convenient times and places in an informal environment. These impartial arbitrators review the positions of the parties, make decisions and, when appropriate, render awards to resolve disputes. CAMVAP decisions are fast, fair, and final as the arbitrator's award is binding on both you and Ford of Canada.

CAMVAP services are available in all Canadian territories and provinces. For more information, without charge or obligation, call your CAMVAP Provincial Administrator directly at 1-800-207-0685 or visit www.camvap.ca.

GETTING ASSISTANCE OUTSIDE THE U.S. AND CANADA

Before exporting your vehicle to a foreign country, contact the appropriate foreign embassy or consulate. These officials can inform you of local vehicle registration regulations and where to find diesel fuel.

If you cannot find diesel fuel or can only get fuel with an anti-knock index lower than is recommended for your vehicle, contact a regional office or owner relations/customer relationship office.

The use of low quality diesel fuel may affect your emissions control system and may cause engine damage. Ford Motor Company/Ford of Canada is not responsible for any damage caused by use of improper fuel. In the United States, using leaded fuel may also result in difficulty importing your vehicle back into the U.S.

Ford dealerships outside of the U.S. and Canada may be unable to support the F-650/750 due to the specialized training and servicing requirements of these vehicles. If your vehicle must be serviced while you are traveling or living in Central or South America, the Caribbean, or the Middle East, contact the nearest Ford dealership. If the dealership cannot help you, write or call:

FORD MOTOR COMPANY
Customer Relationship Center
1555 Fairlane Drive
Fairlane Business Park #3
Allen Park, Michigan 48101
U.S.A.
Telephone: (313) 594-4857
Fax: (313) 390-0804
Email: expcac@ford.com

For customers in Guam, the Commonwealth of the Northern Mariana Islands (CNMI), America Samoa, and the U.S. Virgin Islands, please feel free to call our Toll-Free Number: (800) 841-FORD (3673).

If your vehicle must be serviced while you are traveling or living in Puerto Rico, contact the nearest authorized dealer. If the authorized dealer cannot help you, contact:

FORD MOTOR COMPANY
Customer Relationship Center
1555 Fairlane Drive
Fairlane Business Park #3
Allen Park, Michigan 48101
U.S.A.
Telephone: (800) 841-FORD (3673)
FAX: (313) 390-0804
Email: prcac@ford.com
www.ford.com.pr

If your vehicle must be serviced while you are traveling or living in the Middle East, contact the nearest authorized dealer. If the authorized dealer cannot help you, contact:

Customer Assistance

FORD MOTOR COMPANY
Customer Relationship Center
1555 Fairlane Drive
Fairlane Business Park #3
Allen Park, Michigan 48101
U.S.A.

Ford: 80004443673
Lincoln: 80004441067
If calling from the UAE: 80004441066
If calling from the Kingdom of Saudi Arabia: 8008443673
If calling from Kuwait: 22280384

FAX: +971 4 3327266
Email: menacac@ford.com
www.me.ford.com

If you buy your vehicle in North America and then relocate to any of the above locations, register your vehicle identification number (VIN) and new address with Ford Motor Company Export Operations & Global Growth Initiatives by emailing expcac@ford.com.

If you are in another foreign country, contact the nearest authorized dealer. In the event your inquiry is unresolved, communicate your concern with the dealership's Sales Manager, Service Manager or Customer Relations Manager. If you require additional assistance or clarification, please contact the respective Customer Relationship Center as previously listed.

**Customers in the U.S. should call
1-800-392-3673.**

ORDERING ADDITIONAL OWNER'S LITERATURE

To order the publications in this portfolio, contact Helm, Incorporated at:

HELM, INCORPORATED
47911 Halyard Drive
Plymouth, Michigan 48170
Attention: Customer Service

Or to order a free publication catalog, call toll free: 1-800-782-4356

Monday-Friday 8:00 a.m. - 6:00 p.m. EST

Helm, Incorporated can also be reached by their website:

www.helminc.com

(Items in this catalog may be purchased by credit card, check or money order.)

Obtaining a French Owner's Manual

French Owner's Manual can be obtained from your authorized dealer or by contacting Helm, Incorporated using the contact information listed previously in this section.

REPORTING SAFETY DEFECTS (U.S. ONLY)



E142557

If you believe that your vehicle has a defect which could cause a crash or could cause injury or death, you should immediately inform the National Highway Traffic Safety Administration (NHTSA) in addition to notifying Ford Motor Company.

Customer Assistance

If NHTSA receives similar complaints, it may open an investigation, and if it finds that a safety defect exists in a group of vehicles, it may order a recall and remedy campaign. However, NHTSA cannot become involved in individual problems between you, your dealer, or Ford Motor Company.

To contact NHTSA, you may call the Vehicle Safety Hotline toll-free at 1-888-327-4236 (TTY: 1-800-424-9153); go to www.safercar.gov; or write to:
Administrator

1200 New Jersey Avenue,
Southeast

Washington, D.C. 20590

You can also obtain other information about motor vehicle safety from www.safercar.gov.

REPORTING SAFETY DEFECTS (CANADA ONLY)

If you believe that your vehicle has a defect which could cause a crash or could cause injury or death, you should immediately inform Transport Canada and Ford of Canada.

Transport Canada Contact Information	
Website	www.tc.gc.ca/eng/motorvehiclesafety/safevehicles-defectinvestigations-index-76.htm (English)
Website	www.tc.gc.ca/fra/secureiteautomobile/VehiculesSecuritaires-Enquetes-index-76.htm (French)
Phone	1-800-333-0510

Ford of Canada Contact Information	
Website	www.ford.ca
Phone	1-800-565-3673

Fuses

FUSE SPECIFICATION CHART

Power Distribution Box

WARNINGS



Always disconnect the battery before servicing high current fuses.



To reduce risk of electrical shock, always replace the cover to the power distribution box before reconnecting the battery or refilling fluid reservoirs.

The power distribution box is located in the engine compartment. It has high-current fuses that protect your vehicle's main electrical systems from overloads.

If you disconnect and reconnect the battery, you will need to reset some features. See **Changing the 12V Battery** (page 203).

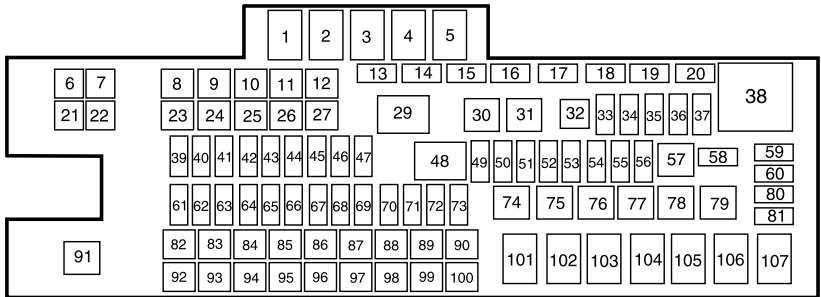

E163101

Fuse or relay number	Fuse amp rating	Protected components
1	Relay	Blower motor.
2	Relay	Trailer tow and body builder stoplamps.
3	Relay	Urea heaters (diesel engine).
4	Relay	Driver air ride seat compressor.
5	Relay	Heated mirrors.
6	—	Not used.
7	—	Not used.
8	20A*	Passenger air ride seat compressor.
9	—	Not used.
10	—	Not used.

Fuses

Fuse or relay number	Fuse amp rating	Protected components
11	—	Not used.
12	—	Not used.
13	Resistor	Terminating resistor (120 ohm).
14	—	Not used.
15	—	Not used.
16	—	Not used.
17	—	Not used.
18	—	Not used.
19	10A**	Brake on/off isolation relay.
20	—	Not used.
21	—	Not used.
22	30A*	Trailer tow electric brake controller.
23	40A*	Blower motor.
24	—	Not used.
25	30A*	Wipers.
26	30A*	Trailer tow park lamps.
27	25A*	Urea heaters (diesel engine).
29	Relay	Trailer tow park lamps.
30	Relay	A/C clutch.
31	Relay	Wipers.
32	—	Not used.
33	20A**	Vehicle power 1.
34	20A**	Vehicle power 2.
35	10A**	Vehicle power 3.
36	20A**	Vehicle power 4.
37	10A**	Vehicle power 5 (diesel engine).
38	Relay	Powertrain control module.

Fuses

Fuse or relay number	Fuse amp rating	Protected components
39	—	Not used.
40	15A**	Heated mirrors.
41	—	Not used
42	20A**	Trailer tow and body builder stoplamps.
43	—	Not used.
44	20A**	Ancillary translator module.
45	10A**	Run/start relay coil.
46	10A**	Transmission control module keep-alive power (diesel engine).
47	10A**	A/C clutch.
48	Relay	Run/start.
49	20A**	Air dryer.
50	10A**	Blower motor relay coil.
51	—	Not used.
52	10A**	Powertrain control module run/start (diesel engine). Transmission control module run/start (diesel engine).
53	—	Not used.
54	10A**	Anti-lock brake system run/start.
55	10A**	Seat compressor relay coil. Chassis solenoids relay coil. Heated mirror relay coil.
56	20A**	Passenger compartment fuse panel run/start feed
57	Relay	Fuel pump.
58	5A**	Wiper relay.
59	5A**	Chassis solenoid relay. Air ride seat compressor relay.
60	—	Not used.

Fuses

Fuse or relay number	Fuse amp rating	Protected components
61	—	Not used.
62	—	Not used.
63	10A**	Chassis solenoids.
64	—	Not used.
65	10A**	Cargo box lamp.
66	30A**	Fuel pump.
67	—	Not used.
68	10A**	Fuel pump relay coil.
69	—	Not used.
70	10A**	Trailer tow or body builder backup lamps.
71	—	Not used.
72	10A**	Powertrain control module relay coil. Keep-alive power.
73	5A**	Hydromax monitor.
74	Relay	Chassis solenoids.
75	—	Not used.
76	—	Not used.
77	Relay	Brake switch isolation (hydraulic brakes).
78	—	Not used.
79	—	Not used.
80	—	Not used.
81	—	Not used.
82	20A*	Auxiliary power point #2.
83	20A*	Auxiliary power point #1.
84	20A*	Driver air ride seat compressor.
85	60A*	Hydromax pump.
86	30A*	Anti-lock brake system modulator valves.

Fuses

Fuse or relay number	Fuse amp rating	Protected components
87	—	Not used.
88	—	Not used.
89	40A*	Starter motor
90	30A*	Trailer battery feed (air brakes). Trailer tow battery charge (hydraulic brakes).
91	Relay	Cargo box lamp.
92	—	Not used.
93	—	Not used.
94	25A*	Upfitter relay #1.
95	25A*	Upfitter relay #2.
96	60A*	Anti-lock brake system pump (hydraulic brakes).
97	—	Not used.
98	—	Not used.
99	40A*	Instrument panel 110v power inverter.
100	30A*	Trailer tow turn lamp relays.
101	Relay	Starter.
102	Relay	Trailer tow battery charge relay (U-Haul). Trailer tow battery feed (air brakes).
103	Relay	Trailer tow right hand side turn and stop lamps.
104	Relay	Trailer tow left hand side turn and stop lamps.
105	—	Not used.
106	Relay	Trailer tow backup lamps relay.
107	Relay	Passenger air ride seat compressor relay.

*J case fuses.

**Mini fuses.

Fuses

Passenger Compartment Fuse Panel

The fuse panel is in the passenger footwell. Remove the panel cover to access the fuses.

Pull the fuse panel cover toward you to remove it. When the clips of the panel disengage, let the panel fall easily.

Use the provided fuse puller tool to remove a fuse. It is on the fuse panel cover.

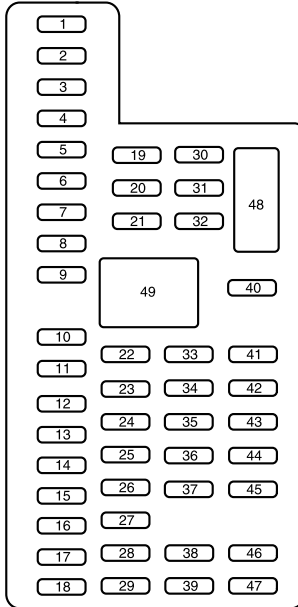

E163102

Fuse or relay number	Fuse amp rating	Protected components
1	30A	Left front window motor.
2	15A	Upfitter relay #4.
3	30A	Right front window motor.
4	10A	Interior lamps.
5	—	Not used.
6	—	Not used.
7	7.5A	Power mirror switch.

Fuses

Fuse or relay number	Fuse amp rating	Protected components
8	—	Not used.
9	10A	Upfitter relay #3.
10	—	Not used.
11	10A	Ford telematics battery feed.
12	15A	Interior lighting.
13	15A	Right turn and brake lamps.
14	15A	Left turn and brake lamps.
15	15A	Center high-mounted stop lamp. Backup lamps.
16	10A	Right headlamp low beam.
17	10A	Left headlamp low beam.
18	10A	Powertrain control module wakeup. Brake shift interlock.
19	—	Not used.
20	20A	Power door locks.
21	10A	Brake on/off switch.
22	20A	Horn.
23	15A	Instrument cluster.
24	15A	Diagnostic connector. Power fold mirror relay. Steering wheel control module. Remote keyless entry.
25	—	Not used.
26	5A	Steering wheel control module.
27	—	Not used.
28	15A	Ignition switch.
29	20A	Radio. SYNC.
30	15A	Parking lamps. Trailer tow parking lamps relay coil.

Fuses

Fuse or relay number	Fuse amp rating	Protected components
31	5A	Customer access trailer brake on/off switch.
32	15A	Delayed accessory power. Driver and passenger door lock switch illumination. 110v power inverter module. Telescoping mirror switch.
33	—	Not used.
34	10A	Ancillary translator module run/start.
35	5A	Tow/Haul run/start.
36	10A	Fuel tank select switch.
37	10A	Auxiliary heater.
38	10A	Delayed accessory power. AM/FM base radio.
39	15A	Left and right headlamp high beam.
40	10A	Rear parking lamps. Clearance lamps.
41	—	Not used.
42	5A	Ford telematics run/start.
43	10A	Power Distribution Box run/accessory fuses. Wiper relay coil.
44	10A	Customer access upfitter switch power. Ancillary translator module run/accessory sense.
45	—	Not used.
46	10A	Climate control module.
47	15A	Fender direction indicator lamps.
48	30A Circuit breaker	Power windows switch (crew cab).
49	Relay	Delayed accessory power.

Fuses

CHANGING A FUSE

Fuses

WARNING



Always replace a fuse with one that has the specified amperage rating. Using a fuse with a higher amperage rating can cause severe wire damage and could start a fire.



E217331

If electrical components in the vehicle are not working, a fuse may have blown. Blown fuses are identified by a broken wire within the fuse. Check the appropriate fuses before replacing any electrical components.

FuseTypes

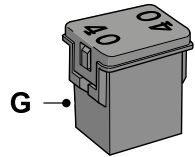
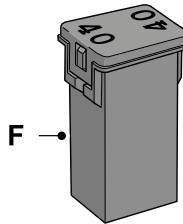
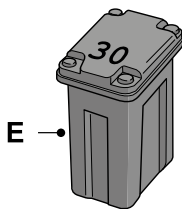
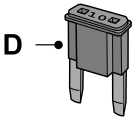
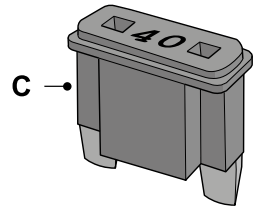
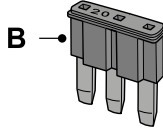
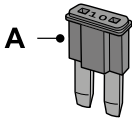

E207206

Callout	Fuse Type
A	Micro 2
B	Micro 3
C	Maxi
D	Mini

Fuses

Callout	Fuse Type
E	M Case
F	J Case
G	J Case Low Profile

Vehicle Inspection Guide

VEHICLE INSPECTION INFORMATION

To make sure your vehicle is ready to operate, conduct a pre-trip inspection at the beginning of each work period. Follow the steps listed in this section to verify a proper vehicle inspection procedure.

WARNINGS



Exercise great caution when working on a vehicle equipped with an automatic fan clutch. The fan starts in motion only after the engine coolant reaches a predetermined temperature or the refrigerant pressure (if equipped with air conditioning) reaches a predetermined setting. The fan starts at this point with no advance warning. Never reach near, or permit objects to protrude into, the fan blade radius while the engine is running as this could result in vehicle damage, personal injury or death.

WARNINGS



Do not operate the vehicle if any suspension conditions listed in the following charts are evident. Loss of steering or suspension could result in property damage, personal injury or death.



If a wheel must be changed, obtain expert tire service help. Mounting and un-mounting of tires should only be performed by a qualified technician using necessary safety procedures and equipment, otherwise the result could be property damage, personal injury or death.

Note: Always make sure you apply the parking brake before starting the engine.

Engine compartment (with engine off)	
Engine oil	Use the dipstick to verify the oil level is in the proper operating range. See Engine Oil Dipstick (page 185).
Engine coolant	Look through the plastic reservoir and verify the coolant level is within the proper operating range. Do not remove the pressure cap until the coolant has cooled. See Engine Coolant Check (page 189).
Power steering fluid	Verify that the fluid level is in the proper operating range. See Power Steering Fluid Check (page 201).
Brake fluid	Remove the master cylinder caps and inspect the fluid level. See Brake Fluid Check (page 200).

Vehicle Inspection Guide

Engine compartment (with engine off)	
Belts (fan, alternator, water pump and air conditioning compressor)	Inspect for glazing, fraying or cracking. There should be no more than 5-7 cracks per rib, per 1 in (2.5 cm)
Fluid leaks	Inspect for signs of fluid puddles or dripping fluid on the ground under the engine, or the underside of the engine.
HVAC air inlet	Inspect for debris that may have collected on the HVAC air inlet grille or inside the exterior module as this may reduce system performance.

Engine starting (with parking brake applied)	
Safety and emergency equipment	Before entering the cab, verify that the vehicle is equipped with spare electrical fuses (if used), three red reflective triangles, a properly charged and rated fire extinguisher and wheel chocks.
	Walk around the vehicle and verify all steps and grab handles, inside and out (as well as behind), are tight and clean. Use extreme caution and a three-point stance at all times.
	Inspect door latches for proper closing, latching and locking.
Starting the engine	Set the parking brake. Make sure the gearshift lever is in neutral (N) or park (P) (if equipped with a park position).
	Diesel engine: Turn the key to the on position. Turn the key to start when the wait to start indicator light in the instrument cluster turns off.
	Gasoline engine: Turn the key to start, and then release it as soon as the engine starts.
Engine oil pressure	Verify pressure builds to normal operating range.
Low air pressure warning tone (if equipped with an air compressor)	A tone indicating low air pressure should sound immediately after the engine starts but before the compressor has built-up pressure. The tone should stop when the air pressure reaches 70 psi (483 kPa). Let the air pressure build to governed cutout pressure, which should occur between 115–130 psi (793–896 kPa).
Accelerator	Press the accelerator and verify that it operates smoothly, without any binding or irregular feel. Release the pedal and verify the engine returns to idle speed immediately.

Vehicle Inspection Guide

Engine starting (with parking brake applied)	
Voltmeter	Check the gauge (diesel engine) or indicator light (gasoline engine) to verify the alternator is charging.
Steering linkage free play	Inspect for excessive free play in the steering linkages. The steering wheel should have less than 2 in (5 cm) of free play at its rim.
Parking brake	Verify the parking brake holds the vehicle by gently trying to pull forward with the parking brake applied.
Air brakes	Verify operation using the following procedure. Chock the wheels, if necessary. Push in the parking brake and, on tractors, push in the tractor parking brake knob:
	1. Verify the air compressor or governor cutout pressure is approximately 120 psi (827 kPa).
	2. Turn off the engine, and then turn the key back to the on position (without starting the engine).
	3. Without the brake pedal applied, note the air pressure drop for one minute. It should be less than 2 psi (14 kPa) for single vehicles and 3 psi (21 kPa) for combination vehicles.
	4. Press and hold the brake pedal with 90 psi (621 kPa) or more. Make sure there is no more than a 3 psi (21 kPa) per minute leak for single vehicles and a 4 psi (28 kPa) minute leak for combination vehicles.
	5. Pump the brake pedal to deplete the system of air pressure. The warning light and tone should turn on at 57 psi (393 kPa).
6. Pump the brake pedal and make sure the parking brake and trailer parking brake knobs pop out at 20 psi (138 kPa) or higher.	
Automatic transmission fluid	Verify that the fluid level is in the proper operating range. See Automatic Transmission Fluid Check (page 198).

Front of vehicle	
Lights	Verify all exterior lights illuminate and are clean.
	Check headlights function on high and low beam.
	Verify reflectors are clean, unbroken and of proper color (red on rear, amber elsewhere).

Vehicle Inspection Guide

Front of vehicle	
	Verify running lights are clean and unbroken.
Steering gear	Inspect for any missing or loose fasteners, power steering fluid leaks and damage to power steering hoses.
Steering linkage	Verify connecting links, arms and rods are not worn or cracked.
	Verify joints, sockets and boot seals are not worn or loose.
	Verify cotter keys, nuts and bolts are not loose or missing.
Tow hooks	Inspect front and rear tow hooks for damage or loose mounting. This is particularly important on vehicles that use them frequently.

Front suspension	
Springs	Inspect for missing, broken or shifted leaves, or leaves that may be in contact with (or nearly contacting) a tire, rim, brake drum, frame or body component.
	Note: Never apply grease to spring pads.
Spring mounts	Make sure there the following items are properly tightened and that there are no cracks, breaks, wear, damage to spring hangers, bolts, bushings, axle mounting bolts, and nuts.
Shock absorbers	Inspect for any cracks, leaks, or missing or broken bolts or bushings.

Vehicle Inspection Guide

Front brakes	
Hoses	Inspect for cracked, worn or frayed hoses, and that all couplings are secure.
Brake chambers	Verify that there are no cracks or dents, and that the chambers are securely mounted.
Slack adjusters	Inspect for broken, loose or missing parts. Note: The angle between the push rod and adjuster arm should be approximately 90 degrees when the brakes are applied. When pulled by hand, the push rod should not move more than approximately 1 in (2.5 cm).
Drums	Verify that there are no cracks, dents, holes, and no loose or missing bolts and that the brake linings are not worn, dangerously thin or contaminated by lubricant.

Front wheels	
Rims	Inspect for damaged or bent rims. They should not have welding repairs, and there should be no rust trails, which indicate it is loose on the wheel.
Lug nuts	Verify all lug nuts are present and not loose (look for rust trails around the lug nuts). There should be no cracks radiating from the lug bolt holes or distortion of the bolt holes.
Hub oil seals	Inspect wheel hub oil seal for leaks and, if sight glass is present, verify the oil level is adequate.
Oil-lubricated front wheel bearings	Inspect for proper lubrication level if the hubcap has a transparent window. If the hubcap does not have a transparent window, remove the rubber fill-plug and inspect for proper level.

Fuel area	
Fuel tank(s)	Verify the tank(s) and cap(s) are secure and that there are no leaks from the tank(s).
Leaks	Inspect for leaks from the tank(s).

Vehicle Inspection Guide

Diesel Exhaust Fluid (DEF) area	
DEF tanks	Verify the tanks and caps are secure and that there are no leaks from the tanks.
Leaks	Inspect for leaks from the tanks.

Underbody	
Driveshaft	Verify that the driveshaft is not bent or cracked and that all driveshaft couplings are secure.
Exhaust system	Verify that the visible outside parts are securely mounted and that there are no cracks, holes or severe dents.
Frame	Inspect for cracks or bends in longitudinal frame members. Verify there are no loose, cracked, bent, broken or missing crossmembers or crossmember fasteners.

Rear of vehicle	
Air hoses and electrical lines	Verify there are no cuts, cracks, chafing or wear on the air hoses and electrical line insulation. Listen for audible air leaks.
	Verify air and electrical lines are not tangled, crimped or pinched or being dragged against any truck parts. None of the air or electrical line should be spliced or taped.
	Inspect for corrosion on pins and in electrical sockets to verify continuity and reduced heat build-up potential.
Deck plate	Verify the deck plate is clean, bolted securely to the frame and is clear of loose objects.
Turns signals, brake lights and flashers	Verify that both brake lights illuminate when the pedal is applied, each signal flashes and that the four-way flashers work properly.
Lights and reflectors	Verify all exterior lights illuminate and are clean.
	Verify reflectors are clean, unbroken and of proper color (red on rear, amber elsewhere).
	Verify running lights are clean and unbroken.
	Note: Inspect rear running lights separately from signal, flasher and brake lights.

Vehicle Inspection Guide

Tractor-coupling system	
Mounting bolts	Inspect for loose or missing mounting brackets, clamps, bolts or nuts. Verify solid attachment of both fifth wheel and the slide mounting.
Platform	Inspect for cracks or breaks in the platform structure.
Safety latch	Verify engagement of the safety latch.
Release arm	Verify the safety latch is in the engaged position, and that any safety latch is in place.
Kingpin and apron	Verify the kingpin is not bent or worn, the apron lies flat on the fifth-wheel skid plate and that the visible part of the apron is not bent, worn, cracked or broken.

Rear suspension	
Springs (if equipped)	Inspect for missing, broken or shifted leaves, or leaves that may be in contact with (or nearly contacting) a tire, rim, brake drum, frame or body component.
Spring mounts (if equipped)	Inspect for any cracked or broken spring hangers; broken missing or loose bolts; missing or damaged bushings; broken, loose or missing axle mounting parts.
Torsion arm and shock absorbers	Verify torsion arm is not cracked, broken or missing.
	Inspect the shock absorber for cracks or leaks. There should be no missing or broken mounting bolts or worn bushings.
Air suspension (if equipped)	Inspect for missing, broken or leaking components. Inspect for any cracked, broken or loose bolts; missing or damaged bushings; broken, loose or missing axle mounting parts.

Vehicle Inspection Guide

Rear brakes	
Hoses	Inspect for cracked, worn or frayed hoses, and that all couplings are secure.
Brake chambers	Verify that there are no cracks or dents, and that the chambers are securely mounted.
Slack adjusters	Inspect for broken, loose or missing parts. Note: The angle between the push rod and adjuster arm should be approximately 90 degrees when the brakes are applied. When pulled by hand, the push rod should not move more than approximately 1 in (2.5 cm).
Drums	Verify that there are no cracks, dents, holes, and no loose or missing bolts and that the brake linings are not worn, dangerously thin or contaminated by lubricant.

Rear wheels	
Spacers	Check for even separation of dual wheels, and that the tires are not touching each other.
Rims	Inspect for damaged or bent rims. They should not have welding repairs, and there should be no rust trails, which indicate it is loose on the wheel.
Lug nuts	Verify all lug nuts are present and not loose (look for rust trails around the lug nuts). There should be no cracks radiating from the lug bolt holes or distortion of the bolt holes.

Trailer

If you are pulling a trailer, perform an inspection of the trailer similar to that of the tractor. The inspection should follow trailer manufacturer recommendations and should include at a minimum: general condition, landing gear, doors, sides, lights, reflectors, suspension, brakes, tires, wheels, cargo placement, stability and tie-downs.

Transmission

WARNING



If the unit starts in gear and/or the neutral start switch is not functioning correctly, the vehicle may inadvertently move which could result in property damage, personal injury or death.

Regularly inspect the transmission's neutral start switch. The engine should only start in neutral (N) or park (P) (if equipped with a park position).

Vehicle Inspection Guide

Inspect the transmission fluid level and shift linkage for proper operation.

Maintenance

GENERAL INFORMATION

WARNINGS



Making modifications to various parts, components and systems of the vehicle, such as brake and steering systems, can adversely affect the quality, reliability and operation of your vehicle and could result in property damage, personal injury or death. Such modifications must be avoided.



Failure to properly perform maintenance and servicing procedures could result in vehicle damage, personal injury or death.



Take care when performing any maintenance, system check or service on your vehicle. Some of the materials may also be hazardous if used, serviced or handled improperly and could result in property damage, personal injury or death.

If the owner or operator of the vehicle is a skilled technician and intends on performing the vehicle maintenance and service, he is strongly urged to purchase a service manual.

Always use care when performing vehicle maintenance, repairs or system checks. Improper or incomplete service could result in your vehicle not working properly which may result in personal injury or damage to your vehicle or equipment. It is the operator's responsibility to see that your vehicle receives proper care and maintenance. If you have any questions about performing service, have the service done by a qualified technician.

To help you service your vehicle, we provide scheduled maintenance information which makes tracking routine service easy. See **Scheduled Maintenance** (page 316).

If your vehicle requires professional service, an authorized dealer can provide the necessary parts and service. Check your warranty information to find out which parts and services are covered.

Use only recommended fuels, lubricants, fluids and service parts conforming to specifications. Motorcraft® parts are designed and built to provide the best performance in your vehicle.

Servicing Guidelines

WARNING



The use of inferior parts can adversely affect the quality and reliability of your vehicle and could result in property damage, personal injury or death.

When servicing your vehicle:

- Always wear safety glasses for eye protection.
- Always set the parking brake or chock the wheels.
- Always use support stands, not a jack, when working under a raised vehicle.
- Always turn off the ignition unless a procedure requires the engine to be running.
- Always avoid contact with hot metal parts. Allow the components to cool before working with, or around, them.
- Always operate the engine in a well-ventilated area.
- Do not wear loose-fitting clothing, hanging jewelry, watches or rings.
- Do not smoke.
- Do not work on the brakes or the clutch unless you take the proper precautions to avoid inhaling friction material dust.

Maintenance

Quality service parts are available through an authorized dealer. If dealer parts are not used, make sure the replacement parts are of equivalent quality.

Working with the Engine Off

1. Set the parking brake and shift to neutral (N) or park (P).
2. Switch off the engine.
3. Block the wheels.

Working with the Engine On

WARNING



To reduce the risk of vehicle damage and/or personal burn injuries, do not start your engine with the air cleaner removed and do not remove it while the engine is running.

1. Set the parking brake and shift to neutral (N) or park (P).
2. Block the wheels

Supporting Your Vehicle for Service

WARNING



Do not use a jack when working under a vehicle. It may give way, causing the vehicle to fall and result in property damage, personal injury or death. Always use floor stands to support the vehicle.

Prepare your vehicle for service repairs by doing the following:

1. Park your vehicle on a level, concrete floor.
2. Set the parking brake and block the wheels to prevent your vehicle from moving.

3. Select a jack with a rated capacity sufficient to lift and hold up your vehicle.
4. Raise your vehicle with the jack applied to the axle(s). Do not use the bumper as a lifting point.
5. Support your vehicle with floor stands under the axle(s). When servicing the axle or the suspension, support your vehicle with floor stands under the frame side-members, preferably between the axles.

OPENING AND CLOSING THE HOOD

WARNINGS



Always set the parking brake fully before opening the hood. Failure to follow this warning could result in serious personal injury or death.



Do not stand under the hood when you raise or lower it. Failure to follow this warning could result in serious personal injury or death.



If the engine is running while the hood is open, stay clear of moving engine components. Failure to follow this warning could result in serious personal injury or death.

Opening the Hood

Before opening the hood, set the parking brake fully, shift into park (P) or neutral (N) and switch the ignition off.

Maintenance

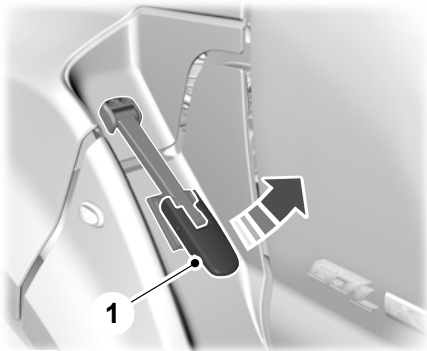

E209159

1. Lift and release the hood latches on both sides of your vehicle.

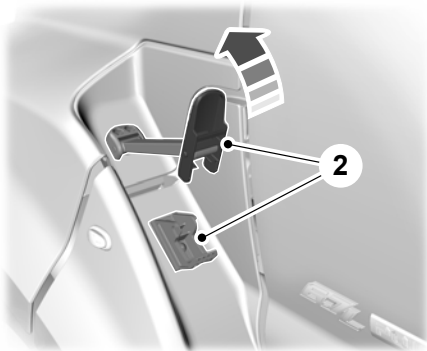

E209160

2. Fully disengage the hood latches on both sides of your vehicle.

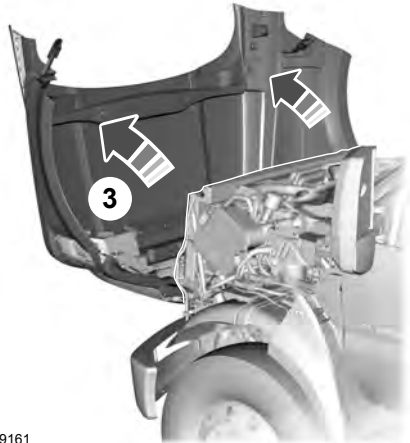

E209161

3. Tilt the hood fully forward until it is held by the gas struts.

Closing the Hood

1. Push the hood rearward above the grille until fully closed.
2. Engage the hood latches on both sides of your vehicle.
3. Fully close the hood latches on both sides of your vehicle.

Maintenance

UNDER HOOD OVERVIEW - 6.8L

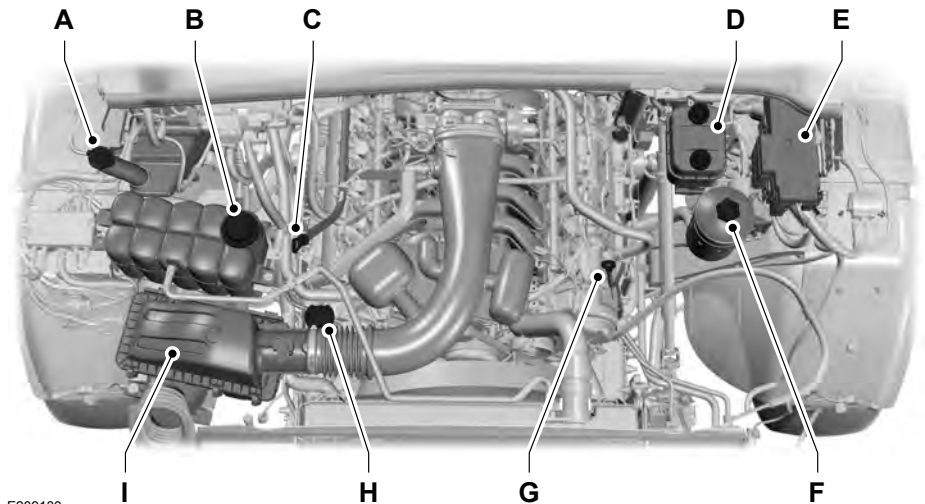

E209130

- A Windshield washer fluid reservoir. See **Washer Fluid Check** (page 201).
- B Engine coolant reservoir. See **Engine Coolant Check** (page 189).
- C Automatic transmission fluid dipstick. See **Automatic Transmission Fluid Check** (page 198).
- D Brake fluid reservoir. See **Brake Fluid Check** (page 200).
- E Engine compartment fusebox. See **Fuses** (page 161).
- F Power steering fluid reservoir. See **Power Steering Fluid Check** (page 201).
- G Engine oil dipstick. See **Engine Oil Dipstick** (page 185).
- H Engine oil filler cap. See **Engine Oil Check** (page 185).
- I Air cleaner assembly. See **Changing the Engine Air Filter** (page 209).

Maintenance

UNDER HOOD OVERVIEW - 6.7L DIESEL

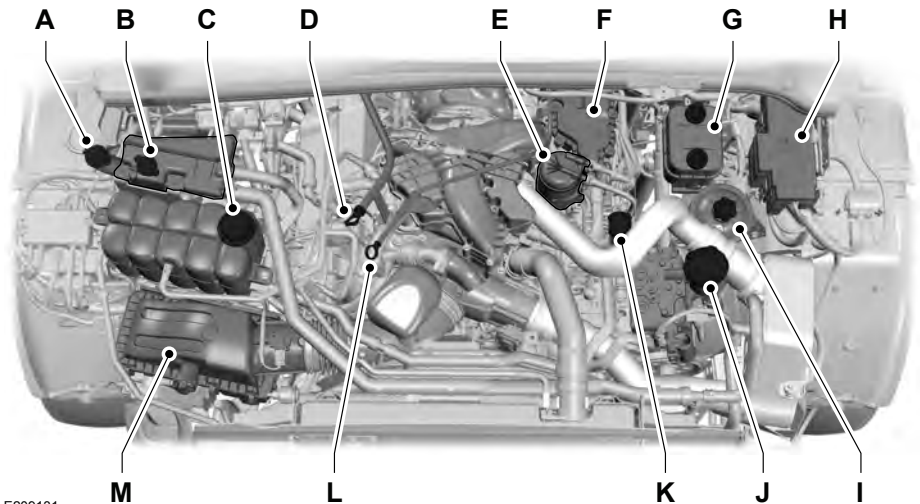

E209131

- A Windshield washer fluid reservoir. See **Washer Fluid Check** (page 201).
- B Secondary Cooling System Reservoir. See **Engine Coolant Check** (page 194).
- C Engine coolant reservoir. See **Engine Coolant Check** (page 194).
- D Automatic transmission fluid dipstick. See **Automatic Transmission Fluid Check** (page 198).
- E Secondary fuel filter. See **Draining the Fuel Filter Water Trap** (page 202).
- F Engine oil separator. See **Changing the Engine Oil and Oil Filter** (page 187).
- G Brake fluid reservoir. See **Brake Fluid Check** (page 200).
- H Engine compartment fusebox. See **Fuses** (page 161).
- I Power steering fluid reservoir. See **Power Steering Fluid Check** (page 201).
- J Air brake compressor. See **Brake System Inspection** (page 219).
- K Engine oil filler cap. See **Engine Oil Check** (page 186).
- L Engine oil dipstick. See **Engine Oil Dipstick** (page 185).
- M Air cleaner assembly. See **Changing the Engine Air Filter** (page 210).

Maintenance

ENGINE OIL DIPSTICK - 6.8L



E161560

- A MIN
- B MAX

ENGINE OIL DIPSTICK - 6.7L DIESEL

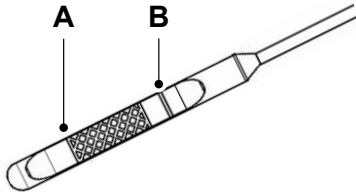

E206879

- A Minimum.
- B Maximum.

ENGINE OIL CHECK - 6.8L

To check the engine oil level consistently and accurately, do the following:

1. Make sure the parking brake is on. Make sure the transmission is in park (P) or neutral (N).

2. Run engine until it reaches normal operating temperature.
3. Make sure that your vehicle is on level ground.
4. Switch the engine off and wait 15 minutes for the oil to drain into the oil pan. Checking the engine oil level too soon after you switch the engine off may result in an inaccurate reading.
5. Open the hood. See **Opening and Closing the Hood** (page 181).
6. Remove the dipstick and wipe it with a clean, lint-free cloth. See **Under Hood Overview** (page 183).
7. Replace the dipstick and remove it again to check the oil level. See **Engine Oil Dipstick** (page 185).
8. Make sure that the oil level is between the maximum and minimum marks. If the oil level is at the minimum mark, add oil immediately. See **Capacities and Specifications** (page 258).
9. If the oil level is correct, replace the dipstick and make sure it is fully seated.

Note: Do not remove the dipstick when the engine is running.

Note: If the oil level is between the maximum and minimum marks, the oil level is acceptable. Do not add oil.

Note: The oil consumption of new engines reaches its normal level after approximately 3,100 mi (5,000 km).

Adding Engine Oil

WARNING



Do not remove the filler cap when the engine is running.

Do not use supplemental engine oil additives because they are unnecessary and could lead to engine damage that may not be covered by the vehicle Warranty.

Maintenance



E142732

Only use oils certified for gasoline engines by the American Petroleum Institute (API). An oil with this trademark symbol conforms to the current engine and emission system protection standards and fuel economy requirements of the International Lubricants Specification Advisory Committee (ILSAC).

To top up the engine oil level do the following:

1. Clean the area surrounding the engine oil filler cap before you remove it.
2. Remove the engine oil filler cap. See **Under Hood Overview** (page 183). Turn it counterclockwise and remove it.
3. Add engine oil that meets Ford specifications. See **Capacities and Specifications** (page 258). You may have to use a funnel to pour the engine oil into the opening.
4. Recheck the oil level.
5. If the oil level is correct, replace the dipstick and make sure it is fully seated.
6. Replace the engine oil filler cap. Turn it clockwise until you feel a strong resistance.

Note: Do not add oil further than the maximum mark. Oil levels above the maximum mark may cause engine damage.

Note: Make sure you install the oil filler cap correctly.

Note: Soak up any spillage with an absorbent cloth immediately.

ENGINE OIL CHECK - 6.7L DIESEL

To check the engine oil level consistently and accurately, do the following:

1. Make sure the parking brake is on. Make sure the transmission is in park (P) or neutral (N).
2. Run engine until it reaches normal operating temperature.
3. Make sure that your vehicle is on level ground.
4. Switch the engine off and wait 15 minutes for the oil to drain into the oil pan. Checking the engine oil level too soon after you switch the engine off may result in an inaccurate reading.
5. Open the hood. See **Opening and Closing the Hood** (page 181).
6. Remove the dipstick and wipe it with a clean, lint-free cloth. See **Under Hood Overview** (page 184).
7. Replace the dipstick and remove it again to check the oil level. See **Engine Oil Dipstick** (page 185).
8. Make sure that the oil level is between the maximum and minimum marks. If the oil level is at the minimum mark, add oil immediately. See **Capacities and Specifications** (page 263).
9. If the oil level is correct, replace the dipstick and make sure it is fully seated.

Note: Do not remove the dipstick when the engine is running.

Note: If the oil level is between the maximum and minimum marks, the oil level is acceptable. Do not add oil.

Maintenance

Note: The oil consumption of new engines reaches its normal level after approximately 3,100 mi (5,000 km).

Adding Engine Oil

WARNING



Do not remove the filler cap when the engine is running.

Do not use supplemental engine oil additives because they are unnecessary and could lead to engine damage that may not be covered by the vehicle Warranty.



E163371

The American Petroleum Institute (API) service symbol is used to identify the proper engine oil for your vehicle's engine. The API service symbol will be displayed on the oil container you purchase. The API service symbol displays the oil performance category in the top half of symbol and the viscosity grade in the center of the symbol.

To top up the engine oil level do the following:

1. Clean the area surrounding the engine oil filler cap before you remove it.
2. Remove the engine oil filler cap. See **Under Hood Overview** (page 184). Turn it counterclockwise and remove it.

3. Add engine oil that meets Ford specifications. See **Capacities and Specifications** (page 263). You may have to use a funnel to pour the engine oil into the opening.
4. Recheck the oil level.
5. If the oil level is correct, replace the dipstick and make sure it is fully seated.
6. Replace the engine oil filler cap. Turn it clockwise until you feel a strong resistance.

Note: Do not add oil further than the maximum mark. Oil levels above the maximum mark may cause engine damage.

Note: Make sure you install the oil filler cap correctly.

Note: Soak up any spillage with an absorbent cloth immediately.

CHANGING THE ENGINE OIL AND OIL FILTER

WARNINGS



Do not handle a hot oil filter with bare hands.



Continuous contact with used motor oil has caused cancer in laboratory mice. Protect your skin by washing with soap and water.

If your vehicle is equipped with a diesel engine, an Intelligent Oil Life Monitor™ calculates the proper oil change service interval. When the information display indicates: OIL CHANGE REQUIRED, change the engine oil and oil filter. See **Information Displays** (page 62).

The engine oil filter protects your engine by filtering harmful, abrasive or sludge particles and particles significantly smaller than most available will-fit filters. See **Motorcraft Parts** (page 254).

Maintenance

1. Unscrew the oil filter and oil pan drain plug and wait for the oil to drain.
2. Replace the filter.
3. Reinstall the oil pan drain plug.
4. Refill the engine with new oil. See **Capacities and Specifications** (page 258).
5. For diesel engines, you need to reset the Intelligent Oil Life Monitor™. See **Information Displays** (page 62).

Engine lubrication for severe service operation

The following conditions define severe operation for which engine operation with SAE 5W-40 API CJ-4 is recommended. Oil and oil filter change intervals will be determined by the Intelligent Oil Life Monitor™ as noted previously.

- Frequent or extended idling (over 10 minutes per hour of normal driving).
- Low-speed operation/stationary use.
- If vehicle is operated in sustained ambient temperatures below -9°F (-23°C) or above 100°F (38°C).
- Frequent low-speed operation, consistent heavy traffic less than 25 mph (40 km/h).
- Operating in severe dust conditions.
- Operating the vehicle off road.
- Towing a trailer over 1,000 mi (1,600 km).
- Sustained, high-speed driving at Gross Vehicle Weight Rating (maximum loaded weight for vehicle operation).
- Use of fuels with sulfur content other than ultra-low sulfur diesel (ULSD).
- Use of high-sulfur diesel fuel.

CHANGING THE COALESCER FILTER ELEMENT

WARNING



Do not dispose of engine oil or oil filters in the household refuse or the public sewage system. Use an authorized waste disposal facility.

Do not clean or recondition the filter element.

We recommend that you demand the use of genuine Ford and Motorcraft® parts whenever your vehicle requires scheduled maintenance or repair. Use the correct specification filter element. See **Motorcraft Parts** (page 255).

Note: *Operating your vehicle without a filter element or with an unapproved filter element may result in damage to the turbo charger or exchanger and could lead to engine damage that may not be covered by the vehicle Warranty.*

Maintenance

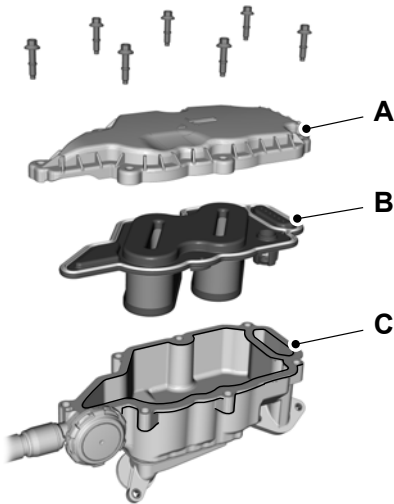

E211403

- A Filter cover.
- B Filter element.
- C Filter housing.

1. Clean the filter cover and remove the bolts.
2. Carefully remove the filter cover.
3. Remove used filter element from the filter housing and carefully dispose of it.
4. Make sure that the sealing surfaces on the filter housing and cover are clean and free of debris.
5. Install the new filter element.
6. Install the filter cover.
7. Install the bolts finger-tight.

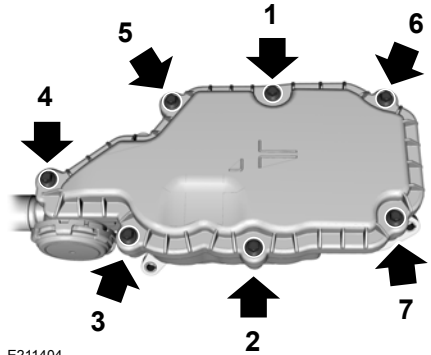

E211404

8. Fully tighten all of the bolts to between 3–4 lb.ft (4.5–6 Nm) in the sequence shown.
9. Record the engine mileage and update the service log accordingly.

OIL CHANGE INDICATOR RESET

Use the information display controls on the steering wheel to reset the oil change indicator. See **General Information** (page 62).

ENGINE COOLANT CHECK - 6.8L

WARNINGS



Do not add engine coolant when the engine is hot. Steam and scalding liquids released from a hot cooling system can burn you badly. Also, spilling coolant on hot engine parts can burn you.



Do not put engine coolant in the windshield washer fluid container. If sprayed on the windshield, engine coolant could make it difficult to see through the windshield.

Maintenance

WARNINGS



To reduce the risk of personal injury, make sure the engine is cool before unscrewing the coolant pressure relief cap. The cooling system is under pressure. Steam and hot liquid can come out forcefully when you loosen the cap slightly.



Do not add coolant further than the **MAX** mark.

When the engine is cold, check the concentration and level of the coolant at the intervals listed in the scheduled maintenance information. See **Scheduled Maintenance** (page 316).

Note: Make sure that the coolant level is between the **MIN** and **MAX** marks on the coolant reservoir.

Note: Coolant expands when it is hot. The level may extend beyond the **MAX** mark.

Maintain coolant concentration within 48% to 50%, which equates to a freeze point between -30°F (-34°C) and -34°F (-37°C). Coolant concentration should be checked using a refractometer. We do not recommend the use of hydrometers or coolant test strips for measuring coolant concentration.

Adding Coolant

WARNING



Never remove the coolant reservoir cap while the engine is running or hot.

Note: Automotive fluids are not interchangeable. Do not use coolant or windshield washer fluid outside of its specified function and vehicle location.

Note: Do not use stop leak pellets, cooling system sealants, or non-specified additives as they can cause damage to the engine cooling or heating systems. Resulting component damage may not be covered by the vehicle Warranty.

It is very important to use prediluted coolant approved to the correct specification in order to avoid plugging the small passageways in the engine cooling system. See **Capacities and Specifications** (page 258). Do not mix different colors or types of coolant in your vehicle. Mixing of engine coolants or using an incorrect coolant may harm the engine or cooling system components and may not be covered by the vehicle Warranty.

Note: Coolants marketed for all makes and models may not be approved to Ford specifications and may cause damage to the cooling system. Resulting component damage may not be covered by the vehicle Warranty.

If the coolant level is at or below the minimum mark, add prediluted coolant immediately.

For vehicles with overflow coolant systems with a non-pressurized cap on the coolant recovery system, add coolant to the coolant recovery reservoir when the engine is cool. Add prediluted coolant to the maximum level. For all vehicles which have a coolant degas system with a pressurized cap, or if it is necessary to remove the coolant pressure relief cap on the radiator, follow these steps to add engine coolant:

1. Turn the engine off and let it cool.
2. Unscrew the cap slowly. Any pressure escapes as you unscrew the cap.
3. Fill the coolant reservoir slowly with prediluted engine coolant to within the minimum and maximum range on the engine coolant reservoir. If you removed the radiator cap in an overflow system, fill the radiator until

Maintenance

the coolant is visible and the radiator is almost full. If coolant is added to bring the level within the minimum and maximum range when the engine is not cold, the system may remain underfilled.

4. Replace the coolant reservoir cap, turn it clockwise until you feel a strong resistance.
5. Check the coolant level in the coolant reservoir the next few times you drive your vehicle. If necessary, add enough prediluted engine coolant to bring the coolant level to the proper level.

Note: *If prediluted coolant is not available, use the approved antifreeze concentrate diluting it to 50/50 with distilled water. See **Capacities and Specifications** (page 258). Using water that has not been deionised may contribute to deposit formation, corrosion or plugging of the small cooling system passageways.*

If you have to add more than 1.1 qt (1 L) of engine coolant per month, have your vehicle checked as soon as possible. Operating an engine with a low level of coolant can result in engine overheating and possible engine damage.

Note: *During normal vehicle operation, the coolant may change color from orange to pink or light red. As long as the coolant is clear and uncontaminated, this color change does not indicate the coolant has degraded nor does it require the coolant to be drained, the system to be flushed, or the coolant to be replaced.*

Note: *In case of emergency, you can add a large amount of water without coolant in order to reach a vehicle service location. Water alone, without coolant, can cause engine damage from corrosion, overheating or freezing. When you reach a service location, you must have the cooling system drained, flushed and refilled using the correct specification prediluted coolant or antifreeze concentrate. See **Capacities and Specifications** (page 258).*

Do not use the following as a coolant substitute:

- Alcohol.
- Methanol.
- Brine.
- Any coolant mixed with alcohol or methanol antifreeze.

Alcohol and other liquids can cause engine damage from overheating or freezing.

Do not add extra inhibitors or additives to the coolant. These can be harmful and compromise the corrosion protection of the coolant.

Recycled Coolant

We do not recommend the use of recycled coolant as an approved recycling process is not yet available.

Dispose of used engine coolant in an appropriate manner. Follow your community's regulations and standards for recycling and disposing of automotive fluids.

Maintenance

Severe Climates

If you drive in extremely cold climates:

- It may be necessary to increase the coolant concentration above 50%.
- A coolant concentration of 60% provides improved freeze point protection. Coolant concentrations above 60% decrease the overheat protection characteristics of the coolant and may cause engine damage.

If you drive in extremely hot climates:

- You can decrease the coolant concentration to 40%.
- Coolant concentrations below 40% decrease the freeze and corrosion protection characteristics of the coolant and may cause engine damage.

Vehicles driven year-round in non-extreme climates should use prediluted engine coolant for optimum cooling system and engine protection.

Coolant Change

At specific mileage intervals, as listed in the scheduled maintenance information, the coolant should be changed. The information display may display a message to change coolant at this time. Add prediluted coolant approved to the correct specification. See **Capacities and Specifications** (page 252).

Engine-driven Cooling Fan (Fan Clutch)

Your vehicle is equipped with an engine driven cooling fan drive (also called a fan clutch). This fan drive changes the fan speed to match the vehicle's changing cooling air flow requirements. Fan speed, fan noise level and fuel consumption all will increase based on the driving conditions that include trailer towing, hill climbing, heavy loads, high speed and high ambient temperature, individually or in combination.

The fan drive is designed to provide the minimum fan speed (and resulting minimum fan noise and fuel consumption) required to meet the ever changing vehicle cooling air flow requirements. You will hear the amount of fan noise increasing and decreasing as the engine power requirements and vehicle driving conditions change as you drive. This is to be expected as being normal to the operation of your vehicle. High levels of fan noise might also be heard when your engine is first started, and should normally decrease after driving for a short time.

Fail-Safe Cooling

Fail-safe cooling allows you to temporarily drive your vehicle before any incremental component damage occurs. The fail-safe distance depends on ambient temperature, vehicle load and terrain.

How Fail-Safe Cooling Works

If the engine begins to overheat, the coolant temperature gauge moves toward the red zone:



A warning lamp illuminates and a message may appear in the information display.



Maintenance

If the engine reaches a preset over-temperature condition, the engine automatically switches to alternating cylinder operation. Each disabled cylinder acts as an air pump and cools the engine.

When this occurs, your vehicle still operates, however:

- Engine power is limited.
- The air conditioning system turns off.

Continued operation increases the engine temperature, causing the engine to completely shut down. Your steering and braking effort increases in this situation.

When the engine temperature cools, you can re-start the engine. Have your vehicle checked as soon as possible to minimize engine damage.

When Fail-Safe Mode Is Activated

WARNINGS



Fail-safe mode is for use during emergencies only. Operate your vehicle in fail-safe mode only as long as necessary to bring your vehicle to rest in a safe location and seek immediate repairs. When in fail-safe mode, your vehicle will have limited power, will not be able to maintain high-speed operation, and may completely shut down without warning, potentially losing engine power, power steering assist, and power brake assist, which may increase the possibility of a crash resulting in serious injury.



Never remove the coolant reservoir cap while the engine is running or hot.

Your vehicle has limited engine power when in the fail-safe mode, drive your vehicle with caution. Your vehicle does not maintain high-speed operation and the engine may operate poorly.

Remember that the engine is capable of automatically shutting down to prevent engine damage. In this situation:

1. Pull off the road as soon as safely possible and switch the engine off.
2. If you are a member of a roadside assistance program, we recommend that you contact your roadside assistance service provider.
3. If this is not possible, wait a short period for the engine to cool.
4. Check the coolant level. If the coolant level is at or below the minimum mark, add prediluted coolant immediately.
5. When the engine temperature cools, you can re-start the engine. Have your vehicle checked as soon as possible to minimize engine damage.

Note: *Driving your vehicle without repair increases the chance of engine damage.*

Engine Coolant Temperature Management (If Equipped)

WARNING



To reduce the risk of crash and injury, be prepared that the vehicle speed may reduce and the vehicle may not be able to accelerate with full power until the coolant temperature reduces.

If you tow a trailer with your vehicle, the engine may temporarily reach higher a temperature during severe operating conditions, for example ascending a long or steep grade in high ambient temperatures.

At this time, you may notice the coolant temperature gauge moves toward the red zone and a message may appear in the information display.

Maintenance

You may notice a reduction in vehicle speed caused by reduced engine power. In order to manage the engine coolant temperature. Your vehicle may enter this mode if certain high-temperature and high-load conditions take place. The amount of speed reduction depends on vehicle loading, grade and ambient temperature. If this occurs, there is no need to pull off the road. You can continue to drive your vehicle.

The air conditioning may automatically turn on and off during severe operating conditions to protect the engine from overheating. When the coolant temperature decreases to the normal operating temperature, the air conditioning turns on.

If the coolant temperature gauge moves fully into the red zone, or if the coolant temperature warning or service engine soon messages appear in your information display, do the following:

1. Pull off the road as soon as safely possible and shift the transmission into park **(P)**.
2. Leave the engine running until the coolant temperature gauge needle returns to the normal position. After several minutes, if the temperature does not drop, follow the remaining steps.
3. Switch the engine off and wait for it to cool. Check the coolant level.
4. If the coolant level is at or below the minimum mark, add prediluted coolant immediately.
5. If the coolant level is normal, restart the engine and continue.

ENGINE COOLANT CHECK - 6.7L DIESEL

WARNINGS



Do not add engine coolant when the engine is hot. Steam and scalding liquids released from a hot cooling system can burn you badly. Also, spilling coolant on hot engine parts can burn you.



Do not put engine coolant in the windshield washer fluid container. If sprayed on the windshield, engine coolant could make it difficult to see through the windshield.



To reduce the risk of personal injury, make sure the engine is cool before unscrewing the coolant pressure relief cap. The cooling system is under pressure. Steam and hot liquid can come out forcefully when you loosen the cap slightly.



Do not add coolant further than the **MAX** mark.

When the engine is cold, check the concentration and level of the coolant at the intervals listed in the scheduled maintenance information. See **Scheduled Maintenance** (page 316).

Note: Make sure that the coolant level is between the **MIN** and **MAX** marks on the coolant reservoir.

Note: Coolant expands when it is hot. The level may extend beyond the **MAX** mark.

Maintain coolant concentration within 48% to 50%, which equates to a freeze point between -30°F (-34°C) and -34°F (-37°C). Coolant concentration should be checked using a refractometer. We do not recommend the use of hydrometers or coolant test strips for measuring coolant concentration.

Maintenance

Adding Coolant

WARNING



Never remove the coolant reservoir cap while the engine is running or hot.

Note: *Automotive fluids are not interchangeable. Do not use coolant or windshield washer fluid outside of its specified function and vehicle location.*

Note: *Do not use stop leak pellets, cooling system sealants, or non-specified additives as they can cause damage to the engine cooling or heating systems. Resulting component damage may not be covered by the vehicle Warranty.*

It is very important to use prediluted coolant approved to the correct specification in order to avoid plugging the small passageways in the engine cooling system. See **Capacities and Specifications** (page 258). Do not mix different colors or types of coolant in your vehicle. Mixing of engine coolants or using an incorrect coolant may harm the engine or cooling system components and may not be covered by the vehicle Warranty.

Note: *Coolants marketed for all makes and models may not be approved to Ford specifications and may cause damage to the cooling system. Resulting component damage may not be covered by the vehicle Warranty.*

If the coolant level is at or below the minimum mark, add prediluted coolant immediately.

For vehicles with overflow coolant systems with a non-pressurized cap on the coolant recovery system, add coolant to the coolant recovery reservoir when the engine is cool. Add prediluted coolant to the maximum level. For all vehicles which have a coolant degas system with a pressurized cap, or if it is necessary to remove the coolant pressure relief cap on the radiator, follow these steps to add engine coolant:

1. Turn the engine off and let it cool.
2. Unscrew the cap slowly. Any pressure escapes as you unscrew the cap.
3. Fill the coolant reservoir slowly with prediluted engine coolant to within the minimum and maximum range on the engine coolant reservoir. If you removed the radiator cap in an overflow system, fill the radiator until the coolant is visible and the radiator is almost full. If coolant is added to bring the level within the minimum and maximum range when the engine is not cold, the system may remain underfilled.
4. Replace the coolant reservoir cap, turn it clockwise until you feel a strong resistance.
5. Check the coolant level in the coolant reservoir the next few times you drive your vehicle. If necessary, add enough prediluted engine coolant to bring the coolant level to the proper level.

Note: *If prediluted coolant is not available, use the approved antifreeze concentrate diluting it to 50/50 with distilled water. See **Capacities and Specifications** (page 258). Using water that has not been deionised may contribute to deposit formation, corrosion or plugging of the small cooling system passageways.*

Maintenance

If you have to add more than 1.1 qt (1 L) of engine coolant per month, have your vehicle checked as soon as possible. Operating an engine with a low level of coolant can result in engine overheating and possible engine damage.

Note: *During normal vehicle operation, the coolant may change color from orange to pink or light red. As long as the coolant is clear and uncontaminated, this color change does not indicate the coolant has degraded nor does it require the coolant to be drained, the system to be flushed, or the coolant to be replaced.*

Note: *In case of emergency, you can add a large amount of water without coolant in order to reach a vehicle service location. Water alone, without coolant, can cause engine damage from corrosion, overheating or freezing. When you reach a service location, you must have the cooling system drained, flushed and refilled using the correct specification prediluted coolant or antifreeze concentrate. See **Capacities and Specifications** (page 258).*

Do not use the following as a coolant substitute:

- Alcohol.
- Methanol.
- Brine.
- Any coolant mixed with alcohol or methanol antifreeze.

Alcohol and other liquids can cause engine damage from overheating or freezing.

Do not add extra inhibitors or non-specified additives to the coolant. These can be harmful and compromise the corrosion protection of the coolant.

Engine and Secondary Cooling System Refill Procedure

The following procedure should be used when refilling the engine or secondary cooling systems after it has been drained or become extremely low:

1. Before you remove the cap, turn the engine off and let it cool.
2. When the engine is cool, wrap a thick cloth around the cap. Slowly turn cap counterclockwise until pressure begins to release.
3. Step back while the pressure releases.
4. When you are sure that all the pressure has been released, use the cloth to turn it counterclockwise and remove the cap.
5. Slowly add prediluted engine coolant to the coolant reservoir until the coolant level is within the minimum and maximum range as listed on the reservoir.
6. Reinstall the pressure relief cap.
7. Start and run the engine at 2000 rpm for 2 minutes.
8. Shut engine off, and remove the pressure relief cap as previously outlined.
9. If required, add prediluted engine coolant to the coolant reservoir until the coolant level is within the minimum and maximum range as listed on the reservoir.
10. **Engine cooling system:** Repeat Step 5 until the coolant level has stabilized (is no longer dropping after each step) and the upper radiator hose at the radiator is warm to the touch (indicating that the engine thermostat is open and coolant is flowing through the radiator).

Maintenance

11. Check the secondary cooling system. Repeat Step 5 until the coolant level has stabilized (is no longer dropping after each step) and the lower passenger side of the secondary radiator is warm to the touch (indicating secondary thermostat is open and coolant is flowing through the entire system).
12. Reinstall the pressure relief cap. Shut the engine off and let it cool.
13. Check the coolant level in the reservoir before you drive your vehicle the next few times.
14. If necessary, add prediluted engine coolant to the coolant reservoir until the coolant level is within the minimum and maximum range as listed on the reservoir. After any coolant has been added, check the coolant concentration.

Recycled Coolant

We do not recommend the use of recycled coolant as an approved recycling process is not yet available.

Dispose of used engine coolant in an appropriate manner. Follow your community's regulations and standards for recycling and disposing of automotive fluids.

Severe Climates

If you drive in extremely cold climates:

- It may be necessary to increase the coolant concentration above 50%.
- A coolant concentration of 60% provides improved freeze point protection. Coolant concentrations above 60% decrease the overheat protection characteristics of the coolant and may cause engine damage.

If you drive in extremely hot climates:

- You can decrease the coolant concentration to 40%.
- Coolant concentrations below 40% decrease the freeze and corrosion protection characteristics of the coolant and may cause engine damage.

Vehicles driven year-round in non-extreme climates should use prediluted engine coolant for optimum cooling system and engine protection.

Checking Coolant Corrosion Inhibitor Additive Strength

At specific mileage intervals as listed in the scheduled maintenance information chapter, the coolant corrosion inhibitor additive should be checked. An information message may display in the optional information display at this time. The purpose of checking is to verify the correct engine coolant concentration (freeze point protection) and corrosion inhibitor additive level (strength) of the coolant for maximum engine performance and protection.

Three products are available to confirm the life and health of the coolant, one tool, a test kit and a coolant inhibitor additive:

Maintenance

- **Robinair® Coolant and Battery Refractometer 75240** – Recommended refractometer to test coolant concentration. (Rotunda tool part number: ROB75240).
- **Rotunda 328-R071-ELC (Antifreeze Coolant ELC Contamination Kit)** – Evaluates the corrosion inhibitor additive strength. Note the first step is to verify the vehicle's coolant concentration is in the correct range of 40 – 60%. Coolant concentrations outside this range will not provide valid test results. If the report results in a pass, for example the cooling system does not show excessive contamination, the corrosion inhibitor additive strength is sufficient, and no action is required. If the report results as insufficient (does not pass), the corrosion inhibitor additive strength of the coolant is too low. If the engine cooling system corrosion inhibitor additive strength is low, add 47 fl oz (1.4 L) of Motorcraft Specialty Orange Engine Coolant Revitalizer. If the secondary cooling system corrosion inhibitor additive strength is low, add 16 fl oz (0.47 L) of Motorcraft Specialty Orange Engine Coolant Revitalizer.
- **Motorcraft Specialty Orange Engine Coolant Revitalizer** – Additive to boost the corrosion inhibitor level based upon the test results of the Antifreeze Coolant ELC Contamination Kit. The Revitalizer may be added two times over the life of the coolant. If additional dosages are required, the cooling system must be flushed and refilled per the instructions in the Workshop Manual.

Make sure to follow the proper coolant and additive specifications. See **Capacities and Specifications** (page 252).

Coolant Change

At specific mileage intervals, as listed in the scheduled maintenance information, the coolant should be changed. The information display may display a message to change coolant at this time. Add prediluted coolant approved to the correct specification. See **Capacities and Specifications** (page 252).

Engine-driven Cooling Fan (Fan Clutch)

Your vehicle may have an engine driven cooling fan drive (also called a fan clutch). This fan drive changes the fan speed to match the vehicle's changing cooling air flow requirements. Fan speed, fan noise level and fuel consumption all will increase based on the driving conditions that include trailer towing, hill climbing, heavy loads, high speed and high ambient temperature, individually or in combination.

The fan drive is designed to provide the minimum fan speed (and resulting minimum fan noise and fuel consumption) required to meet the ever changing vehicle cooling air flow requirements. You will hear the amount of fan noise increasing and decreasing as the engine power requirements and vehicle driving conditions change as you drive. This is to be expected as being normal to the operation of your vehicle. High levels of fan noise might also be heard when your engine is first started, and should normally decrease after driving for a short time.

AUTOMATIC TRANSMISSION FLUID CHECK

The transmission does not consume fluid. However, the fluid level should be checked if the transmission is not working properly, for example if the transmission slips, shifts slowly or if there are signs of fluid loss.

Maintenance

The transmission fluid and filter on your vehicle must be replaced at the specified service interval. See **Scheduled Maintenance** (page 316).

Automatic transmission fluid expands when warmed. To check the fluid level consistently and accurately, do the following:

1. Drive the vehicle until it reaches normal operating temperature. This may take up to 20 mi (30 km).
2. Make sure that your vehicle is on level ground.
3. With the engine running, parking brake engaged and your foot on the brake pedal, move the gearshift lever through all of the gear ranges. Allow sufficient time for each gear to engage.
4. Make sure the parking brake is on. Make sure the transmission is in park (P) or neutral (N) and leave the engine running.
5. Open the hood. See **Opening and Closing the Hood** (page 181).
6. Remove the dipstick and wipe it with a clean, lint-free cloth. See **Under Hood Overview** (page 183).
7. Replace the dipstick and remove it again to check the fluid level.
8. If the fluid level is correct, replace the dipstick and make sure it is fully seated.

Note: *If the fluid level is between the maximum and minimum marks, the fluid level is acceptable. Do not add fluid.*

Transmission Fluid Level

Low Fluid Level



E163740

If the fluid level is at or below the minimum mark, add fluid immediately. See **Capacities and Specifications** (page 258).

Note: *If there is no indication of fluid on the dipstick, have your vehicle checked immediately.*

Correct Fluid Level



E163742

Make sure that the fluid level is between the maximum and minimum marks.

Maintenance

High Fluid Level



E163744

Do not add fluid further than the maximum mark. Fluid levels above the maximum mark may cause shift or engagement concerns and possible damage.

Note: *High fluid levels can be caused by an overheating condition.*

Adding Transmission Fluid

Do not use supplemental transmission fluid additives, treatments or cleaning agents. The use of these materials may affect transmission operation and result in damage to internal transmission components and could lead to transmission damage that may not be covered by the vehicle Warranty.

Use only recommended transmission fluid that meets our specifications. See **Capacities and Specifications** (page 258).





Note: *Use of a non-approved automatic transmission fluid may cause internal transmission component damage.*

If necessary, add fluid in 8 fl oz (250 ml) increments through the filler tube until the level is correct.

If an overfill occurs, excess fluid should be removed, have your vehicle checked as soon as possible.

BRAKE FLUID CHECK

WARNINGS

-  Do not use any fluid other than the recommended brake fluid as this will reduce brake efficiency. Use of incorrect fluid could result in the loss of vehicle control, serious personal injury or death.
-  Only use brake fluid from a sealed container. Contamination with dirt, water, petroleum products or other materials may result in brake system damage or failure. Failure to adhere to this warning could result in the loss of vehicle control, serious personal injury or death.
-  Do not allow the fluid to touch your skin or eyes. If this happens, rinse the affected areas immediately with plenty of water and contact your physician.
-  A fluid level between the **MAX** and **MIN** lines is within the normal operating range and there is no need to add fluid. A fluid level not in the normal operating range could compromise the performance of the system. Have your vehicle checked immediately.

Maintenance



E170684

To avoid fluid contamination, the reservoir cap must remain in place and fully tight, unless you are adding fluid.

Only use fluid that meets Ford specifications. See **Capacities and Specifications** (page 252).

POWER STEERING FLUID CHECK

Check the power steering fluid. See **Scheduled Maintenance** (page 316). If adding fluid is necessary, use only MERCON LV ATF

Check the fluid level when it is at ambient temperature.

1. Check the fluid level in the reservoir. It should be between the MIN and MAX range. Do not add fluid if the level is within this range.
2. If the fluid level is low, add fluid to bring the fluid level up to between the MIN and MAX range.
3. Switch the engine on.

4. While the engine idles, turn the steering wheel left and right several times.
5. Switch the engine off.
6. Recheck the fluid level in the reservoir. Do not add fluid if the level is between the MIN and MAX range.
7. If the fluid is low, add the proper type of fluid in small amounts, continuously checking the level until it is between the MIN and MAX range. See **Capacities and Specifications** (page 258). Be sure to put the cap back on the reservoir.

WASHER FLUID CHECK

WARNING



If you operate your vehicle in temperatures below 40°F (5°C), use washer fluid with antifreeze protection. Failure to use washer fluid with antifreeze protection in cold weather could result in impaired windshield vision and increase the risk of injury or accident.

Add fluid to fill the reservoir if the level is low. Only use a washer fluid that meets Ford specifications. See **Capacities and Specifications** (page 252).

State or local regulations on volatile organic compounds may restrict the use of methanol, a common windshield washer antifreeze additive. Washer fluids containing non-methanol antifreezes should be used only if they provide cold weather protection without damaging the vehicle's paint finish, wiper blades or washer system.

Maintenance

DRAINING THE FUEL FILTER WATER TRAP - 6.7L DIESEL

Your vehicle is equipped with a diesel fuel conditioner module located on the frame-rail under the driver-side floorboard near the transmission.



You should drain water from the module assembly whenever the warning light comes on and the message center directs you to drain the water separator. This will occur when approximately 8.45 fl oz (250 ml) of water accumulates in the module. If you allow the water level to exceed this level, the water may pass through to the engine and may cause fuel injection equipment damage.

Draining the Diesel Fuel Conditioner Module (DFCM)

WARNING



Your vehicle must be stopped with the engine off when draining the Diesel Fuel Conditioner Module. Fuel may ignite if the separator is drained while the engine is running or vehicle is moving.

Note: If you drain the diesel fuel conditioner module while the system is running air will enter into the fuel system. The engine will not operate properly if air enters the system.

Note: With fuel tank levels above 3/4 tank it may be necessary to loosen the bowl three turns before opening the drain. This will actuate an anti-siphon valve at the fuel and water separator inlet and prevent the fuel from siphoning out of the tank.

Note: A loose drain valve can allow air to enter the fuel system and cause drivetrain issues. The engine will not operate properly. Be sure that you fully tighten the drain valve.

1. Stop your vehicle and shut off the engine.
2. Locate the diesel fuel conditioner module and place an appropriate container under the drain port.



E163360

3. Rotate the drain counterclockwise until the O-ring is visible. Allow the diesel fuel conditioner module to drain for approximately 25 seconds or until clean fuel is observed. Rotate the drain clockwise to tighten it. If no liquid drains, there may be a clog in the drain. Have the conditioner module serviced by an authorized dealer.
4. Make sure that you fully tighten the drain valve and then remove the container from under your vehicle.
5. Restart the engine. If the WATER IN FUEL DRAIN FILTER or WATER IN FUEL DRAIN FILTER SEE MANUAL message and light continues to illuminate, have the fuel system checked and repaired.

FUEL FILTER - 6.8L

Your vehicle is equipped with a lifetime fuel filter that is integrated with the fuel tank. Regular maintenance or replacement is not needed.

Maintenance

CHANGING THE 12V BATTERY

WARNINGS



This vehicle may be equipped with more than one battery, removal of cable from only one battery does not disconnect the vehicle electrical system. Be sure to disconnect cables from all batteries when disconnecting power. Failure to do so may cause serious personal injury or property damage.



Batteries normally produce explosive gases which can cause personal injury. Therefore, do not allow flames, sparks or lighted substances to come near the battery. When working near the battery, always shield your face and protect your eyes. Always provide proper ventilation.



When lifting a plastic-cased battery, excessive pressure on the end walls could cause acid to flow through the vent caps, resulting in personal injury and damage to the vehicle or battery. Lift the battery with a battery carrier or with your hands on opposite corners.



Keep batteries out of reach of children. Batteries contain sulfuric acid. Avoid contact with skin, eyes or clothing. Shield your eyes when working near the battery to protect against possible splashing of acid solution. In case of acid contact with skin or eyes, flush immediately with water for a minimum of 15 minutes and get prompt medical attention. If acid is swallowed, call a physician immediately.

Note: *If your battery has a cover/shield, make sure it is reinstalled after the battery has been cleaned or replaced.*

Note: *Battery posts, terminals and related accessories contain lead and lead compounds. Wash hands after handling.*

Note: *Electrical or electronic accessories or components added to the vehicle by the dealer or the owner may adversely affect battery performance and durability.*

Your vehicle is equipped with a Motorcraft maintenance-free battery which normally does not require additional water during its life of service.

For longer, trouble-free operation, keep the top of the battery clean and dry. Also, make certain the battery cables are always tightly fastened to the battery terminals.

If you see any corrosion on the battery or terminals, remove the cables from the terminals and clean with a wire brush. You can neutralize the acid with a solution of baking soda and water.

It is recommended that the negative battery cable terminal be disconnected from the battery if you plan to store your vehicle for an extended period of time.

Because your vehicle's engine is electronically controlled by a computer, some control conditions are maintained by power from the battery. When the battery is disconnected or a new battery is installed, the engine must relearn its idle and fuel trim strategy for optimum driveability and performance. To begin this process

1. With the vehicle at a complete stop, set the parking brake.
2. Put the gearshift in park (P) or neutral (N) and turn off all accessories.
3. Start the engine. Run the engine until it reaches normal operating temperature.
4. Allow the engine to idle for at least one minute.
5. Turn the air conditioning (if equipped) on and allow the engine to idle for at least one minute.

Maintenance

6. Release the parking brake. With your foot on the brake pedal and with the air conditioning on, put the vehicle in drive (D) and allow the engine to idle for at least one minute.
 - If you do not allow the engine to relearn its idle trim, the idle quality of your vehicle may be adversely affected until the idle trim is eventually relearned.
7. Drive the vehicle to complete the relearning process
 - The vehicle may need to be driven 10 mi (16 km) or more to relearn the idle and fuel trim strategy along with the ethanol content for flexible fuel vehicles.

If the battery has been disconnected or a new battery has been installed, the clock and radio settings must be reset once the battery is reconnected.

Always dispose of automotive batteries in a responsible manner. Follow your local authorized standards for disposal. Call your local authorized recycling center to find out more about recycling automotive batteries.

Battery Management System (If Equipped)

The battery management system (BMS) monitors battery conditions and takes actions to extend battery life. If excessive battery drain is detected, the system may temporarily disable certain electrical features to protect the battery. Those electrical accessories affected include the rear defrost, heated/cooled seats, climate control fan, heated steering wheel, audio and navigation system. A message may be shown in the information displays to alert

the driver that battery protection actions are active. These messages are only for notification that an action is taking place, and not intended to indicate an electrical problem or that the battery requires replacement.

Electrical accessory installation

To ensure proper operation of the BMS, any electrical devices that are added to the vehicle should not have their ground connection made directly at the negative battery post. A connection at the negative battery post can cause inaccurate measurements of the battery condition and potential incorrect system operation.

Note: *Electrical or electronic accessories added to the vehicle by the dealer or the owner may adversely affect battery performance and durability, and may also affect the performance of other electrical systems in the vehicle.*

When a battery replacement is required, the battery should only be replaced with a Ford recommended replacement battery which matches the electrical requirements of the vehicle. After battery replacement, or in some cases after charging the battery with the external charger, the BMS requires eight hours of vehicle sleep time (key off with doors closed) to relearn the new battery state of charge. Prior to relearning the state of charge, the BMS may disable electrical features (to protect the battery) earlier than normal.

Maintenance

CHECKING THE WIPER BLADES



E142463

Run the tip of your fingers over the edge of the blade to check for roughness.

Clean the wiper blades with washer fluid or water applied with a soft sponge or cloth.

CHANGING THE WIPER BLADES

You can manually move the wiper arms when the ignition is off. This allows for ease of blade replacement and cleaning under the blades.



E165804

1. Pull the wiper blade and arm away from the glass.



E165794

2. Release the wiper blade lock (A) and separate the wiper blade from the wiper arm.
3. Install in the reverse order.

Note: Make sure that the wiper blade locks into place. Lower the wiper arm and blade back on the windshield. The wiper arms will automatically return to their normal position when you turn the ignition on.

- Replace wiper blades at least once per year for optimum performance.
- You can improve poor wiper quality by cleaning the wiper blades and the windshield.

ADJUSTING THE HEADLAMPS

Vertical Aim Adjustment

The headlamps on your vehicle are properly aimed at the assembly plant. If your vehicle has been in an accident, the alignment of your headlamps should be checked by your authorized dealer.

Maintenance

Headlamp Aiming Target

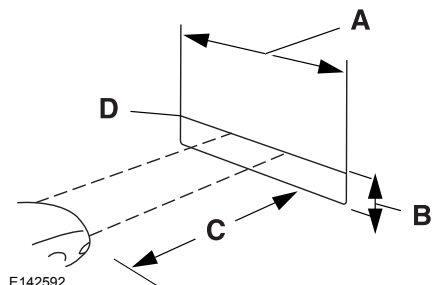

- A 8 feet (2.4 meters)
- B Center height of lamp to ground
- C 25 feet (7.6 meters)
- D Horizontal reference line



E142465

4. On the wall or screen you will observe a flat zone of high intensity light located at the top of the right hand portion of the beam pattern. If the top edge of the high intensity light zone is not at the horizontal reference line, the headlamp will need to be adjusted.

Vertical Aim Adjustment Procedure

1. Park the vehicle directly in front of a wall or screen on a level surface, approximately 25 feet (7.6 meters) away.
2. Measure the height of the headlamp bulb center from the ground and mark an 8 foot (2.4 meter) horizontal reference line on the vertical wall or screen at this height.

Note: To see a clearer light pattern for adjusting, you may want to block the light from one headlamp while adjusting the other.

3. Turn on the low beam headlamps to illuminate the wall or screen and open the hood.



E163806

5. Locate the vertical adjuster on each headlamp. Using a Phillips #2 screwdriver, turn the adjuster either clockwise or counterclockwise in order to adjust the vertical aim of the headlamp.
6. Repeat steps 3 thru 5 to adjust the other headlamp.
7. Close the hood and turn off the lamps.

Horizontal Aim Adjustment

Horizontal aim is not required for this vehicle and is not adjustable.

Maintenance

REMOVING A HEADLAMP



E163822

1. Remove the four bolts from the headlamp assembly.
2. Pull the assembly straight out disengaging one snap clip from the fender.
3. Disconnect the electrical connector by squeezing the release tab and pushing the connector forward, then pulling it rearward.

CHANGING A BULB

WARNING



Bulbs can become hot. Let the bulb cool down before removing it. Failure to do so could result in personal injury.

Headlamp bulbs must be marked with an authorized D.O.T. marking for North America to make sure they have the proper lamp performance, light brightness, light pattern and safe visibility.

Install in the reverse order unless otherwise stated.

Headlamp Bulbs

1. Switch all of the lamps and the ignition off.

2. Remove the headlamp. See **Removing a Headlamp** (page 207).
3. Release the clip and remove the bulb.

Note: Do not touch the bulb glass.

Note: If the bulb is accidentally touched, it should be cleaned with rubbing alcohol before being used.

Front Clearance and Identification Lamp (If Equipped)



E163825

1. Switch all of the lamps and the ignition off.
2. Remove the screw and lens from the lamp assembly.
3. Press the bulb in and turn the bulb counterclockwise to remove it.

Maintenance

Brake Lamp, Rear Lamp, Rear Direction Indicator, License Plate Lamp and Reverse Lamp



E163828

1. Switch all of the lamps and the ignition off.

2. Remove the four screws and the lamp lens from lamp assembly.
3. Remove the bulb by pulling it straight out.

BULB SPECIFICATION CHART

Replacement bulbs are specified in the chart below. Headlamp bulbs must be marked with an authorized "D.O.T." for North America and an "E" for Europe to ensure lamp performance, light brightness and pattern and safe visibility. The correct bulbs will not damage the lamp assembly or void the lamp assembly warranty and will provide quality bulb illumination time.

Function	Number of Bulbs	Trade name
*Headlamps	2	H13/9008
*Side marker lamp - front	2	W5W
*Park/Turn lamp- front	2	3157NA
Tail/stop/turn/side marker	2	3157
Reverse	2	3157
License plate lamp	—	194
High-mount brake lamp	1	912
Map lamp	2	12V6W
Dome/reading lamps	3	578
Interior visor lamp	2	2825
Mirror turn signal	2	2825
Mirror clearance lamp		2825
Front clearance lamps and front identification lamps	5	194

Note: To replace instrument panel lights, see an authorized dealer

Maintenance

CHANGING THE ENGINE AIR FILTER - 6.8L

WARNING



To reduce the risk of vehicle damage and personal burn injuries, do not start your engine with the air cleaner removed and do not remove it while the engine is running.

Note: Operating your vehicle in heavy snowfall or extreme rain conditions may allow excessive amounts of snow or water into the air intake system. This could plug or soak the air filter that could cause the engine to lose power or shut down.

When replacing the air filter element, use a Motorcraft® air filter element. See **Motorcraft Parts** (page 254).

Note: Failure to use the correct air filter element may result in severe engine damage. Resulting component damage may not be covered by the vehicle Warranty.

Change the air filter element at the correct interval. See **Scheduled Maintenance** (page 316).

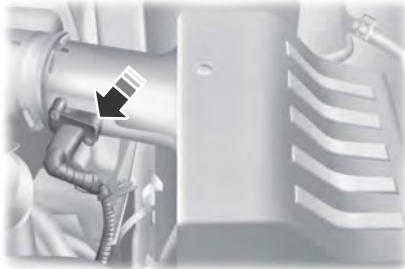

E163755

1. Locate the mass air flow sensor electrical connector on the air outlet tube. Disconnect the mass air flow sensor electrical connector.

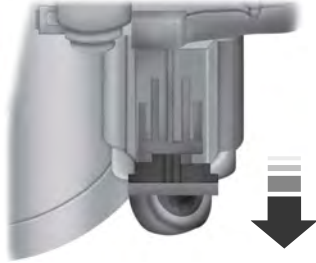

E163756

2. Reposition the locking clip on the connector (connector shown below for clarity), squeeze the connector and pull it off of the air outlet tube.

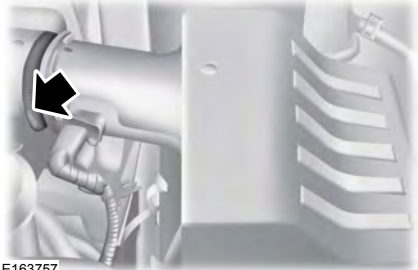

E163757

3. Clean the area from around the air tube to the air cover connection to prevent debris from entering the system. Next, loosen the bolt on the air tube clamp so the clamp is no longer snug to the air tube. It is not necessary to completely remove the clamp.
4. Pull the air tube off from the air cleaner housing.

Maintenance

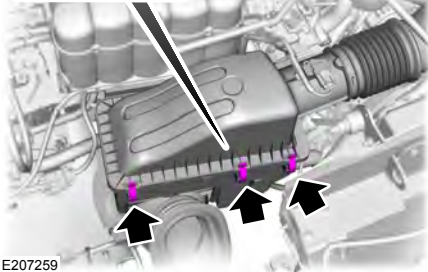

5. Remove the clips that secure the air filter housing cover. Push the air filter housing cover toward the center of the vehicle and up slightly to release it.
6. Remove the air filter element from the air filter housing.
7. Install the new air filter element.
8. Engage the clips to secure the air filter housing cover to the air filter housing. Be careful not to crimp the filter element edges between the air filter housing and cover. Ensure that you align the tabs on the edge properly into the slots.
9. Slip the air tube onto the air filter housing and tighten the air-tube clamp bolt snugly. Do not over tighten air-tube clamp bolt.

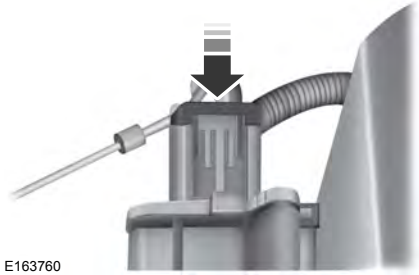

10. Reconnect the mass air flow sensor electrical connector to the outlet tube. Make sure the locking tab on the connector is in the locked position (connector shown from below for clarity).

CHANGING THE ENGINE AIR FILTER - 6.7L DIESEL

Air Filter Restriction Gauge

WARNING



To reduce the risk of vehicle damage and/or personal burn injuries do not start your engine with the air filter removed and do not remove it while the engine is running.

Note: *Operating your vehicle in heavy snowfall or extreme rain conditions may allow excessive amounts of snow or water into the air intake system. This could plug or soak the air filter that could cause the engine to lose power or shut down.*

Maintenance



E163372

The restriction gauge, located on the upper housing of the air filter assembly, measures the vacuum inside the air filter. The more the air filter is restricted (dirty, clogged), the higher the vacuum reading.

Check the air filter restriction gauge whenever you open the hood to perform general engine maintenance or at least every 7,500 miles (12,000 km). If you operate your vehicle in extremely dusty conditions, check and reset the gauge at least every 500 miles (800 km), or two weeks, whichever comes first. Change the air filter when the restriction gauge reads near the **change filter** line and the gauge is yellow. If you allow the restriction gauge to reach maximum restriction you can affect your engine performance and fuel economy.

Note: Do not blow out the air filter element with compressed air since the compressed air could damage the filter paper.

Note: Do not rely on filter appearance alone. A filter which appears to be dirty may actually have several thousand miles (kilometers) of life remaining.



E163373

After installation of the new filter element, reset the gauge by pressing the reset button on top of the gauge.

The following actions are recommended after operating the vehicle up to 200 miles (320 km) in heavy snowfall or extreme rain:

- Snow: At the earliest opportunity, open the hood and clear all the snow and ice from the air filter housing inlet (do NOT remove the foam filter) and reset the air filter restriction gauge.
- Extreme rain: The air filter will dry after about 15–30 minutes at highway speeds. At the earliest opportunity, open the hood and reset the air filter restriction gauge.

Air Filter Replacement

When replacing the air filter element, use a Motorcraft® air filter element. See **Motorcraft Parts** (page 255).

Note: Failure to use the correct air filter element may result in severe engine damage.

Maintenance

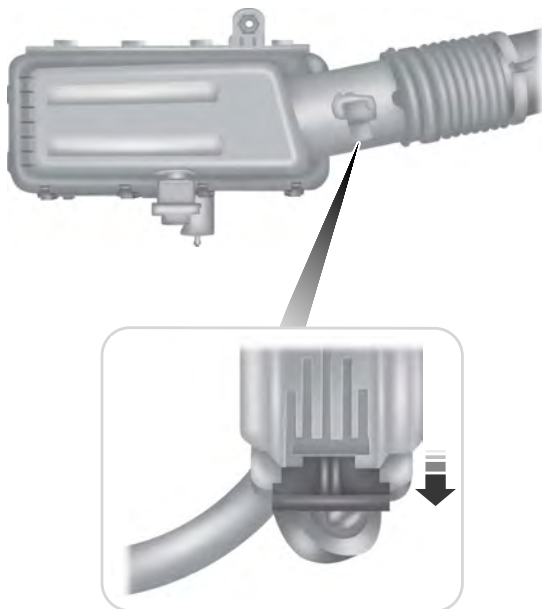

E163374

1. Locate the mass airflow sensor electrical connector on the air inlet tube. This connector will need to be unplugged. Unlock the locking clip on the connector, then squeeze and pull the connector off the air inlet tube.

Maintenance

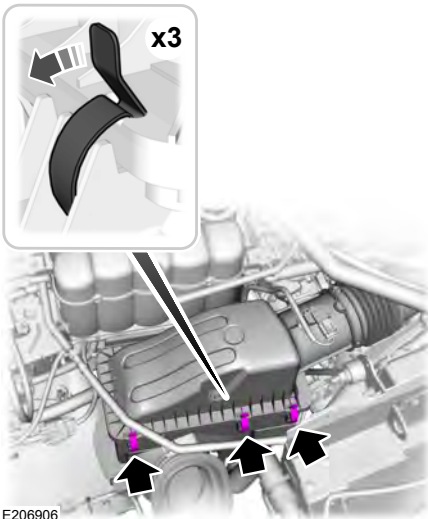

2. Remove the clips that secure the air filter housing cover. Push the air filter cover forward (away from you) and up slightly to release it.
3. Remove the air filter element from the air filter housing.



4. Remove and install a new foam filter if needed according to the service interval indicated in the scheduled maintenance information in this guide. If you do not replace the foam filter, be sure the existing foam filter is in place.



5. Install a new air filter element. Be sure that the groove seal on the pleated paper filter traps both sides of the vertical partition of the air box.
6. Engage the clips to secure the air filter housing cover to the air filter housing. Be careful not to crimp the filter element edges between the air filter housing and cover. Ensure that you align the tabs on the edge properly into the slots.
7. Reconnect the mass airflow sensor electrical connector to the inlet tube. Make sure the locking tab on the connector is in the locked position.

Air Purge Procedure

Turn the key on for 30 seconds, and then turn off. Repeat the procedure six times.

Maintenance

CHANGING THE ENGINE-MOUNTED AND DIESEL FUEL CONDITIONER MODULE FUEL FILTERS

WARNING



Do not dispose of fuel in the household refuse or the public sewage system. Use an authorized waste disposal facility.

Your vehicle has two fuel filters. The first filter mounts on top of the engine on the left-hand side. The second filter is inside the diesel fuel conditioner module. The module is mounted between the outboard side of the fuel tank and the frame rail.

Note: *The module is at the front of the fuel tank or at the front of the aft-axle fuel tank on some models.*

Regular fuel filter changes are an important part of engine maintenance; failing to keep with the scheduled maintenance could lead to engine performance issues and fuel injection system damage. See **Scheduled Maintenance** (page 316).

Use only recommended service parts conforming to specifications. See **Motorcraft Parts** (page 255).

Note: *Using fuel that has high levels of impurities may require more frequent filter replacements than the service interval specifies.*

Diesel Fuel Conditioner Module Filter

Removal

1. Access the underside of your vehicle.

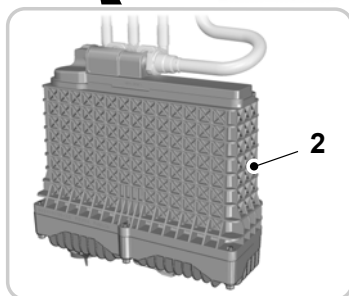
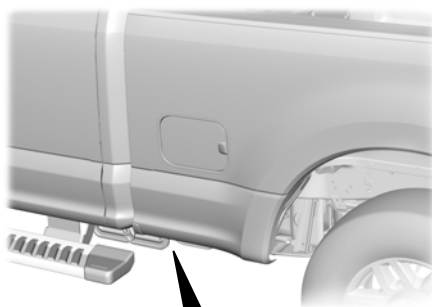

E226475

2. The diesel fuel conditioner module is on the left-hand frame rail.

Maintenance

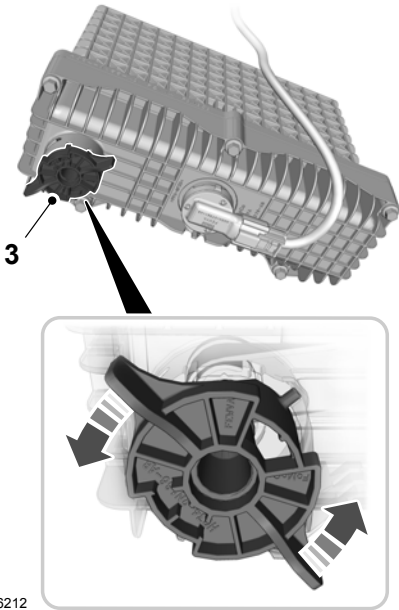

E226212

3. Drain the diesel fuel conditioner module. Turn the drain plug counterclockwise until it stops. Do not use any tools to loosen the drain plug. Drain the filter, approximately 0.5 gal (2 L), into an appropriate container. Do not re-use the fuel drained from the module.

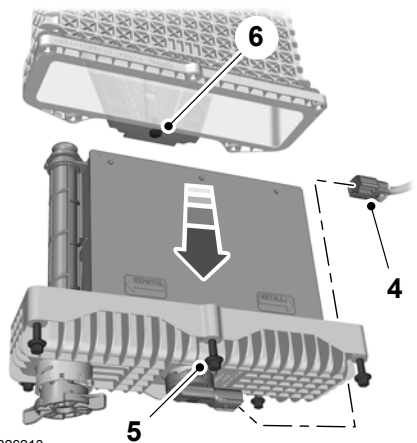

E226213

4. Disconnect the electrical connector.
5. Fully loosen the bolts securing the lower portion of the diesel fuel conditioner module housing.

Note: Do not fully remove the bolts from the lower portion of the diesel fuel conditioner module housing.

6. Remove the lower portion of the diesel fuel conditioner module housing.

Maintenance

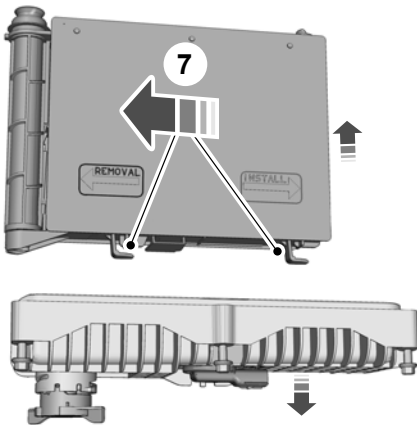

E226563

7. Slide the filter element toward the drain plug to disengage the securing clips.

Installation

1. Slide the filter element into the housing and fully engage the securing clips.
2. Install the lower portion of the housing. Tighten the bolts until you feel a strong resistance. Maximum torque 7 lb.ft (9 Nm).
3. Connect the electrical connector.
4. Tighten the drain plug, turn it clockwise until it stops and you feel a strong resistance. Do not use any tools to tighten the drain plug.
5. Switch the ignition on for 30 seconds and then switch the ignition off. Repeat this operation six times in a row to purge any trapped air from the fuel system.

Engine-mounted Fuel Filter

Although the fuel system is not fully pressurized when the vehicle is off, some residual pressure may remain in the fuel system since it can take some time for the pressure to completely bleed off. Therefore, we recommend you place an absorbent cloth below the filter connectors to absorb any fuel that may drain.

The engine-mounted fuel filter is a plastic disposable cartridge.

Removal

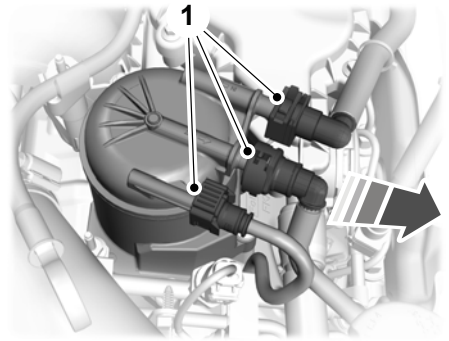

E226215

1. Disconnect the fuel lines by squeezing the connector tabs and pulling the lines straight off.

Maintenance

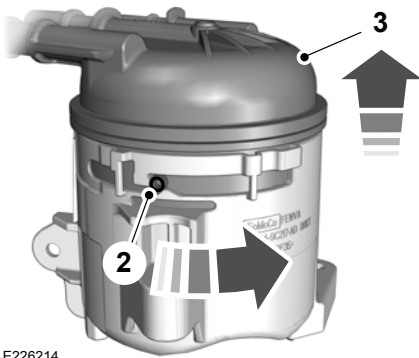

E226214

2. Rotate the filter fully counterclockwise until the peg is at the far end of the slot.
3. Pull the filter straight up from the bracket and discard the filter.

Installation

1. Install the new filter into the filter bracket. Turn the filter clockwise to lock it in place.
2. Reconnect the fuel lines.
3. Switch the ignition on for 30 seconds and then switch the ignition off. Repeat this operation six times in a row to purge any trapped air from the fuel system.

ELECTRICAL SYSTEM INSPECTION

Periodically inspect electrical connectors on the outside of the cab and on the engine and frame for corrosion and tightness. Exposed terminals, such as the fuel sender, cranking motor, alternator and feed-through studs, should be cleaned and

re-coated with a lubricant sealing grease such as Motorcraft Silicone Brake Caliper Grease and Dielectric Compound XG-3, or equivalent. This should include the ground cable connector for batteries, engine and cab as well as the jump-starting stud.

Accessory Feed Connections

Vehicle electrical systems are complex and often include powertrain components, such as engine and transmission controls, instrument panels and ABS. While most systems operate on battery voltage (12 volts), some systems can be as high as 90 volts or as low as five volts. See the Electrical Circuit Diagram Manuals, available from your vehicle's manufacturer, to make sure that any extra body lights and accessory connections to circuits are both appropriate and not overloaded. Do not make modifications to any vehicle control system without first contacting an authorized dealer.

AIR INDUCTION SYSTEM INSPECTION

WARNING



When performing maintenance to any turbocharged engine with engine air inlet piping disconnected, keep loose clothing, jewelry and long hair away from the engine air inlet piping. A turbocharger compressor air inlet protective shield should be installed over the turbocharger air inlet to reduce the risk of personal injury or death.

Perform a complete inspection of the air induction system annually.

Maintenance

In areas where road salt is used, disassemble the joints of each aluminum component and inspect for salt build-up and presence of chlorine that can cause aluminum particles to flake off and enter the engine combustion chambers. If evidence of corrosion is found (usually at the pipe connections), use a wire brush to clean the inside of the pipes and inside the rubber hoses.

If pitting is evident at the joint ends of the intake pipes, use Motorcraft Silicone Gasket and Sealant TA-30 to seal the joints. Make sure no excess material, which can pull into the engine, is on the inside of the pipes. If the service condition of the pipes, hoses or clamps is questionable, replace the defective part(s).

Make sure to clean all dust and debris out of the pipes and couplings with a clean, damp rag before reassembly.

Chassis-mounted Charge Air Cooler

Visually inspect the core assembly for debris and clogging of external fins with the engine off.

Before engine operation, remove any debris blocking the core.

- Turbocharger-to-charge air cooler.
- Charge air cooler-to-intake manifold pipe.
- Mounting bracket.
- Chassis-mounted charge air cooler core.

Inspect air intake piping:

- Check for accumulation of salt deposits (where applicable). If present, disassemble and clean the complete air intake piping system. If pitting is evident on the intake piping, use Motorcraft Silicone Gasket and Sealant TA-30 to seal joints against leakage.
- Check for loose hoses and clamps.

- Check for ruptured or collapsed hoses.
- Check air cleaner housing for cracks.

EXHAUST SYSTEM INSPECTION

Note: *If your vehicle is equipped with a catalytic converter or muffler, do not blend waste oil with diesel fuel. Operate only on ultra-low sulfur (less than 15 parts per million sulfur) diesel fuel with a cetane value of 45 or higher.*

If your diesel engine is equipped with a catalytic converter, it is important to review the maintenance schedule to make sure proper functioning of the catalytic converter. Also, take precautions not to damage the catalytic converter when servicing your engine or storing your vehicle.

Maintenance

BRAKE SYSTEM INSPECTION

WARNING



Always wear a respirator approved by the National Institute of Occupational Studies of Health (NIOSH) or Mine Safety and Appliance (MSA) during all brake service procedures. Wear the respirator from removal of the wheels through assembly.

Never use compressed air or dry brushing to clean brake parts or assemblies.

Clean brake parts and assemblies in open air. During assembly, carefully place all parts on the floor to avoid getting dust in the air. Use an industrial vacuum cleaner with a HEPA filter system to clean dust from the brake drums, backing plates and other brake parts. After using the vacuum, remove any remaining dust with a rag soaked in water and wrung until nearly dry.

Never use compressed air or dry sweeping to clean the work area. Use an industrial vacuum cleaner with a HEPA filter system and rags soaked in water and wrung until nearly dry. Dispose of used rags with care to avoid getting dust in the air. Use an approved respirator when emptying vacuum cleaners and handling used rags.

Worker clean-up: Wash your hands before eating, drinking or smoking. Vacuum your work clothes after use and then launder them separately, without shaking them, to prevent fiber dust getting into the air.

Your vehicle is equipped with non-asbestos brake linings. However, exposure to excessive amounts of brake material (whether asbestos or non-asbestos, fiberglass, mineral wool, aramid or carbon) may be a serious health hazard.

Air Brakes

WARNING



Do not manually adjust the automatic slack adjusters to correct excessive push rod stroke as it may result in reduced brake effectiveness and a vehicle crash. Excessive push rod stroke indicates that a problem exists with the automatic adjuster, with the installation of the adjuster, or with foundation brake components that manual adjustment does not remedy. Seek service from a qualified facility for excessive push rod stroke.

Inspection and Adjustment

Establish a regular schedule for periodic cleaning, lubrication and adjustment inspection based on vehicle use. Exact maintenance intervals are difficult to predetermine due to vehicle applications and operating conditions. If you are uncertain of the proper schedule for your vehicle, contact an authorized dealer.

Regular inspections should include:

- Periodic checking (every service interval) of push rod travel or brake adjustment. This is essential for effective braking. Brake chamber push rods on original equipment chambers now incorporate an orange paint marker near the base of the push rod

Maintenance

as a stroke indicator to aid in adjustment checks. If the push rod is clean and the brakes are out of adjustment, you can see the orange marker protruding from the chamber when the brakes are applied.

- Checking the brake lining (every service interval). When brake linings or blocks wear within 0.063 in (1.6 mm) they must be replaced.
- Periodic checking (every service interval) of the air compressor filter. Check the filter minder and when the indicator is near or on the red line marked **Service**, replace the filter and reset the service filter minder.

Do not back off or disconnect the front brakes so that they are less effective, letting the rear brakes do all the stopping of your vehicle. Do not overlook the brakes on the trailer either. Brake condition on the trailer is just as important as the tractor. Proper brake balance on trucks and tractor-trailers is essential for effective braking.

Once a year, inspect the entire brake system:

- Rubber components for deterioration. A qualified technician should inspect these components and replace them as necessary. Replacement intervals vary according to the severity and length of vehicle service.
- Condition of brake drums, brake chambers and slack adjusters.
- System for air leaks.
- Hose or pipes for rust, damage and deterioration.
- Operation of service and parking brakes.

Periodically inspect parts such as air brake chamber diaphragm, air compressor and air cleaner. Replace any parts if you can consider them unserviceable.

Air Dryer

Climactic conditions affect performance of desiccant or after-cooler type air dryers. You must establish a maintenance schedule for each specific operation.

The use of an air dryer on a vehicle does not eliminate the need to drain the air reservoirs periodically.

Inspect for moisture in the air system by opening reservoirs, draincocks or valves and checking for presence of water. The presence of small amounts of water due to condensation is normal and is not an indication that the dryer is not functioning properly.

Replace or rebuild the desiccant cartridge when you determine that the desiccant is contaminated and does not have adequate water absorption capacity. The desiccant change interval may vary. A general recommendation is to replace the desiccant every 12 months (yearly). If experience has shown that extended or shortened life has resulted for a particular installation, then the yearly interval can be increased or decreased accordingly.

Draining the Air Brake Reservoir

WARNING



Failure to drain air brake reservoirs can result in a reduction or loss of braking ability due to fluid accumulation in the reservoir and/or possible freeze-up during cold weather.

Completely drain all the air brake reservoirs daily by opening the draincock at the ends of the tanks. (Where accessible. Pull-chains are used when the drains are undercab or otherwise inaccessible.) Close the draincock after draining. Manually drain

Maintenance

any air tanks equipped with automatic moisture ejector valves, as required, to maintain a dry air system. Contact an authorized dealer if you are unsure of the air reservoir locations or the draining procedure.

Hydraulic Brakes

Establish a regular schedule for periodic cleaning, lubrication and adjustment inspection based on vehicle use. Exact maintenance intervals are difficult to predetermine due to vehicle applications and operating conditions. If you are uncertain of the proper schedule for your vehicle, contact an authorized dealer.

Regular inspections should include:

- Checking the brake lining (every service interval). Establish inspection intervals that provide for lining replacement before damage to the disc occurs. Excessive lining wear may expose the backing plate to the disc causing scoring of the disc faces. A qualified technician should perform this

inspection and keep to instructions provided by the service manual. Hydraulic brake systems are power-assisted. There is a great reduction in braking capabilities without engine assist.

- Proper fluid level. The level should be at the bottom edge of the ring on each reservoir fill port. Do not fill the master cylinder to the top of the reservoir. If fluid level requires attention to maintain a proper master cylinder level, this is an indication of either severe operation (pad wear) or fluid leakage. A more frequent and thorough brake inspection is required.
- Brake lines, hoses and fittings. Repair or replace brake line tubes, hoses or fittings as required. Inspect these components every 4,000 mi (6,000 km) for the following.
 - Lines for kinks, dents, corrosion or rupture.
 - Hoses for abrasions, kinks, soft spots or rupture, collapse, cracks, twists or loose frame supports. When replacing a hose, be sure there is adequate clearance to the hose to avoid an abrasion to the new hose.
 - All connections for leaks.

Driveline Parking Brake

WARNING



Use wheel chocks and exercise caution when inspecting under the vehicle. A vehicle roll-away could result in property damage, personal injury or death.

A qualified technician should adjust the parking brake and keep to the instructions in the service manual.

Maintenance

AXLE INSPECTION

Front Axle

Maintaining the front axle alignment to specifications is very important. A qualified technician should check and maintain the alignment.

Regular inspections should include:

- Toe-in inspection and adjustment (if necessary), particularly with radial tires.
- Checking for proper tightness of axle mounting U-bolt nuts, attaching or mounting bolts and nuts.
- Checking the axle for damage, binding, worn parts and adequate lubrication.
- Checking the kingpins for excessive wear. Also, perform this check during other scheduled maintenance, for example as tire rotation or service, wheel bearing service and alignment. See the workshop manual for proper procedures.

Toe-in

It is essential to maintain correct toe-in and tire pressure for optimum tire wear.

Inspecting steer axle tires in the first 3,000–10,000 mi (5,000–16,000 km) generally shows if tires are wearing normally.

Rapid outside shoulder wear on both tires indicates too much toe-in.

Rapid inside shoulder wear on both tires indicates too much toe-out.

In P&D-type service, there can be a left-to-right steer tire tread life differential up to 40% depending on routes and other variables.

Follow the tire manufacturer's recommended cold inflation pressure for the tire size, load range (ply rating) and steer axle loading typical for their operation (each steer axle tire equals ½ steer axle loading).

Special applications may warrant a setting based on experience with the type of tire operating loads and conditions. Radial tires are more sensitive to toe-in setting than bias ply tires. Fine tuning school bus alignment to line-haul truck standards does not drastically improve tire tread life.

STEERING SYSTEM INSPECTION

WARNING



Failure to maintain the steering system in proper condition can cause reduced steering ability resulting in property damage, personal injury or death.

Note: *Have any steering problems immediately corrected by a qualified service technician.*

Ask your service technician to examine the steering mechanism. Only minor adjustments may be necessary.

Regular inspections should include:

- Checking the tie rod, drag link end clamp bolts and ball joints for proper tightness.
- Checking for installation and spread of cotter pins and tightness of nuts at both ends of the tie rod and drag link.
- Checking that the pitman arm (steering arm at steering gear) mounting is tight and locked. Check system for leaks or hose chafing. Repair immediately, if necessary.

Maintenance

- Maintaining proper steering gear and power steering pump lubricant levels.
- Checking steering column joint bolts and steering linkage, particularly for body-to-chassis clearance.

Steering Column Joint Bolts

As a good maintenance practice, check steering column joint bolt tightness every 60,000 mi (96,000 km) or annually, whichever occurs first. Do not overtighten the bolts.

Hydraulic System

Whenever draining and refilling the power steering's hydraulic system for any reason, bleed air from the system before returning the vehicle to service. Failure to bleed the hydraulic system properly can result in degradation of power system performance.

Consult an authorized dealer who is aware of the proper procedures for filling and bleeding the system.

SUSPENSION SYSTEM INSPECTION

Note: *Do not adjust air suspension height to any setting other than the specified setting. Altering the height setting changes the driveline angle and may result in unwarrantable component damage, such as transmission component damage.*

Verify drive axle air suspension height and height control valve performance at engine oil change intervals.

Periodically check:

- Condition of spring leaves for evidence of fatigue, bending or breakage.
- Condition of suspension mounting brackets and bushings.
- Torque rod mounting fasteners for tightness.

- For proper suspension alignment. Maintain proper alignment at all times.
- U-bolts. After the chassis has been operating under load for 1,000 mi (1,600 km) or six months (whichever comes first), the U-bolt nuts must be re-torqued. Re-torque the U-bolt nuts every 37,000 mi (60,000 km) thereafter. Clean and lubricate the U-bolt and nut threads and seats to make sure a like new condition when re-torquing. See **Spring U-Bolt Check** (page 224).

FRAME AND TOW HOOK INSPECTION

Your vehicle's chassis is manufactured with frame rails of either HSLA steel or heat-treated steel. Handle each in a specific manner to make sure maximum service life. Consult the service manual or an authorized dealer before attempting frame repair or modification.

It is important, particularly on vehicles that use tow hooks frequently, to inspect the front and rear tow hooks for damage or a loose mounting.

REAR AXLE FLUID CHECK

Your rear axle may have an optional synthetic lubricant that allows the use of extended service intervals. A tag on the filler plug identifies the use of the synthetic lubricant.

Only use a lubricant that meets manufacturer specifications. Only use a lubricant that meets manufacturer specifications. Use of a non-approved rear axle lubricant may cause internal axle component damage. See **Capacities and Specifications** (page 258).

Maintenance

Checking the Fluid Level

1. Park your vehicle on level ground.
2. Set the parking brake and shift into position neutral (N) or park (P). Turn the engine off.
3. Clean any dirt from around the axle filler plug.
4. Remove the filler plug and inspect the lubricant level. It should be at the bottom of the filler plug opening.
5. Add lubricant, if necessary, through the filler plug opening.
6. Clean and install the filler plug securely.

Changing the Fluid

Note: Drain the rear axle while the lubricant is warm.

1. Park your vehicle on level ground.
2. Set the parking brake and shift into position neutral (N) or park (P). Turn the engine off.
3. Clean any dirt from around the axle filler and drain plugs.
4. Remove the filler and drain plugs. Drain the lubricant into a suitable container. Dispose of all used automotive fluids in a responsible manner following your local authorized standards.
5. Clean and install the drain plug securely.
6. Add lubricant through the filler plug opening.
7. Clean and install the filler plug securely.

SPRING U-BOLT CHECK

Check and tighten the U-bolt nuts after your vehicle has been operated under load for 1,000 mi (1,600 km) or six months, whichever occurs first.

Thereafter, install new U-bolt nuts and washers every 36,000 mi (58,000 km).

Check and tighten the U-bolt nuts with your vehicle at curb height and unloaded. Inspect the U-bolt threads for rust and debris. Clean the threads if contaminated.

U-bolt Nut Torque

Front Axle

Note: Check and tighten the U-bolt nuts evenly using a criss-cross pattern in the following stages.

Stage	lb.ft (Nm)
1.	40 (60)
2.	90 (125)
3.	170 (225)
4.	240 (325)

Rear Axle

Note: Check and tighten the U-bolt nuts evenly using a criss-cross pattern in the following stages.

Stage	lb.ft (Nm)
1.	60 (75)
2.	90 (125)
3.	170 (225)
4.	240 (325)
5.	320 (440)

Vehicle Care

GENERAL INFORMATION

Your Ford or Lincoln authorized dealer has many quality products available to clean your vehicle and protect its finishes.

Materials

CLEANING PRODUCTS

For best results, use the following products or products of equivalent quality:

Name	Specification
Motorcraft Bug and Tar Remover (U.S.) Motorcraft Dissolvant de goudron et éliminateur d'insectes (Canada) ZC-42 (U.S. & Canada)	-
Motorcraft Custom Bright Metal Cleaner (U.S.) Motorcraft Nettoyant pour métal brillant (Canada) ZC-15 (U.S. & Canada)	-
Motorcraft® Detail Wash (U.S.) Shampooing superfin Motorcraft® (Canada) ZC-3-A (U.S. & Canada)	ESR-M14P4-A
Motorcraft Engine Shampoo and Degreaser Engine Shampoo and Degreaser ZC-20 (U.S.)	-
Engine Shampoo Motorcraft Shampooing pour moteur (Canada) CXC-66-A (Canada)	-
Motorcraft Leather and Vinyl Cleaner (U.S.) Motorcraft Nettoyant pour cuir et vinyle de haute qualité (Canada) ZC-56 (U.S. & Canada)	-
Multi-Purpose Cleaner Motorcraft Nettoyant multi-usage (Canada) CXC-101 (Canada)	-
Motorcraft® Premium Windshield Wash Concentrate with Bitterant (U.S.) Liquide lave-glace de haute qualité Motorcraft® (Canada) ZC-32-B2 (U.S.) CXC-37-A/B/D/F (Canada)	WSS-M14P19-A
Professional Strength Carpet and Upholstery Cleaner (U.S.) Motorcraft Nettoyant professionnel pour sellerie et moquette (Canada) ZC-54 (U.S. & Canada)	-
Motorcraft Spot and Stain Remover Spot and Stain Remover ZC-14 (U.S.)	-
Motorcraft® Ultra-Clear Spray Glass Cleaner (U.S.) Motorcraft Nettoie-vitres de qualité supérieure (Canada) ZC-23 (U.S.) CXC-100 (Canada)	ESR-M14P5-A
Motorcraft® Wheel and Tire Cleaner (U.S.)	-

Vehicle Care

Name	Specification
Nettoyant pour roues et pneus Motorcraft® (Canada) ZC-37-A (U.S. & Canada)	

CLEANING THE EXTERIOR

Wash your vehicle regularly with cool or lukewarm water and a neutral pH shampoo, we recommend Motorcraft Detail Wash.

- Never use strong household detergents or soap, for example dish washing or laundry liquid. These products can discolor and spot painted surfaces.
- Never wash your vehicle when it is hot to the touch, or during strong or direct sunlight.
- Dry your vehicle with a chamois or soft terry cloth towel to eliminate water spotting.
- Immediately remove fuel spillages, bird droppings, insect deposits and road tar. These may cause damage to your vehicle's paintwork or trim over time. We recommend Motorcraft Bug and Tar Remover.
- Remove any exterior accessories, for example antennas, before entering a car wash.

Note: *Suntan lotions and insect repellents can damage painted surfaces. If these substances come in contact with your vehicle, wash the affected area as soon as possible.*

Exterior Chrome Parts

- Apply a high quality-cleaning product to bumpers and other chrome parts. Follow the manufacturer's instructions. We recommend Motorcraft Custom Bright Metal Cleaner.
- Do not apply the cleaning product to hot surfaces. Do not leave the cleaning product on chrome surfaces longer than the time recommended.
- Using other non-recommended cleaners can result in severe and permanent cosmetic damage.

Note: *Never use abrasive materials, for example steel wool or plastic pads as they can scratch the chrome surface.*

Note: *Do not use chrome cleaner, metal cleaner or polish on wheels or wheel covers.*

Exterior Plastic Parts

For routine cleaning we recommend Motorcraft Detail Wash. If tar or grease spots are present, we recommend Motorcraft Bug and Tar Remover.

Stripes or Graphics (If Equipped)

Hand washing your vehicle is preferred however, pressure washing may be used under the following conditions:

- Do not use water pressure higher than 2,000 psi (14,000 kPa).
- Do not use water hotter than 179°F (82°C).
- Use a spray with a 40° wide spray angle pattern.
- Keep the nozzle at a 12 in (305 mm) distance and 90° angle to your vehicle's surface.

Vehicle Care

Note: *Holding the pressure washer nozzle at an angle to the vehicle's surface may damage graphics and cause the edges to peel away from the vehicle's surface.*

Underbody

Flush the complete underside of your vehicle frequently. Keep body and door drain holes free of debris or foreign material.

Under Hood

For removing black rubber marks from under the hood we recommend Motorcraft Wheel and Tire Cleaner or Motorcraft Bug and Tar Remover.

WAXING

Regular waxing is necessary to protect your car's paint from the elements. We recommend that you wash and wax the painted surface once or twice a year.

When washing and waxing, park your vehicle in a shaded area out of direct sunlight. Always wash your vehicle before applying wax.

- Use a quality wax that does not contain abrasives.
- Follow the manufacturer's instructions to apply and remove the wax.
- Apply a small amount of wax in a back-and-forth motion, not in circles.

- Do not allow wax to come in contact with any non-body (low-gloss black) colored trim. The wax will discolor or stain the parts over time.
 - Roof racks.
 - Bumpers.
 - Grained door handles.
 - Side moldings.
 - Mirror housings.
 - Windshield cowl area.
- Do not apply wax to glass areas.
- After waxing, your car's paint should feel smooth, and be free of streaks and smudges.

CLEANING THE ENGINE

Engines are more efficient when they are clean because grease and dirt buildup keep the engine warmer than normal.

When washing:

- Take care when using a power washer to clean the engine. The high-pressure fluid could penetrate the sealed parts and cause damage.
- Do not spray a hot engine with cold water to avoid cracking the engine block or other engine components.
- Spray Motorcraft Engine Shampoo and Degreaser on all parts that require cleaning and pressure rinse clean. In Canada, use Motorcraft Engine Shampoo.
- Never wash or rinse the engine while it is hot or running; water in the running engine may cause internal damage.

Vehicle Care

- Never wash or rinse any ignition coil, spark plug wire or spark plug well, or the area in and around these locations.
- Cover the battery, power distribution box, and air filter assembly to prevent water damage when cleaning the engine.

CLEANING THE WINDOWS AND WIPER BLADES

Car wash chemicals and environmental fallout can result in windshield and wiper blade contamination. Dirty windshield and wipers will result in poor windshield wiper operation. Keep the windshield and wiper blades clean to maintain windshield wiper performance.

To clean the windshield and wiper blades:

- Clean the windshield with a non-abrasive glass cleaner. When cleaning the interior of the windshield, avoid getting any glass cleaner on the instrument panel or door panels. Wipe any glass cleaner off these surfaces immediately.
- For windshields contaminated with tree sap, chemicals, wax or bugs, clean the entire windshield using steel wool (no greater than 0000 grade) in a circular motion and rinse with water.
- Clean the wiper blades with isopropyl rubbing alcohol or windshield washer concentrate.

Note: *Do not use razor blades or other sharp objects to clean or remove decals from the inside of the heated rear window. The vehicle warranty does not cover damage caused to the heated rear window grid lines.*

CLEANING THE INTERIOR

WARNINGS



Do not use cleaning solvents, bleach or dye on the vehicle's safety belts, as these actions may weaken the belt webbing.



On vehicles equipped with seat-mounted airbags, do not use chemical solvents or strong detergents. Such products could contaminate the side airbag system and affect performance of the side airbag in a collision.

For fabric, carpets, cloth seats, safety belts and seats equipped with side airbags:

- Remove dust and loose dirt with a vacuum cleaner.
- Remove light stains and soil with Motorcraft Professional Strength Carpet & Upholstery Cleaner.
- If grease or tar is present on the material, spot-clean the area first with Motorcraft Spot and Stain Remover. In Canada, use Motorcraft Multi-Purpose Cleaner.
- If a ring forms on the fabric after spot cleaning, clean the entire area immediately (but do not oversaturate) or the ring will set.
- Do not use household cleaning products or glass cleaners, which can stain and discolor the fabric and affect the flame retardant abilities of the seat materials.

Vehicle Care

CLEANING THE INSTRUMENT PANEL AND INSTRUMENT CLUSTER LENS

WARNING



Do not use chemical solvents or strong detergents when cleaning the steering wheel or instrument panel to avoid contamination of the airbag system.

Note: Follow the same procedure as cleaning leather seats for cleaning leather instrument panels and leather interior trim surfaces.

Clean the instrument panel and cluster lens with a clean, damp and soft cloth, then use a clean, dry and soft cloth to dry these areas.

- Avoid cleaners or polishes that increase the gloss of the upper portion of the instrument panel. The dull finish in this area helps protect you from undesirable windshield reflection.
- Do not use any household cleaning products or glass cleaners as these may damage the finish of the instrument panel, interior trim and cluster lens.
- Wash or wipe your hands clean if you have been in contact with certain products such as insect repellent and suntan lotion to avoid possible damage to the interior painted surfaces.
- Do not allow air fresheners and hand sanitizers to spill onto interior surfaces. If a spill occurs, wipe off immediately. Your warranty may not cover these damages.

If a staining liquid like coffee or juice has been spilled on the instrument panel or on interior trim surfaces:

1. Wipe up spilled liquid using a clean, soft cloth as quickly as possible.
2. Use Motorcraft Premium Leather and Vinyl Cleaner or a commercially available leather cleaning product for automotive interiors. Test any cleaner or stain remover on an inconspicuous area.
3. Alternatively, wipe the surface with a clean, soft cloth and a mild soap and water solution. Dry the area with a clean, soft cloth.
4. If necessary, apply more soap and water solution or cleaning product to a clean, soft cloth and press it onto the soiled area. Allow this to set at room temperature for 30 minutes.
5. Remove the soaked cloth, then with a clean, damp cloth, use a rubbing motion for 60 seconds on the soiled area.
6. Dry the area with a clean, soft cloth.

REPAIRING MINOR PAINT DAMAGE

Authorized dealers have touch-up paint to match your vehicle's color. Your vehicle color code is printed on a sticker on the front, left-hand side door jamb. Take your color code to your authorized dealer to make sure you get the correct color.

Before repairing minor paint damage, use a cleaner such as Motorcraft Bug and Tar Remover to remove particles such as bird droppings, tree sap, insect deposits, tar spots, road salt and industrial fallout.

Always read the instructions before using cleaning products.

Vehicle Care

CLEANING THE ALLOY WHEELS *(If Equipped)*

Note: Do not apply a cleaning chemical to warm or hot wheel rims and covers.

Note: Some automatic car washes may cause damage to the finish on your wheel rims and covers.

Note: Industrial-strength or heavy-duty cleaners in combination with brush agitation to remove brake dust and dirt, could wear away the clear coat finish over a period time.

Note: Do not use hydrofluoric acid-based or high caustic-based wheel cleaners, steel wool, fuels or strong household detergents.

Note: If you intend parking your vehicle for an extended period after cleaning the wheels with a wheel cleaner, drive your vehicle for a few minutes before doing so. This will reduce the risk of increased corrosion of the brake discs.

Alloy wheels and wheel covers are coated with a clear coat paint finish. To maintain their condition we recommend that you:

- Clean the wheels weekly using Motorcraft Wheel and Tire Cleaner. Apply using manufacturer's instructions.
- Use a sponge to remove heavy deposits of dirt and brake dust accumulation.
- Rinse thoroughly with a strong stream of water when you have completed the cleaning process.
- To remove tar and grease, use Motorcraft Bug and Tar Remover.

VEHICLE STORAGE

If you plan on storing your vehicle for 30 days or more, read the following maintenance recommendations to make sure your vehicle stays in good operating condition.

We engineer and test all motor vehicles and their components for reliable, regular driving. Under various conditions, long-term storage may lead to degraded engine performance or failure unless you use specific precautions to preserve engine components.

General

- Store all vehicles in a dry, ventilated place.
- Protect from sunlight, if possible.
- If vehicles are stored outside, they require regular maintenance to protect against rust and damage.

Body

- Wash your vehicle thoroughly to remove dirt, grease, oil, tar or mud from exterior surfaces, rear-wheel housing and the underside of front fenders.
- Periodically wash your vehicle if it is stored in exposed locations.
- Touch-up exposed or primed metal to prevent rust.
- Cover chrome and stainless steel parts with a thick coat of auto wax to prevent discoloration. Re-wax as necessary when you wash your vehicle.
- Lubricate all hood, door and luggage compartment hinges and latches with a light grade oil.
- Cover interior trim to prevent fading.
- Keep all rubber parts free from oil and solvents.

Vehicle Care

Engine

- Change the engine oil and filter prior to storage because used engine oil contains contaminants which may cause engine damage.
- Start the engine every 15 days for a minimum of 15 minutes. Run at fast idle with the climate controls set to defrost until the engine reaches normal operating temperature.
- With your foot on the brake, shift through all the gears while the engine is running.
- We recommend that you change the engine oil before you use your vehicle again.

Fuel system

- Fill the fuel tank with high-quality fuel until the first automatic shutoff of the fuel pump nozzle.

Cooling system

- Protect against freezing temperatures.
- When removing your vehicle from storage, check coolant fluid level. Confirm that there are no cooling system leaks and that fluid is at the recommended level.

Battery

- Check and recharge as necessary. Keep connections clean.
- If storing your vehicle for more than 30 days without recharging the battery, we recommend that you disconnect the battery cables to maintain battery charge for quick starting.

Note: *It is necessary to reset memory features if battery cables are disconnected.*

Brakes

- Make sure the brakes and parking brake release fully.

Tires

- Maintain recommended air pressure.

Miscellaneous

- Make sure all linkages, cables, levers and pins under your vehicle are covered with grease to prevent rust.
- Move vehicles at least 25 ft (7.5 m) every 15 days to lubricate working parts and prevent corrosion.

Removing Vehicle From Storage

When your vehicle is ready to come out of storage, do the following:

- Wash your vehicle to remove any dirt or grease film build-up on window surfaces.
- Check windshield wipers for any deterioration.
- Check under the hood for any foreign material that may have collected during storage such as mice or squirrel nests.
- Check the exhaust for any foreign material that may have collected during storage.
- Check tire pressures and set tire inflation per the Tire Label.
- Check brake pedal operation. Drive your vehicle 15 ft (4.5 m) back and forth to remove rust build-up.
- Check fluid levels (including coolant, oil and gas) to make sure there are no leaks, and fluids are at recommended levels.
- If you remove the battery, clean the battery cable ends and check for damage.

Vehicle Care

Contact an authorized dealer if you have any concerns or issues.

Wheels and Tires

TIRE CARE

Glossary of Tire Terminology

***Tire label:** A label showing the original equipment tire sizes, recommended inflation pressure and the maximum weight the vehicle can carry.

***Tire Identification Number:** A number on the sidewall of each tire providing information about the tire brand and manufacturing plant, tire size and date of manufacture. Also referred to as DOT code.

***Inflation pressure:** A measure of the amount of air in a tire.

***Standard load:** A class of P-metric or Metric tires designed to carry a maximum load at set pressure. For example: For P-metric tires 35 psi (2.4 bar) or 36 (2.5 bar) depending on tire size and for Metric tires 36 psi (2.5 bar). Increasing the inflation pressure beyond this pressure will not increase the tire's load carrying capability.

***Extra load:** A class of P-metric or Metric tires designed to carry a heavier maximum load at 42 psi (2.9 bar). Increasing the inflation pressure beyond this pressure will not increase the tire's load carrying capability.

***kPa:** Kilopascal, a metric unit of air pressure.

***PSI:** Pounds per square inch, a standard unit of air pressure.

***Cold tire pressure:** The tire pressure when the vehicle has been stationary and out of direct sunlight for an hour or more and prior to the vehicle being driven for 1 mile (1.6 kilometers).

***Recommended inflation pressure:** The cold inflation pressure is found on the Safety Compliance Certification Label, located in the driver's door jam.

***Bead area of the tire:** Area of the tire next to the rim.

***Sidewall of the tire:** Area between the bead area and the tread.

***Tread area of the tire:** Area of the perimeter of the tire that contacts the road when mounted on the vehicle.

***Rim:** The metal support (wheel) for a tire or a tire and tube assembly upon which the tire beads are seated.

Information Contained on the Tire Sidewall

Both United States and Canada Federal regulations require tire manufacturers to place standardized information on the sidewall of all tires. This information identifies and

Wheels and Tires

describes the fundamental characteristics of the tire and also provides a U.S. DOT Tire Identification Number for safety standard certification and in case of a recall.

Information on P Type Tires

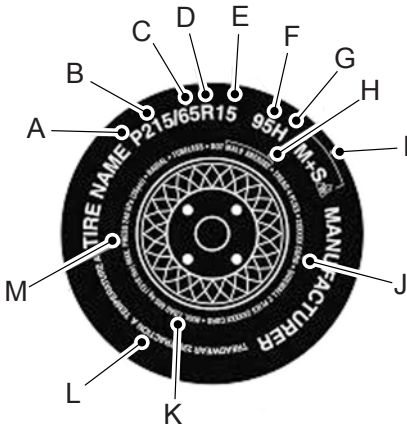

E142543

P215/65R15 95H is an example of a tire size, load index and speed rating. The definitions of these items are listed below. (Note that the tire size, load index and speed rating for your vehicle may be different from this example.)

A. P: Indicates a tire, designated by the Tire and Rim Association, that may be used for service on cars, sport utility vehicles, minivans and light trucks. **Note:** If your tire size does not begin with a letter this may mean it is designated by either the European Tire and Rim Technical Organization or the Japan Tire Manufacturing Association.

B. 215: Indicates the nominal width of the tire in millimeters from sidewall edge to sidewall edge. In general, the larger the number, the wider the tire.

C. 65: Indicates the aspect ratio which gives the tire's ratio of height to width.

D. R: Indicates a radial type tire.

E. 15: Indicates the wheel or rim diameter in inches. If you change your wheel size, you will have to purchase new tires to match the new wheel diameter.

F. 95: Indicates the tire's load index. It is an index that relates to how much weight a tire can carry.

Note: *You may not find this information on all tires because it is not required by federal law.*

G. H: Indicates the tire's speed rating. The speed rating denotes the speed at which a tire is designed to be driven for extended periods of time under a standard condition of load and inflation pressure. The tires on your vehicle may operate at different

Wheels and Tires

conditions for load and inflation pressure. These speed ratings may need to be adjusted for the difference in conditions. The ratings range from 81 mph (130 km/h) to 186 mph (299 km/h). These ratings are listed in the following chart.

Note: *You may not find this information on all tires because it is not required by federal law.*

Letter rating	Speed rating - mph (km/h)
M	81 (130)
N	87 (140)
Q	99 (159)
R	106 (171)
S	112 (180)
T	118 (190)
U	124 (200)
H	130 (210)
V	149 (240)
W	168 (270)
Y	186 (299)

Note: *For tires with a maximum speed capability over 149 mph (240 km/h), tire manufacturers sometimes use the letters ZR. For those with a maximum speed capability over 186 mph (299 km/h), tire manufacturers always use the letters ZR.*

H. U.S. DOT Tire Identification

Number: This begins with the letters DOT and indicates that the tire meets all federal standards. The next two numbers or letters are the plant code designating where it was manufactured, the next two are the tire size code and the last four numbers represent the week and year the tire was built. For example, the numbers 317 mean the 31st week of 1997. After 2000 the numbers go to four digits. For example, 2501 means the 25th week of 2001. The numbers in between are identification codes used for traceability. This information is used to contact customers if a tire defect requires a recall.

I. **M+S or M/S:** Mud and Snow, or

AT: All Terrain, or

AS: All Season.

J. Tire Ply Composition and Material Used:

Indicates the number of plies or the number of layers of rubber-coated fabric in the tire tread and sidewall. Tire manufacturers also must indicate the ply materials in the tire and the sidewall, which include steel, nylon, polyester, and others.

K. **Maximum Load:** Indicates the maximum load in kilograms and pounds that can be carried by the tire.

L. Treadwear, Traction and Temperature Grades:

Wheels and Tires

***Treadwear** The treadwear grade is a comparative rating based on the wear rate of the tire when tested under controlled conditions on a specified government test course. For example, a tire graded 150 would wear 1½ times as well on the government course as a tire graded 100.

***Traction:** The traction grades, from highest to lowest are AA, A, B, and C. The grades represent the tire's ability to stop on wet pavement as measured under controlled conditions on specified government test surfaces of asphalt and concrete. A tire marked C may have poor traction performance.

***Temperature:** The temperature grades are A (the highest), B and C, representing the tire's resistance to the generation of heat and its ability to dissipate heat when tested under controlled conditions on a specified indoor laboratory test wheel.

M. Maximum Inflation Pressure: Indicates the tire manufacturers' maximum permissible pressure or the pressure at which the maximum load can be carried by the tire. This pressure is normally higher than the vehicle manufacturer's recommended cold inflation

pressure which can be found on the Safety Compliance Certification Label. The cold inflation pressure should never be set lower than the recommended pressure on the vehicle label.

The tire suppliers may have additional markings, notes or warnings such as standard load or radial tubeless.

Additional Information Contained on the Tire Sidewall for LT Type Tires

Note: *Tire Quality Grades do not apply to this type of tire.*

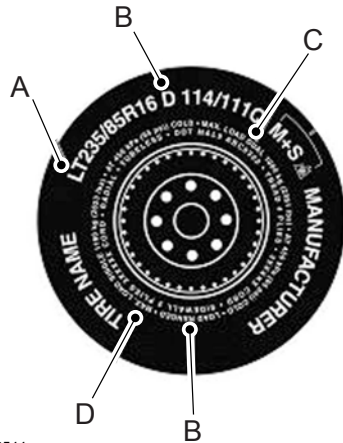

E142544

LT type tires have some additional information beyond those of P type tires; these differences are described below.

Wheels and Tires

A. **LT:** Indicates a tire, designated by the Tire and Rim Association, that is intended for service on light trucks.

B. **Load Range and Load Inflation Limits:** Indicates the tire's load-carrying capabilities and its inflation limits.

C. **Maximum Load Dual lb (kg) at psi (kPa) cold:** Indicates the maximum load and tire pressure when the tire is used as a dual; defined as four tires on the rear axle (a total of six or more tires on the vehicle).

D. **Maximum Load Single lb (kg) at psi (kPa) cold:** Indicates the maximum load and tire pressure when the tire is used as a single; defined as two tires (total) on the rear axle.

Information on T Type Tires

T145/80D16 is an example of a tire size.

Note: *The temporary tire size for your vehicle may be different from this example. Tire Quality Grades do not apply to this type of tire.*

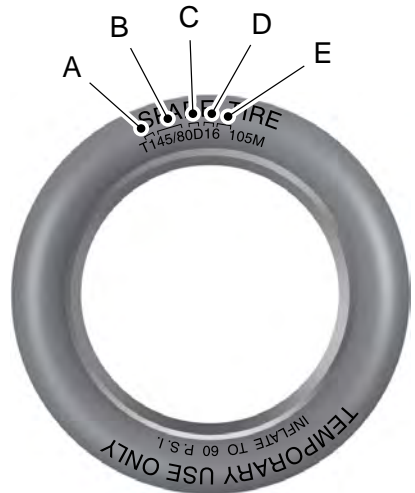

E142545

T type tires have some additional information beyond those of P type tires; these differences are described below:

A. **T:** Indicates a type of tire, designated by the Tire and Rim Association, that is intended for temporary service on cars, sport utility vehicles, minivans and light trucks.

B. **145:** Indicates the nominal width of the tire in millimeters from sidewall edge to sidewall edge. In general, the larger the number, the wider the tire.

Wheels and Tires

C. **80:** Indicates the aspect ratio which gives the tire's ratio of height to width. Numbers of 70 or lower indicate a short sidewall.

D. **D:** Indicates a diagonal type tire.

R: Indicates a radial type tire.

E. **16:** Indicates the wheel or rim diameter in inches. If you change your wheel size, you will have to purchase new tires to match the new wheel diameter.

Inflating Your Tires

Safe operation of your vehicle requires that your tires are properly inflated. Remember that a tire can lose up to half of its air pressure without appearing flat.

Every day before you drive, check your tires. If one looks lower than the others, use a tire gauge to check pressure of all tires and adjust if required.

At least once a month and before long trips, inspect each tire and check the tire pressure with a tire gauge (including spare, if equipped). Inflate all tires to the inflation pressure recommended by Ford Motor Company.

You are strongly urged to buy a reliable tire pressure gauge, as automatic service station gauges may be inaccurate. Ford recommends the use of a digital or dial-type tire pressure gauge rather than a stick-type tire pressure gauge.

Use the recommended cold inflation pressure for optimum tire performance and wear. Under-inflation or over-inflation may cause uneven treadwear patterns

WARNING



Under-inflation is the most common cause of tire failures and may result in severe tire cracking, tread separation or blowout, with unexpected loss of vehicle control and increased risk of injury. Under-inflation increases sidewall flexing and rolling resistance, resulting in heat buildup and internal damage to the tire. It also may result in unnecessary tire stress, irregular wear, loss of vehicle control and accidents. A tire can lose up to half of its air pressure and not appear to be flat!

Always inflate your tires to the Ford recommended inflation pressure even if it is less than the maximum inflation pressure information found on the tire. The Ford recommended tire inflation pressure is found on the Safety Compliance Certification Label or Tire Label. Failure to follow the tire pressure recommendations can cause uneven treadwear patterns and adversely affect the way your vehicle handles

Wheels and Tires

Maximum Inflation Pressure is the tire manufacturer's maximum permissible pressure and the pressure at which the maximum load can be carried by the tire. This pressure is normally higher than the manufacturer's recommended cold inflation pressure which can be found on the Safety Compliance Certification Label or Tire Label. The cold inflation pressure should never be set lower than the recommended pressure on the Safety Compliance Certification Label or Tire Label.

When weather temperature changes occur, tire inflation pressures also change. A 10°F (6°C) temperature drop can cause a corresponding drop of 1 psi (7 kPa) in inflation pressure. Check your tire pressures frequently and adjust them to the proper pressure which can be found on the Safety Compliance Certification Label or Tire Label.

To check the pressure in your tire(s):

1. Make sure the tires are cool, meaning they are not hot from driving even a mile.

Note: *If you are checking tire pressure when the tire is hot, (for example, driven more than 1 mile [1.6 kilometers]), never bleed or reduce air pressure. The tires are hot from driving and it is normal for pressures to increase above recommended cold pressures. A hot tire at or below recommended cold inflation pressure could be significantly under-inflated.*

Note: *If you have to drive a distance to get air for your tire(s), check and record the tire pressure first and add the appropriate air pressure when you get to the pump. It is normal for tires to heat up and the air pressure inside to go up as you drive.*

2. Remove the cap from the valve on one tire, then firmly press the tire gauge onto the valve and measure the pressure.
3. Add enough air to reach the recommended air pressure.

Note: *If you overfill the tire, release air by pressing on the metal stem in the center of the valve. Then recheck the pressure with your tire gauge.*

4. Replace the valve cap.
5. Repeat this procedure for each tire, including the spare.

Wheels and Tires

Note: *Some spare tires operate at a higher inflation pressure than the other tires. For T type mini-spare tires, see the Dissimilar spare wheel and tire assembly information for a description. Store and maintain at 60 psi (4.15 bar). For full-size and dissimilar spare tires, see the Dissimilar spare wheel and tire assembly information for a description. Store and maintain at the higher of the front and rear inflation pressure as shown on the Safety Compliance Certification Label or Tire Label.*

6. Visually inspect the tires to make sure there are no nails or other objects embedded that could poke a hole in the tire and cause an air leak.
7. Check the sidewalls to make sure there are no gouges, cuts or bulges.

Tire Inflation Information

WARNING



An inflated tire and rim can be very dangerous if improperly used, serviced or maintained. To reduce the risk of serious injury, never attempt to re-inflate a tire which has been run flat or seriously under-inflated without first removing the tire from the wheel assembly for inspection. Do not attempt to add air to tires or replace tires or wheels without first taking precautions to protect persons and property.

All tires with Steel Carcass Plies (if equipped):

This type of tire utilizes steel cords in the sidewalls. As such, they cannot be treated like normal light truck tires. Tire service, including adjusting tire pressure, must be performed by personnel trained, supervised and equipped according to Federal Occupational Safety and Health Administration regulations. For example, during any procedure involving tire inflation, the technician or individual must utilize a remote inflation device, and ensure that all persons are clear of the trajectory area.

Wheels and Tires

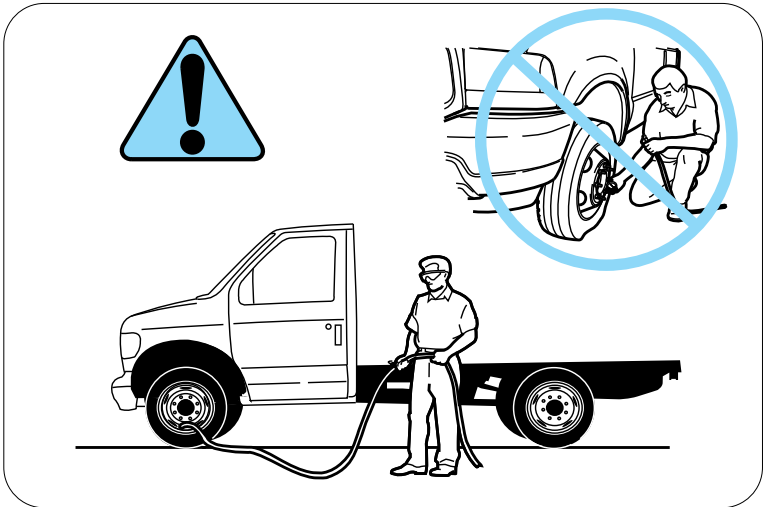

E161437

Wheels and Tires

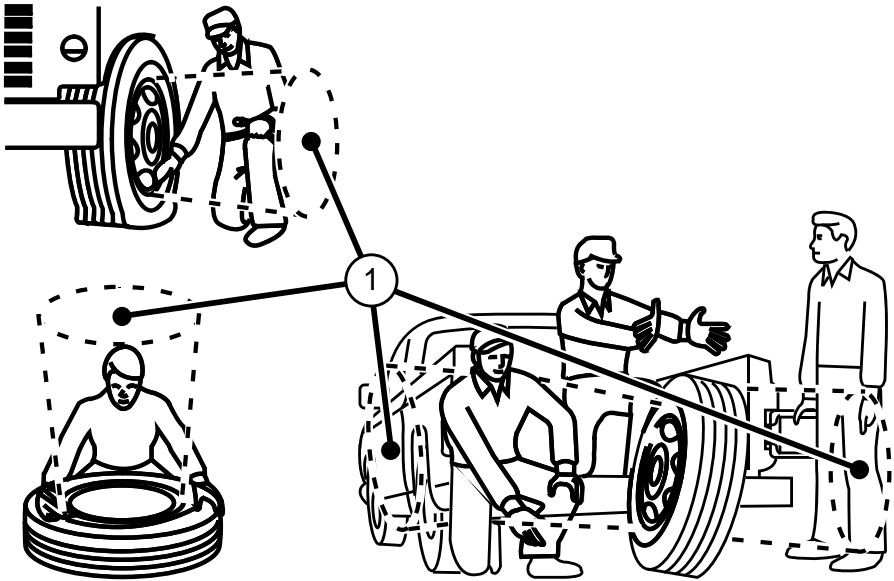

E161438

WARNING



Stay out of the trajectory (1) as indicated in the illustration.

Inspecting Your Tires and Wheel Valve Stems

Periodically inspect the tire treads for uneven or excessive wear and remove objects such as stones, nails or glass that may be wedged in the tread grooves. Check the tire and valve stems for holes, cracks, or cuts that may permit air leakage and repair or replace the tire and replace the valve stem. Inspect the tire sidewalls for cracking, cuts, bruises and other

signs of damage or excessive wear. If internal damage to the tire is suspected, have the tire demounted and inspected in case it needs to be repaired or replaced. For your safety, tires that are damaged or show signs of excessive wear should not be used because they are more likely to blow out or fail.

Improper or inadequate vehicle maintenance can cause tires to wear abnormally. Inspect all your tires, including the spare, frequently, and replace them if one or more of the following conditions exist:

Wheels and Tires

Tire Wear



E142546

When the tread is worn down to one sixteenth of an inch (2 millimeters), tires must be replaced to help prevent your vehicle from skidding and hydroplaning. Built-in treadwear indicators, or wear bars, which look like narrow strips of smooth rubber across the tread will appear on the tire when the tread is worn down to one sixteenth of an inch (2 millimeters).

When the tire tread wears down to the same height as these wear bars, the tire is worn out and must be replaced.

Damage

Periodically inspect the tire treads and sidewalls for damage (such as bulges in the tread or sidewalls, cracks in the tread groove and separation in the tread or sidewall). If damage is observed

or suspected have the tire inspected by a tire professional. Tires can be damaged during off-road use, so inspection after off-road use is also recommended.

Age

WARNING



Tires degrade over time depending on many factors such as weather, storage conditions, and conditions of use (load, speed, inflation pressure) the tires experience throughout their lives.

In general, tires should be replaced after six years regardless of tread wear. However, heat caused by hot climates or frequent high loading conditions can accelerate the aging process and may require tires to be replaced more frequently.

You should replace your spare tire when you replace the road tires or after six years due to aging even if it has not been used.

U.S. DOT Tire Identification Number

Both United States and Canada Federal regulations require tire manufacturers to place standardized information on the sidewall of all tires. This information identifies and

Wheels and Tires

describes the fundamental characteristics of the tire and also provides a U.S. DOT Tire Identification Number for safety standard certification and in case of a recall.

This begins with the letters DOT and indicates that the tire meets all federal standards. The next two numbers or letters are the plant code designating where it was manufactured, the next two are the tire size code and the last four numbers represent the week and year the tire was built. For example, the numbers 317 mean the 31st week of 1997. After 2000 the numbers go to four digits. For example, 2501 means the 25th week of 2001. The numbers in between are identification codes used for traceability. This information is used to contact customers if a tire defect requires a recall.

Tire Replacement Requirements

Your vehicle is equipped with tires designed to provide a safe ride and handling capability.

WARNINGS



Only use replacement tires and wheels that are the same size, load index, speed rating and type (such as P-metric versus LT-metric or all-season versus all-terrain) as those originally provided by Ford. The recommended tire and wheel size

WARNINGS

may be found on either the Safety Compliance Certification Label or the Tire Label. If this information is not found on these labels then you should contact your authorized dealer as soon as possible. Use of any tire or wheel not recommended by Ford can affect the safety and performance of your vehicle, which could result in an increased risk of loss of vehicle control, vehicle rollover, personal injury and death. Additionally the use of non-recommended tires and wheels could cause steering, suspension, axle, transfer case or power transfer unit failure. If you have questions regarding tire replacement, contact your authorized dealer as soon as possible.



To reduce the risk of serious injury, when mounting replacement tires and wheels, you should not exceed the maximum pressure indicated on the sidewall of the tire to set the beads without additional precautions listed below. If the beads do not seat at the maximum pressure indicated, re-lubricate and try again

Wheels and Tires

WARNINGS

When inflating the tire for mounting pressures up to 20 psi (1.38 bar) greater than the maximum pressure on the tire sidewall, the following precautions must be taken to protect the person mounting the tire:

1. Make sure that you have the correct tire and wheel size.
2. Lubricate the tire bead and wheel bead seat area again.
3. Stand at a minimum of 12 feet (3.6 meters) away from the wheel and tire assembly.
4. Use both eye and ear protection.

For a mounting pressure more than 20 psi (1.38 bar) greater than the maximum pressure, a Ford dealer or other tire service professional should do the mounting.

Always inflate steel carcass tires with a remote air fill with the person inflating standing at a minimum of 12 feet (3.6 meters) away from the wheel and tire assembly

Important: Remember to replace the wheel valve stems when the road tires are replaced on your vehicle

It is recommended that the two front tires or two rear tires generally be replaced as a pair.

Replacing a Tire That is Greenhouse Gas Certified

The tires installed on this vehicle at the factory as original equipment are certified for Greenhouse Gas and Fuel Efficiency regulations. Replacement tires must be of equal or lower rolling resistance level (TRRL or Crr). Consult with your tire supplier(s) for appropriate replacement tires.

Safety Practices

WARNINGS



If your vehicle is stuck in snow, mud, or sand, do not rapidly spin the tires; spinning the tires can tear the tire and cause an explosion. A tire can explode in as little as three to five seconds.



Do not spin the wheels at over 35 mph (56 km/h). The tires may fail and injure a passenger or bystander.

Driving habits have a great deal to do with your tire mileage and safety.

- *Observe posted speed limits
- *Avoid fast starts, stops and turns
- *Avoid potholes and objects on the road

Wheels and Tires

*Do not run over curbs or hit the tire against a curb when parking

Highway Hazards

No matter how carefully you drive there's always the possibility that you may eventually have a flat tire on the highway. Drive slowly to the closest safe area out of traffic.

This may further damage the flat tire, but your safety is more important.

If you feel a sudden vibration or ride disturbance while driving, or you suspect your tire or vehicle has been damaged, immediately reduce your speed. Drive with caution until you can safely pull off the road. Stop and inspect the tires for damage. If a tire is under-inflated or damaged, deflate it, remove wheel and replace it with your spare tire and wheel. If you cannot detect a cause, have the vehicle towed to the nearest repair facility or tire dealer to have the vehicle inspected.

Tire and Wheel Alignment

A bad jolt from hitting a curb or pothole can cause the front end of your vehicle to become misaligned or cause damage to your tires. If your vehicle seems to pull to one side when you're driving, the wheels may be out of alignment. Have an authorized dealer check the wheel alignment periodically.

Wheel misalignment in the front or the rear can cause uneven and rapid treadwear of your tires and should be corrected by an authorized dealer. Front-wheel drive vehicles and those with an independent rear suspension may require alignment of all four wheels.

The tires should also be balanced periodically. An unbalanced tire and wheel assembly may result in irregular tire wear.

Tire Rotation

Note: *If your tires show uneven wear ask an authorized dealer to check for and correct any wheel misalignment, tire imbalance or mechanical problem involved before tire rotation.*

Note: *Your vehicle may be equipped with a dissimilar spare wheel and tire assembly. A dissimilar spare wheel and tire assembly is defined as a spare wheel and tire assembly that is different in brand, size or appearance from the road tires and wheels. If you have a dissimilar spare wheel and tire assembly it is intended for temporary use only and should not be used in a tire rotation.*

Rotating your tires at the recommended interval will help your tires wear more evenly, providing better tire performance and longer tire life.

Wheels and Tires

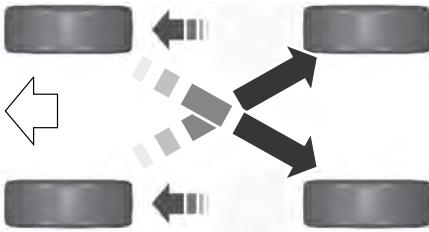

E142548

Rear-wheel drive vehicles

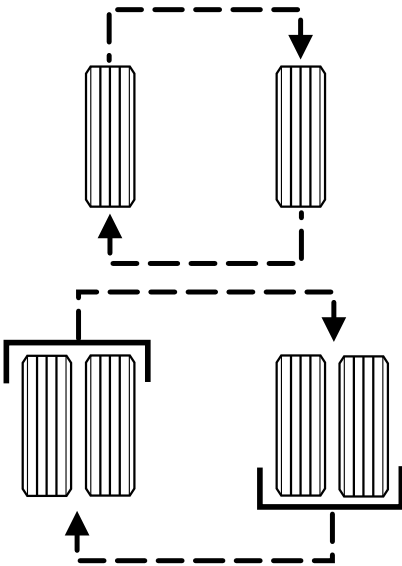

E161439

Dual rear wheel vehicles (six tire rotation)

If your vehicle is equipped with dual rear wheels it is recommended that the front and rear tires (in pairs) be rotated only side to side. We do not recommend splitting up the dual rear wheels. Rotate them side to side as a set. After tire rotation, inflation pressures must be adjusted for the tires new positions in accordance with vehicle requirements.

Sometimes irregular tire wear can be corrected by rotating the tires.

USING SNOW CHAINS

WARNING



Snow tires must be the same size, load index, and speed rating as those originally provided by Ford. Use of any tire or wheel not recommended by Ford can affect the safety and performance of your vehicle, which could result in an increased risk of loss of vehicle control, vehicle rollover, personal injury, and death. Additionally, the use of non-recommended tires and wheels could cause steering, suspension, axle, transfer case, or power transfer unit failure. It is also strongly advised to follow the Ford recommended tire inflation pressure found on the Safety Compliance Certification Label (affixed to either the door hinge pillar, door-latch post, or the door edge that meets the door-latch post, next to the driver's seating position), or Tire Label which is located on the B-Pillar or the edge of the driver door. Failure to follow the tire pressure recommendations can cause uneven treadwear patterns and adversely affect the way your vehicle handles.

Wheels and Tires

The tires on your vehicle have all-weather treads to provide traction in rain and snow. However, in some climates, you may need to use snow tires and cables. If you need to use cables, it is recommended that steel wheels (of the same size and specifications) be used, as cables may chip aluminum wheels.

Note: *The suspension insulation and bumpers help prevent vehicle damage. Do not remove these components from your vehicle when using snow tires and chains.*

Follow these guidelines when using snow tires and chains:

- If possible, avoid fully loading your vehicle.
- Use only SAE Class S chains.
- Install chains securely, verifying that the chains do not touch any wiring, brake lines or fuel lines.
- Drive cautiously. If you hear the chains rub or bang against your vehicle, stop and retighten the chains. If this does not work, remove the chains to prevent damage to your vehicle.
- Remove the tire chains when they are no longer needed. Do not use tire chains on dry roads.

If you have any questions regarding snow chains or cables, please contact your authorized dealer.

CHANGING A ROAD WHEEL

If you get a flat tire while driving, do not apply the brake heavily. Instead, gradually decrease your speed. Hold the steering wheel firmly and slowly move to a safe place on the side of the road.

Tire Change Procedure

WARNINGS

- ⚠ When one of the front wheels is off the ground, the transmission alone will not prevent the vehicle from moving or slipping off the jack, even if the transmission is in park (P).
- ⚠ To help prevent the vehicle from moving when you change a tire, be sure to place the transmission in park (P), set the parking brake and block (in both directions) the wheel that is diagonally opposite (other side and end of the vehicle) to the tire being changed.
- ⚠ Never get underneath a vehicle that is supported only by a jack. If the vehicle slips off the jack, you or someone else could be seriously injured.
- ⚠ Do not attempt to change a tire on the side of the vehicle close to moving traffic. Pull far enough off the road to avoid the danger of being hit when operating the jack or changing the wheel.

Note: *Passengers should not remain in the vehicle when the vehicle is being jacked.*

Park on a level surface, set the parking brake and activate the hazard flashers.

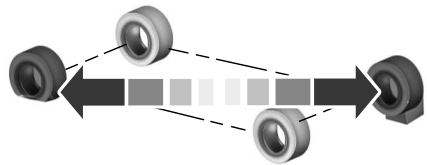

E142551

1. Turn the engine off and block the wheel that is diagonally opposite of the flat tire using a wheel chock.

Wheels and Tires

- Loosen each wheel lug nut $\frac{1}{2}$ turn counterclockwise, but do not remove them until the wheel is raised off the ground.
- Replace the flat tire with the spare tire, making sure the valve stem is facing outward on all front and inboard rear wheels. If you are replacing the outboard wheel, the valve stem must be facing inward. Reinstall the lug nuts until the wheel is snug against the hub. Do not fully tighten the lug nuts until the wheel has been lowered.
- Lower the wheel and fully tighten the lug nuts in the order shown below. See **Technical Specifications** (page 250).
- Unblock the wheels.



E161441

8-lug nut torque sequence.



E169375

10-lug nut torque sequence.

Wheels and Tires

TECHNICAL SPECIFICATIONS

Wheel Lug Nut Torque Specifications

WARNING



When a wheel is installed, always remove any corrosion, dirt or foreign materials present on the mounting surfaces of the wheel or the surface of the wheel hub, brake drum or brake disc that contacts the wheel. Make sure that any fasteners that attach the rotor to the hub are secured so they do not interfere with the mounting surfaces of the wheel. Installing wheels without correct metal-to-metal contact at the wheel mounting surfaces can cause the wheel nuts to loosen and the wheel to come off while the vehicle is in motion, resulting in loss of control.

Bolt size	lb.ft (Nm)
M22 x 1.5	450–500 lb.ft (610–678 Nm)

*Torque specifications are for nut and bolt threads free of dirt and rust. Use only Ford recommended replacement fasteners.

On vehicles equipped with single rear wheels, retighten the lug nuts to the specified torque at 100 miles (160 kilometers) after any wheel disturbance (such as tire rotation, changing a flat tire, wheel removal).

On vehicles equipped with dual rear wheels, retighten the lug nuts to the specified torque at 100 miles (160 kilometers) and again at 500 miles (800 kilometers) of new vehicle operation and after any wheel disturbance (such as tire rotation, changing a flat tire, wheel removal).

It is important to follow the proper wheel mounting and lug nut torque procedures.



E161443

On all two-piece flat wheel nuts, apply one drop of motor oil between the flat washer and the nut. Do not apply motor oil to the wheel nut threads or the wheel stud threads.

Wheels and Tires



E145950

A Wheel pilot bore

Inspect the wheel pilot hole and mounting surface prior to installation. Remove any visible corrosion or loose particles.

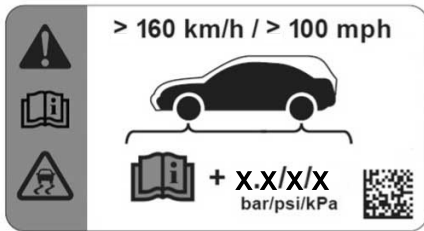

E184089

The Tire Label is located on the B-Pillar or edge of the driver's door.

Capacities and Specifications

ENGINE SPECIFICATIONS - 6.8L

Engine	6.8L V10 Engine
Cubic inches	413
Required fuel	Minimum 87 octane
Firing order	1-6-5-10-2-7-3-8-4-9
Ignition system	Coil on plug
Spark plug gap	0.039 - 0.043 in (1.00 - 1.10 mm)
Compression ratio	9.2:1

Drivebelt Routing

6.8L Engines with A/C



E163762

6.8L Engines without A/C



E163763

ENGINE SPECIFICATIONS - 6.7L DIESEL

Drivebelt Routing

Engine	6.7L Diesel
Cubic inches	406
Required fuel	Low Sulfur Diesel up to B20
Firing order	1-3-7-2-6-5-4-8
Compression ratio	16.2:1

Capacities and Specifications

Single Alternator

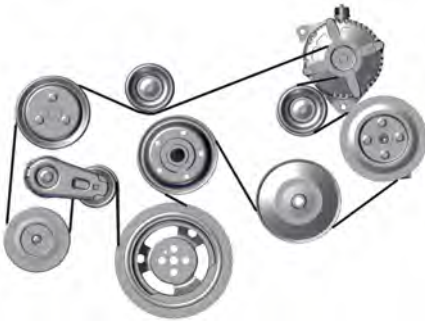

E224819

Dual Alternator



E224820

Single Alternator With Air Brake Compressor

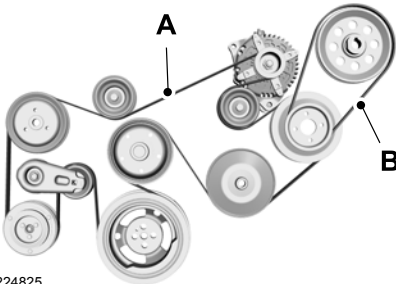

E224825

A	Drivebelt closest to the engine.
B	Drivebelt furthest from the engine.

Dual Alternator With Air Brake Compressor

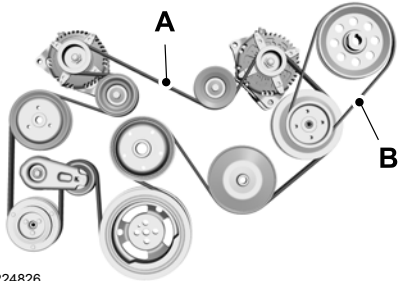

E224826

A	Drivebelt closest to the engine.
B	Drivebelt furthest from the engine.

Note: The belt routings show vehicles equipped with air conditioning. When not equipped with air conditioning a idler pulley is in place of the A/C compressor.

Capacities and Specifications

MOTORCRAFT PARTS - 6.8L

Component	6.8L V10 engine
Air filter element	FA-1923
Oil filter	FL-820-S
One Battery (standard)(900 CCA)	BH-31-XT
Two Batteries (optional)(except for limited series)(1800 CCA)	BH-31-XT
Spark plugs-platinum	SP-509
Windshield wiper blade	WW-2245

For scheduled maintenance, we recommend Motorcraft® replacement parts available at your Ford dealer or at fordparts.com. These parts meet or exceed Ford Motor Company's specifications and are engineered for your vehicle. Use of other parts may impact vehicle performance, emissions and durability. Your warranty may be void for any damage related to use of other parts.

If a Motorcraft® oil filter is not available, use an oil filter that meets industry performance specification SAE/USCAR-36/USC-D.

For spark plug replacement, contact an authorized dealer. Replace the spark plugs at the appropriate intervals. See **Scheduled Maintenance** (page 316).

Capacities and Specifications

MOTORCRAFT PARTS - 6.7L DIESEL

Component	6.7L Diesel
Engine oil filter	FL-2051S
Foam pre-filter	FA-1907
Air filter	FA-1923
Crankcase vent filter	FL-2070
Fuel filter kit (2 included - engine and frame rail mounted)	FD-4615
Transmission filter	FT-187
Two Batteries (standard)(1500 CCA)	BH-31-XL
Two Batteries (optional)(1800 CCA)	BH-31-XT
Three Batteries (optional)(2700 CCA)	BH-31-XT
Windshield wiper blade	WW-2245

For scheduled maintenance, we recommend Motorcraft® replacement parts available at your Ford dealer or at fordparts.com. These parts meet or exceed Ford Motor Company's specifications and are engineered for your vehicle. Use of other parts may impact vehicle performance, emissions and durability. Your warranty may be void for any damage related to use of other parts.

If a Motorcraft® oil filter is not available, use an oil filter that meets industry performance specification SAE/USCAR-36.

Capacities and Specifications

VEHICLE IDENTIFICATION NUMBER

The vehicle identification number is located on the left-hand side of the instrument panel.

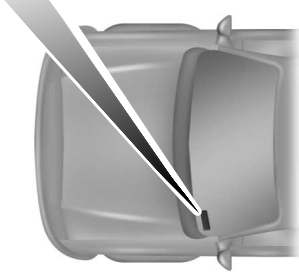
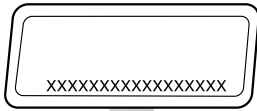

E142476

Please note that in the graphic, XXXX is representative of your vehicle identification number.

The Vehicle Identification Number contains the following information:

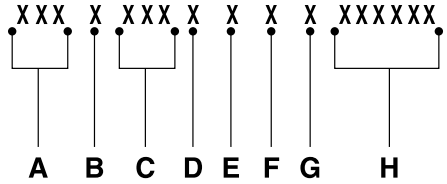

E142477

- A World manufacturer identifier
- B Brake system, Gross Vehicle Weight Rating, Restraint Devices and their locations
- C Make, vehicle line, series, body type
- D Engine type
- E Check digit
- F Model year
- G Assembly plant
- H Production sequence number

Capacities and Specifications

VEHICLE CERTIFICATION LABEL

MFD. BY FORD MOTOR CO.

DATE: XX/XX GVWR: XXXX KG (XXXX LB)
 FRONT GAWR: REAR GAWR:
 XXXX KG (XXXX LB) WITH XXXX KG (XXXX LB) WITH
 XXXXXXXXXXXXXXXX TIRES XXXXXXXXXXXXXXXX TIRES
 XXXXXXXX RIMS XXXXXXXX RIMS
 AT XXXX kPa/ XXX PSI COLD AT XXXX kPa/ XXX PSI COLD

THIS VEHICLE CONFORMS TO ALL APPLICABLE FEDERAL MOTOR VEHICLE SAFETY AND THEFT PREVENTION STANDARDS IN EFFECT ON THE DATE OF MANUFACTURE SHOWN ABOVE.

VIN: XXXXXXXXXXXXXXXX XXXXX
 TYPE: XXXX XXXXX



EXT PNT: XX	XXXXXX	RC: XX	DSC: XXXX
WB	INT TR	TP/PS	R AXLE
TR	SPR	XXXX	XXXX
XXX	XX	XXX	X XX X XXXX XXXX
XXXXXXXXXXXXXX	XXX	XXXX-XXXXXX-XX	

E167469

The National Highway Traffic Safety Administration Regulations require that a Safety Compliance Certification Label be affixed to a vehicle and prescribe where the Safety Compliance Certification Label may be located. The Safety Compliance Certification Label shall be affixed to either the door hinge pillar, the door latch post, or the edge of the door near the door latch, next to the driver's seating position.

TRANSMISSION CODE DESIGNATION

MFD. BY FORD MOTOR CO.

DATE: XX/XX GVWR: XXXX KG (XXXX LB)
 FRONT GAWR: REAR GAWR:
 XXXX KG (XXXX LB) WITH XXXX KG (XXXX LB) WITH
 XXXXXXXXXXXXXXXX TIRES XXXXXXXXXXXXXXXX TIRES
 XXXXXXXX RIMS XXXXXXXX RIMS
 AT XXXX kPa/ XXX PSI COLD AT XXXX kPa/ XXX PSI COLD

THIS VEHICLE CONFORMS TO ALL APPLICABLE FEDERAL MOTOR VEHICLE SAFETY AND THEFT PREVENTION STANDARDS IN EFFECT ON THE DATE OF MANUFACTURE SHOWN ABOVE.

VIN: XXXXXXXXXXXXXXXX XXXXX
 TYPE: XXXX XXXXX



EXT PNT: XX	XXXXXX	RC: XX	DSC: XXXX
WB	INT TR	TP/PS	R AXLE
TR	SPR	XXXX	XXXX
XXX	XX	XXX	X XX X XXXX XXXX
XXXXXXXXXXXXXX	XXX	XXXX-XXXXXX-XX	

E167814

The transmission code is on the Safety Compliance Certification Label. The following table shows the transmission code along with the transmission description.

Description	Code
Six-speed automatic transmission 6R140 (Gas)	P
Six-speed automatic transmission 6R140 (Diesel)	G

Capacities and Specifications

CAPACITIES AND SPECIFICATIONS - 6.8L

Capacities

WARNING



The air conditioning refrigerant system contains refrigerant under high pressure. Only qualified personnel should service the air conditioning refrigerant system. Opening the air conditioning refrigerant system can cause personal injury.

Item	Capacity
Engine oil (with oil filter)	7.0 qt (6.6 L)
Engine coolant	28.8 qt (27.3 L) ¹
Fuel tank (Limited Series)	58 gal (219.5 L) (Usable capacity) ²
	62 gal (234.6 L) (Liquid capacity)
Fuel tank (Small)	47 gal (177.9 L) (Usable capacity) ²
	50 gal (189.2 L) (Liquid capacity)
Fuel tank (Large)	59 gal (223.3 L) (Usable capacity) ²
	63 gal (238.4 L) (Liquid capacity)
Brake fluid	Between MIN and MAX on brake fluid reservoir
Automatic transmission fluid	17.4 qt (16.5 L) ³
Front axle wheel bearing oil (8500 lb axle)	6–7 fl oz (177–207 ml)
Front axle wheel bearing oil (all except 8500 lb axle)	12–13 fl oz (355–385 ml)
Rear axle (S-140)(13.5k, 17.5k, 19k single speed)	19 pt (9.0 L) ⁴
Rear axle (S-170)(23k single speed)	37 pt (17.5 L) ⁴

Capacities and Specifications

Item	Capacity
Rear axle (S-190)(26k single speed)	37 pt (17.5 L) ⁴
Rear axle (21060S)(21k single speed)	28 pt (13.2 L) ⁴
Power Steering (air brake equipped)	5.2 qt (4.9 L) ⁴
Power Steering (hydraulic brake equipped)	6.1 qt (5.8 L) ⁴
Windshield washer fluid	Fill as required
A/C refrigerant	29.1 oz (0.825 kg)
A/C refrigerant compressor oil	7.1 fl oz (210 ml) ⁵

¹Use the coolant type originally equipped in your vehicle. Using any other coolant may result in vehicle damage.

²Do NOT fill above the 95% liquid capacity.

³Approximate dry fill capacity. Actual amount may vary during fluid changes.

⁴Capacities may be higher if the vehicle is equipped with a cooler. Always check to make sure the fluid level is in the acceptable range.

⁵This system uses mineral-based refrigerant oil to lubricate O-rings and fittings.

Specifications

Materials

Name	Specification
Recommended motor oil (U.S. and Mexico): Motorcraft® SAE 5W-20 Premium Synthetic Blend Motor Oil XO-5W20-QSP	WSS-M2C945-A
Recommended motor oil (Canada): Motorcraft® SAE 5W-20 Super Premium Motor Oil CXO-5W20-LSP12	WSS-M2C945-A
Optional motor oil (U.S. and Mexico): Motorcraft® SAE 5W-20 Full Synthetic Motor Oil XO-5W20-QFS	WSS-M2C945-A
Optional Motor oil (Canada): Motorcraft® SAE 5W-20 Synthetic Motor Oil CXO-5W20-LFS12	WSS-M2C945-A

Capacities and Specifications

Name	Specification
Engine coolant (U.S. and Mexico): Motorcraft® Orange Prediluted Antifreeze/Coolant VC-3DIL-B	WSS-M97B44-D2
Engine coolant (Canada): Motorcraft® Orange Prediluted Antifreeze/Coolant CVC-3DIL-B	WSS-M97B44-D2
Brake fluid: Motorcraft® DOT 5.1 Motor Vehicle Brake Fluid PM-21	WSS-M6C65-A3
Automatic transmission fluid (U.S. and Mexico): Motorcraft® MERCON LV Automatic Transmission Fluid XT-10-QLVC	WSS-M2C938-A MERCON LV
Automatic transmission fluid (Canada): Motorcraft® MERCON LV Automatic Transmission Fluid CXT-10-QLVC	WSS-M2C938-A MERCON LV
Front axle (wheel bearing oil): Motorcraft® SAE 75W-140 Synthetic Rear Axle Lubricant XY-75W140-QL	WSL-M2C192-A
Recommended Rear axle fluid (U.S. and Mexico): (S-140) Motorcraft® SAE 80W-90 Premium Rear Axle Lubricant XY-80W90-QL	WSP-M2C197-A ¹
Recommended Rear axle fluid (Canada): (S-140) Motorcraft® SAE 80W-90 Premium Rear Axle Lubricant CXY-80W90-1L	WSP-M2C197-A ¹
Optional Rear axle fluid (U.S. and Mexico): (S-140) Motorcraft® SAE 75W-140 Synthetic Rear Axle Lubricant XY-75W140-QL	WSL-M2C192-A ¹
Optional Rear axle fluid (Canada): (S-140) Motorcraft® SAE 75W-140 Synthetic Rear Axle Lubricant CXY-75W140-1L	WSL-M2C192-A ¹
Recommended Rear axle fluid (U.S. and Mexico): (S-170) Motorcraft® SAE 80W-90 Premium Rear Axle Lubricant XY-80W90-QL	WSP-M2C197-A
Recommended Rear axle fluid (Canada): (S-170) Motorcraft® SAE 80W-90 Premium Rear Axle Lubricant CXY-80W90-1L	WSP-M2C197-A

Capacities and Specifications

Name	Specification
Optional Rear axle fluid (U.S. and Mexico): (S-170) Motorcraft® SAE 75W-140 Synthetic Rear Axle Lubricant XY-75W140-QL	WSL-M2C192-A
Optional Rear axle fluid (Canada): (S-170) Motorcraft® SAE 75W-140 Synthetic Rear Axle Lubricant CXY-75W140-1L	WSL-M2C192-A
Recommended Rear axle fluid (U.S. and Mexico): (S-190) Motorcraft® SAE 80W-90 Premium Rear Axle Lubricant XY-80W90-QL	WSP-M2C197-A
Recommended Rear axle fluid (Canada): (S-190) Motorcraft® SAE 80W-90 Premium Rear Axle Lubricant CXY-80W90-1L	WSP-M2C197-A
Optional Rear axle fluid (U.S. and Mexico): (S-190) Motorcraft® SAE 75W-140 Synthetic Rear Axle Lubricant XY-75W140-QL	WSL-M2C192-A
Optional Rear axle fluid (Canada): (S-190) Motorcraft® SAE 75W-140 Synthetic Rear Axle Lubricant CXY-75W140-1L	WSL-M2C192-A
Recommended Rear axle fluid (U.S.): (21060S) Motorcraft® SAE 80W-90 Premium Rear Axle Lubricant XY-80W90-QL	WSP-M2C197-A
Recommended Rear axle fluid (Canada): (21060S) Motorcraft® SAE 80W-90 Premium Rear Axle Lubricant CXY-80W90-1L	WSP-M2C197-A
Optional Rear axle fluid (U.S.): (21060S) Motorcraft® SAE 75W-140 Synthetic Rear Axle Lubricant XY-75W140-QL	WSL-M2C192-A
Optional Rear axle fluid (Canada): (21060S) Motorcraft® SAE 75W-140 Synthetic Rear Axle Lubricant CXY-75W140-1L	WSL-M2C192-A
Power steering fluid: Motorcraft® MERCON LV XT-10-QLVC	WSS-M2C938-A MERCON LV
Windshield washer fluid (U.S. and Mexico): Motorcraft® Premium Windshield Wash Concentrate with Bitterant ZC-32-B2	WSB-M8B16-A2

Capacities and Specifications

Name	Specification
Windshield washer fluid (Canada): Motorcraft® Premium Quality Windshield Washer Fluid CXC-37-(A, B, D, F)	WSB-M8B16-A2
A/C refrigerant (U.S.): Motorcraft® R-134a Refrigerant YN-19	WSH-M17B19-A
A/C refrigerant (Canada): Motorcraft® R-134a Refrigerant CYN-16-R	WSH-M17B19-A
A/C refrigerant (Mexico): Motorcraft® R-134a Refrigerant MYN-19	WSH-M17B19-A
A/C refrigerant compressor oil: Motorcraft® PAG Refrigerant Compressor Oil YN-12-D	WSH-M1C231-B
Multi-purpose grease: Motorcraft® Multi-Purpose Grease Spray XL-5-A	ESB-M1C93-B
Lock cylinders (U.S.): Penetrating and Lock Lubricant XL-1	--
Lock cylinders (Canada): Penetrating Fluid CXC-51-A	--
Lock cylinders (Mexico): Penetrating and Lock Lubricant MXL-1	--
Transmission, parking brake linkages and pivots, brake pedal shift: Motorcraft® Premium Long-Life Grease XG-1-E1	WSD-M1C227-A

¹Motorcraft® SAE 75W-140 Synthetic Rear Axle Lubricant is standard for (Limited Series) vehicles.

If you use oil and fluids that do not meet the defined specification and viscosity grade, this may lead to:

- Component damage which is not covered by the vehicle warranty.
- Longer engine cranking periods.

Capacities and Specifications

- Increased emission levels.
- Reduced engine performance.
- Reduced fuel economy.
- Degraded brake performance.

We recommend Motorcraft® motor oil for your vehicle. If Motorcraft® oil is not available, use motor oils of the recommended viscosity grade that meet API SN requirements and display the API Certification Mark for gasoline engines. Do not use oil labeled with API SN service category unless the label also displays the API certification mark.



E142732

An oil that displays this symbol conforms to current engine, emission system and fuel economy performance standards of the International Lubricants Specification Advisory Committee (ILSAC).

Do not use supplemental engine oil additives because they are unnecessary and could lead to engine damage that may not be covered by your vehicle warranty.

Note: *Ford recommends using DOT 4 Low Viscosity (LV) High Performance Brake Fluid or equivalent meeting WSS-M6C65-A2. Use of any fluid other than the recommended fluid may cause degraded brake performance and not meet the Ford performance standards. Keep brake fluid clean and dry. Contamination with dirt, water, petroleum products or other materials may result in brake system damage and possible failure.*

Note: *Automatic transmissions that require MERCON LV transmission fluid should only use MERCON LV transmission fluid. The use of any other fluid may cause transmission damage.*

CAPACITIES AND SPECIFICATIONS - 6.7L DIESEL

Capacities

WARNING



The air conditioning refrigerant system contains refrigerant under high pressure. Only qualified personnel should service the air conditioning refrigerant system. Opening the air conditioning refrigerant system can cause personal injury.

Item	Capacity
Engine oil (with oil filter)	15.0 qt (14.2 L)
Engine coolant (primary high-temperature cooling system loop)	35.1 qt (33.2 L) ¹
Engine coolant additive (primary high-temperature cooling system loop)	48 fl oz (1.41 L) ²

Capacities and Specifications

Item	Capacity
Engine coolant (secondary cooling system)	15.1 qt (14.3 L) ¹
Engine coolant additive (secondary cooling system)	16.0 fl oz (473 ml) ²
Diesel Exhaust Fluid (DEF)	8 gal (30.2 L)
Fuel tank (Dual)(Left side)	61 gal (230.9 L) (Usable capacity) ³
	65 gal (246 L) (Liquid capacity)
Fuel tank (Dual)(Right side)	47 gal (177.9 L) (Usable capacity) ³
	50 gal (189.2 L) (Liquid capacity)
Fuel tank (Small)	47 gal (177.9 L) (Usable capacity) ³
	50 gal (189.2 L) (Liquid capacity)
Fuel tank (Medium)	53 gal (200.6 L) (Usable capacity) ³
	56 gal (211.9 L) (Liquid capacity)
Fuel tank (Large)	61 gal (230.9 L) (Usable capacity) ³
	65 gal (246 L) (Liquid capacity)
Brake Fluid	Between MIN and MAX on brake fluid reservoir
Automatic Transmission Fluid	16.3 qt (15.4 L) ⁴
Front axle wheel bearing oil (8500 lb axle)	6–7 fl oz (177–207 ml)
Front axle wheel bearing oil (all except 8500 lb axle)	12–13 fl oz (355–385 ml)

Capacities and Specifications

Item	Capacity
Rear axle (S-140)(13.5k, 17.5k, 19k single speed)	19 pt (9.0 L) ⁴
Rear axle (S-170)(23k single speed)	37 pt (17.5 L) ⁴
Rear axle (S-190)(26k single speed)	37 pt (17.5 L) ⁴
Rear axle (21060S)(21k single speed)	28 pt (13.2 L) ⁴
Rear axle (21065T/P)(21k two speed)	35 pt (16.6 L) ⁴
Power Steering (air brake equipped)	5.2 qt (4.9 L) ⁵
Power Steering (hydraulic brake equipped)	6.1 qt (5.8 L) ⁵
Windshield washer fluid	Fill as required
A/C refrigerant	26.5 oz (0.75 kg)
A/C refrigerant compressor oil	5.1 fl oz (150 ml) ⁶

¹Use the coolant type originally equipped in your vehicle. Using any other coolant may result in vehicle damage.

²Per addition if required.

³Do NOT fill above the 95% liquid capacity.

⁴Approximate dry fill capacity. Actual amount may vary during fluid changes.

⁵Capacities may be higher if the vehicle is equipped with a cooler. Always check to make sure the fluid level is in the acceptable range.

⁶This system uses mineral-based refrigerant oil to lubricate O-rings and fittings.

Capacities and Specifications

Specifications

Materials

Name	Specification
Recommended motor oil (U.S.): Motorcraft® SAE 10W-30 Super Duty Diesel Motor Oil XO-10W30-QSD	WSS-M2C171-E*
Recommended motor oil (Canada): Motorcraft® SAE 10W-30 Super Duty Diesel Motor Oil CXO-10W30-LSD12	WSS-M2C171-E*
Recommended motor oil (U.S.): Motorcraft® SAE 15W-40 Super Duty Diesel Motor Oil XO-15W40-QSD	WSS-M2C171-E*
Recommended motor oil (Canada): Motorcraft® SAE 15W-40 Super Duty Diesel Motor Oil CXO-15W40-LSD12	WSS-M2C171-E*
Recommended motor oil (U.S.): Motorcraft® SAE 5W-40 Full Synthetic Diesel Motor Oil XO-5W40-5QSD	WSS-M2C171-E*
Recommended motor oil (U.S.): Motorcraft® SAE 0W-40 Full Synthetic Diesel Motor Oil XO-0W40-DAS	WSS-M2C171-E*
Engine and secondary cooling system coolant (U.S.): Motorcraft® Orange Prediluted Antifreeze/Coolant VC-3DIL-B	WSS-M97B44-D2
Engine and secondary cooling system coolant (Canada): Motorcraft® Orange Prediluted Antifreeze/Coolant CVC-3DIL-B	WSS-M97B44-D2
Engine and secondary cooling system coolant additive: Motorcraft® Specialty Orange Engine Coolant Revitalizer VC-12	--
Diesel Exhaust Fluid (DEF): Motorcraft® Diesel Exhaust Fluid PM-27-Gal / PM-27-Jug	WSS-M99C130-A
Cetane Booster & Performance Improver (U.S.): Motorcraft® Cetane Booster & Performance Improver PM-22-A	--
Cetane Booster & Performance Improver (Canada):	--

Capacities and Specifications

Name	Specification
Motorcraft® Cetane Booster & Performance Improver PM-22-B	
Anti-Gel & Performance Improver (U.S.): Motorcraft® Anti-Gel & Performance Improver PM-23-A	--
Anti-Gel & Performance Improver (Canada): Motorcraft® Anti-Gel & Performance Improver PM-23-B	--
Brake fluid: Motorcraft® DOT 5.1 Motor Vehicle Brake Fluid PM-21	WSS-M6C65-A3
Automatic transmission fluid (U.S. and Mexico): Motorcraft® MERCON LV Automatic Transmission Fluid XT-10-QLVC	WSS-M2C938-A MERCON LV
Automatic transmission fluid (Canada): Motorcraft® MERCON LV Automatic Transmission Fluid CXT-10-QLVC	WSS-M2C938-A MERCON LV
Front axle (wheel bearing oil): Motorcraft® SAE 75W-140 Synthetic Rear Axle Lubricant XY-75W140-QL	WSL-M2C192-A
Recommended Rear axle fluid (U.S.): (S-140) Motorcraft® SAE 80W-90 Premium Rear Axle Lubricant XY-80W90-QL	WSP-M2C197-A
Recommended Rear axle fluid (Canada): (S-140) Motorcraft® SAE 80W-90 Premium Rear Axle Lubricant CXY-80W90-1L	WSP-M2C197-A
Optional Rear axle fluid (U.S.): (S-140) Motorcraft® SAE 75W-140 Synthetic Rear Axle Lubricant XY-75W140-QL	WSL-M2C192-A
Optional Rear axle fluid (Canada): (S-140) Motorcraft® SAE 75W-140 Synthetic Rear Axle Lubricant CXY-75W140-1L	WSL-M2C192-A
Recommended Rear axle fluid (U.S.): (S-170) Motorcraft® SAE 80W-90 Premium Rear Axle Lubricant XY-80W90-QL	WSP-M2C197-A
Recommended Rear axle fluid (U.S.): (S-170) Motorcraft® SAE 80W-90 Premium Rear Axle Lubricant	WSP-M2C197-A

Capacities and Specifications

Name	Specification
CXY-80W90-1L	
Optional Rear axle fluid (U.S.): (S-170) Motorcraft® SAE 75W-140 Synthetic Rear Axle Lubricant XY-75W140-QL	WSL-M2C192-A
Optional Rear axle fluid (Canada): (S-170) Motorcraft® SAE 75W-140 Synthetic Rear Axle Lubricant CXY-75W140-1L	WSL-M2C192-A
Recommended Rear axle fluid (U.S.): (S-190) Motorcraft® SAE 80W-90 Premium Rear Axle Lubricant XY-80W90-QL	WSP-M2C197-A
Recommended Rear axle fluid (Canada): (S-190) Motorcraft® SAE 80W-90 Premium Rear Axle Lubricant CXY-80W90-1L	WSP-M2C197-A
Optional Rear axle fluid (U.S.): (S-190) Motorcraft® SAE 75W-140 Synthetic Rear Axle Lubricant XY-75W140-QL	WSL-M2C192-A
Optional Rear axle fluid (Canada): (S-190) Motorcraft® SAE 75W-140 Synthetic Rear Axle Lubricant CXY-75W140-1L	WSL-M2C192-A
Recommended Rear axle fluid (U.S.): (21060S) Motorcraft® SAE 80W-90 Premium Rear Axle Lubricant XY-80W90-QL	WSP-M2C197-A
Recommended Rear axle fluid (Canada): (21060S) Motorcraft® SAE 80W-90 Premium Rear Axle Lubricant CXY-80W90-1L	WSP-M2C197-A
Optional Rear axle fluid (U.S.): (21060S) Motorcraft® SAE 75W-140 Synthetic Rear Axle Lubricant XY-75W140-QL	WSL-M2C192-A
Optional Rear axle fluid (Canada): (21060S) Motorcraft® SAE 75W-140 Synthetic Rear Axle Lubricant CXY-75W140-1L	WSL-M2C192-A
Recommended Rear axle fluid (U.S.): (21065T/P) Motorcraft® SAE 80W-90 Premium Rear Axle Lubricant XY-80W90-QL	WSP-M2C197-A
Recommended Rear axle fluid (Canada): (21065T/P) Motorcraft® SAE 80W-90 Premium Rear Axle Lubricant CXY-80W90-1L	WSP-M2C197-A

Capacities and Specifications

Name	Specification
Optional Rear axle fluid (U.S.): (21065T/P) Motorcraft® SAE 75W-140 Synthetic Rear Axle Lubricant XY-75W140-QL	WSL-M2C192-A
Optional Rear axle fluid (Canada): (21065T/P) Motorcraft® SAE 75W-140 Synthetic Rear Axle Lubricant CXY-75W140-1L	WSL-M2C192-A
Automatic transmission fluid (U.S. and Mexico): Motorcraft® MERCON LV Automatic Transmission Fluid XT-10-QLVC	WSS-M2C938-A MERCON LV
Automatic transmission fluid (Canada): Motorcraft® MERCON LV Automatic Transmission Fluid CXT-10-QLVC	WSS-M2C938-A MERCON LV
Windshield washer fluid (U.S. and Mexico): Motorcraft® Premium Windshield Wash Concentrate with Bitterant ZC-32-B2	WSB-M8B16-A2
Windshield washer fluid (Canada): Motorcraft® Premium Quality Windshield Washer Fluid CXC-37-(A, B, D, F)	WSB-M8B16-A2
Power steering fluid: Motorcraft® MERCON LV XT-10-QLVC	WSS-M2C938-A MERCON LV
A/C refrigerant (U.S.): Motorcraft® R-134a Refrigerant YN-19	WSH-M17B19-A
A/C refrigerant (Canada): Motorcraft® R-134a Refrigerant CYN-16-R	WSH-M17B19-A
A/C refrigerant (Mexico): Motorcraft® R-134a Refrigerant MYN-19	WSH-M17B19-A
A/C refrigerant compressor oil: Motorcraft® PAG Refrigerant Compressor Oil YN-12-D	WSH-M1C231-B
Multi-purpose grease: Motorcraft® Multi-Purpose Grease Spray XL-5-A	ESB-M1C93-B

Capacities and Specifications

Name	Specification
Lock cylinders (U.S.): Penetrating and Lock Lubricant XL-1	--
Lock cylinders (Canada): Penetrating Fluid CXC-51-A	--
Lock cylinders (Mexico): Penetrating and Lock Lubricant MXL-1	--
Transmission, parking brake linkages and pivots, brake pedal shift: Motorcraft® Premium Long-Life Grease XG-1-E1	WSD-M1C227-A

*See the SAE viscosities grades chart for correct temperature usage.

If you use oil and fluids that do not meet the defined specification and viscosity grade, this may lead to:

- Component damage which is not covered by the vehicle warranty.
- Longer engine cranking periods.
- Increased emission levels.
- Reduced engine performance.
- Reduced fuel economy.
- Degraded brake performance.

Note: *An engine block heater is recommended at temperatures below -10°F (-23°C).*

Engine Oil Specifications

The use of correct oil viscosities for diesel engines is important for satisfactory operation. Determine which oil viscosity best suits the temperature range you expect to encounter for the next service interval from the following SAE viscosity grade chart.

Capacities and Specifications

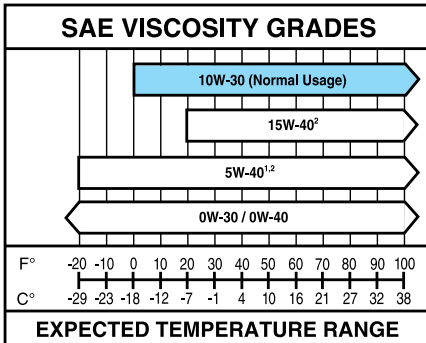

- (1) For severe duty service, use SAE 5W-40 API CJ-4.
- (2) For biodiesel fuel blends (B20 max), use SAE 5W-40 or SAE 15W-40 API CJ-4.

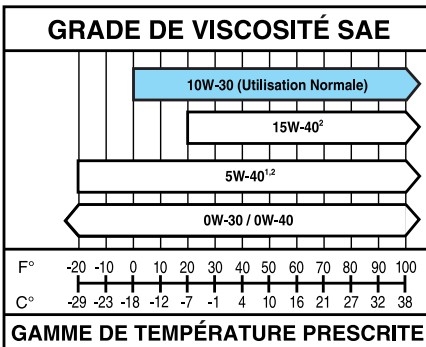

E163371

The American Petroleum Institute (API) service symbol is used to identify the proper engine oil for your engine. The API service symbol will be displayed on the oil container you purchase. The API symbol displays the oil performance category in the top half of the symbol and the viscosity grade in the center of the symbol.

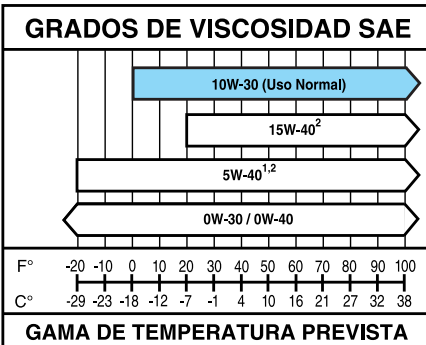

E163370

Audio System

GENERAL INFORMATION

Radio Frequencies and Reception Factors

AM and FM frequencies are established by the Federal Communications Commission (FCC) and the Canadian Radio and Telecommunications Commission (CRTC). Those frequencies are:

- AM: 530, 540-1700, 1710 kHz
- FM: 87.9-107.7, 107.9 MHz

Radio Reception Factors	
Distance and strength	The further you travel from an AM or FM station, the weaker the signal and the weaker the reception.
Terrain	Hills, mountains, tall buildings, bridges, tunnels, freeway overpasses, parking garages, dense tree foliage and thunderstorms can interfere with the reception.
Station overload	When you pass a ground-based broadcast repeating tower, a stronger signal may overtake a weaker one and result in the audio system muting.

CD and CD Player Information

Note: *CD units play commercially pressed 4.7 in (12 cm) audio compact discs only. Due to technical incompatibility, certain recordable and re-recordable compact discs may not function correctly when used in Ford CD players.*

Note: *Do not insert CDs with homemade paper (adhesive) labels into the CD player as the label may peel and cause the CD to become jammed. You should use a permanent felt tip marker rather than adhesive labels on your homemade CDs. Ballpoint pens may damage CDs. Please contact an authorized dealer for further information.*

Note: *Do not use any irregularly shaped discs or discs with a scratch protection film attached.*

Always handle discs by their edges only. Clean the disc with an approved CD cleaner only. Wipe it from the center of the disc toward the edge. Do not clean in a circular motion.

Do not expose discs to direct sunlight or heat sources for extended periods.

MP3 and WMA Track and Folder Structure

Audio systems capable of recognizing and playing MP3 and WMA individual tracks and folder structures work as follows:

- There are two different modes for MP3 and WMA disc playback: MP3 and WMA track mode (system default) and MP3 and WMA folder mode.
- MP3 and WMA track mode ignores any folder structure on the MP3 and WMA disc. The player numbers each MP3 and WMA track on the disc (noted by the MP3 or WMA file extension) from T001 to a maximum of T255. The maximum number of playable MP3 and WMA files may be less depending on the structure of the CD and exact model of radio present.

Audio System

- MP3 and WMA folder mode represents a folder structure consisting of one level of folders. The CD player numbers all MP3 and WMA tracks on the disc (noted by the MP3 or WMA file extension) and all folders containing MP3 and WMA files, from F001 (folder) T001 (track) to F253 T255.
- Creating discs with only one level of folders helps with navigation through the disc files.

If you are burning your own MP3 and WMA discs, it is important to understand how the system reads the structures you create. While various files may be present (files with extensions other than MP3 and WMA), only files with the MP3 and WMA extension are played; other files are ignored by the system. This enables you to use the same MP3 and WMA disc for a variety of tasks on your work computer, home computer and your in-vehicle system.

In track mode, the system displays and plays the structure as if it were only one level deep (all MP3 and WMA files play, regardless of being in a specific folder). In folder mode, the system only plays the MP3 and WMA files in the current folder.

AUDIO UNIT - VEHICLES WITH: AM/FM

WARNING



Driving while distracted can result in loss of vehicle control, crash and injury. We strongly recommend that you use extreme caution when using any device that may take your focus off the road. Your primary responsibility is the safe operation of your vehicle. We recommend against the use of any hand-held device while driving and encourage the use of voice-operated systems when possible. Make sure you are aware of all applicable local laws that may affect the use of electronic devices while driving.

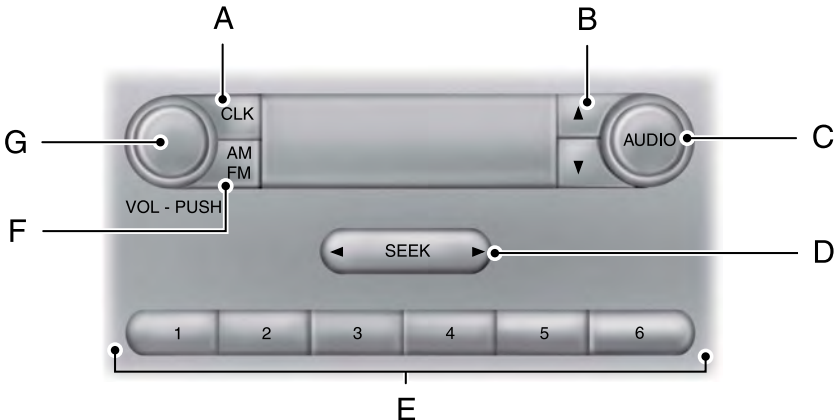

E163157

Audio System

- A **CLOCK:** Press to display the clock. To set the time, press and hold until the hours start to flash. Press the arrow buttons to adjust the hours, then repeat to set the minutes. Press again to exit clock mode.
- B **TUNE:** In radio mode, press to manually search through the radio frequency band.
- C **AUDIO:** Press to access settings for Treble, Midrange, Bass, Fade or Balance.
- D **Seek, Fast Forward and Reverse:** In radio mode, select a frequency band and press this button. The system stops at the first station it finds in that direction.
- E **Numeric keypad:** In radio mode, you can store your favorite radio stations. To store a radio station, tune to the station, then press and hold a preset button until sound returns.
- F **AM/FM:** Press to access different audio modes, for example AM, FM, audio input jack.
- G **VOL and Power:** Press to switch the system on and off. Turn to adjust the volume.

AUDIO UNIT - VEHICLES WITH: AM/FM/CD/SYNC

WARNING



Driving while distracted can result in loss of vehicle control, crash and injury. We strongly recommend that you use extreme caution when using any device that may take your focus off the road. Your primary responsibility is the safe operation of your vehicle. We recommend against the use of any hand-held device while driving and encourage the use of voice-operated systems when possible. Make sure you are aware of all applicable local laws that may affect the use of electronic devices while driving.

Audio System

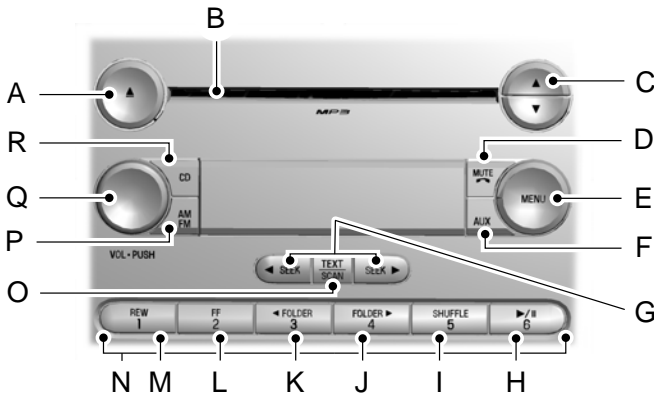

E169515

- A **Eject:** Press to eject a CD.
- B **CD slot:** Insert a CD.
- C **Tune:** Press to search through the radio frequency band manually. Press and hold for a fast search.
- D **Phone:** Press to access the phone features of the SYNC system. See **SYNC™** (page 281).
- E **MENU:** Press to access different audio system features.

If your vehicle is equipped with satellite radio, you can access different menus by pressing **OK**.

Set the time by pressing **MENU** until SET HOURS or SET MINUTES appears and using the arrow buttons to adjust the time.

Set the strongest stations on the radio frequency by pressing **MENU** until AUTOSET appears. AUTOSET does not override your original presets.

RBDS displays text transmitted by certain radio stations and searches for music categories. To search for music categories, turn on RBDS (by using the **SEEK** buttons when RBDS ON/OFF appears). Press the up and down arrow buttons to scroll through categories, then use the **SEEK** buttons to begin the search.

SPEEDVOL (speed compensated volume) allows you to adjust radio volume to compensate for noise levels when vehicle speed increases.

Audio System

Track/Folder is only available on MP3 files when in CD mode. In track mode, pressing the **SEEK** arrows allows you to scroll through all the tracks on the disc. In folder mode, pressing the **SEEK** arrows allows you to scroll through all the tracks within the selected folder. Press the **FOLDER** buttons to access other folders.

COMPRESS (Compression) is only available in CD and MP3 modes. Switching compression on brings the soft and loud passages together for a more consistent listening level. Use the **SEEK** buttons and up and down arrow buttons to switch it on and off.

- F **AUX:** Press to access the media features of the SYNC system. See **SYNC™** (page 281).
- G **SEEK:** In radio mode, press and release these buttons to go to the next (or previous) preset radio station or disc track. In CD and MP3 modes, press these buttons to select the next (or previous) track, or press and hold to advance (or reverse) within the same track.
- H **Play, Pause and OK:** Play and Pause allow you to play or pause a track when listening to a CD. **OK** allows you to confirm commands with phone and media features of the SYNC system. See **SYNC™** (page 281).
- I **SHUFFLE:** Play music on the selected CD or MP3 folder in random order.
- J **FOLDER >:** Press to access the next folder on an MP3 disc.
- K **< FOLDER:** Press to access the previous folder on an MP3 disc.
- L **FF:** Press to fast forward in a CD track or MP3 file manually.
- M **REW:** Press to rewind in a CD track or MP3 file manually.
- N **Memory presets:** Store your favorite radio stations. To store a radio station, tune to the station, then press and hold a preset button until sound returns.
- O **TEXT/SCAN:** In radio, CD and MP3 modes, press and hold to hear a brief sampling of radio stations, CD tracks or MP3 files. In CD and MP3 modes, press and release to display track title, artist name and disc title. In text mode, sometimes the display requires additional text to show. When the < / > indicator is on, press **TEXT** and then use the **SEEK** buttons to view the additional display text.
- P **AM/FM:** Press to select a frequency band.
- Q **VOL-PUSH:** Press to switch the system off and on. Turn it to adjust the volume.
- R **CD:** Press to enter CD or MP3 mode.

Audio System

SATELLITE RADIO (If Equipped)

SIRIUS® broadcasts a variety of music, news, sports, weather, traffic and entertainment satellite radio channels. For more information and a complete list of SIRIUS satellite radio channels, visit

www.siriusxm.com in the United States, www.siriusxm.ca in Canada, or call SIRIUS at 1-888-539-7474.

Note: *This receiver includes the eCos real-time operating system. eCos is published under the eCos License.*

Satellite Radio Reception Factors

Potential satellite radio reception issues	
Antenna obstructions	For optimal reception performance, keep the antenna clear of snow and ice build-up and keep luggage and other material as far away from the antenna as possible.
Terrain	Hills, mountains, tall buildings, bridges, tunnels, freeway overpasses, parking garages, dense tree foliage and thunderstorms can interfere with your reception.
Station overload	When you pass a ground-based broadcast-repeating tower, a stronger signal may overtake a weaker one and the audio system may mute.
Satellite radio signal interference	Your display may show ACQUIRING . . . to indicate the interference and the audio system may mute.

SIRIUS® Satellite Radio Service

Note: *SIRIUS reserves the unrestricted right to change, rearrange, add or delete programming including canceling, moving or adding particular channels, and its prices, at any time, with or without notice to you. Ford Motor Company shall not be responsible for any such programming changes.*

SIRIUS satellite radio is a subscription-based satellite radio service that broadcasts a variety of music, sports, news, weather, traffic and entertainment programming. Your factory-installed SIRIUS satellite radio system includes hardware and a limited subscription term, which begins on the date of sale or lease of your vehicle. See an authorized dealer for availability.

For more information on extended subscription terms (a service fee is required), the online media player and a complete list of SIRIUS satellite radio channels, and other features, please visit www.siriusxm.com in the United States, www.siriusxm.ca in Canada, or call SIRIUS at 1-888-539-7474.



E142593

Audio System

Satellite Radio Electronic Serial Number (ESN)

You need your ESN to activate, modify or track your satellite radio account. When in satellite radio mode, tune to channel 0.

Troubleshooting

Message	Condition	Action
Acquiring...	Radio requires more than two seconds to produce audio for the selected channel.	No action required. This message should disappear shortly.
Satellite antenna fault SIRIUS system failure	There is an internal module or system failure present.	If this message does not clear shortly, or with an ignition key cycle, your receiver may have a fault. See an authorized dealer for service.
Invalid Channel	The channel is no longer available.	Tune to another channel or choose another preset.
Unsubscribed Channel	Your subscription does not include this channel.	Contact SIRIUS at 1-888-539-7474 to subscribe to the channel, or tune to another channel.
No Signal	The signal is lost from the SIRIUS satellite or SIRIUS tower to your vehicle antenna.	The signal is blocked. When you move into an open area, the signal should return.
Updating...	Update of channel programming in progress.	No action required. The process may take up to three minutes.
Questions? Call 1-888-539-7474	Your satellite service is no longer available.	Contact SIRIUS at 1-888-539-7474 to resolve subscription issues.
None found Check Channel Guide	All the channels in the selected category are either skipped or locked.	Use the channel guide to turn off the Lock or Skip function on that station.
Subscription Updated	SIRIUS has updated the channels available for your vehicle.	No action required.

Audio System

AUDIO INPUT JACK

WARNINGS



Driving while distracted can result in loss of vehicle control, crash and injury. We strongly recommend that you use extreme caution when using any device that may take your focus off the road. Your primary responsibility is the safe operation of your vehicle. We recommend against the use of any hand-held device while driving and encourage the use of voice-operated systems when possible. Make sure you are aware of all applicable local laws that may affect the use of electronic devices while driving.



For safety reasons, do not connect or adjust the settings on your portable music player while your vehicle is moving.



Store the portable music player in a secure location, such as the center console or the glove box, when your vehicle is moving. Hard objects may become projectiles in a collision or sudden stop, which may increase the risk of serious injury. The audio extension cable must be long enough to allow the portable music player to be safely stored while your vehicle is moving.

The auxiliary input jack allows you to connect and play music from your portable music player through your vehicle speakers. You can use any portable music player designed for use with headphones. Your audio extension cable must have male 1/8th-inch (3.5 millimeter) connectors at each end.

1. Make sure your vehicle, radio and portable music player are turned off and the transmission is in position **P**.
2. Plug the extension cable from the portable music player into the AIJ.
3. Turn on the radio. Select either a tuned FM station or a CD.
4. Adjust the volume as desired.
5. Turn on your portable music player and adjust its volume to half its maximum level.
6. Press **AUX** until **LINE** or **LINE IN** appears in the display. You should hear music from your device even if it is low.
7. Adjust the volume on your portable music player until it reaches the volume level of the FM station or CD. Do this by switching back and forth between the AUX and FM or CD controls.

USB PORT (If Equipped)

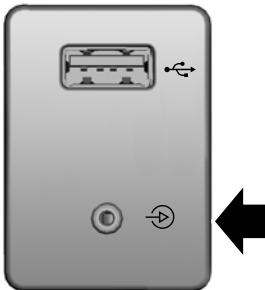

E163160

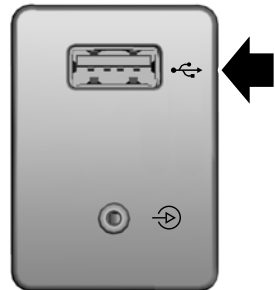

E163161

Audio System

The USB port allows you to plug in media playing devices, memory sticks and charge devices (if supported). See **SYNC™** (page 281).

GENERAL INFORMATION

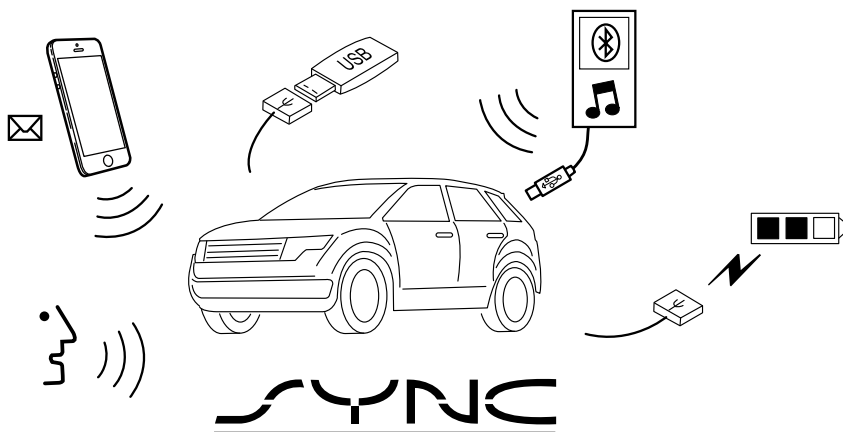

E198355

SYNC is an in-vehicle communications system that works with your Bluetooth-enabled cellular phone and portable media player. This allows you to:

- Make and receive calls.
- Access and play music from your portable music player.
- Access phonebook contacts and music using voice commands.
- Stream music from your connected phone.
- Text message.
- Use the advanced voice recognition system.
- Charge your USB device (if your device supports this).

Make sure that you review your device's manual before using it with SYNC.

Support

The SYNC support team is available to help you with any questions you cannot answer on your own.

Monday-Saturday, 8:30am-9:00pm EST.
Sunday, 10:30am-7:30pm EST.

In the United States, call 1-800-392-3673.
In Canada, call 1-800-565-3673.

Times are subject to change due to holidays.

SYNC Owner Account

Why do I need a SYNC owner account?

- Essential for keeping up with the latest software downloads available for SYNC.
- Access to customer support for any questions you may have.

Driving Restrictions

For your safety, certain features are speed-dependent and restricted when your vehicle is traveling over 3 mph (5 km/h).

Safety Information

WARNING



Driving while distracted can result in loss of vehicle control, crash and injury. We strongly recommend that you use extreme caution when using any device that may take your focus off the road. Your primary responsibility is the safe operation of your vehicle. We recommend against the use of any hand-held device while driving and encourage the use of voice-operated systems when possible. Make sure you are aware of all applicable local laws that may affect the use of electronic devices while driving.

When using SYNC:

- Do not operate playing devices if the power cords or cables are broken, split or damaged. Place cords and cables out of the way, so they do not interfere with the operation of pedals, seats, compartments or safe driving abilities.
- Do not leave playing devices in your vehicle during extreme conditions as it could cause them damage. See your device's manual for further information.
- Do not attempt to service or repair the system. See an authorized dealer.

Privacy Information

When a cellular phone is connected to SYNC, the system creates a profile within your vehicle that is linked to that cellular phone. This profile is created in order to offer you more cellular features and to operate more efficiently. Among other things, this profile may contain data about your cellular phone book, text messages (read and unread), and call history, including history of calls when your cellular phone was not connected to the system. In addition, if you connect a media device, the system creates and retains an index of supported media content. The system also records a short development log of approximately 10 minutes of all recent system activity. The log profile and other system data may be used to improve the system and help diagnose any problems that may occur.

The cellular profile, media device index, and development log will remain in the vehicle unless you delete them and are generally accessible only in the vehicle when the cellular phone or media player is connected. If you no longer plan to use the system or the vehicle, we recommend you perform a Master Reset to erase all stored information.

System data cannot be accessed without special equipment and access to the vehicle's SYNC module. Ford Motor Company and Ford of Canada will not access the system data for any purpose other than as described absent consent, a court order, or where required by law enforcement, other government authorities, or other third parties acting with lawful authority. Other parties may seek to access the information independently of Ford Motor Company and Ford of Canada.

USING VOICE RECOGNITION

This system helps you control many features using voice commands. This allows you to keep your hands on the wheel and focus on what is in front of you.

Helpful Hints

- Make sure the interior of your vehicle is as quiet as possible. Wind noise from open windows and road vibrations may prevent the system from correctly recognizing spoken commands.
- After pressing the voice button, wait until after the tone sounds and Listening appears before saying a command. Any command spoken before this does not register with the system.

- Speak naturally, without long pauses between words.
- At any time, you can interrupt the system while it is speaking by pressing the voice button.

Initiating a Voice Session



Initiate a voice session by pressing the voice button on the steering wheel controls. See

Steering Wheel (page 44).

When prompted you can say any of the following:

Voice command	If you want the system to carry out the following
Bluetooth Audio	Stream audio from your phone.
Cancel	Cancel the requested action.
Line In Aux Audio In	Access the device connected to the auxiliary input jack.
Phone	Make calls.
USB [1]	Access the device connected to your USB port.
Voice Settings Voice Preferences	Adjust the level of voice interaction and feedback.
Help	Hear a list of voice commands available in the current mode.

You can say any of the voice commands that appear within open and close brackets that are separated by |. For example, where (line in| Aux | Audio In) appears you say; line in, aux or audio in.

You do not need to say words that appear within square brackets. For example, for where USB [1] appears, you can say just USB.

System Interaction and Feedback

The system provides feedback through audible tones, prompts, questions and spoken confirmations depending on the situation and the chosen level of interaction (voice settings). You can customize the voice recognition system to provide more or less instruction and feedback.

The default setting is to a higher level of interaction in order to help you learn to use the system. You can change these settings at any time.

Adjusting the Interaction Level



Initiate a voice session by pressing the voice button on the steering wheel controls. See

Steering Wheel (page 44).

When prompted say the following:

Voice command	If you want the system to carry out the following
Voice Settings Voice Preferences	
Followed by either of the following:	
Interaction Mode Standard	Provide more detailed interaction and guidance.
Interaction Mode Advanced	Provide less audible interaction and more tone prompts.

The system defaults to the standard interaction mode.

Confirmation prompts are short questions the system asks when it is not sure of your request or when there are multiple possible responses to your request. For example, the system may ask "Phone, is that correct?". If turned off, the system simply makes a best guess as to what you requested and may ask you to confirm settings.

Voice command	If you want the system to carry out the following
Confirmation Prompts Off	Make a best guess from the command; you may still occasionally be asked to confirm settings.
Confirmation Prompts On	Clarify your voice command with a short question.

SYNC™ (If Equipped)

The system creates candidate lists when it has the same confidence level of several options based on your voice command. When turned on, it may prompt you with as many as four possibilities for clarification.

For example, say "Say 1 after the tone to call John Doe at home. Say 2 after the tone to call Johnny Doe on mobile. Say 3 after the tone to call Jane Doe at home." You could also say "Say 1 after the tone to play John Doe, Say 2 after the tone to play Johnny Doe."

Voice command	If you want the system to carry out the following
Media Candidate Lists Off	Make a best guess from the media candidate list. You may still occasionally be asked questions.
Media Candidate Lists On	Clarify your voice command for media candidates.
Phone Candidate Lists Off	Make a best guess from the phone candidate list. You may still occasionally be asked questions.
Phone Candidate Lists On	Clarify your voice command for phone candidates.

USING SYNC™ WITH YOUR PHONE

Hands-free calling is one of the main features of SYNC. While the system supports a variety of features, many are dependent on your cell phone's functionality. At a minimum, most cell phones with Bluetooth wireless technology support the following functions:

- Answering an incoming call.
- Ending a call.
- Using privacy mode.
- Dialing a number.
- Redialing.
- Call waiting notification.
- Caller ID.

Other features, such as text messaging using Bluetooth and automatic phonebook download, are cell phone-dependent features. To check your cell phone's compatibility, see your cell phone's manual and visit www.SYNCMYRide.com, www.SYNCMYRide.ca or www.syncmaroute.ca.

Pairing a Cell Phone for the First Time

Note: SYNC can support downloading up to approximately 1000 entries per Bluetooth-enabled cell phone.

Note: Make sure to switch on the ignition and the radio. Put the transmission in position park (P).

Note: To scroll through the menus, press the up and down arrows on your audio system.

Wirelessly pairing your cell phone with SYNC allows you to make and receive hands-free calls.

SYNC™ (If Equipped)

Press the phone button. When the display indicates there is no paired cell phone, do the following:

Message	Action and Description
No Phone Paired	Press the OK button.
Add	<ol style="list-style-type: none">1. Press the OK button.2. Put your cell phone into Bluetooth discovery mode. See your device's manual if necessary.3. When prompted on your cell phone's display, enter the six-digit PIN provided by SYNC in the radio display. The display indicates when the pairing is successful.

Depending on your cell phone's capability and your market, the system may prompt you with questions, such as setting the current cell phone as the primary cell phone (the cell phone SYNC automatically tries to connect with first upon vehicle start-up) and downloading your phonebook.

Pairing Subsequent Cell Phones

Note: *To scroll through the menus, press the up and down arrows on your audio system.*

Note: *Make sure to switch on the ignition and the radio. Put the transmission in position park (P).*

Press the phone button and then scroll to:

Message	Action
Phone settings	Press the OK button.
Bluetooth device	Press the OK button.
Add	Press the OK button. When the following message appears in the display:
Find SYNC	<ol style="list-style-type: none">1. Press the OK button.2. Put your cell phone into Bluetooth discovery mode. See your device's manual if necessary.3. When prompted on your cell phone's display, enter the six-digit PIN provided by SYNC in the radio display. The display indicates when the pairing is successful.

The system then prompts with questions, such as if you would like to set the current cell phone as the primary cell phone (the cell phone SYNC automatically tries to connect with first upon vehicle start-up) or download your phonebook.

Phone Voice Commands

Press the voice icon and say:

Voice Commands
Phone
You can then say any of the following commands.
Call History Incoming
Call History Missed
Call History Outgoing
Phonebook ___
Phonebook ___ at Home
Phonebook ___ at Work
Phonebook ___ in Office
Phonebook ___ on Cell

___ is a dynamic listing that should be the name of a contact in your phonebook. For example you could say "Call Mom".

You can also say any of the following:

Voice Command
Call ___
Call ___ at Home
Call ___ at Work
Call ___ in Office
Call ___ on Mobile
Call ___ on Other
Dial

None of these commands are available until you completely download your cell phone information using Bluetooth.

___ is a dynamic listing that should be the name of a contact in your phonebook. For example you could say "Call Mom".

The following commands are only available during active calls:

Voice Commands
Go To Privacy
Hold
Join

Phone Menu Commands

To access the phone menu with voice commands, press the voice button and when prompted say:

Voice Command
[Phone] Menu
You can then say any of the following:
[Phone] Connections [Media] Connections [Bluetooth] Connections
[Phone] Settings [Message] Notification On
[Phone] Settings [Message] Notification Off
[Phone] Settings [Set] Phone Ringer
[Phone] Settings [Set] Ringer 1
[Phone] Settings [Set] Ringer 2
[Phone] Settings [Set] Ringer 3
[Phone] Settings [Set] Ringer Off
Battery
Phone Name
Signal

Voice Command
Text Message Inbox
Send [New] Text Message

Phonebook Commands

When you ask SYNC to access content, for example the phonebook name or number, the requested information appears in the display to view.

You do not need to say word contained within brackets for the system to understand your command.

Note: To exit dial mode, press and hold the phone button or press MENU to go to the PHONE menu.

Making a Call

Press the voice button and when prompted say:

Voice Command	Action and Description
Call ___	This command is not available until you completely download your cell phone information using Bluetooth
Dial	Use to enter a phone number digit by digit.
When the system confirms the number, say one of the following commands:	
Dial	To confirm the number and initiate the call.
delete	To erase the last spoken digit. You can also press the left arrow button.
clear	To erase all spoken digits. You can also press and hold the left arrow button.

To end a call, press and hold the red phone button.

Receiving Calls

When receiving a call, you can:

- Answer the call by pressing the phone button.
- Reject the call by pressing and holding the red phone button.
- Ignore the call by doing nothing.

Phone Options during an Active Call

During an active call, you have more menu features that become available, for example putting a call on hold or joining calls. Use the arrow buttons to scroll through the menu options.

SYNC™ (If Equipped)

Press the MENU button during an active call, then scroll to:

Message	Action and Description		
Active call	Press the OK button.		
Select one of the following:			
Mute Call	Press the OK button to mute the call.		
Privacy	Press the OK button to switch a call from an active hands-free environment to your cell phone for a more private conversation.		
Hold	Press the OK button to put an active call on hold.		
Join calls	<p>Join two separate calls. SYNC supports a maximum of three callers on a multiparty call or conference call.</p> <ol style="list-style-type: none"> 1. Press the phone button. 2. Access the desired contact through SYNC or use voice commands to place the second call. Once actively in the second call, press MENU. 3. Scroll to Join Calls, and press the OK button. Wait until the following message appears. <table border="0" style="width: 100%; border-collapse: collapse;"> <tr> <td style="width: 60%; border-right: 1px solid black; padding-right: 10px;">Join calls</td> <td style="padding-left: 10px;">Press the OK button.</td> </tr> </table>	Join calls	Press the OK button.
Join calls	Press the OK button.		
Enter Tones	Enter tones such as numbers for passwords. Scroll until the desired number appears in the display, then press OK; a tone sounds as confirmation. Repeat as necessary.		
Phonebook	<p>To access your phonebook contacts.</p> <ol style="list-style-type: none"> 1. Press the OK button to select, and then scroll through your phonebook contacts. 2. Press the OK button again when the desired selection appears in the display. 3. Press the phone button to call the contact. 		
Call History	<p>To access your call history log.</p> <ol style="list-style-type: none"> 1. Press the OK button to select, then scroll through your call history options (incoming, outgoing or missed). 2. Press the OK button when the desired selection appears in the display. 3. Press the phone button to call the selection. 		
Return	Exit the current menu.		

SYNC™ (If Equipped)

Accessing Features Through the Phone Menu

The phone menu allows you to redial a

number, access your call history and phonebook, and send text messages as well as access cell phone and system settings.

Press the phone button to enter the Phone Menu, then scroll to:

Message	Action and Description
Phone Redial	Press the OK button to redial the last number called. Press the OK button again to confirm.
Call History	Access any previously dialed, received or missed calls after you connect your Bluetooth-enabled cell phone to SYNC ¹ . Press the OK button, select one of the following and press the OK button again to confirm. Incoming calls Outgoing calls Missed calls The system attempts to automatically re-download your phonebook and call history each time your cell phone connects to SYNC (if the auto download feature is on and your Bluetooth-enabled cell phone supports this feature).
Phonebook	Access and call any contacts in your previously downloaded phonebook ^{1,2} . If your phonebook has less than 255 entries, they appear alphabetically in flat file mode. If there are more than 255 entries, the system organizes them into alphabetical categories. <ol style="list-style-type: none">1. Press the OK button.2. Scroll to the desired contact.3. Press OK or the phone button to call the contact.
Text messaging	Press the OK button to send, download, read and delete text messages ¹ .
Phone settings	View your cell phone's status, set ring tones, select your message notification, change phonebook entries and automatically download your cell phone content, among other features ¹ .

SYNC™ (If Equipped)

Message	Action and Description
Sys Settings	Access Bluetooth Devices menu listings and advanced menu listings.
Exit	Press the OK button to exit the phone menu.

¹ This is a cell phone-dependent feature.

² This is a cell phone-dependent and speed-dependent feature.

Text Messaging

Note: This is a cell phone-dependent feature.

SYNC allows you to receive, send, download and delete text messages. The system can also read incoming text messages to you so that you do not have to take your eyes off the road.

Note: This is a cell phone-dependent feature.

Receiving a Text Message

Note: This is a cell phone-dependent feature. Your cell phone must support downloading text messages using Bluetooth to receive incoming text messages.

To have SYNC read you the message using voice commands, press the voice button and when prompted say:

Voice Command	Action and Description
Read Message Read Text Message Text Message	Press the OK button to have SYNC read the message to you.

To open the text message, press OK to receive and open the text message. Press OK again and SYNC reads your message aloud as you are not able to view the message. You can then also choose whether you would like to reply or forward the message.

Note: Forwarding a text message is a speed-dependent feature. It is only available when your vehicle is traveling at 3 mph (5 km/h) or less.

Note: Only one recipient is allowed per text message.

When a new text message arrives, an audible tone sounds and the information display indicates you have a new message.

Following the notification, you can do any of the following:

Do nothing to have the message go into your text message inbox.

SYNC™ (If Equipped)

Reply or forward the message, press OK and scroll to choose between:

Message	Action and Description
Reply to sender	Press the OK button to access and then scroll through the list of pre-defined messages to send.
Forward msg.	Press the OK button to forward the message to anyone in your Phonebook or Call History. You can also choose enter a number.

Sending, Downloading and Deleting Your Text Messages

Text messaging is a cell phone-dependent feature. If your cell phone is compatible, SYNC allows you to receive, send, download and delete text messages.

Note: *Sending a text message is a speed-dependent feature. It is only available when your vehicle is traveling at 3 mph (5 km/h) or less.*

Note: *You can only have one recipient per text message.*

Press the phone button, then scroll to:

Message	Action and Description
Text messaging	Press the OK button.

Select one of the following:

Send Text Message?	<p>Allows you to send a new text message based on a pre-defined set of 15 messages.</p> <ol style="list-style-type: none">1. Press the OK button.2. Scroll to your desired message.3. Press the OK button.4. Scroll through your phonebook, call history entries or enter a new number.5. Press the OK button to enter the desired contact.6. Press the OK button again when the system asks if you would like to send the message. The system sends each text message with the following signature: This message was sent from my Ford.
--------------------	---

SYNC™ (If Equipped)

Message	Action and Description
Download now	Allows you to download your unread messages to SYNC. To download the messages, press the OK button to select. The display indicates the system is downloading your messages. When downloading is complete, SYNC returns you to the inbox.
Delete All Messages?	Allows you to delete current text messages from SYNC. To delete the messages, press the OK button to select. The display indicates when it is finished deleting all your text messages. SYNC returns you to the text message menu.
Return	Press the OK button to exit the current menu.

Accessing Your Phone Settings

These are cell phone-dependent features. Your cell phone settings allow you to access and adjust some features. For example ring tones, text message notifications, modifying your phonebook and setting up automatic downloads.

Press the phone button, then scroll to:

Message	Action and Description
Phone settings	Press the OK button.
Select one of the following:	
Phone status	See the provider, name, signal power, battery power and roaming status of your connected cell phone. Press OK to select and scroll to view the information. When done, press OK again to return to the phone status menu.
Set ringtone	Select which ring tone sounds during an incoming call. You can choose one of the system ring tones or your cell phone ring tones. Press the OK button and scroll to hear the available options. You can also choose to use your phone's ring tone.
	Press the OK button to select the desired ring tone. If your cell phone supports in-band ringing, your cell phone ring plays when you choose the phone ringer option.
Text msg notify	You have the option of hearing an audible tone to notify you when a text message arrives.

SYNC™ (If Equipped)

Message	Action and Description	
	Press the OK button then select one of the following and press the OK button again to confirm. Message Notification On Message Notification Off	
Modify Phone-book	Modify the contents of your phone book (such as add, delete, download). Press OK to select and scroll between:	
	Add contacts	Press the OK button to add more contacts from your phonebook. Push the desired contact(s) on your cell phone. See your cell phone's manual on how to push contacts.
	Delete Phone-book	Press OK to delete the current phone book and call history. When Delete Phonebook appears, press OK to confirm. SYNC takes you back to the Phone Settings menu.
	Download Phonebook	Press OK to select and press OK again when Confirm Download? appears.
Auto-download	Automatically download your phone book each time your phone connects to SYNC. Press OK to select.	
	Auto On?	When this message appears, press OK to have your phonebook automatically downloaded each time. Select Off to NOT download your phonebook every time your phone connects to SYNC. Your phonebook, call history and text messages can only be accessed when your specific phone is connected to SYNC. *
Return	Exit the current menu.	

* Downloading times are cell phone-dependent and quantity-dependent. When Auto Download is on, it automatically deletes any changes, additions or deletions saved since your last download.

System Settings

This menu provides access to your Bluetooth Devices and Advanced menu features. Use the arrow buttons to scroll through the menu options.

Bluetooth Devices

The Bluetooth Devices menu allows you to add, connect and delete devices, set a cell phone as primary as well as switch your Bluetooth feature on and off.

SYNC™ (If Equipped)

Press the Phone button to enter the Phone Menu, then scroll to:

Message	Action and Description
Sys Settings	Press the OK button.
Bluetooth device	Press the OK button.
Select one of the following:	
Add BT device	Connect a previously paired Bluetooth-enabled phone. ^{1 2} Press OK to select and view a list of previously paired phones. Scroll until you choose the desired device, then press OK to connect the phone.
Set Primary?	Set a previously paired phone as your primary phone. ³ Press OK to select and scroll to select the desired phone. Press OK to confirm.
Bluetooth On and Off	Turn the Bluetooth feature on and off. ⁴ Press OK and scroll to toggle between On and Off. When the desired selection is chosen, press OK . Setting Bluetooth to off disconnects all Bluetooth devices and turns off all Bluetooth features.
Del Device	Delete a paired cell phone. Press the OK button and scroll to select the device. Press OK to confirm.
Delete all	Delete all previously paired phones (and all information originally saved with those phones). Press OK to select.
Return	Exit the current menu.

¹ This is a speed-dependent feature. It is only available when your vehicle is traveling at 3 mph (5 km/h) or less.

² You can only connect one device at a time. When another cell phone is connected, the previous one is disconnected.

³ SYNC attempts to connect with the primary phone at every ignition cycle. When a phone is selected as primary, it appears first in the list and is marked with an asterisk (*).

⁴ Turning Bluetooth off disconnects all Bluetooth devices and deactivates all Bluetooth features.

SYNC™ (If Equipped)

Advanced

The Advanced menu allows you to access

and set prompts, languages, defaults, perform a master reset, install an application and view system information.

To access the advanced menu, press the phone button to enter the Phone Menu, then scroll to:

Message	Action and Description
Sys Settings	Press OK .
Advanced	Press OK .
Select one of the following:	
Confirmation Prompts	<p>Get help from SYNC by using questions, helpful hints or asking you for a specific action. To turn these prompts on or off:</p> <ol style="list-style-type: none"> 1. Press the OK button to select and then scroll to select between On and Off. 2. Press the OK button when the desired selection appears in the display. SYNC returns you to the Advanced menu.
Language	<ol style="list-style-type: none"> 1. Press OK to select and then scroll through the languages. Choose between English, Français and Español. Once selected, all of the radio displays and prompts are in the selected language. 2. Press OK when the desired selection appears in the display. If you change the language setting, the display indicates that the system is updating. When complete, SYNC returns you to the Advanced menu.
Factory Defaults	<p>Return to the factory default settings. This selection does not erase your indexed information, for example phonebook, call history, text messages or paired devices. Press the OK button to select and then press OK again when the following message appears in the display.</p> <p>Confirm Restore</p>
Master reset	<p>Completely erase all information stored on SYNC, for example phonebook, call history, text messages and paired devices, and return the system to the factory default settings. Press OK to select. The display indicates when complete. SYNC returns you to the Advanced menu.</p>
System info	<p>Access the Auto Version number as well as the FDN number. Press the OK button to select.</p>
Return	Exit the current menu.

USING SYNC™ WITH YOUR MEDIA PLAYER

You can access and play music from your digital music player over your vehicle's speaker system using the system's media menu or voice commands. You can also sort and play your music by specific categories, for example artist and album.

Note: *The system is capable of indexing up to 6,000 songs.*

SYNC is capable of hosting nearly any digital media player including: iPod®, Zune™, plays from device players, and most USB drives. SYNC also supports the following audio formats MP3, WMA, WAV and ACC.

Connecting Your Digital Media Player to the USB Port

Note: *If your digital media player has a power switch, make sure you switch it on before plugging it in.*

To Connect Using Voice Commands

Plug the device into the USB port. See **USB Port** (page 279).



Press the voice button and when prompted say:

Voice command	Action and Description
USB [1]	You can now play music by saying any of the appropriate voice commands. See Media voice commands.

You do not need to say words that appear within square brackets. For example, for where USB [1] appears, you can say USB or USB one.

To Connect Using the System Menu

Plug the device into the USB port. See **USB Port** (page 279).

Press the **AUX** button, then the **Menu** button to enter the Media Menu.

You can then scroll to:

Message	Action and Description
Select Src	Press the OK button.
USB	Press the OK button. Depending on how many digital media files are on your connected device, the following message may appear in the radio display. Indexing...
When indexing is complete, the screen returns to the Play menu. You can then select one of the following:	

Message	Action and Description
Play all	
Artists	
Albums	
Genres	
Playlists	
Songs	
Browse USB	
Similar music	
Return	Exit the current menu.

What's Playing?

When a track is playing, you can ask the system to tell you what is currently playing.

Press the voice button and when prompted say:

Voice command	Action and Description
Whats This? Whats Playing?	The system reads the metadata tags of the playing track, and if the metadata tags are populated, the system will tell you what track is playing.

You can say any of the voice commands that appear within open and close brackets that are separated by |. For example, where; (what's | what is) appears you say; what's or what is.

You must say any of the voice commands that appear outside of open and close brackets. For example, where; who plays this (what's | what is) playing, you must say; who plays this (what's or what is) playing.

Media Voice Commands

Press the voice button and when prompted say any of the following:

Voice command	
USB [1]	
You can then say any of the following	
[Phone] Connections [Media] Connections [Bluetooth] Connections	
Pause	
Play	
Play All	
Play Artist ____	1,2
Play Album ____	1,2
Play Genre ____	1,2
[Play] Next Folder	3
[Play] Next Track [Play] Next Song	
Play Playlist ____	1,2
[Play] Previous Folder	3
[Play] Previous Track [Play] Previous Song	
[Play] Next Track [Play] Next Song	1,2
Repeat [On]	
Repeat Off	
Shuffle [On]	
Shuffle Off	
Search Album ____	1,2
Search Artist ____	1,2

Voice command		
Search Genre ____	The system searches all the data from your indexed music and, if available, begins to play the chosen type of music. You can only play genres of music which are present in the GENRE metadata tags that you have on your digital media player.	1,2
Search Track ____ Search Song ____	The system searches for a specific artist/track/album from the music indexed through the USB port.	1,2
Refine album ____	This allows you to make your previous command more specific. By using this command you can filter though a previous selection, such as an artist to play only specific album.	1,2
Similar Music	The system compiles a playlist and then plays similar music to what is currently playing from the USB port using indexed metadata information.	

Voice command	
Autoplay Off	
Autoplay [on]	Turn autoplay on to listen to music processed during indexing. Turn autoplay off to allow the indexing process to finish before the system plays any of your music.

¹ ___ is a dynamic listing, meaning that it could be the name of anything, such as a group, artist or song. For example, you could say "Play artist The Beatles".

² This voice command is not available until indexing is complete.

³ This voice command is only available in folder mode.

Bluetooth Audio Command Guide

Press the voice button and say:

Voice command
Bluetooth Audio
You can then say any of the following:
[Phone] Connections [Media] Connections [Bluetooth] Connections
Pause
Play
[Play] Next Track [Play] Next Song
[Play] Previous Track [Play] Previous Song

Media Menu Features

The media menu allows you to select your media source, how to play your music, for example by artist, genre, shuffle or repeat, and to add, connect or delete devices.

Press the **AUX** button, then the **Menu** button to enter the Media Menu.

You can then scroll to:

Message	Action and Description
Play Menu	Play your music by artist, album, genre, playlists, tracks, similar music or to simply play all. You can also choose to Explore USB to view the supported digital music files on your playing device. See Play Menu later in this section for more information.
Select one of the following:	
Select Src	USB Press the OK button to access music plugged into your USB port. You can also plug in devices to charge them (if supported by your device). Once connected, the system indexes any readable media files. ¹

SYNC™ (If Equipped)

Message	Action and Description	
	Bluetooth Audio	Press the OK button. This is a phone-dependent feature that allows you to stream music playing on your Bluetooth-enabled phone. If supported by your device, you can press seek to play the previous or next track.
	Line in	Press the OK button to select and play music from your portable music player over your vehicle's speakers. ²
Media Player Settings	Choose to shuffle or repeat your music and select your Auto-play settings. Once you turn these selections on, they remain on until you turn them off. Press SEEK to play the previous or next track. ³	
	Shuffle	Press the OK button to shuffle available media files in the current playlist. To shuffle all media tracks, you must select Play All in the play menu and then select Shuffle.
	Repeat	Press the OK button to repeat any song.
	Autoplay	Press the OK button to turn autoplay on to listen to music processed during indexing. Turn autoplay off to allow the indexing process to finish before the system plays any of your music. ⁴

SYNC™ (If Equipped)

Message	Action and Description
Sys Settings	Access available Bluetooth Device menu listings as well as Advanced menu listings.
Exit	Press OK to exit the media menu.

¹The time required to complete this depends on the size of the media the system needs to index. If autoplay is on, you can listen to media processed during indexing. If autoplay is off, you cannot listen to music until the system finishes indexing media. SYNC is capable of indexing thousands of average size media and notifies you if it reaches the maximum indexing file size.

²If you have already connected a device to the USB port, you cannot access the line in feature. Some digital media players require both USB and line in ports to stream data and music separately.

³Some digital media players require both USB and line in ports to stream data and music separately.

⁴Indexing times can vary from device to device and with regard to the number of songs the system needs to process.

Accessing Your Play Menu

This menu allows you to select and play your media by artist, album, genre, playlist, track, similar music or even to explore what is on your USB device.

Make sure that your device is plugged into the USB port and is turned on.

Press the **AUX** button, then the **Menu** button to enter the Media Menu.

You can then scroll to select:

Message	Action and Description
Play Menu	Press the OK button.
If there are no media files to access, the display indicates there is no media. If there are media files, you have the following options:	
Play all	Press the OK button. The first track title appears in the display. Play all indexed media (tracks) from your playing device in flat file mode, one at a time in numerical order.
Artists	Sort all indexed media by artist. Once selected, the system lists and then plays all artists and tracks alphabetically. If there are fewer than 255 indexed artists, the system lists them alphabetically in flat file mode. If there are more than 255, the system categorizes them alphabetically.

SYNC™ (If Equipped)

Message	Action and Description
	<ol style="list-style-type: none"><li data-bbox="370 213 999 265">1. Press the OK button. You can select to play all artists or any indexed artist.<li data-bbox="370 268 999 298">2. Scroll to choose the desired artist. Press the OK button.
Albums	<p data-bbox="370 322 999 417">Sort all indexed media by albums. If there are fewer than 255 indexed albums, the system lists them alphabetically in flat file mode. If there are more than 255, the system categorizes them alphabetically.</p> <ol style="list-style-type: none"><li data-bbox="370 431 999 501">1. Press the OK button. You can enter the album menu and select from playing all albums or from any individual indexed album.<li data-bbox="370 509 999 538">2. Scroll to choose the desired album. Press the OK button.
Genres	<p data-bbox="370 562 999 632">Sort indexed music by genre (category) type. SYNC lists the genres alphabetically in flat file mode. If there are more than 255, the system categorizes them alphabetically.</p> <ol style="list-style-type: none"><li data-bbox="370 647 999 676">1. Press the OK button.<li data-bbox="370 679 999 709">2. Scroll to select the desired genre. Press the OK button.
Playlists	<p data-bbox="370 733 999 828">Access your playlists from formats ASX, M3U, WPL or MTP. The system lists your playlists alphabetically in flat file mode. If there are more than 255, the system categorizes them alphabetically.</p> <ol style="list-style-type: none"><li data-bbox="370 842 999 872">1. Press the OK button.<li data-bbox="370 875 999 905">2. Scroll to select the desired playlist. Press the OK button.
Songs	<p data-bbox="370 926 999 995">Search for and play a specific indexed track. SYNC lists your tracks alphabetically in flat file mode. If there are more than 255, the system categorizes them alphabetically.</p> <ol style="list-style-type: none"><li data-bbox="370 1010 999 1040">1. Press the OK button.<li data-bbox="370 1043 999 1072">2. Scroll to select the desired track. Press the OK button.
Browse USB	<p data-bbox="370 1096 999 1191">Explore all supported digital media on your media device connected to the USB port. You can only view media content which is compatible with SYNC; other files saved are not visible.</p> <ol style="list-style-type: none"><li data-bbox="370 1206 999 1236">1. Press the OK button.<li data-bbox="370 1239 999 1268">2. Scroll to explore indexed media on your flash drive.

SYNC™ (If Equipped)

Message	Action and Description
Similar music	Play music similar to what is currently playing from the USB port. The system uses the metadata information of each song to compile a playlist for you.* <ol style="list-style-type: none">1. Press the OK button.2. The system creates a new list of similar songs and begins playing. This feature does not include tracks with incomplete metadata information. Press the OK button.
Return	Exit the current menu.

*With certain playing devices, if your metadata tags are not populated, the tracks are not available in voice recognition, play menu or similar music. However, if you place these tracks onto your playing device in "Mass Storage Device Mode", they are available in voice recognition, play menu browsing and similar music. The system places Unknown items into any unpopulated metadata tag.

System Settings

System settings provide access to your Bluetooth Devices and Advanced menu features.

Bluetooth Devices

The Bluetooth Devices menu allows you to enable, disable, add, connect and delete a Bluetooth device.

Press the **AUX** button, then the **Menu** button to enter the Media Menu.

You can then scroll to:

Message	Action and Description
Sys Settings	Press the OK button.
Bluetooth device	Press the OK button.

You can then select one of the following:

Add Device	Pair more devices to the system.* <ol style="list-style-type: none">1. Press the OK button. When find SYNC appears in the display, press the OK button again.2. Follow the directions in your phone's manual to put your phone into discovery mode. A six-digit PIN appears in the display.3. When prompted on your phone's six-digit display, enter the PIN.
------------	---

SYNC™ (If Equipped)

Message	Action and Description
Connect BT	Connect a previously paired Bluetooth-enabled phone. <ol style="list-style-type: none">1. Press OK to select and view a list of devices.2. Scroll until the desired device is chosen and press OK to connect the device.
Bluetooth On and Off	Turn the Bluetooth feature on and off.** <ol style="list-style-type: none">1. Press the OK button and scroll to toggle between on and off.2. Make a selection and press the OK button.
Delete	Delete a paired media device. <ol style="list-style-type: none">1. Press the OK button and scroll to select the device.2. Press the OK button to confirm.
Delete all	Delete all previously paired devices. <ol style="list-style-type: none">1. Press the OK button.2. Press the OK button to confirm.
Return	Exit the current menu.

*This is a speed-dependent feature. It is only available when your vehicle is traveling at 3 mph (5 km/h) or less.

**Setting Bluetooth to off disconnects all Bluetooth devices and turns off all Bluetooth features.

Advanced

Press the **AUX** button, then the **Menu** button to enter the Media Menu.

The Advanced menu allows you to access and set prompts, languages, defaults and perform a master reset.

You can then scroll to:

Message	Action and Description
Sys Settings	Press the OK button.
Advanced	Press the OK button.

You can then select one of the following:

SYNC™ (If Equipped)

Message	Action and Description
Confirmation Prompts	<p>Have SYNC guide you by asking questions, helpful hints or ask you for a specific action.</p> <ol style="list-style-type: none">1. Press the OK button and scroll to toggle between on and off.2. Make a selection and press the OK button. SYNC takes you back to the Advanced menu.
Language	<p>Choose from the available languages. The displays and prompts are in the selected language.</p> <ol style="list-style-type: none">1. Press the OK button and scroll through the available languages.2. Press the OK button when the desired language appears in the display.3. If you change the language setting, the display indicates that the system is updating. When complete, SYNC takes you back to the Advanced menu.
Factory Defaults	<p>Return to the factory default settings. This selection does not erase your indexed information, for example phonebook, call history, text messages and paired devices.</p> <ol style="list-style-type: none">1. Press the OK button.2. Press the OK button. When restore defaults appears in the display, press the OK button again to confirm.
Master reset	<p>Completely erase all information stored on SYNC. All phonebook, call history, text messages and all paired devices will be deleted and the system will return to the factory default settings.</p>
Return	<p>Exit the current menu.</p>

SYNC™ TROUBLESHOOTING

Your SYNC system is easy to use. However, should questions arise, see the tables below.

Use the website at any time to check your phone's compatibility, register your account and set preferences as well as access a customer representative via an online chat (during certain hours). Visit www.SYNCMyRide.com, www.SYNCMyRide.ca or www.syncmaroute.ca for more information.

SYNC™ (If Equipped)

Phone issues		
Issue	Possible cause(s)	Possible solution(s)
There is excessive background noise during a phone call.	The audio control settings on your phone may be affecting SYNC performance.	Review your phone's manual about audio adjustments.
During a call, I can hear the other person but they cannot hear me.	This may be a possible phone malfunction.	Try turning off the device, resetting the device, removing the device's battery, then trying again.
SYNC is not able to download my phonebook.	This is a phone-dependent feature. This may be a possible phone malfunction.	Go to the website to review your phone's compatibility. Try turning off the device, resetting the device or removing the device's battery, then trying again. Try pushing your phonebook contacts to SYNC by using the Add Contacts feature. Use the SYNCmyphone feature available on the website.
The system says Phonebook Downloaded but the phonebook in SYNC is empty or missing contacts.	This may be a limitation on your phone's capability.	Try pushing your phonebook contacts to SYNC by using the Add Contacts feature. If the missing contacts are stored on your SIM card, try moving them to the device memory. Remove any pictures or special ring tones associated with the missing contact.

SYNC™ (If Equipped)

Phone issues		
Issue	Possible cause(s)	Possible solution(s)
		Depending upon your phone, you may have to grant SYNC permission to access your phonebook contacts. Make sure to confirm when prompted by your phone during the phonebook download.
I am having trouble connecting my phone to SYNC.	This is a phone-dependent feature. This may be a possible phone malfunction.	Go to the website to review your phone's compatibility. Try turning off the device, resetting the device or removing the device's battery, then trying again. Try deleting your device from SYNC, deleting SYNC from your device and trying again. Check the security and auto accept and prompt always settings relative to the SYNC Bluetooth connection on your phone. Update your device's firmware. Turn off the Auto phonebook download setting.
Text messaging is not working on SYNC.	This is a phone-dependent feature. This may be a possible phone malfunction.	Go to the website to review your phone's compatibility. Try turning off the device, resetting the device or removing the device's battery, then trying again.

SYNC™ (If Equipped)

USB and media issues		
Issue	Possible cause(s)	Possible solution(s)
I am having trouble connecting my device.	This may be a possible device malfunction.	Try turning off the device, resetting the device, removing the device's battery, then trying again. Make sure you are using the manufacturer's cable. Make sure you insert the USB cable correctly into the device and the USB port. Make sure that the device does not have an auto-install program or active security settings.
SYNC does not recognize my device when I turn on the car.	This is a device limitation.	Make sure you are not leaving the device in your vehicle during very hot or cold temperatures.
Bluetooth audio does not stream.	This is a phone-dependent feature. The device is not connected.	Review the device compatibility chart on the SYNC website to confirm your phone supports the Bluetooth audio streaming function. Make sure you correctly connect the device to SYNC, and that you have pressed play on your device.
SYNC does not recognize music that is on my device.	Your music files may not contain the correct artist, song title, album or genre information. The file may be corrupted. The song may have copyright protection, which does not allow it to play.	Make sure that all song details are populated. Some devices require you to change the USB settings from mass storage to MTP class.

SYNC™ (If Equipped)

Voice command issues		
Issue	Possible cause(s)	Possible solution(s)
SYNC does not understand what I am saying.	You may be using the wrong voice commands. You may be speaking too soon or at the wrong time.	Review the phone voice commands and the media voice commands at the beginning of their respective sections. After pressing the voice icon, wait until after the tone sounds and Listening appears before saying a command. Any command spoken before this does not register with the system.
SYNC does not understand the name of a song or artist.	You may be using the wrong voice commands. You may be saying the name differently than the way you saved it. The system may not be reading the name the same way you are saying it.	Review the media voice commands at the beginning of the media section. Say the song or artist exactly as listed. If you say "Play Artist Prince", the system does not play music by Prince and the Revolution or Prince and the New Power Generation. Make sure you are saying the complete title, such as "California remix featuring Jennifer Nettles". If the song titles are in all CAPS, you have to spell them. LOLA requires you to say "L-O-L-A". Do not use special characters in the title. The system does not recognize them.
SYNC does not understand or is calling the wrong contact when I want to make a call.	You may be using the wrong voice commands. You may be saying the name differently than the way you saved it.	Review the Phone voice commands at the beginning of the phone section.

SYNC™ (If Equipped)

Voice command issues		
Issue	Possible cause(s)	Possible solution(s)
	<p>The system may not be reading the name the same way you are saying it. Contacts in your phonebook may be very short and similar, or they may contain special characters. Your phonebook contacts may be in CAPS.</p>	<p>Make sure you are saying the contacts exactly as they are listed. For example, if you save a contact as Joe Wilson, say "Call Joe Wilson".</p> <p>Using the SYNC phone menu, open the phonebook and scroll to the name SYNC is having trouble understanding. SYNC will read the name to you, giving you some idea of the pronunciation SYNC is expecting.</p> <p>The system works better if you list full names, such as "Joe Wilson" rather than "Joe".</p> <p>Do not use special characters, such as 123 or ICE, as the system does not recognize them.</p> <p>If a contact is in CAPS, you have to spell it. JAKE requires you to say "Call J-A-K-E".</p>

Accessories

AUXILIARY SWITCHES (If Equipped)

For maximum vehicle performance, keep the following information in mind when adding accessories or equipment to your vehicle:

- When adding accessories, equipment, passengers and luggage to your vehicle, do not exceed the total weight capacity of the vehicle or of the front or rear axle (GVWR or GAWR as indicated on the Safety Compliance Certification label). Ask an authorized dealer for specific weight information.
- The Federal Communications Commission (FCC) and Canadian Radio Telecommunications Commission (CRTC) regulate the use of mobile communications systems equipped with radio transmitters, for example, two-way radios, telephones and theft alarms. Any such equipment installed in your vehicle should comply with Federal Communications Commission (FCC) and Canadian Radio Telecommunications Commission (CRTC) regulations, and should be installed by an authorized dealer.
- An authorized dealer needs to install mobile communications systems. Improper installation may harm the operation of your vehicle, particularly if the manufacturer did not design the mobile communication system specifically for automotive use.
- If you or an authorized Ford dealer add any non-Ford electrical or electronic accessories or components to your vehicle, you may adversely affect battery performance and durability. In addition, you may also adversely affect the performance of other electrical systems in the vehicle.



E163431

The auxiliary switch option package provides four switches, mounted in the center of the instrument panel. These switches operate only while the ignition is in the on position, whether the engine is running or not. Ford recommends, however, that the engine remain running to maintain battery charge when using the auxiliary switches for extended periods of time or higher current draws.

Note: *When your vehicle has a diesel engine, use the auxiliary switches only while the engine is running. The glow plugs also drain battery power when the ignition key is in the on position. Using the auxiliary switches, even for limited amounts of time, can cause your battery to drain quickly and prevent your vehicle from restarting.*

When switched on, the auxiliary switches provide 8 amps, 12 amps or 20 amps of electrical battery power for a variety of personal or commercial uses.

The relay box for the auxiliary switches is on the end of the left side of the instrument panel. See your authorized dealer for service.

The relays are coded as shown:

Accessories

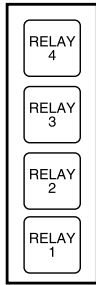

E163432

Each switch includes a power lead, a blunt-cut and sealed wire located below the instrument panel and to the left of the steering column.

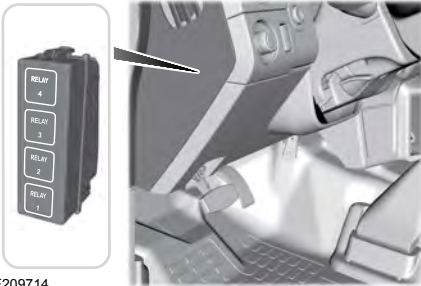

E209714

The power leads are coded as shown:

Switch	Circuit Number	Wire Color	Fuse Amp Rating
AUX 1	CAC05	Yellow	25A
AUX 2	CAC06	Green with Brown Trace	25A
AUX 3	CAC07	Violet with Green Trace	10A
AUX 4	CAC08	Brown	15A

Learn more about auxiliary switches by visiting:

Web Address
www.fleet.ford.com/truckbbas/

Ford Protect

PROTECT YOURSELF FROM THE RISING COST OF VEHICLE REPAIRS WITH FORD PROTECT.

Ford Protect (U.S. Only)

Ford Protect means peace of mind. It's the extended service plan backed by Ford Motor Company, and provides more protection beyond the New Vehicle Limited Warranty coverage.

Ford Protect Can Quickly Pay for Itself

One trip to the Service Center could easily exceed the price of your Ford Extended Service Plan. With Ford Protect you minimize your risk for unexpected repair bills and rising repair costs.

Up to 1,000+ Covered Vehicle Components

There are four core Ford Protect with different levels of coverage. Ask your authorized dealer for details.

1. PremiumCARE - Our most comprehensive coverage. With over 1,000 covered components, this plan is so complete it's probably easier to list what's not covered.
2. ExtraCARE - Covers 113 components, and includes many high-tech items.
3. BaseCARE - Covers 84 components.
4. PowertrainCARE - Covers 29 critical components.

Ford Protect is honored by all authorized Ford dealers in the U.S., Canada and Mexico.

That means you get:

- Reliable, quality service at any Ford or Lincoln dealership.
- Repairs performed by factory trained technicians, using genuine parts.

Rental Car Reimbursement

1st day Rental Benefit

If you bring your car into your dealer for service, we'll give you a loaner to use for the day.

Extended Rental Benefits

If your vehicle is kept overnight for covered repairs, you are eligible for rental car coverage, including bumper to bumper warranty repairs, and Field Service Actions.

Roadside Assistance

Exclusive 24/7 roadside assistance, including:

- Towing, flat-tire change and battery jump starts.
- Out of fuel and lock-out assistance.
- Travel expense reimbursement for lodging, meals and rental car.
- Assistance for taxi, shuttle, rental car coverage or other transportation.

Transferable Coverage

If you sell your vehicle before your Ford Protect plan coverage expires, you can transfer any remaining coverage to the new owner. Which should give you and your potential buyer a little more peace of mind.

Less Cost to Properly Maintain Your Vehicle

Ford Protect also offers a Premium Maintenance Plan that covers all scheduled maintenance, and selected wear items. The coverage is prepaid, so you never have to worry about the cost of your vehicle's maintenance.

Covered maintenance includes:

- Windshield wiper blades.
- Spark plugs.
- The clutch disc.

Ford Protect

- Brake pads and linings.
- Shock absorbers.
- Struts.
- Engine Belts.
- Engine coolant hoses, clamps and o-rings.
- Diesel exhaust fluid replenishment.

Interest Free Finance Options

Just a 10% down payment will provide you with an affordable, no interest, no fee payment program allowing you all the security and benefits Ford ESP has to offer while paying over time. You are pre-approved with no credit check or hassles. To learn more, call our Ford Protect Extended Service Plan specialists at 800-367-3377.

Ford Protect Extended Service Plan
P.O. Box 321067
Detroit, MI 48232

EXTENDED SERVICE PLAN (CANADA ONLY)

You can get more protection for your vehicle by purchasing a Ford Extended Service Plan. Ford Extended Service Plan is the only service contract backed by Ford Motor Company of Canada, Limited. Depending on the plan you purchase, Ford Extended Service Plan provides benefits such as:

- Rental reimbursement.
- Coverage for certain maintenance and wear items.
- Protection against repair costs after your New Vehicle Limited Warranty Coverage expires.
- Roadside Assistance benefits.

There are several Ford Extended Service Plans available in various time, distance and deductible combinations. Each plan is tailored to fit your own driving needs, including reimbursement for towing and rental. When you purchase Ford Extended Service Plan, you receive added peace-of-mind protection throughout Canada, the United States and Mexico, provided by a network of participating authorized Ford Motor Company dealers.

Note: *Repairs performed outside of Canada, the United States and Mexico are not eligible for Ford Extended Service Plan coverage.*

This information is subject to change. For more information, visit your local Ford of Canada dealer or www.ford.ca to find the Ford Extended Service Plan that is right for you.

Scheduled Maintenance

GENERAL MAINTENANCE INFORMATION

Why Maintain Your Vehicle?

Carefully following the maintenance schedule helps protect against major repair expenses resulting from neglect or inadequate maintenance and may help to increase the value of your vehicle when you sell or trade it. Keep all receipts for completed maintenance with your vehicle.

We have established regular maintenance intervals for your vehicle based upon rigorous testing. It is important that you have your vehicle serviced at the proper times. These intervals serve two purposes; one is to maintain the reliability of your vehicle and the second is to keep your cost of owning your vehicle down.

It is your responsibility to have all scheduled maintenance performed and to make sure that the materials used meet the specifications identified in this owner's manual. See **Capacities and Specifications** (page 258).

Failure to perform scheduled maintenance invalidates warranty coverage on parts affected by the lack of maintenance.

Why Maintain Your Vehicle at Your Dealership?

Factory-trained Technicians

Service technicians participate in extensive factory-sponsored certification training to help them become experts on the operation of your vehicle. Ask your dealership about the training and certification their technicians have received.

Genuine Ford and Motorcraft Replacement Parts

Dealerships stock Ford, Motorcraft and Ford-authorized branded re-manufactured replacement parts. These parts meet or exceed our specifications. Parts installed at your dealership carry a nationwide 12-month or 12000-mile (20000 kilometer) parts and labor limited warranty.

If you do not use Ford authorized parts they may not meet our specifications and depending on the part, it could affect emissions compliance.

Convenience

Many dealerships have extended evening and Saturday hours to make your service visit more convenient and they offer one stop shopping. They can perform any services that are required on your vehicle, from general maintenance to collision repairs.

Note: *Not all dealers have extended hours or body shops. Please contact your dealer for details.*

Protecting Your Investment

Maintenance is an investment that pays dividends in the form of improved reliability, durability and resale value. To maintain the proper performance of your vehicle and its emission control systems, make sure you have scheduled maintenance performed at the designated intervals.

Diesel Engine

Your vehicle is equipped with the Intelligent Oil-Life Monitor system, which displays a message in the information display at the proper oil change interval. This interval may be up to one year or 10000 miles (16000 kilometers).

Scheduled Maintenance

A message appears in the information display when it is time for an oil change. Make sure you perform the oil change within two weeks or 500 miles (800 kilometers) of the message appearing. Make sure you reset the Intelligent Oil-Life Monitor after each oil change. See **Instrument Cluster** (page 54).

If your information display resets prematurely or becomes inoperative, you should perform the oil change interval at six months or 5000 miles (8000 kilometers) from your last oil change. Never exceed one year or 10000 miles (16000 kilometers) between oil change intervals.

All Vehicles

Your vehicle is very sophisticated and built with multiple, complex, performance systems. Every manufacturer develops these systems using different specifications and performance features. That is why it is important to rely upon your dealership to properly diagnose and repair your vehicle.

Ford Motor Company has recommended maintenance intervals for various parts and component systems based upon engineering testing. Ford Motor Company relies upon this testing to determine the most appropriate mileage for replacement of oils and fluids to protect your vehicle at the lowest overall cost to you and recommends against maintenance schedules that deviate from the scheduled maintenance information.

We strongly recommend the use of only genuine Ford, Motorcraft or Ford-authorized re-manufactured replacement parts engineered for your vehicle.

Additives and Chemicals

This owner's manual and the Ford Workshop Manual list the recommended additives and chemicals for your vehicle. We do not recommend using chemicals or additives not approved by us as part of your vehicle's normal maintenance. Please consult your warranty information.

Oils, Fluids and Flushing

In many cases, fluid discoloration is a normal operating characteristic and, by itself, does not necessarily indicate a concern or that the fluid needs to be changed. However, a qualified expert, such as the factory-trained technicians at your dealership, should inspect discolored fluids that also show signs of overheating or foreign material contamination immediately.

Make sure to change your vehicle's oils and fluids at the specified intervals or in conjunction with a repair. Flushing is a viable way to change fluid for many vehicle sub-systems during scheduled maintenance. It is critical that systems are flushed only with new fluid that is the same as that required to fill and operate the system or using a Ford-approved flushing chemical.

Emissions Control System

WARNING



Do not park, idle or drive your vehicle on dry grass or other dry ground cover. The emission system heats up the engine compartment and exhaust system, creating the risk of fire.

Scheduled Maintenance

To make sure the emissions control systems operate effectively, you should have the services listed in the maintenance schedule performed at the specified time and mileage intervals. You should avoid running out of fuel or turning off the ignition when your vehicle is moving, especially at high speeds.

Do not make unauthorized modifications to the engine or vehicle. Modifications causing increased amounts of unburned fuel to reach the exhaust system can significantly increase the temperature of the engine compartment and the exhaust system.

Avoid driving your vehicle if it does not operate properly. If the engine diesels (more than five seconds of engine run-on after shut-off), misfires, surges, stalls or backfires, see an authorized dealer. Be alert for fluid leakage, odor, smoke, loss of oil pressure, or charge indicator or over temperature warning.

Vehicles equipped with a diesel engine cannot use diesel fuel blended with waste oil if equipped with a catalytic converter-muffler. Waste lube oil blending in fuel plugs the catalytic converter-muffler, resulting in a significant loss of engine power.

Noise Emissions Warranty, Prohibited Tampering Acts and Maintenance

On January 1, 1978, Federal regulations became effective governing the noise emissions on trucks over 10000 pounds (4536 kilograms) GVWR. The following statements concerning prohibited tampering acts and maintenance and the noise warranty are found in the warranty information, and are applicable to completed trucks.

Tampering with Noise Control System Prohibited

Federal law prohibits the following acts or the causing thereof: (1) The removal or rendering inoperative, by any person other than for purposes of maintenance, repair or replacement, of any device or element of design incorporated into any new vehicle for the purpose of noise control prior to its sale or delivery to the ultimate purchaser or while it is in use, or (2) the use of the vehicle after such device or element of design has been removed or rendered inoperative by any person.

Among those acts presumed to constitute tampering are the following acts listed:

Vehicle system	Acts
Acoustical shielding	Removal of noise shields, hood blanket, tunnel liner or acoustical absorptive material.
Engine	Removal or rendering inoperative the engine speed governor to allow engine speed to exceed manufacturer specifications. Removal of engine mounted noise shield or oil pan enclosure.
Engine air induction	Removal of the air duct, silencer, air cleaner, and/or air cleaner element and baffle in air cleaner; re-indexing of air cleaner.

Scheduled Maintenance

Vehicle system	Acts
Exhaust	Removal or rendering inoperative exhaust system components including the catalytic converter - muffler assembly, inlet pipe, outlet pipe, resonator and flex pipe. Rotation of horizontal exhaust system directional outlet pipe to cause the exhaust to be emitted in a direction other than the orientation your vehicle was originally produced with.
Engine cooling	Removal or rendering inoperative the fan clutch. Removal or modification of the fan shroud. Replacing a fixed fan with a fan of increased diameter, different number of blades or different pitch width.
DEF (Diesel exhaust fluid)	Removal or rendering inoperative DEF system components including the DEF tank, dosing module, dosing supply module, dosing control unit, NOx electronic module or NOx sensor.

Emissions Control System(s) Laws

Federal law prohibits vehicle manufacturers, dealers and other persons engaged in the business of repairing, servicing, selling, leasing or trading motor vehicles, as well as fleet operators from knowingly removing or rendering an emissions control device or system inoperative. Further, modifications of the emissions control system(s) could create liability on the part of individual owners under the laws of some states. In Canada, modification of the emissions control system could create liability under applicable Federal or Provincial laws.

Maintenance

Instructions for maintenance and service of the noise control system have been included in the required maintenance services and in the general maintenance section. To further help minimize noise emissions degradation throughout the life of your vehicle, Ford Motor Company recommends that you operate this vehicle in the manner described within this owner's

manual. Caution should be exercised by the owner when installing replacement parts to be sure that a tampering act (as outlined above) is not committed. Note any inspection and service performed in the maintenance log.

Emissions Information Label

Emissions information appears on the Important Engine Information decal located on or near the engine.

Scheduled Maintenance Services

Maintenance service adjustments must conform to specifications contained in this manual, and those shown on the Important Engine Information decal. Perform the following services at scheduled intervals because they essential to the life and performance of your vehicle. Ford recommends that you perform maintenance on all designated items to achieve best vehicle operation.

Scheduled Maintenance

There are three types of maintenance intervals for general vehicle environments: On-Highway, City and Severe Service. In all applications, monitoring miles (kilometers) and time and when the engine is due for an oil change determine the actual interval. When the engine oil change is required before the truck lubrication interval, perform the lubrication at the same time in order to reduce your vehicle's time out of service.

Air Brake Adjustment

WARNING



Failure to maintain proper air brake adjustment can result in reduction or loss of braking ability.

A qualified service technician, keeping to the instructions in the service manual, should perform air brake inspection and adjustment or repairs.

Cam Brakes - Automatic Slack Adjusters

WARNING



Do not manually adjust the automatic slack adjusters to correct excessive push rod stroke as it may result in reduced brake effectiveness and a vehicle crash. Excessive push rod stroke indicates that a problem exists with the automatic adjuster, with the installation of the adjuster, or with foundation brake components that manual adjustment does not remedy. Seek service from a qualified facility for excessive push rod stroke.

Inspect standard air brakes equipped with automatic slack adjusters for proper brake adjustment as listed in the maintenance schedule charts.

However, inspect the brakes more frequently when subjecting them to heavy use or adverse operating conditions such as:

- Frequent brake applications while fully loaded.
- Operation on hilly or mountainous terrain.
- Frequent operation on dirt, gravel or mud.

Some aftermarket brake linings also require more frequent inspections.

Owner Checks and Services

Make sure you perform the following basic maintenance checks and inspections every month or at six-month intervals.

Scheduled Maintenance

Check every month
Air filter restriction gauge.*
Engine oil level.
Fuel and water separator. Drain if necessary, or if indicated by the information display.*
Function of all interior and exterior lights.
Holes and slots in the tail pipe to make sure they are functional and clear of debris.*
Tires (including spare) for wear and proper pressure.
Windshield washer fluid level.

*Diesel engine only.

Check every six months
Battery connections. Clean if necessary.
Body and door drain holes for obstructions. Clean if necessary.
Cooling system fluid level and coolant concentration (freeze-point protection).
Door weatherstrips for wear. Lubricate if necessary.
Hinges, latches and outside locks for proper operation. Lubricate if necessary.
Parking brake for proper operation.
Safety belts and seat latches for wear and function.
Safety warning lamps (brake, ABS, airbag and safety belt) for operation.
Washer spray and wiper operation. Clean or replace blades as necessary.

Scheduled Maintenance

Tightening lug nuts	
Single rear wheels	Tighten the lug nuts to the specified torque* at 500 miles (800 km) after any wheel disturbance (such as tire rotation, changing a flat tire or wheel removal).
Dual rear wheels	Tighten the wheel lug nuts to the specified torque* at 100 miles (160 km), and again at 500 miles (800 km) of new vehicle operation and after any wheel disturbance (such as tire rotation, changing a flat tire or wheel removal).

* See **Technical Specifications** (page 250).

Multi-point Inspection

In order to keep your vehicle running right, it is important to have the systems on your vehicle checked regularly. This can help identify potential issues and prevent major problems. We recommend having the following multi-point inspection performed at every scheduled maintenance interval to help make sure your vehicle keeps running great.

Multi-point inspection	
Accessory drive belt(s)	Horn operation
Battery performance	Radiator, cooler, heater and A/C hoses
Engine air filter	Suspension component for leaks or damage
Exhaust system	Steering and linkage
Exterior lamps operation	Tires (including spare) for wear and proper pressure**
Fluid levels*; fill if necessary	Windshield for cracks, chips or pits

Scheduled Maintenance

Multi-point inspection	
For oil and fluid leaks	Washer spray and wiper operation
Hood rest for lubrication	Hazard warning system operation

*Brake, coolant recovery reservoir, automatic transmission, power steering and window washer.

**If your vehicle is equipped with a temporary mobility kit, check the tire sealant expiration Use By date on the canister. Replace as needed.

Be sure to ask your dealership service advisor or technician about the multi-point vehicle inspection. It is a comprehensive way to perform a thorough inspection of your vehicle. Your checklist gives you immediate feedback on the overall condition of your vehicle.

This means you do not have to remember to change the oil on a mileage-based schedule. Your vehicle lets you know when an oil change is due by displaying a message in the information display.

The following table provides examples of vehicle use and its impact on oil change intervals. It is a guideline only. Actual oil change intervals depend on several factors and generally decrease with severity of use.

NORMAL SCHEDULED MAINTENANCE

Intelligent Oil-Life Monitor™ (Diesel Engine Only)

Your diesel engine is equipped with an Intelligent Oil-Life Monitor that determines when you should change the engine oil based on how your vehicle is used. By using several important factors in its calculations, the monitor helps reduce the cost of owning your vehicle and reduces environmental waste at the same time.

When to expect the message prompting you to change your oil	
Interval	Vehicle use and example
7500-10000 miles (12000-16000 km)	Normal
	Normal commuting with highway driving No, or moderate, load or towing Flat to moderately hilly roads No extended idling
5000-7499 miles (8000-11999 km)	Severe

Scheduled Maintenance

When to expect the message prompting you to change your oil	
Interval	Vehicle use and example
	Moderate to heavy load or towing Mountainous or off-road conditions Extended idling Extended hot or cold operation
	Extreme
3000-4999 miles (4000-7999 km)	Maximum load or towing Extreme hot or cold operation Use of high sulfur diesel fuel

Note: Use the appropriate special operating condition for maintenance information when using high sulfur diesel fuels, operating your vehicle off-road or in dusty conditions (such as unpaved roads).

Normal Maintenance Intervals

Gasoline Engines

Every 7500 miles (12000 km) or six months (whichever comes first)
Change the engine oil and filter.
Rotate the tires*, inspect tire wear and measure tread depth.
Inspect the wheels and related components for abnormal noise, wear, looseness or drag.
Perform a multi-point inspection (recommended).
Inspect front oil hubs for leaks and check fluid level through hub cap sight glass.

*Vehicles with dual rear wheels should rotate the front wheels when specified; rear wheels only if unusual wear is noted.

Scheduled Maintenance

Every 15000 miles (24000 km) or 12 months (whichever comes first)	
Inspect the automatic transmission fluid level. Consult an authorized dealer for requirements.	
Inspect the brake pads, shoes, rotors, drums, brake linings, hoses and parking brake.	
Inspect the engine cooling system concentration (freeze-point protection), level and hoses.	
Inspect the exhaust system and heat shields.	
Inspect the steering linkage, ball joints, suspension, tie-rod ends, driveshaft and U-joints. Lubricate components equipped with grease fittings.	

Other maintenance items	
Every 30000 miles (48000 km)	Replace the engine air filter.
Every 60000 miles (96000 km)	Replace the front wheel bearing grease and grease seal if equipped with non-sealed bearings.
Every 97500 miles (156000 km)	Replace the spark plugs.
Every 105000 miles (168000 km)	Change the engine coolant.*
	Change the rear axle fluid. See Special Operating Conditions Scheduled Maintenance (page 328).
	Inspect the accessory drive belt(s).**
Every 150000 miles (240000 km)	Change the automatic transmission fluid and filter. Consult an authorized dealer for requirements.
	Replace the accessory drive belt(s) if not replaced within the last 100000 miles (160000 km).
	Replace the front wheel bearings and seals if equipped with non-sealed bearings.

* Initial replacement at six years or 105000 miles (168000 kilometers), then every three years or 45000 miles (72000 kilometers).

** If not replaced, inspect the belt(s) every 15000 miles (24000 kilometers).

Scheduled Maintenance

Diesel Engine

At every oil change interval as indicated by the information display¹
Change the engine oil and filter. ²
Drain the fuel filter water trap.
Refill the diesel exhaust fluid tank.
Rotate the tires ³ , inspect the tires for wear and measure tread depth.
Perform a multi-point inspection (recommended).
Inspect the air filter restriction gauge. Replace the filter if necessary.
Inspect the automatic transmission fluid level. Consult an authorized dealer for requirements.
Inspect the brake pads, shoes, rotors, drums, brake linings, hoses and parking brake.
Inspect the engine and secondary coolant concentration (freeze-point protection), level and hoses.
Inspect the exhaust system and heat shields.
Inspect the steering linkage, ball joints, suspension, tie-rod ends, driveshaft and U-joints. Lubricate components equipped with grease fittings.
Inspect front oil hubs for leaks and check fluid level through hub cap sight glass.

¹ Do not exceed one year or 10000 miles (16000 kilometers) between service intervals.

² Reset the Intelligent Oil-Life Monitor after engine oil and filter changes.

³ Vehicles with dual rear wheels should rotate the front wheels when specified; rear wheels only if unusual wear is noted.

Scheduled Maintenance

Other maintenance items¹	
Every 22500 miles (36000 km)	Replace the engine-mounted and frame-mounted fuel filters. ²
Every 30000 miles (48000 km)	Inspect engine and secondary cooling system coolant concentration (freeze-point protection), additive (corrosion inhibitor) strength, coolant level, and hoses. Add coolant additive if necessary. ³
Every 45000 miles (72000 km)	Replace the air inlet foam filter.
At 90000 miles (144000 km)	Inspect the accessory drive belt(s). ⁴
At 100000 miles (160000 km)	Change the rear axle fluid. See Special Operating Conditions Scheduled Maintenance (page 328). ⁵
Every 105000 miles (168000 km)	Change the engine and secondary cooling system coolant. ⁶ Change crankcase ventilation filter.
Every 150000 miles (240000 km)	Change the automatic transmission fluid and filter. Consult an authorized dealer for requirements.

Scheduled Maintenance

Other maintenance items ¹	
	Replace the accessory drive belt(s) if not replaced within the last 100000 miles (160000 km).
	Replace the front wheel bearings and seals.

¹ You can perform these maintenance items within 3000 miles (4800 kilometers) of the last oil change. Do not exceed the designated distance for the interval.

² Every 22500 miles (36000 kilometers) or as indicated by the information display.

³ Every 30000 miles (48000 kilometers), 1200 engine hours or as indicated by the information display.

Note: *When adding coolant additive, do not exceed the specified maximum of 48 fluid ounces (1.4 liters) for the engine and 16 fluid ounces (473 ml) for the secondary cooling system. Operating the engine with excessive coolant additive may cause overheating which could lead to severe, permanent engine damage.*

⁴ Perform follow-up inspections every 15000 miles (24000 kilometers) after the initial inspection. Replace the belt(s) at 150000 miles (240000 kilometers).

⁵ Change the fluid again at 150000 miles (240000 kilometers).

⁶ Initial replacement is at six years or 105000 miles (168000 kilometers), then every three years or 45000 miles (72000 kilometers).

SPECIAL OPERATING CONDITIONS SCHEDULED MAINTENANCE

Gasoline Engines

If you operate your vehicle **primarily** in any of the following conditions, you need to perform extra maintenance as indicated.

If you operate your vehicle **occasionally** under any of these conditions, it is not necessary to perform the extra maintenance. For specific recommendations, see your dealership service advisor or technician.

Scheduled Maintenance

Towing a trailer	
Inspect frequently, service as required	Inspect and lubricate U-joints.
	See axle maintenance items under Exceptions .
Every 5000 miles (8000 km)	Inspect the wheels and related components for abnormal noise, wear, looseness or drag.
	Rotate tires*, inspect tires for wear and measure tread depth.
Every 5000 miles (8000 km) or six months	Change engine oil and filter.
	Inspect and lubricate U-joints.
Every 60000 miles (96000 km)	Replace spark plugs.

*Vehicles with dual rear wheels should rotate the front wheels when specified; rear wheels only if unusual wear is noted.

Extensive idling or low-speed driving for long distances, as in heavy commercial use (such as delivery, taxi, patrol car or livery)	
Inspect frequently, service as required	Replace engine air filter.
Every 5000 miles (8000 km)	Inspect brake system.
	Inspect wheels and related components for abnormal noise, wear, looseness or drag.
	Lubricate control arm and steering ball joints if equipped with grease fittings.
	Rotate tires*, inspect tires for wear and measure tread depth.
Every 5000 miles (8000 km) or six months	Inspect and lubricate U-joints.

Scheduled Maintenance

Extensive idling or low-speed driving for long distances, as in heavy commercial use (such as delivery, taxi, patrol car or livery)	
Every 5000 miles (8000 km), six months or 200 engine hours	Change engine oil and filter.
Every 60000 miles (96000 km)	Replace spark plugs.

*Vehicles with dual rear wheels should rotate the front wheels when specified; rear wheels only if unusual wear is noted.

Operating in dusty or sandy conditions (such as unpaved or dusty roads)	
Inspect frequently, service as required	Replace engine air filter.
Every 5000 miles (8000 km)	Inspect the wheels and related components for abnormal noise, wear, looseness or drag.
	Rotate tires*, inspect tires for wear and measure tread depth.
Every 5000 miles (8000 km) or six months	Change engine oil and filter.
	Inspect and lubricate U-joints.

*Vehicles with dual rear wheels should rotate the front wheels when specified; rear wheels only if unusual wear is noted.

Off-road operation	
Inspect frequently, service as required	Inspect steering linkage, ball joints and U-joints, Lubricate if equipped with grease fittings.
	Replace engine air filter.
Every 5000 miles (8000 km) or six months	Change engine oil and filter.
	Inspect the wheels and related components for abnormal noise, wear, looseness or drag.
	Rotate tires*, inspect tires for wear and measure tread depth.

*Vehicles with dual rear wheels should rotate the front wheels when specified; rear wheels only if unusual wear is noted.

Scheduled Maintenance

Diesel Engine

If you operate your vehicle **primarily** in any of the following conditions, you need to perform extra maintenance as indicated. If you operate your vehicle **occasionally**

under any of these conditions, it is not necessary to perform the extra maintenance. For specific recommendations, see your dealership service advisor or technician.

Towing a trailer	
As required	Change the engine oil and filter as indicated by the information display, and perform the services listed in the scheduled maintenance chart.
	See the axle maintenance items under Exceptions .
Every 15000 miles (24000 km), 6 months, 600 engine hours, or as indicated by the information display	Replace the engine-mounted and frame-mounted fuel filters.
Every 30000 miles (48000 km) or 1200 engine hours	Inspect the coolant concentration (freeze-point protection) and additive (corrosion inhibitor) strength. Add coolant additive if necessary.
Every 60000 miles (96000 km) or 2400 engine hours	Flush and refill the coolant. Do not add coolant additive.

Note: When adding coolant additive, do not exceed the specified maximum of 48 fluid ounces (1.4 liters) for the engine and 16 fluid ounces (473 ml) for the secondary cooling system. Operating the engine with excessive coolant additive may cause overheating which could lead to severe, permanent engine damage.

Note: After the initial coolant flush and fill at 60000 miles (96000 kilometers) or 2400 engine hours, flush and fill every 45000 miles (72000 kilometers) or 1800 engine hours thereafter.

Scheduled Maintenance

Frequent or extended idling (over 10 minutes per hour of normal driving) or frequent low-speed operation if your vehicle is used for stationary operation	
As required	Change the engine oil and filter as indicated by the information display, and perform the services listed in the scheduled maintenance chart.
Every 15000 miles (24000 km), six months, 600 engine hours, or as indicated by the information display	Replace the engine-mounted and frame-mounted fuel filters.
Every 30000 miles (48000 km) or 1200 engine hours	Inspect the coolant concentration (freeze-point protection) and additive (corrosion inhibitor) strength. Add coolant additive if necessary.
Every 60000 miles (96000 km) or 2400 engine hours	Flush and refill the coolant. Do not add coolant additive.

Note: When adding coolant additive, do not exceed the specified maximum of 48 fluid ounces (1.4 liters) for the engine and 16 fluid ounces (473 ml) for the secondary cooling system. Operating the engine with excessive coolant additive may cause overheating which could lead to severe, permanent engine damage.

Note: After the initial coolant flush and fill at 60000 miles (96000 kilometers) or 2400 engine hours, flush and fill every 45000 miles (72000 kilometers) or 1800 engine hours thereafter.

Scheduled Maintenance

Frequent low-speed operation, consistent heavy traffic under 25 mph (40 km/h) or long rush-hour traffic	
As required	Change the engine oil and filter as indicated by the information display, and perform the services listed in the scheduled maintenance chart.
Every 15000 miles (24000 km), six months, 600 engine hours, or as indicated by the information display	Replace the engine-mounted and frame-mounted fuel filters.
Every 30000 miles (48000 km) or 1200 engine hours	Inspect the coolant concentration (freeze-point protection) and additive (corrosion inhibitor) strength. Add coolant additive if necessary.
Every 60000 miles (96000 km) or 2400 engine hours	Flush and refill the coolant. Do not add coolant additive.

Note: When adding coolant additive, do not exceed the specified maximum of 48 fluid ounces (1.4 liters) for the engine and 16 fluid ounces (473 ml) for the secondary cooling system. Operating the engine with excessive coolant additive may cause overheating which could lead to severe, permanent engine damage.

Note: After the initial coolant flush and fill at 60000 miles (96000 kilometers) or 2400 engine hours, flush and fill every 45000 miles (72000 kilometers) or 1800 engine hours thereafter.

Scheduled Maintenance

Sustained high-speed driving at gross vehicle weight rating (maximum loaded weight for vehicle operation)	
As required	Change the engine oil and filter as indicated by the information display, and perform the services listed in the scheduled maintenance chart.
Every 15000 miles (24000 km), six months, 600 engine hours, or as indicated by the information display	Replace the engine-mounted and frame-mounted fuel filters.
Every 30000 miles (48000 km) or 1200 engine hours	Inspect the coolant concentration (freeze-point protection) and additive (corrosion inhibitor) strength. Add coolant additive if necessary.
Every 60000 miles (96000 km) or 2400 engine hours	Flush and refill the coolant. Do not add coolant additive.

Note: When adding coolant additive, do not exceed the specified maximum of 48 fluid ounces (1.4 liters) for the engine and 16 fluid ounces (473 ml) for the secondary cooling system. Operating the engine with excessive coolant additive may cause overheating which could lead to severe, permanent engine damage.

Note: After the initial coolant flush and fill at 60000 miles (96000 kilometers) or 2400 engine hours, flush and fill every 45000 miles (72000 kilometers) or 1800 engine hours thereafter.

Operating in sustained ambient temperatures below -10°F (-23°C) or above 100°F (38°C)	
As required	Change the engine oil and filter as indicated by the information display, and perform the services listed in the scheduled maintenance chart.
Every 15000 miles (24000 km), six months, 600 engine hours, or as indicated by the information display	Replace the engine-mounted and frame-mounted fuel filters.

Scheduled Maintenance

Operating in dusty or sandy conditions (such as unpaved or dusty roads)	
Every 7500 miles (12000 km)	Rotate the tires*, inspect the tires for wear and measure tread depth.
	Inspect the brake system pads and rotors.
	Inspect the air filter restriction gauge. Replace the filter if necessary.
	Inspect the steering and suspension ball joints and tie rods. Lubricate any grease fittings.
Every 7500 miles (12000 km), six months or 300 engine hours	Change the engine oil and filter.**
	Inspect and lubricate the U-joints.
Every 15000 miles (24000 km), six months, 600 engine hours, or as indicated by the information display	Replace the engine-mounted and frame-mounted fuel filters.
Every 30000 miles (48000 km)	Replace the air inlet foam filter.

*Vehicles with dual rear wheels should rotate the front wheels when specified; rear wheels only if unusual wear is noted.

**Reset the Intelligent Oil-Life Monitor after engine oil and filter changes.

Off-road operation	
As required	Inspect functional holes in each leg of the twin exhaust tips and the holes under the shield just inboard of the right rear tire to make sure they are clean and clear of debris or foreign materials. Refer to the Vehicle Care chapter of your owner's manual for more information.
	Inspect the steering and suspension ball joints and tie rods. Lubricate any grease fittings.
Every 7500 miles (12000 km), six months or 300 engine hours	Rotate the tires*, inspect the tires for wear and measure tread depth.
	Inspect the brake system pads and rotors.
	Inspect the air filter restriction gauge. Replace the filter if necessary.

Scheduled Maintenance

Off-road operation	
Every 7500 miles (12000 km) or 300 engine hours	Change the engine oil and filter.**
Every 15000 miles (24000 km), six months, 600 engine hours, or as indicated by the information display	Replace the engine-mounted and frame-mounted fuel filters.
Every 30000 miles (48000 km)	Replace the air inlet foam filter.

*Vehicles with dual rear wheels should rotate the front wheels when specified; rear wheels only if unusual wear is noted.

**Reset the Intelligent Oil-Life Monitor after engine oil and filter changes.

Using biodiesel, up to and including 20% biodiesel (B20)	
As required	Change the engine oil and filter as indicated by the information display, and perform the services listed in the scheduled maintenance chart.
Every 15000 miles (24000 km), six months, 600 engine hours, or as indicated by the information display	Replace the engine-mounted and frame-mounted fuel filters.

Using fuel other than ultra-low sulfur diesel fuel - vehicles operated where ultra-low sulfur diesel fuel is not required or available	
Every 2500 miles (4000 km) or three months (if using high sulfur fuel with more than 500 ppm sulfur)	Change engine oil and filter.
Every 5000 miles (8000 km) or six months (if using high sulfur fuel with fewer than 500 ppm sulfur)	Change engine oil and filter.

Exceptions

There are several exceptions to the Normal Schedule:

Scheduled Maintenance

Rear Axle Maintenance

A rear axle fluid change or level check is not required unless a leak is suspected or the assembly has been submerged in water. During long periods of trailer towing with outside temperatures above 70°F (21°C), and at wide-open throttle for long periods above 45 mph (72 km/h), change the rear axle fluid every 24,000 mi (38,000 km) or three months, whichever comes first.

California Fuel Filter Replacement

If you register your vehicle in California, the California Air Resources Board has determined that the failure to perform this maintenance item does not nullify the emission warranty or limit recall liability before the completion of your vehicle's useful life. Ford Motor Company, however, urges you to have all recommended maintenance services performed at the specified intervals and to record all vehicle service.

Hot Climate Oil Change Intervals

The normal oil change interval is 3000 miles (5000 kilometers) for gasoline vehicles operating in the Middle East, North Africa, Sub-Saharan Africa or locations with similar climates using American Petroleum Institute (API) oils Certified for

Gasoline Engines and displaying the API Certification Mark. If API Certified Oils are not available, then it is acceptable to use API SM or SN oils. If API oils are not available, then the oil change interval is 1800 miles (3000 kilometers).

Engine Air Filter Replacement

The life of the engine air filter is dependent on exposure to dusty and dirty conditions. Vehicles operated in these conditions require frequent inspection and replacement of the engine air filter and cabin air filter.

Diesel Particulate Filter

The filter may need to be removed for ash cleaning at approximately 120000 miles (192000 kilometers) or greater (actual mileage can vary greatly depending upon engine and vehicle operating conditions) and replaced with a new or re-manufactured (ash cleaned) part. The filter may need to be replaced at approximately 250000 miles (400000 kilometers) depending upon engine and vehicle operating conditions. In both cases, the engine control system sets a service light (wrench icon) to inform you to bring your vehicle to the dealer for service. If there are any issues with the oxidation catalyst or particulate filter system, a service light (wrench or engine icon) sets by the engine control system to inform you to bring your vehicle into a dealer for service.

Scheduled Maintenance

SCHEDULED MAINTENANCE RECORD

<input type="radio"/> Repair Order #:	<p>Dealer stamp</p>
<input type="radio"/> Distance:	
<input type="radio"/> Engine hours (optional):	
<input type="radio"/> Multi-point inspection (recommended): <input type="checkbox"/>	
<input type="radio"/> Signature:	

<input type="radio"/> Repair Order #:	<p>Dealer stamp</p>
<input type="radio"/> Distance:	
<input type="radio"/> Engine hours (optional):	
<input type="radio"/> Multi-point inspection (recommended): <input type="checkbox"/>	
<input type="radio"/> Signature:	

Scheduled Maintenance

<input type="radio"/> Repair Order #:	Dealer stamp
<input type="radio"/> Distance:	
<input type="radio"/> Engine hours (optional):	
<input type="radio"/> Multi-point inspection (recommended): <input type="checkbox"/>	
<input type="radio"/> Signature:	

<input type="radio"/> Repair Order #:	Dealer stamp
<input type="radio"/> Distance:	
<input type="radio"/> Engine hours (optional):	
<input type="radio"/> Multi-point inspection (recommended): <input type="checkbox"/>	
<input type="radio"/> Signature:	

Scheduled Maintenance

<input type="radio"/> Repair Order #:	Dealer stamp
<input type="radio"/> Distance:	
<input type="radio"/> Engine hours (optional):	
<input type="radio"/> Multi-point inspection (recommended): <input type="checkbox"/>	
<input type="radio"/> Signature:	

<input type="radio"/> Repair Order #:	Dealer stamp
<input type="radio"/> Distance:	
<input type="radio"/> Engine hours (optional):	
<input type="radio"/> Multi-point inspection (recommended): <input type="checkbox"/>	
<input type="radio"/> Signature:	

Scheduled Maintenance

<input type="radio"/> Repair Order #:	Dealer stamp
<input type="radio"/> Distance:	
<input type="radio"/> Engine hours (optional):	
<input type="radio"/> Multi-point inspection (recommended): <input type="checkbox"/>	
<input type="radio"/> Signature:	

<input type="radio"/> Repair Order #:	Dealer stamp
<input type="radio"/> Distance:	
<input type="radio"/> Engine hours (optional):	
<input type="radio"/> Multi-point inspection (recommended): <input type="checkbox"/>	
<input type="radio"/> Signature:	

Scheduled Maintenance

<input type="radio"/> Repair Order #:	<p>Dealer stamp</p>
<input type="radio"/> Distance:	
<input type="radio"/> Engine hours (optional):	
<input type="radio"/> Multi-point inspection (recommended): <input type="checkbox"/>	
<input type="radio"/> Signature:	

<input type="radio"/> Repair Order #:	<p>Dealer stamp</p>
<input type="radio"/> Distance:	
<input type="radio"/> Engine hours (optional):	
<input type="radio"/> Multi-point inspection (recommended): <input type="checkbox"/>	
<input type="radio"/> Signature:	

Scheduled Maintenance

<input type="radio"/> Repair Order #:	<p>Dealer stamp</p>
<input type="radio"/> Distance:	
<input type="radio"/> Engine hours (optional):	
<input type="radio"/> Multi-point inspection (recommended): <input type="checkbox"/>	
<input type="radio"/> Signature:	

<input type="radio"/> Repair Order #:	<p>Dealer stamp</p>
<input type="radio"/> Distance:	
<input type="radio"/> Engine hours (optional):	
<input type="radio"/> Multi-point inspection (recommended): <input type="checkbox"/>	
<input type="radio"/> Signature:	

Scheduled Maintenance

<input type="radio"/> Repair Order #:	Dealer stamp
<input type="radio"/> Distance:	
<input type="radio"/> Engine hours (optional):	
<input type="radio"/> Multi-point inspection (recommended): <input type="checkbox"/>	
<input type="radio"/> Signature:	

<input type="radio"/> Repair Order #:	Dealer stamp
<input type="radio"/> Distance:	
<input type="radio"/> Engine hours (optional):	
<input type="radio"/> Multi-point inspection (recommended): <input type="checkbox"/>	
<input type="radio"/> Signature:	

Scheduled Maintenance

<input type="radio"/> Repair Order #:	<p>Dealer stamp</p>
<input type="radio"/> Distance:	
<input type="radio"/> Engine hours (optional):	
<input type="radio"/> Multi-point inspection (recommended): <input type="checkbox"/>	
<input type="radio"/> Signature:	

<input type="radio"/> Repair Order #:	<p>Dealer stamp</p>
<input type="radio"/> Distance:	
<input type="radio"/> Engine hours (optional):	
<input type="radio"/> Multi-point inspection (recommended): <input type="checkbox"/>	
<input type="radio"/> Signature:	

Scheduled Maintenance

<input type="radio"/> Repair Order #:	Dealer stamp
<input type="radio"/> Distance:	
<input type="radio"/> Engine hours (optional):	
<input type="radio"/> Multi-point inspection (recommended): <input type="checkbox"/>	
<input type="radio"/> Signature:	

<input type="radio"/> Repair Order #:	Dealer stamp
<input type="radio"/> Distance:	
<input type="radio"/> Engine hours (optional):	
<input type="radio"/> Multi-point inspection (recommended): <input type="checkbox"/>	
<input type="radio"/> Signature:	

Scheduled Maintenance

<input type="radio"/> Repair Order #:	<p>Dealer stamp</p>
<input type="radio"/> Distance:	
<input type="radio"/> Engine hours (optional):	
<input type="radio"/> Multi-point inspection (recommended): <input type="checkbox"/>	
<input type="radio"/> Signature:	

<input type="radio"/> Repair Order #:	<p>Dealer stamp</p>
<input type="radio"/> Distance:	
<input type="radio"/> Engine hours (optional):	
<input type="radio"/> Multi-point inspection (recommended): <input type="checkbox"/>	
<input type="radio"/> Signature:	

Appendices

END USER LICENSE AGREEMENT

SYNC End User License Agreement (EULA)

- You have acquired a device ("DEVICE") that includes software licensed by Ford Motor Company and its affiliates ("FORD MOTOR COMPANY") from an affiliate of Microsoft Corporation ("MS"). Those installed software products of MS origin, as well as associated media, printed materials, and "online" or electronic documentation ("MS SOFTWARE") are protected by international intellectual property laws and treaties. The MS SOFTWARE is licensed, not sold. All rights reserved.
- The MS SOFTWARE may interface with and/or communicate with, or may be later upgraded to interface with and/or communicate with additional software and/or systems provided by FORD MOTOR COMPANY. The additional software and systems of FORD MOTOR COMPANY origin, as well as associated media, printed materials, and "online" or electronic documentation ("FORD SOFTWARE") are protected by international intellectual property laws and treaties. The FORD SOFTWARE is licensed, not sold. All rights reserved.

- The MS SOFTWARE and/or FORD SOFTWARE may interface with and/or communicate with, or may be later upgraded to interface with and/or communicate with additional software and/or systems provided by third party software and service suppliers. The additional software and services of third party origin, as well as associated media, printed materials, and "online" or electronic documentation ("THIRD PARTY SOFTWARE") are protected by international intellectual property laws and treaties. The THIRD PARTY SOFTWARE is licensed, not sold. All rights reserved.
- The MS SOFTWARE, FORD SOFTWARE and THIRD PARTY SOFTWARE hereinafter collectively and individually will be referred to as "SOFTWARE".

IF YOU DO NOT AGREE TO THIS END USER LICENSE AGREEMENT ("EULA") DO NOT USE THE DEVICE OR COPY THE SOFTWARE. ANY USE OF THE SOFTWARE, INCLUDING BUT NOT LIMITED TO USE ON THE DEVICE, WILL CONSTITUTE YOUR AGREEMENT TO THIS EULA (OR RATIFICATION OF ANY PREVIOUS CONSENT).

GRANT OF SOFTWARE LICENSE: This EULA grants you the following license:

- You may use the SOFTWARE as installed on the DEVICE and as otherwise interfacing with systems and/or services provide by or through FORD MOTOR COMPANY or its third party software and service providers.

Appendices

Description of Other Rights and Limitations

- **Speech Recognition:** If the SOFTWARE includes speech recognition component(s), you should understand that speech recognition is an inherently statistical process and that recognition errors are inherent in the process. Neither FORD MOTOR COMPANY nor its suppliers shall be liable for any damages arising out of errors in the speech recognition process.
- **Limitations on Reverse Engineering, Decompilation and Disassembly:** You may not reverse engineer, decompile, or disassemble nor permit others to reverse engineer, decompile or disassemble the SOFTWARE, except and only to the extent that such activity is expressly permitted by applicable law notwithstanding this limitation.
- **Limitations on Distributing, Copying, Modifying and Creating Derivative Works:** You may not distribute, copy, make modifications to or create derivative works based on the SOFTWARE, except and only to the extent that such activity is expressly permitted by applicable law notwithstanding this limitation.
- **Single EULA:** The end user documentation for the DEVICE and related systems and services may contain multiple EULAs, such as multiple translations and/or multiple media versions (e.g., in the user documentation and in the software). Even if you receive multiple EULAs, you are licensed to use only one (1) copy of the SOFTWARE.
- **SOFTWARE Transfer:** You may permanently transfer your rights under this EULA only as part of a sale or transfer of the DEVICE, provided you retain no copies, you transfer all of the SOFTWARE (including all component parts, the media and printed materials, any upgrades, and, if applicable, the Certificate(s) of Authenticity), and the recipient agrees to the terms of this EULA. If the SOFTWARE is an upgrade, any transfer must include all prior versions of the SOFTWARE.
- **Termination:** Without prejudice to any other rights, FORD MOTOR COMPANY or MS may terminate this EULA if you fail to comply with the terms and conditions of this EULA.
- **Security Updates/Digital Rights Management:** Content owners use the WMDRM technology included in your DEVICE to protect their intellectual property, included copyrighted content. Portions of the SOFTWARE on your DEVICE use WMDRM software to access WMDRM-protected content. If the WMDRM software fails to protect the content, content owners may ask Microsoft to revoke the SOFTWARE's ability to use WMDRM to play or copy protected content. This action does not affect unprotected content. When your DEVICE downloads licenses for protected content, you agree that Microsoft may include a revocation list with the licenses. Content owners may require you to upgrade the SOFTWARE on your DEVICE to access their content. If you decline an upgrade, you will not be able to access content that requires the upgrade.

Appendices

- **Consent to Use of Data:** You agree that MS, Microsoft Corporation, FORD MOTOR COMPANY, third party software and systems suppliers, their affiliates and/or their designated agent may collect and use technical information gathered in any manner as part of product support services related to the SOFTWARE or related services. MS, Microsoft Corporation, FORD MOTOR COMPANY, third party software and services suppliers, their affiliates and/or their designated agent may use this information solely to improve their products or to provide customized services or technologies to you. MS, Microsoft Corporation, FORD MOTOR COMPANY, third party software and systems suppliers, their affiliates and/or their designated agent may disclose this information to others, but not in a form that personally identifies you.
- **Internet-Based Services Components:** The SOFTWARE may contain components that enable and facilitate the use of certain Internet-based services. You acknowledge and agree that MS, Microsoft Corporation, FORD MOTOR COMPANY, third party software and service suppliers, their affiliates and/or their designated agent may automatically check the version of the SOFTWARE and/or its components that you are utilizing and may provide upgrades or supplements to the SOFTWARE that may be automatically downloaded to your DEVICE.
- **Additional Software/Services:** The SOFTWARE may permit FORD MOTOR COMPANY, third party software and service suppliers, MS, Microsoft Corporation, their affiliates and/or their designated agent to provide or make available to you SOFTWARE updates,

supplements, add-on components, or Internet-based services components of the SOFTWARE after the date you obtain your initial copy of the SOFTWARE ("Supplemental Components").

If FORD MOTOR COMPANY or third party software and services suppliers provide or make available to you Supplemental Components and no other EULA terms are provided along with the Supplemental Components, then the terms of this EULA shall apply.

If MS, Microsoft Corporation, their affiliates and/or their designated agent make available Supplemental Components, and no other EULA terms are provided, then the terms of this EULA shall apply, except that the MS, Microsoft Corporation or affiliate entity providing the Supplemental Component(s) shall be the licensor of the Supplemental Component(s).

FORD MOTOR COMPANY, MS, Microsoft Corporation, their affiliates and/or their designated agent reserve the right to discontinue without liability any Internet-based services provided to you or made available to you through the use of the SOFTWARE.

Appendices

- **Links to Third Party Sites:** The MS SOFTWARE may provide you with the ability to link to third party sites through the use of the SOFTWARE. The third party sites are not under the control of MS, Microsoft Corporation, their affiliates and/or their designated agent. Neither MS nor Microsoft Corporation nor their affiliates nor their designated agent are responsible for (i) the contents of any third party sites, any links contained in third party sites, or any changes or updates to third party sites, or (ii) webcasting or any other form of transmission received from any third party sites. If the SOFTWARE provides links to third party sites, those links are provided to you only as a convenience, and the inclusion of any link does not imply an endorsement of the third party site by MS, Microsoft Corporation, their affiliates and/or their designated agent.
- **Obligation to Drive Responsibly:** You recognize your obligation to drive responsibly and keep attention on the road. You will read and abide with the DEVICE operating instructions particularly as they pertain to safety and assumes any risk associated with the use of the DEVICE.

UPGRADES AND RECOVERY MEDIA:

If the SOFTWARE is provided by FORD MOTOR COMPANY separate from the DEVICE on media such as a ROM chip, CD ROM disk(s) or via web download or other means, and is labeled "For Upgrade Purposes Only" or "For Recovery Purposes Only" you may install one (1) copy of such SOFTWARE onto the DEVICE as a replacement copy for the existing SOFTWARE, and use it in accordance with this EULA, including any additional EULA terms accompanying the upgrade SOFTWARE.

INTELLECTUAL PROPERTY RIGHTS:

All title and intellectual property rights in and to the SOFTWARE (including but not limited to any images, photographs, animations, video, audio, music, text and "applets" incorporated into the SOFTWARE), the accompanying printed materials, and any copies of the SOFTWARE, are owned by MS, Microsoft Corporation, FORD MOTOR COMPANY, or their affiliates or suppliers. The SOFTWARE is licensed, not sold. You may not copy the printed materials accompanying the SOFTWARE. All title and intellectual property rights in and to the content which may be accessed through use of the SOFTWARE is the property of the respective content owner and may be protected by applicable copyright or other intellectual property laws and treaties. This EULA grants you no rights to use such content. All rights not specifically granted under this EULA are reserved by MS, Microsoft Corporation, FORD MOTOR COMPANY, third party software and service providers, their affiliates and suppliers. Use of any on-line services which may be accessed through the SOFTWARE may be governed by the respective terms of use relating to such services. If this SOFTWARE contains documentation that is provided only in electronic form, you may print one copy of such electronic documentation.

EXPORT RESTRICTIONS: You acknowledge that the SOFTWARE is subject to U.S. and European Union export jurisdiction. You agree to comply with all applicable international and national laws that apply to the SOFTWARE, including the U.S. Export Administration Regulations, as well as end-user, end-use and destination restrictions issued by U.S. and other governments. For additional information, see:

Appendices

Website
http://www.microsoft.com/exporting/

TRADEMARKS: This EULA does not grant you any rights in connection with any trademarks or service marks of FORD MOTOR COMPANY, MS, Microsoft Corporation, third party software or service providers, their affiliates or suppliers.

PRODUCT SUPPORT: Product support for the SOFTWARE is not provided by MS, its parent corporation Microsoft Corporation, or their affiliates or subsidiaries. For product support, please refer to FORD MOTOR COMPANY instructions provided in the documentation for the DEVICE. Should you have any questions concerning this EULA, or if you desire to contact FORD MOTOR COMPANY for any other reason, please refer to the address provided in the documentation for the DEVICE.

No Liability for Certain Damages: EXCEPT AS PROHIBITED BY LAW, FORD MOTOR COMPANY, ANY THIRD PARTY SOFTWARE OR SERVICES SUPPLIERS, MS, MICROSOFT CORPORATION AND THEIR AFFILIATES SHALL HAVE NO LIABILITY FOR ANY INDIRECT, SPECIAL, CONSEQUENTIAL OR INCIDENTAL DAMAGES ARISING FROM OR IN CONNECTION WITH THE USE OR PERFORMANCE OF THE SOFTWARE. THIS LIMITATION SHALL APPLY EVEN IF ANY REMEDY FAILS OF ITS ESSENTIAL PURPOSE. IN NO EVENT SHALL MS, MICROSOFT CORPORATION AND/OR THEIR AFFILIATES BE LIABLE FOR ANY AMOUNT IN EXCESS OF U.S. TWO HUNDRED FIFTY DOLLARS (U.S. \$250.00).

- THERE ARE NO WARRANTIES OTHER THAN THOSE THAT MAY EXPRESSLY BE PROVIDED FOR YOUR NEW VEHICLE.

Adobe

Contains Adobe® [Flash® Player] or [AIR®] technology by Adobe Systems Incorporated. This [Licensee Product] contains [Adobe® Flash® Player] [Adobe® AIR®] software under license from Adobe Systems Incorporated, Copyright ©1995-2009 Adobe Macromedia Software LLC. All rights reserved. Adobe, Flash and AIR are trademarks of Adobe Systems Incorporated.

End User Notice

Microsoft® Windows® Mobile for Automotive Important Safety Information

This system Ford SYNC contains software that is licensed to Manufacturer FORD MOTOR COMPANY by an affiliate of Microsoft Corporation pursuant to a license agreement. Any removal, reproduction, reverse engineering or other unauthorized use of the software from this system in violation of the license agreement is strictly prohibited and may subject you to legal action.

Read and follow instructions: Before using your Windows Automotive- based system, read and follow all instructions and safety information provided in this end user manual ("User's Guide"). Not following precautions found in this User's Guide can lead to an accident or other serious consequences.

Appendices

Keep User's Guide in vehicle: When kept in the vehicle, the User's Guide will be a ready reference for you and other users unfamiliar with the Windows Automotive-based system. Please make certain that before using the system for the first time, all persons have access to the User's Guide and read its instructions and safety information carefully.

WARNING



Operating certain parts of this system while driving can distract your attention away from the road, and possibly cause an accident or other serious consequences. Do not change system settings or enter data non-verbally (using your hands) while driving. Stop the vehicle in a safe and legal manner before attempting these operations. This is important since while setting up or changing some functions you might be required to distract your attention away from the road and remove your hands from the wheel.

General Operation

Voice Command Control: Functions within the Windows Automotive-based system may be accomplished using only voice commands. Using voice commands while driving allows you to operate the system without removing your hands from the wheel.

Prolonged Views of Screen: Do not access any function requiring a prolonged view of the screen while you are driving. Pull over in a safe and legal manner before attempting to access a function of the system requiring prolonged attention. Even occasional short scans to the screen may be hazardous if your attention has been diverted away from your driving task at a critical time.

Volume Setting: Do not raise the volume excessively. Keep the volume at a level where you can still hear outside traffic and emergency signals while driving. Driving while unable to hear these sounds could cause an accident.

Use of Speech Recognition Functions: Speech recognition software is inherently a statistical process which is subject to errors. It is your responsibility to monitor any speech recognition functions included in the system and address any errors.

Navigation Features: Any navigation features included in the system are intended to provide turn by turn instructions to get you to a desired destination. Please make certain all persons using this system carefully read and follow instructions and safety information fully.

Distraction Hazard: Any navigation features may require manual (non-verbal) setup. Attempting to perform such set-up or insert data while driving can seriously distract your attention and could cause an accident or other serious consequences. Stop the vehicle in a safe and legal manner before attempting these operations.

Let Your Judgment Prevail: Any navigation features are provided only as an aid. Make your driving decisions based on your observations of local conditions and existing traffic regulations. Any such feature is not a substitute for your personal judgment. Any route suggestions made by this system should never replace any local traffic regulations or your personal judgment or knowledge of safe driving practices.

Appendices

Route Safety: Do not follow the route suggestions if doing so would result in an unsafe or illegal maneuver, if you would be placed in an unsafe situation, or if you would be directed into an area that you consider unsafe. The driver is ultimately responsible for the safe operation of the vehicle and therefore, must evaluate whether it is safe to follow the suggested directions.

Potential Map Inaccuracy: Maps used by this system may be inaccurate because of changes in roads, traffic controls or driving conditions. Always use good judgment and common sense when following the suggested routes.

Emergency Services: Do not rely on any navigation features included in the system to route you to emergency services. Ask local authorities or an emergency services operator for these locations. Not all emergency services such as police, fire stations, hospitals and clinics are likely to be contained in the map database for such navigation features.

Telenav Software End User License Agreement

Please read these terms and conditions carefully before you use the Telenav Software. Your use of the Telenav Software indicates that you accept these terms and conditions. If you do not accept these terms and conditions, do not break the seal of the package, launch, or otherwise use the Telenav Software.

These terms and conditions represent the agreement ("Agreement") between you and Telenav, Inc. ("Telenav") with respect to the Telenav Software (including upgrades, modifications, or additions thereto) (collectively "Telenav Software"). All references herein to "you" and "your" means you, your employees, agents, and contractors, and any other entity on whose behalf you accept these terms and

conditions, all of whom shall also be bound by this Agreement. Additionally, all of your account information, as well as other payment and personal information provided by you to Telenav (directly or through the use of the Telenav Software, is subject to Telenav's privacy policy located at <http://www.telenav.com>.

Telenav may revise this Agreement and the privacy policy at any time, with or without notice to you. You agree to visit <http://www.telenav.com> from time to time to review the then current version of this Agreement and of the privacy policy.

1. Safe and Lawful Use

You acknowledge that devoting attention to the Telenav Software may pose a risk of injury or death to you and others in situations that otherwise require your undivided attention, and you therefore agree to comply with the following when using the Telenav Software: (a) observe all traffic laws and otherwise drive safely; (b) use your own personal judgment while driving. If you feel that a route suggested by the Telenav Software instructs you to perform an unsafe or illegal maneuver, places you in an unsafe situation, or directs you into an area that you consider to be unsafe, do not follow such instructions; (c) do not input destinations, or otherwise manipulate the Telenav Software, unless your vehicle is stationary and parked; (d) do not use the Telenav Software for any illegal, unauthorized, unintended, unsafe, hazardous, or unlawful purposes, or in any manner inconsistent with this Agreement; (e) arrange all GPS and wireless devices and cables necessary for use of the Telenav Software in a secure manner in your vehicle so that they will not interfere with your driving and will not prevent the operation of any safety device (such as an airbag).

Appendices

You agree to indemnify and hold Telenav harmless against all claims resulting from any dangerous or otherwise inappropriate use of the Telenav Software in any moving vehicle, including as a result of your failure to comply with the directions above.

2. Account Information

You agree: (a) when registering the Telenav Software, to provide Telenav with true, accurate, current, and complete information about yourself, and (b) to inform Telenav promptly of any changes to such information, and to keep it true, accurate, current and complete.

3. Software License

Subject to your compliance with the terms of this Agreement, Telenav hereby grants to you a personal, non-exclusive, non-transferable license (except as expressly permitted below in connection with your permanent transfer of the Telenav Software license), without the right to sublicense, to use the Telenav Software (in object code form only) in order to access and use the Telenav Software. This license shall terminate upon any termination or expiration of this Agreement. You agree that you will use the Telenav Software only for your personal business or leisure purposes, and not to provide commercial navigation services to other parties.

3.1 License Limitations

You agree not to do any of the following: (a) reverse engineer, decompile, disassemble, translate, modify, alter or otherwise change the Telenav Software or any part thereof; (b) attempt to derive the source code, audio library or structure of the Telenav Software without the prior express written consent of Telenav; (c) remove from the Telenav Software, or alter, any of Telenav's or its suppliers' trademarks, trade names, logos, patent or

copyright notices, or other notices or markings; (d) distribute, sublicense or otherwise transfer the Telenav Software to others, except as part of your permanent transfer of the Telenav Software; or (e) use the Telenav Software in any manner that (i) infringes the intellectual property or proprietary rights, rights of publicity or privacy or other rights of any party, (ii) violates any law, statute, ordinance or regulation, including but not limited to laws and regulations related to spamming, privacy, consumer and child protection, obscenity or defamation, or (iii) is harmful, threatening, abusive, harassing, tortuous, defamatory, vulgar, obscene, libelous, or otherwise objectionable; and (f) lease, rent out, or otherwise permit unauthorized access by third parties to the Telenav Software without advanced written permission of Telenav.

4. Disclaimers

To the fullest extent permissible pursuant to applicable law, in no event will Telenav, its licensors and suppliers, or agents or employees of any of the foregoing, be liable for any decision made or action taken by you or anyone else in reliance on the information provided by the Telenav Software. Telenav also does not warrant the accuracy of the map or other data used for the Telenav Software. Such data may not always reflect reality due to, among other things, road closures, construction, weather, new roads and other changing conditions. You are responsible for the entire risk arising out of your use of the Telenav Software. For example but without limitation, you agree not to rely on the Telenav Software for critical navigation in areas where the well-being or survival of you or others is dependent on the accuracy of navigation, as the maps or functionality of the Telenav Software are not intended to support such high risk applications, especially in more remote geographical areas.

Appendices

TELENAV EXPRESSLY DISCLAIMS AND EXCLUDES ALL WARRANTIES IN CONNECTION WITH THE TELENAV SOFTWARE, WHETHER STATUTORY, EXPRESS OR IMPLIED, INCLUDING ALL WARRANTIES WHICH MAY ARISE FROM COURSE OF DEALING, CUSTOM OR TRADE AND INCLUDING, BUT NOT LIMITED TO, THE IMPLIED WARRANTIES OF MERCHANTABILITY, FITNESS FOR A PARTICULAR PURPOSE AND NON-INFRINGEMENT OF THIRD PARTY RIGHTS WITH RESPECT TO THE TELENAV SOFTWARE. Certain jurisdictions do not permit the disclaimer of certain warranties, so this limitation may not apply to you.

5. Limitation of Liability

TO THE EXTENT PERMITTED UNDER APPLICABLE LAW, UNDER NO CIRCUMSTANCES SHALL TELENAV OR ITS LICENSORS AND SUPPLIERS BE LIABLE TO YOU OR TO ANY THIRD PARTY FOR ANY INDIRECT, INCIDENTAL, CONSEQUENTIAL, SPECIAL OR EXEMPLARY DAMAGES (INCLUDING IN EACH CASE, BUT NOT LIMITED TO, DAMAGES FOR THE INABILITY TO USE THE EQUIPMENT OR ACCESS DATA, LOSS OF DATA, LOSS OF BUSINESS, LOSS OF PROFITS, BUSINESS INTERRUPTION OR THE LIKE) ARISING OUT OF THE USE OF OR INABILITY TO USE THE TELENAV SOFTWARE, EVEN IF TELENAV HAS BEEN ADVISED OF THE POSSIBILITY OF SUCH DAMAGES.

NOTWITHSTANDING ANY DAMAGES THAT YOU MIGHT INCUR FOR ANY REASON WHATSOEVER (INCLUDING, WITHOUT LIMITATION, ALL DAMAGES REFERENCED HEREIN AND ALL DIRECT OR GENERAL DAMAGES IN CONTRACT, TORT (INCLUDING NEGLIGENCE) OR OTHERWISE), THE ENTIRE LIABILITY OF TELENAV AND OF ALL OF TELENAV'S SUPPLIERS SHALL BE LIMITED TO THE AMOUNT ACTUALLY PAID BY YOU FOR

THE TELENAV SOFTWARE. SOME STATES AND/OR JURISDICTIONS DO NOT ALLOW THE EXCLUSION OR LIMITATION OF INCIDENTAL OR CONSEQUENTIAL DAMAGES, SO THE ABOVE LIMITATIONS OR EXCLUSIONS MAY NOT APPLY TO YOU.

6. Arbitration and Governing Law

You agree that any dispute, claim or controversy arising out of or relating to this Agreement or the Telenav Software shall be settled by independent arbitration involving a neutral arbitrator and administered by the American Arbitration Association in the County of Santa Clara, California. The arbitrator shall apply the Commercial Arbitration Rules of the American Arbitration Association, and the judgment upon the award rendered by the arbitrator may be entered by any court having jurisdiction. Note that there is no judge or jury in an arbitration proceeding and the decision of the arbitrator shall be binding upon both parties. You expressly agree to waive your right to a jury trial.

This Agreement and performance hereunder will be governed by and construed in accordance with the laws of the State of California, without giving effect to its conflict of laws provisions. To the extent judicial action is necessary in connection with the binding arbitration, both Telenav and you agree to submit to the exclusive jurisdiction of the courts of the County of Santa Clara, California. The United Nations Convention on Contracts for the International Sale of Goods shall not apply.

7. Assignment

You may not resell, assign, or transfer this Agreement or any of your rights or obligations, except in totality, in connection with your permanent transfer of the Telenav Software, and expressly conditioned upon the new user of the

Appendices

Telenav Software agreeing to be bound by the terms and conditions of this Agreement. Any such sale, assignment or transfer that is not expressly permitted under this paragraph will result in immediate termination of this Agreement, without liability to Telenav, in which case you and all other parties shall immediately cease all use of the Telenav Software. Notwithstanding the foregoing, Telenav may assign this Agreement to any other party at any time without notice, provided the assignee remains bound by this Agreement.

8. Miscellaneous

8.1

This Agreement constitutes the entire agreement between Telenav and you with respect to the subject matter hereof.

8.2

Except for the limited licenses expressly granted in this Agreement, Telenav retains all right, title and interest in and to the Telenav Software, including without limitation all related intellectual property rights. No licenses or other rights which are not expressly granted in this Agreement are intended to, or shall be, granted or conferred by implication, statute, inducement, estoppel or otherwise, and Telenav and its suppliers and licensors hereby reserve all of their respective rights other than the licenses explicitly granted in this Agreement.

8.3

By using the Telenav Software, you consent to receive from Telenav all communications, including notices, agreements, legally required disclosures or other information in connection with the Telenav Software (collectively, "Notices") electronically. Telenav may provide such

Notices by posting them on Telenav's Website or by downloading such Notices to your wireless device. If you desire to withdraw your consent to receive Notices electronically, you must discontinue your use of the Telenav Software.

8.4

Telenav's or your failure to require performance of any provision shall not affect that party's right to require performance at any time thereafter, nor shall a waiver of any breach or default of this Agreement constitute a waiver of any subsequent breach or default or a waiver of the provision itself.

8.5

If any provision herein is held unenforceable, then such provision will be modified to reflect the intention of the parties, and the remaining provisions of this Agreement will remain in full force and effect.

8.6

The headings in this Agreement are for convenience of reference only, will not be deemed to be a part of this Agreement, and will not be referred to in connection with the construction or interpretation of this Agreement. As used in this Agreement, the words "include" and "including," and variations thereof, will not be deemed to be terms of limitation, but rather will be deemed to be followed by the words "without limitation."

9. Other Vendors Terms and Conditions

The Telenav Software utilizes map and other data licensed to Telenav by third party vendors for the benefit of you and other end users. This Agreement includes end-user terms applicable to these companies (included at the end of this

Appendices

Agreement), and thus your use of the Telenav Software is also subject to such terms. You agree to comply with the following additional terms and conditions, which are applicable to Telenav's third party vendor licensors:

9.1 End User Terms Required by HERE North America, LLC

The data ("Data") is provided for your personal, internal use only and not for resale. It is protected by copyright, and is subject to the following terms and conditions which are agreed to by you, on the one hand, and Telenav ("Telenav") and its licensors (including their licensors and suppliers) on the other hand.

© 2013 HERE. All rights reserved.

The Data for areas of Canada includes information taken with permission from Canadian authorities, including: © Her Majesty the Queen in Right of Canada, © Queen's Printer for Ontario, © Canada Post Corporation, GeoBase®, © Department of Natural Resources Canada.

HERE holds a non-exclusive license from the United States Postal Service® to publish and sell ZIP+4® information.

©United States Postal Service® 2014. Prices are not established, controlled or approved by the United States Postal Service®. The following trademarks and registrations are owned by the USPS: United States Postal Service, USPS, and ZIP+4.

The Data for Mexico includes certain data from Instituto Nacional de Estadística y Geografía.

TERMS AND CONDITIONS

9.2 End User Terms Required by NAV2 (Shanghai) Co., Ltd

The data ("Data") is provided for your personal, internal use only and not for resale. It is protected by copyright, and is subject to the following terms and conditions which are agreed to by you, on the one hand, and NAV2 (Shanghai) Co., Ltd ("NAV2") and its licensors (including their licensors and suppliers) on the other hand.

© 20xx. All rights reserved.

Permitted Use.

You agree to use this Data together with the Telenav Software solely for the internal business and personal purposes for which you were licensed, and not for service bureau, time-sharing or other similar purposes. Accordingly, but subject to the restrictions set forth in the following paragraphs, you agree not to otherwise reproduce, copy, modify, decompile, disassemble, create any derivative works of, or reverse engineer any portion of this Data, and may not transfer or distribute it in any form, for any purpose, except to the extent permitted by mandatory laws.

Restrictions.

Except where you have been specifically licensed to do so by Telenav, and without limiting the preceding paragraph, you may not use this Data (a) with any products, systems, or applications installed or otherwise connected to or in communication with vehicles, capable of vehicle navigation, positioning, dispatch, real time route guidance, fleet management or similar applications; or (b) with or in communication with any

Appendices

positioning devices or any mobile or wireless-connected electronic or computer devices, including without limitation cellular phones, palmtop and handheld computers, pagers, and personal digital assistants or PDAs.

Warning.

The Data may contain inaccurate or incomplete information due to the passage of time, changing circumstances, sources used and the nature of collecting comprehensive geographic data, any of which may lead to incorrect results.

No Warranty.

This Data is provided to you "as is," and you agree to use it at your own risk. Telenav and its licensors (and their licensors and suppliers) make no guarantees, representations or warranties of any kind, express or implied, arising by law or otherwise, including but not limited to, content, quality, accuracy, completeness, effectiveness, reliability, fitness for a particular purpose, usefulness, use or results to be obtained from this Data, or that the Data or server will be uninterrupted or error-free.

Disclaimer of Warranty:

TELENAV AND ITS LICENSORS (INCLUDING THEIR LICENSORS AND SUPPLIERS) DISCLAIM ANY WARRANTIES, EXPRESS OR IMPLIED, OF QUALITY, PERFORMANCE, MERCHANTABILITY, FITNESS FOR A PARTICULAR PURPOSE OR NON-INFRINGEMENT. Some States, Territories and Countries do not allow certain warranty exclusions, so to that extent the above exclusion may not apply to you.

Disclaimer of Liability:

TELENAV AND ITS LICENSORS (INCLUDING THEIR LICENSORS AND SUPPLIERS) SHALL NOT BE LIABLE TO YOU: IN RESPECT OF ANY CLAIM, DEMAND OR ACTION, IRRESPECTIVE OF THE NATURE OF THE CAUSE OF THE CLAIM, DEMAND OR ACTION ALLEGING ANY LOSS, INJURY OR DAMAGES, DIRECT OR INDIRECT, WHICH MAY RESULT FROM THE USE OR POSSESSION OF THE INFORMATION; OR FOR ANY LOSS OF PROFIT, REVENUE, CONTRACTS OR SAVINGS, OR ANY OTHER DIRECT, INDIRECT, INCIDENTAL, SPECIAL OR CONSEQUENTIAL DAMAGES ARISING OUT OF YOUR USE OF OR INABILITY TO USE THIS INFORMATION, ANY DEFECT IN THE INFORMATION, OR THE BREACH OF THESE TERMS OR CONDITIONS, WHETHER IN AN ACTION IN CONTRACT OR TORT OR BASED ON A WARRANTY, EVEN IF TELENAV OR ITS LICENSORS HAVE BEEN ADVISED OF THE POSSIBILITY OF SUCH DAMAGES. Some States, Territories and Countries do not allow certain liability exclusions or damages limitations, so to that extent the above may not apply to you.

Export Control.

You shall not export from anywhere any part of the Data or any direct product thereof except in compliance with, and with all licenses and approvals required under, applicable export laws, rules and regulations, including but not limited to the laws, rules and regulations administered by the Office of Foreign Assets Control of the U.S. Department of Commerce and the Bureau of Industry and Security of the U.S. Department of Commerce. To the extent

Appendices

that any such export laws, rules or regulations prohibit HERE from complying with any of its obligations hereunder to deliver or distribute Data, such failure shall be excused and shall not constitute a breach of this Agreement.

Entire Agreement.

These terms and conditions constitute the entire agreement between Telenav (and its licensors, including their licensors and suppliers) and you pertaining to the subject matter hereof, and supersedes in their entirety any and all written or oral agreements previously existing between us with respect to such subject matter.

Governing Law.

The above terms and conditions shall be governed by the laws of the State of Illinois [insert "Netherlands" where European HERE Data is used], without giving effect to (i) its conflict of laws provisions, or (ii) the United Nations Convention for Contracts for the International Sale of Goods, which is explicitly excluded. You agree to submit to the jurisdiction of the State of Illinois [insert "The Netherlands" where European HERE Data is used] for any and all disputes, claims and actions arising from or in connection with the Data provided to you hereunder.

Government End Users.

If the Data is being acquired by or on behalf of the United States government or any other entity seeking or applying rights similar to those customarily claimed by the United States government, this Data is a "commercial item" as that term is defined at 48 C.F.R. ("FAR") 2.101, is licensed in accordance with these End-User Terms, and each copy of Data delivered or otherwise furnished shall be marked and embedded as appropriate with the following "Notice of Use," and shall be treated in accordance with such Notice:

NOTICE OF USE

CONTRACTOR (MANUFACTURER/
SUPPLIER) NAME: HERE

CONTRACTOR (MANUFACTURER/
SUPPLIER) ADDRESS: c/o Nokia, 425
West Randolph Street, Chicago, Illinois
60606

This Data is a commercial item as defined in FAR 2.101 and is subject to these End-User Terms under which this Data was provided.

© 1987 – 2014 HERE – All rights reserved.

If the Contracting Officer, federal government agency, or any federal official refuses to use the legend provided herein, the Contracting Officer, federal government agency, or any federal official must notify HERE prior to seeking additional or alternative rights in the Data.

I. US/Canada Territory

A. United States Data. The End-User Terms for any Application containing Data for the United States shall contain the following notices:

"HERE holds a non-exclusive license from the United States Postal Service® to publish and sell ZIP+4® information."

"©United States Postal Service® 20XX. Prices are not established, controlled or approved by the United States Postal Service®. The following trademarks and registrations are owned by the USPS: United States Postal Service, USPS, and ZIP+4."

Appendices

B. Canada Data. The following provisions apply to the Data for Canada, which may include or reflect data from third party licensors (“Third Party Data”), including Her Majesty the Queen in Right of Canada (“Her Majesty”), Canada Post Corporation (“Canada Post”) and the Department of Natural Resources of Canada (“NRCan”):

1. Disclaimer and Limitation: Client agrees that its use of the Third Party Data is subject to the following provisions:

a. Disclaimer: The Third Party Data is licensed on an “as is” basis. The licensors of such data, including Her Majesty, Canada Post and NRCan, make no guarantees, representations or warranties respecting such data, either express or implied, arising by law or otherwise, including but not limited to, effectiveness, completeness, accuracy or fitness for a particular purpose.

b. Limitation on Liability: The Third Party Data licensors, including Her Majesty, Canada Post and NRCan, shall not be liable: (i) in respect of any claim, demand or action, irrespective of the nature of the cause of the claim, demand or action alleging any loss, injury or damages, direct or indirect, which may result from the use or possession of such Data; or (ii) in any way for loss of revenues or contracts, or any other consequential loss of any kind resulting from any defect in the Data.

2. Copyright Notice: In connection with each copy of all or any portion of the Data for the Territory of Canada, Client shall affix in a conspicuous manner the following copyright notice on at least one of: (i) the label for the storage media of the copy; (ii) the packaging for the copy; or (iii) other materials packaged with the copy, such as user manuals or end user license agreements: “This data includes information taken with permission from Canadian authorities, including © Her Majesty the Queen in Right of Canada, © Queen’s Printer for Ontario, © Canada Post Corporation, GeoBase®, © The Department of Natural Resources Canada. All rights reserved.”

3. End-User Terms: Except as otherwise agreed by the parties, in connection with the provision of any portion of the Data for the Territory of Canada to End-Users as may be authorized under the Agreement, Client shall provide such End-Users, in a reasonably conspicuous manner, with terms (set forth with other end user terms required to be provided under the Agreement, or as otherwise may be provided, by Client) which shall include the following provisions on behalf of the Third Party Data licensors, including Her Majesty, Canada Post and NRCan:

The Data may include or reflect data of licensors, including Her Majesty the Queen in the Right of Canada (“Her Majesty”), Canada Post Corporation (“Canada Post”) and the Department of Natural Resources Canada (“NRCan”). Such data is licensed on an “as is” basis. The licensors, including Her Majesty, Canada Post and NRCan, make no guarantees, representations or warranties respecting such data,

Appendices

either express or implied, arising by law or otherwise, including but not limited to, effectiveness, completeness, accuracy or fitness for a particular purpose. The licensors, including Her Majesty, Canada Post and NRCan, shall not be liable in respect of any claim, demand or action, irrespective of the nature of the cause of the claim, demand or action alleging any loss, injury or damages, direct or indirect, which may result from the use or possession of the data or the Data. The licensors, including Her Majesty, Canada Post and NRCan, shall not be liable in any way for loss of revenues or contracts, or any other consequential loss of any kind resulting from any defect in the data or the Data.

End User shall indemnify and save harmless the licensors, including Her Majesty, Canada Post and NRCan, and their officers, employees and agents from and against any claim, demand or action, irrespective of the nature of the cause of the claim, demand or action, alleging loss, costs, expenses, damages or injuries (including injuries resulting in death) arising out of the use or possession of the data or the Data.

4. Additional Provisions: The terms contained in this Section are in addition to all of the rights and obligations of the parties under the Agreement. To the extent that any of the provisions of this Section are inconsistent with, or conflict with, any other provisions of the Agreement, the provisions of this Section shall prevail.

II. Mexico. The following provision applies to the Data for Mexico, which includes certain data from the Instituto Nacional de Estadística y Geografía (“INEGI”):

A. Any and all copies of the Data and/or packaging containing Data for Mexico shall contain the following notice: “Fuente: INEGI (Instituto Nacional de Estadística y Geografía)”

III. Latin America Territory

A. Third Party Notices. Any and all copies of the Data and/or packaging relating thereto shall include the respective Third Party Notices set forth below and used as described below corresponding to the Territory (or portion thereof) included in such copy:

Territory	Notice
Ecuador	“INSTITUTO GEOGRAFICO MILITAR DEL ECUADOR AUTORIZACION N° IGM-2011-01- PCO-01 DEL 25 DE ENERO DE 2011” “source: © IGN 2009 - BD TOPO ®”
Guadeloupe, French Guiana and Martinique Mexico	“Fuente: INEGI (Instituto Nacional de Estadística y Geografía)”

IV. Middle East Territory

Appendices

A. Third Party Notices. Any and all copies of the Data and/or packaging relating thereto shall include the respective Third Party Notices set forth below and used as described below corresponding to the Territory (or portion thereof) included in such copy:

Country	Notice
Jordan	“© Royal Jordanian Geographic Centre”. The foregoing notice requirement for Jordan Data is a material term of the Agreement. If Client or any of its permitted sublicensees (if any) fail to meet such requirement, HERE shall have the right to terminate Client’s license with respect to the Jordan Data.

B. Jordan Data. Client and its permitted sublicensees (if any) are restricted from licensing and/or otherwise distributing HERE’s database for the country of Jordan (“Jordan Data”) for use in Enterprise Applications to (i) non-Jordanian entities for use of the Jordan Data solely in Jordan or (ii) Jordan-based customers. In addition, Client, its permitted sublicensees (if any) and End-Users are restricted from using the Jordan Data in Enterprise Applications if such party is (i) a non-Jordanian entity using the Jordan Data solely in Jordan or (ii) a Jordan-based customer. For purposes of the foregoing, “Enterprise Applications” shall mean Geomarketing applications, GIS applications, mobile business asset management applications, call center applications, telematics applications, public organization Internet applications or for providing geocoding services.

V. Europe Territory

A. Use of Certain Traffic Codes in Europe

1. General Restrictions Applicable to Traffic Codes. Client acknowledges and agrees that in certain countries of the Europe Territory, Client will need to obtain rights directly from third party RDS-TMC code providers to receive and use the Traffic Codes in the Data and to deliver to End-Users Transactions in any way derived from or based on such Traffic Codes. For such countries, HERE shall deliver the Data incorporating Traffic Codes to Client only after receiving certification from Client of its having obtained such rights.

2. Display of Third Party Rights Legends for Belgium. Client shall, for each Transaction that uses Traffic Codes for Belgium, provide the following notice to the End-User: “Traffic Codes for Belgium are provided by the Ministerie van de Vlaamse Gemeenschap and the Ministère de l’Équipement et des Transports.”

B. Paper Maps. With respect to any license granted to Client relating to making, selling or distributing paper maps (i.e., a map fixed on a paper or paper-like medium): (a) such license with respect to Data for the Territory of Great Britain is conditioned on Client’s entering into and complying with a separate written agreement with the Ordnance Survey (“OS”) to create and sell paper maps, Client’s paying to the OS any and all applicable paper map royalties, and Client’s complying with the OS copyright notice requirements; (b) such license for selling or otherwise distributing for charge with respect to Data for the Territory of Czech Republic

Appendices

is conditioned on Client's obtaining prior written consent from Kartografie a.s.; (c) such license for selling or distributing with respect to Data for the Territory of Switzerland is conditioned on Client's obtaining a permit from Bundesamt für Landestopografie of Switzerland; (d) Client is restricted from using Data for the Territory of France to create paper maps with a scale between 1:5,000 and 1:250,000; and (e) Client is restricted from using any Data to create, sell or distribute paper maps that are the same or substantially similar, in terms of data content and specific use of color, symbols and scale, to paper maps published by the European national mapping agencies, including without limitation, Landervermessungämter of Germany, Topografische Dienst of the Netherlands, Nationaal Geografisch Instituut of Belgium, Bundesamt für Landestopografie of Switzerland, Bundesamt für Eich- und Vermessungswesen of Austria, and the National Land Survey of Sweden.

C. OS Enforcement. Without limiting Section IV(B) above, with respect to Data for the Territory of Great Britain, Client acknowledges and agrees that the Ordnance Survey ("OS") may bring a direct action against Client to enforce compliance with the OS copyright notice (see Section IV(D) below) and paper map requirements (see Section IV(B) above) contained in this Agreement.

D. Third Party Notices. Any and all copies of the Data and/or packaging relating thereto shall include the respective Third Party Notices set forth below and used as described below corresponding to the Territory (or portion thereof) included in such copy:

Country(ies) Notice

Austria	"© Bundesamt für Eich- und Vermessungswesen"
Croatia Cyprus, Estonia, Latvia, Lithuania, Moldova, Poland, Slovenia and/or Ukraine	"© EuroGeographics"
France	"source: © IGN 2009 – BD TOPO ®"
Germany	"Die Grundlagendaten wurden mit Genehmigung der zuständigen Behörden entnommen"
Great Britain	"Contains Ordnance Survey data © Crown copyright and database right 2010 Contains Royal Mail data © Royal Mail copyright and database right 2010"
Greece	"Copyright Geomatics Ltd."
Hungary	"Copyright © 2003; Top-Map Ltd."
Italy	"La Banca Dati Italiana è stata prodotta usando quale riferimento anche cartografia numerica ed al tratto prodotta e fornita dalla Regione Toscana."
Norway	"Copyright © 2000; Norwegian Mapping Authority"
Portugal	"Source: IgeoE – Portugal"

Appendices

Spain	“Información geográfica propiedad del CNIG”
Sweden	“Based upon electronic data © National Land Survey Sweden.”
Switzerland	“Topografische Grundlage: © Bundesamt für Landestopographie.

E. Respective Country Distribution. Client acknowledges that HERE has not received approvals to distribute map data for the following countries in such respective countries: Albania, Belarus, Kyrgyzstan, Moldova and Uzbekistan. HERE may update such list from time to time. The license rights granted to Client under this TL with respect to the Data for such countries are contingent upon Client's compliance with all applicable laws and regulations, including, without limitation, any required licenses or approvals to distribute the Application incorporating such Data in such respective countries.

VI. Australia Territory

A. Third Party Notices. Any and all copies of the Data and/or packaging relating thereto shall include the respective Third Party Notices set forth below and used as described below corresponding to the Territory (or portion thereof) included in such copy:

Copyright. Based on data provided under license from PSMA Australia Limited (www.pasma.com.au).

Product incorporates data which is © 20XX Telstra Corporation Limited, GM Holden Limited, Intelomatics Australia Pty Ltd and Continental Pty Ltd.

B. Third Party Notices for Australia. In addition to the foregoing, the End-User Terms for any Application containing RDS-TMC Traffic Codes for Australia shall contain the following notice: “Product incorporates traffic location codes which is © 20XX Telstra Corporation Limited and its licensors.”

VII. China Territory

Personal Use Only

You agree to use this Data together with [insert name of Client Application] for the solely personal, non-commercial purposes for which you were licensed, and not for service bureau, time-sharing or other similar purposes. Accordingly, but subject to the restrictions set forth in the following paragraphs, you may copy this Data only as necessary for your personal use to (i) view it, and (ii) save it, provided that you do not remove any copyright notices that appear and do not modify the Data in any way. You agree not to otherwise reproduce, copy, modify, decompile, disassemble or reverse engineer any portion of this Data, and may not transfer or distribute it in any form, for any purpose, except to the extent permitted by mandatory laws.

Restrictions

Except where you have been specifically licensed to do so by NAV2 , and without limiting the preceding paragraph, you may not (a) use this Data with any products, systems, or applications installed or otherwise connected to or in communication with vehicles, capable of vehicle navigation, positioning, dispatch, real time route guidance, fleet management or similar applications; or (b)

Appendices

with or in communication with any positioning devices or any mobile or wireless-connected electronic or computer devices, including without limitation cellular phones, palmtop and handheld computers, pagers, and personal digital assistants or PDAs. You agree to cease using this Data if you fail to comply with these terms and conditions.

Limited Warranty

NAV2 warrants that (a) the Data will perform substantially in accordance with the accompanying written materials for a period of ninety (90) days from the date of receipt, and (b) any support services provided by NAV2 shall be substantially as described in applicable written materials provided to you by NAV2, and NAV2's support engineers will make commercially reasonable efforts to solve any problem issues.

rigCustomer Remedies

NAV2 and its suppliers' entire liability and your exclusive remedy shall be, at NAV2's sole discretion, either (a) return of the price paid, if any, or (b) repair or replacement of the Data that do not meet NAV2's Limited Warranty and that are returned to NAV2 with a copy of your receipt. This Limited Warranty is void if failure of the Data has resulted from accident, abuse, or misapplication. Any replacement Data will be warranted for the remainder of the original warranty period or thirty (30) days, whichever is longer. Neither these remedies nor any product support services offered by NAV2 are available without proof of purchase from an authorized international source.

No Other Warranty:

EXCEPT FOR THE LIMITED WARRANTY SET FORTH ABOVE AND TO THE EXTENT PERMITTED BY APPLICABLE LAW, NAV2 AND ITS LICENSORS (INCLUDING THEIR LICENSORS AND SUPPLIERS) DISCLAIM ANY WARRANTIES, EXPRESS OR IMPLIED, OF QUALITY, PERFORMANCE, MERCHANTABILITY, FITNESS FOR A PARTICULAR PURPOSE, OWNERSHIP OR NON-INFRINGEMENT. Certain warranty exclusions may not be permitted under applicable law, so to that extent the above exclusion may not apply to you.

Limited Liability:

TO THE EXTENT PERMITTED BY APPLICABLE LAW, NAV2 AND ITS LICENSORS (INCLUDING THEIR LICENSORS AND SUPPLIERS) SHALL NOT BE LIABLE TO YOU: IN RESPECT OF ANY CLAIM, DEMAND OR ACTION, IRRESPECTIVE OF THE NATURE OF THE CAUSE OF THE CLAIM, DEMAND OR ACTION ALLEGING ANY LOSS, INJURY OR DAMAGES, DIRECT OR INDIRECT, WHICH MAY RESULT FROM THE USE OR POSSESSION OF THE INFORMATION; OR FOR ANY LOSS OF PROFIT, REVENUE, CONTRACTS OR SAVINGS, OR ANY OTHER DIRECT, INDIRECT, INCIDENTAL, SPECIAL OR CONSEQUENTIAL DAMAGES ARISING OUT OF YOUR USE OF OR INABILITY TO USE THIS INFORMATION, ANY DEFECT IN THE INFORMATION, OR THE BREACH OF THESE TERMS OR CONDITIONS, WHETHER IN AN ACTION IN CONTRACT OR TORT OR BASED ON A WARRANTY, EVEN IF NAV2 OR ITS LICENSORS HAVE BEEN ADVISED OF THE POSSIBILITY OF SUCH DAMAGES. UNDER NO CIRCUMSTANCES SHALL NAV2'S OR ITS SUPPLIERS' LIABILITY HEREUNDER EXCEED THE PRICE PAID. Certain liability exclusions may not be permitted under applicable law, so to that extent the above exclusion may not apply to you.

Appendices

Export Control

You agree not to export to anywhere any part of the Data provided to you or any direct product thereof except in compliance with, and with all licenses and approvals required under, applicable export laws, rules and regulations.

IP Protection

The Data are owned by NAV2 or its suppliers and are protected by applicable copyright and other intellectual property law and treaties. The Data are provided solely on the basis of a license to use, not sale.

Entire Agreement

These terms and conditions constitute the entire agreement between NAV2 (and its licensors, including their licensors and suppliers) and you pertaining to the subject matter hereof, and supersedes in their entirety any and all written or oral agreements previously existing between us with respect to such subject matter.

Governing Law.

The above terms and conditions shall be governed by the laws of the People's Republic of China, without giving effect to (i) its conflict of laws provisions, or (ii) the United Nations Convention for Contracts for the International Sale of Goods, which is explicitly excluded. Any dispute arising from or in connection with the Data provided to you hereunder shall be submitted to the Shanghai International Economic and Trade Arbitration Commission for arbitration.

Gracenote® Copyright

CD and music-related data from Gracenote, Inc., copyright© 2000-2007 Gracenote. Gracenote Software, copyright © 2000-2007 Gracenote. This product and service may practice one or more of the following U.S. Patents #5,987,525, #6,061,680, #6,154,773, #6,161,132, #6,230,192, #6,230,207, #6,240,459, #6,330,593 and other patents issued or pending. Some services supplied under license from Open Globe, Inc. for U.S. Patent: #6,304,523.

Gracenote and CDDB are registered trademarks of Gracenote. The Gracenote logo and logotype, and the "Powered by Gracenote™" logo are trademarks of Gracenote.

Gracenote® End User License Agreement (EULA)

This device contains software from Gracenote, Inc. of 2000 Powell Street Emeryville, California 94608 ("Gracenote").

The software from Gracenote (the "Gracenote Software") enables this device to do disc and music file identification and obtain music-related information, including name, artist, track, and title information ("Gracenote Data") from online servers ("Gracenote Servers"), and to perform other functions. You may use Gracenote Data only by means of the intended End User functions of this device.

This device may contain content belonging to Gracenote's providers. If so, all of the restrictions set forth herein with respect to Gracenote Data shall also apply to such content and such content providers shall be entitled to all of the benefits and protections set forth herein that are available to Gracenote.

Appendices

You agree that you will use the content from Gracenote ("Gracenote Content"), Gracenote Data, the Gracenote Software, and Gracenote Servers for your own personal, non-commercial use only. You agree not to assign, copy, transfer or transmit the Gracenote Content, Gracenote Software or any Gracenote Data (except in a Tag associated with a music file) to any third party. YOU AGREE NOT TO USE OR EXPLOIT GRACENOTE CONTENT, GRACENOTE DATA, THE GRACENOTE SOFTWARE, OR GRACENOTE SERVERS, EXCEPT AS EXPRESSLY PERMITTED HEREIN.

You agree that your non-exclusive licenses to use the Gracenote Content, Gracenote Data, the Gracenote Software, and Gracenote Servers will terminate if you violate these restrictions. If your licenses terminate, you agree to cease any and all use of the Gracenote Content, Gracenote Data, the Gracenote Software, and Gracenote Servers. Gracenote, respectively, reserve all rights in Gracenote Data, the Gracenote Software, and the Gracenote Servers and Gracenote Content, including all ownership rights. Under no circumstances will either Gracenote become liable for any payment to you for any information that you provide, including any copyrighted material or music file information. You agree that Gracenote may enforce its respective rights, collectively or separately, under this agreement against you, directly in each company's own name.

Gracenote uses a unique identifier to track queries for statistical purposes. The purpose of a randomly assigned numeric identifier is to allow Gracenote to count queries without knowing anything about who you are. For more information, see the web page at www.gracenote.com for the Gracenote Privacy Policy.

THE GRACENOTE SOFTWARE, EACH ITEM OF GRACENOTE DATA AND THE GRACENOTE CONTENT ARE LICENSED TO YOU "AS IS". NEITHER GRACENOTE MAKES ANY REPRESENTATIONS OR WARRANTIES, EXPRESS OR IMPLIED, REGARDING THE ACCURACY OF ANY GRACENOTE DATA FROM THE GRACENOTE SERVERS OR GRACENOTE CONTENT. GRACENOTE COLLECTIVELY AND SEPARATELY RESERVE THE RIGHT TO DELETE DATA AND/OR CONTENT FROM THE COMPANIES' RESPECTIVE SERVERS OR, IN THE CASE OF GRACENOTE, CHANGE DATA CATEGORIES FOR ANY CAUSE THAT GRACENOTE DEEMS SUFFICIENT. NO WARRANTY IS MADE THAT EITHER GRACENOTE CONTENT OR THE GRACENOTE SOFTWARE OR GRACENOTE SERVERS ARE ERROR-FREE OR THAT THE FUNCTIONING OF THE GRACENOTE SOFTWARE OR GRACENOTE SERVERS WILL BE UNINTERRUPTED. GRACENOTE IS NOT OBLIGATED TO PROVIDE YOU WITH ANY ENHANCED OR ADDITIONAL DATA TYPES THAT GRACENOTE MAY CHOOSE TO PROVIDE IN THE FUTURE AND IS FREE TO DISCONTINUE ITS ONLINE SERVICES AT ANY TIME. GRACENOTE DISCLAIM ALL WARRANTIES EXPRESS OR IMPLIED, INCLUDING, BUT NOT LIMITED TO, IMPLIED WARRANTIES OF MERCHANTABILITY, FITNESS FOR A PARTICULAR PURPOSE, TITLE, AND NON-INFRINGEMENT. NEITHER GRACENOTE WARRANTS THE RESULTS THAT WILL BE OBTAINED BY YOUR USE OF THE GRACENOTE SOFTWARE OR ANY GRACENOTE SERVER. IN NO CASE WILL GRACENOTE BE LIABLE FOR ANY CONSEQUENTIAL OR INCIDENTAL DAMAGES OR FOR ANY LOST PROFITS OR LOST REVENUES FOR ANY REASON WHATSOEVER.

© Gracenote 2007.

Appendices

Vehicle with SYNC only United States and Mexico

FCC ID: KMHSG1G1

IC: 1422A-SG1G1

Mexico

Model: KMHSG1P1

NOM-121-SCT1-2009

The operation of this equipment is subject to the following two conditions: (1) This equipment or device may not cause harmful interference, and (2) this equipment or device must accept any interference, including interference that may cause undesired operation.

Vehicle with SYNC with Touchscreen/My Touch

FCC ID: KMHSYNGG2

IC: 1422A-SYNGG2

This device complies with Part 15 of the FCC Rules and with RSS-210 of Industry Canada. Operation is subject to the following two conditions: (1) This device may not cause harmful interference, and (2) this device must accept any interference received, including interference that may cause undesired operation.

WARNING



Changes or modifications not expressly approved by the party responsible for compliance could void the user's authority to operate the equipment. The term "IC" before the radio certification number only signifies that Industry Canada technical specifications were met.

The antenna used for this transmitter must not be co-located or operating in conjunction with any other antenna or transmitter.

Index

2

2-Speed Rear Axle.....	118
Axle Shifting.....	118

A

A/C	
See: Climate Control.....	70
About This Manual.....	7
Diesel Engine Information.....	8
Minor Troubleshooting Guide.....	9
Warnings.....	8
ABS	
See: Brakes.....	119
ABS driving hints	
See: Hints on Driving With Anti-Lock Brakes.....	120
Accessories.....	312
Accessories	
See: Replacement Parts Recommendation.....	13
Adjusting the Headlamps.....	205
Horizontal Aim Adjustment.....	206
Vertical Aim Adjustment.....	205
Adjusting the Steering Wheel.....	44
Air Brakes.....	123
Air Chamber Stroke Indication.....	124
Cam Brakes - Automatic Slack Adjusters.....	124
Emergency Air Brake.....	124
Air Conditioning	
See: Climate Control.....	70
Air Filter	
See: Changing the Engine Air Filter - 6.7L Diesel.....	210
See: Changing the Engine Air Filter - 6.8L.....	209
Air Induction System Inspection.....	217
Chassis-mounted Charge Air Cooler.....	218
Air Suspension.....	136
Air Suspension Dump Button.....	136
Connecting and Disconnecting a Trailer with Air Suspension and Air Suspension Dump Button.....	136
Suspension Conversions.....	136
System Indicator Light.....	136
Appendices.....	348

Audible Warnings and Indicators.....	61
Beltminder Warning.....	61
Door Ajar.....	61
Headlamps On Warning Chime.....	61
Key in Ignition Warning Chime.....	61
Parking Brake On Warning Chime.....	61
Audio Control.....	44
Media.....	45
Seek, Next or Previous.....	45
Audio Input Jack.....	279
Audio System.....	272
General Information.....	272
Audio Unit - Vehicles With: AM/FM/CD/ SYNC.....	274
Audio Unit - Vehicles With: AM/FM.....	273
Automatic Transmission.....	112
Brake-Shift Interlock.....	115
If Your Vehicle Gets Stuck In Mud or Snow.....	116
Understanding the Shift Positions of a 6-Speed Automatic Transmission.....	112
Understanding your SelectShift™ Automatic transmission.....	113
Automatic Transmission Fluid	
Check.....	198
Transmission Fluid Level.....	199
Auxiliary Power Points.....	81
110 Volt AC Power Points.....	81
12 Volt DC Power Point.....	81
Locations.....	81
Auxiliary Switches.....	312
Axle Inspection.....	222
Front Axle.....	222

B

Battery	
See: Changing the 12V Battery.....	203
Bonnet Lock	
See: Opening and Closing the Hood.....	181
Booster Seats.....	25
Types of Booster Seats.....	25
Brake Fluid Check.....	200
Brakes.....	119
General Information.....	119
Brake System Inspection.....	219
Air Brakes.....	219
Driveline Parking Brake.....	221

Index

Hydraulic Brakes.....	221
Breaking-In.....	143
Bulb Specification Chart.....	208

C

California Proposition 65.....	13
Capacities and Specifications - 6.7L	
Diesel.....	263
Engine Oil Specifications.....	270
Specifications.....	266
Capacities and Specifications -	
6.8L.....	258
Specifications.....	259
Capacities and Specifications.....	252
Car Wash	
See: Cleaning the Exterior.....	226
Changing a Bulb.....	207
Brake Lamp, Rear Lamp, Rear Direction	
Indicator, License Plate Lamp and	
Reverse Lamp.....	208
Front Clearance and Identification	
Lamp.....	207
Headlamp Bulbs.....	207
Changing a Fuse.....	169
Fuses.....	169
Changing a Road Wheel.....	248
Tire Change Procedure.....	248
Changing the 12V Battery.....	203
Battery Management System (If	
Equipped).....	204
Changing the Coalescer Filter	
Element.....	188
Changing the Engine Air Filter - 6.7L	
Diesel.....	210
Air Filter Replacement.....	211
Air Filter Restriction Gauge.....	210
Changing the Engine Air Filter -	
6.8L.....	209
Changing the Engine-Mounted and	
Diesel Fuel Conditioner Module Fuel	
Filters.....	214
Diesel Fuel Conditioner Module Filter.....	214
Engine-mounted Fuel Filter.....	216
Changing the Engine Oil and Oil	
Filter.....	187
Engine lubrication for severe service	
operation.....	188

Changing the Wiper Blades.....	205
Checking the Wiper Blades.....	205
Child Restraint and Seatbelt	
Maintenance.....	36
Child Restraint Positioning.....	27
Child Safety.....	17
General Information.....	17
Child Safety Locks.....	28
Cleaning Products.....	225
Cleaning the Alloy Wheels.....	230
Cleaning the Engine.....	227
Cleaning the Exterior.....	226
Exterior Chrome Parts.....	226
Exterior Plastic Parts.....	226
Stripes or Graphics.....	226
Underbody.....	227
Under Hood.....	227
Cleaning the Instrument Panel and	
Instrument Cluster Lens.....	229
Cleaning the Interior.....	228
Cleaning the Windows and Wiper	
Blades.....	228
Climate Control.....	70
Cold Weather Precautions.....	145
Winter Operating Tips for Arctic Operation	
-20°F (-29°C) and Below.....	146
Coolant Check	
See: Engine Coolant Check - 6.7L Diesel...194	
See: Engine Coolant Check - 6.8L.....189	
Cruise Control.....	45
Principle of Operation.....	132
Cruise control	
See: Using Cruise Control.....132	
Customer Assistance.....	155

D

Data Recording.....	12
Service Data Recording.....	12
Daytime Running Lamps.....	48
Diesel Particulate Filter.....	87
Direction Indicators.....	48
Doors and Locks.....	40
DPF	
See: Diesel Particulate Filter.....87	

Index

Draining the Fuel Filter Water Trap - 6.7L Diesel.....	202
Draining the Diesel Fuel Conditioner Module (DFCM).....	202
Driving Aids.....	134
Driving Hints.....	143
Driving Through Water.....	147
Operation in Standing Water.....	147
DRL	
See: Daytime Running Lamps.....	48
E	
Economical Driving.....	144
Electrical System Inspection.....	217
Accessory Feed Connections.....	217
Electronic Locking Differential.....	117
Activating the Locking Differential.....	118
Driver-Controlled Locking Differential.....	117
Servicing a Vehicle with a Locking Differential.....	118
Emission Control System - Diesel.....	105
Oxidation Catalytic Converter and Diesel Particulate Filter System.....	105
Emission Control System - Gasoline.....	103
On-Board Diagnostics (OBD-II).....	104
Readiness for Inspection and Maintenance (I/M) Testing.....	105
End User License Agreement.....	348
SYNC End User License Agreement (EULA).....	348
Engine Block Heater.....	88
Rapid Heat Supplemental Heating System.....	89
Using the Engine Block Heater.....	89
Engine Coolant Check - 6.7L Diesel.....	194
Adding Coolant.....	195
Checking Coolant Corrosion Inhibitor Additive Strength.....	197
Coolant Change.....	198
Engine and Secondary Cooling System Refill Procedure.....	196
Engine-driven Cooling Fan (Fan Clutch).....	198
Recycled Coolant.....	197
Severe Climates.....	197
Engine Coolant Check - 6.8L.....	189
Adding Coolant.....	190
Coolant Change.....	192
Engine Coolant Temperature Management.....	193
Engine-driven Cooling Fan (Fan Clutch).....	192
Fail-Safe Cooling.....	192
Recycled Coolant.....	191
Severe Climates.....	192
Engine Idle Shutdown.....	88
Engine Immobilizer	
See: Passive Anti-Theft System.....	42
Engine Oil Check - 6.7L Diesel.....	186
Adding Engine Oil.....	187
Engine Oil Check - 6.8L.....	185
Adding Engine Oil.....	185
Engine Oil Dipstick - 6.7L Diesel.....	185
Engine Oil Dipstick - 6.8L.....	185
Engine Specifications - 6.7L Diesel.....	252
Drivebelt Routing.....	252
Engine Specifications - 6.8L.....	252
Drivebelt Routing.....	252
Entering, Exiting or Climbing on This Vehicle.....	15
Environment.....	16
Essential Towing Checks.....	140
Before Towing a Trailer.....	140
Hitches.....	140
Safety Chains.....	140
Trailer Brakes.....	140
Trailer Lamps.....	140
When Towing a Trailer.....	140
Event Data Recording	
See: Data Recording.....	12
Exhaust Brake.....	124
Exhaust Brake Operating Characteristics.....	126
Exhaust System Inspection.....	218
Export Unique Options.....	14
Exterior Mirrors.....	51
Auxiliary Convex Mirrors.....	51
Clearance Lamps.....	52
Foldaway Exterior Mirrors.....	51
Heated Exterior Mirrors.....	52
Power Exterior Mirrors.....	51
Signal Indicator Mirrors.....	52
Telescoping Mirrors.....	52

Index

F

Fastening the Seatbelts.....	29
Energy Management Feature.....	33
Fastening the Cinch Tongue.....	31
Lap Belts.....	31
Seatbelt Locking Modes.....	32
Using Seatbelts During Pregnancy.....	32
Using the Seatbelt with Cinch Tongue (Front Center and Rear Center Seats Only).....	30
Federal Highway Administration Regulation.....	15
Fifth Wheel Operation.....	141
Hook-up.....	141
Un-hook.....	141
Ford Credit.....	13
US Only.....	13
Ford Protect.....	314
EXTENDED SERVICE PLAN (CANADA ONLY).....	315
Ford Protect (U.S. Only).....	314
Frame and Tow Hook Inspection.....	223
Front Seat Armrest.....	79
Fuel and Refueling.....	90
Fuel Consumption.....	102
Calculating Fuel Economy.....	102
Filling the Tank.....	102
Fuel Filter - 6.8L.....	202
Fuel Quality - Diesel.....	92
Biodiesel.....	93
Diesel Fuel Additives.....	94
Fuel Requirements - Choosing The Right Fuel: Vehicles Operated Where Ultra Low Sulfur Diesel Fuel Is Not Required	93
Fuel Requirements - Choosing The Right Fuel: Vehicles Operated Where Ultra Low Sulfur Diesel Fuel Is Required (United States/Canada/Puerto Rico/U.S. Virgin Islands And Other Locales)	92
Fuel Quality - Gasoline.....	91
Choosing the Right Fuel.....	91
Fuel Shutoff.....	149
Running Out Of DEF (Diesel Exhaust Fluid).....	150
Fuel Tank Selector Switch.....	111
Full Power Brake.....	123
Fuses.....	161

Fuse Specification Chart.....	161
Passenger Compartment Fuse Panel.....	166
Power Distribution Box.....	161

G

Gauges.....	54
Diesel Engines.....	56
Diesel Exhaust Fluid (DEF) Gauge.....	57
Engine Coolant Temperature Gauge.....	55
Engine Oil Pressure Gauge.....	55
Fuel Gauge.....	55
Gasoline Engines.....	54
Gauge Package.....	55
Information Display.....	56
Transmission Fluid Temperature Gauge.....	55
General Driving Points.....	143
Backing Up.....	143
General Information.....	143
Parking.....	144
General Information on Radio Frequencies.....	38
General Maintenance Information.....	316
Multi-point Inspection.....	322
Owner Checks and Services.....	320
Protecting Your Investment.....	316
Why Maintain Your Vehicle?.....	316
Why Maintain Your Vehicle at Your Dealership?.....	316
Getting Assistance Outside the U.S. and Canada.....	158
Getting the Services You Need.....	155
Away From Home.....	155

H

Handbrake See: Parking Brake.....	120
Hazard Warning Flashers.....	149
Headlamp Adjusting See: Adjusting the Headlamps.....	205
Headlamp Removal See: Removing a Headlamp.....	207
Head Restraints.....	73
Adjusting the Head Restraint.....	74
Heated Exterior Mirrors.....	72

Index

Heating	
See: Climate Control.....	70
Hints on Controlling the Interior	
Climate.....	71
Cooling the Interior Quickly.....	71
General Hints.....	71
Heating the Interior Quickly.....	71
Recommended Settings for Cooling.....	71
Recommended Settings for Heating.....	71
Side Window Defogging in Cold Weather.....	72
Vehicle Stationary for Extended Periods During Extreme High Ambient Temperatures.....	71
Hints on Driving With Anti-Lock Brakes.....	120
Hood Lock	
See: Opening and Closing the Hood.....	181
I	
Ignition Switch.....	84
In California (U.S. Only).....	156
Information Display Control.....	45
Information Displays.....	62
General Information.....	62
Information Messages.....	64
Diesel Messages.....	65
Engine.....	68
Fuel.....	68
Key.....	68
Maintenance.....	68
Park Brake.....	69
Installing Child Restraints.....	18
Child Seats.....	18
Tether Strap Attachment.....	24
Using Cinch Tongue Lap and Shoulder Belts (All Front Center, Super Cab and Crew Cab Rear Center Positions).....	21
Using Lap and Shoulder Belts.....	19
Using Lower Anchors and Tethers for Children (LATCH).....	23
Using Tether Straps.....	23
Instrument Cluster.....	54
Instrument Lighting Dimmer.....	48
Interior Lamps.....	49
Dome and Map Lamps.....	49
Map Lamps.....	49
Interior Mirror.....	53
Introduction.....	7
J	
Jump Starting the Vehicle.....	150
Connecting the Jumper Cables.....	151
Jump Starting.....	152
Preparing Your Vehicle.....	150
Removing the Jumper Cables.....	152
K	
Keys and Remote Controls.....	38
L	
Lighting Control.....	47
Headlamp Flasher.....	48
High Beams.....	47
Lighting.....	47
General Information.....	47
Limited Slip Differential.....	117
Load Carrying.....	135
Load Limit.....	135
Unloaded or Lightly Loaded Vehicles.....	135
Locking and Unlocking.....	40
Autolock and Autounlock.....	40
Battery Saver.....	41
Illuminated Entry.....	41
Power Door Locks.....	40
Remote Control.....	40
Smart Unlocks.....	40
Lug Nuts	
See: Changing a Road Wheel.....	248
M	
Maintenance.....	180
General Information.....	180
Manual Climate Control.....	70
Manual Seats.....	75
Manual Lumbar.....	76
Moving the Seat Backward and Forward.....	75
Recline Adjustment.....	75
Tilting the Seatback Forward (Two-Passenger Bench Seat).....	76

Index

Message Center	
See: Information Displays.....	62
Mirrors	
See: Windows and Mirrors.....	50
Mobile Communications Equipment.....	14
Motorcraft Parts - 6.7L Diesel.....	255
Motorcraft Parts - 6.8L.....	254

N

Noise Pollution Control.....	16
Air Intake System.....	16
Body.....	16
Cooling System.....	16
Engine.....	16
Exhaust System.....	16
Transmission Enclosure.....	16
Normal Scheduled Maintenance.....	323
Intelligent Oil-Life Monitor™ (Diesel Engine Only).....	323
Normal Maintenance Intervals.....	324

O

Oil Change Indicator Reset.....	189
Oil Check	
See: Engine Oil Check - 6.7L Diesel.....	186
See: Engine Oil Check - 6.8L.....	185
Opening and Closing the Hood.....	181
Closing the Hood.....	182
Opening the Hood.....	181
Ordering Additional Owner's Literature.....	159
Obtaining a French Owner's Manual.....	159
Overhead Console.....	83

P

Parking Brake.....	120
Air Brakes.....	121
Hydraulic Brakes.....	120
Passive Anti-Theft System.....	42
SecuriLock®.....	42
PATS	
See: Passive Anti-Theft System.....	42
Perchlorate.....	13
Power Door Locks	
See: Locking and Unlocking.....	40

Power Seats.....	76
Air-Ride Seat.....	77
Power Steering Fluid Check.....	201
Power Take-Off.....	116
Power Windows.....	50
Bounce-Back.....	50
One-Touch Up or Down.....	50
Window Lock.....	50
Protecting the Environment.....	16

R

Rear Axle Fluid Check.....	223
Changing the Fluid.....	224
Checking the Fluid Level.....	224
Rear Axle.....	117
General Information.....	117
Rear Seat Armrest.....	80
Rear Seats.....	78
Folding the Rear Seat Back (Crew Cab)	78
Folding up the Rear Seat Cushion.....	78
Returning the Seat to the Seating Position.....	78
Recommended Towing Weights.....	139
Refueling - Diesel.....	101
Fuel Filler Cap.....	101
Fuel Fill Rate.....	102
Refueling - Gasoline.....	100
Fuel Filler Cap.....	100
Remote Control.....	38
Car Finder.....	39
Integrated Keyhead Transmitters	38
Replacing the Battery.....	38
Sounding a Panic Alarm.....	39
Removing a Headlamp.....	207
Repairing Minor Paint Damage.....	229
Replacement Parts	
Recommendation.....	13
Collision Repairs.....	13
Scheduled Maintenance and Mechanical Repairs.....	13
Warranty on Replacement Parts.....	14
Replacing a Lost Key or Remote Control.....	39
Reporting Safety Defects (Canada Only).....	160

Index

Reporting Safety Defects (U.S. Only).....	159
Roadside Assistance.....	148
Vehicles Sold in Canada: Getting Roadside Assistance.....	148
Vehicles Sold in Canada: Roadside Assistance Program Coverage.....	149
Vehicles Sold in Canada: Using Roadside Assistance.....	149
Vehicles Sold in the United States: Getting Roadside Assistance.....	148
Vehicles Sold in the United States: Using Roadside Assistance.....	148
Roadside Emergencies.....	148
Running-In	
See: Breaking-In.....	143
Running Out of Fuel - Diesel.....	95
Purging Air From the System.....	95
Starting the Engine.....	95
Running Out of Fuel - Gasoline.....	95
S	
Safety Precautions.....	90
Low Fuel Pressure.....	91
Satellite Radio.....	277
Satellite Radio Electronic Serial Number (ESN).....	278
Satellite Radio Reception Factors.....	277
SIRIUS® Satellite Radio Service.....	277
Troubleshooting.....	278
Scheduled Maintenance Record.....	338
Scheduled Maintenance.....	316
Seatbelt Extension.....	36
Seatbelt Height Adjustment.....	33
Seatbelt Reminder.....	34
Belt-Minder™.....	34
Seatbelts.....	29
Principle of Operation.....	29
Seatbelt Warning Lamp and Indicator	
Chime.....	34
Conditions of operation.....	34
Seats.....	73
Security.....	42
Selective Catalytic Reduction System - Diesel.....	95
Contaminated Diesel Exhaust Fluid or Inoperative Selective Catalytic Reduction System.....	99
Diesel Exhaust Fluid Guidelines and Information.....	98
Diesel Exhaust Fluid Level.....	96
Diesel Exhaust Fluid Warning Messages and Vehicle Operations.....	97
Filling the Diesel Exhaust Fluid Tank.....	96
Sitting in the Correct Position.....	73
Snow Chains	
See: Using Snow Chains.....	247
Special Notices.....	14
New Vehicle Limited Warranty.....	14
Special Instructions.....	14
Special Operating Conditions Scheduled Maintenance.....	328
Diesel Engine.....	331
Exceptions.....	336
Gasoline Engines.....	328
Speed Control	
See: Cruise Control.....	132
Spring U-Bolt Check.....	224
U-bolt Nut Torque.....	224
Starter Switch	
See: Ignition Switch.....	84
Starting a Diesel Engine.....	86
Cold Weather Starting.....	86
Diesel Engine Fast Start Glow Plug System.....	86
Starting a Gasoline Engine.....	85
Failure to Start.....	85
Guarding Against Exhaust Fumes.....	85
Important Ventilating Information.....	85
Stopping the Engine When Your Vehicle is Moving.....	85
Stopping the Engine When Your Vehicle is Stationary.....	85
Starting and Stopping the Engine.....	84
General Information.....	84
Steering.....	134
Steering System Inspection.....	222
Hydraulic System.....	223
Steering Column Joint Bolts.....	223
Steering Wheel.....	44

Index

Storage Compartments.....	83
Sun Visors.....	53
Slide-on-rod.....	53
Suspension System Inspection.....	223
Switching Off the Engine.....	88
Symbols Glossary.....	10
SYNC™.....	281
General Information.....	281
SYNC™ Troubleshooting.....	306

T

Technical Specifications	
See: Capacities and Specifications.....	252
The Better Business Bureau (BBB) Auto Line Program (U.S. Only).....	157
Tire Care.....	233
Glossary of Tire Terminology.....	233
Information Contained on the Tire Sidewall.....	233
Tires	
See: Wheels and Tires.....	233
Towing a Trailer.....	138
Load Placement.....	138
Towing.....	138
Traction Control.....	130
Principle of Operation.....	130
Trailer Brakes.....	126
Trailer Air Supply and Parking Brake Modular Controls.....	127
Trailer Brake Hand Control.....	126
Transmission Code Designation.....	257
Transmission.....	112
See: Transmission.....	112
Transporting the Vehicle.....	153

U

Under Hood Overview - 6.7L	
Diesel.....	184
Under Hood Overview - 6.8L.....	183
USB Port.....	279
Using Cruise Control.....	132
Switching Cruise Control Off.....	133
Switching Cruise Control On.....	132
Using Snow Chains.....	247

Using SYNC™ With Your Media Player.....	297
Accessing Your Play Menu.....	302
Connecting Your Digital Media Player to the USB Port.....	297
Media Menu Features.....	300
Media Voice Commands.....	299
System Settings.....	304
What's Playing?.....	298
Using SYNC™ With Your Phone.....	285
Accessing Features Through the Phone Menu.....	290
Accessing Your Phone Settings.....	293
Making a Call.....	288
Pairing a Cell Phone for the First Time.....	285
Pairing Subsequent Cell Phones.....	286
Phone Options during an Active Call.....	288
Phone Voice Commands.....	287
Receiving Calls.....	288
System Settings.....	294
Text Messaging.....	291
Using Traction Control - Vehicles With: Air Brakes.....	130
System Indicator Light.....	130
Using Traction Control - Vehicles With: Hydraulic Brakes.....	130
System Indicator Light.....	131
Using Voice Recognition.....	283
Initiating a Voice Session.....	283
System Interaction and Feedback.....	284
Utilizing the Mediation/Arbitration Program (Canada Only).....	157

V

Vehicle Care.....	225
General Information.....	225
Vehicle Certification Label.....	257
Vehicle Identification Number.....	256
Vehicle Inspection Guide.....	171
Vehicle Inspection Information.....	171
Trailer.....	178
Transmission.....	178
Vehicle Storage.....	230
Battery.....	231
Body.....	230
Brakes.....	231

Index

Cooling system.....	231	Water in Fuel.....	61
Engine.....	231	Washer Fluid Check.....	201
Fuel system.....	231	Washers	
General.....	230	See: Cleaning the Exterior.....	226
Miscellaneous.....	231	See: Wipers and Washers.....	46
Removing Vehicle From Storage.....	231	Waxing.....	227
Tires.....	231	Wheel Nuts	
Ventilation		See: Changing a Road Wheel.....	248
See: Climate Control.....	70	Wheels and Tires.....	233
VIN		Technical Specifications.....	250
See: Vehicle Identification Number.....	256	Windows and Mirrors.....	50
Voice Control.....	45	Windshield Washers.....	46
W		Windshield Wipers.....	46
Warning Lamps and Indicators.....	58	Wiper Blades	
Anti-Lock Braking System.....	58	See: Checking the Wiper Blades.....	205
Automatic Regeneration Control.....	58	Wipers and Washers.....	46
Battery.....	58		
Brake System.....	58		
Check Fuel Cap.....	58		
Check Suspension.....	58		
Cruise Control.....	58		
Diesel Exhaust Fluid (Diesel Engine Only).....	58		
Diesel Particulate Filter (Diesel Engine Only).....	59		
Direction Indicator.....	59		
Door Ajar.....	59		
Electronic Locking Differential.....	59		
Engine Oil Pressure.....	59		
Exhaust Brake On.....	59		
Fasten Seatbelt.....	59		
High Beam.....	59		
Hydromax.....	59		
Low Fuel Level (Gasoline Engine Only).....	59		
Parking Brake Warning.....	59		
Powertrain Malfunction/Reduced Power/Electronic Throttle Control (Gasoline Engine Only).....	60		
Service Engine Soon.....	60		
Traction Control (Diesel Engine Only).....	60		
Trailer Anti-Lock Brake System (ABS).....	60		
Transmission Tow/Haul.....	60		
Two Speed Axle.....	60		
Wait to Start (Diesel Engine Only).....	60		