

# OWNER'S MANUAL



*Wayfarer*

---

2020



**TIFFIN**  
MOTORHOMES

MADE TO MOVE YOU.



TIFFIN

MOTORHOMES

*Wayfarer*

---

TIFFIN MOTORHOMES, INC.

625 Fawn Grove Road | Winfield, AL 35594 205-487-4710

# TABLE OF CONTENTS

**\*VIEWING VIA PDF: Each page number is cross referenced. Simply click on the desired page number to direct you straight to that page\***

## 1

### GENERAL INFORMATION

WELCOME.....	1
ABOUT THIS MANUAL .....	1
DELIVERY .....	2
DEALER RESPONSIBILITIES.....	2
CUSTOMER RESPONSIBILITIES.....	3
TIFFIN MOTORHOMES LIMITED WARRANTY .....	3
MAJOR EQUIPMENT MANUFACTURERS.....	4
WARRANTY AND SERVICE .....	4
OWNER'S INFORMATION PACKAGE .....	4
CUSTOMER RELATIONS.....	5
SPECIFICATION LABELS .....	5
WEIGHT PROCEDURES.....	6
WEIGHT DISTRIBUTION.....	7
SAFETY MESSAGES.....	7

## 2

### SAFETY INSTRUCTIONS

SAFETY CONSIDERATIONS.....	9
GENERAL WARNINGS .....	9
PRE-DEPARTURE CHECKLIST.....	10
DRIVING SAFETY .....	11
FUELS FOR THE MOTORHOME .....	12
LIQUID PROPANE .....	13
LP GAS REGULATOR .....	15
LP DISTRIBUTION SYSTEM .....	15
RECOMMENDED PRACTICES .....	16
CARBON MONOXIDE WARNING .....	17

CO/LP DETECTOR .....	17
FIRE SAFETY .....	19
FIRE EXTINGUISHER .....	20
SMOKE DETECTOR .....	21
ELECTRICAL .....	21
LOADING .....	22
MAINTENANCE .....	22
EMERGENCY EXITS .....	22
PARKING PROCEDURES .....	23
TOWING HITCH .....	24

3

HEATING & AIR CONDITIONING

FURNACE .....	26
AIR CONDITIONING SYSTEM .....	27
THERMOSTAT CONTROLS .....	28
HEAT PUMP CONTROLS .....	28

4

LP GAS SYSTEM

LIQUID PROPANE (LP) TANK .....	31
LP TANK FILLING PRACTICES.....	32
LP GAS REGULATOR .....	32
LP QUICK DISCONNECT.....	33

5

MAJOR APPLIANCES

LP/GAS REFRIGERATOR .....	35
MICROWAVE OVEN .....	36
COOK TOP .....	37
WATER HEATER .....	38
WATER HEATER STORAGE .....	40
PRESSURE RELIEF VALVE .....	40

6

ENTERTAINMENT

TELEVISION SETS ..... 52  
DVD PLAYER ..... 52

7

CABINETS & FURNITURE

CABINETS ..... 54  
FURNITURE ..... 55  
BEDROOM AREA ..... 56

8

STRUCTURAL FEATURES

CHASSIS FEATURES ..... 58

9

ELECTRICAL FEATURES

GENERAL INFORMATION ..... 60  
CIRCUIT BREAKER BOXES ..... 62  
BATTERY INSPECTION AND CARE ..... 63  
120 – VOLT (VAC) AC RECEPTACLES ..... 65  
GROUND FAULT CIRCUIT INTERRUPT RECEPTACLES ..... 65  
CONVERTER/INVERTER ..... 66  
ELECTRICAL GENERATOR ..... 67  
AUTOMATIC TRANSFER SWITCH ..... 68  
CIRCUIT BREAKERS ..... 68  
FUSE BREAKERS ..... 69  
SEVEN PIN TOWING CONNECTOR ..... 70

10

HYDRAULIC LEVELING SYSTEM

WARNINGS AND PRECAUTIONS ..... 72  
PARKING THE COACH ..... 72  
HYDRAULIC LEVELING SYSTEM CONTROLS ..... 73

11

SLIDE-OUT FEATURES

GENERAL CONSIDERATIONS ..... 88  
 OPERATING PRECAUTIONS ..... 89  
 EXTENDING/RETRACTING THE SLIDE OUT ..... 89

12

EXTERIOR FEATURES

TOWING HITCH ..... 91  
 EXTERIOR SIDES ..... 91  
 SECURITY LIGHTS ..... 92  
 ELECTRIC STEPS ..... 92  
 MIRRORS..... 94

13

INTERIOR FEATURES

FLOORING ..... 96  
 CEILING .....96  
 WINDOW TREATMENTS .....97

14

PLUMBING & BATH FEATURES

MONITOR PANEL ..... 99  
 KITCHEN SINK ..... 99  
 BATH, SINK, SHOWER, & ACCESSORIES ..... 99  
 WATER PUMP ..... 100  
 CITY WATER CONNECTIONS ..... 101  
 FILLING FRESHWATER TANK ..... 102  
 SANITIZING ..... 102  
 WATER FILTER ..... 104  
 WATER HEATER BYPASS SYSTEM ..... 104  
 FRESH WATER LINES ..... 104  
 GENERAL INFORMATION ..... 105  
 TOILET ..... 105  
 BLACK WATER HOLDING TANK.....105

GRAY WATER HOLDING TANK .....	106
P-TRAPS .....	106
WASTEWATER DISPOSAL .....	106
SEWER CONNECTION AND CAMPING .....	107
NO FUSS FLUSH .....	107
EXTERIOR SHOWER.....	108

15

WINDOWS, AWNINGS, VENTS, AND DOORS

WINDOWS .....	110
AWNING .....	110
VENTS .....	118
DOORS .....	118

16

DRIVING YOUR MOTORHOME

SINGLE VISION CAMERA MONITOR SYSTEM .....	120
AM/FM/CD STEREO SYSTEM .....	120
DASHBOARD HEATING/COOLING CONTROLS .....	120

17

ROUTINE MAINTENANCE

WASHING .....	122
SEALS .....	123
PROPER SEALANTS FOR APPLICATION.....	123
WHEEL CARE .....	124
ROOF CARE & MAINTENANCE .....	124
MOISTURE MAINTENANCE .....	125
TIRE & SAFETY INFORMATION .....	128
TIRE PRESSURE .....	137
INTERIOR CARE .....	141
FABRICS .....	141
WALLS & CEILING .....	142
DASHBOARD .....	142
WOODWORK & FLOORS .....	142
COUNTERTOPS .....	142

ACCESSORIES ..... 143  
DETECTORS ..... 143  
CONDENSATION ..... 144  
ROUTINE MAINTENANCE SCHEDULES ..... 144  
WINTERIZING ..... 145  
DE-WINTERIZING ..... 146

MAINTENANCE & DATA CHART

RV OWNER'S DATA SHEET ..... 149  
RV OWNER'S MAINTENANCE RECORD ..... 150





# *Wayfarer*

---

GENERAL INFORMATION

CHAPTER

1



**TIFFIN**  
MOTORHOMES

MADE TO MOVE YOU.

#### DISCLAIMER

Many of the features and appliances described in this manual may or may not be reflected in the actual motorhome purchased, depending on the options and models selected by the motorhome owner. All items, materials, instructions, and guidance described in this manual are as accurate as possible at the time of printing. However, due to Tiffin Motorhomes' ongoing and dedicated commitment to excellence, improvement of Tiffin's motor homes is a continuing process. Consequently, Tiffin Motorhomes reserves the right to make substitutions and improvements in its makes and models of motor homes without prior notification. Substitutions of comparable or better materials, finishes, appliances, instrumentation, and instruction may be made at any time it is deemed prudent to provide the customer with the best possible motorhome meeting the customer's requirements.

Copyright © by Tiffin Motorhomes, Inc. - all rights reserved

Tiffin Motorhomes, Inc. ©

625 Fawn Grove Rd. Winfield, Al 35594

Phone: 205-487-4710

FAX: 205-487-0444

MERCEDES 24 HOUR ROAD SIDE SERVICE

800-367-6372

Email: [winfieldparts@tiffinmotorhomes.com](mailto:winfieldparts@tiffinmotorhomes.com)

[winfieldservice@tiffinmotorhomes.com](mailto:winfieldservice@tiffinmotorhomes.com)

## WELCOME TO A LIFE OF “ROUGHING IT SMOOTHLY”



Tiffin Motorhomes is excited that you have entered the world of motorhome travel and we believe that you and your family will enjoy this way of life for years to come. Your Tiffin built motorhome provides all the luxuries and comforts of home while allowing you to travel freely as you choose. But before heading out on the open roads, please make yourself familiar with this owner’s manual to learn more about the operations of your motorhome. Also, please work with your dealer to learn as much as possible about the functionality and features of your coach. And remember - *“Wherever you go, we go.”*

### ABOUT THIS MANUAL

This operator/owner’s manual was prepared with you in mind. We want to provide you with the information you need to properly care for and use your vehicle and equipment. Please carefully read through this manual to help you understand how everything in your motorhome works.

NOTE: This operator’s manual describes many features of your Wayfarer and includes instructions for its safe use. The manual, however, including its photography and illustrations, is of a general nature. Some equipment and features described in this manual may be optional or unavailable on your model. The instructions included are meant to serve as a guide and in no way extend the responsibilities of Tiffin Motorhomes beyond the standard written warranty. The descriptions, illustrations, and specifications in this manual were correct at the time of printing and Tiffin Motorhomes reserves the right to change specifications or design without notice, and without incurring obligation to install the same on products previously manufactured. Many of the instruction sheets and manuals for the various appliances inside your motorhome have been incorporated into this manual for your convenience. There’s also a flash drive in the information bag inside of your coach with instruction manuals to your appliances on it as well.

## GENERAL INFORMATION



# TIFFIN MOTORHOMES

WHEREVER YOU GO, WE GO.

## DELIVERY

Throughout the entire manufacturing process, your Tiffin motorhome has been regularly inspected by our qualified personnel to assure you of the finest product of the highest quality, without exception. However, the final inspection at our factory is not to be the last one. The pre-delivery inspection and system check that your dealer performs are the final inspections done to your particular motorhome prior to you actually receiving your new Wayfarer motorhome. Your dealer is also available to assist you in understanding the warranties and completing the necessary forms to activate the warranties for the various appliances and accessories installed in your motorhome.

## DEALER RESPONSIBILITIES

1. A pre-delivery inspection and systems check is performed to assure a thorough inspection of the motorhome and to assure the proper operation of all factory-installed components.
2. A customer walk-through is performed to familiarize the new customer with the motorhome, its systems and components, and their proper and safe operation.
3. Delivery of the Owner's Information Package which contains warranty cards and registrations for the vehicle and all factory-installed components from other vendors and suppliers to Tiffin Motorhomes. The detailed operation instructions and maintenance instructions on these components are also included in this package.
4. Assisting the customer in completing the registration forms to avoid loss of warranty coverage. The dealer should review the limited-warranty provisions with the customer to stress the importance of completing the warranty cards and registration forms for the components in the motorhome to enable the manufacturers to receive them within the prescribed time limits.
5. Providing the customer with information regarding warranty and non-warranty work on the vehicle and its separately warranted components.

## GENERAL INFORMATION

### CUSTOMER RESPONSIBILITIES

The customer is responsible for regular and proper maintenance of the motorhome. Properly maintaining your motorhome will prevent conditions arising from neglect that are not covered by your Tiffin Motorhomes limited warranty. The maintenance guidelines in this manual and any other, applicable manual(s) should be followed. It is your responsibility and obligation to return the vehicle to an authorized dealer for repairs and service.

To assist you in avoiding problems with your motorhome, it is recommended that you do the following:

1. Read the warranty. Go over it thoroughly with your dealer to make sure you understand all the terms and conditions of the warranty.
2. Please ask questions about anything you don't fully understand about your Wayfarer. Tiffin Motorhomes is here to serve you and assure that you have all the information necessary for your safe and enjoyable use of your new motor home.
3. When you are taking delivery, set an appointment for adjustments. This appointment should be within two weeks after you accept delivery.
4. You are responsible for and expected to use your Wayfarer in a responsible, safe manner. Please take the time to familiarize yourself with the proper operation of the motor home and all its features before you attempt to use your motor home.
5. Once a year the roof seals need to be inspected and replaced if need to prevent leaks. This can be done at a Tiffin Motorhomes Service Center.

### TIFFIN MOTORHOMES LIMITED WARRANTY

The Tiffin Motorhomes limited warranty was provided to you by your authorized Tiffin Motorhomes dealer during the pre-delivery inspection. When you inquire about your Tiffin Motorhomes warranty, please refer to this document. Should you need or desire an additional copy or other information, please contact:



Tiffin Motorhomes, Inc.

625 Fawn Grove Rd.

Winfield, Alabama 35594

Tiffin Motorhomes will be pleased to send you an additional copy or any other information requested, as may be warranted.

## MAJOR EQUIPMENT MANUFACTURERS

The following list is a compilation of the vendors and suppliers of the major subsystems and components of your Wayfarer. This list is provided for your convenience and is not meant as a complete substitution of the literature and accompanying “how to contact us” information supplied by those vendors and suppliers in your Owner’s Information Package. Where appropriate, website information is provided as well.

• Atwood Mobile Products	(800) 646-8557	atwoodmobile.com
• LP Gas Water Heater	(815) 877-5700	atwoodmobile.com
• HWH Corporation	(800) 321-3494	hwhcorp.com
• Kwikkee	(541) 942-3888	kwikkee.com
• Norcold, Inc.	(800) 543-1219	norcold.com
• Onan Corporation	(612) 574-5944	onanindiana.com
• RV Products (Coleman A/C)	(316) 832-3400	airxcel.com
• Precision Circuits Inc.	(630)-240-9832	precisioncircuitsinc.com
• Saf-T-Alert (CO/LP Alarm)	(800) 383-0269	safetalert.com
• Triple H	(800) 237-4277	triplehelectronics.com
• The Dometic Corporation	(219) 294-2017	dometic.com
• Lippert	(574)-535-1125	lippert.com

For those looking for more information (e.g., locations of authorized subsidiaries), the following web site, [www.rvamerica.com/data/s\\_alist.htm](http://www.rvamerica.com/data/s_alist.htm), should be helpful. This site provides complete, alphabetic listings of all suppliers and vendors for all contemporary recreational vehicles and motor homes.

## WARRANTY SERVICE

Mercedes-Benz covers roadside for the full term of the bumper-to-bumper chassis warranty 3 years or 36,000 miles. Tiffin Motorhomes warrants its unitized construction for 10 years and its laminations for five years. Any service work performed after the expiration of the Tiffin Motorhomes warranties WILL NOT be covered by those warranties. Exceptions may be made, on an individual basis, to this deadline on account of the unavailability of parts and/or service appointment time where work is to be performed. However, don’t rely on the possibility of an exception; please schedule any desired in-warranty work before your warranty expires.

## OWNER’S INFORMATION PACKAGE

The Owner’s Information Package includes valuable documents about your Wayfarer and its components and systems. By consulting the booklets and instruction manuals included in the Owner’s Information Package, you will learn how to operate, maintain, and troubleshoot these items safely and effectively. The Tiffin Motorhomes Wayfarer Owner’s Manual does not cover every possible detail of equipment—standard and/or optional—installed on or in your vehicle. As with all valuable documentation, please keep them in a safe, secure place for your later use and consultation. When you complete and mail to the respective manufacturer(s) any warranty/guaranty registration card(s) make a photocopy of both sides of

each card prior to mailing and keep the photocopy in your permanent records for your Wayfarer motorhome.

## CUSTOMER RELATIONS

If you wish to schedule maintenance or service or wish to order parts, you should notify your local authorized Tiffin Motorhomes dealership to set up an appointment. If you are unsure of the location of your nearest authorized Tiffin Motorhomes dealership, please access the Tiffin Motorhomes website at [www.tiffinmotorhomes.com](http://www.tiffinmotorhomes.com) and then click on the “Locate Dealer” button, then enter in the appropriate search criteria such as state and retail sales, then click on the red ball located on the map to find dealer information in that area.

## SPECIFICATION LABELS

There are two main numbers used to identify your Wayfarer. The Vehicle Identification Number (VIN) is the legal identification of the completed vehicle. The VIN is the number used by the state for vehicle identification and registration.



Another label affixed to your Wayfarer is the Recreational Vehicle Industrial Association (RVIA) label for Tiffin

Motorhomes, a manufacturer member of RVIA, has the obligation to disclose the following information, at minimum, to the purchaser of the motor home:



P.O. Box 596  
Red Bay, Alabama 35582  
[www.tiffinmotorhomes.com](http://www.tiffinmotorhomes.com)

Phone: (256) 356-8661  
Fax: (256) 356-8219  
[info@tiffinmotorhomes.com](mailto:info@tiffinmotorhomes.com)

---

**MOTORHOME WEIGHT INFORMATION**

YEAR: 2014      Model Name: 45 LP - Powerglide 51388

Serial Number: 7361

**GVWR (Gross Vehicle Weight Rating)**  
is the maximum permissible weight of the fully loaded motorhome.

**UVW (Unloaded Vehicle Weight)**  
is the weight of this motorhome as manufactured at the factory with full fuel, engine oil and contents.

**SCWR (Sleeping Capacity Weight Rating)**  
is the manufacturer's designed number of sleeping positions multiplied by 154 pounds (70 kilograms).

**CCC (Cargo Carrying Capacity)**  
is equal to GVWR minus each of the following: UVW, full fresh (potable) water weight (including water heater), full propane weight and SCWR.

CARGO CARRY CAPACITY (CCC) COMPUTATION			pounds	kilograms
GVWR			81,300	23,270
minus UVW			37,330	16,933
minus fresh water weight of	90 gallons @ 8.3lb/gal		747	339
minus propane weight of	24.5 gallons @ 4.2lb/gal		82	37
minus SCWR of	4 persons @ 154lb/person		616	279
<b>CCC for this motorhome*</b>			12,525	5,681
<b>GCWR</b>			66,300	

\*Dealer installed equipment and towed vehicle tongue weight will reduce CCC

**WARNING: CONSULT OWNERS MANUAL(S) FOR SPECIFIC WEIGHING INSTRUCTIONS AND TOWING GUIDELINES INCLUDING AUXILIARY BRAKE REQUIREMENTS FOR ANY TOWED TRAILER OR TOWED VEHICLE.**

This vehicle contains composite wood products that comply with the applicable California Code of Regulation Section 92120 Phase 1 or Phase 2 Formaldehyde emission standards.

*"Just ask someone who owns one"*

- An indication of the contents of the motorhome weight label affixed to the motorhome.
- A concise explanation of the following items: Vehicle Weight (VW) distribution and Proper weighing techniques to be used to weigh the vehicle.
- Specific definitions for the following terminology:

Gross Vehicle-Weight Rating (GVWR) – This is the maximum permissible weight of the motor home when it is fully loaded.

Unloaded Vehicle Weight (UVW) – This is the weight of the motor home, as built at the factory, with full fuel, engine oil, and coolants. The UVW does not include cargo, fresh water, LP gas, or any dealer installed accessories.

Cargo-Carrying Capacity (CCC) – This is the maximum weight of all occupants including the driver, personal belongings, food, fresh water, waste water, LP gas, tools, tongue weight of towed vehicle [if any], dealer-installed accessories, and the like. The CCC is equal to or less than the GVWR minus the UVW.

Gross Combination-Weight Rating (GCWR) – This is the value specified by the chassis manufacturer as the maximum allowable loaded weight of the motor home with a towed trailer and/or vehicle [if any].

Sleeping-Capacity Weight Rating (SCWR) – This is the maximum weight capacity of the combined number of persons (i.e., number of people multiplied by 154 pounds per person) permitted to sleep within the vehicle.

Gross Axle-Weight Rating (GAWR) – This is the maximum allowable weight for an axle; the GAWR considers the weakest link in the tire, wheel, brakes, hubs, axle, springs, and attaching parts. To illustrate, if the axle is rated at 15,000 pounds and the tires are rated at 3,200 pounds each as a dual installation; then the maximum GAWR would be 12,800 pounds for a four-tire vehicle.

## WEIGHT PROCEDURES

To weigh the motorhome properly, the motorhome should be level when the weighing process is performed. Your Wayfarer motorhome has been designed and built in compliance with the recommended limits of the major-component/system suppliers to provide a realistic CCC. It is up to the final user to provide even distribution of the loads brought into the motor home to prevent uneven loading. Once the vehicle is loaded, it can be taken to any certified drive-on scales or individual-wheel scales to determine that the final weight is within specified limits for the motorhome. The procedure that can be used is as follows:

First, drive the motorhome onto the scales so that all wheels are on the scales; this provides the gross vehicle weight (GVW) of the vehicle and can be recorded as such. The GVW should not exceed the GVWR specified for the vehicle.



## GENERAL INFORMATION

Second, drive the motorhome so that the front wheels are off the scales and only the rear wheels remain on the scales; this provides the total weight of the vehicle, save for the front axle. This weight should not exceed the total rating of the axles remaining on the scales. The front axle weight is determined by subtracting the weight from the GVW that was obtained in the first step which was performed earlier. The result should not exceed the listed front-axle weight rating.

## WEIGHT DISTRIBUTION

To assure the maximum stability of the motorhome under static (i.e., parked) and dynamic (i.e., moving) conditions, the distribution of the items to be carried and stored within the motorhome and in the storage bays underneath the motorhome should be performed in such a manner to strive for reasonably even side-to-side and front-to-rear dispersion of the weight of the stored items. This process will assure that the motorhome is not “lop-sided” in weight distribution (i.e., all the stored weight on one side and/or mainly towards the front or the rear)—keeping a center of mass of the motorhome essentially centered on a front-to-rear and side-to-side basis will also provide better control of the motorhome when it is in motion.

## SAFETY MESSAGES

Please note that several labels listed in this manual represent items that need your attention. The Danger, Warning, Caution, and Notice labels alert you to precautions that may help you avoid damage to your motorhome, its equipment or your personal safety. Please read and follow them carefully.

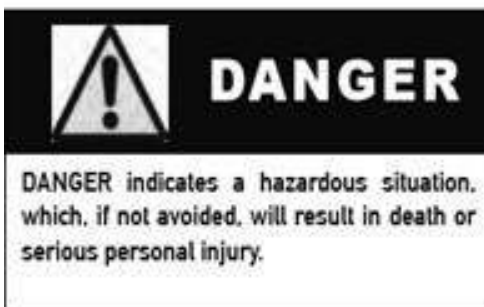



*Wayfarer*

---

SAFETY INSTRUCTIONS

CHAPTER

2

## SAFETY CONSIDERATIONS

Prior to using your motorhome, especially for the first time or after a long period of non-use, please read thoroughly all the instructions in the Owner's Manual and the chassis-manufacturer's manual before attempting to operate your motorhome. There are several safety considerations which you should realize and follow while your Wayfarer is in motion. These safety considerations, as well as others meant to preclude any damage to the motorhome, are listed in this chapter. Besides the driver, it would be helpful for the passengers to be familiar with these safety considerations and precautions, too.

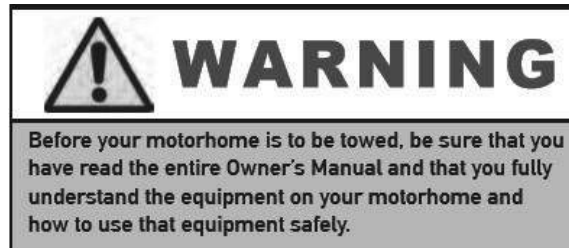

## GENERAL WARNINGS

In general, there are several "common-sense" safety precautions that should be taken every time the motorhome is to be used on the road. These precautions include:

- Only seats with seat belts should be used while the motorhome is in motion; those seat belts should be worn by all people (driver, passengers) in the motorhome at that time.
- While the motorhome is moving, lock all seats in the forward-facing position to provide maximum safety for the users.
- While the motorhome is moving, no one inside should ever stand or kneel on seats (e.g., young children).
- In the majority of states, it is the law that seat belts must be used (fastened snugly about the chest and hip areas), anytime the motorhome is in motion, to provide desired protection in the event of a crash.
- Any fire extinguisher(s) should be inspected on a monthly basis to assure that each extinguisher is properly charged and ready for operation.
- Any smoke and/or carbon-monoxide (CO)/liquid propane (LP) alarm(s) should be regularly inspected and tested. If being used for the first time, the smoke and/or CO/LP alarm should be properly activated and fresh batteries installed before the motorhome is placed into service. Never sleep in a motorhome not having functional smoke and/or CO/LP alarm(s).
- While the motorhome is moving, the sleeping facilities are not to be used.
- In the event of an emergency, be sure to be familiar with all escape exits (doors, escape window) Do not use the emergency window as a routine exit; this is strictly to be used for emergency purposes only.
- Movement inside the motorhome should be minimized while the motorhome is in motion.
- Never leave the driver's seat unattended while the motorhome is in motion.

## YOUR PRE-DEPARTURE CHECKLIST

For your continued safety and convenience, the following is a representative “check list” designed to assure your safety while driving:



- ✓ Clean all windows, mirrors, and light lenses (front, back, side) to assure that you can “see” and “be seen.” Reposition any mirrors or other fixtures to provide an unobstructed view (front, sides, and back) from the driver’s seat.
- ✓ Remove or secure all loose fixtures (e.g., awnings, flags, antennas, portable lights) to keep them from falling from the motorhome when the vehicle is in motion.
- ✓ Make a “walk-around” visual inspection of the motorhome to note any irregularities (e.g., loose trim) or problems (e.g., low tires); correct noted problems accordingly
- ✓ Check all exterior storage-compartment and generator-compartment doors to make sure they are properly latched. If need be, check inside all exterior compartments to make sure that all cargo and equipment are properly secured so they won’t work loose and become hazards during sudden starts and stops.
- ✓ Check tires for proper inflation (i.e., cold inflation pressure: 100 psi). If the motorhome has not been used, make sure that the “cold inflation” pressure is maintained. If the motorhome has recently been used, make sure that the “hot inflation” pressure (see the tire-manufacturer’s literature to determine appropriate “hot inflation” pressure) is maintained. All tire pressures should be within 1-2 pounds (psig) of each other.
- ✓ Examine wheel lug nuts to assure their proper tightness. If any lug nuts were found to be loose, first check the fit of the wheel to the hub to make sure the wheel is mounted properly. If the wheel is improperly mounted it could cause the wheel to wobble when the motorhome is in motion, then tighten the lug nuts.
- ✓ Check all fluid levels (e.g., engine oil, transmission fluid, coolant, power-steering fluid, brake fluid, battery fluid [if applicable], windshield-washer solvent) to assure correct levels are maintained. Fill any low reservoirs, as needed.
- ✓ **DO NOT SUBSTITUTE** any other fluids for specified oils, transmission fluid, brake fluid, or other hydraulic fluids—in most instances, substitutions are not acceptable and may void warranties.
- ✓ Prior to starting the motorhome engine, make sure all lines (e.g., water, sewer) and electrical power cords are disconnected and properly stowed.
- ✓ After entering the motorhome, make sure that the electrically-actuated, retractable step has properly
- ✓ Check visually that all stabilizer legs are retracted before operation of the motorhome.

## DRIVING SAFETY



Various adjustments need to be made to assure the driver's comfort and the safety of the motorhome before starting and moving the motorhome; these include:

- Do not attempt to adjust the driver's seat while the vehicle is moving.
- Do not adjust the tilt steering while the vehicle is moving.
- The driver should be familiar with all gauges, instruments, switches, and indicators on the instrument panel prior to driving.
- Do not operate the cruise-control function during any extreme weather situations (e.g., snow, ice, sleet, heavy rain) or when road conditions are hazardous (icy, snowy, winding roads, city traffic) or when a constant speed of the motorhome is not possible or if traffic conditions don't warrant such.
- Avoid driving the motorhome through any standing water. If deep enough, such water can wet the brake pads and cause fading of the brakes (i.e., loss of braking power) and lead to excessive sliding or pulling to one side or another.
- Know the limits of operation of the motorhome. Don't try to achieve excessive speeds, climb overly steep hills, traverse overly long grades, attempt to use the motorhome as an "off the road" (OTR) motorhome, rapidly switch lanes, or rapidly accelerate or decelerate the motorhome. When in doubt about the handling characteristics of the motorhome, consult your chassis manual for information.
- NEVER drive the vehicle with a slide out room extended.

Figure 2-1: Driver's side dashboard and instrument console



## FUELS FOR THE MOTORHOME

 <b>WARNING</b>	
<p>Liquid propane (LP) gas containers, gasoline, or other flammable liquids are not to be placed or stored inside the motorhome because a fire or explosion may occur. LP gas containers (Figure 2-2) are equipped with safety valves that may relieve excess pressure by discharging gas into the atmosphere—any containment of that vented LP gas constitutes an explosive hazard.</p>	Figure 2-2: LP tank

Your motorhome is designed to use diesel only for the engine used in the routine operation of the motorhome—these require prudent and safe handling to assure safety of the motorhome and its occupants; namely:

- Anytime the motor fuel or the LP tank is to be filled, the motorhome engine is to be turned OFF and all pilot lights and appliances should be turned OFF.
- A NO SMOKING policy should always be observed when refilling the fuel or propane gas tank.
- NEVER use an open flame to test for LP gas leaks or to examine the fluid levels in the fuel tanks.
- After filling any LP system, immediately replace and secure all protective covers and caps.
- After closing the LP valve, close and securely latch the LP door to prevent unintentional access or damage.
- NEVER connect natural gas to the LP gas system—LP gas and natural gas are not interchangeable.
- When lighting range burners, do not turn burner controls to “On” and allow the gas to escape before lighting.
- NEVER use any other “burning” equipment (e.g., charcoal grills, wood stoves, butane lights, propane lights) inside the motorhome. Doing so may cause fires and/or asphyxiation.

	<b>DANGER</b>
<p>All pilot lights, appliances, and their ignitors must be turned off before refueling of motor fuel tanks or propane containers. A failure to comply, could result in serious injury or death.</p>	

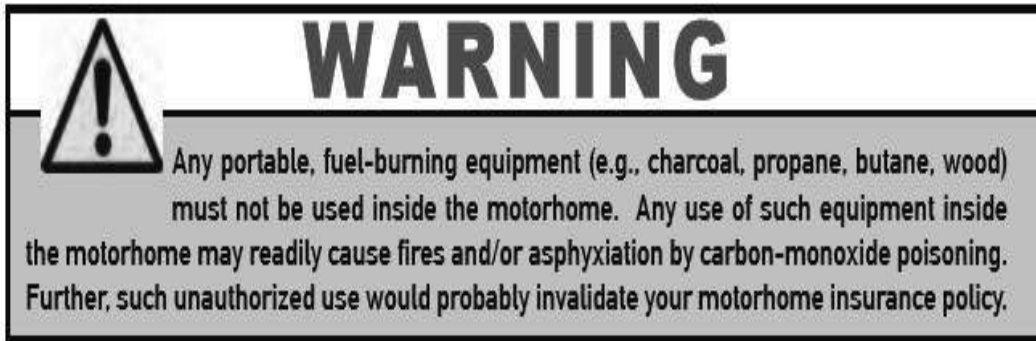

## LIQUID PROPANE (LP) GAS SYSTEM

Check the propane gas system for leaks yearly or as necessary. If you smell gas within the motorhome, quickly perform the following:

### IF YOU SMELL PROPANE

- Extinguish any open flames, pilot lights and all smoking materials.
- Do not touch electrical switches.
- Shut off the gas supply at the tank valve or gas supply connection.
- Open doors, windows and other ventilating openings.
- Leave the area until the odor clears.
- Have the propane system checked and leak source corrected immediately, failure to comply could result in serious injury or death.

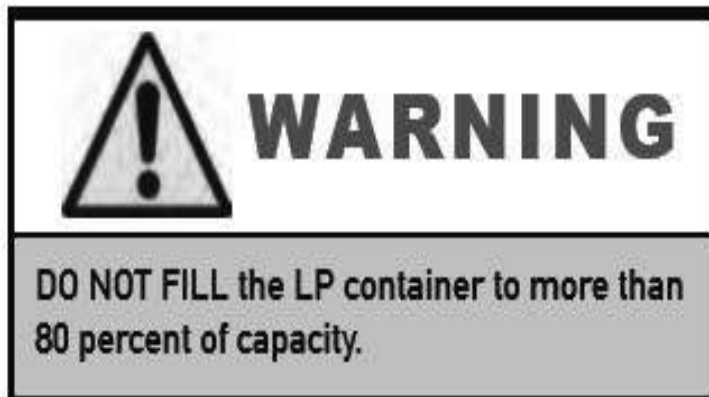

A WARNING label such as this is located near the LP gas container.

Any overfilling of the LP gas container(s) can result in uncontrolled gas flow—a prime condition for a fire or explosion.

The LP container should only be filled to 80 percent of its capacity; the remainder of the cylinder space is an air space to contain expansion of that liquid when subjected to varying ambient-temperature conditions. Filling in excess of 80 percent of the liquid volume of the container reduces that air space and, thus, creates a condition for possible over-pressurization of the container.



Figure 2-3: LP Tank

All LP appliances in your motorhome have been approved for use in motorhomes by a nationally-recognized testing laboratory (i.e., UL and CSA certified). When properly used, LP gas is a clean-burning fuel which can be dependably used. In actuality, the LP container contains liquid propane under high pressure.

The liquid, when it passes through the tank valve to a lower pressure, vaporizes into a gas, and then passes through a regulator to maintain a constant pressure. This gas, then, is the actual fuel distributed through the LP gas manifold system to the LP based appliances used in your motorhome.

LP appliance lighting problems are typically caused by an improperly-adjusted gas regulator. NEVER attempt to adjust or reset the gas regulator yourself. An authorized service technician is needed to make these adjustments. As a good preventive-maintenance procedure, the regulator should be checked annually by a service technician and also before every extended trip. Even though the LP gas system is leak-checked and verified at the factory at the time of manufacture, normal usage (travel vibrations, etc.) could loosen the fittings. Consequently, it is wise to check the gas fittings periodically for leak tightness.

You can wipe some leak-detector solution (e.g., a “liquid-soap” like solution) on all the fittings, connections, and junctures when the system is under pressure. Should there be any leaks, small bubbles will appear at any leak sites.

Generally, loose fittings can be tightened to stop the leaks. If this process doesn’t work, then you must shut off the main gas valve at the LP cylinder(s) and immediately consult an authorized service technician to determine what repairs are necessary. Leaks may also be detected by noting a sulfurous odor (i.e., rotten eggs). DO NOT search for a leak by using a match or open flame.



 **WARNING**

When the motorhome is not in use, be sure to close the main LP gas valve at the tank. When the LP gas tank is to be refilled, close the main valve to preclude the chance of pilot lights possibly igniting fumes from the LP fuel. As some LP-gas appliances (e.g., refrigerator, furnace, water heater) have Direct Spark Ignition (DSI) systems, it is very important that these appliances be turned off when the LP gas is off. The DSI boards will continue to work (i.e., emit an ignition spark) even when there is no LP gas available.

## LP GAS REGULATOR

The LP gas regulator (Figure 2-4) is the most critical element of the LP-gas distribution system. The regulator converts the high-pressure LP gas from the tank into a reduced-pressure LP-gas supply suitable for use in the various appliances in the motorhome.

You should regularly inspect the regulator system. If any damage or corrosion is noted, contact an authorized service technician to inspect and repair or replace the regulator.



Figure 2-4 LP Gas Regulator

Do not attempt to adjust the regulator yourself; the regulator has been pre-set at the factory. Only a qualified LP service technician using specialized equipment should adjust the regulator.

## LP DISTRIBUTION SYSTEM

The primary LP distribution system in the motorhome is a steel manifold located underneath the motorhome. The secondary distribution lines running from this main distribution system are usually reinforced rubber supply lines.

If any of the gas lines break, do not attempt to splice them—always run new lines to maintain the safety of the motor home. It is strongly recommended that only qualified service technicians perform this work.

Remember, the main valve at the LP gas tank must be closed whenever any gas appliance is to be installed, removed, or serviced—this process prevents LP gas leakage which could result in a possible harmful explosion. If the odor of LP gas is ever detected, immediately discontinue use of any gas appliances and seek the services of a qualified service technician.



## RECOMMENDED PRACTICES

The following practices are recommended to assure continued safety and reliability of the LP gas system. These are, of course, representative; not necessarily exhaustive. In all cases, use common sense in the use of the LP system.

- Visually inspect the LP fill valve before any refueling operation to look for foreign materials or debris; remove, as necessary, to assure a leak-tight connection.
- Prior to any refueling operation of the LP gas system, shut off all the pilot lights.
- NEVER, under any circumstances, check for LP gas leaks with any type of open flame; doing so would probably cause an explosion and subsequent fire.
- Periodically inspect visually the entire LP gas distribution system; do so at least annually and before any major trips.

Should problems be noted, seek the services of a qualified service technician to make necessary repairs and perform any maintenance.

## CARBON MONOXIDE WARNING

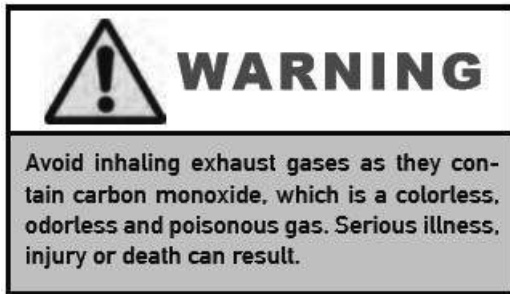

A properly maintained engine exhaust and ventilation system is the best way to protect against carbon monoxide's entry into the vehicle. We recommend that the exhaust system and body be inspected by a qualified motorhome service center:

- Each time the vehicle is serviced for an oil change.
- Whenever a change in the sound of the exhaust system is noticed.
- Whenever the exhaust system, underbody, or rear of the vehicle is damaged.

To allow proper operation of the vehicle's ventilation system, keep front ventilation inlet grill clear of obstructions at all times. Do not occupy a parked vehicle with engine running for an extended time and do not run engine in confined areas, such as a garage.

Your motorhome is equipped with a Carbon Monoxide alarm, which has a sensor that is designed to detect carbon monoxide gas fumes resulting from incomplete combustion of fuel. It will detect carbon monoxide gas from any combustion source such as from the furnace, oven/ range, water heater, refrigerator, chassis engine and generator engine.

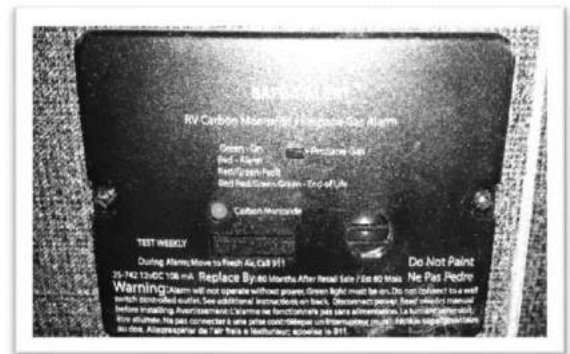

Figure 2-5: Carbon Monoxide alarm

## CO/LP GAS DETECTOR

Since LP gas is denser than air, the LP gas will naturally settle to the lowest point in an enclosed space. In the motorhome, this would be the floor.

Because of this, the CO/LP gas detector (Figure 2-5) is necessarily mounted close to the floor. To activate the CO/LP-gas sensor on this detector for the first time, remove the sensor activation strip, if such was not performed during the pre-delivery inspection.

If the alarm persists in re-arming and giving further alarms, ventilate the motorhome by opening doors and windows and then check for possible LP gas leaks. If the leak cannot be readily found, SAFELY, then close the main valve to the LP tank and turn “off” all gas appliances and then take the motorhome to a qualified service technician after the ventilation process is concluded and the doors and windows again shut.

This single compact system provides a powerful combined alarm that detects both Carbon Monoxide (CO) and explosive gases Propane (LPG) and Methane (Natural Gas). This detector uses the latest microprocessor technology combined with two electronic self-cleaning sensors that operate independently of each other. The combined unit can detect both CO and explosive gases simultaneously.

Carbon monoxide (CO) is a colorless, odorless, tasteless gas which, when breathed, bonds to the hemoglobin in the red blood cells and, thus, drastically reduces or blocks the transfer of oxygen from the lungs to the rest of the body.

In sufficient concentrations, CO kills by asphyxiation. In lesser amounts, CO makes the victim groggy, lethargic, and unable to think clearly or quickly.

CO is one of the products of combustion for many materials including petroleum-based products (e.g., gasoline, diesel fuel, propane, butane; among others). Since many of the appliances and the engines associated with the motorhome produce CO in their normal operations, it is necessary to assure that CO levels do not rise to dangerous levels within the motor home. In sufficiently high concentrations, CO can kill in minutes.

The most susceptible people to CO poisoning are unborn babies, small children, pregnant women, senior citizens, and people with cardiovascular or respiratory problems

Consequently, it is prudent to check the CO monitor regularly for normal operation and to remain aware of the symptoms of CO poisoning which include dizziness, nausea, vomiting,

Muscular twitching, throbbing in the temples, incoherent thinking and speech, weakness, sleepiness, and intense headaches.

Should any of these symptoms be experienced in the motorhome, you should IMMEDIATELY evacuate the motorhome and seek medical help. Shut down the motorhome and do not attempt to operate it again until the source(s) of the CO are located and fixed.



## **DANGER**

Carbon monoxide gas—derived from products of combustion of diesel fuel, LP gas, and other petroleum-based products—is a deadly gas which can kill motorhome occupants, if allowed to accumulate in sufficient concentration. Assure that all engine operations are not restricted—tailpipes and exhaust ports should not be blocked or restricted in any way. Additionally, any accumulation of exhaust gases outside or underneath the vehicle should be avoided as such may enter the motor home through windows or vents—be careful how and where the motor home is parked to avoid such conditions. Regularly monitor outside conditions to assure that all exhaust gases can readily be dissipated and not enter the motor home inadvertently.

## **DANGER**



Never sleep in a motorhome when the engine is running—engine exhaust fumes could enter the motorhome and cause disability or death. Regularly check the exhaust system to note any leakage sites and, if found, discontinue use of the motor home until they are repaired by a competent, qualified service technician. Do not attempt repairs on the exhaust system yourself and do not modify (temporarily or permanently) the exhaust system at all.

### **FIRE SAFETY**

As with any enclosed system containing the three required conditions for fire (i.e., combustible materials, oxygen, ignition sources), there will exist the possibility of fire. Tiffin Motorhomes has taken every precaution and design practice to minimize or negate this possibility, but the final determination rests with the owner and user of the motorhome. Accordingly, it is in the best interests of the owners, users, and their guests to be aware of basic fire-safety practices and procedures and those particular features that Tiffin Motorhomes has provided for fire safety.

## FIRE EXTINGUISHER

Figure 2-6: Fire Extinguisher

The Wayfarer is equipped with a fire extinguisher located in the entrance door stairwell (Figure 2-6) The extinguisher is rated for both Class B and C (i.e., grease, gasoline, diesel fuel, flammable liquids and electrical). Read and understand the accompanying owner's manual on that extinguisher (found in your Owner's Information Package) and remember the location of the extinguisher. These types of fire extinguishers are pressurized, mechanical devices and require that appropriate care be used in their safe storage and use. The owner's manual will provide necessary guidance for the proper storage, handling, and use of the extinguishers. Prudent preventive maintenance suggests monthly inspection of any fire extinguisher to assure that it is sufficiently pressurized (i.e., the needle on the gauge is in the "normal" zone) and that the mechanical components are not blocked in any way. Do not test a fire extinguisher by partially discharging the unit—this will cause a loss of pressure and may lodge some fire retardant materials in the valve mechanism and cause the extinguisher to continue to vent slowly down to zero pressure. If an extinguisher is ever partially used; continue its use until the unit is completely discharged, then have the fire extinguisher fully recharged at an appropriate service center (one can call any fire department for information on having an extinguisher recharged in that particular locality). **DO NOT** wait a long time to recharge an empty fire extinguisher; you'll never know when it may be needed. Should a fire occur inside or around the motorhome, evacuate the motorhome quickly and calmly—do not panic. In the event of heavy smoke or extensive flames, keep low (crawl if you must) and make your way to the nearest exit (door, emergency window) and leave. If the fire involves a fuel source (e.g., diesel fuel, LP gas); consider the probability of an explosion and move sufficiently far away to minimize personal harm. If such is available, immediately place a call to the local fire department (or ask someone nearby to do so) to report the fire. Consider the cause and the consequences of the fire and the risks associated with possibly fighting the fire yourself before trying to extinguish it. **DO NOT** expose yourself or others to unnecessary danger.



## SMOKE DETECTOR

INSERT PIC OF SMOKE DET.

The Wayfarer motorhome is equipped with a battery operated smoke detector (Figure 2-7) located on the ceiling in the living area of the motorhome. The smoke detector should be tested on a weekly basis, before each trip, and after any period of storage of the motorhome. If a low battery condition is noted or the alarm “chirps” to indicate a low-battery condition, immediately replace the



Figure 2-7: Smoke Detector

The Wayfarer motorhome is equipped with a battery-operated smoke detector (Figure 2-7) located on the ceiling in the living area of the motorhome. The smoke detector should be tested on a weekly basis, before each trip, and after any period of storage of the motorhome. If a low battery condition is noted or the alarm “chirps” to indicate a low-battery condition, immediately replace the battery. It is suggested that you keep replacement batteries in the motorhome for any in-transit replacements so that the smoke-alarm capability is never compromised. DO NOT disable the smoke detector for any transient, false alarm (e.g., cooking smoke, dusty furnace, tobacco smoke). Ventilate the motorhome with fresh air and the alarm will reset.

## ELECTRICAL

- Careless handling of electrical components can be fatal. Never touch or use electrical components or appliances while feet are bare, while hands are wet or while standing in water.
- Improper grounding of the vehicle can cause personal injury.
- Do not attach an extension cord to the utility power cord.
- Do not use any electrical device that has had the ground pin removed.
- Avoid overloading electrical circuits. Replace fuses or circuit breakers with those of the same size and amperage rating only. NEVER use a higher rated fuse or breaker.

## LOADING

- Store or secure all loose items inside the motorhome before traveling. Possible overlooked items such as canned goods or small appliances on the countertop, cooking SAFELY pans on the range, or free-standing furniture can become dangerous projectiles during a sudden stop.
- Be aware of GVWR, GAWR, and individual load limit on each tire or set of duals.
- Never load the motorhome in excess of the gross vehicle weight rating or the gross axle weight rating for either axle.

## MAINTENANCE

- Do not remove the radiator cap while engine and radiator are still hot. Always check coolant level visually at the see-through coolant reservoir.
- NEVER get beneath a vehicle that is held up by a jack only.
- Do not mix different construction types of tires on the vehicle. Replace tires with exact size, type, and load range.

## EMERGENCY EXITS

In the living areas of the motorhome, there are emergency exit windows (Figure 2-8 and 2-9) These windows are designed for emergency exits when it is not practical to exit by the door, which also is an emergency exit - in the front of the motorhome. These windows are readily noticeable by their red handles and the red "EXIT" label on the windows.



Figure 2-9: Emergency Exit Latch

Figure 2-8: Emergency Exit Window



To use these windows as emergency exits, lift the handle and push outward on the window. As required, the window can be closed by pulling the window inwards and then lowering the handle to latch the window back in place. When parking the motorhome note where these windows will be so the exits won't be blocked.



## PARKING PROCEDURES

To park the motorhome in any unfamiliar terrain, examine the site for surface irregularities, slopes or inclines, and other items such as stumps, rocks, external connections for power/water/sewage and also examine the area immediately above the parking site for obstructions like tree branches and limbs, signs, overhead wiring.

If the motorhome is to be backed into the parking site, try to have that site be on the driver's left-hand side, as this will allow the driver to watch the rear of the motorhome. Back up slowly and use the side mirrors and the back-up camera as a guide or, better yet, have another person outside providing guidance to help park the motorhome.

When the motorhome is finally situated, shift the transmission into park, set the foot-operated park brake, and then turn "off" the engine. Activate the hydraulic leveling system to level and stabilize the motorhome.

If the motorhome is to be powered externally, connect the 120 VAC power to the motorhome. Turn "on" the LP gas valve at the LP tank. Connect the fresh-water supply and sanitize the water systems as needed. Connect the waste drain hose to the external sewer hook-up. Start the refrigerator, water heater, and furnace; as warranted. Light the oven pilot light, as needed.

Certain appliances, such as the refrigerator, will not work properly, if the motorhome is not level, so be sure to complete the motorhome-leveling process before activating any of the appliances.

## TOWING HITCH

The Wayfarer is fully capable of towing typical motor vehicles.

The motorhome is equipped with a Class 2; 5,000-pound towing hitch (Figure 2-10) and associated connector.

The wiring connector features a 7-pin connector. The tongue weight is not to exceed 10 percent of the towing capacity. If it is desired to connect a trailer brake actuator, the plug for the actuator is located to the left of the steering column under the dash.



Figure 2-10: Towing Hitch

The motorhome is capable of towing light loads and instructions are found in the chassis-manufacturer's literature in the Owner's Information Package provided with the Wayfarer.

The total weight of the motorhome and any vehicle towed by that motorhome must not exceed the Gross Combined Weight Rating (GCWR). When the motorhome is being weighed, remember to account for passengers and their locations in the motorhome.

Any vehicles to be towed by the motorhome should have adequate active braking. The wiring connector provided is a standard seven-pin connector.

Tiffin Motorhomes does not recommend using any type of hydraulic towing lift that attaches to the rear of the motorhome designed to carry motorcycles, scooters, golf carts, etc.



*Wayfarer*

---

HEATING & AIR CONDITIONING

CHAPTER

3

## FURNACE

<h1>NOTICE</h1>
<p><b>NEVER attempt to modify the furnace. To do so may cause fire, explosion, carbon monoxide poisoning or asphyxiation. If the furnace is malfunctioning, immediately shut the unit "off" and call a trained service technician as soon as possible.</b></p>



Figure 3-1: Thermostat

The Wayfarer is equipped with a forced-air furnace fueled by LP gas. The furnace is controlled by the wall-mounted thermostats (Figure 3-1) located inside the motorhome. These thermostats control both the heating and air conditioning for the motorhome.

In the gas heating mode, the furnace heats air which, in turn, is circulated through duct work in the floor of the motorhome. If any obstruction(s) block the floor vent(s) or air-return register, then the furnace will not function properly. Any items stored under the cabinets should be carefully stowed to prevent damaging or crushing the furnace ducting or blocking the warm-air return.

When a furnace is being used for the first time, there may be an initial "burn-off" of manufacturing compounds or residues left on the heat exchange or in the duct work which could produce odors, fumes, and possibly some smoke. This is normal and should not cause concern, unless it persists for an excessive amount of time.

To minimize the after-effects of this "burn-off" process, the initial use of the furnace should be done with all the doors and windows open to permit normal air circulation to dissipate these odors and fumes.

For routine operation of the furnace, set the thermostat to the desired temperature setting and then turn the thermostat to gas heat. In about a minute, the furnace should begin to operate and warm or hot air should be coming through the ductwork.

To shut down the furnace, turn the thermostat to the "off" position. Even though the thermostat may be turned "off," the furnace system will continue to run for about a minute or so to permit a gradual cool-down of the heating system which is normal.

On a regular basis, thoroughly clean the complete furnace and air-tube passageways to remove dust, lint, and any other possible obstructions. Leak-test the entire LP gas system at least annually. Also check and clean the air-blower system annually.

Any access hatches to the furnace are for authorized service personnel only, as there are no user serviceable parts on the furnace. Accordingly, do not attempt to tamper with the interior of the furnace.

# NOTICE

**Be cautious when washing the exterior of the motorhome. Water should never be sprayed directly into the furnace vent. Should any water be forced beyond the rain baffles into the furnace vent, the furnace may rust which, in turn, may cause improper combustion and produce unwanted by-products of combustion.**

Before the beginning of each travel season, the furnace should be thoroughly cleaned and inspected. Any obstructions, debris, or lint which may obstruct free air flow or impede the operation of the air circulation system should be removed. For example, accumulated dust or lint could possibly obstruct the orifices for the pilot light or may accumulate on the blower blades and unbalance the operation of the blower. Additionally, any debris in the ductwork, when heated by the furnace, could emit unpleasant odors or possibly become a fire hazard.

The furnace system should be periodically cleaned. Annually is recommended unless the motorhome is subjected to dust levels significantly greater than average, in which case more frequent cleaning is recommended. The Owner's Information Package provides recommended cleaning tips and procedures. When needed, a more thorough cleaning should be performed by a qualified service technician.

## AIR CONDITIONING SYSTEM

The factory-installed air-conditioning system is designed for 120 VAC power supplied either from the external power cord or from the generator. For the best cooling scenarios, park the motorhome in a shady location whenever possible and close drapes on those windows exposed to direct sunlight.

The air-conditioned, cooled air is emitted through "chill grill" vents which are located in the center of the coach. The return air vents have a filter that prevents dust from flowing back through the air conditioning system. The return filters can be easily removed and cleaned with warm water and a mild cleaning solution. To remove the filter, simply pull the vent down and lift the filter from inside the opening.



Figure 3-2: Round Air Vent

# NOTICE

**The air conditioning system is the major consumption device of electrical power in the motorhome.** When this system is being used in an RV park, cumulative use of these air-conditioning systems by the resident vehicles can create a bigger demand for electrical power than is actually available. Accordingly, at times a "brown-out" condition may arise. This is when the AC voltage normally available drops to a lesser value (e.g., 10-20% below normal or more).

"Brown-out" conditions cause appliances to draw greater currents to make up for the reduced voltage, thereby causing circuit breakers to trip or fuses to blow. Under such conditions, your own motorhome is not at fault; simply reset your breakers and/or replace your fuses. Should such conditions continue, you may wish to reduce the electrical load (in this case, turn "off" the air conditioning system for awhile) or start the electrical generator.

## THERMOSTAT CONTROLS

- Press the Up and/or the Down buttons to set the desired temperature for the motorhome.

For more detailed instructions, please consult the thermostat literature in the Owner's Information Package.

## HEAT PUMP CONTROLS

To activate the heat optional pump, set the thermostat to ELEC HEAT and select desired temperature.

NOTE: If the setting on the thermostat and the room temperature are more than five degrees apart, the gas furnace will automatically turn ON with the heat pump. Once the room temperature reaches the desired level specified on the thermostat setting, the furnace will cut off and the heat pump will maintain the heating of the coach.

NOTE: The heat pump is controlled by the thermostat located in the bedroom area of the motorhome.

If the external temperature falls to 35-38 degrees Fahrenheit, the heat pump will become inoperative and the gas furnace will begin to operate automatically.



Figure 3-3: Thermostat

## HOW THE HEAT PUMP THERMOSTAT WORKS.

The RvComfort.HP, the RvComfort.PHP, the Coleman True-air, and the RvComfort.ZC thermostats by RvProducts Inc. are all capable of running not only an Air Conditioning unit, but also an Electric Heat Pump. Frequently we receive calls from customers who do not understand the functions of the Heat Pump Thermostat. This guide is a quick run through of the information already provided in the Thermostat Operation Manual, included with each thermostat.

The Heat Pump is an electric source of heat. IT will supply and maintain heat assuming the outside (ambient) temperature is above 40 degrees. This number of course can be slightly higher or lower depending on the humidity. Higher humidity can cause a heat pump to lose efficiency at higher ambient temperature, while lower humidity can cause a heat pump to lose efficiency at a lower ambient temperature.

Since no one wants to wake up to find that the outside temperature has dropped below 40 degrees and it is now 50 degrees in the coach, the Heat Pump thermostats are programmed internally to recognize when the temperature drops five degrees or more from the set temperature to the actual inside room temperature. When the temperature exceeds five degrees or more between the two, the thermostat will default to the next available heat source.

The thermostat, upon sensing a temperature split of five degrees or more in the electric heat mode will bring the gas heat on to assist the electric heat. This is the first strike. A strike is created by the thermostat having to change modes (or run dual modes to sustain a temperature split). The electric heat and gas heat will continue to run together until the thermostat reaches the set temperature and satisfies. When the electric heat comes back on. It will be in electric heat only at that point. If the temperature again drops five degrees or more from the set point, the thermostat will again bring on the gas heat to assist. This is strike two. The system will then go through the above stated procedures. If the temperature should drop five more degrees from the set point or a third time, the thermostat will give up the electric heat, lock the electric heat out for two hours (showing either DIFF on the display or FLASHING GAS HEAT on the display) and default to GAS heat only. You WILL NOT be able to run any Electric Heat during this two-hour lockout.



*Wayfarer*

---

LP GAS SYSTEM

CHAPTER

4



## LIQUID PROPANE (LP) TANK

Figure 4-1: LP Tank

The Wayfarer is equipped with an ASME (American Society of Mechanical Engineers) approved LP tank (Figure 4-1) which is equipped with an automatic pressure regulator. This tank contains liquid petroleum fuel under high pressure.

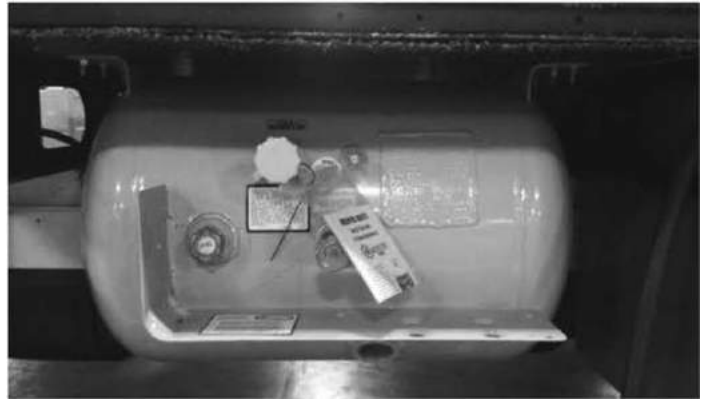

A LP gas-distribution system distributes the gas to those appliances using such in the motorhome. The “heart” of this LP gas distribution system is the regulator and it should

only be adjusted by a qualified service technician. Most of the problems encountered in lighting the pilots of these appliances are caused by regulator miss-adjustments.

The major component of the LP gas supply is a pipe which runs underneath the motorhome floor. The various gas appliances are connected by a rubber supply line.

Should any of the secondary tubing develop a leak, do not attempt to splice any of the lines. Instead, have a qualified service technician run a new length of tubing to the appliance of concern and then have that line leak-tested before placing it in normal operation.

To remove, repair, or replace any gas-operated appliance, always close the main gas valve at the LP tank.

	<h1>WARNING</h1>
<p><b>When the motorhome is not being used, the main LP gas valve must be turned “off.” Also, turn “off” the main valve when the LP gas tank is to be refueled to avoid the possibility of ignition fuel fumes by the pilot lights. All gas valves on the gas-operated appliances with Direct Spark Ignition (DSI) should also be in the “off” position during refueling and/or maintenance operations. DO NOT store LP, diesel fuel, propane, butane, or other flammable liquids inside the vehicle as these represent a very real fire hazard and possible threat to life.</b></p>	

# NOTICE

**If a gas leak is noted or suspected, turn “off” the main valve and keep the LP gas system “off” until that system is inspected by a qualified service technician as soon as possible. Do not delay in addressing any possible gas leaks with appropriate service because of the inherent hazards to safety.**

## LP TANK FILLING PRACTICES

Any LP gas tank associated with the motorhome should never be filled to more than 80 percent of total capacity. Filling should always be done only when the motorhome is leveled. If the motorhome is not level, the tank may be overfilled (i.e., more than 80 percent of capacity) and, thus, subject the motorhome to possible fire or explosion from resultant uncontrolled gas flows.

## LP GAS REGULATOR

As noted earlier, the LP gas regulator (Figure 4-2) is the “heart” of the LP gas distribution system. This regulator reduces and controls the pressure of the gas on the outlet end to provide a constant supply of gas at a constant pressure to the gas-operated appliances. The regulator has a vent to relieve excess pressure on the inlet side of the regulator, should excess pressure develop in the gas tank and connecting gas line to that regulator inlet. The vent would normally release the excess LP gas to the atmosphere until the over-pressurization condition is eliminated.

This vent should be regularly checked to assure that it is not clogged or obstructed. If that vent is blocked from normal operation, component or system failures may result. If periodic visual inspection indicates any sign of corrosion or degradation, contact a qualified service technician to repair the regulator as soon as possible; **DO NOT** operate the LP gas system with any faulty component in place.



Figure 4-2: LP Gas Regulator

## LP Quick Connect

When assembling your LP quick connect line, rotate the shut off lever shown in the picture below.

Next, pull back on the release (Circled). Insert quick connect line. After inserting, rotate shut off lever back in to lock position.

\*When LP quick connect is not in use, to ensure you don't have any leaks have the valve in the position shown in the picture below.



Figure 4-3 LP Quick Assembly



Figure 4-4 LP Quick Connect



Figure 4-5 LP Quick Connect in off position.

## NOTICE

When a LP gas regulator is installed or re-installed, the regulator must always be installed with the gas diaphragm vent facing downwards. For more information, consult the manufacturer's literature in your Owner's Information Package that came with the motorhome.

Always keep the main valve to the LP gas tank closed when the system is not in use. When the LP tank is empty, keep the main valve closed until re-filling is to be performed—this process will keep any moisture-laden air from back-flowing into the gas system and trapping unwanted moisture in the LP gas tank. If an empty LP gas tank has been exposed to the atmosphere for an extended time, let a qualified service technician purge the tank before its next filling operation.



*Wayfarer*

---

MAJOR APPLIANCES

CHAPTER

5

## APPLIANCES & ACCESSORIES

### LP/GAS REFRIGERATOR

Your coach may be equipped with a standard LP/gas refrigerator. When this refrigerator is in the “LP gas” mode, make sure that the main LP gas valve is in the “on” position before attempting to start the refrigerator. Please note that the refrigerator is equipped with a semi-automatic energy selector (AES) control system which can be set automatically to switch between a 120volt AC system or a LP-gas operation system when available.

A 12-volt power supply (e.g., 12 VDC system of the motorhome, auxiliary battery, converter, or motorhome engine battery) is required for proper operation of the electronic control panel. For 120 VAC electrical operation of the refrigerator, either the 30 AMP shore power line must be connected or the on board generator must be running, or the refrigerator is also connected into the inverter system to provide the necessary 120-volt AC power.

**Note: Running the refrigerator on inverter power for prolong periods of time will drain the motorhome batteries.**



Figure 5-1: LP/Gas Refrigerator

To operate the refrigerator in the LP-gas mode, the main LP gas valve must be “open.”

For specific instructions on refrigerator please refer to the operating booklet found in the Owner’s Information Package.

# NOTICE

The majority of LP gas appliances used in motorhomes normally vent to the outside of the motorhome. When your motorhome may be parked in close proximity to a fuel pump (i.e., during re-fueling operations), it is possible that the diesel fumes could enter this type of appliance and possibly be ignited by the burner flame thereby causing a fire or explosion. Accordingly, please use extreme caution when re-fueling the motorhome.

## MICROWAVE OVEN

The Wayfarer contains a convection microwave. All microwave ranges operate on 120-volt AC electrical power, supplied either by the external electrical hookup or by the onboard electrical generator in the motorhome.

Touch pad controls are used for operating the convection microwave (i.e. cooking temperature, mode, power level, and cooking time). For basic operating instructions, care, and maintenance for the proper use of the microwave, please consult the specific manual in the Owner's Information Package.



Figure 5-2: Microwave

## COOK TOP

The Wayfarer is equipped with a standard recessed two burner range (Figure 5-4).

Do not attempt to adjust the oven pilot light as it has been factory-adjusted and factory-set. To extinguish the oven pilot light when use of the oven is concluded, push inwards on the oven control knob and turn that knob clockwise (CW) to the “off” position.

To operate either the two-burner range or the optional two-burner, recessed cook top, light the burners by turning “on” the gas control knob, wait a couple of seconds, then push the red DSI (direct spark ignition) button until a flame appears.

If the burner does not start after a few attempts, discontinue the process, let the released gas dissipate, then try the process again. The burner knobs operate in a CCW manner and must be gently pushed inwards as they are being turned. Never use the cook top when the motorhome is in motion.

It is wise to have a qualified service technician periodically check the entire LP-gas distribution system in the motorhome. Scheduling such an inspection annually would be a recommended, preventive maintenance routine for each motorhome owner.

Figure 5-4: Cook

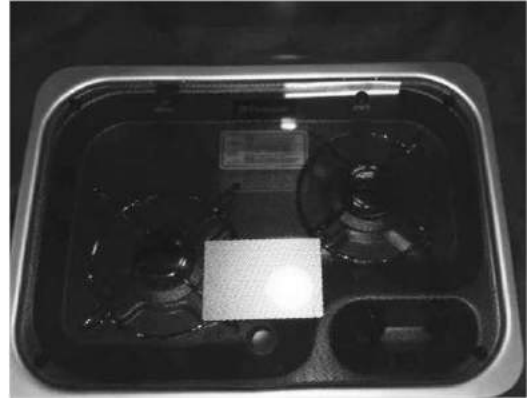

	<b>WARNING</b>
<p>DO NOT USE cooking appliances as a heating source for the motorhome. Cooking appliances require fresh air for safe operation. Before using any cooking appliance, make sure that an overhead vent or window is open and/or turn “on” an exhaust fan.</p>	

	<b>DANGER</b>
<p>All LP gas-operated appliances in the motorhome will consume oxygen. If the motorhome is totally closed during such operation, the oxygen level may be reduced and the associated carbon monoxide level may be increased thereby causing possible harm or death to the occupants through asphyxiation. Always use these appliances with proper ventilation.</p>	

<b>WARNING</b>	
<p>Portable fuel burning equipment, including wood and charcoal grills and stoves, should NEVER be used inside the motorhome. The use of this equipment inside the coach can cause fire or asphyxiation and could result in serious injury or death.</p>	



**DANGER**

**IF YOU SMELL GAS, YOU SHOULD IMMEDIATELY:**

**Extinguish any open flames, pilot lights, and all smoking materials. Do not touch or operate any electrical appliances or switches. Immediately shut off the gas supply at the main tank valve or supply connection. Open doors, windows, and other ventilation openings. Exit the RV to allow entrapped LP gas to dissipate. Have the LP gas system checked to locate and fix the source(s) of the leakage.**

**WARNING** 

**DO NOT APPLY 110 VAC POWER to or LIGHT the water heater until after the water heater is filled with water and the water lines and heater tank are purged of any trapped air. Failure to do so will damage the water heater and may cause additional damage to the motorhome.**

Before the water heater is to be used, fill the fresh water system and purge the water lines to and from the water heater by opening all the hot-water faucets until water steadily flows from each one and no “spurting” or “hissing” sounds are heard.

The water heater uses either the LP gas system or the 120-volt AC electrical system to operate the heater. Proper and safe operation of the water heater requires that all safety information provided in the owner’s manual be read and understood before placing the water heater in service. Take the time to become familiar with this manual (provided in the Owner’s Information Package).

The water heater is designed for operation either with LP gas or 120-volt AC electricity.

NOTE: When you turn “on” the switch for the water heater the middle red button will light up. It will go off after several seconds—this means the water heater is lit. However, if the light stays illuminated, then that means the water heater has not ignited.



Figure 5-5: Water Heater Switch

### LP Gas – Electronic Ignition Operation

1. If the water heater fails to operate because of high water temperature, the heater will go into a lockout condition (indicator light “on”). When the water eventually cools, reset the system by turning the switch to the “off” position for at least 30 seconds, then turn the switch back “on.”
2. If a lockout condition persists, contact your authorized dealer.



### 120- VOLT AC ELECTRICAL OPERATION

1. For electrical operation, use the Water Heater switch found on the master control panel in the galley of the coach.
2. Completely fill the water heater with water and purge the hot-water lines of any trapped air.
3. Turn the Water Heater switch “on.” NOTE: Turning the power “on” to the water heater without having previously covered the water-heating element with water may burn out the element and void the warranty.
4. After a while, check the water heater for proper operation; the water temperature should be approximately 140°F (60°C).
5. If the manual-reset, high temperature-limit switch should trip the circuit breaker; reset the switch by depressing the reset button – use a pencil or other non-metallic object to depress the reset button. If the high-temperature limit switch should again trip the circuit breaker, contact an authorized service technician or an authorized dealer.
6. Both the electrical and gas operations of the water heater may be used simultaneously to reduce recovery time of heating water up to desired temperature.

For general maintenance of the water heater or specific information about select steps in operating the water heater, please refer to the owner’s manual for this appliance contained in the Owner’s Information Package.



## WATER HEATER STORAGE

Figure 5-6: Water Heater if the motorhome is to be stored during the winter months, the water heater should be drained to prevent damage caused by freezing water contained in the water heater.

To drain the water heater, first turn “off” all electrical power, turn “off” the LP gas going to the water heater, then turn “off” the water pump. Open both the hot- and the cold-water faucets to drain the water lines and open the drain on the water heater to drain the entire system.

When re-activating the water heater after the motorhome is taken out of storage, make sure that the entire water system, including the water heater, has been filled with water and the lines have been purged of any entrapped air before relighting the water heater. Failure to do so may allow the water heating element to be turned “on” before it is immersed in water; thereby, causing the premature failure of the heating element and voiding the warranty.

## PRESSURE RELIEF VALVE

The relief valve for over-pressure and over-temperature conditions is located on the exterior of the water heater. This valve will operate if the water temperature reaches or exceeds 210°F or if the water pressure reaches or exceeds 150 psig.

Since the water system in the motorhome is a closed system when all water valves are shut, the water heating cycle can raise the temperature and, consequently, the pressure, of the water in the water heater; thereby realizing pressure increases approaching 150 psig.

Should this pressure (i.e., 150 psig) be reached, the pressure-relief valve will begin “weeping,” that is, minor dripping or leakage from that valve until the pressure drops below 150 psig, at which time the pressure-relief valve will re-seat itself and restrict the water flow. This is normal operation and should not be a cause for alarm. Do not obstruct or block the pressure-relief valve in any way, as this would keep the valve from functioning normally and protecting the hot water system.

**NOTE: WHEN WINTERIZING YOUR COACH, REMOVE THE WATER FILTER.**



# Truma AquaGo® LP Gas Instant Water Heater

Model: Truma AquaGo® basic (DLE60B) \*

Truma AquaGo® comfort (DLE60C) \*

Truma AquaGo® comfort plus (DLE60CP) \*

\* Patent Pending

\*PLEASE REFER TO YOUR TRUMA WATER HEATER OWNER'S MANUAL FOR THE FIGURE PICTURES. \*

## WARNING

-If the information in these instructions is not followed exactly, a fire or explosion may result, causing property damage, personal injury or death.

- Do not store or use gasoline or other flammable vapors and liquids in the vicinity of this or any other appliance.

## WHAT TO DO IF YOU SMELL GAS

- Evacuate all persons from the vehicle.
- Shut off the gas supply at the gas container or source.
- Do not touch any electrical switch or use any phone or radio in the vehicle.
- Do not start the vehicle's engine or electric generator.
- Contact the nearest gas supplier or certified service technician for repairs.
- If you cannot reach a gas supplier or certified service technician, contact the nearest fire department.
- Do not turn on the gas supply until gas leaks have been repaired.

Installation and service must be performed by a certified service technician, service agency, or the gas supplier.

1. Use with LP gas (propane) only. Butane or any mixtures containing more than 10% butane must not be used.
  - LP tanks must be filled by a qualified gas supplier only.
2. The nominal gas system pressure must be 10.5 in. wc.
3. Hot water can be dangerous, especially for infants, children, the elderly, or infirm. It can cause severe burns. Therefore:
  - Never actuate the pressure relief valve (Fig. 1-4) as long as the appliance is still hot.
  - Never actuate the Easy Drain Lever (Fig. 1-11) as long as the appliance is under water pressure and/or still hot.
  - Always check the water temperature before entering a shower or bath.

### 4. How long before hot water causes skin damage?

Temperature °F (°C)	Time before skin becomes scalded
155 (68)	1 second
148 (64)	2 seconds
140 (60)	5 seconds
133 (56)	15 seconds
127 (52)	1 minute
124 (51 )	3 minutes
120 (48)	5 minutes
100 (37)	safe bathing temperature

- The water pressure on the inlet side must be limited to 65 psi (4.5 bar), otherwise internal components of the appliance will be damaged. On (city) water connections with a pressure higher than 65 psi (4.5 bar) a pressure regulator is strongly recommended. **Operating Instructions**

Read and follow the "Consumer Safety Information" before operating the appliance.



#### WARNING

Scalding injuries caused by hot water!

- Water temperatures over 127 °F (52 °C) can cause severe burns or scalding and extreme cases even death.
- Before using the hot water faucet or using the shower, allow the hot water to run until the water temperature no longer increases.
- Test the temperature of the water before placing a child in the bath or shower.
- Do not leave a child or an infirm person in the bath unsupervised.

### How the appliance works

The appliance was developed exclusively for use in recreational vehicles (RVs).

The appliance is connected between the vehicle's fresh water supply and its hot water plumbing system.

It is powered by propane and a 12 V power supply. The ventilation grille on the access door allows combustion air to flow into the appliance and exhaust gas to flow out.

When the appliance is switched on, the water will be heated on demand:

- A volume-flow sensor in the appliance detects when the hot water faucet has been opened and the volume flow is greater than approximately 0.4 gallon/min (1.5 liter/min). The burner then starts automatically.
- The burner control continuously adjusts the heater output based on volume flow and inlet water temperature, so that the temperature at the hot water outlet is approximately 120 °F (49 °C). A temperature stabilizer is also installed in the appliance to minimize fluctuations of the outlet temperature.
- After some time, the maximum temperature at the faucet or in the shower is reached. The length of time will depend on the model (AquaGo basic, AquaGo comfort and AquaGo comfort plus) and variations in the water plumbing (length of pipes, insulation, circulation line, etc.).

Like in a home shower, a comfortable water temperature at the shower head is reached by mixing in cold water.

- When the volume flow is less than approximately 0.4 gallons/min (1.5 liter/min) and the faucet is closed, the burner is automatically switched off.

The AquaGo comfort and AquaGo comfort plus models are equipped with a circulation pump. The circulation pump as well as the burner are switched on automatically by the control unit in order to keep the water temperature above 102 °F (39 °C) in "COMFORT" mode and 41 °F (5 °C) in "ECO" mode.

#### NOTICE

Risk of damage in frost conditions. Refer to "Operations in frost conditions" on page 13 of the Truma owner's manual.

### Starting the appliance

#### WARNING

Danger of over temperature and toxic exhaust gases!

- Use with the LP gas (propane) only. Butane or any mixtures containing more than 10% butane must not be used.
- Keep the air inlet and exhaust gas outlet free of obstructions. Do not lean any objects against the water heater's access door or place foreign objects within 2 feet (61 cm) of the access door.



#### WARNING

Danger of combustion, personal injury and damage to the RV!

- Keep the area around the appliance free from combustible materials, gasoline, and other flammable vapors or liquids.
- Switch the gas supply and the appliance off:
  - If anything seems to be out of the ordinary.
  - If you smell gas.
  - If you move the RV.
  - Before entering the gas station. - Before entering a tunnel.

## Operating procedures



NOTICE Risk of damage in frost conditions

In frost conditions, ambient temperatures below 39 °F (°C), there is a risk that water in pipes, faucets and appliances could freeze. This can cause considerable damage.

- Before you fill water into appliances and parts that transport water, you must heat the installation area sufficiently so that the water cannot freeze.

Proceed as follows to fill the appliance with water:

1. Close open bypass lines (if present). Insert the water inlet filter or heating cartridge – if removed 2, 7, 9, 11.
2. Turn on fresh water supply or switch on the water pump.
3. Fill the plumbing system.
  - Open all the water-release points, e.g., cold and hot water faucets, showers, toilets.

IT IS IMPORTANT THAT YOU BLEED THE WATER SYSTEM BEFORE STARTING THE APPLIANCE.

- Once water flows, the plumbing system is vented. Close the water-release points.
4. Start the appliance as follows:
    - Make sure that the LP gas supply is turned on.
    - Switch on the 12 V power supply (RV).
    - Open the access door (refer to “Opening the access door” on page 8 in the owner’s manual)
    - Switch on the appliance at the POWER switch. Refer to “Switching ON the appliance” on page 11 in the owner’s manual.
  5. AquaGo comfort /AquaGo comfort plus
    - Select the desired operating mode (refer to “Operating modes (control panel)” on page 11 in the owner’s manual.
    - Close the access door (refer to “Opening the access door” on page 8 in the owner’s manual.
    - There may be a variation between the temperature delivered to from the appliance and the temperature at the faucet due to water conditions or the length of pipe from the appliance.
    - The presence of a flow restrictor in the hot waterline may limit the water flow.
  6. How to use hot water:
    - To obtain the desired water temperature at the faucet or in the shower, mix cold and hot water.
    - Particularly when showering, wait until the water temperature has stabilized before entering or allowing other people or animals to enter the shower.

Switching ON the appliance

1. Open the access door
2. To switch on the appliance, switch the POWER switch to one of the two ‘ON’ positions.

Both ON positions on the POWER switch have the same function. Choose your preferred position.

- When the green power ON LED 1 is lit, the appliance is switched on.
- If the red error code LED 2 is lit /flashes, there is a fault warning (refer to” APPENDIX A – error codes” on page 37 in the owner’s manual.

#### AquaGo basic

- The operating mode is set automatically to “BASIC”.
- The appliance is now ready for use.
- Water temperature at the outlet is approximately 120 °F (49 °C)

#### AquaGo comfort/comfort plus

- The appliance is now ready for using the control panel inside your vehicle. Refer to ‘Operating modes (control panel)’ on page 11.

#### Operating modes (control panel)

##### AquaGo comfort/AquaGo comfort plus

A control panel to select the operating mode included with the delivery from serial number DLE60X(X)27100000 with the rotary switch you can choose between the following operating modes:

#### ECO

The appliance is now running in energy saving mode.

- Water temperature at the outlet is approximately 120 °F (49 °C)
- Prevention of freezing by using propane gas. The temperature in the appliance is automatically kept above 41°F (5°C).
- During operation, the yellow status LED 3 is lit.

#### Comfort

The appliance is now running in a mode that provides rapid availability of hot water.

- Water temperature at the outlet is approximately 120 °F (49 °C).
- Stand by heat. The temperature in the appliance is automatically kept above 102°F (39°C)
- During operation, the yellow status LED 3 is lit.



Stand-by. The appliance is not running in any operation mode.

- The yellow status LED 3 is off.
- To switch the POWER and gas supply refer to “Switching OFF” the appliance on page 12 in the owner’s manual.

Switching OFF the appliance AquaGo comfort /AquaGo comfort plus

1. Set the contro Panel to “Off”.
2. Open the access door.
3. Switch off the appliance at the POWER switch -the green ON LED extinguishes.
4. Close the access door.
5. If the appliance is not needed, turn off the gas supply to the appliance.

 If you intend to put the RV into storage or turn off the appliance during freezing temperatures, refer to “Winterizing” on page 14 in the owner’s manual.

Operating in frost conditions

Ambient temperatures below 39°F (4°C)

#### NOTICE

Risk of damage in the frost conditions.

In frost conditions, ambient temperatures below 39°F (4°C), there is a risk that water in pipes, faucets and appliances could freeze. This can cause considerable damage.

- If the appliance is not to be used in frost conditions, you must winterize the appliance. Refer to “Winterizing” on page 14 in the owner’s manual.
- Winter operation will not protect the RV’s entire water system. Water lines, faucets, water tanks and the external water valves and the vehicle must be heated separately.
- The RV must be designed for winter use/freezing conditions.
- The water pipes in the RV must be ice free to operate the AquaGocomfort/AquaGo comfort plus in winter. Otherwise, there is no water flow and the appliance does not start.

#### NOTICE

Gas must not be used for heating while the vehicle is in motion. Ask your dealer/vehicle manufacturer about options for heating your RV while driving.

Winterizing

NOTICE: Severe damage to the water system components and the appliance

Any damage caused by freezing or an unsuitable winterizing fluid will not be covered by warranty.

- Follow the recommendations if the appliance will be stored under freezing conditions or for an extended period of time.
- Winterize the appliance at the start of the winter season or before traveling to a location where freezing conditions are likely.

If your RV is equipped with a bypass around the appliance, separate the appliance from the water system with the bypass.

#### Winterizing the appliance

- To winterize the appliance, you must drain all water from the appliance. To do this we advise the following steps:
- Remove the water from inlet filter or heating cartridge. See “Draining the water and cleaning the water inlet filter” on page 15 in the owner’s manual steps 1-8.
- Let water completely drain from the appliance. This can take several minutes.
- Do not insert the water inlet filter or the heating cartridge into the appliance during winter – if the appliance is not used.
-  CAUTION Danger of crushing/pinching of fingers when the Easy Drain Lever is closed! Never put fingers between the Easy Drain Lever and latch.
- Close the Easy Drain Lever and the access door.

Once the water has been drained, the appliance is protected against freezing conditions.

#### Winterizing the RV with a winterizing fluid



- Winterizing the RV with a winterizing fluid is only possible with an installed bypass kit (not in scope of delivery)
- Refer to “Connection diagrams on page 31 in the owner’s manual for all letters referred to in the following description.

#### Winterizing AquaGo basic /AquaGo comfort

1. Close valves A and B.
2. Open valve C
3. Drain the appliance
4. Flush the RV’s water system with a suitable winterizing fluid according to the supplier’s or RV manufacturer’s guidelines.

#### Winterizing AquaGo comfort plus

1. Close valves A, B and E.
2. Make sure that valve D remains in the closed position.
3. Open valve C.
4. Drain the appliance

5. Flush the RV's water system with a suitable winterizing fluid according to the supplier's or manufacturer's guidelines.
6. Close all faucets (if open).
7. Open valve D.
8. Wait until winterizing fluid has drained. Collect escaping fluid in a suitable vessel.
9. Close valve D.

#### Rinsing the water system

- You will need about 8 gallons (30 liters) of water to rinse the water system.
- Dispose of (used) decalcification solution in accordance with local laws and regulations.

#### Tasks within the RV

- Open all water-release points, e.g., hot water faucets, showers, toilets.
- Run the water until the status LED 3 on the control panel goes out.
- Set the control panel to "Off".
- Close all water release points.
- Turn OFF the water supply or switch OFF the water pump.
- Open a hot water faucet to relieve pressure in the system.



To make sure that the appliance and the water pipes contain no decalcification agent, empty the water system again and refill it.

#### Tasks outside the RV

- Switch the appliance OFF at the POWER switch (red error code LED 2) flashes before it switches off.
- Drain the water system (refer to "Draining the water and cleaning the water inlet filter" on page 15 steps 1-8 in the owner's manual).
- Install the water inlet filter. (referring to step 9). Or antifreeze cartridge if electric antifreeze kit is installed.
- Switch ON the appliance at the POWER switch.
- Insert and close the access door (refer to "Closing the access door" on page 9).



You have to switch the appliance off and on to unblock decalcification and enable further operation.

#### Filling the water system

##### Tasks within the RV

- Turn on fresh water supply or switch on water pump.
- Fill the water system.
  - Open all water-release points, e.g. hot water faucets, showers, toilets.
  - Once water flows evenly, the water system is vented.
  - Close the water-release points.
- Before you use the water system and the appliance, check the color of the water at all faucets. -Slightly red> rinse again.
  - Clear -> decalcification is finished.
- Remove the warning signs" Caution decalcification in progress".

# TRUMA COMFORT PLUS

Figure 1:

Represents regular running mode. Red arrows represent the position of the valve handles. Blue arrows represent the water flow.

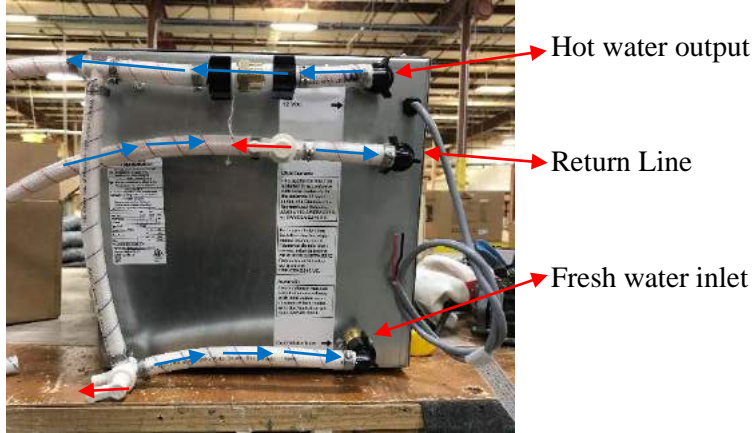
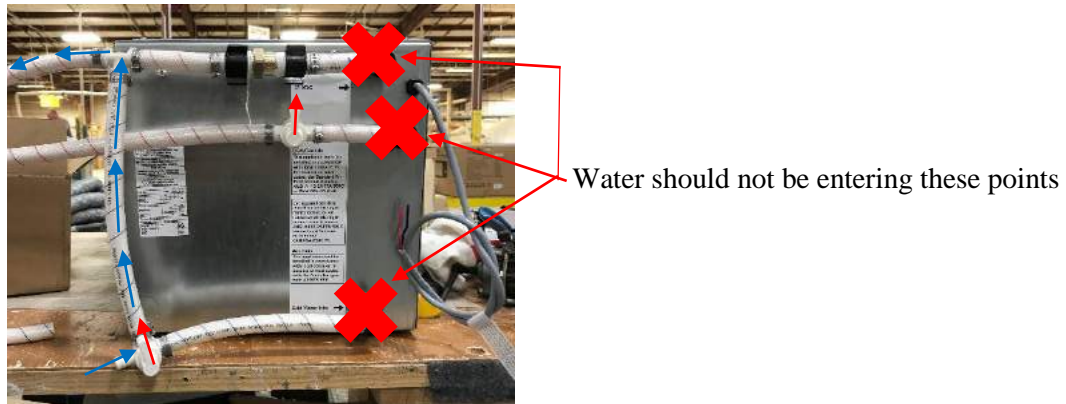

Figure 2:

Represents winterizing mode. Red arrows represent the position of the valve handles. Blue arrows represent the water flow.





*Wayfarer*

---

ENTERTAINMENT

CHAPTER

6

## TELEVISION SETS

**Note:** Running the television(s) on inverter power for prolonged periods of time will drain the motorhome batteries.

Televisions will need to be reprogrammed each time the motorhome is moved in order to pick up all over the air antenna channels available.

Standard Cable/satellite tripod hookups (Figure 6-3: Tripod Hookup) is located on the driver's side rear cargo compartment on the water systems control board, allows a mobile satellite to be added instead of the standard dome. Prewire for a roof satellite is provided and located on the roof of the motorhome. Consult an authorized Tiffin Motorhomes Dealership or Tiffin Motorhomes, incorporated in Winfield, AL, to provide roof satellite wiring diagram for rough in location prior to cutting or drilling roof.

The televisions are powered by 120-volt AC electricity; therefore, the motorhome must either be plugged into with the 30 AMP shore power cord, or generator. The entertainment system is also connected into the inverter would permit the 12-volt DC power to be converted into 120-volt AC for the television(s).



Figure: 6-3 Tripod Hookup

Detailed operation of the television(s) is provided in the accompanying owner's manuals found in the Owner's Information Package included with the motorhome.

## DVD PLAYER

The DVD Player is built into the Jensen House Radio. Detailed operation for the Jensen House radio is provided in the accompanying owner's manuals found in the Owner's Information Package included with the motorhome.





*Wayfarer*

---

CABINETS & FURNITURE

CHAPTER

7

## CABINETS

Your Wayfarer contains cabinetry installed throughout the entire motorhome from the driver's area, through the kitchen/dining areas, and back into the bedroom.

The cabinetry has been designed and built to provide ample storage space, to be easily accessible, and to be conveniently located to support the areas of concern.

Construction of these cabinets incorporates various hardwoods, raised panels, cabinet doors, and supports. Door pulls, handles, and knobs are installed in a style complementing the particular décor of each Wayfarer so that an aesthetically-pleasing, as well as fully functional, storage capacity is realized.

For the many floor plans available in the Wayfarer product line, cabinet design (Figure 7-1) has been optimized to provide maximal storage for each and every floor plan available. Accordingly, the Wayfarer can readily accommodate the routine materials, supplies, and customer-specific items desired for any travel requirements.

These cabinets are designed to contain stored supplies quite securely during travel to minimize or eliminate the possibility of shifting or spilling of cabinet contents during travel. But, when the motorhome is parked, all stored items are readily available in the cabinets for the convenience of the users.

As the storage requirements will vary somewhat from one floor plan to another, general observations can be made about the Tiffin-supplied cabinetry which may or may not be applicable for your specific Wayfarer configuration.

Cabinets are provided in the kitchen/dining area to accommodate the routine cooking utensils and groceries normally desired for travel. Storage space within these cabinets has been designed to accommodate the typical sizes and configurations of food supplies (e.g., cereal boxes, condiments, canned goods, bottled liquids) normally taken on travel trips.

Based on Tiffin Motorhomes' extensive experience with travel requirements of the seasoned motorhome users and from Tiffin Motorhomes' own research and development in cabinet-design requirements, the cabinets offer the greatest storage capacity possible. In the bathroom and bedroom, additional cabinets are available for storage of sundries and toiletries specific to these areas.

In the kitchen, a color-coordinated countertop is provided on top of the floor-mounted cabinets. To maintain the appearance of the countertop, clean with a damp cloth. If spotting occurs, clean the countertop with a damp cloth and a mild liquid soap. Should some dried-on residue still be present wet a damp cloth moistened with the liquid cleaner stand directly on top of that residue for 15-30 minutes to loosen the residue, then clean that spot accordingly.

Please note that strong chemicals, solvents, and cleaners (e.g., oven cleaner) may damage the surface; so do not use any products not specifically designed for countertop cleaning.

**Figure 7-1: Living Room**





The countertop (Figure 7-2) may be physically damaged, too, if proper care is not taken. Do not cut anything (e.g., vegetables, fruits) directly on the countertop; rather, use a cutting board on top of the countertop to provide necessary protection. Excessive heat may also damage the countertop; therefore, any pots or pans taken directly from the range or oven should not be placed directly on the countertop; rather, use trivets or some other form of fireproof heat insulators to hold very hot pots or pans on the countertop.

All drawers are equipped with metal slides to provide additional load-bearing strength for the drawers and to permit effortless opening and closing of those drawers, even when they are fully loaded. These metal guides have a slight “locking” action, when closed. To open those drawers, slightly lift up on the drawer handle and then pull the drawer open.



**Figure 7-2: Counter Tops**

To close, push the drawer closed until it “clicks” back into place (i.e., the locking action is engaged).

As this cabinetry is typically of furniture-grade quality, any commercial furniture polish or cleaner can be used. Do not try to soak these wooden surfaces with any water or any other liquid; be sure to wipe up spills or residues of any fluids that contact these surfaces to preclude any staining or discoloration of the cabinet surfaces.

## KITCHEN, LIVING & DINING AREAS

### Sofa Booth

On the Wayfarer floor plan, a built in dinette booth (Figure 7-3) or sofa are available. Both provide additional storage under the seat area, in addition to providing additional sleeping facilities.

### Dinette Instructions

1. Remove seat back and side cushions.
2. Slide seat bottoms back.
3. Pull the lever underneath the table to release the table down.
4. Reinstall the seat back cushions and back rests to make up the mattress for the bed.

**Figure 7-3: Dinette Booth**



The living room contains a tri-fold sofa (Figure 7-4) which converts into a bed. The sofa is custom coordinated with the décor of the motorhome. To convert the sofa into a bed, follow these directions:

1. Remove the accent pillows
2. Lift bottom cushions and pull toward you.
3. Support legs are located in the trifold section. Be sure to lower the legs and secure support.

Figure 7-4: Tri-fold Sofa



### SOFA

The driver's seat is manually operated and has swivel features. When the motorhome is parked, the driver's seat can be swiveled to face into the living room. To swivel this chair, first extend the slide-out room. Then move the chair backwards as far as possible to gain clearance from the steering wheel. Now the chair can be swiveled without interference. In a comparable manner, the passenger's seat is also a manually operated seat having essentially the same controls as that of the driver's seat and it is operated accordingly.



Figure 7-5: Swivel Chairs

### BEDROOM AREA

If a décor-coordinated, quilted bedspread with accessorized pillow shams and accent pillow(s) (Figure 7-6) are included with the bedroom suit, it is recommended that the bedspread be only dry-cleaned to preserve the quality of the bedspread for the longest time possible.

Treatment of the bedspread with any of the stain-resistant sprays (e.g., Scotch Gard, etc.) will also make the bedspread more resistant to the possibilities of stains and fabric damage and, thus, provide many years of dependable service.

Figure 7-6: Bedroom Decor

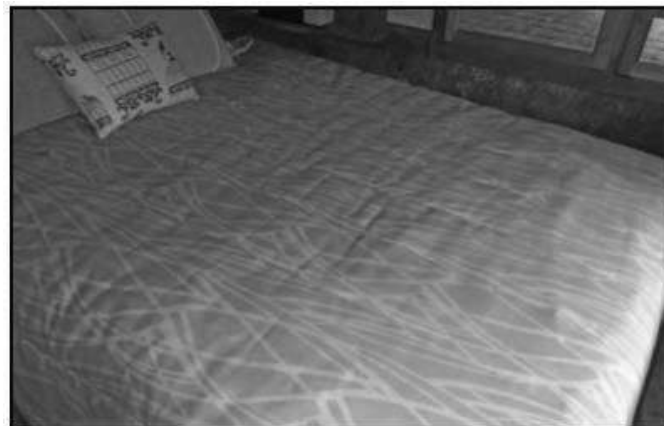



*Wayfarer*

---

STRUCTURAL FEATURES

CHAPTER

8

## CHASSIS FEATURES

The chassis of your Tiffin Motorhomes Wayfarer was built by and is warranted by Mercedes Motors. The operating instructions for that chassis are included in the Chassis Owner's Manual which is provided with your Wayfarer and is a part of the Owner's Information Package furnished to you by your Tiffin Motorhomes dealership.

Before you begin using your Wayfarer, please read and follow all recommendations for the proper care, operation, and maintenance of the chassis—this will assure you of pleasant, trouble-free use of your vehicle. Should you have any questions about the chassis, however, you should contact your chassis manufacturer as noted in the literature described earlier.



*Wayfarer*

---

ELECTRICAL FEATURES

CHAPTER

9

## ELECTRICAL FEATURES

### GENERAL INFORMATION

There are two electrical systems in your Wayfarer motorhome. These are the 12-volt DC (VDC) system and the 120-volt AC (VAC) system. Most standard appliances require the 120-VAC system, while the majority of the lighting systems used in the Wayfarer use the 12-VDC electrical system.

The electrical power for the 12 VDC system is supplied by the batteries of the Wayfarer. Those batteries are charged by a power converter. The alternator also charges the batteries when the engine is running.

The electrical power for the 120 VAC is supplied by the 30 AMP shore power cord when the Wayfarer is connected to an external power source or when the on-board electrical generator is in operation. The inverter can also supply 120 VAC electrical power (to limited outlets and limited appliances) the items onboard the Wayfarer are powered by the inverter are limited to Televisions and Refrigerator —the inverter transforms the 12 VDC electrical power from the batteries into the 120 VAC electrical power needed for the basic appliances.

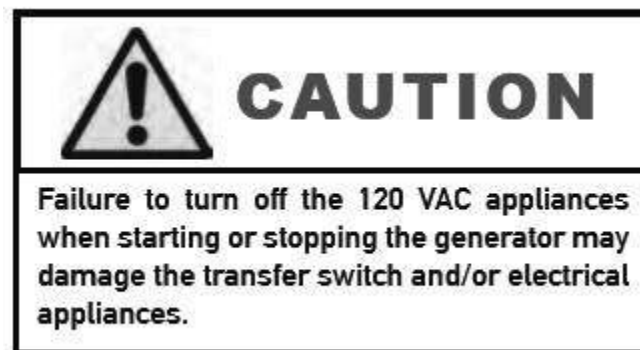

To connect the Wayfarer to an external source of 120 VAC electrical power, it is first recommended that main 30-amp circuit breaker is in the “off” position. This is done to prevent any power surge upon connecting the motorhome to the external power source. Then unwind the power cord from the electrical compartment located in an external compartment. The standard, flexible, power cord supplied with the Wayfarer is designed to handle 30 amperes. Make sure that the pins in the male end of the plug are oriented correctly so they match the power cable, and they are in good condition (i.e., aren’t bent or damaged).

**Note:** Do not attempt to use any electrical adapters to convert the provided 30amp power cord, as this will damage electrical components inside the motorhome.

If there is a circuit breaker switch at the “plug” end of the power cord, that breaker should be turned “off” before making the connection. Insert the plug into the mating outlet and then turn the circuit breaker “on.” Close and lock the electrical compartment door to protect the contents and to keep them clean and dry. Close the cover on the power box, if so equipped, to avoid an unintentional disconnection and to keep the contents clean and dry. Then switch the main breaker to the “on” position.

## ELECTRICAL FEATURES

When properly connected, the 120 VAC system provides power to all the 120 VAC circuits and outlets when the main breaker is turned “on.”

	<b>ELECTRICAL CAUTIONS</b>
<ul style="list-style-type: none"><li>• Careless handling of electrical components can be fatal. Do not touch or use electrical components or appliances while feet are bare, while hands are wet, or while standing in water or on wet ground.</li><li>• Do not touch an extension cord to the utility power cord.</li><li>• Avoid overloading circuits and replace fuses or circuit breakers with those of the same size and amps only. DO NOT use a higher rated fuse or breaker.</li><li>• Do not plug the utility power cord into an outlet that is not grounded.</li><li>• Do not adapt a plug to connect to a receptacle that it is not designed for.</li><li>• Be sure that all electrical appliances used inside the motorhome contain three-prong plugs for proper grounding.</li><li>• Use caution when handling or working near electrical storage batteries.</li><li>• Always remove jewelry and wear protective clothing and eyewear when working on an electrical matter.</li></ul>	

## CIRCUIT BREAKER BOXES

For the Wayfarer, the 120 VAC and 12 VDC breaker boxes are located in the bedroom.

The circuit breakers and fuses are installed to protect the electrical system of the Wayfarer from any overloads. Do not attempt to change the electrical circuitry or to add appliances yourself.

Please consult an authorized Tiffin Motorhomes Dealership or Tiffin Motorhomes, incorporated in Winfield AL to determine whether any changes you desire are appropriate and acceptable.

Tiffin Motorhomes' qualified staff of electricians can readily determine whether any changes sought (e.g solar, radio, amateur radio, satellite television receiver, personal computer system, and the like) are possible or not and can advise you on how best to realize these enhancements.

Please note that the 12 VDC fuses and breakers are located in a separate compartment adjoining the 120 VAC breakers. Fusing is provided for the following 12 VDC CIRCUITS: Refrigerator power, Radio power, HD Antenna / Satellite Booster Power, and Thermostat Power. When the ignition is on, the chassis batteries and house batteries will automatically merge to charge batteries when vehicle is in operation. NO SWITCH.

Figure 9-1: Circuit Breaker Box

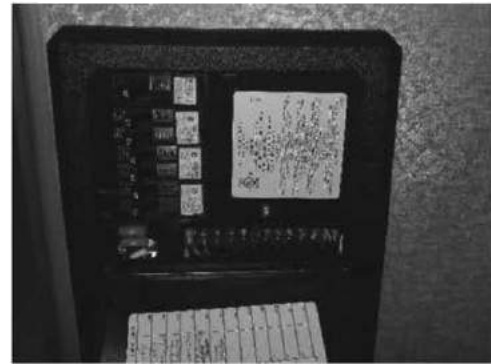

## BATTERY DISTRIBUTION CENTER

The motorhome is equipped with a 12 VDC battery distribution center, located in the coach's battery compartment. The center has a 200amp main coach disconnect / breaker which will turn off all 12volt battery power to the motorhome. There is also (2) fuses of 250amp, and 60amp which distributes the 12 VDC power to system components within the motorhome.



When the 200 amp 12 VDC main circuit breaker is shut down or electrically tripped, it must be manually reset. This breaker protects the slide-outs, the AC ignition, the electric step, the 30-amp ignition system, and the 12 VDC disconnect system. As needed, manually reset the circuit breaker or breakers.

Be careful when working around these connections as an accidental electrical short to ground (i.e., momentarily connecting the "positive" or "hot" terminal to any part of the chassis) can be hazardous and harmful.

To access the battery distribution center, open the access panel on the steps. When access to the batteries are no longer needed, close and securely fasten the access cover to place these steps back in service.



## BATTERY INSPECTION AND CARE

The motorhome batteries which constitute the 12 VDC system are contained inside the motorhome entrance step well.

To access these batteries, open the access panel on the steps. When access to the batteries is no longer needed, close and securely fasten the access cover to place these steps back in service.



Figure 9-2: House Batteries

When batteries are not used for extended periods of time, they will gradually lose their electrical charge. Therefore, it is necessary periodically to recharge the batteries to increase the operational lives of the batteries. It is also necessary to check the external condition of the batteries on a regular basis.

Look for cracks in the battery case and cover. Check the vent plugs and replace them if they are cracked or broken. Keep the battery clean. Since accumulations of dirt and acid residue around the battery terminals may provide an electrical path for discharging the battery, the area around the terminals should be cleaned periodically. One can use an old toothbrush and a sparse amount of a diluted solution of baking soda (sodium bicarbonate) and water (distilled or de-ionized, preferred; tap water, acceptable) to clean and neutralize any acidic build-up around the battery terminals. If there is any foaming on the top of the battery, this indicates that acidic residues are being neutralized. Rinse the cleaned areas thoroughly with distilled or de-ionized water (tap water is okay, too).

Avoid getting the baking-soda solution into the battery fill plugs to each battery cell; this would drastically reduce the effectiveness of the battery (by neutralizing the sulfuric acid in the battery cells) or, worse, “kill” the battery. Dry the battery cables and terminals to prevent corrosion; to protect those terminals further, use a plastic ignition spray on the terminals. Do not use grease on the terminals, especially on the metal-to-metal connections, as grease may act as an insulator and keep the battery electrical power from entering the cables.

If the batteries are not going to be used for an extended period of time, they should be removed from the Wayfarer and stored in a warm, dry place. **IT IS STRONGLY RECOMMENDED** that this service be performed by a qualified service technician, as the process is usually too complicated for the average owner to perform. For those who may wish to perform this service themselves, the following procedure is described: Mark the battery cables (“+” sign or “red” for the positive cable; “-” sign or “black” for the negative cable) so that they can be properly reconnected again later. These batteries would require periodic recharging to maintain their full charge.

Following manufacturer's recommendations as found in the Owner's Information Package, periodically check the fluid levels in all the cells of the batteries (be sure to use safety eyewear during this process) and fill those that are low with water (distilled or de-ionized water is preferred; DO NOT use tap water). Don't overfill the cells; follow the filling directions exactly. This battery checkup should be done on a regular basis to realize the fullest service possible from the batteries over the longest time possible. If the Wayfarer is to be stored for an extended period of time, the 12 VDC battery system should be disconnected—this procedure will prevent unnecessary drain and corrosion of the batteries and their terminals.

## NOTICE

If the Wayfarer ever requires any welding operations on the frame first disconnect the chassis batteries. Failure to do so will destroy all of the chassis computer systems.

## NOTICE

Disconnect the 120 VAC electrical power cord and the negative terminal from the coach batteries while working on the Wayfarer electrical system.

## WARNING



**Remove rings, metal watchbands, and any other metal jewelry before working around batteries. If any metallic object (tool, jewelry, etc.) contacts the positive battery terminal or any connection made to that terminal AND also contacts the negative terminal or any of its connections, a SEVERE ELECTRICAL SHORT will occur which could result in an explosion, fire, and/or personal injury. Lead-acid batteries contain diluted sulfuric acid which can be dangerous; avoid direct contact with any battery fluids. Wear eye protection.**

## 120 VOLT (VAC) AC RECEPTACLES

Your Wayfarer motorhome is equipped with several 120 VAC receptacles (Figure 9-5) located throughout the interior of the motorhome.

These 120 VAC receptacles are of the “three-prong” variety; the third prong being a grounding pin which provides adequate grounding to protect one from any electrical shock.

For these receptacles to work properly, do not use an adapter, cheater, or extension cord which defeats the function of the grounding pin. For the same reason, never remove or bend away the ground prong or pin from any three-prong AC plug so that it would fit a two-prong AC receptacle (i.e., an ungrounded AC receptacle).

Never operate the Wayfarer if there is an electrical short present, as an electrical short may deliver an electrical shock to anyone coming in contact with the exterior of the unit.

If you should feel even the slightest of electrical shock, immediately disconnect the unit from the 120 VAC power source and locate the electrical fault (i.e., typically, it is a break in the grounding circuit).

Do not reconnect the 120 VAC power until after that electrical fault is fixed—the grounding circuit must be continuous from the frame to the distribution panel, to the power cord, and to the earth ground so that electrical-shock protection is

realized.

## USB RECEPTACLES

The Wayfarer is equipped with USB ports conveniently located on the front dashboard and in the bedroom area as well as on the passenger console. These ports allow for easy access when charging cell phones, laptop computers, iPods, iPads or other tablets.

## GROUND-FAULT-CIRCUIT-INTERRUPT RECEPTACLES

In the bath areas, there is 120 VAC GFCI receptacles (Figure 9-5) which provide greater protection against inadvertent electrical shocks.



Figure 9-3: 120 VAC Receptacle



Figure 9-4: USB Port

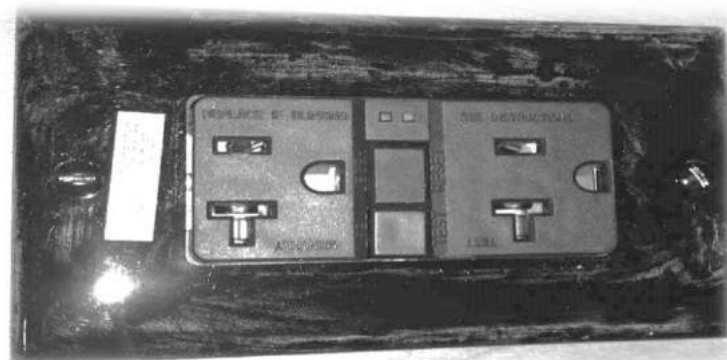

Figure 9-5: GFCI Receptacle

These specialized GFCI receptacles provide both overload and short-circuit protection for the user. All of the electrical receptacles on the “general” branch is GFCI protected through the bathroom GFCI. Consequently, if an appliance plugged into an outlet that is not on the inverter, check for a tripped GFCI in the bathroom.

All GFCI-protected receptacles are marked as such, but only one of them may have two pushbuttons on the receptacle (as shown in the picture). The upper pushbutton is a “test” button which can be used to assure that the GFCI function is working—all one need do to test this function is to push that upper button: There will be a momentary “click” and the circuit will be disconnected (i.e., no power is available at the GFCI-protected receptacles). To reset this GFCI breaker, push the lower button (the “reset”

These receptacles protect the user from ground faults between an electrically “hot” wire and ground. The GFCI will not reduce the shock hazard if the short is between a neutral and “hot” wire, or two “hot load” wires. The GFCI should be tested at least once a month. The 120 VAC electrical system must be “on” for the GFCI to be tested. To test the GFCI the reset button needs to be pushed in fully before starting the test. Push the test button; this will cause the reset button to pop out which means that the protected circuits have been disconnected. Push the reset button back in until a “click” is heard—this will re-activate the protected circuit. If the GFCI is working properly, the reset button will remain in the “in” position.

#### INVERTER (1000 Watts)

1. Invert 12 VDC power into 120 VAC power when 120 VAC is not available. The inverter can create 120 VAC to power the entertainment system (e.g. TVs, Blu-ray player and refrigerator when 120 VAC power is not available.

The inverter will transfer or pass 120 VAC power to its loads when plugged into shoreline or the generator is running.

The inverter switch is located on the central control panel. This switch allows quick inverter ON/OFF control and a quick indication of the inverters power status.

NOTE: Leaving the switch on for extended times can drain the batteries.

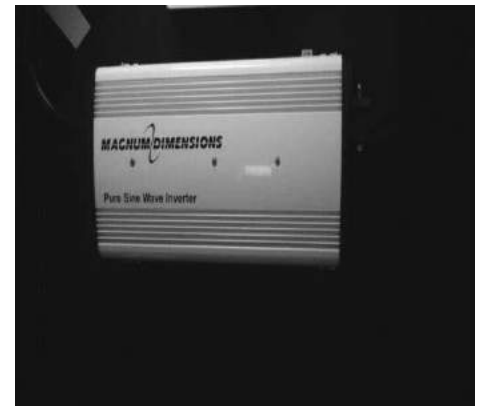

Figure 9-7: Inverter



Figure 9-8: Inverter Switch

## ELECTRICAL GENERATOR

The electrical generator is a 3.2 KW conveniently located in one of the side compartments in the Wayfarer motorhome. Prior to starting or stopping the generator, make sure that all the 120 VAC appliances are turned “off.”

After the generator has been started, wait until the transfer switch has connected before turning “on” any of the appliances.

The generator can be started from either the remote-start switch located on the central control panel or directly at the generator itself. The hour meter installed on the generator records the number of hours of operation of the generator motor—this elapsed time is needed for observing necessary maintenance schedules on the generator.

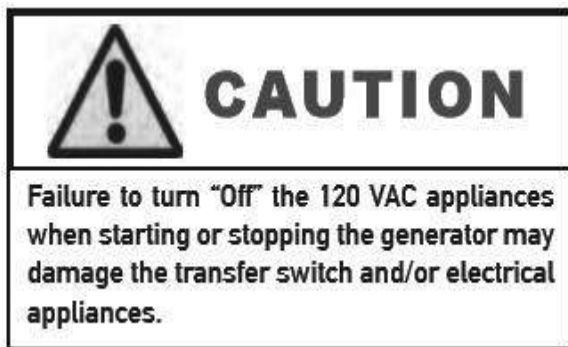

## AUTOMATIC TRANSFER SWITCH

The automatic transfer switches or (ATS) transfers 120V AC power from shore line normal power or generator power to the coach's main electrical distribution panel. The ATS has a delay of around 5 seconds before switching power to shore line, and a delay of around 30 seconds before switching power to the generator. The ATS is located on the driver's side rear cargo bay. This appliance has limited surge protection capabilities.



If the unit is plugged into shore but no power to coach, then make sure the shore outlet has power. If power is present, this may indicate the unit is sensing an open neutral condition. Start the generator, if the power is restored, then either the shore plug or the outlet may be defective (the neutral line may be broken.)

If there is no power to coach from shore or generator, then check the generator circuit breaker. If the circuit breakers are not tripped in the generator or the coach, the transfer box may need to be replaced. For more detailed information on the automatic transfer switch, please refer to the specific owner's instructions found in the owner's information package.



## CAUTION

**Service to this box is to be done by a qualified technician. DO NOT attempt to remove cover unless shore cord is unplugged and generator is off.**

## NOTICE

**Be sure air conditioning units are off before connecting or disconnecting to or from shore power.**

## CIRCUIT BREAKERS

The circuit breakers (Figure 9-9) are located in the main 120 VAC distribution load center located in bedroom.

When the circuit breakers are shut down or electrically tripped, they must be manually reset. As needed, manually reset the circuit breaker or breakers as shown in the accompanying figure.

The panel has a main 30amp breaker which turns off all incoming power to the panels branch breakers. All branch breakers are labeled as to their function. This panel also has 12 VDC fuses, which are labeled as to their function.

Figure 9-9 Main 120 VAC Load Center



## CONVERTER

A converter is provided as a standard feature on the Wayfarer located as part of the main 120volt distribution load center (Figure 9-8) located in the bedroom. This converter takes 120 VAC power and transformers that into 12 VDC power when 120 VAC is available. The converter will create 12 VDC to charge the house batteries when 120VAC power is available from either the shoreline or generator power.

## FUSES

The electrical circuits protected by the under-dash fuse block include: headlights, panel light for dashboard, tail lights, turn signals, cruise control, engine computer, accessory fuses, heater and dash air conditioning. Additionally, there is another chassis fuse panel which works in conjunction with the chassis fuse panel and provides comparable protection for the above-listed circuits.

Located beneath the access panel on the dashboard are two additional fuse panels; these panels protect the following electrical systems: mirrors, optional satellite jacks, camera, optional power windows, dash trim, lighter, map light, optional power seats, and radio.

Should there be any electrical failure of these components or systems, the first troubleshooting procedure should be to check the fuses and have available replacements to replace any blown fuses, as may be warranted.

As an aid to extracting and/or installing fuses in the fuse blocks, one may wish to buy an inexpensive fuse puller at any electronics or hardware store. This tool makes the installation or removal of fuses much easier and prevents inadvertent damage to nearby fuses or the fuse block itself.

## SEVEN-PIN TOWING CONNECTOR

Your Wayfarer is equipped with a standard, 7-pin connector near the towing hitch at the rear of the motorhome to supply the necessary circuitry to control a towed vehicle.

Figure 9-10: Seven-Pin Towing Connector

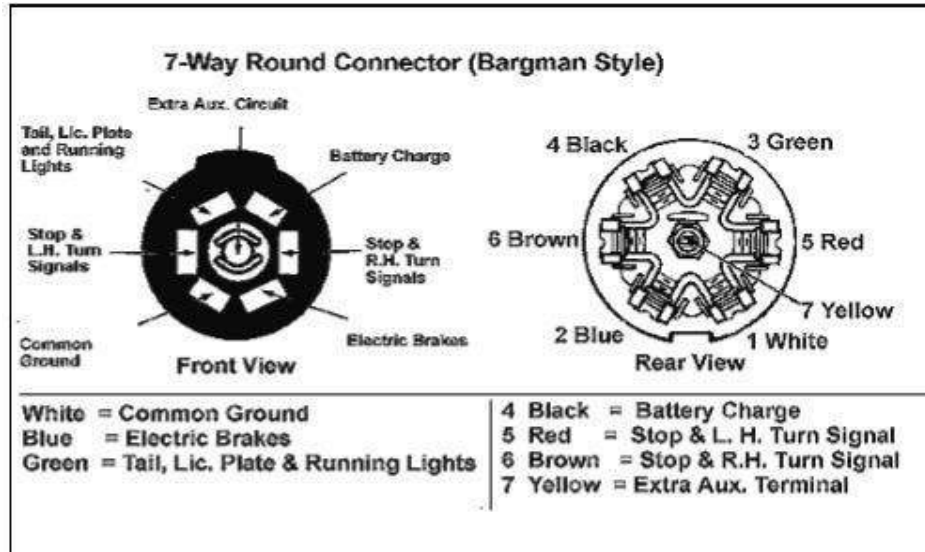

The wiring of that connector is shown in the accompanying diagram (see Figure 9-10).

Make sure that any cable from the vehicle to be towed is wired correctly to mate properly with the connections shown in the connector. If in doubt about proper wiring, have a qualified service technician prepare and install the necessary cable to mate with the 7-pin connector on the motor home to assure proper operation subsequently when any vehicle is actually towed by the motorhome.

When the towed vehicle is uncoupled from the motorhome and the cable is disconnected from the 7-pin connector, be sure to close the spring-hinged cover plate on the connector to protect the contact pins from dirt or debris. In a similar manner, protect the cable end from similar damage, weather, or debris—one such method could be to place the connector end in a heavy-gauge plastic bag (e.g., polypropylene, polyethylene, etc.) and secure the bag tightly around the cable with a stout elastic band or tape and then mount the secured cable in a manner to keep it both from mechanical damage and water intrusion.

When the towed vehicle is again coupled to the motorhome via the towing hitch and the cable is again connected to the 7-pin connector, make sure the resultant connection is tight and solid so that the connection won't jar loose during use. Several supplemental methods to secure that connection have been used; some of which include securing the connection with a strong rubber band or with velcro type fasteners to provide a supplemental mechanical backup to the actual electromechanical connection. Should a conversion adapter to convert the round, seven-pin connector to a flat, four-pin connector be needed; such an adapter may be purchased from any RV after-market store.





*Wayfarer*

---

HYDRAULIC LEVELING SYSTEM

CHAPTER

10

## WARNINGS AND PRECAUTIONS

- Use the system in the intended manner. System forces and pressures can cause severe injury or death if used improperly or modified. Service work should only be performed by trained technicians.
- Do not attempt to operate the system when the vehicle is in motion.
- Visually confirm that all stabilizer legs are retracted prior to travel.
- The equalizer system is designed to deny extension or retraction if the ignition switch is in the (on) position. If equalizer system is extended and the ignition is turned on it will default and retract automatically.
- Make sure there are no obstructions in the path of the extend or retract paths of the stabilizer unit.
- Do not use the stabilizer legs to lift the unit to perform any kind of service work or to change the legs. The system is designed to stabilize the unit not to lift it off the ground.
- Do not go under vehicle while stabilizer legs are extended.
- Do not operate any system functions while anyone is under the coach.
- Do not allow excessive motion in the coach during stabilizer operation. This could cause the system to stabilize improperly.
- Modification of any factory-supplied item may result in denial of all warranty claims.

## PARKING THE COACH

- Care must be taken when selecting a parking spot. Since the system is designed to provide stabilization, rather than leveling, park the coach on suitably level ground. The surface must be firm enough to prevent the stabilizer feet from sinking into the ground.
- Place the transmission in PARK and set the PARKING BRAKE.
- Prior to ANY system operation, visually confirm that the area above and below the stabilizers is clear of objects or obstructions.
- In order for the slide out(s) and/or stabilizers to extend/retract, turn the ignition key to the ON position. Deploy the stabilizers before extending Slide-Outs. Retract Slide-Outs and stabilizers will retract automatically when the ignition key is turned to the ON position.

# Automatic Leveling System Controls

## Control Panel Operation...

- Make sure the key is out of the vehicle ignition.
- Previous version of panel to the right.



1. Turn panel/system on and let system run through its diagnostic mode. Lights will flash clockwise around the green foot. (System will not operate with the ignition key ON)
2. When the lights stop flashing, it's time to choose your function (MANUAL or AUTOMATIC). If choosing MANUAL, press and hold button until light comes on. For AUTOMATIC, simply press once and release.
3. When in the MANUAL mode, each leveler may be operated individually. FRONT operates right front. RIGHT operates right rear. REAR operates left rear. LEFT operates left front. When using this feature, it is important to level the coach by using two levelers at a time or together. For example, right front and right rear, this puts less stress on the frame. To retract individually, press and hold the RETRACT button & the jack button. To retract all, press & hold MANUAL until light goes off, then press RETRACT.
4. When using the AUTOMATIC feature, simply press the AUTO button and then let the system operate itself. It is important at this time that there is NO MOVEMENT IN THE COACH. This process will take 1-3 minutes. To retract the levelers simply turn panel on and press RETRACT.

## Programming / Reprogramming the Automatic Leveling System

1. Turn panel/system on and let system run through its diagnostic mode. Lights will flash clockwise around the green foot.
2. When the lights stop flashing, push the button labeled "FRONT" 5 times.
3. Then press the button labeled "REAR" 5 times. Once you have done this all lights on panel will begin to flash. This means you have reached in the system what is called zero mode. At this time, you can operate each corner or pair of levelers individually.

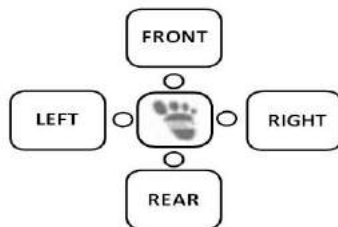

- **FRONT** indicator operates the right front.
- **RIGHT** operates the right rear.
- **REAR** operates the left rear.
- **LEFT** operates the left front.

**Keep in mind the twisting/flexing of the vehicle's frame.**

**Try to operate jacks in pairs when possible.**

Once you have the coach level, you can now store a new program into the system. To do so, press the **RETRACT** button **3 times**. All of the lights except 'AIR DUMP' will stop flashing (*Air Dump will flash 20 times – approximately 20 seconds*). The leveling sensor is now (re)programmed. If you do not want to store the new program, simply turn off panel, to avoid changing the original program.

## Rocker Switch Controls

Included is a harness (#M43800) that routes from the tank assembly to the rocker control switch. The red wire is the 12V power, this goes from the power stud on the tank assembly (on copper strip with 5/16" studs from solenoids) to the center post on the switch. The black wire is ground & is not needed for this switch. The grey wire goes from the retract operation post on the retract solenoid to the post labeled "1" on the switch. The blue wire goes from the extend post on the extend solenoid to the post labeled "3" on the switch. The switch is not waterproof & must be installed inside the coach.

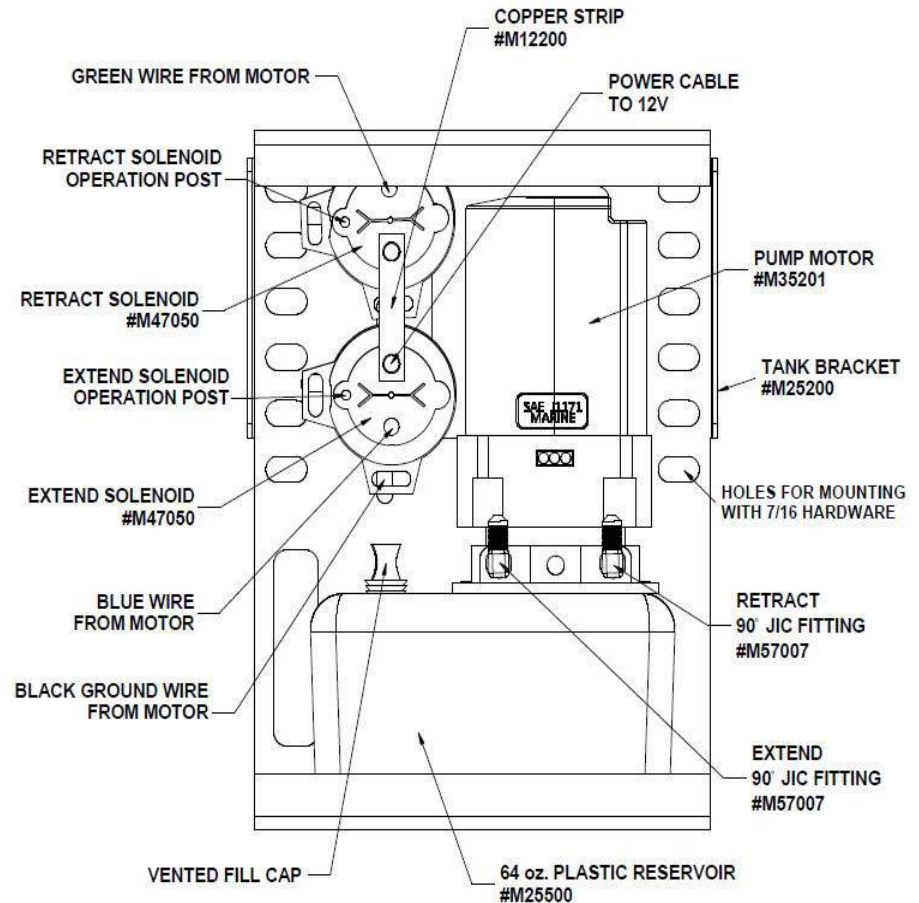

## Typical Plumbing

### For 2pt "Slave" Systems (one pump, two jacks)

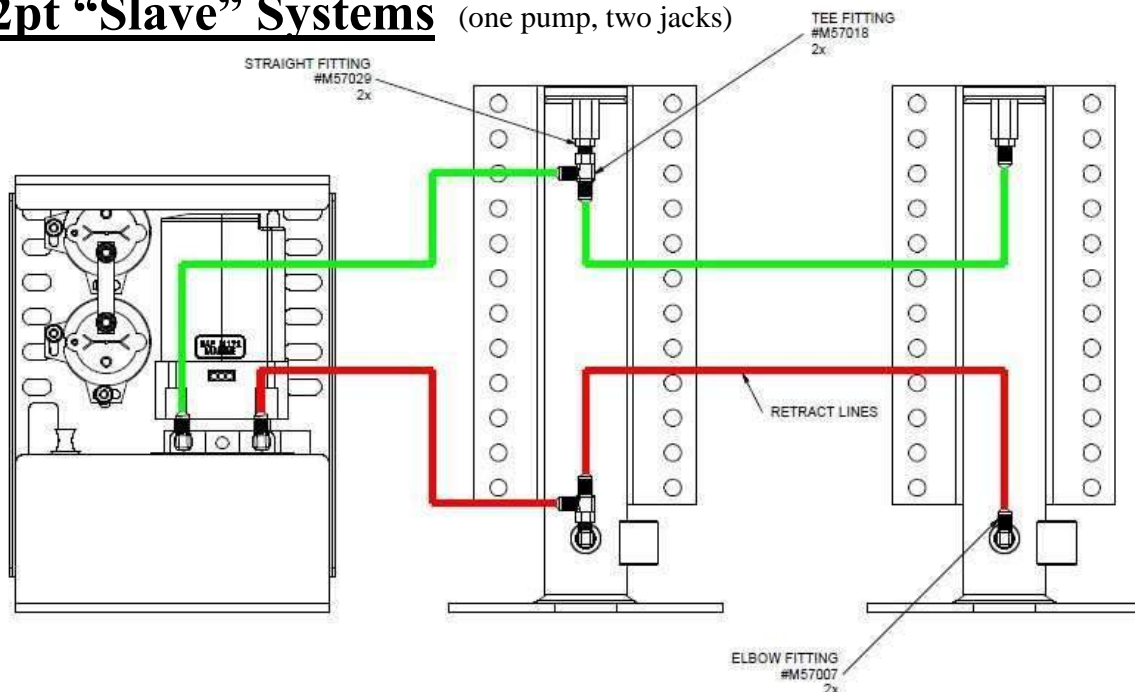

VERSION #1: (SHOWN) THE "TEE" FITTINGS MOUNTED TO THE DRIVE JACK.

VERSION #2: INCLUDES MOUNTING THE "TEE" FITTINGS TO THE PUMP FITTINGS.

VERSION #3: RUNNING TWO LINES FROM THE PUMP AND PLACING THE "TEE" FITTINGS IN-LINE, THEN RUNNING INDIVIDUAL LINES TO EACH JACK FROM THE "TEE" FITTINGS.

# Cylinder Installation & Assembly

## Mounting the Cylinders

Pre-assemble jack prior to hanging on previously mounted weld-on bracket.

- Attach foot pad with  $\frac{3}{4}$ " thin jam nut using a 1  $\frac{1}{16}$ " socket.
- Remove port plugs with  $\frac{3}{16}$ " allen wrench.
- Install supplied JIC elbow fittings to the bottom & top ports with a  $\frac{9}{16}$ " wrench.
- **DO NOT** install the extend hose to the top port on central pump systems yet, this will be done later on in installation (due to the length of hose they must go through a bleeding process).
- Place  $\frac{1}{4}$ " clevis pin in limit switch barrel then insert threaded limit switch with  $\frac{7}{8}$ " wrench. - For jack locations see diagrams on the following pages, but typically the front jacks should be under the cab and the rear jacks should be within 60" behind the rear axle.
- If it is a weld-on application, make sure the weld-on bracket is level and you get good penetration to the frame with full welds the entire length of the bracket. Sometimes it is easier to mount jack prior to welding by lifting assembly with floor jack, be sure to verify levelness and ground clearance.
- Hang jack using at minimum of four  $\frac{7}{16}$ " x 1.75" grade 8 bolts, hex nuts & lock washers. If you have 17k-lb or larger jacks (3  $\frac{3}{8}$ " diameter or larger) you need a minimum of six bolts per jack. Prior to tightening, verify jack is straight & level using carpenter's level. Tighten with  $\frac{5}{8}$ " wrench on bolt,  $\frac{11}{16}$ " socket on nut, tighten to 70 ft.-lbs. (See Fig. 1)

Fig. 1

The jack pictured in this diagram may not match the jack for your vehicle specific or universal kit.

Identifying jacks by diameter:

- 2  $\frac{3}{8}$ " = 8k-lb jack
- 2  $\frac{7}{8}$ " = 12k-lb jack
- 3  $\frac{3}{8}$ " = 17k-lb jack
- 3  $\frac{7}{8}$ " = 24k-lb jack

See bottom of page 9 & 11 for possible vehicle modifications, torque specs & typical jack locations and additional instructions...

If mounting the rear jacks between the vehicle's frame rails also called an "inside mount" a crossbrace is required in the installation for structural stability.

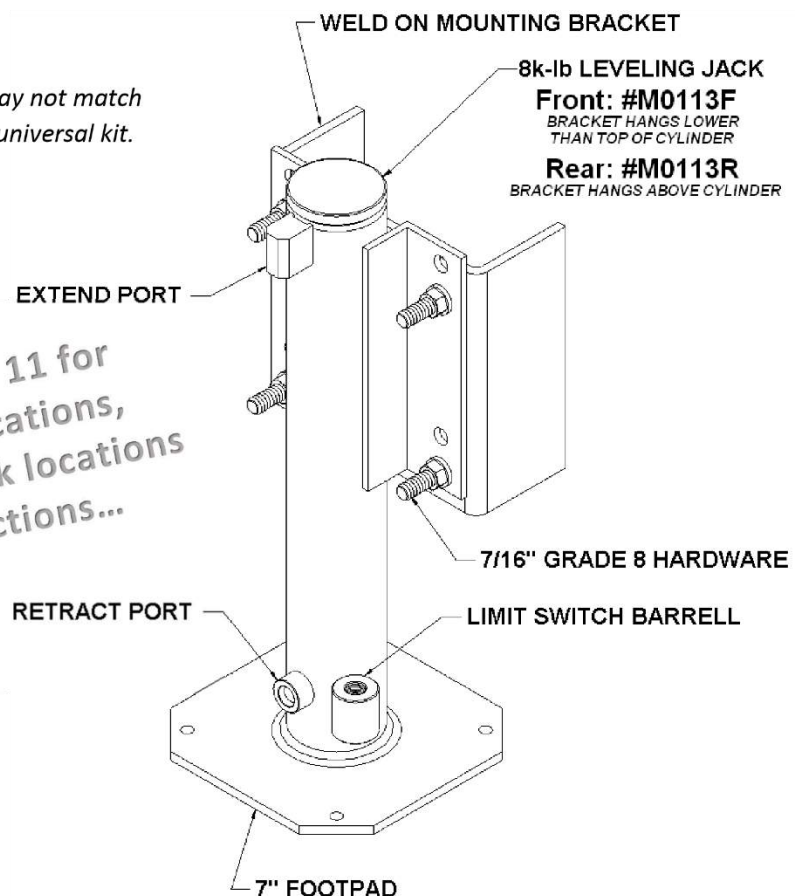

## Vertical Tank Assembly for *Central Pump Systems*

Tank Assembly will be pre-assembled & pre-wired direct from factory.

- Mount the pump using a minimum of two 7/16" bolts, nuts & lock washers.
- Plumbing is shown in Fig. 2 below, use 9/16" wrench and be careful not to under or over-tighten the hydraulic fittings. Sometimes marking the hydraulic lines with tape may make it easier.
- **DO NOT** install the top extend lines to the jacks themselves yet, this will be done later in installation.
- The main wire harness will plug directly into the 14-pin connector that is pre-wired to the assembly.
- Route the **ground harness** (attached to ground shown below) to a grounded surface on the vehicle frame.
- Finally installing the plastic three sided tank cover, this should be done later on in the assembly.
- The tank cover will need to be trimmed to your liking around the hydraulic lines. Fasten the tank cover with at least two self-threading screws, be careful not to puncture the plastic reservoir.

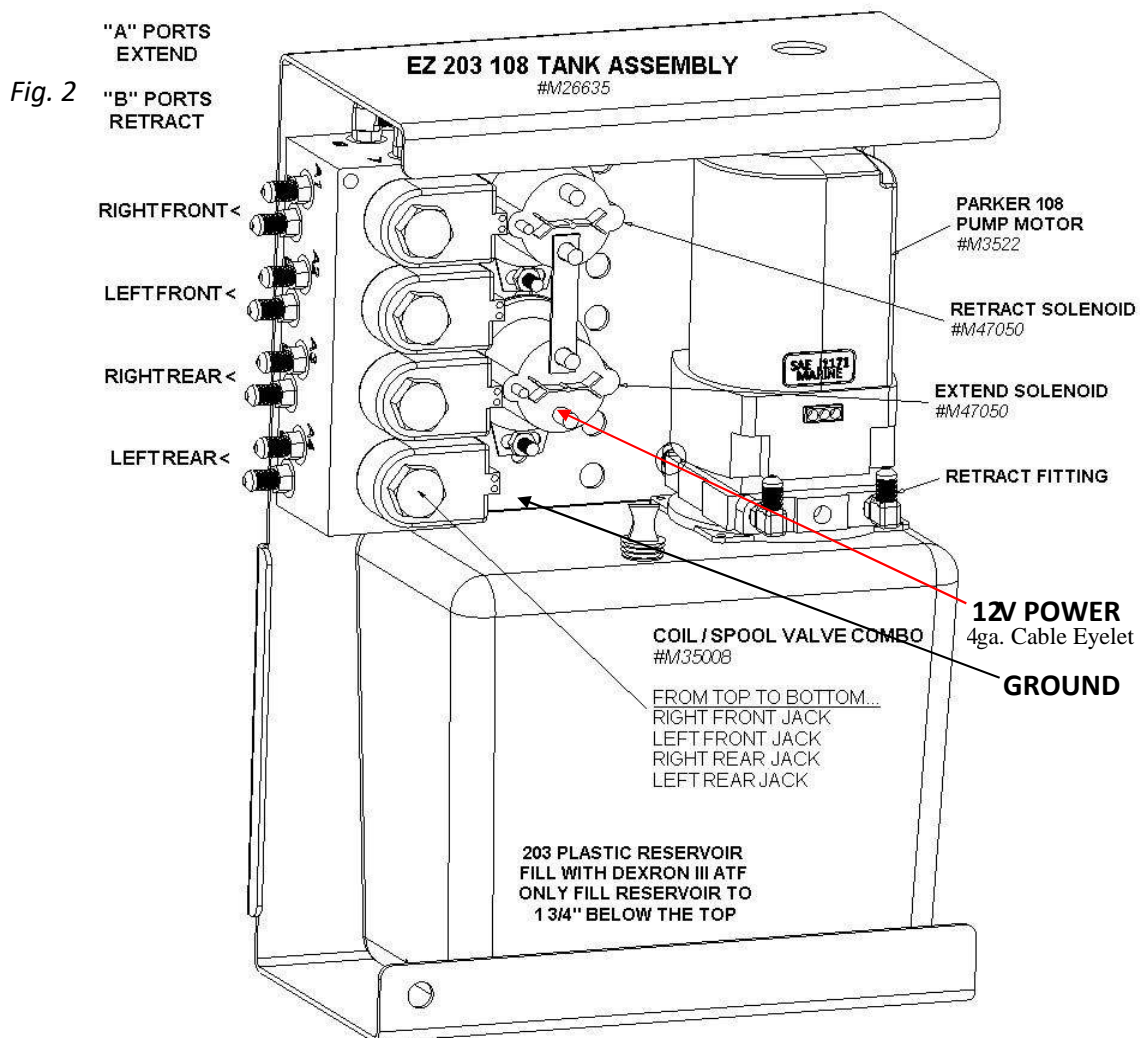

Central tank assembly is typically located near the "center" of the unit, Example: In front of rear axle on driver's side frame rail (outside of rail or between rails).

# Horizontal Tank Assembly

192oz. Parker 165 M/O #M26650 CENTRAL TANK ASSEMBLY

Operating Manual Override to retract the cylinders in case of power failure.  
Power & Ground locations/installation.

**SAFETY WARNING!**  
MAKE SURE COACH IS ON BLOCKS OR BOTTLE JACK (etc.) WHILE OPERATOR IS UNDER COACH TO RETRACT JACKS MANUALLY!

192 fl oz. STEEL RESERVOIR (ATF DEXRON III)  
MANUAL OVERRIDE 165 MAGNETIZED BI-DIRECTIONAL MOTOR  
INDIVIDUAL MANUAL OVERRIDE VALVES FOR EACH CYLINDER

VALVES FOR EACH INDIVIDUAL JACK FROM LEFT TO RIGHT (BELOW)...  
DRIVER REAR, PASSENGER REAR, DRIVER FRONT & PASSENGER FRONT

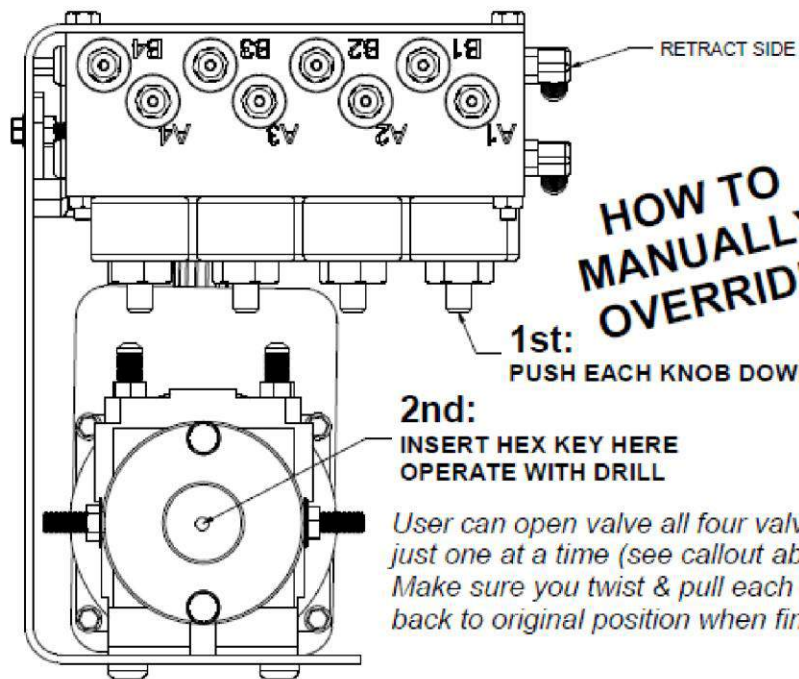
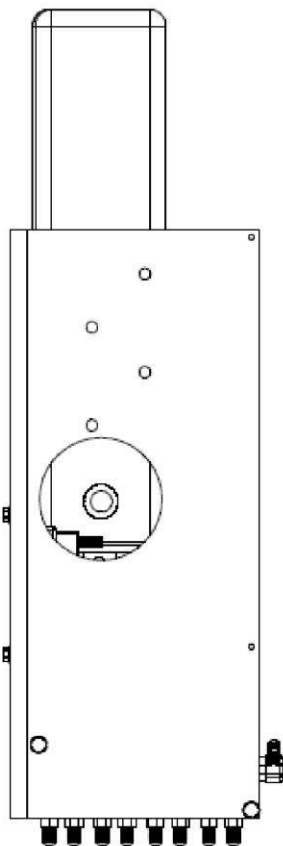

**HOW TO MANUALLY OVERRIDE**

1st: PUSH EACH KNOB DOWN & TWIST

2nd: INSERT HEX KEY HERE OPERATE WITH DRILL

*User can open valve all four valves or just one at a time (see callout above). Make sure you twist & pull each knob back to original position when finished.*

## INSTALLATION: 12V & GROUND CABLES

**12V POWER STUD ON SOLENOID**  
-ROUTE RED 2 GAUGE BATTERY CABLE TO POSITIVE TERMINAL ON CHASSIS/VEHICLE BATTERY IF DIESEL, RUN TO HOUSE/RV BATTERY IF GAS CHASSIS.

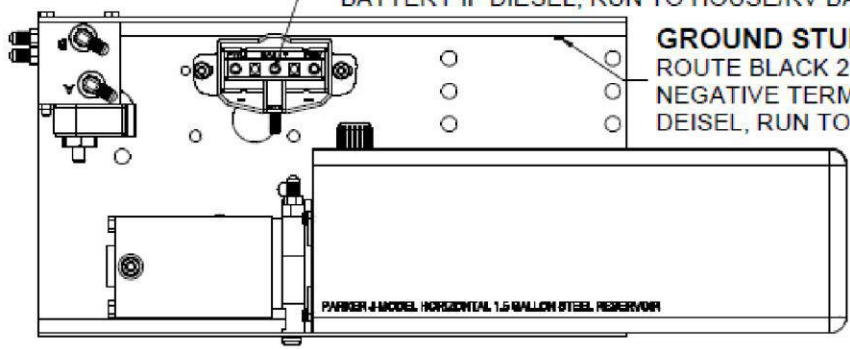

**GROUND STUD LOCATION (UNDERNEATH w/ COPPER STRIP)**  
ROUTE BLACK 2 GAUGE BATTERY CABLE DIRECTLY TO NEGATIVE TERMINAL ON CHASSIS/VEHICLE BATTERY IF DIESEL, RUN TO HOUSE/RV BATTERY IF GAS CHASSIS.

PARKER # MODEL HORIZONTAL 1.6 GALLON STEEL RESERVOIR

# MEDIUM TANK ASSEMBLY

#M26850

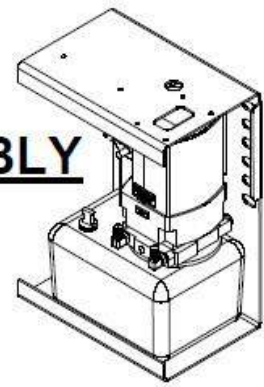

OVERALL DIMENSIONS:  
 9" WIDE  
 12.5" TALL  
 5.75" DEEP

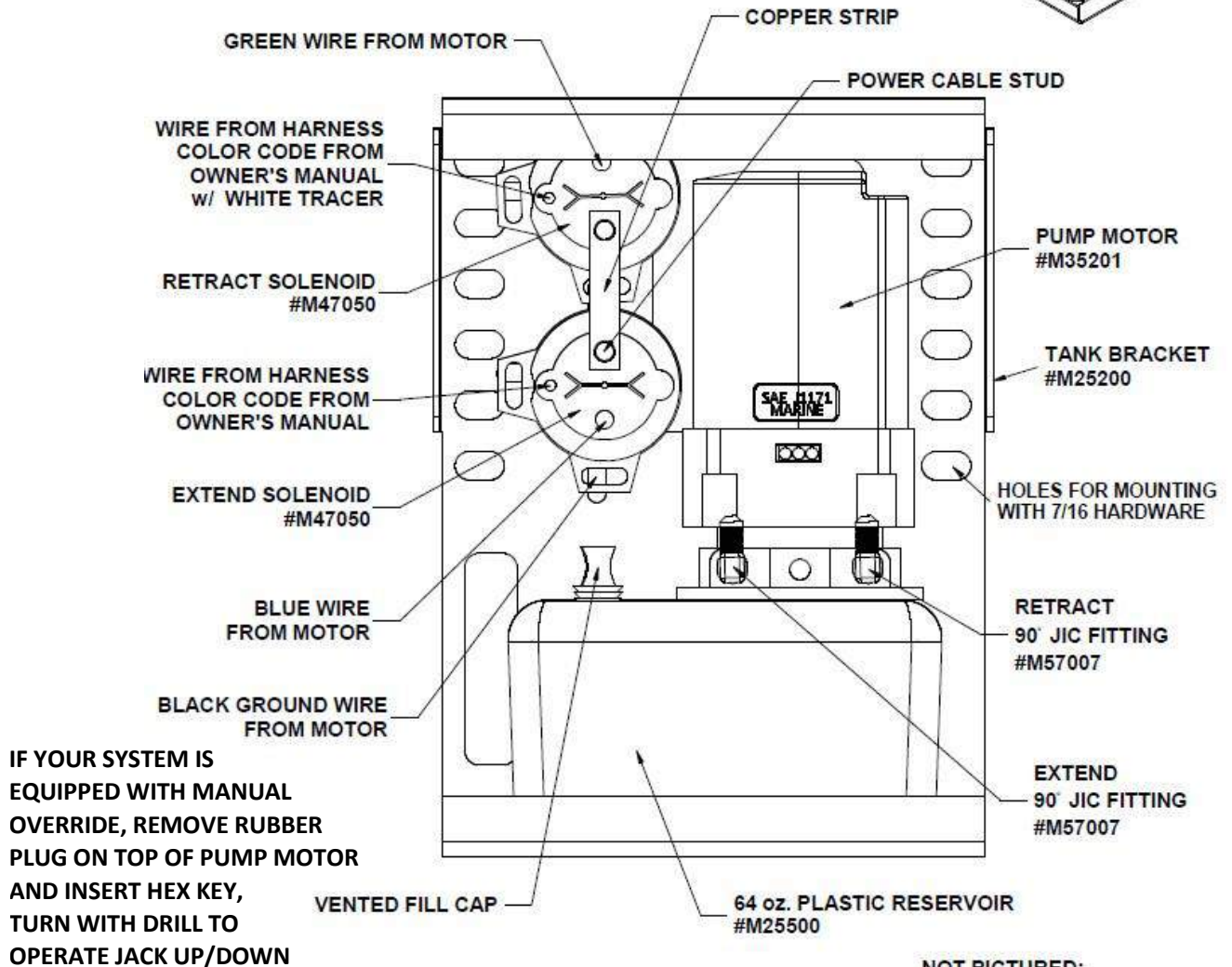

4 PT WIRING HARNESS COLOR CODE DIAGRAM:  
 LEFT FRONT: GREEN/WHITE & GREEN  
 RIGHT FRONT: BLUE/WHITE & BLUE  
 LEFT REAR: GREY/WHITE & GREY  
 RIGHT REAR: BROWN/WHITE & BROWN

NOT PICTURED:  
 TANK COVER  
 (BLACK TEXTURED PLASTIC)  
 #M12002

## Mounting Tank Assemblies (Quad or Central)

Our tank assemblies are weather resistant and must be mounted vertically and can be mounted externally on the vehicle's frame by drilling holes in the frame or welding a bracket, tanks can be mounted to a cylinder bracket or inside a storage box. Use at minimum two 7/16" or 3/8" bolts per tank assembly. Take care when mounting and running hydraulic lines & wiring to avoid moving parts, exhaust, etc.



# Grounding your tank assembly...

Each pump requires 12V power and sometimes an additional ground is required for the pump/motor to operate correctly. This is true for central pump, quad pump and 2pt systems. An auxiliary ground harness (optional) could come pre-wired to the tank assembly, otherwise attach a 10-gauge wire from the location shown below (solenenoid mounting stud from each so and to a good grounded surface on the vehicle frame or directly to the negative terminal on the battery. At the bottom of this page is a picture of the Mercedes Sprinter (chassis cab) uni-body ground location in front of the rear axle.

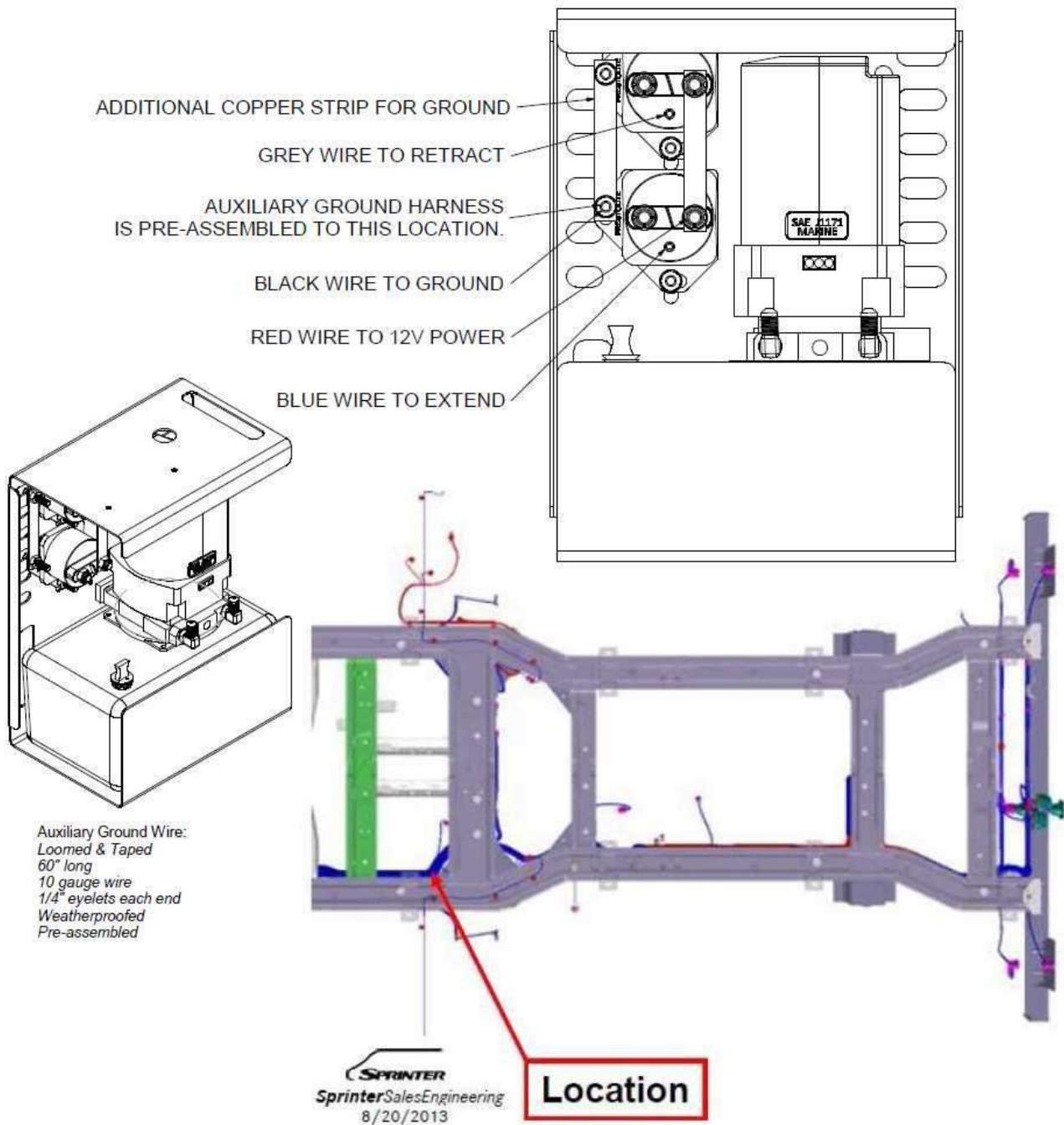

## Main Wire Harness –Automatic Leveling & Platinum System

### Installing the 14-Pin Wiring Harness Central Pump Automatic Leveling & Platinum Systems

The harness has two ends with plugs; the “panel” end has a 14-pin connector & a 6-pin. This end will need to route to the control panel’s location (usually near front of vehicle near driver’s seat or in wall of cabinet near service door). The other end will have one 14-pin connector that will plug directly into the tank assembly. The rest of the harness has two wires: Black & Tan, both of these wires plug directly into the Limit Switch that you installed previously onto each jack. Attach the wire harness to the frame rail (usually inside of rail with other wiring) with p-clips or zip ties safely routing away from any moving suspension parts or exhaust (complying with RVIA regulations). Example diagram on next page...

### Installing the 14-Pin Wiring Harness Quad Pump Automatic System

The main wire harness will have three wires for each corner: One wire goes to the limit switch (has spade connector) (the limit switch has two wires coming from it, the wire with the eyelet goes to ground, the spade connects to harness). The other two wires (same color except one has a tracer) have female push-on connectors that plug into the operation posts on each solenoid. The battery harness has eyelets at each corner that attaches to the power stud on the lower solenoid (with the copper strip). See the “Medium Tank Assembly” diagram earlier in the booklet. The main harness lead has a 14-pin connector at the end, this end will need to route to the sensor location. Attach the wire harness to the frame rail (usually inside of driver’s side rail with other wiring) with p-clips or zip ties safely routing away from any moving suspension parts or exhaust (complying RVIA regulations). Example diagram on next page...

## Installing the Limit Switches to the Jacks

Central Pump systems, both wires from limit switch plug into harness.

The Wireless System does not have a main wire harness that goes to each jack from the controls, but it does have an optional all-up safety feature complete with limit switches that is routed to each jack. This harness routes to the All-Up indicator that should be mounted near the driver inside the vehicle. The Limit Switch harness has two wires that go to each jack, one green and one black, each wire goes to the wires from the limit switch shown on the right. Wiring the lead wire to the all up indicator is shown below.

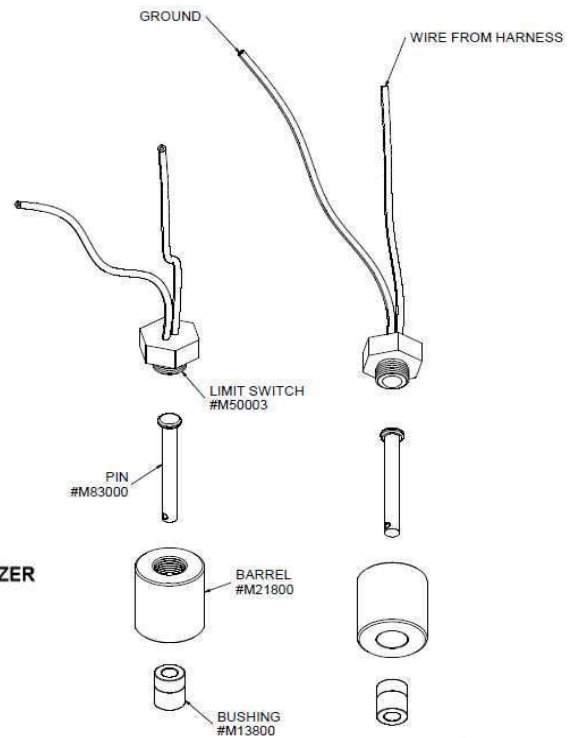
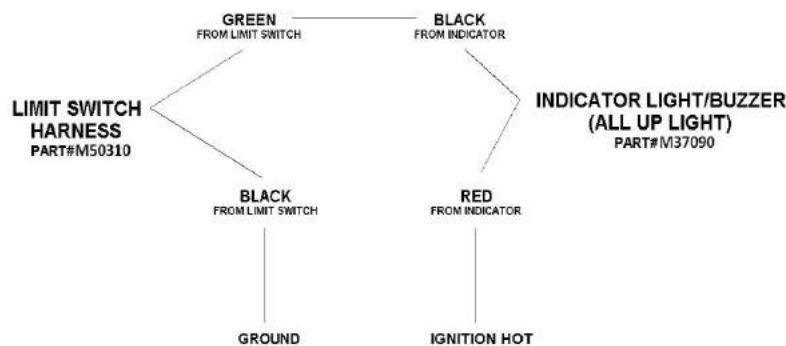

Example below of routing the Quad Pump Automatic & Manual systems 14-pin wire harness. The Central Pump Automatic & Platinum systems harness is similar except that the leads to each corner or jack have only a tan & black wire that plugs into the limit switch and the end of the harness with the 14-pin connector plugs into the pump while the end with the 14-pin & 6-pin connectors plug into the Automatic's Sensor or Platinum panel. Take care to avoid high heat areas and moving parts.

### MAIN WIRE HARNESS DIAGRAM

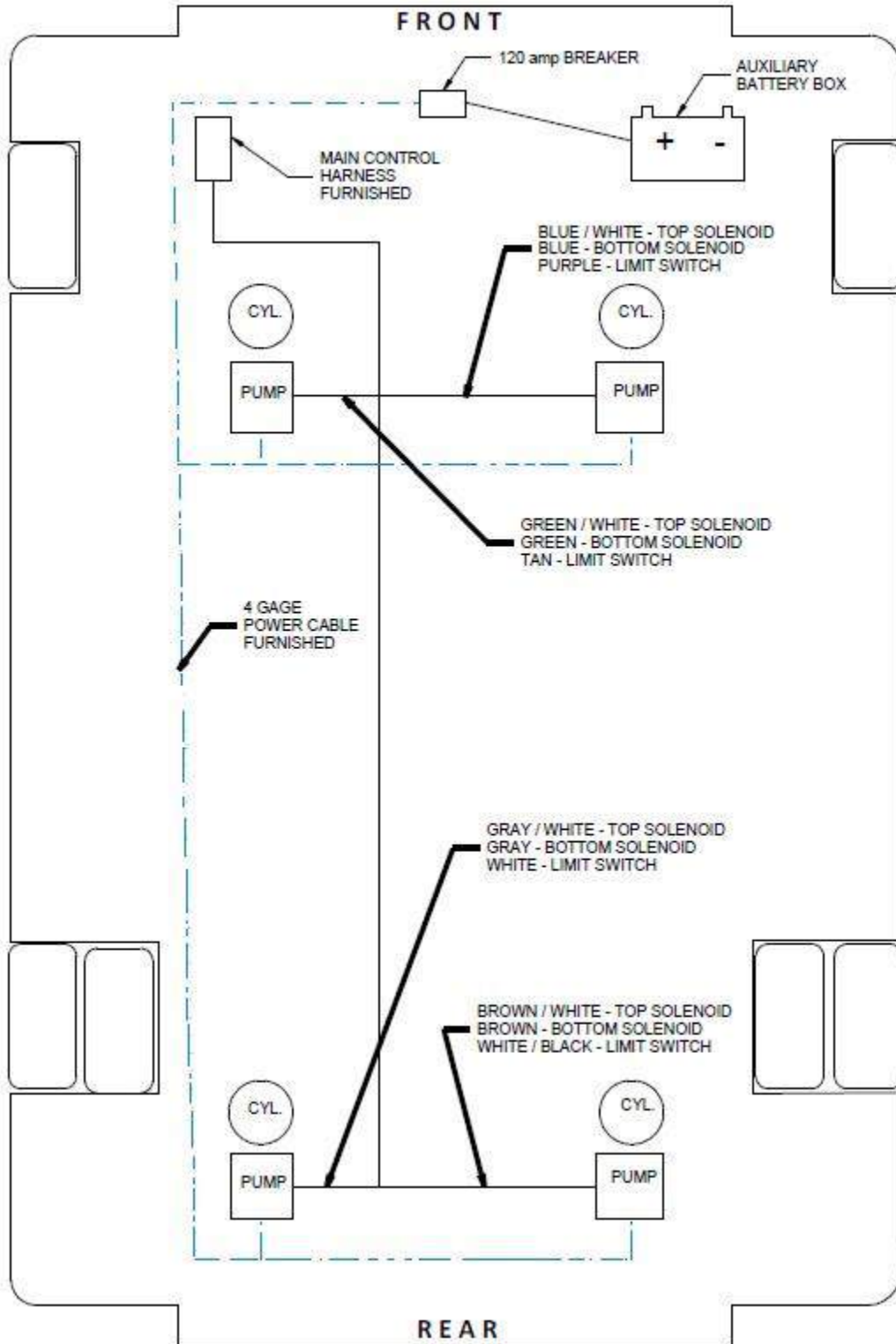

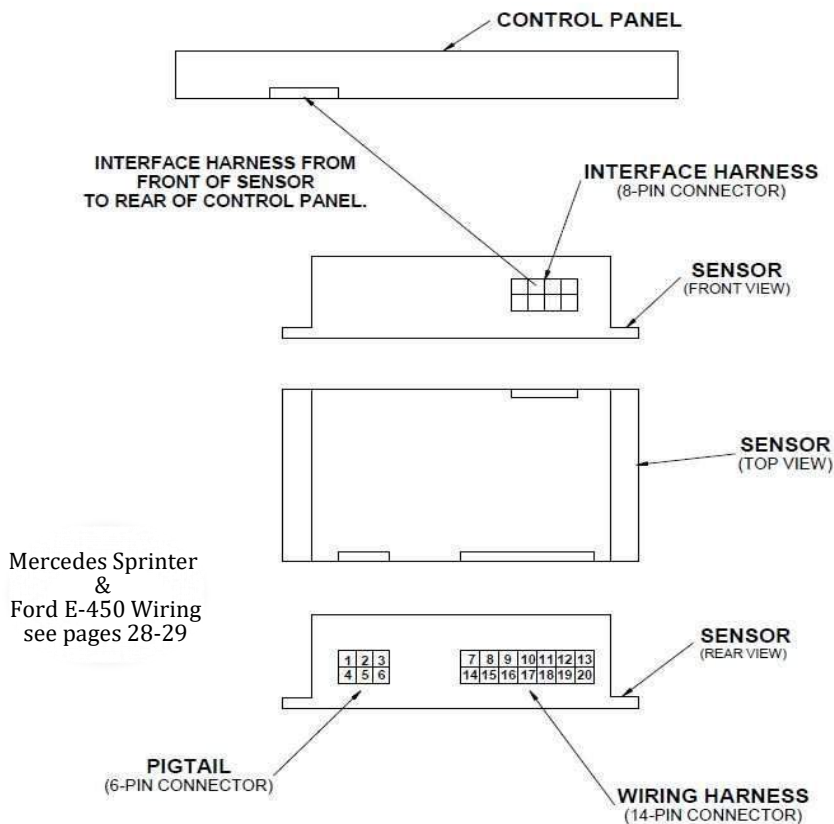

### **Installing the Automatic Leveling**

**Sensor & Control Panel:** Fasten the sensor to a secure structure (usually the floor) inside the vehicle (not weatherproof) ensure that it is mounted level and the arrow on top of the sensor is facing the correct way. Plug the 14-pin & 6-pin from the harnesses into the back side. The 6-pin connector only has three wires that need to be hooked up: red, yellow and black. The yellow wire needs to tie into an ignition or accessory hot wire from the vehicle. The red wire needs to attach to a factory fused 12V power source (7.5-amp fuse). The black wire is ground. After doing so attach the interface harness (8-pin connector) to the front of the sensor and attach to the Control Panel. The panel may be mounted on the dash in a safe location or on a panel somewhere on inside the coach, or inside Quadra's optional plastic

box assembly with the harness loosely coiled underneath the driver's seat.

### **Installing the Platinum Control Panel**

Plug the 14-pin & 6-pin from the harness into the back side. There is a yellow wire coming from the 6-pin that needs to tie into an ignition hot wire from the vehicle. The panel may be mounted on the dash in a safe location or on a panel somewhere on inside the coach, or inside Quadra's plastic box assembly with the harness loosely coiled underneath the driver's seat. **Optional safety feature for Platinum panels,** features an in-line toggle switch to shut power off to the panel to prevent operation while driving down the road from children, etc. Find the red wire from the 6-pin harness that goes to the back of the panel. Cut and splice the included wires to route to the toggle switch that should be located near the Platinum panel for convenience.

### **Battery Cable Installation for Central Pump & 2pt Systems**

Supplied will be a 4-gauge battery cable that needs to be cut into two pieces.

- The 1<sup>st</sup> to run from the Solenoid power stud (marked BATT+) to the 80-amp breaker AUX stud.
- The 2<sup>nd</sup> to run from the BAT stud on the breaker to the Positive Terminal on the coach's house battery.

Hooking up the power should be the final wiring step so make sure this is done after all the other electrical work is done for safety. The supplied 80-amp breaker should be securely fastened in the battery box.

### **Battery Harness Installation for Quad Pump Systems**

Supplied will be a 4-gauge battery harness that must be ran from the coach's house battery to all four pump assemblies at the solenoid power stud (with the copper strip). For the end going to the breaker read below:

- Mount the 120-amp breaker near the battery (usually in the battery box) cut a piece of the battery harness off that is long enough to reach the battery from the breaker.
- Install the eyelet to the now open end of the battery harness and hook it to the BATT post on the breaker.
- Install the eyelet to the short cut piece and hook that to the AUX post on the breaker and to the positive terminal on the coach's house battery. Hooking up the power should be the final wiring step so make sure this is done after all the other electrical work is done for safety.

**Installing the Manual Control Panel:** Plug the 14-pin harness & 6-pin into back of panel, mount with bezel.

### **Installing the Wireless Receiver**

Mount the Wireless Receiver near the tank assembly, check and plug the wiring connector from the receiver to The tank assembly to make sure it reaches, the Receiver is weatherproof but be aware of possible road debris, clear of exhaust and other moving parts.

## ***Central Pump* Final Extend Hose Installation & Bleeding the System**

---

During installation of the hydraulic lines, air is internally captured in the hose. Due to this, bleeding the air out of the system is necessary for the system to work properly. This process is done at the end of installation and requires two people and can be messy, so as a warning make sure you are wearing eye protection and have rags ready to use. Make sure all hose fittings are tight on the pump side and the retract side of the jacks. Extend hose fittings should still be un-installed.

- With person #1 running the panel, go into Manual Mode, all jacks should be fully retracted.
- Person #2 (armed with a 15mm wrench, safety glasses, rag and a one-gallon container) needs to access the left rear jack and place the un-attached extend hose into the empty container.
- Now person #1 will extend that left rear jack from the panel (press & hold button).
- Fluid & air will be spilling out of the port, once a solid stream of fluid occurs, person #1 will release the button on the panel, after fluid stops flowing person #2 should install the hose fitting to the jack.
- Repeat these steps with the rest of the jacks.
- After doing so, extend all jacks fully and let stand for 15 minutes.

---

- Then retract all the jacks and remove the tank cover and check your fluid level to verify the fluid in the reservoir is around 1 3/4" below the top (ATF Dexron III) do not fill to the top!

Finally install the tank cover, check that all hardware is tight, the sensor is facing the correct way and is mounted level and the house battery is fully charged.

*In some instances, the front jacks may need to be dis-mounted from underneath the cab to access the top extend ports during the bleeding procedure.*

## ***Bleeding Quad Pump* systems**

---

In Manual mode, extend all four jacks to complete extension and leave in this position for 20 to 30 minutes. This pushes all the air out of the lines by weight pressure. After turn panel back on and press Retract.

## Troubleshooting - *Hydraulic Cylinder/Plumbing Related*

---

**What fluid do we use in the system?** Automatic Transmission Fluid Dexron III ATF

**Cylinders running “choppy” ...** Bleed the system, if central pump system, try quad pump method first.

**Cylinders make loud “squeaking” noise while operating...** Spray rams with Teflon spray (dry lubricant).

**Hydraulic fluid on footpad or on ground around cylinder...** Loose fitting or broken hydraulic line.

**Cylinders “creep” down or don’t hold pressure when lifting/holding coach...**

- Check fluid level, Check for leaks in hydraulic lines/fittings
- Possibly plumbed backwards... (Bottom port on cylinder tube connects to right port on pump, etc.)
- Relief Valves have failed on pump motor... replace motor/tank assembly
- Hydraulic seal failure, check for oil around bottom of cylinder or welds... replace cylinder

## Troubleshooting – No “All Up” Light

---

Auto Leveling/Platinum Control: If the “All Up” light is not coming on and you hear the **buzzing sound from your panel when the vehicle ignition is on** it might be a limit switch on one of the jacks. After attempting to retract all four jacks from the panel and doing a visual check to verify that the jacks are indeed retracted but the panel has no “All Up” light. The first step is to extend each jack a few inches and individually retract one at a time. Sometimes the foot pad retracts crooked and doesn’t fully engage the pin. If that doesn’t work, with the jacks fully retracted, press the RETRACT button on the panel and manually pull each limit switch pin up to see if that engages the switch, if the panel shuts the pump off then that limit switch is not engaging properly. To fix this, it could be the foot pad is loose, remove & re-tighten the ¾” nut with a 1 1/16” socket with an impact wrench. If this does not work you can get a “vacuum cap” at your local hardware store for the ¼” diameter pin which extends the length of the pin and completes the circuit.

If you have an “All Up” light but your jacks are NOT fully retracted, we call this a false all up light, this means you have a bad limit switch (they can stick in the “passing” position due to build-up of road debris or rust).

To get you out of a jam or to bypass this... Central pump systems: disconnect the wires to the limit switch, and plug the two wires from the harness that usually go to the limit switch and plug them into each other (black & tan wires) this closes the circuit and allows the jack to be retracted. Quad pump systems: connect the colored wire from the main harness and connect it to the ground wire from the limit switch (or to frame).

## Troubleshooting - Continued...

---

(Auto Leveling) If the **LEFT & RIGHT** lights are flashing that means the program “timed out”, which may mean the coach is on too un-level ground or there was too much movement in the coach during the automatic leveling program. Try again.

If rear jacks are hanging too low to the ground with the jacks retracted fully, check underneath the coach and check to see if the jack can slide up one row of holes. If this can be done, make sure you raise both rear jacks the same height and tighten each mounting bolt to 70 ft./lbs. If your coach is equipped with an airbag system, just increase air pressure slightly to raise the coach.

If a single jack on a central pump system is simply not working properly, the **valve or coil** to that particular jack might be bad. To replace, simply call or go online to order part number **#M35008**.

**Panel won't turn on, system won't run, clicking noise, FRONT & REAR lights flash...**

Battery low, panel won't turn on = coach battery, the system relies on the house battery. The battery needs to be nearly 100% charged for the system to work, it doesn't make a difference if the coach is new, that doesn't mean the battery is fully charged or even good. Batteries don't charge instantaneously, so one can't just expect to hook it up to a charger and the system will work immediately, if the battery is good, then the unit might have a ground issue. **Auto systems must un-plug/re-plug the interface cable to clear code on panel regardless.**

***Panel is on, but pump(s) are not working OR solenoids clicking but pump/motor is not running...***

**Auxiliary Ground Cable**

Sometimes required for heavily coated frames, solenoids need a 10-gauge wire to be attached to one mounting stud for both solenoids on each pump assembly (central or quad) that isn't working properly to the vehicle's frame for optimum performance.

Effective: February 12th, 2018

## Warranty Guide

Owner must activate warranty! Via Phone or Website  
1-800-752-9815 [www.bigfootleveler.com](http://www.bigfootleveler.com)

OEM Installed Auto Leveling Quad/Central Pump Systems:  
*1 Year Cylinder Replacement, Parts & Labor*

Should the product be defective due to workmanship and/or material flaws, we will repair/replace the defective material. **Core charges may be applied and refunded on certain components.**

### Quadra is NOT responsible for:

- Freight on warranty parts.
- Replacing footpads, bolts, or fluids lost as a result of failure to maintain the system (Loose footpads should be tightened at owner's expense).
- Damages caused by abuse, misuse, negligence, misapplication, error of operation, accidental or purposeful damage or faulty installation. Including but not limited to hoses, fittings & wiring components.
- Liability for loss to the vehicle, or apparatus or property, loss of time, manufacturing costs, labor, material, loss of profits, consequential damages (direct or indirect).
- For transportation to and from a service center, onsite service calls to or from the customer, damage from road hazard, loss of salaries, commissions, lodging, towing charges, bus fares, car rentals, fuel expense, telephone charges, inconvenience compensation while repairing or replacing a defective part or material.

*This warranty voids all previous issues. Effective date: 2/12/2018*

**OWNERSHIP MUST BE REGISTERED WITHIN 30 DAYS FROM THE DATE OF PURCHASE TO ACTIVATE WARRANTY. Do it online at [BIGFOOTLEVELER.com](http://BIGFOOTLEVELER.com)!**

Prior to any work being done an **authorization number must be obtained** by calling 269-483-9633 for Warranty Parts or Service Labor. For full warranty transcript just contact us!

Service labor based on a flat rate schedule determined by Quadra for **authorized** work performed will be reimbursed. This will eliminate much diagnostic time and avoid **refusal of unauthorized claims**. Many problems may be resolved by contacting a Quadra service representative.

**Provide the system serial number here \_\_\_\_\_.**

### **EMERGENCY SERVICE**

For afterhours emergency service please call our normal office number  
**269-483-9633** and follow the instructions.





*Wayfarer*

---

SLIDE-OUT FEATURES

CHAPTER

11

## SLIDE-OUT FEATURES

### GENERAL CONSIDERATIONS

The Wayfarer is equipped with a slide out located on the drivers' side and on the rear of the motorhome. The slide-out-room feature is actuated by a wall switch (Figure 10-1). Press the slide-out setting to extend or retract the slide-out.

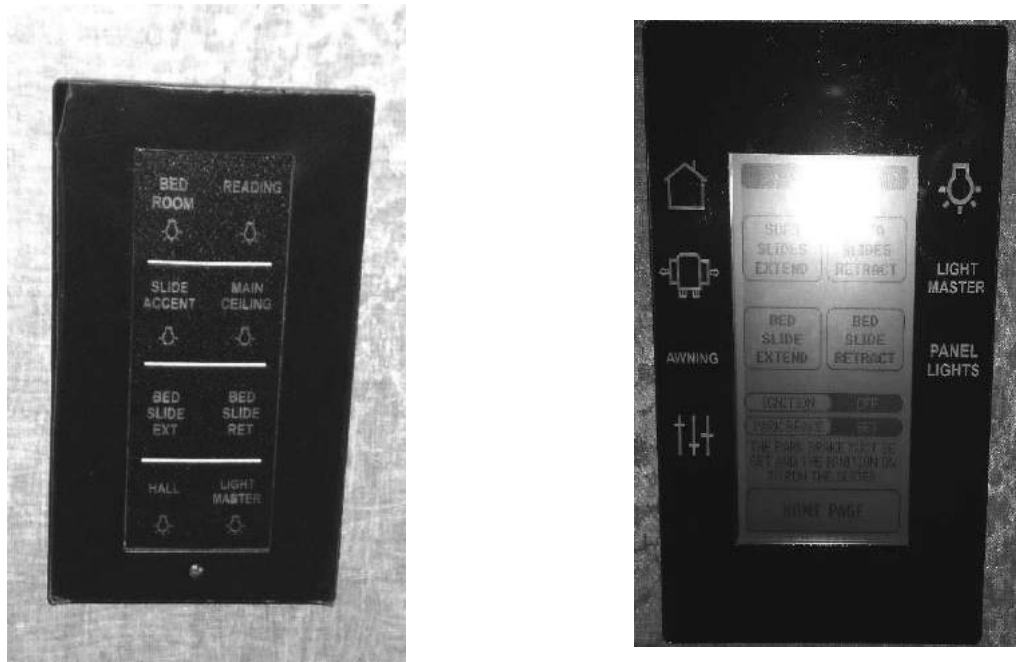

Figure 10-1: Slide-out Switches

# NOTICE

**If the slide-out room doesn't move when the switch is depressed, check the following:**

- **Make sure the ignition system is turned "on."**
- **Make sure the park brake is engaged.**
- **Make sure the battery is fully charged and connected.**
- **Make sure the slide-out breakers haven't been "tripped." These are located in the storage box with the inverter or converter.**

## OPERATING PRECAUTIONS

Before the slide-out-room mechanism is to be used, make sure the motorhome is parked level. Verify that no obstacles (e.g., branches, trees, telephone poles, power/water hookups, trash bins, etc.) are within a five-foot space envelope of that slide-out room to keep from damaging the slide-out room when it is finally deployed.

## NOTICE

Before attempting to extend the slide-out room, check to make sure that there is at least five-foot clearance around the area where the slide-out will be extended. Do not allow anyone to sit in slide out while operating the slide feature. This could result in extensive damage to the motorhome.



Figure 10-2: Typical Slide-out fully

## EXTENDING THE SLIDE-OUT ROOM

1. Any loose materials or possible obstructions, such as rugs or furniture should be removed from the immediate, slide-out room area. Make sure that the motorhome has been leveled, that the battery is fully charged and connected to the electrical system, parking brake must be set and that the ignition switch is “on” and the engine is running before attempting to use the slide-out features.
2. Verify that there are no obstructions outside which may interfere with the operation of the slide-out room.
3. Make sure the ignition switch is on the “on” position and the parking brake is engaged.
4. Push the “Extend” portion of switch and allow the slide-out room to go to its fully extended position. When fully extended, release the switch.

## RETRACTING THE SLIDE-OUT ROOM

1. Before attempting to move the motorhome, the slide-out room must be fully retracted.
2. Verify that the 12 VDC system is fully charged and connected to the electrical system.
3. Make sure all personal equipment and any children are away from the slide-out.
4. Make sure all cabinet doors around the slide-out areas are closed.
5. Push the retract section of the touch panel; allow the slide-out room to go to its fully retracted position.
6. Release the rocker switch (this locks the room into position).
7. For the slide-out in the bedroom the bed must be raised to retract.



*Wayfarer*

---

EXTERIOR FEATURES

CHAPTER

12

## TOWING HITCH

On the rear of the Wayfarer is a Class 2, 5,000-pound towing hitch (Figure 11-1) capable of handling a tongue weight of 500 pounds.

This hitch is installed for towing a passenger car to be used when the vehicle is parked. The wire connector installed with this hitch is a standard, seven-pin connector.



Figure 11-1: Towing

## EXTERIOR SIDES

The sides (Figure 11-2) of your Wayfarer are constructed of gel-coated fiberglass. To add to this feature, the end caps are also gel-coated fiberglass. To clean these fiberglass surfaces, only use warm water and a mild cleanser; gently wash with soft cloths. Use of stiff bristle brushes or other harsh abrasives may cause scratches in the fiberglass surfaces.

Please note: Tiffin Motorhomes is NOT responsible for the weathering and/or oxidation of gel-coated surfaces.

Spacious storage compartments are located on the exterior sides of your Wayfarer. These external compartments provide ample, additional space for your belongings while you are traveling. When stowing materials in these storage compartments, try to “balance” the resultant weight load from front to rear and from side to side—this will keep the center of gravity of the motor home essentially unchanged and should not adversely affect the handling characteristics of the motor home when it is in motion.



Figure 11-2: Exterior of Wayfarer

## SECURITY LIGHTS

On the Wayfarer, exterior security lights (Figure 11-3) are standard features.

A light is installed on the passenger side of the coach to help light that side of the Wayfarer for added protection.

This light can serve as a “porch light” when the motorhome is parked and the awning is deployed so that various activities (e.g., sitting outside, grilling, visiting) at dusk and later can be enjoyed by the motorhome owners and their guests.

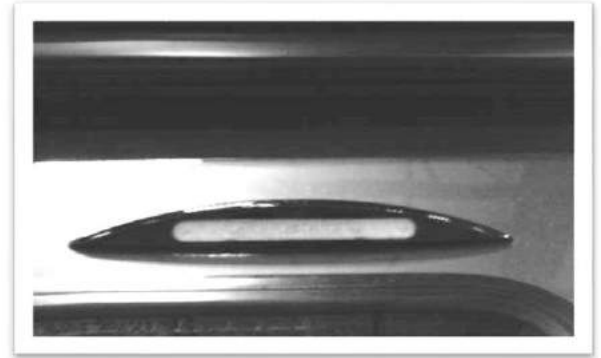

Figure 11-3: Exterior Security Light

## ELECTRIC STEPS



Figure 11-4: Electric Steps



Figure 11-5: Step Switch

The Wayfarer is equipped with electric door steps (Figure 11-4).

The switch (Figure 11-5) to operate these steps is located in the door stairwell. When the power switch for the steps is in the “on” position, simply open the door and the steps will automatically extend.

Detailed operation for the electrical, double-entrance, door steps is as follows:

1. Turn the step power switch “on”.
2. Close the door. The step should retract and lock into the UP position.
3. Open the door. The step should extend and lock into the DOWN position.
4. Turn the step power switch “off.” The step should remain in an extended position when the door is closed. Turning “off” the power with the step retracted will hold the step in a retracted position, as well.
5. With the step extended, turn the step power switch “off” and close the entrance door. Turn the vehicle ignition switch “on.” The ignition override system will go into effect and the step will automatically retract.

6. With the step switch in the “on” position, turn the vehicle ignition switch “off” and open the door. The step will extend and lock in the DOWN position.
7. This feature is only operative the first time the door is opened after the vehicle ignition switch is turned “off.” When the ignition switch is “on,” the step will always activate with the door movement, regardless of the position of the step power switch.

Other exterior features include power-assisted patio awning. If such are available, they can be controlled from the switch console located in the stairwell of the Wayfarer (see Figure 9-8).

	<b>CAUTION</b>
<p><b>DO NOT travel with the step in the extended position. If the motorhome is driven with the step in the extended position, there is the possibility of causing major damage to both the step and the motorhome.</b></p>	

<b>NOTICE</b>
<p>If the door is opened and closed without allowing the step to extend fully and lock in the “DOWN” position, the step will retract and lock in the “UP” position. When the door is re-opened, the step will not extend. The power switch must be turned “on” for the step to extend.</p>

	<b>CAUTION</b>
<p><b>Always be sure to “look before you leap!” When opening the entrance door from the inside, be sure that the step has fully deployed before trying to step outside to avoid falling and possible injury.</b></p>	

## MIRRORS

This motorhome is equipped with remote controlled, exterior, rear-view mirrors (Figure 11-6). Always adjust the mirrors for maximum rear visibility prior to driving. If another driver is to drive, be sure the mirrors are readjusted to accommodate the second driver.

The mirrors are adjusted by using the multidirectional switch located on the dashboard. Select the mirror to be adjusted by pointing the arrow in the direction of that mirror.



Figure 11-6: Mirror

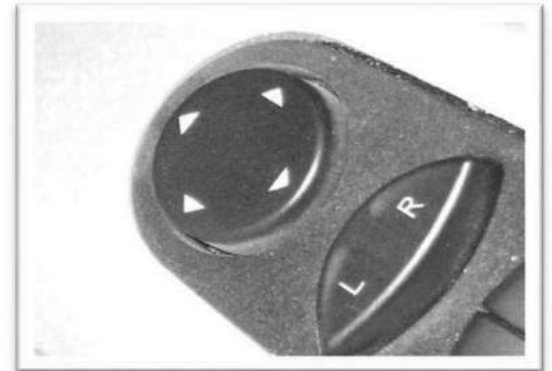

Move the control in the direction of movement desired to obtain the best view for that mirror. The adjustment control moves the top half of both mirrors. The bottom half of each mirror is convex and is adjusted manually.

Further information can be found in the Mercedes Owner's Manual.

Detailed instructions for these manual adjustments can be found in the manufacturer's literature available in the Owner's Information Package. However, this brief overview of mirror adjustment can begin the process: The top portion of the mirror should be adjusted horizontally so that you can see your own motorhome in the one-inch surface closest to the motorhome. The remaining portion of the mirror now permits you to see the road behind you. The mirror should be adjusted vertically so that you can see the rear bumper on the bottom of the plane portion of the mirror.

The convex mirrors should be adjusted horizontally so that you can see your own motorhome in 1/3 of the mirror. These convex mirrors should then be adjusted vertically to allow you to see any other vehicles alongside your motor home.





*Wayfarer*

---

INTERIOR FEATURES

CHAPTER

13

## INTERIOR FEATURES

### FLOORING

Vinyl flooring (Figure 12-2) is standard throughout the motorhome with the exception of the slide-out rooms, which are carpeted. For routine cleaning, sweeping or vacuuming the floor would be sufficient. If more thorough cleaning is warranted, the flooring can be cleaned with a damp mop and water. For stubborn stains, a mixture of soap free household cleaner (e.g., vinegar, ammonia, or comparable products) and water can be used to advantage.

You should not unduly saturate the floor surfaces with water, as this could damage the flooring substrate. Do not use any abrasives (cleansers, scouring pads; and the like) as they can scratch or mar the vinyl flooring surfaces and may cause damage to the vinyl flooring.

### CEILING

The ceiling in the Wayfarer motorhome is covered with a padded-vinyl headliner which can be easily cleaned with a damp, soft cloth and a mild detergent.

Clean around all vent areas to prevent any buildup of dirt, grease, or other accumulations.

Figure 12-4: Night Shades



Figure 12-2: Flooring

## WINDOW TREATMENTS

Throughout the Wayfarer, the window treatments consist of a blackout shade.

This blackout shade keeps heat and sunlight out during the day and provides complete privacy at night.

Each shade can be raised and lowered simply by pulling down on the shade.

The blackout shades are located on all the windows in the living area and bedroom. The cab over the bunk has a manual roller shade.

**CAUTION: DO NOT** overextend the shade; this will damage the roller tube. To operate the cockpit shades, pull the shade down to the desired level and slowly release to lock the shade in place. To retract, gently pull down on the shade and release.



*Wayfarer*

---

PLUMBING & BATH FEATURES

CHAPTER

14

## MONITOR PANEL

The monitor panel (Figure 13-1) permits checking the approximate levels in the fresh, gray, and black water holding tanks; the LP-gas level; and the condition of the battery.



Figure 13-2: Kitchen Sink

For the sink, cleaning care consists of washing only with mild detergents and water and using a soft cloth for subsequent drying and polishing.



Figure 13-1: Monitor Panel

## SINK, SHOWER & ACCESSORIES

The typical bathroom accessories include a towel bar and a toilet paper holder. The faucet in the bathroom was chosen to match the specified decor. The tub faucet with showerhead, hose, and bracket are coordinated with the sink faucet.



Figure 13-3: Bathroom



Figure 13-4: Shower

## WATER PUMP

The water pump is self-priming and totally automatic, operating on demand whenever water is required.

The water pump is used to pressurize the freshwater system when the unit is not connected to city water.

To start the pump, follow these instructions:

1. Fill or partially fill the fresh water supply tank
2. Open the kitchen and bathroom faucets.
3. Turn the water pump switch “on” and allow the water to fill water line and hot water heater.
4. Close each faucet after it delivers a steady stream of water (close the cold-water faucet first). Leave the hot water faucets “on” until they also deliver a steady stream of water. This procedure will assure that the water heater is filled with water.
5. The water pump should stop running once all faucets are closed.
6. The water pump is now ready for automatic operation.  
The pump will run when a faucet is open and stop when a faucet is closed.
7. Never allow the pump to run for long periods of time without water being present in the supply tank, as doing so may cause physical damage or blow fuses.

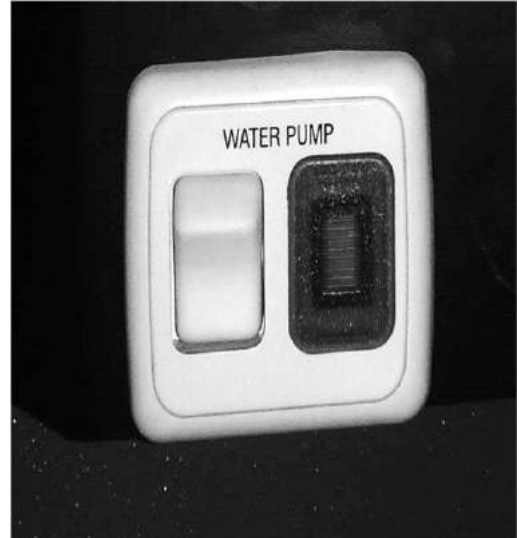

If water does not flow when a faucet is turned “on” while using the demand system, use the following troubleshooting chart:

<u>SITUATION</u>	<u>SOLUTION</u>
Pump running – no water	1. Fill tank
Pump doesn't Run	2. Clear the water line to the pump

1. Check the pump switch.
2. Check the 12-volt fuses
3. Check the electrical connections
4. Check the Battery

All the water should be drained from the freshwater system when the unit is not in use for extended periods. For more detailed information regarding the water pump, one should refer to the water-pump manufactures brochure.

## CITY WATER CONNECTIONS

When connecting your unit to city water, use the water hose manufactured and labeled for potable water service—this will assure that the hose selected for use will not alter the taste of the water.



When connecting your unit to city water, use the water hose and connect to #1 in the above figure. While doing so, make sure the blue handle is turned to CITY.

## DRY CAMPING CONNECTIONS

When dry camping, make sure the blue handle is turned to DRY. The switch located on the side will need to be switched to ON.

## HOOKUP

### HOOKING UP TO WINTERIZATION

1. Take plug out located at the end of the hose (#2).
2. Insert winterization hose.
3. Turn the blue handle to city.
4. Reference page 60, figure 2, to bypass.
5. Switch pump to ON position.

To connect the city water supply, connect one end of the hose to the city water supply.

Turn the city water supply “on” for a few seconds to clear the line. Once the hose has been flushed, turn the supply “off.” Connect the other end of the hose to the inlet valve on the sewer board; turn the blue handle valve on the sewer board to the city water fixtures turn the red handle valve on the sewer board to normal. (Note: As the water goes through the inlet and then passes through the filter insuring that all water exiting the faucets and showers have been filtered). Once the city water fill valve is opened, water is supplied to the freshwater system including the hot water heater, faucets, and toilet. Turn “on” the water supply and open all of the faucets to clear any trapped air within the plumbing lines within the motor home.

Once any air pockets have purged from the water lines and water flows freely, close all the faucets. The city water supply is pressurized; therefore, the water pump is not needed when the water system of the vehicle is connected to the city water system.

The valves should never be turned while there is pressure on the lines.

#### FILLING THE FRESHWATER TANK

1. Insert hose to #1.
2. Turn the blue handle to dry.
3. Turn the water hose on.
4. Fill to the desired location.

The freshwater tank is normally filled from the city water inlet on the sewer board. The red and blue handle valves located on the sewer board determine whether the city water is going through the water system or into the freshwater tank. To fill the freshwater tank, turn the blue handle valve to city fill tank, turn the red handle valve to normal. Since there is no automatic shut-off when filling the freshwater tank, check the level from the monitor panel while filling the freshwater tank on the motorhome. (NOTE: As your freshwater tank fills the water passes through the filter insuring that the water in the freshwater tank has been filtered before use).

All of the water should be drained from the freshwater system when the motorhome is not in use for an extended period of time.

#### RUN HOT AND COLD FIXTURES FROM FRESH WATER TANK

After filling the freshwater you are ready to run the water system from the freshwater tank supply.

1. Turn “on” water pump.
2. On the sewer board turn the blue handle valve to the normal position and turn the red handle valve to the normal position.

#### SANITIZING HOT AND COLD FIXTURES AND FRESHWATER TANK

To assure complete disinfecting of the freshwater system, it is recommended that the following procedures be performed on a new system, on one that has not been used for a length of time, or one that may have become contaminated. This procedure is also recommended before long periods of storage, such as during the winter months:

1. Drain the freshwater tank by opening the drain valve. All of the faucets should be in the closed or “off” position.
2. Prepare a chlorine solution using one gallon of water and one-half cup of chlorine bleach (5% sodium-hypochlorite solution). Prepare enough of the chlorine solution to administer one gallon of solution for every 15 gallons of tank capacity. Concentrations greater than 50 ppm may damage the water lines and/or the tank.
3. Once the freshwater tank is empty, close the drain valves in the water tank.
4. Pour the solution in the gravity fill which is located on the rear of this coach.



5. Turn “on” the water pump. On the sewer board turn the blue handle valve to “normal” position and turn the red handle valve to “normal” position.
6. Open each faucet, in turning “on” both the hot and cold faucets and flushing the toilet until all of the air has been purged from the pipes and the water runs freely. The entire system will then be filled with the sanitizing solution.
7. Allow the 50 ppm disinfecting solution to stand in the system at least four hours.
8. Drain the system and flush it with freshwater. The water system needs to be flushed with water repeatedly, if necessary, until there is no chlorine taste or smell left in the system. To remove any excessive chlorine taste or odor that might remain, prepare a solution of one quart of vinegar to five gallons of water. “Rock” the tank containing the solution; by moving the vehicle forward and backward several times to clean the tank; then drain that tank and refill with clean water.

#### SANITIZING HOT AND COLD FIXTURES ONLY (NOT FRESHWATER TANK)

1. All faucets should be in the closed or “off” position.
2. Prepare a chlorine solution using one gallon of water and one-half cup of chlorine bleach (5% sodium-hypochlorite solution). Concentrations greater than 50 ppm may damage the water lines.
3. Connect one end of the vinyl hose to the inlet valve on the sewer board; place the other end of the hose into the solution that has been prepared.
4. Turn “on” the water pump. On the sewer board turn the blue handle valve sanitize/winterize and turn the red handle valve to bypass.
5. Open each faucet, in turning “on” both the hot and cold faucets and flushing the toilet until all of the air has been purged from the pipes and the water runs freely. The entire water lines will then be filled with the sanitizing solution.
6. When the sanitizing process is completed, turn the water pump “off”.
7. Allow the 50 ppm disinfecting solution to stand in the system at least four hours.
8. Drain the system and flush it with freshwater. The water lines will need to be flushed with water repeatedly, if necessary, until there is no chlorine taste or smell left in the system. To remove any excessive chlorine taste or odor that might remain, prepare a solution on one quart of vinegar to five gallons of water. Repeat steps four, five and six to run the solution through the water lines. Drain the system and flush with freshwater.

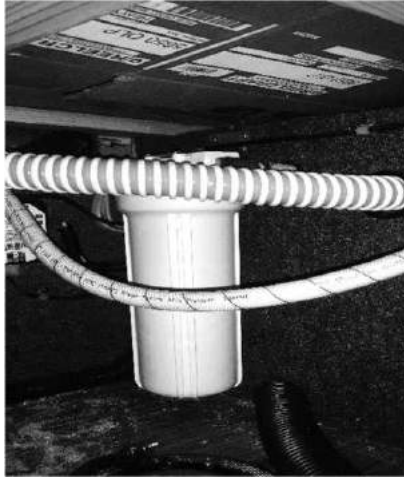

Figure 13-7: Water Filter

## WATER FILTER

This unit is equipped with a water filter (Figure 13-7) which must be removed before disinfecting the fresh-water system.

First remove the water filter and then replace cover to allow the sanitizing solution access to the faucets. As installed, the filter will remove chlorine, dirt, and other matter. The filter will also eliminate most phenol (or similar) odors and tastes while delivering sparkling, taste-free water for drinking and cooking.

The water filter is located in the sanitation compartment on the outside of the motorhome. The water filter is not guaranteed to remove the tastes and odors of iron and sulfur. To remove these impurities, you need to chlorinate the water. Replacement filters are available that will filter iron and sulfur. Ask your dealer or RV supply center about purchasing an iron and sulfur filter.

If you are traveling in an area where the water has high iron and sulfur content, then add one tablespoon of chlorine bleach to every 10 gallons of water in your tank—this will precipitate the iron or sulfur so that the filter can remove those impurities.

If you are at a site where the unit is connected to a city water supply, you will not be able to chlorinate the system because the water flows straight to your faucets and not through the freshwater tank.

Filters should be changed every 6-12 months depending on the quality and quantity of water that is used in your motorhome.

## WATER HEATER BYPASS SYSTEM

This process is performed when winterizing your motorhome. Using the bypass valve will keep antifreeze out of the water heater when winterizing the motorhome. Draining the water heater during winterizing is a MUST.

## BYPASS WATER HEATER FOR MAINTENANCE

This procedure is used for any maintenance that may be done to the water heater. On the sewer board turn the blue handle valve to the city fixture position and turn the red handle valve to the bypass position. (NOTE: You will still be able to use your faucets and showers if necessary but it can only be done with pressurized city water and will only receive cold water).

## FRESHWATER LINES

Check all of the plumbing connections for leaks at least on an annual basis.

If the water pump runs when all faucets are turned “off,” check for a possible leak. Be sure that the drain valves are closed. Connections at the kitchen and bathroom faucets normally seal by hand-tightening them and then making an additional half-turn with a wrench.

If a fitting leak persists, disconnect it completely and visually inspect it for mineral deposits or foreign material stuck on the sealing surfaces. Clean the surfaces thoroughly and reinstall the fitting.



Figure 13-8: Water Bypass

## GENERAL INFORMATION

The waste drainage system was designed to provide adequate and safe storage and/or disposal of waste materials. All of the materials used in the fabrication of this system are tested by a nationally recognized testing laboratory. The drainage system uses plastic piping and fittings connected to the sinks, toilet, and holding tanks. This plumbing permits the drainage of these fixtures to an outside termination. The vehicle should be reasonably level for best operation of both of the wastewater systems.

There are two, separate wastewater systems. The gray-water system is for wastewater from the sinks and shower. The black-water system is for sewage waste from the toilet. Each wastewater tank has its own control valve and both drain through a common sewer-drain hose.

## TOILET

The toilet (Figure 13-9) operates with water from either the fresh water tank with the water pump “on” or the city water supply. Before using the toilet, add water to the bottom of the tank. Refer to the “BLACK WATER TANK” instructions.

Figure 13-9: Toilet

The toilet flushes waste directly into the black-water holding tank. It is imperative that you use as much water as possible when flushing to prevent tissue and other solids from clogging the holding tank outlet.

When using your toilet, fill the toilet  $\frac{3}{4}$  full of water. To add water to the toilet bowl, push the pedal lever  $\frac{1}{4}$  of the way down until the desired water level is reached. To flush the toilet, push down on the lever until the water swirls. A small amount of water should remain in the bowl.

The toilet should be cleaned regularly for maximum sanitation and operational efficiency. Clean the toilet bowl with a mild bathroom cleaner.



## NOTICE

**Do not use chlorine or caustic chemicals, such as bleach or drain opening chemicals in your motorhome's toilet. This will damage the seals in the toilet and dump valves.**

## BLACK WATER HOLDING TANK

The “black water” (i.e., sewage) holding tank is located directly beneath the toilet. Before using the toilet, you will need to treat the tank with water that is mixed with an odor-controlling chemical. These chemicals are readily available at any RV supply store. Pull the toilet levers forward to allow the chemicals to mix with the toilet water. Continue pulling the toilet levers until a depth of at least one inch of solution is directly under the toilet. Release the levers and the waste tank is now ready for use.

### GRAY WATER HOLDING TANK (P-TRAPS)

The gray-water holding tank is located in the underbelly of the vehicle. It is primarily used for the drainage from the kitchen and bath sinks and the shower. P-TRAPS Each of the sink drains and the shower drain has a water trap (P-trap) to prevent holding-tank odors from entering the vehicle. These traps must have water in them to trap odors. When the vehicle is in motion, the water may splash out of the sink and shower drains. When the vehicle is stored, the water may evaporate from these traps allowing odors to enter the vehicle. If this occurs, run water from the faucet into the drain, allowing water to fill the traps again.

## NOTICE

Use only RV odor-controlling chemicals in the holding tanks. Products containing ammonia and petroleum will damage the ABS plastic holding tanks and seals. It is important that you use as much water as possible each time you flush the toilet. This will help prevent tissue and other solids from clogging the holding tank outlet.

### WASTEWATER DISPOSAL

Both of the holding tanks terminate in a valve arrangement that permits draining each tank separately or together. It is recommended to drain the black water tank first before draining the gray water tank. This procedure permits the water from the gray tank to wash the black-water residue from the drain lines.

The valves that open to release the water are called gate valves. The blade that closed the opening in the sewer drainpipes is connected to the T-handle to release contents of the tank(s) when pulled. The sewer line must be securely capped during self-containment use to prevent leakage of waste materials. Do not pull the holding tank gate valve “open” when the protective cap is installed on the pipe.

Always drain the tank into an acceptable sewer inlet or dump station. Whenever possible, drain both the holding tanks prior to traveling. The carrying capacity of your vehicle will be reduced if water is left in the black or gray tanks. The holding tanks should only be drained when they are at least  $\frac{3}{4}$  full. Doing this will provide a sufficient volume of water to allow the complete flushing of waste materials in the drain lines and hose. If the tanks are not  $\frac{3}{4}$  full, add enough water to allow for sufficient flushing.

Figure 13-10: Sanitation Coupling Valve

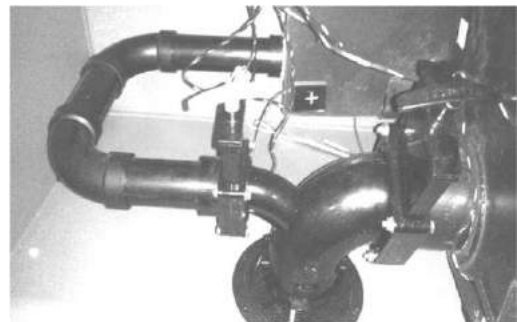

To empty the wastewater tanks, connect the adapter, supplied with your vehicle, to the drain hose. Unscrew the cap from the drain. Connect the hose, with the adapter in place, to the drain fitting. Open the gate valve completely by pulling on the T-handle. The tank will start to drain as soon as the T-handle is pulled. After you have drained the black-water tank, immediately drain the gray-water tank. This procedure helps to flush the black water from the sewage hose. When both the tanks are empty, flush them with a freshwater rinse before you close the valves. The gray tanks are easily flushed by pouring a couple of gallons of water into a sink drain. The drain outlet is engineered for quick release of the drain hose adapter. Always close the gate valves and secure the end cap to prevent leakage while the vehicle is in transit.

After draining the black water tank, it is recommended to add a holding tank deodorant to help control the odor and break down the solids. Follow the instructions given on the holding tank deodorant package.

#### SEWER CONNECTION AND CAMPING

While using the motorhome, it is important to keep the black-water holding-tank gate valve closed at all times, except when dumping. This allows an ample amount of liquid to remain in the tank to provide a smooth flow through the gate and drain valves when dumping. Sufficient liquid in the tank causes a swirling action that should take any accumulated solid wastes with it. Accumulation of solid wastes in the black water tank can be avoided by keeping the gate valve closed when connected to the sewer connection. The gray tank can be kept open while hooked to a sewer connection.

NOTE: When dumping, it is suggested to dump the black tank first, then the gray.

#### NO FUSS FLUSH

This vehicle may be equipped with a flushing system for the black-water holding tank. When draining your sewer tank, attach a water hose to the sewer spray connection. After the tank is drained, leave the gate valve “open” and open the water valve to allow water to spray inside the black-water tank. This will clean the inside of the tank of any debris that may be left inside the tank. After this procedure is done, disconnect the freshwater hose and close the gate valve.

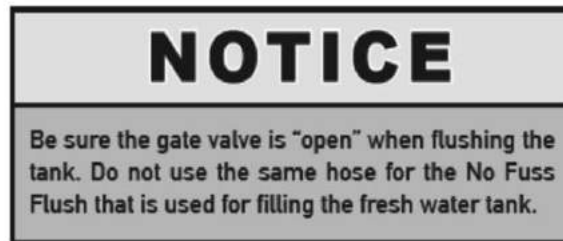

Be sure the gate valve is “open” when flushing the tank. Do not use the same hose for the No Fuss Flush that is used for filling the fresh water tank.

### EXTERIOR SHOWER

Your Wayfarer has an exterior shower for your use and convenience outside the motorhome. The exterior shower is located in the service compartment on the driver's side and allows you to do such things as rinse off sand or grass, muddy shoes, or bathe yourself outside of your motorhome. The faucet operates just as it would in your kitchen or bathroom. Exterior Shower and light.

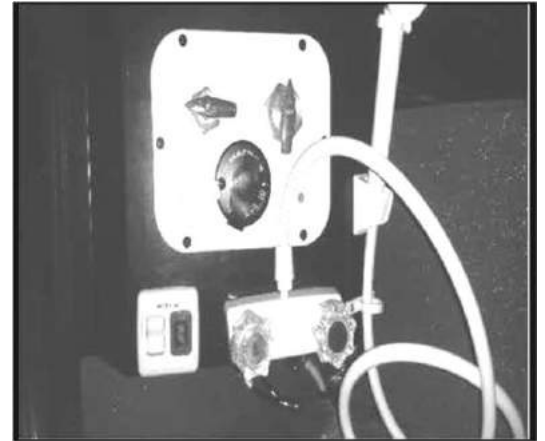



*Wayfarer*

---

WINDOWS, AWNINGS, VENTS, DOORS

CHAPTER

15

## WINDOWS

Sliding windows are custom built for the Wayfarer and allow easy sliding access to open the coach to fresh outside air.

There may also be a reflective coating on the windows to reflect back a portion of the sunlight to reduce the heating of the motorhome interior and to reduce the effects of the sun's "bleaching" of interior fabrics (curtains, upholstery).

Sun shades on both the driver's and passenger's sides can be deployed and moved at any time.



Figure 14-1: Wayfarer Windows

Windows throughout the coach are designated as "EXIT" windows in the event of an emergency.

To help make the windows slide more easily, we recommend using Plexus Plastic Cleaner which can be purchased through the Tiffin Motorhomes Service Department.

## AWNING

### GG1000 Awning with Speakers

The Girard Systems power patio awning (Figure 14-2) is standard on the Wayfarer.

The power patio awning is extremely durable and can be operated during light rain and wind conditions. However, when periods of heavy rain, or wind is expected, or you leave the awning unattended, the awning should be closed. Please note that damage caused by wind and rain is not covered by warranty.

To operate the awning follow the instructions listed below.



Figure 14-2: Power Patio Awning



### **WARNING!**

"To reduce the risk of electric shock the operator power is to be provided from a weatherproof junction box in the case of permanent wiring, as per 314.15 of the National Electrical Code, NFPA 70."

To prevent the motor protector from tripping do not exceed 2 minutes of operation per hour.

**ALL ELECTRICAL WORK MUST BE CARRIED OUT BY QUALIFIED PERSONNEL AND CONFORM TO APPLICABLE ELECTRICAL CODES AND STANDARDS.**

- Turn off power before beginning any electrical work.
- Please consult your RV's wiring diagram to locate any wiring prior to any drilling or any installation procedure.



- Ensure that placement of controls, cables, and wires are not in any way obstructed. This can damage the components and obstruct electrical current.
- Use only certified components.



Girard Systems awnings may be operated in light wind and rain conditions. When periods of heavy rain and or high wind are expected the awning must be closed. Never leave the awning open and unattended.

**Damage caused by wind and rain is not covered by warranty.**

All awnings must be closed prior to moving the vehicle for any reason. As an extra safety precaution a visual check that every awning is fully closed is required.

**Damage caused by failure to comply with these instructions is not covered by warranty.**

Before using your awning, ensure that the area into which the awning will be deployed is free of obstructions (Trees, walls, pillars, posts, other vehicles etc.)

**Damage caused by collisions with any of the above or similar is not covered by warranty.**

## BASIC SYSTEM OVERVIEW

### 1. **Mechanical system** – Consisting of:

- The enclosure (or cassette) protects the awning while closed.
- The roller tube which is mounted within the cassette.
- The top cover or fabric rolled onto the roller tube and connected to the lead rail that extends from the enclosure when the awning is opened.
- The folding arms that supports the lead rail and the fabric.
- Tubular motor which is mounted inside of the roller tube that controls the extension and retraction of the awning.

### 2. **Electronic controls** – Consisting of:

- 98GC781B Direct Wired Wall Switch

### 3. **User Controls** – Consisting of:

- 98GC781B Direct Wired Wall Switch used in conjunction with the 98GC780B Direct Wired Automatic Motion Sensor

### Buttons Description:



**IN Button retract the awning**



**STOP Command**



**OUT Button Extend the awning**

## TESTING AND ADJUSTMENTS

### OVERVIEW

- A. Adjusting Motor-limit switches
- B. Manual Override
- C. Adjusting Pitch and Elbow height
- D. Motion Sensor Testing

### A. ADJUSTING MOTOR LIMIT SWITCHES

#### **TOOLS REQUIRED**

Black plastic key provided with awning, or 4mm (5/32") Allen wrench.

**NOTE: The motor limit switches have been adjusted to the correct positions at the factory prior to shipment. When fully retracted the awning motor is set to stop the exact moment the awning box closes. When fully extended the fabric should be taut and the arms should be slightly bent, exposing a gap of about 1/4" at the elbows.**

Always check the motor limits after installation to ensure that the awning opens and closes correctly. Awning fabric can stretch over time, this will require an adjustment of the IN and/or OUT limit switch.

**IMPORTANT: EXTREME CARE SHOULD BE TAKEN TO ENSURE THAT THE MOTOR LIMIT TURNS OFF AT THE EXACT MOMENT THE AWNING BOX CLOSSES. FAILURE TO DO SO WILL CAUSE THE MOTOR TO RUN WHEN THE AWNING IS CLOSED. THIS WILL DESTROY THE MOTOR.**

1. The motors used in Girard Systems awnings are reversible.
2. The motor has limit settings for both OUT (extension) and IN (retraction).

3. The limit switches can be adjusted by use of the black key provided with the awning, or you may use a 4mm (5/32") Allen wrench.

4. Extend the awning a few feet to gain access to the motor. Locate the motor. The limit adjustment screws are located on the head of the motor. Using the symbols printed next to the adjustment screws, turn the black key (or 4mm Allen wrench) to make the necessary adjustments. The motors are labeled with a + or a - to indicate the adjustment direction.

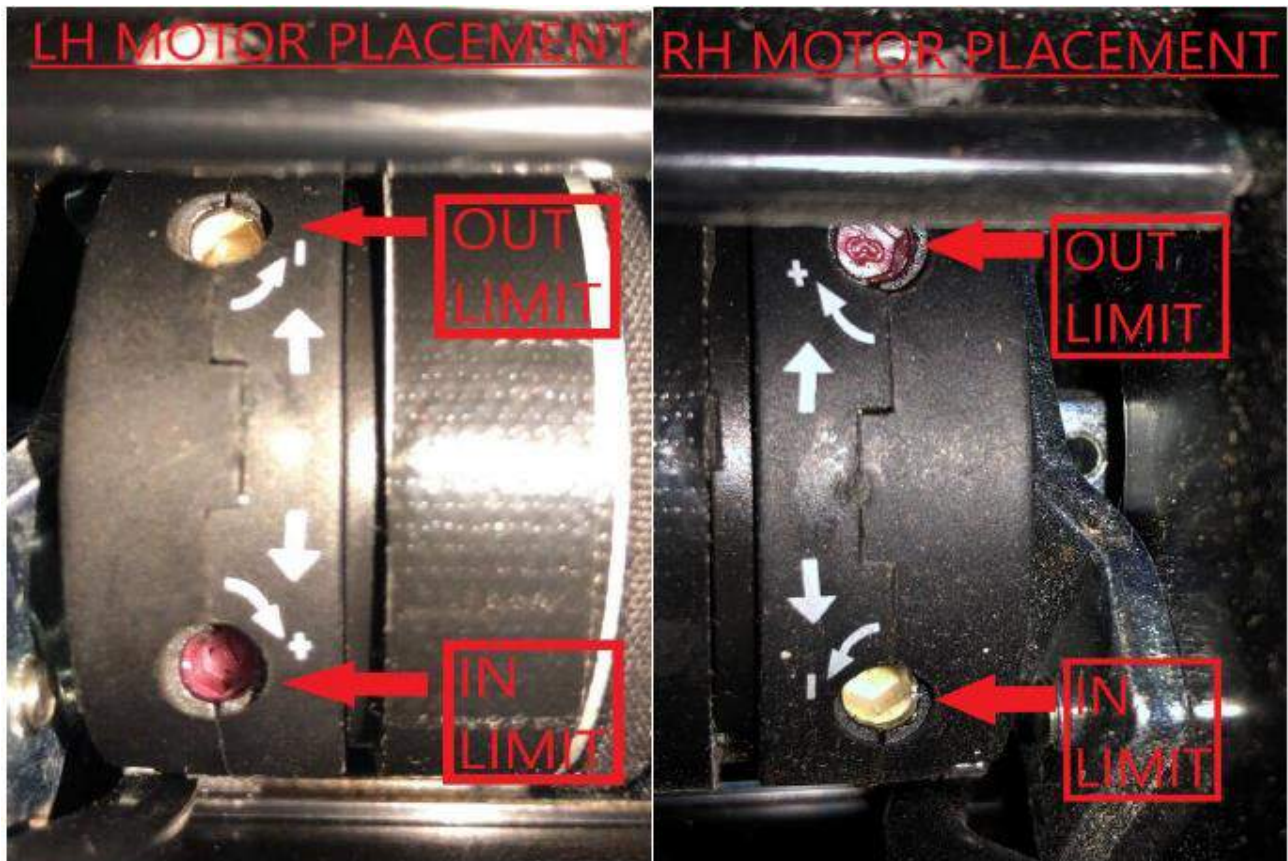

5. Approximately  $\frac{1}{4}$  turn of the adjustment screw represents about 1" of awning movement. NEVER set outward limits so that the fabric is slack with full arm extension. For proper adjustment set limit switch to stop the motor just before the arms lock. This will expose about a  $\frac{1}{4}$ " gap at the elbow.

## **B. MANUAL OVERRIDE**

1. In case of motor issues, the GG 1000 has a manual override to close the awning.
2. Remove the endcap opposite the motor, by removing the 3 phillips head screws.
3. Using a 13mm wrench, turn the manual override shaft in order to close the awning, see Figure 10.

NOTE: The manual override is one-way; it can only close the awning.

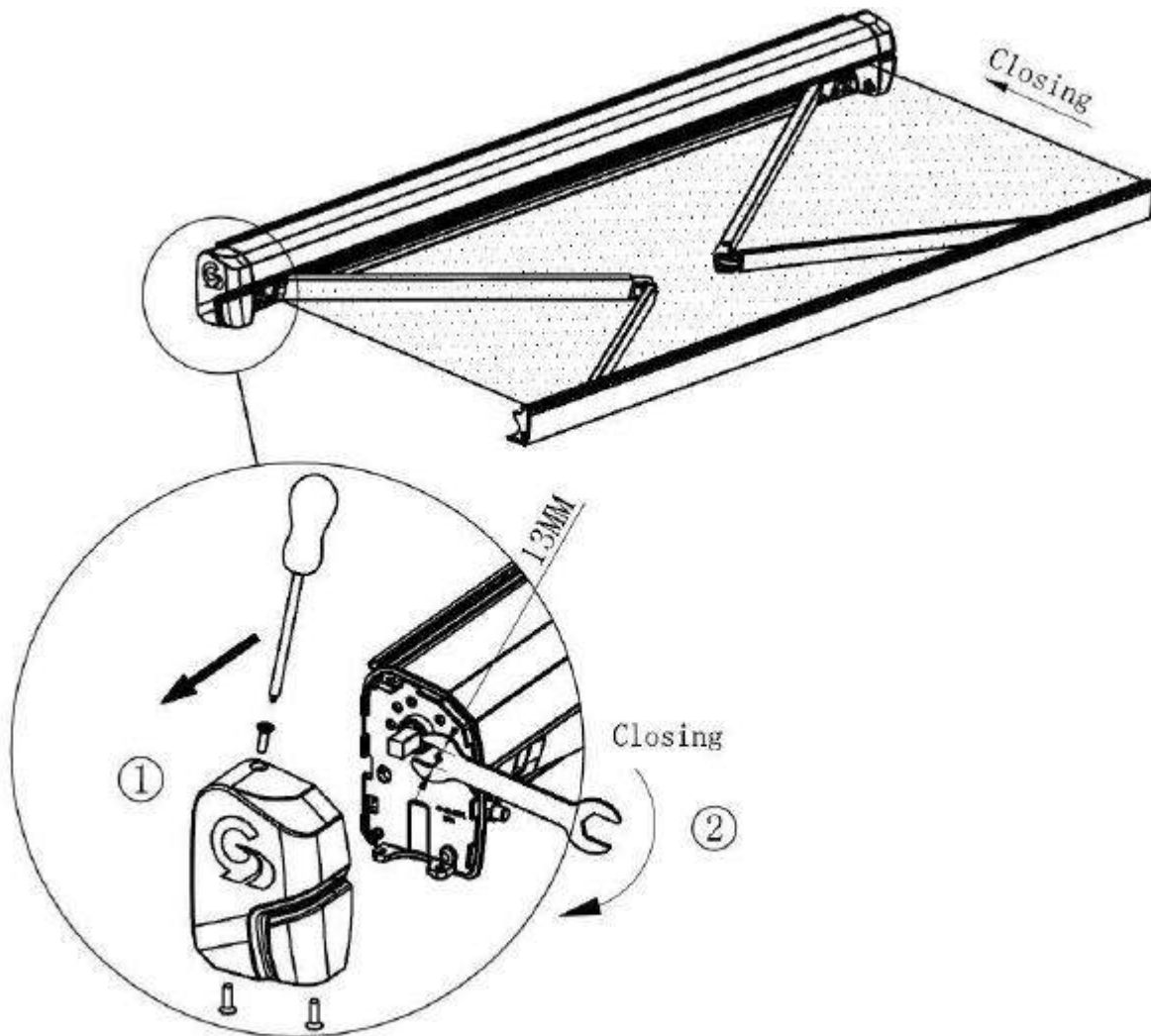

(Figure 10)

## C. ADJUSTING PITCH and ELBOW HEIGHT

**NOTE: Adjustment of the Elbow height and pitch, will affect the height of the awning lead rail when it is fully deployed.**

This adjustment is usually required after an arm replacement. Also, if the elbow of the arm hits the bottom of the casing as the lead rail closes.

### Tools Required

- 17mm open-end wrench
- 19mm (3/4") open-end wrench
- 4mm allen wrench

### 1. ELBOW HEIGHT

- Extend the awning about 12"
- Locate screw C located on the side of the shoulder, the top bolt. (Figure 11) Using a 17mm open-end wrench, rotate the bolt counter-clockwise to lower the arm position.
- Locate screw D located on the side of the shoulder, the lower bolt. (Figure 11) Using a 19mm open-end wrench, rotate the bolt clockwise to raise the arm position.
- Close the awning completely to ensure smooth operation, that the lead rail lies flush and square along the length of the cassette, and that the arms fit fold inside the cassette without interference.

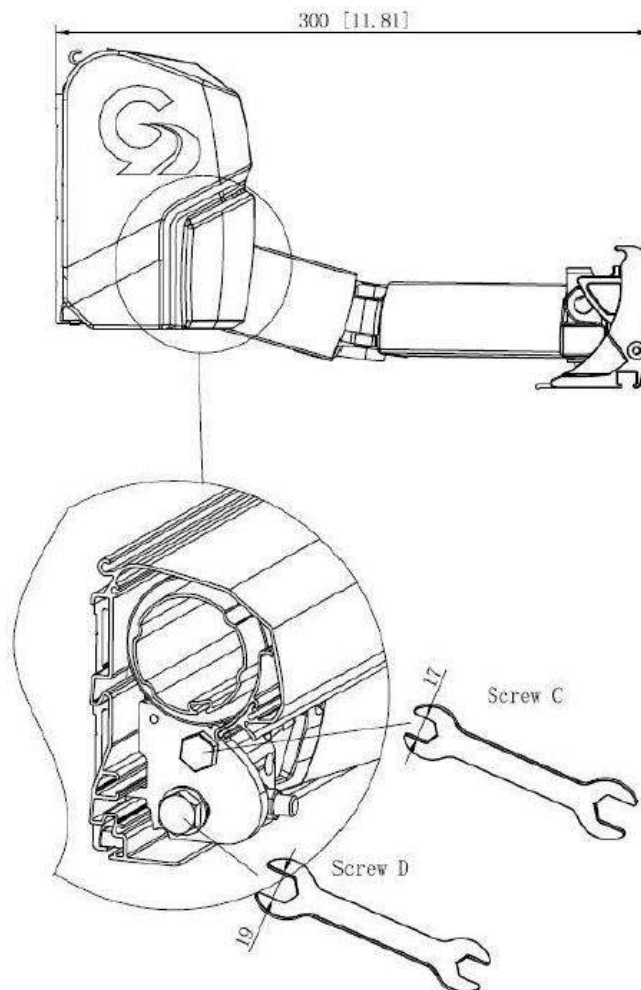

(Figure 11)

## 2. ADJUSTING PITCH

- a. Extend the awning to  $\frac{1}{4}$  of its fully extended length.
- b. Locate screw A, adjustment nut located on front side of the shoulder assembly (Figure 12, 13). Using a 17mm open-end wrench rotate the nut **counter-clockwise** to **lower** the pitch or **clockwise** to **raise** the pitch.

**DO NOT OVERTIGHTEN AS THIS WILL RESULT IN DAMAGE TO THE AWNING.**

- c. Close the awning completely to ensure smooth operation and that the lead rail lies flush and square along the length of the cassette.

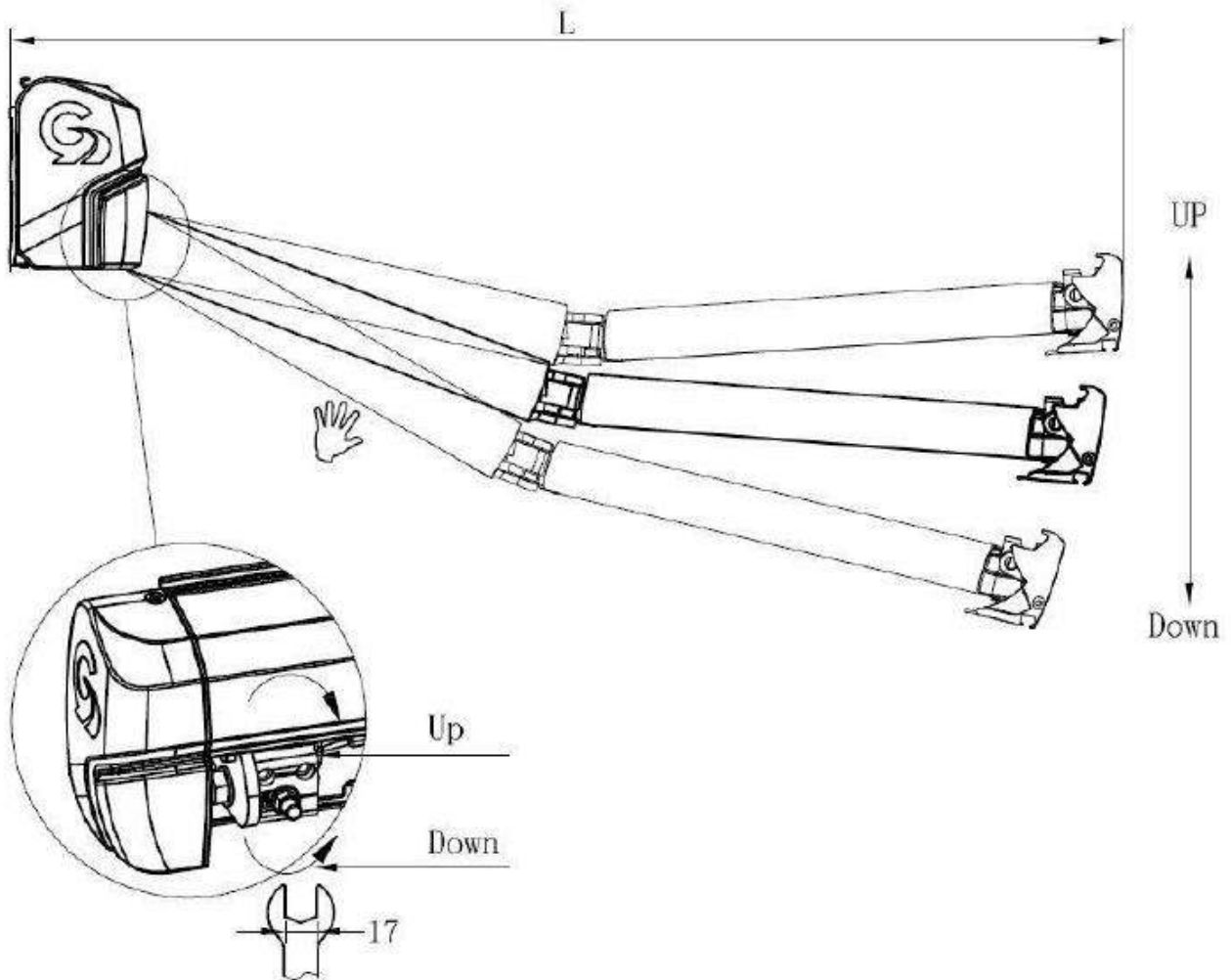

(Figure 12)

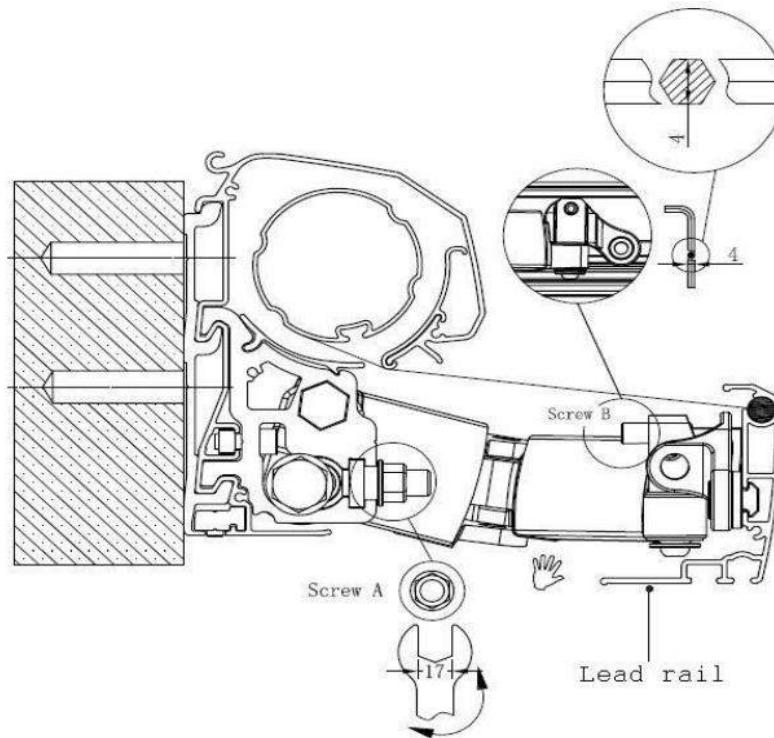

(Figure 13)

**D. TESTING THE MOTION SENSOR (Wind Sensor)**

1. Partially extend the awning (at least 3 feet).
2. Physically activate the motion sensor by shaking the awning lead rail.
3. At this point the awning should retract; if not, check that there is a 12VDC supply to the motion sensor and that the motion sensor is correctly programmed.

**NOTE:** The Motion sensor will send a retract signal to the motor of the awning it is programmed to on the RV. If there are multiple awnings extended that begin to retract simultaneously under windy conditions, the power system of the vehicle must be able to withstand the resulting surge of current. The surge will be the greatest when the awnings are fully extended. When testing the system verify all of the awnings will close when fully extended.

## VENTS

The kitchen, bathroom, and bedroom are all equipped with a 12VDC exhaust vent fan (Figure 14-3). A three-speed switch controls the fan speed of both. The vent fan should only be left in the “on” mode when the motorhome is parked and in use. The fan will not operate until the vent is open.

## DOORS

The primary entrance door to the motorhome has a key lock and a dead bolt for additional security. When the door is fully opened, the door hinge automatically holds the door in an “open” position. There is also a screen that allows increased air circulation when the entrance door is open.

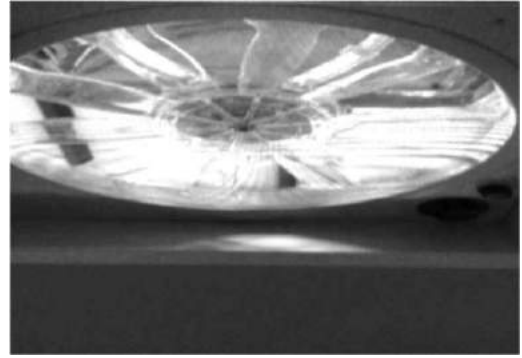
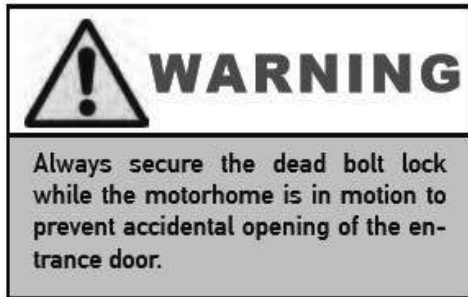

Figure 14-3: Overhead vent fan







*Wayfarer*

---

DRIVING YOUR MOTORHOME

CHAPTER

16

## SINGLE VISION CAMERA MONITOR SYSTEM

The rear-view monitoring system (Figure 15-1) is provided to aid the driver in backing and parking the motorhome.

A camera mounted on the rear of the vehicle feeds a televised view of the rear of the motorhome to the monitor located in the front near the driver. If the mode switch is in the “manual” mode, the monitor will be “on” when the ignition switch is turned “on.”

If the mode switch is in the “automatic” mode, the monitor will display the picture from the rear-mounted camera only when the transmission is in “reverse” gear. To use this system effectively, please consult the owner’s manual for this system. This manual is in the Owner’s Information Package.



Figure 15-1: Rear-view camera monitor

## AM / FM / CD STEREO SYSTEM

An AM/FM/CD stereo system is included in the motorhome.

This system is powered by the 12-volt DC system of the motorhome and operates like any conventional car-stereo system. The coach is also SIRIUS XM compatible with a subscription.



Figure 15-2: CD Player

## DASHBOARD HEATING / COOLING CONTROLS

The dash air conditioner/heater is not designed to heat and cool the entire interior of the motorhome. It is intended only to provide heating and cooling for the cab area. A small amount of air will blow out of all of the defrost and dash vents regardless of the mode settings.



Figure 15-3: Dashboard controls



# *Wayfarer*

---

ROUTINE MAINTENANCE

CHAPTER

17

## NOTICE

Damage caused by improperly performed maintenance or inadequate maintenance is not covered by your Tiffin Motorhomes limited warranty.

### WASHING



The paint on your Tiffin motorhome has a polyurethane base called Diamont. While multiple layers of clear coat sealants protect the paint against oxidation, the sealant must be protected from deterioration.

Paint manufacturers advise against using harsh cleaners such as Simple Green, Mr. Clean, or liquid dish washing soaps. The degreasing agents in these cleaners leave a residue on the sealant, which softens and damages the clear coat in time.

Baby shampoo provides an effective yet gentle cleaner. Without the typical heavy degreasers of most detergents, baby shampoo cleans without leaving a residue to gum up the clear coat finish. Usually one ounce (1 oz.) is all you need per five gallons of water. Add one cup of food grade distilled white vinegar to your wash bucket.

Tiffin Motorhomes recommends the lamb's wool pad sold by Mary Moppins. This allows you to safely wash your coach from the ground by placing the pad on an extension.

Do not mistake lamb's wool with imitations. Imitation pads are made from 100% polyester, which is plastic. Plastic imitations will scratch the finish of the motorhome. For this same reason avoid microfiber products to wash or dry your motorhome, car, boat, airplane, motorcycle, vehicle, furniture, or cabinets. Microfiber is made from 80% polyester.

Avoid washing with brushes. Even though you may not see brush marks now, the damage will happen as the bristles wear down.

Use only 100% cotton towels to dry your vehicle. Adding vinegar to your wash water and washing in the morning or evening will help prevent water spots. Water spots damage the exterior of your coach the same way they damage glass shower doors. They etch their way into the surface and removal becomes difficult. Prevention becomes the key.

Wash one side at a time, rinse, and then dry quickly using a squeegee followed by a towel placed over the cleaning head.

To remove oil and grease remember an important rule of cleaning: Give your product time to work. Dab a bit of concentrated cleaner like CleanEz by Mary Moppins—never an orange based cleaner or one with petroleum distillates—onto a soft cloth. Apply to the oil spot and wait 10 to 15 minutes before rubbing lightly to remove the oil. Rinse immediately.

## SEALS

The seals around the doors, windows, vents, slide-out trim, and external seams should be checked at least semi-annually. Additionally, the roof seams should be inspected for cracking or peeling semiannually. If deterioration is noted during a routine maintenance inspection, reseal the seams or seals with an approved sealant to prevent leaks.

Your Tiffin Motorhomes dealer can perform resealing inspections and subsequent work for you. It is recommended that a Tiffin Motorhomes authorized service center perform these inspections periodically and perform necessary resealing when necessary.

## PROPER SEALANTS FOR APPLICATION

The following sealants are recommended for specific sealing applications, as noted in the table. These can be purchased through the Tiffin Motorhomes parts and service department by calling 205-487-4710.

Recommended sealants for specific sealing applications	
SEALANT	APPLICATION
Plas-T-Code	Metal or fiberglass roof
Surebond #SB-140	Rubber laminated to metal roof and ALL SKYLIGHTS
Carlisle #502-LSW self leveling sealant	Rubber roof over wood base
Silicone sealant	To cover butyl and other sealants; not to be used as the main sealant
Parbond	To seal across tops of windows on exterior surfaces where silicone is not used

#### WHEEL CARE

The care and maintenance of your wheels are simple and require no special material or products; simply follow the directions included in the Owner's Information Package for these. Timely care and cleaning will maintain the appearance of these wheel products for many years.



#### ROOF CARE & MAINTANENCE

Proper care and maintenance of your motorhome, including your roof, is important for sustained, trouble-free performance. Normal maintenance is simple and easy and does not require special materials. The roof of the motorhome is fiberglass and can be cared for in the conventional manner. Clean the roof at least every three months. The roof should be professionally inspected by a dealer annually.



#### MOISTURE MANAGEMENT

This section outlines important recommendations to manage moisture in your motorhome to avoid moisture-related damage, such as mold. The materials and methods used to construct your motorhome were selected in part to minimize air leakage and to create a weather tight exterior shell. However, in order to protect your investment and reduce the risk of moisture-related damage and costly repairs, attention and care has to be taken to manage moisture inside your RV.

Note: These are only suggestions intended to minimize moisture-related issues with your motorhome. If any concerns arise, contact Tiffin Motorhomes' Service Department at (205)487-4710.

#### INTERIOR CARE FOR YOUR RV

Signs of excessive moisture can be obvious, such as water droplets forming on surfaces or wet carpet. Conversely, signs of excess moisture can be subtle, such as condensation forming on metal surfaces. When symptoms appear, it is important to immediately determine the cause of the excess moisture and take appropriate corrective action to prevent moisture related damage.

#### CONTROL RELATIVE HUMIDITY

Monitoring and controlling relative humidity within the motorhome is one of the most important steps to minimize the risk for moisture-related damage. Ideally, relative humidity should be at 60% or less. Relative humidity can be monitored utilizing a portable hygrometer, which is a small device that measures temperature and relative humidity.

Use exhaust fans, the air conditioner, and/or a portable dehumidifier to manage moisture inside the RV to maintain relative humidity at 60% or less. In cold climates, relative humidity may need to be at 35% or less to avoid window condensation issues. If the motorhome is used the majority of the time in a hot, humid climate, it may be difficult to keep relative humidity below 60%. A dehumidifier will help, but is important to check the condensation (water) collection bucket regularly or discharge the condensation (water) directly to a drain.

#### AVOID DRASTIC THERMOSTAT SETBACKS

To minimize the opportunity for condensation to form on interior surfaces, maintain a comfortable temperature in your RV, and avoid nighttime setbacks of 10 degrees or more. Drastic setbacks that reduce the indoor air temperature quickly can increase the chance for airborne moisture to condense on cool surfaces such as windows. If you are away from your RV for an extended number of days, it is

recommended that you do not set the temperature back without taking other measures to manage relative humidity, including operating a dehumidifier with a continuous drain.

#### MANAGE WINDOW CONDENSATION

Window condensation issues can be identified by water or ice-build up, usually at the base of the window. The majority of these problems can be addressed by managing moisture generated inside the motorhome. Minor condensation issues are not unusual, especially for RVs used in colder climates. To help minimize window condensation, use exhaust fans vented to the outside, avoid drastic changes in thermostat settings, do not use “vent-free” heaters and use window coverings wisely. For example, make sure to open curtains or blinds during the day to allow air to circulate and warm the window surface.

#### CARPET CARE AND MOISTURE MANAGEMENT

The carpet should be cleaned when it shows signs of discoloration or traffic patterns. A steam cleaning system should be used to clean the carpet unless other noted in your warranty information. To manage moisture from the cleaning process, the cleaning system needs to be capable of extracting the excess water from the carpet after it has been cleaned. Important: Be sure the carpet is thoroughly dry before closing up the RV for storage. Water from the cleaning process can cause significant damage to the RV if the carpet is not completely dry before closing up the motorhome for an extended period.

#### CLEANING TILE

Most floors only require a mild detergent and warm water for cleaning. More water on the floor is not always better for cleaning. Use a damp cloth to clean on a regular basis rather than wet mopping each time.

#### STORAGE AND OTHER ISOLATED AREAS IN THE RV

Storage areas are more difficult to condition since the areas are isolated from the main body of the RV. The surfaces of these areas are more at risk for condensation and surface mold growth. To minimize this risk, clean storage areas regularly, and allow an air space between stored items and the exterior wall to promote air circulation.

#### USE OF UN-VENTED COMBUSTION EQUIPMENT

Un-vented combustion equipment, such as propane stovetops are a source of moisture within the RV. For every gallon of fuel consumed, approximately one gallon of water vapor is evaporated into the air. Whenever possible, operate an exhaust fan in combination with the use of any un-vented combustion appliance within the RV. Water vapor and other combustion byproducts should be vented to the exterior of the RV. The RV owner should strictly follow use and maintenance instructions for safe operation of any combustion equipment, particularly un-vented equipment.

#### EXTERIOR CARE OF YOUR RV

The exterior shell of the RV is the primary weather and moisture barrier. Over the life of the vehicle, the shell will require regular care and maintenance in accordance with other instructions for exterior care. The shell includes the roof, sidewalls, windows, doors, and under-floor of the vehicle. Particular attention needs to be devoted to ensure these components are maintained to ensure a tight barrier against bulk water intrusion. The shell should be inspected periodically for tears, gaps, and condition of sealants in accordance with this owner’s manual. Areas that require maintenance should be resealed utilizing a similar, high quality sealant used by the manufacturer. Particular attention should be devoted to ensure the slide outs are functioning properly. Each time a slide out is used it should be inspected to ensure



proper operation and sealing. The slide out gaskets should also be inspected to ensure proper sealing when the slide out is operated.

### USE OF YOUR RV

It is important to remember that the square footage of an RV is significantly less than that of a single family residence. This fact alone will elevate the relative humidity because there is less volume of air to help absorb or dissipate the humidity. For example, showering and cooking create a lot of humidity in a small area. In these instances, use of an exhaust fan and opening windows should reduce the relative humidity, particularly when living in the RV for an extended period.

### SEVERE ENVIRONMENTS

Prolonged use of your RV in severe environments—for example in extremely cold or hot-humid climates, will require extra care and maintenance to avoid moisture-related issues. In both extremely cold and hot humid climates more attention needs to be focused on controlling relative humidity within the RV. It also may require the use of a portable dehumidifier to manage relative humidity within an acceptable range.

### STORAGE OF YOUR RV

During those periods when your motorhome is not in use, care must be taken to ensure moisture sources are addressed. Ideal storage of your RV would be in an enclosed climate controlled environment. When this is not possible, the following steps should be taken to ensure moisture is controlled:

- Turn off all water sources.
- Turn off all combustion appliances.
- Drain the water tank(s)
- Drain the water heater.
- Open all closets, cabinet doors and drawers.
- Close all windows and entrance doors.
- Open a vent or a window enough to allow for some limited ventilation air flow, but not so far as to allow snow or rain to enter.
- When storing the RV in high humidity climates, add a dehumidifier drained to exterior to control humidity inside the RV during storage.
- Refer to other sections of this owner's manual for additional recommendations.

### MODIFICATIONS TO YOUR RV

Consult Tiffin Motorhomes for guidance prior to making any modifications to your RV. It is important that changes be completed by a qualified service firm to ensure moisture intrusion or accumulation problems do not occur.

### WET AREAS

Areas that are exposed to water spills or leaks should be dried as soon as possible and definitely within 24 to 48 hours. Drying areas quickly minimizes the chance for moisture damage and possible mold growth, which can begin to form colonies within 48 hours. A variety of methods can be used to help the drying process:

- Remove excess water with an extraction vacuum
- Use a dehumidifier to aid drying
- Use portable fans to move air across the surface

- Because moisture is key to mold issues, treat all signs of condensation and spills seriously and deal with promptly. Failure to deal with a moisture issue promptly may cause more severe issues where none initially existed, or may make a small problem much worse.
- Learn to recognize signs of mold—don't paint over or cover up suspicious discoloration until you are sure it is not mold. The affected surface must first be cleaned and dried; residual staining may be painted.
- Be sure to understand and eliminate the source of moisture accumulation as a part of the cleanup. Otherwise, the same issues will simply reoccur.
  - Small amounts of mold should be cleaned as soon as it appears. Small areas of mold should be cleaned using a detergent/soapy solution or an appropriate RV household cleaner. Gloves should be worn during cleaning. The cleaned area should then be thoroughly dried. Dispose of any sponges or rags used to clean mold.

#### TIRE & SAFETY INFORMATION

This portion of the Owner's Manual contains tire safety information as required by 49 CFR 575.6. The National Traffic Safety Administration (NHTSA) can be contacted at 1-888-327-4236. Their web site is <http://www.safercar.gov> and their address is: NHTSA, 400 Seventh St, S.W., Washington, D.C. 20590.

#### SECTION ONE:

The National Traffic Safety (NHTSA) has published a brochure (DOT HS 809 361) that discusses all aspects of Tire Safety, as required by CFR 575.6. This brochure is reproduced in part below. It can be obtained and downloaded from NHTSA, free of charge, from the following web site:

[http://www.nhtsa.dot.gov/cars/rules/TireSafety/ridesonit/tires\\_index.html](http://www.nhtsa.dot.gov/cars/rules/TireSafety/ridesonit/tires_index.html)

Studies of tire safety show that maintaining proper tire pressure, observing tire and vehicle load limits, avoiding road hazards, and inspecting tires for cuts, slashes, and other irregularities are the most important things you can do to avoid tire failure, such as tread separation or blowout and flat tires. These actions, along with other care and maintenance activities, can also:

- Improve vehicle handling
- Help protect you and others from avoidable breakdowns and accidents
- Improve fuel economy
- Increase the life of your tires

This section presents a comprehensive overview of tire safety, including information on the following topics:

- Basic tire maintenance
- Uniform Tire Quality Grading System
- Fundamental characteristics of tires
- Tire safety tips

Use this information to make tire safety a regular part of your vehicle maintenance routine. Recognize that the time you spend is minimal compared with the inconvenience and safety consequences of a flat tire or other tire failure.

#### Safety First-Basic Tire Maintenance

Properly maintained tires improve the steering, stopping, traction, and load-carrying capability of your vehicle. Under-inflated tires and overloaded vehicles are a major cause of tire failure. Therefore, as mentioned above, to avoid flat tires and other types of tire failure, you should maintain proper tire pressure, observe tire and vehicle load limits, avoid road hazards, and regularly inspect your tires.

## Finding Your Vehicle's Recommended Tire Pressure and Load Limits

Tire information placards and vehicle certification labels contain information on tires and load limits. These labels indicate the vehicle manufacturer's information including:

- Recommended tire size
- Recommended tire inflation pressure
- Vehicle capacity weight (VCW—the maximum occupant and cargo weight a vehicle is designed to carry)
  - Front and rear gross axle weight ratings (GAWR—the maximum weight the axle systems are designed to carry)

### UNDERSTANDING TIRE PRESSURE AND LOAD LIMITS

Tire inflation pressure is the level of air in the tire that provides it with load-carrying capacity and affects the overall performance of the vehicle. The tire inflation pressure is a number that indicates the amount of air pressure—measured in pounds per square inch (psi)—a tire requires to be properly inflated. (You will also find this number on the vehicle information placard expressed in kilopascals (kPa), which is the metric measure used internationally).

Vehicle manufacturers determine this number based on the vehicle's design load limit, that is, the greatest amount of weight a vehicle can safely carry and the vehicle's tire size. The proper tire pressure for your vehicle is referred to as the "recommended cold inflation pressure." Because tires are designed to be used on more than one type of vehicle, tire manufacturers list the "maximum permissible inflation pressure" on the tire sidewall. This number is the greatest amount of air pressure that should ever be put in the tire under normal driving conditions.

### CHECKING TIRE PRESSURE

It is important to check your vehicle's tire pressure at least once a month for the following reasons:

- Most tires may naturally lose air over time
- Tires can lose air suddenly if you drive over a pothole or other object or if you strike the curb when parking
- With radial tires, it is usually not possible to determine under-inflation by visual inspection for convenience, purchase a tire pressure gauge to keep in your vehicle. Gauges can be purchased at tire dealerships, auto supply stores, and other retail outlets.

The recommended tire inflation pressure that vehicle manufacturers provide reflects the proper psi when a tire is cold. The term cold does not relate to the outside temperature. Rather, a cold tire is one that has not been driven on for at least three hours. When you drive, your tires get warmer, causing the air pressure within them to increase. Therefore, to get an accurate tire pressure reading, you must measure tire pressure when the tires are cold or compensate for the extra pressure in warm tires.

### STEPS FOR MAINTAINING PROPER TIRE PRESSURE

- Step 1: Locate the recommended tire pressure on the vehicle's tire information placard, certification label, or in the owner's manual
- Step 2: Record the tire pressure of all tires
- Step 3: If the tire pressure is too high in any of the tires, slowly release air by gently pressing on the tire valve stem with the edge of your tire gauge until you get to the correct pressure
- Step 4: If the tire pressure is too low, note the difference between the measured tire pressure and correct tire pressure. These "missing" pounds of pressure are what you will need to add
- Step 5: At a service station, add the missing pounds of air pressure to each tire that is under inflated
- Step 6: Check all the tires to make sure they have the same air pressure (except in cases in which the front and rear tires are supposed to have different amounts of pressure)

If you have been driving your vehicle and think that a tire is under-inflated, fill it to the recommended cold inflation pressure indicated on your vehicle's tire information placard or certification label. While your tire may still be slightly under-inflated due to the extra pounds of pressure in the warm tire, it is safer to drive with air pressure that is slightly lower than the vehicle manufacturer's recommended cold inflation pressure than to drive with a significantly under-inflated tire. Since this is a temporary fix, don't forget to recheck and adjust the tire's pressure when you can obtain a cold reading.

#### TIRE SIZE

To maintain tire safety, purchase new tires that are the same size as the vehicle's original tires or another size recommended by the manufacturer. Look at the tire information placard, the owner's manual, or the sidewall of the tire you are replacing to find this information. If you have any doubt about the correct size to choose, consult with the tire dealer.

#### TIRE TREAD

The tire tread provides the gripping action and traction that prevent your vehicle from slipping or sliding, especially when the road is wet or icy. In general, tires are not safe and should be replaced when the tread is worn down to 1/16 of an inch. Tires have built-in tread-wear indicators that let you know when it is time to replace your tires. These indicators are raised sections spaced intermittently in the bottom of the tread grooves. When they appear "even" with the outside of the tread, it is time to replace your tires. Another method for checking tread depth is to place a penny in the tread with Lincoln's head upside down and facing you. If you can see the top of Lincoln's head, you are ready for new tires.

#### TIRE BALANCE AND WHEEL ALIGNMENT

To avoid vibration or shaking of the vehicle when a tire rotates, the tire must be properly balanced. This balance is achieved by positioning weights on the wheel to counterbalance heavy spots on the wheel and tire assembly. A wheel alignment adjusts the angles of the wheels so that they are positioned correctly relative to the vehicle's frame. This adjustment maximizes the life of your tires. These adjustments require special equipment and should be performed by a qualified technician.

#### TIRE ROTATION

Rotating tires from front to back and from side to side can reduce irregular wear (for vehicles that have tires that are all the same size). Look in your owner's manual for information on how frequently the tires on your vehicle should be rotated and the best pattern for rotation.

#### Tire Repair

The proper repair of a punctured tire requires a plug for the hole and a patch for the area inside the tire surrounds the puncture hole. Punctures through the tread can be repaired if they are not too large, but punctures to the sidewall should not be repaired. Tires must be removed from the rim to be properly inspected before being plugged and patched.

#### A Tire Rotation Example

Please refer to Mercedes Sprinter Manual provided in the Owner's Information Package.



**Speed Rating**—The speed rating denotes the speed at which a tire is designed to be driven for extended periods of time.

**U.S. DOT Tire Identification Number**—This begins with the letters “DOT” and indicates that the tire meets all federal standards. The next two numbers or letters are the plant code where it was manufactured, and the last four numbers represent the week and year the tire was built. For example, the numbers 1612 means the 16th week of 2012. The other numbers are marketing codes used at the manufacturer’s discretion. This information is used to contact customers if a tire defect requires a recall.

**Tire Ply Composition and Materials Used**—The number of plies indicates the number of layers of rubber-coated fabric in the tire. In general, the greater the number of plies, the more weight a tire can support. Tire manufacturers also must indicate the materials in the tire, which include steel, nylon, polyester, and others.

**Maximum Load Rating**—This number indicates the maximum load in kilograms and pounds that can be carried by a tire

**Maximum Permissible Inflation Pressure**—This number is the greatest amount of air pressure that should never be put in tire under normal driving conditions.

### Vehicle Load Limits

Determining the load limits of a vehicle includes more than understanding the load limits of the tires alone. On a motorhome, there is a federal certification label that is affixed in the rear closet. The certification label will indicate the vehicle’s gross vehicle weight rating (GVWR). This is the most weight the fully loaded vehicle can weigh. It will also provide the gross axle weight rating (GAWR).

This is the most a particular axle can weigh. If there are multiple axles, the GAWR of each axle will be provided. For motorhomes, in the same location as the certification label described above, there is a vehicle placard in the entry door frame. This placard provides tire and loading information. In addition, this placard will show the vehicle’s seating capacity for people and a statement regarding maximum cargo capacity.

### Cargo Capacities

For motorhomes, cargo can be added to the vehicle, up to the maximum weight specified on the placard. For motorized vehicles, the combined weight of passengers and cargo is provided as a single number. If fewer people are traveling, more cargo can be added. If more people are involved, the weight of cargo must be reduced. In any case, remember: the total weight of a fully loaded vehicle, including passengers, cannot exceed the stated GVWR.

For motorhomes, the water and propane also need to be considered. The weight of fully filled propane containers is considered part of the weight of the RV before it is loaded with people or cargo and is not considered part of the disposable cargo load. Water, however, is a cargo weight and is treated as such. If there is a fresh water storage tank of 50 gallons, this tank when filled would weigh about 400 pounds. If more cargo or people are being transported, water can be off-loaded to keep the total amount of cargo added to the vehicle within the limits of the GVWR so as not to overload the vehicle.

Understanding this flexibility will allow you to make choices that fit your travel and camping needs. When loading your cargo, be sure it is distributed evenly to prevent overloading front to back and side to side. Heavy items should be placed low and as close to the axle positions as reasonable. Too many items on one side may overload a tire.

The best way to know the actual weight of the vehicle is to weigh it at a certified public scale. Talk to your RV dealer to discuss the weighing methods needed to determine the various weights related to the RV. This would include weights for the following: axles, wheels, hitch and total weight.

### How Overloading Affects Your RV and Tires

The results of overloading can have serious consequences for passenger safety. Too much weight on your vehicle's suspension system can cause spring, shock absorber, or brake failure, handling or steering problems, irregular tire wear, tire failure or other damage.

An overloaded vehicle is hard to drive and hard to stop. In cases of serious overloading, brakes can fail completely, particularly on steep hills. The load a tire will safely carry is a combination of the size of tire, its load range, and corresponding inflation pressure.

Excessive loads and/or under-inflation cause tire overloading and, as a result, abnormal tire flexing occurs. This situation can generate an excessive amount of heat within the tire. Excessive heat may lead to tire wear and eventually tire failure.

It is the air pressure that enables a tire to support the load, so proper inflation is critical. Since RVs can be configured and loaded in many ways, air pressures must be determined from actual loads (determined by weighing) and taken from the load and inflation tables provided by the tire manufacturer. These air pressures may differ from those found on the certification label. However, they should never exceed the tire limitation for load or air pressure.

### Tire Safety Tips

#### Preventing Tire Damage

- Slow down if you have to go over a pothole or other object in the road.
- Do not run over curbs or other foreign objects in the roadway, and try not to strike the curb when parking.

#### Tire Safety Checklist

- Check tire pressure regularly (at least once a month), including the spare.
- Inspect tires for uneven wear patterns on the tread, cracks, foreign objects, or other signs of wear or trauma.
- Remove bits of glass and foreign objects wedged in the tread.
- Make sure your tire valves have valve caps.
- Check tire pressure before going on a long trip.
- Do not overload your vehicle. Check the Tire Information and Loading Placard or User's Manual for the maximum recommended load for the vehicle.

Section Two:  
Steps for Determining Correct Load Limit

1. Locate the statement “The combined weight of occupants and cargo should never exceed XXX lbs” on your vehicles placard.
2. Determine the combined weight of the driver and passengers that will be riding in your vehicle.
3. Subtract the combined weight of the driver and passengers from XXX kilograms or XXX pounds.
4. The resulting figure equals the available amount of cargo and luggage capacity. For example, if the “XXX” equals 1400 lbs. and there will be five 150 lb. passengers in your vehicle, the amount of available cargo and luggage capacity is 650 lbs. (1400-750 (5 x 150) = 650 lbs.)
5. Determine the combined weight of luggage and cargo being loaded on the vehicle. That weight may not safely exceed the available cargo and luggage capacity calculated in Step #4.
6. If your vehicle will be towing a trailer, load from your trailer will be transferred to your vehicle. Consult this section to determine how this reduces the available cargo and luggage capacity of your vehicle.

Section Three:

Glossary of Tire Terminology

Accessory weight—The combined weight (in excess of those standard items which may be replaced) of automatic transmission, power steering, power brakes, power windows, power seats, radio and heater, to the extent that these items are available as factory-installed equipment (whether installed or not).

Bead—The part of the tire that is made of steel wires, wrapped or reinforced by ply cords and that is shaped to fit the rim.

Bead separation—This is the breakdown of the bond between components in the bead.

Bias ply tire—A pneumatic tire in which the ply cords that extend to the beads are laid at alternate angles substantially less than 90 degrees to the centerline of the tread.

Carcass—The tire structure, except tread and sidewall rubber which, when inflated, bears the load.

Chunking—The breaking away of pieces of the tread or sidewall.

Cold inflation pressure—The pressure in the tire before you drive.

Cord—The strands forming the plies in the tire.

Cord separation—The parting of cords from adjacent rubber compounds.

Cracking—Any parting within the tread, sidewall, or inner liner of the tire extending to cord material.



CT—A pneumatic tire with an inverted flange tire and rim system in which the rim is designed with rim flanges pointed radially inward and the tire is designed to fit on the underside of the rim in a manner that encloses the rim flanges inside the air cavity of the tire.

Curb weight—The weight of a motor vehicle with standard equipment including the maximum capacity of fuel, oil, and coolant, and, if so equipped, air conditioning and additional weight optional engine.

Extra load tire—A tire designed to operate at higher loads and at higher inflation pressures than the corresponding standard tire.

Groove—The space between two adjacent tread ribs.

Gross Vehicle Weight Rating (GVWR)—The maximum permissible weight of this fully loaded motorhome.

Gross Axle Weight Rating (GAWR)—The value specified as the load carrying capacity of a single axle system, as measured at the tire-ground interfaces.

Hitch Weight—The vertical trailer load supported by the hitch ball.

Inner liner separation—The parting of the inner liner from cord material in the carcass.

Intended outboard sidewall—The sidewall that contains a white-wall, bears white lettering or bears manufacturer, brand, and /or model name molding that is higher or deeper than the same molding on the other sidewall of the tire or the outward facing sidewall of an asymmetrical tire that has a particular side that must always face outward when mounted on a vehicle.

Light truck (LT) tire—A tire designated by its manufacturer as primarily intended for use on lightweight trucks or multipurpose passenger vehicles.

Load rating—The maximum load that a tire is rated to carry for a given inflation pressure. Maximum load rating—The load rating for a tire at the maximum permissible inflation pressure for that tire.

Maximum permissible inflation pressure—The maximum cold inflation pressure to which a tire may be inflated.

Maximum loaded vehicle weight—The sum of curb weight, accessory weight, vehicle capacity weight, and production options weight.

Measuring rim—The rim on which a tire is fitted for physical dimension requirements.

Non-pneumatic rim—A mechanical device which, when a non-pneumatic tire assembly incorporates a wheel, supports the tire, and attaches, either integrally or separable, to the wheel center member and upon which the tire is attached.

Non-pneumatic tire assembly—A non-pneumatic tire, alone or in combination with a wheel or wheel center member, which can be mounted on a vehicle.

Normal occupant weight—This means 68 kilograms (150 lbs.) times the number of occupants specified in the second column of Table I of 49 CFR 571.110.

Occupant distribution—The distribution of occupants in a vehicle as specified in the third column of Table I of 49 CFR 571.110.

Open splice—Any parting at any junction of tread, sidewall, or inner liner that extends to cord material.

Outer diameter—The overall diameter of an inflated new tire.

Overall width—The linear distance between the exteriors of the sidewalls of an inflated tire, including elevations due to labeling, decorations, or protective bands or ribs.

Pin Weight—The vertical trailer load supported by the king pin of a fifth wheel hitch.

Ply—A layer of rubber-coated parallel cords.

Ply separation—A parting of rubber compound between adjacent plies.

Pneumatic tire—A mechanical device made of rubber, chemicals, fabric and steel or other materials that, when mounted on an automotive wheel, provides the traction and contains the gas or fluid that sustains the load.

Production options weight—The combined weight of those installed regular production options weighing over 2.3 kilograms (5 lbs.) in excess of those standard items which they replace, not previously considered in curb weight or accessory weight, including heavy duty brakes, ride levelers, roof rack, heavy duty battery, and special trim.

Radial ply tire—A pneumatic tire in which the ply cords that extend to the beads are laid at substantially 90 degrees to the centerline of the tread.

Recommended inflation pressure—This is the inflation pressure provided by the vehicle manufacturer on the Tire Information label and on the Certification/ VIN tag.

Reinforced tire—A tire designed to operate at higher loads and at higher inflation pressures than the corresponding standard tire.

Rim—A metal support for a tire or a tire and tube assembly upon which the tire beads are seated.

Rim diameter—This means the nominal diameter of the bead seat.

Rim size designation—This means the rim diameter and width.

Rim type designation—This means the industry of manufacturer's designation for a rim by style or code.

Rim width—This means the nominal distance between rim flanges.

Section width—The linear distance between the exteriors of the sidewalls of an inflated tire, excluding elevations due to labeling, decoration, or protective bands.

Sidewall—That portion of a tire between the tread and bead.

Sidewall separation—The parting of the rubber compound from the cord material in the sidewall.

Test rim—The rim on which a tire is fitted for testing, and may be any rim listed as appropriate for use with that tire.

Tread—That portion of a tire that comes into contact with the road.

Tread rib—A tread section running circumferentially around a tire.

Tread separation—Pulling away of the tread from the tire carcass.

Tread wear indicators (TWI)—The projections within the principal grooves designed to give a visual indication of the degrees of wear of the tread.

Vehicle capacity weight—The rated cargo and luggage load plus 68 kilograms (150 lbs.) times the vehicle's designated seating capacity.

Vehicle maximum load on the tire—The load on an individual tire that is determined by distributing to each axle its share of the maximum loaded vehicle weight and dividing by two.

Vehicle normal load on the tire—The load on an individual tire that is determined by distributing to each axle its share of the curb weight, accessory weight, and normal occupant weight (distributed in accordance with Table I of CFR 49 571.110) and dividing by 2.

Weather side—The surface area of the rim not covered by the inflated tire.

Wheel center member—In the case of a non-pneumatic tire assembly incorporating a wheel, a mechanical device which attached, either integrally or separable, to the non-pneumatic rim and provides the connection between the non-pneumatic rim and the vehicle; or, in the case of a no pneumatic tire assembly not incorporating a wheel, a mechanical device which attaches, either integrally or separable, to the non-pneumatic tire and provides the connection between tire and the vehicle.

#### Tire Pressure

Correct tire inflation pressure is essential to maximizing the life of the tires and assuring the safety of the vehicle and its occupants. Driving with tires that are not correctly inflated for the load of the motorhome is dangerous and may cause premature wear, tire damage, and/or loss of control of the motorhome.

An underinflated tire will build up excessive heat that may actually approach the vulcanization temperature of the rubber and lead to tread separation and/or disintegration of the tire.

Underinflated tires will also cause poor handling of the motorhome, rapid and/or irregular tire wear, and an increase in rolling resistance of the motorhome which, in turn, produces a decrease in fuel economy of operation.

An overinflated tire will reduce the tire's "footprint" (i.e., its actual contact with the road); thus, reducing the traction, braking capacity, and handling of the motorhome. A tire that is over-inflated for the load that it is carrying will also contribute to a harsh ride, uneven tire wear, and the tire itself will be more susceptible to impact damage.

Maintaining correct tire pressure for each loaded wheel position on the motorhome is critically important and must be a part of regular vehicle maintenance.

#### Tire Maximum Load Rating

Federal law requires that the maximum load rating be molded into the sidewall of the tire. If you look at a tire sidewall, you may see some "typical" information, such as:

Max. Load Single 2,880 Lbs. at 61 psi cold

Max. Load Dual 2,470 Lbs. at 61 psi cold

The maximum load allowed for the size tire and load rating and the minimum cold air-inflation pressure needed to carry that stated maximum load are noted on the tire. Using less air pressure would reduce the load-carrying capacity of the tire.

The amount of air pressure you need depends on the weight of the fully loaded motorhome. You cannot determine the correct air-inflation pressure, unless you know the actual weights of the motorhome.

#### Weighing the Motorhome

Earlier, in Chapter 1, the procedures for weighing the motorhome were presented. These procedures provided the weighing of a "non-loaded" (i.e., not stocked with the possessions and provisions the user would normally have onboard for travel) motorhome. Obviously, any additional weight stored onboard (inside and underneath) the motorhome will contribute to the overall weight of the motorhome. If not stored uniformly throughout the motorhome, additional weight of the possessions and provisions of the motorhome user will load each axle and each tire differently (front to rear and side to side distribution of that additional weight). Accordingly, it is necessary to weigh the motorhome fully loaded as the user would have it for travel. Moreover, it is necessary to weigh each tire position individually.

Overloading the motorhome can produce problems with the tires, wheels, springs, brakes, drive train, and other motorhome assemblies. In addition, an overloaded motorhome uses more fuel, is more difficult to handle properly, and can lead to driver fatigue more quickly. In a worst-case condition, if any component should fail, this could result in loss of control of the motorhome and subsequent damage. In certain states, the Highway Patrol routinely weighs motorhomes to check for overloaded axle weights. Therefore, there are many good reasons for assuring that the motorhome is properly loaded and not overloaded—this can be accomplished through a proper weighing of the fully loaded motorhome.

# WEIGHING YOUR SINGLE AXLE RECREATIONAL VEHICLE

## RV: To Obtain Individual Axle and Gross Vehicle Weights:

	STEP 1a	STEP 1b	STEP 1c	STEP 1d
Scale Weight	_____ lbs.	_____ lbs.	_____ lbs.	_____ lbs.
From Owner's Manual	(Step 1a = GAWR) _____ lbs.	(Step 1b = GVWR) _____ lbs.	(Step 1c = GAWR) _____ lbs.	(Step 1d) _____ lbs.
	GAWR	GVWR	GAWR	Vehicle Weight (GVWR - GVW)

## To Obtain Individual Wheel Position Weights:

	STEP 2a	STEP 2b	STEP 2c
One Side Scale Weight	_____ lbs.	_____ lbs.	_____ lbs.
Calculate Other Side Weight	(Step 2a) _____ lbs.	(Step 2b) _____ lbs.	(Step 2c) _____ lbs.
Tire Load (lbs.)	(Step 1a-2a) _____ lbs.	(Step 1b-2b) _____ lbs.	(Step 1c-2c) _____ lbs.
Inflation	(See Note #1) _____ psi	(See Note #1) _____ psi	(See Notes #1 & 2) _____ psi

Note 1: From the tire manufacturer's load and inflation tables or the sidewall of the tires mounted on the motor home.

Note 2: If the motor home has duals, read dual capacity from the tire and multiply by 2 (two) to obtain dual-assembly load-carrying capacity.

More detailed information can be found in the manufacturer's literature associated with the chassis and/or the tires provided with the motorhome. For example, the attached illustrates the inflation pressures for Michelin tires as a function of the loads per position for a specified speed of the motorhome. You can determine the appropriate inflation pressures for each of the tires on the motor home, as a function of the loads they are to carry on a trip. Whenever there is a significant change in the loading regimen of the motorhome, it would be wise to re-calculate the load weights of the tires to assure optimal use of the motorhome.

### Frequency of Checking Tire Inflation Pressures

When you have determined the “correct” tire inflation pressures for each of the motorhome tires and inflated the tires under “cold” conditions, meaning the tires haven’t been driven for more than one mile, then the air pressures in the tires should be periodically checked to make sure that they keep their proper pressure. It is recommended that tire pressures be checked at least once a month, or preferably, every two weeks, and before any major trip.

On long trips, the tires should be checked every “drive” morning. On short trips (a day or less), the tires should be checked before one departs on the trip and again before one returns home.

Check tire pressures when they are “cold”; that is, the tires haven’t been driven at all or, at most, less than one mile before being measured. In this manner, the tire pressure has not been increased by the heating associated with tire sidewall and tread flexure associated with traveling. If you check tires that are warm or hot, remember that they will necessarily read higher than normal. Do not “bleed” these tires down to the “cold pressure” readings, as they will probably then be underinflated when they are actually cool. Don’t make any adjustments to tire pressures when the tires are warm or hot, if such can be avoided. To make these tire-pressure measurements, it is recommended that you purchase a high-quality, truck-tire air gauge which has an angled dual head. This type of gauge allows you to check inflation pressures of both the inner dual wheel which has the valve stem pointing towards one and on the outer wheel which has the valve stem pointing away from one. Pressure-sealing valve caps should always be used to protect the valve stems and prevent air from escaping from the valve stems.

### Tire Wear, Balance, and Wheel Alignment

In addition to tire inflation considerations, the tires should also be periodically examined for other types of normal “wear and tear.” If installed and maintained properly, all tires mounted on the motor home should wear in a smooth, even pattern. If the tires begin to show irregular wear patterns and the motor home alignment is still correct, then sometimes just rotating the tires by changing wheel position and rotation of the tires will allow the tires to wear evenly. Check with the chassis manufacturer (Power Glide) and its literature in the Owner’s Information Package for particulars on maintaining proper wheel alignment.

### Tire Cleaning

Proper cleaning of the tires will assure maximum years of service. A soft brush and the normal mild soap should be used to clean the tires. Use care in applying any tire “dressing” product as these contain petroleum derivatives, alcohol, or silicones which may cause deterioration of the rubber, possibly leading to cracking, and accelerate the aging process. In many instances it isn’t the actual dressing itself, but the reaction of that product with the antioxidant in the tire. Heat can compound this problem also.

## INTERIOR CARE

# NOTICE

**The fading of upholstery, carpet, and other interior fabrics is generally caused by excessive sunlight. The drapes, blinds, or other shades should be kept closed when the vehicle is parked for an extended period of time to minimize the fading. Normal deterioration of the appearance of such items caused by wear and/or exposure to strong lighting is not covered by the Tiffin Motorhomes Limited Warranty.**

### CARPET

A weekly routine of vacuuming the carpet and fabrics throughout the vehicle is recommended.

### FABRICS

The fabrics used in this Tiffin motorhome for the bedspread, draperies, headboard, and valances contain fire-retardant additives that may be damaged by use of improper cleaning products. Cleaning instructions for these items are DRY CLEAN ONLY. Water-based products are not recommended for cleaning the fabrics in your new vehicle. Most water-based, household-cleaning products are not formulated for use on these fabrics and may cause excessive shrinkage or fading. For best results, the fabrics in this vehicle should be cleaned by a professional carpet and upholstery cleaner.

Spills, spots, or stains should be treated as soon as possible to avoid permanent damage to the fabrics. If a spill occurs, blot the fluid with a dry towel, do not rub the spill as rubbing may cause the liquid to “set” in the fabric and cause a stain. When attempting to clean a spot or stain, always start from the outside and work inward to avoid spreading the stain further. Some stains or soils are extremely difficult or impossible to be removed completely. These stains should receive immediate, professional attention. Spills, spots, stains, or soiled areas are the responsibility of the owner and are not covered by Tiffin Motorhomes Limited Warranty.



## WARNING

**When cleaning the upholstery and fabric of the motorhome, do not use lacquer thinner, nail polish remover, laundry soaps, or bleach. Never use carbon tetrachloride or gasoline for cleaning purposes. These substances may cause damage to the materials being cleaned and most are highly flammable.**

## WALLS & CEILING

The wall and ceiling coverings should be cleaned periodically to maintain a new appearance. Use a nonabrasive cleaner with a soft cloth on the walls. Do not use solvents of any kind, as those solvents may damage the surfaces being cleaned.

## DASHBOARD

To keep the motorhome dashboard in like-new condition, regularly follow these guidelines:

### DO:

- Dust and clean the dashboard with a soft, damp cloth or chamois, wiping the service gently.
- Use a mild detergent and lukewarm water.
- After washing and rinsing the dashboard, dry it by blotting with a damp cloth or chamois.

### DO NOT:

- Use harsh chemicals that may damage the dashboard.
- Use cloths containing grit or abrasive particles or kitchen-scouring compounds to clean or dust the dashboard.
- Subject the dashboard to hard, direct blows.
- Use boiling water, strong solvents, or other such materials to clean the dashboard as they will soften the plastic.

## WOODWORK & FLOORS

The wood cabinetry should be cared for with furniture polish to sustain the natural beauty and luster of the wood. This procedure will also keep the cabinetry looking new, prevent the wood from drying, and reduce chances of accidental staining or aging.

Use area rugs and floor mats by the entrance door to trap dirt.

Use soap and water to clean the flooring, begin by vacuuming the floor to remove loose dust and dirt. Then, damp mop the floor with a cleaning solution consisting of any standard cleaning solution. The mop should be damp, but not dripping. Feel free to use soap-based cleaners, scouring powders, steel wool, abrasive cleaners, wax, or polish on the ceramic floor as this floor is impervious to these cleaning agents.

To remove stubborn spots like shoe polish, oil, tar, markers, scuffs, and the like, use a household solvent or nail-polish remover on those spots then wipe those treated areas with a damp cloth.

To remove chocolate, grease, juice, or wine, use warm water and any off-the-shelf abrasive cleaner. To remove candle wax or chewing gum, carefully scrape off when the material has hardened. For further tips, please see the manufacturer's information sheet in your Tiffin Motorhomes Owners Information Package.

## COUNTERTOPS

To care properly for the countertops in your new vehicle, always use a heat pad or trivet to protect the surface from hot objects that may mar or damage the countertop surface. Hot pans and heat-producing appliances (such as electric skillets), when set directly on top of the countertop, can possibly mar the beauty and finish of the product.



Additionally, since heat-producing appliances can also damage countertop seams, it is essential to check with Tiffin Motorhomes to identify seam locations to avoid them during subsequent use of the motorhome. Although solid surfacing is repaired easily, certain steps should be taken to protect it. Be sure to use a cutting board, rather than cutting directly on the countertop surfaces. Although minor scratches and cuts can be repaired a little care will assure that the countertop surfaces will keep looking new for years.

Avoid using harsh chemicals on the countertop. Wipe the countertop with a damp cloth to remove water spots. For most dirt and stains, wipe with a damp cloth and use soapy water or ammonia-based cleaners (e.g., Windex). If a stain doesn't respond to soap and water, for a matte finish, apply an abrasive cleanser and buff it with a Scotch-Brite pad, using a circular motion. Use the same technique in the case of a cigarette burn. If the finish is a gloss finish, please contact the dealer for specific cleaning instructions.

Do not expose the surface to harsh chemicals, such as paint remover, turpentine, nail polish remover, or any stove and drain cleansers. If these chemicals should come into contact with the countertop surfaces, immediately wash off these chemicals, using appropriate safety measures to avoid injury.

In the event of subsequent staining or spotting, sand the affected surface lightly with fine sandpaper (400 grit or finer), then buff in a circular motion with a Scotch-Brite pad.

#### ACCESSORIES

The metallic light fixtures, bath accessories, and faucets can be cleaned by wiping with a soft, damp cloth. Washing with warm water will remove dry water spots. Polishing those fixtures with a soft cloth will also enhance their appearance. Do not use cleaners that contain harsh or abrasive chemicals. Alcohol or other similar solvents should never be used.

#### DETECTORS

The CO/LP gas detectors are self-contained and DO NOT require any maintenance other than normal cleaning and periodic testing. The smoke detector installed in the motorhome is a nine volt, battery operated detector. The CO/LP gas detector is wired directly to the house batteries. The batteries in the smoke detector need to be tested periodically and replaced when necessary. When cleaning the case on any of the detectors, use a damp cloth or paper towel. Do not spray cleaners or wax directly into the case as this action may cause false alarms or hinder the normal operation of the detectors.

An inexpensive battery tester would be a good investment to make. This tester would allow checking of the batteries in the various alarms, any flashlights used in the motorhome, and batteries in other appliances which may be in the motorhome during travels.

## CONDENSATION

Damage may occur to your vehicle if excessive condensation exists. Accumulation of condensation on surfaces within your motorhome occurs when warm, moist air contacts a cool surface. It is most evident on the inside of windows, but this problem can be controlled by:

1. Slightly opening a window or roof vent to allow the moisture to escape from the motorhome.
2. A small dehumidifier is also very effective in removing moisture from the air.

## ROUTINE MAINTENANCE SCHEDULES

### NOTICE

**Always follow the chassis maintenance guidelines found in the chassis manufacturer's owner's manual.**

All routine maintenance is the responsibility of the owner and is not covered by the Tiffin Motorhomes Limited Warranty. Use the maintenance record found in Chapter 15 to record all performed maintenance as required.

Please note that any damage caused by improper or unperformed maintenance is not covered by the Tiffin Motorhomes Limited Warranty. Items supplied by other manufacturers may require specific individual maintenance not listed herein. Please refer to the manufacturers' suggested maintenance guidelines in the Owners Information Package.

### NOTICE

**Cosmetic adjustments and alignments must be performed within the first three months from date of original purchase for warranty consideration. Thereafter, these items are considered routine maintenance.**

#### Monthly

- Check the water levels of the batteries

### Every Three Months

- Check LP gas lines for leaks with soap solution or leak detector.
- Test smoke alarm and carbon monoxide/LP gas detector.
- Check operation of windows, latches, and hinges.
- Clean the roof ducted air conditioner filter or filters.
- Clean and inspect door and window seals; reseal where necessary.
- Inspect and reseal around the tub and shower area where necessary.
- Lubricate the exterior door hinges and latches with a graphite (silicone) lubricant.
- Check, clean, and tighten battery cables and inspect batteries for proper fluid levels.

### EVERY SIX MONTHS

- Inspect the slide-out for proper seal. If realignment is necessary, please contact an authorized Tiffin Motorhomes Service Center.
- Inspect the exterior rubber slide-out seals and apply an UV inhibitor, such as 303 Protectant.
- Change the battery in the smoke detector.
- Rotate tires as recommended by the tire manufacturer.
- Check all gas appliances for proper operation.
- Have the LP system inspected by a qualified technician.
- Lubricate the movable parts on the entrance step.
- Change the batteries in both the smoke detector.

### ANNUALLY

- Inspection of roof seams and joints should be performed by an authorized Motorhomes Service Center. If resealing is necessary, it is the owner's responsibility and is not covered by the Tiffin Motorhomes Limited Warranty.
- Sanitize the fresh water system.

### WINTERIZING

To store your vehicle for the winter months, it is necessary to winterize the water system to help prevent freezing of this system. To do this, follow these instructions:

1. Drain all the water from the water system including the holding tank(s), the water heater and freshwater tank. Also, drain the water filter. For the holding tank(s), open the gate valve(s) to drain the tanks. Turn off water heater before draining to prevent burning the element out.  
(NOTE: This procedure is to be performed only at a waste water pumping station to prevent dumping of contaminated water elsewhere). For the water heater, remove the outside cover and then remove the drain plug. When this tank is drained, replace the drain plug and then replace the cover. For the water tank, open the red-handled valve to drain the tank; then close the valve. Remove the filter cartridge from the water filter and store it in a clean environment. Empty any excess water from the filter housing and replace the housing.
2. At the sewer board turn the blue handle valve to the sanitize/winterize position turn the red handle valve to the bypass position.
3. Connect a vinyl hose to the inlet valve on the sewer board place the other end of the hose into a gallon of freshwater system antifreeze. NOTE: Do not use automotive antifreeze; use only antifreeze approved for RV applications. Otherwise, damage to the systems being protected may result.

4. Turn “on” the water pump to start the flow of antifreeze. Turn “on” each faucet, one at a time, including the kitchen faucet, bath faucet, inside and outside showers and allow pure antifreeze to run through that piping. Let about one cup drop into the drains to protect the traps.
5. When all the antifreeze is withdrawn from the bottle, disconnect the vinyl hose from the inlet valve on the sewer board. (This may require more than one gallon of antifreeze).
6. When the winterize process is completed, turn the water pump “off”. Store the vinyl hose for future use.

#### DE-WINTERIZING

1. To de-winterize your vehicle, open both of the low-point drains to allow the antifreeze solution to drain from the water system.
2. Next, close the low-point drains and connect your vehicle to the city water system. Put water in the freshwater tank and pump at least one gallon through the water pump to remove the antifreeze from the water pump. Keep the water heater in the bypass mode.
3. As in winterizing, open the kitchen faucet, bath faucet, inside and outside showers, turning “on” both the hot- and the cold-water valves and flushing the stool until the antifreeze solution is flushed out of the system and the water flow is clear.
4. Once the system has been flushed, open the water heater bypass valve. Open the freshwater tank supply valve from the pump and the icemaker valve.
5. Reinstall the (optional) water filter. Fill the water heater and hot water lines before turning the water heater on.
6. Be sure to close the fresh water tank drain valves to allow the tank to fill.

#### MERCEDES MAINTENANCE SCHEDULE

##### GENERAL NOTES

Your Sprinter is equipped with the Active Service System (AASYST). The maintenance computer tracks distance driven and time elapsed since your last service. The service is shown in the multifunction display in the instrument cluster. The multifunction display shows a message approximately one month before the maintenance service is due. It indicates when the next service is due in miles or days. The symbols or letters on the service display shows the type of service that is due.



**A** Oil service plus



**B** Maintenance service

Services are carried out in a series defined as A – B. The first oil service plus (SERVICE A) is due after 20,000 miles. The first maintenance service (SERVICE B) is due after 40,000 miles.

#### SERVICE DUE DATE DISPLAY

One of the following messages appears:



Service A: Due in ..... Days



Service A: Due in ..... Miles



Service A: Due now

#### SERVICE DUE DATE HAS BEEN EXCEEDED

A qualified specialist workshop, e.g an authorized Sprinter Dealer resets the service Display during the service appointment.

If the service due date has been exceeded, one of the following messages will appear in the display:



Service A: Exceeded by ..... days



SERVICE A: Exceeded by ..... miles

Additionally, a warning tone sounds.

Any additional information can be found in the Mercedes Maintenance Booklet found in the Sprinter Owner's Manual package.



*Wayfarer*

---

MAINTENANCE & DATA CHART

CHAPTER

18









