



2020 JEEP® PERFORMANCE PARTS CATALOGUE CANADA



IN A JEEP® VEHICLE, THE JOURNEY IS THE DESTINATION.

A winding, rocky, treacherous journey that only the toughest of the tough can handle. For those looking to explore that path rarely traveled, we can help you get there.

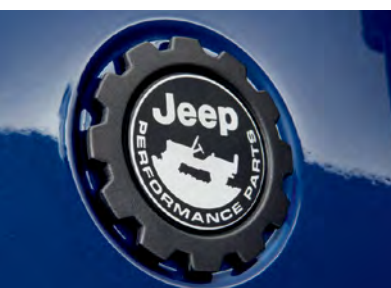

BUILD YOUR DREAMS 10

PERFORMANCE CHASSIS 20

2" Lift Kit With FOX Shocks*	22, 24
Tall Jack Base	23
4" Lift Kit With FOX Shocks*	24
Steering Dampers	25
Big Brake Kit	26

PERFORMANCE WHEELS & TIRE COMPONENTS 28

Performance Wheels	30
Beadlock-Capable Wheel	31
Oversized Spare Tire Carriers	32

PERFORMANCE DRIVELINE COMPONENTS 34

Crate Axle Assemblies	36
Axle Components	37
Differential Covers	39

OFF-ROAD ACCESSORIES 40

Bumpers	42
Winch Accessory Kit	46
Tow Hooks	48
Skid Plates	48
Windshield Accessories	50
LED Headlights & Fog Lights	51
Off-Road Lights* & Installation Kits	52
Rock Rails	54
Tube Steps	55
Fender Flares	57
Tube Door Kits & Components*	58
All-Weather Floor Mats	59
Vehicle Cab Covers	59

ENGINE COMPONENTS 60

Performance Intake Systems	62
Replacement Filters for Cold Air Intake Systems	63
Snorkel	64
Exhaust Systems	65

LIMITED WARRANTIES 66

*Jeep® Performance Parts Lift Kits, Functional Beadlock Ring Kit, Tube Doors without mirrors and Off-Road Lights are aftermarket only and may not be installed by a Chrysler, Dodge, Jeep® or Ram dealer on any vehicle prior to its first retail sale, and may not be sold or financed in conjunction with the sale of a new vehicle. FCA does not authorize the installation of these parts on any vehicle prior to its first retail sale.

*Jeep® Performance Parts Lift Kits, Functional Beadlock Ring Kit, Tube Doors without mirrors and Off-Road Lights are aftermarket only and may not be installed by a Chrysler, Dodge, Jeep® or Ram dealer on any vehicle prior to its first retail sale, and may not be sold or financed in conjunction with the sale of a new vehicle. FCA does not authorize the installation of these parts on any vehicle prior to its first retail sale.



JEEP® PERFORMANCE PARTS

Wide-Open Possibilities, Exceptional Durability, Original-Equipment Specs

When you're looking to maximize the no-excuses, rock-your-world experience – on-road or off – there's simply no better way to customize and accessorize your Jeep® vehicle than with Jeep® Performance Parts.

We affectionately refer to them as JPP, but they're Mopar® to the core. Mopar is Original Equipment (OE) for all FCA Canada Brand vehicles and the foundation of the company's worldwide parts and service enterprise. It means we understand a vehicle's original intent and have direct, exclusive access to a vehicle's specifications. It means we can design and test parts and accessories to the highest standards. For Jeep® Brand vehicle owners, it means Jeep® Performance Parts – built by us, easy to install and a perfect match for your Jeep® vehicle. It just doesn't get any more original than this. Mopar means a pure Jeep® Brand experience.

JPP gear is a great mix of OE specs with generations of time-tested engineering expertise, pushed to the limit in real-life testing by people just like you – those with a relentless passion for taking a Jeep® vehicle to the next level, and the next adventure.



HOW IT ALL STARTED

Jeep® Performance Parts (JPP) became the best option for Jeep® vehicles by design. In 2012, the Mopar® and Jeep® Brands launched the Jeep® Performance Parts division to meet a specific need: delivering a cutting-edge portfolio of off-roading parts to cater to die-hard off-road enthusiasts. Who better to offer accessories for Jeep® vehicles than the people behind the Jeep® Brand itself?

As part of the Mopar® family, JPP uses specifically designed, built and quality-tested accessories to ensure serious off-roaders have access to high-end, hard-core quality Jeep® vehicle parts. The Mopar team's long and storied history of creating desirable high-end OE parts has earned them recognition with performance enthusiasts everywhere. And that's also true as they've produced a large portfolio of parts and accessories now bearing the JPP name.





WHERE YOU'LL FIND JPP TODAY

All around the globe, from fancy auto shows to bare-bones deserts to the unforgiving wilderness, Jeep® Performance Parts can be found just about everywhere performance enthusiasts gather and drive. Our one-of-a-kind JPP concept vehicles are designed and built in Detroit to inspire and generate feedback from our most loyal and passionate customers. JPP also displays concept cars at parts and accessories events throughout the year; in fact, our custom vehicles are so sought after, we even sponsor vehicle builds for various aftermarket suppliers and racers.

We do all this and more for the love of Jeep®, vehicle drivers and their seemingly insatiable desire for powerful and truly functional parts and accessories. Our exceptional vehicle builds demonstrate to daily drivers, gearheads and off-road enthusiasts the possibilities of what Jeep® Performance Parts can do on both production and modified vehicles.

JPP. What's on your Jeep® vehicle?



JUST WHEN WE THINK WE'RE DONE, WE TEST MORE.

Why are our standards so high?

Because we know when you're off the grid – hours past the end of the pavement and kilometres from the nearest cell tower – you want strong, reliable parts that can take you anywhere.

That's why we conduct such a rigorous testing process. From computer-aided engineering to computer modeling to endless lab testing, we use every state-of-the-art FCA design, engineering and testing resource available to us.

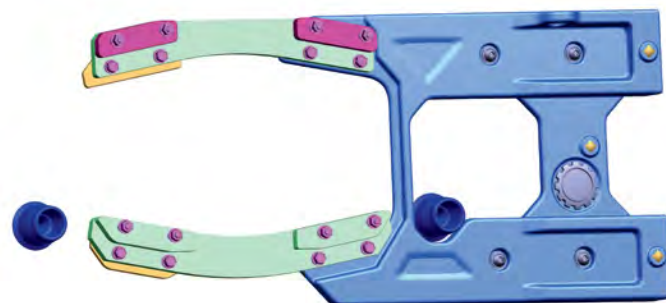
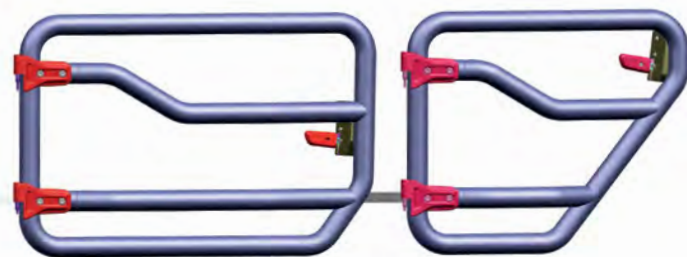

For example:

- Our parts are tested to the everyday equivalent of 240,000 kilometres on-road and off-road.
- Extensive temperature testing to hot and cold extremes, as low as -40 °C (-40 °F) and as high as 93 °C (200 °F).
- X-ray analysis of raw materials and finished parts to make sure there are no internal voids.
- Impact testing for overall safety because we know our parts are going to see things that are a little more challenging than what most vehicles experience.
- Corrosion-testing – finishes are tested to the equivalent of 10 years of everyday use.
- Electrical product testing to make sure there is not any interference with Original Equipment electronics.
- Our graphics endure grueling testing – simulated sun-loads make sure that graphics will stay as sharp and vibrant as they were when you brought your Jeep® vehicle home.

Every single performance part endures rigorous testing to make sure it's ready for your next adventure – that's what sets us apart from other aftermarket companies. We're the same factory engineers who designed your vehicle, and we live by a few simple principles: Original Equipment specs, integrated engineering, robust design and rigorous testing. That's why authentic Jeep® Performance Parts fit well, install easily and work the way they should. We take pride in building parts that will take you to the ends of the earth – AND back.



**THIS IS WHERE
YOUR DREAMS BEGIN.**

It's time to start your dream build. Check out the vehicles we've outfitted with Jeep® Performance Parts and Accessories on the following pages, and let your dreams run wild.



FOR WHEN YOU WANT TO HIT THE TRAILS

JEEP® GLADIATOR RUBICON®

1. P/N 82215594AB

2. P/N TCOES599

3. P/N 82215631

4. P/N LRJT0202TU

5. P/N 82215523AB - FRONT
P/N 82215524AB - REAR
See page 58 for more details.

6. P/N 82215385AB*
See page 52 for more details.

7. P/N 82215427AB
See page 52 for more details.

8. P/N 77072498AB*
See page 58 for more details.

9. P/N 82215606
See page 54 for more details.

10. P/N 77072468AB*
See page 22 for more details.

11. P/N 77072494AB
See page 30 for more details.





FOR WHEN THINGS GET A LITTLE ROCKY

JEEP® WRANGLER JL RUBICON®

1. **P/N 82215386AB***
See page 52 for more details.

2. **P/N 82215114**

3. **P/N 82215385AB***
See page 52 for more details.

4. **P/N 82215389AB - 2 DOOR**
P/N 82215390AB - 4 DOOR

5. **P/N 82215356AB**
See page 32 for more details.

6. **P/N 82215349**
See page 32 for more details.

7. **P/N 77072396AD***
See page 22 for more details.

8. **P/N 77072466AB***
See page 31 for more details.

9. **P/N 82215129AB**
See page 54 for more details.

10. **P/N 77072496AC***
See page 58 for more details.

11. **P/N 82215427AB**
See page 52 for more details.

12. **P/N 82215351**
See page 42 for more details.



FOR WHEN YOU NEED A RECHARGE

JEEP® WRANGLER JL RUBICON®

1. **P/N 82215729**
See page 52 for more details.

2. **P/N 82215386AB***
See page 52 for more details.

3. **P/N 82215385AB***
See page 52 for more details.

4. **P/N 82215427AB**
See page 52 for more details.

5. **P/N 82215390AB**

6. **P/N 82215349**
See page 32 for more details.

7. **P/N 82215356AB**
See page 32 for more details.

8. **P/N 77072466AB***
See page 31 for more details.

9. **P/N 77072396AD***
See page 22 for more details.

10. **P/N 82215165AB**
See page 54 for more details.



*For additional information, see pages 66 and 67.

*For additional information, see pages 66 and 67.





1
SOFT TRI-FOLD
TONNEAU COVER

2
A-PILLAR LIGHT BRACKET

3
1941 HOOD GRAPHIC

4
7-INCH LED
OFF-ROAD LIGHT KIT*

10
BLACK TUBULAR
SIDE STEPS

9
5-INCH LED
OFF-ROAD LIGHT KIT*

8
BEADLOCK-CAPABLE
WHEELS WITH BEAUTY RING*

7
RUBICON® STEEL
THREE-PIECE FRONT BUMPER

6
WINCH GUARD LIGHT
MOUNTING BRACKET

5
GRILLE AND WINCH
GUARD HOOP

FOR WHEN YOU'RE LIVING THE DREAM

JEEP® GLADIATOR RUBICON®

1. P/N 82215615

2. P/N 82215427AB
See page 52 for more details.

3. P/N 82215734

4. P/N 82215386AB*
See page 52 for more details.

5. P/N 82215351
See page 42 for more details.

6. P/N 82215729
See page 52 for more details.

7. P/N 82215121AC
See page 42 for more details.

8. P/N 77072466AB*
See page 31 for more details.

9. P/N 82215385AB*
See page 52 for more details.

10. P/N 82215609
See page 55 for more details.





PERFORMANCE CHASSIS

Unleash your Jeep® vehicle into the wild with custom chassis products that provide increased performance, ground clearance and exceptional off-road articulation.



LIFT KITS*



STEERING DAMPERS



BIG BRAKE KITS



Jeep® Performance Parts Lift Kits* improve ground clearance and allow for larger tires. You can further enhance any ride with FOX shocks that are already tuned specifically for a Jeep® vehicle with larger tires.

JEOP® GLADIATOR AND JEOP® WRANGLER JL 2" LIFT KIT WITH FOX SHOCKS*

Jeep® Performance Parts (JPP) 2" Lift Kits* have been developed by Jeep® Brand engineers and off-road enthusiasts, and allow you to use larger tires. The Kits include 2.5" diameter aluminum body monotube FOX shock absorbers for cooler operation. The Lift Kits increase articulation and tire-to-ground contact, and the longer front control arms optimize suspension tuning for on-road drivability while improving off-road capability. They work with electronic stability control although unique alignment specifications are required. The parts are easy to install as no driveshaft or brake line replacements are required. Rigorously tested for performance, durability and corrosion, the parts in this Kit are held to all FCA production standards. The Kit comes in a reusable Jeep® Branded wooden crate with a Jeep® Performance Parts Badge.

P/N 77072468AB

2020–2021, Jeep® Gladiator equipped with 3.6L engine

P/N 77072395AD

2018–2021, 4–Door Jeep® Wrangler JL equipped with 3.6L engine

P/N 77072396AD

2018–2021, 2–Door Jeep® Wrangler JL equipped with 3.6L engine

P/N 77072399

2020, 4–Door Jeep® Wrangler JL equipped with 3.0L diesel engine

P/N 77072430AD

2018–2021, 4–Door Jeep® Wrangler JL equipped with 2.0L engine

P/N 77072397AD

2018–2021, 2–Door Jeep® Wrangler JL equipped with 2.0L engine



TALL JACK BASE

Single unit block made out of a polymer. Moulded indentation designed to fit your factory scissor jack to keep it planted firmly in place when jacking the vehicle. Used as a stable base to help lift and extend the range of the production jack when vehicle is equipped with larger tires and/or Lift Kits* are present. Angled face to work as a wheel chock as well.

P/N 82215637AB

2020–2021, Jeep® Gladiator
2018–2021, Jeep® Wrangler JL

“Love the OEM quality of the product and am confident in the durability of this JPP Kit offering. Ride and handling with oversized tires is top notch.”

JEFF GREEN

VP, Corporate Development – Bestop, Inc.



JEEP® WRANGLER JK 2" LIFT KIT WITH FOX SHOCKS*

Features the FOX Shocks 2.0 Performance Series IFP shock. Its brushed aluminum shock body dissipates heat faster than conventional steel and combines with other race-inspired technology to provide incredible fade-free performance, precise handling and stability. Hard chrome-plated, heat-treated shock shaft and redundant sealing system does not require a dust boot. Includes four tuned coil springs, four FOX shocks, brake line and track bar brackets, 1310-Double Cardan front driveshaft and yoke (3.6L engine) and all the hardware required for a complete installation. Tires larger than production will require a 12mm wheel offset (Jeep® Performance Parts offers several styles; see the Performance Wheels & Tire Components section in this Catalogue).

P/N 77070089AC

2007-2011, 4-Door Jeep® Wrangler JK equipped with 3.8L engine

P/N 77070088AD

2012-2018, 4-Door Jeep® Wrangler JK equipped with 3.6L engine

P/N 77070095AD

2012-2018, 2-Door Jeep® Wrangler JK equipped with 3.6L engine

P/N 77070090AB

2007-2018 Jeep® Wrangler JK, Front Driveshaft

P/N 77070100AB

2" FOX Shock, Front Shock (1).
2012-2018, 2-Door or 4-Door Jeep® Wrangler JK

P/N 77070102AB

2" FOX Shock, Rear Shock (1).
2012-2018, 4-Door Jeep® Wrangler JK

P/N 77070103AB

2" FOX Shock, Rear Shock (1).
2012-2018, 2-Door Jeep® Wrangler JK



P/N 77070095AD

JEEP® WRANGLER JK 4" LIFT KIT WITH FOX SHOCKS*

Raise your profile and enjoy the fun of off-roading and handling. Kit includes four specially tuned springs with dual-coat protective coating, four tuned FOX reservoir shocks, control arms, four brake lines, 1310-Double Cardan front driveshaft and yoke, front/rear track bar relocation and all necessary brackets. Also includes a FOX steering damper and our High-Steer Conversion Kit to correct the steering geometry.

Note: Production wheels will not work with this Kit. Min. of 12mm wheel offset required. Allows for up to 35" tires.

P/N 77072353AD

2007-2011, 4-Door Jeep® Wrangler JK equipped with 3.8L engine

P/N 77072357AB

2007-2011, 2-Door Jeep® Wrangler JK equipped with 3.8L engine

P/N 77072359

2012-2018, 4-Door Jeep® Wrangler JK equipped with 3.6L engine

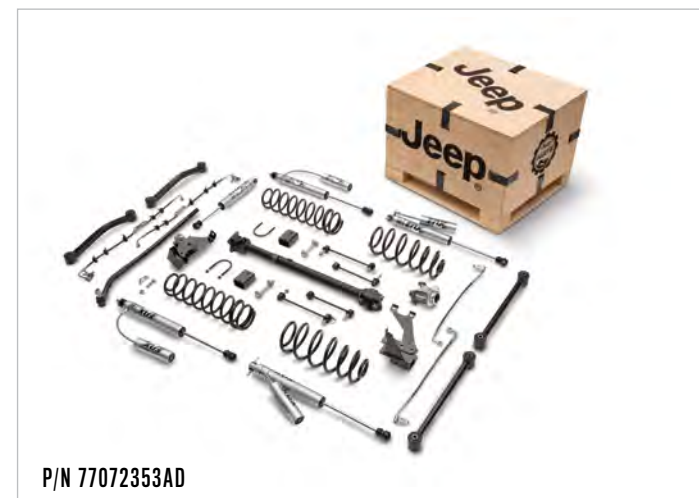

P/N 77072353AD



P/N 77072360AB



P/N P5160094

STEERING DAMPERS

Provides additional steering linkage damping necessary when vehicle is fitted with larger than stock tires.

FOX Premium Steering Damper

P/N 77072360AB

2020-2021, Jeep® Gladiator
2018-2021, Jeep® Wrangler JL

Heavy-Duty Steering Stabilizer

P/N P5155264

2007-2018, Jeep® Wrangler JK

High-Steer Kit

High-Steer Kit relocates steering damper and includes drag link, front track bar bracket and bushing. To be used with 3"-4" Lift Kits*.

P/N P5160094

2007-2018, Jeep® Wrangler JK



P/N P5155264



Big wheels and tires need big brakes. Our Big Brake Kits can help improve fade resistance and stopping power so your next adventure can take you further.

Note: 17" wheels or larger are required; however, not all 17" wheels will work. Be sure to check clearance before driving.

JEEP® WRANGLER JL BIG BRAKE KIT

Direct bolt-on, heavy-duty front and rear Big Brake Kit features front 330mm x 28mm vented rotors and 51mm 2-piston caliper, front brake lines, rear 342mm x 14mm solid rotors and 48mm single piston caliper, heavy-duty brake pads and hardware. Same as what comes standard on the Rubicon®. Replacement pads and rotors are available.

P/N 77072434

2018–2021, Jeep® Wrangler JL

Note: Brakes work with original master cylinder, no need to change.



P/N 77072434

JEEP® WRANGLER JK BIG BRAKE KIT

Front axle Big Brake Kit features large 330mm rotors, big 54mm 2-piston calipers, brake lines and heavy-duty pads. Kit also includes a matching brake booster and a 21% larger master cylinder. Replacement pads and rotors are available.

P/N P5160051AD

2007–2018, Jeep® Wrangler JK



P/N P5160051AD

REPLACEMENT PARTS FOR P/N P5160051AD

Performance Master Cylinder and Booster

Includes reservoir.

P/N P5160050

2007–2018, Jeep® Wrangler JK



P/N P5160050



P/N 68456066AA

Replacement Pads

P/N 68456066AA

Replacement Rotors

P/N 68250085AB



P/N 68250085AB

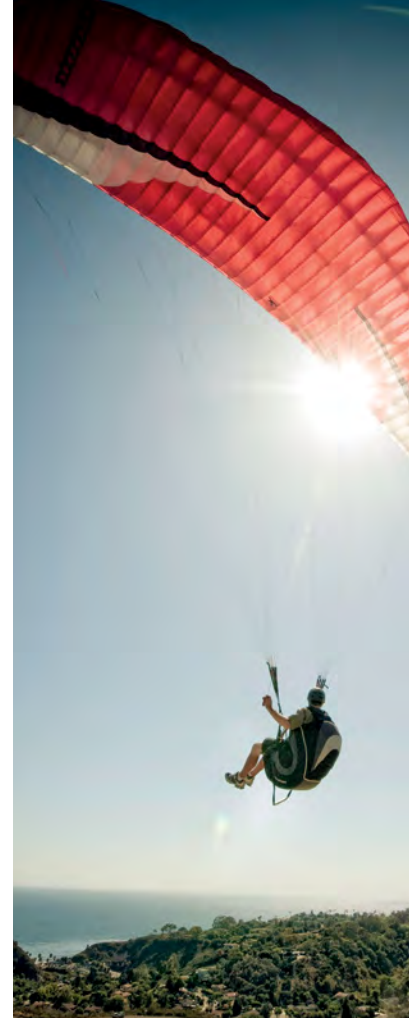



PERFORMANCE WHEELS & TIRE COMPONENTS

As a Jeep® vehicle owner, you can't resist unmarked territory, so it's only fitting that your wheels match your ambition. Our performance wheels are engineered to handle wider, aggressive off-road rubber to give you maximum traction wherever you wander.



OFF-ROAD WHEELS



BEADLOCK-CAPABLE WHEELS*



TAILGATE REINFORCEMENTS

*For additional information, see pages 66 and 67.



Where rubber meets rock, Jeep® Performance Parts shine. Wheels that are engineered to accommodate wider, high-impact, aggressive off-road tires aren't meant to only stay on pavement.

17" CAST ALUMINUM OFF-ROAD WHEELS

17" x 8.5" x 12mm offset Cast Aluminum Wheel is rated for a 1,950-lb. load rating, a 5" x 5" bolt pattern and a 71.54mm pilot bore diameter. Also includes a Jeep® Branded center cap in corresponding wheel finish.

2020-2021, Jeep® Gladiator
2018-2021, Jeep® Wrangler JL
2007-2018, Jeep® Wrangler JK

P/N 77072470AB

17" Off-Road Wheel – Jet Black

P/N 77072472AB

17" Off-Road Wheel – Fine Silver

P/N 77072471AB

17" Off-Road Wheel – Gear Design – Satin Carbon

P/N 77072494AB

17" Off-Road Wheel – Slotted Design – Satin Carbon



BEADLOCK-CAPABLE WHEEL

17" x 8" Beadlock-Capable Wheel provides a backspacing of 4.4" (12mm offset). This wheel features dual bead seats. The outer bead of the tire can be mounted in a compliant inner location or in the outer location as a true beadlock with purchase of Functional Lock Ring Kit. Wheel is satin black with a tech silver beauty ring. Beauty ring is paintable. This wheel features a protected valve stem design, a 5" x 5" bolt pattern, and meets all FCA standards for corrosion and load. Requires Functional Lock Ring Kit, sold separately, for true beadlock capability.

P/N 77072466AB

2020-2021, Jeep® Gladiator
2018-2021, Jeep® Wrangler JL
2007-2018, Jeep® Wrangler JK



FUNCTIONAL BEADLOCK RING KIT FOR TRUE BEADLOCK CAPABILITY*

Beadlock wheels clamp the outer tire bead to the rim, allowing you to run very low tire pressure for maximum traction and ride. This Functional Lock Ring Kit turns your Beadlock-Capable Wheel into a true functioning Beadlock Wheel. Hardware included.

Note: Lock Ring for off-road use only.

P/N P5160154

2020-2021, Jeep® Gladiator
2018-2021, Jeep® Wrangler JL
2007-2018, Jeep® Wrangler JK

“The Jeep® Performance Parts wheels are often the most commented item on the Jeep® vehicle and folks are stunned when we tell them they came from the Jeep® dealership.”

DOUG JOHNSON

Director, OE Programs – Katzkin®



JEEP® WRANGLER JL TAILGATE REINFORCEMENT & SPARE TIRE CARRIERS

Tailgate Reinforcement System

Swing Gate Hinge Reinforcement allows for larger tires to be mounted on the swing gate. The reinforcement is powder-coated black and works with production hinge for easier installation. Requires Oversized Spare Tire Carrier Modification Kit (P/N 82215355). For use with tires up to 37". Also provides mounting provisions for other accessories.

P/N 82215356AB

2018–2021, Jeep® Wrangler JL



Oversized Spare Tire Carrier Modification Kit

Modification Kit provides various spacers to adjust the production spare tire carrier in order to accommodate larger tire assembly. The carrier is painted with a corrosion-resistant black finish. Requires Tailgate Reinforcement System (P/N 82215356AB).

P/N 82215355

2018–2021, Jeep® Wrangler JL



Center High-Mount Stop Light (CHMSL) Relocation Kit

CHMSL Relocation Kit allows you to add larger tires on the spare tire mount and move the CHMSL to the center of the spare tire. Can be used with the Oversized Spare Tire Carrier Modification Kit (P/N 82215355), Tailgate Reinforcement System (P/N 82215356AB) or as a stand-alone component.

Note: Not compatible with Mopar® Spare Tire Covers.

P/N 82215349

2018–2021, Jeep® Wrangler JL



JEEP® WRANGLER JK TAILGATE REINFORCEMENT & SPARE TIRE CARRIERS

Tailgate Reinforcement System

Cast Aluminum Tailgate Reinforcement replaces the stock hinges and supports the spare tire mount. This tailgate hinge system mounts to existing body attachment locations and can be used with or without the production tire carrier. Requires Oversized Spare Tire Carrier Modification Kit (P/N 82215713). For use with tires over 33".

P/N 82214770AC

2007–2018, Jeep® Wrangler JK



Oversized Spare Tire Carrier Modification Kit

Oversized Spare Tire Carrier is adjustable for different size tires and wheel offsets. Use with cast tailgate reinforcement. Required for tires over 33" in diameter with tailgate reinforcement.

P/N 82215713

2007–2018, Jeep® Wrangler JK





PERFORMANCE DRIVELINE COMPONENTS

When you're driving a Jeep® vehicle, giving up is not an option. You've got the power to go over, around and under, and you just can't resist. Feed your addiction to adventure with durable axle components that deliver handling and capability you want.



CRATE AXLES

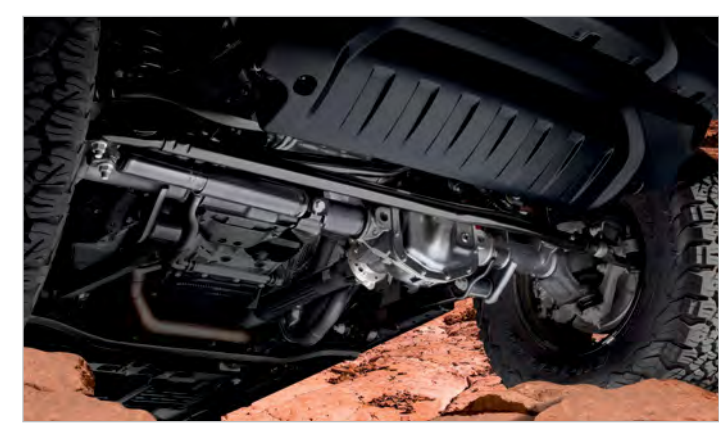

CRATE AXLE COMPONENTS

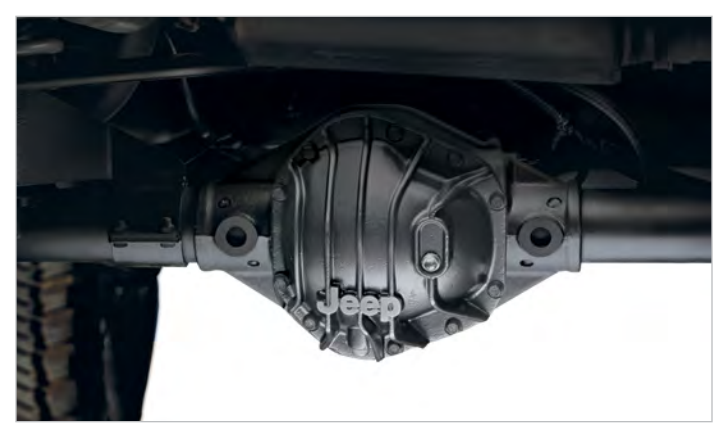

DIFFERENTIAL COVERS



Looking for next level off-road performance? Go with these front and rear axle assemblies. Our wide range of axle options cater to all kinds of rides, from serious expeditions to casual adventures.

JEEP® GLADIATOR RUBICON® CRATE AXLE

Crate Axle Assembly is the same as the production Rubicon® Axle Assembly, a 4.10 ratio. Assemblies come with electric lockers.

P/N 77072533AA

Jeep® Gladiator Axle Assembly, Front.
2020–2021, Jeep® Gladiator

Note: Does not come with brakes.

P/N 77072505

Jeep® Gladiator Axle Assembly, Rear.
2020–2021, Jeep® Gladiator



JEEP® WRANGLER JL RUBICON® CRATE AXLE

Crate Axle Assembly is the same as the production Rubicon® Axle Assembly, a 4.10 ratio. Assemblies come with electric lockers.

P/N 77072405

Jeep® Wrangler Rubicon® Axle Assembly, Front.
2018–2021, Jeep® Wrangler JL

Note: Does not come with brakes.

P/N 77072406

Jeep® Wrangler Rubicon® Axle Assembly, Rear.
2018–2021, Jeep® Wrangler JL



RUBICON® LOCKER WIRING HARNESS

20-foot, 2-wire connector. You provide power and ground with your switch. Allows front or rear locking axle to be powered.

P/N 77072413

2020–2021, Jeep® Gladiator
2018–2021, Jeep® Wrangler JL



RING AND PINION GEARS, DANA M210, 4.88 RATIO

Ring and Pinion Gears help maintain vehicle performance after larger tires are fitted. Jeep® Performance Parts gears are made from heat-treated 8620 steel. Gear ratio is 4.88:1.

P/N 77072409

Axle, Wide-Front.
2020–2021, Jeep® Gladiator
2018–2021, Jeep® Wrangler JL



ULTIMATE DANA 44™ ADVANTEK® AXLE

The Dana 44™ AdvanTEK® Front Axle Assembly provides improved off-road capability and additional ground clearance. Delivered as a complete assembly and designed as a direct bolt-on, they are available with your choice of four gear ratios (4.56, 4.88, 5.13, 5.38) to better accommodate different tire sizes. Features heat-treated SAE-4340 chromoly axle shafts with large 1410 series universal joints load-rated at 3,600 Nm. Includes a selectable electronic locker and necessary suspension brackets. Nodular iron, Jeep® Branded differential cover with extra ribbing offers added strength, and ½" rotated high-clearance carrier provides additional ground clearance.

P/N 77072527

Ultimate Dana 44™ AdvanTEK® Axle Assembly, Front, 5.13.
2020–2021, Jeep® Gladiator
2018–2021, Jeep® Wrangler JL

P/N 77072529

Ultimate Dana 44™ AdvanTEK® Axle Assembly, Front, 4.56.
2020–2021, Jeep® Gladiator
2018–2021, Jeep® Wrangler JL

P/N 77072528

Ultimate Dana 44™ AdvanTEK® Axle Assembly, Front, 4.88.
2020–2021, Jeep® Gladiator
2018–2021, Jeep® Wrangler JL

P/N 77072530

Ultimate Dana 44™ AdvanTEK® Axle Assembly, Front, 5.38.
2020–2021, Jeep® Gladiator
2018–2021, Jeep® Wrangler JL

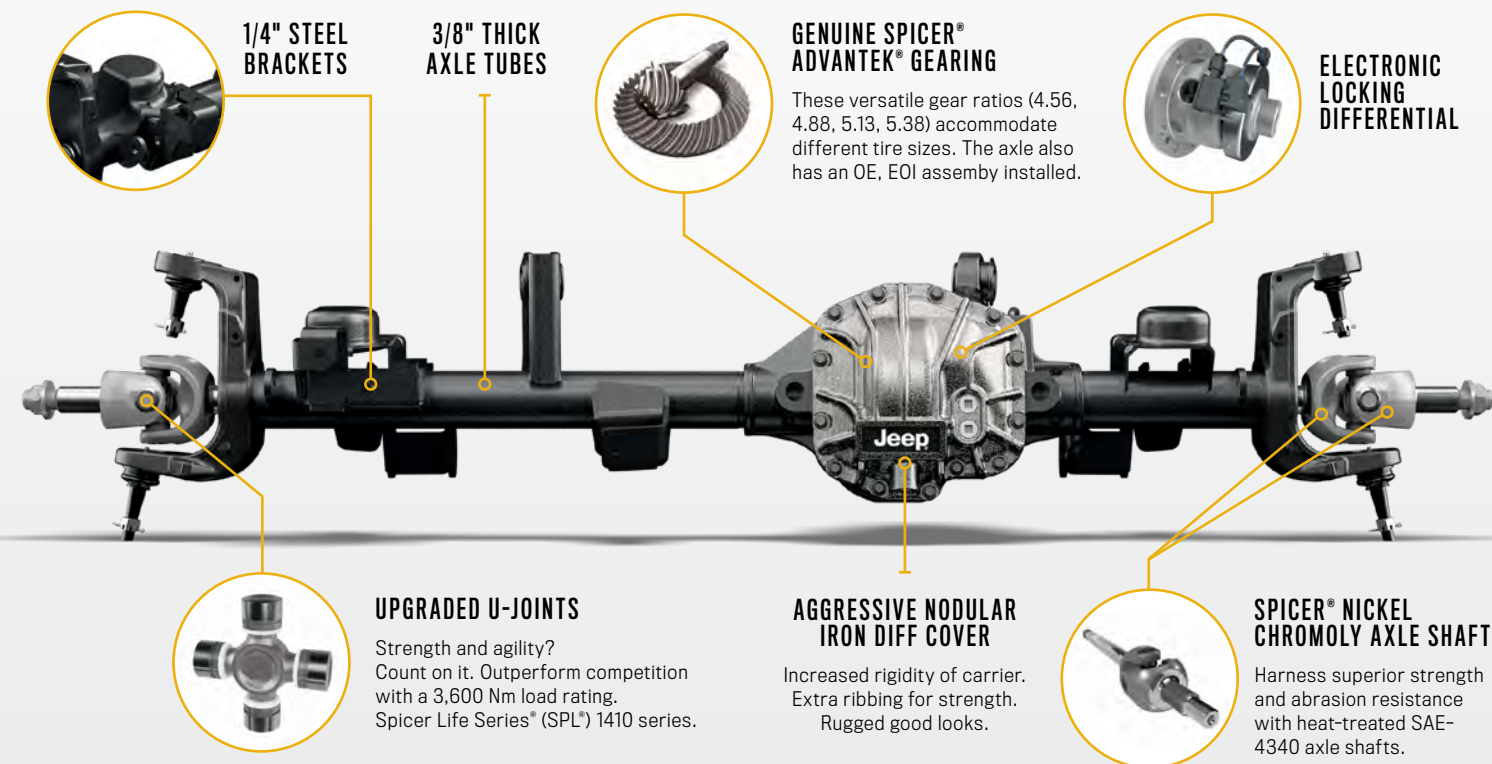

1/2" ROTATED HIGH-CLEARANCE CARRIER

Take on even the most brutal terrain with the high-clearance carrier design of these superior axles.



HEAVY-DUTY RUBICON® DANA 44™ AXLE HOUSING, FRONT

This heavy-duty Axle Housing is a direct replacement for your Rubicon® front axle. This Housing features thicker wall tubes and improved bending strength over stock. This is a bare Housing, ready to accept the gears, locker and shafts from your Housing.

P/N P5160036

2007-2018, Jeep® Wrangler JK



“JPP’s Ultimate Dana 44™ AdvanTEK® axles are built strong so hardcore Jeep® Wrangler off-roaders can go where others fear to tread. High-strength features include AdvanTEK® Gear technology that reduces gear set packaging, allowing for a condensed carrier and improving ground clearance. We are proud to offer these axles through the Jeep® Performance Parts program.”

BILL NUNNERY

Senior Director, Dana Global Aftermarket Sales & Marketing



AXLE BRACKET KITS

Our Kits offer all necessary brackets you'll need for your Jeep® vehicle when installing your own axle. The Kit consists of the upper and lower control arm mounts, shock mounts, spring mounts and track bar mounts. All parts are raw steel and are ready for welding.

P/N P5160041

Axle Brackets, Front.

2007-2018, Jeep® Wrangler JK

P/N P5160042

Axle Brackets, Rear.

2007-2018, Jeep® Wrangler JK



DIFFERENTIAL COVERS

The Jeep® Performance Parts extreme heavy-duty Differential Covers offer upgraded protection for your axle's differential. Made from nodular castings, these covers provide increased strength and protect your differential from severe impact from rocks or off-road obstacles. They also greatly enhance the rugged look of your axles. Each Cover comes with exclusive Jeep® Brand badging.

P/N P5160020

Dana 60™ Heavy-Ribbed Cast Iron Differential

Cover with Jeep® Brand logo. Rear only.

Fits all Dana 60™ rear axles.

2007-2018, Jeep® Wrangler JK



RING AND PINION GEARS, DANA 44™, 4.88 RATIO

Ring and Pinion Gears help maintain vehicle performance after larger tires are fitted. Jeep® Performance Parts gears are made from heat-treated 8620 steel.

P/N P5155355AB

Axle, Front.

2007-2018, Jeep® Wrangler JK

P/N P5155356AB

Axle, Rear.

2007-2018, Jeep® Wrangler JK



HEAVY-DUTY GREASABLE BALL JOINT KIT

Includes all four ball joints.

P/N P5160059

2007-2018, Jeep® Wrangler JK





OFF-ROAD ACCESSORIES

A Jeep® vehicle is the only vehicle that looks better dirty. With accessories like rock rails, bumpers, winches and skid plates, you can venture even further off the beaten path, where things really get dirty.



BUMPERS AND WINCHES



OFF-ROAD LED LIGHTS*



ROCK RAILS



JEEP® WRANGLER JL AND JEEP® GLADIATOR BUMPERS

Steel high-clearance bumpers are tough and heavily gusseted for strength. Functional and strong, these bumpers include many must-have features already built in. They are even compatible with airbag systems and will maintain proper deployment.

Rubicon® Steel 3-pc. Bumper, Front

Front off-road bumper, same as production, is the complete 3-pc. steel assembly including Steel Stubby Bumper and end caps.

P/N 82215121AC

2020-2021, Jeep® Gladiator

2018-2021, 2-Door and 4-Door Jeep® Wrangler JL

Rubicon® Steel Stubby Bumper, Front

Rubicon® Steel 1-pc. Bumper, same as production front steel bumper. The Stubby Bumper is the centerpiece of the Rubicon® Bumper and you can add the Front Bumper End Caps (P/N 82215115AB) to this bumper to create the complete Rubicon® Bumper. This steel, winch-capable bumper assembly must be used with the production Steel Skid Plate (P/N 82215183).

P/N 82215120

2020-2021, Jeep® Gladiator

2018-2021, 2-Door and 4-Door Jeep® Wrangler JL

Front Bumper End Caps

For Rubicon® Steel 1-pc Bumper. Add this kit to complete full Rubicon® Bumper kit.

P/N 82215115AB

2020-2021, Jeep® Gladiator

2018-2021, 2-Door and 4-Door Jeep® Wrangler JL

Grille and Winch Guard Hoop

Grille and Winch Guard designed with 2" outside diameter (OD), black, powder-coated steel. Bolts to the Rubicon steel bumper or Jeep® Performance Parts steel front bumper.

P/N 82215351

2020-2021, Jeep® Gladiator

2018-2021, Jeep® Wrangler JL

Rubicon® Steel Rear Bumper

Rear off-road bumper, same as production, matches front Rubicon® Bumper. Bumper is steel with black, powder-coated finish.

P/N 82215634AB

2020-2021, Jeep® Gladiator

P/N 82215342AD

2018-2021, 2-Door and 4-Door Jeep® Wrangler JL



Jeep® Performance Parts Front Bumper

Rigorously tested for performance, durability and corrosion, this heavy-duty bumper is steel e-coated and black powder-coated. Includes D-rings for extra towing capability. Bumper is fully compatible with Jeep® Performance Parts Rubicon® Winch and maintains vehicle compliance. Use with Steel Skid Plate (P/N 82215183) and LED Fog Lamps (P/N 82215549).

Note: Jeep® Performance Parts Bumper is winch-capable for JL only.

P/N 82215691AD

2020-2021, Jeep® Gladiator

2018-2021, Jeep® Wrangler JL



JEEP® WRANGLER JK BUMPERS

Rubicon® Steel 3-pc. Bumper, Front

Same as Rubicon® 10th Anniversary, Rubicon® Hard Rock and Rubicon® X Bumpers. Bumper is winch mount-capable and comes with black tow hooks and fog lamps. If desired, also order Front Bumper Skid Plate (P/N 82214330).

P/N 82213653AB

2007-2018, Jeep® Wrangler JK



Rubicon® Steel Stubby Bumper, Front

Rubicon® Steel 1-pc. Bumper, same as production front steel bumper. The Stubby Bumper is the centerpiece of the Rubicon® Bumper and you can add the Front Bumper End Caps (P/N 82214754AB) to this bumper to create the complete Rubicon® Bumper.

P/N 82214565AB

2007-2018, Jeep® Wrangler JK



Front Bumper End Caps

For Rubicon® Steel Stubby Bumper. Add End Caps to complete bumper kit.

P/N 82214754AB

2007-2018, Jeep® Wrangler JK



Aero End Caps

Aero Bumper End Caps, designed to be used with Rubicon® Steel Bumpers.

P/N 82214403AB

2007-2018, Jeep® Wrangler JK



Grille and Winch Guard Hoop

Grille and Winch Guard bolts to the Rubicon® Steel Front Bumpers with a no-drill installation. Powder-coated finish to match the front bumper assembly.

P/N 77072349

2007-2018, Jeep® Wrangler JK

Rubicon® Steel Rear Bumper

Same as Rubicon® 10th Anniversary, Rubicon® Hard Rock and Rubicon® X Bumpers.

P/N 82213654

2007-2018, Jeep® Wrangler JK



Heavy-Duty Steel 1-pc. Bumper, Front

Front, satin black, includes winch mount, integrated production fog lamp mounting provisions, license plate holes and Tubular Grille and Winch Guard. Compatible with production tow hooks. Also order Lower Skid Plate (P/N 82213581AB) to replace plastic air dam if desired.

P/N 82213575AC

2007-2018, Jeep® Wrangler JK



Heavy-Duty Steel 1-pc. Bumper, Front

Front, satin black, without winch mount provision. Includes holes for production fog lamps. Appearance is same as P/N 82213575AC.

P/N 82213578AC

2007-2018, Jeep® Wrangler JK

Heavy-Duty Rear Bumper

Satin black and includes tow eyes. Compatible with production hitch.

P/N 82213579AC

2007-2018, Jeep® Wrangler JK



WINCHES AND ACCESSORIES

Exclusive Jeep® Performance Parts Rubicon® Winch

Completely waterproof and submersible to ensure reliable operation during water fording and other adverse conditions. Includes 100 feet of Warn Spydura™ Synthetic Rope (the strongest, most feature-packed synthetic rope on the market today). Finished in three-stage zinc phosphate, e-coat and powder coating. Fasteners treated with anti-corrosive Magni 565 coating. This Winch should be paired with the Front Bumper End Caps (P/N 82215115AB) to maintain equivalent airbag performance.

Note: Do not attempt water fording unless depth is known and consistent with the vehicle's water fording rating in the Owner's Manual. Traversing water can cause damage that may not be covered by the new vehicle warranty. Always off road responsibly in approved areas.

P/N P5160095AC

2020-2021, Jeep® Gladiator
2018-2021, Jeep® Wrangler JL
2007-2018, Jeep® Wrangler JK

Jeep® Trail Rated® Winch Accessory Kit

Trail Rated® Kit contains a Jeep® Branded, 22-foot, 18,000-lb. tensile strength tow strap, two 3/4" D-rings, a carabiner and a pair of Jeep® Branded gloves, all in a red nylon carrying bag with a black Jeep® Brand logo.

P/N 82213901AD

2020-2021, Jeep® Gladiator
2018-2021, Jeep® Wrangler JL
2007-2018, Jeep® Wrangler JK

Jeep® Winch Mounting Kit

Winch Mounting Kit, designed to fit on the stock steel front bumper and the Mopar® Front Bumper Assembly. The Mopar Winch Plate Kits keep the vehicle in compliance with all Motor Vehicle Safety Act (MVSA) Safety Standards for frontal impact and airbag deployment.

Jeep® Wrangler JL can have a Winch and Winch Mounting Plate installed on both the Rubicon® Bumper and Jeep®, Performance Parts Front Bumper. Jeep® Gladiator can have the Winch and Mounting Plate installed on the Rubicon® Bumper only.

P/N 82215182AC

2020-2021, Jeep® Gladiator
2018-2021, Jeep® Wrangler JL

Fairlead Mounting Plates

2020-2021, Jeep® Gladiator
2018-2021, Jeep® Wrangler JL

P/N 82215528AB

Centered winches

P/N 82215527AB

Non-centered winches

Replacement Winch Line

P/N 510RR211

2020-2021, Jeep® Gladiator
2018-2021, Jeep® Wrangler JL
2007-2018, Jeep® Wrangler JK



P/N P5160095AC



P/N 82213901AD



P/N 82215182AC

WANT US TO HOOK YOU UP?

Here's everything it takes to assemble your winch to your Jeep® vehicle.



P/N P5160095AC
Exclusive Jeep® Performance Parts Rubicon® Winch

P/N 82215182AC
Jeep® Winch Mounting Kit

P/N 77072349
Grille and Winch Guard Hoop

P/N 82215528AB
Fairlead Mounting Plate for
Centered Winches

P/N 82215527AB
Fairlead Mounting Plate for
Non-Centered Winches

P/N 82213653AB
Rubicon® Steel 3-pc. Bumper, Front



TOW HOOKS

Rated with a capacity up to 5,500 pounds or 1.5 times the vehicle's Gross Vehicle Weight Rating (GVWR), depending on vehicle. Tow Hooks securely mount to the frame and are fully tested for durability and capacity.

Jeep® Grand Cherokee Tow Hooks – Black

Front Tow Hooks. Black, set of 2.

P/N 82208987

2005–2010, Jeep® Grand Cherokee

Jeep® Grand Cherokee Tow Hooks

Front Tow Hooks. Set of 2, same as production.

P/N 82212095

2011–2020, Jeep® Grand Cherokee

Jeep® Wrangler JK Tow Hooks

Front Tow Hooks. Black, set of 2. A template is provided for trimming the plastic bumper.

P/N 82210256

2007–2016, Jeep® Wrangler JK

SKID PLATES

Your Jeep® vehicle was built to climb rocks and tear through streams. You don't have to take it easy, because you have the right Skid Plates to protect your Jeep® vehicle from issues like punctured oil pans or bent axles. Our high-quality, OE-approved Skid Plates protect exposed parts, ranging from front suspension and axle components to the transfer case and fuel tank.

Front Bumper Skid Plate

Skid Plate designed to fit under the front bumper. Same as production Rubicon® Skid Plate. For use with the production steel front bumper only.

P/N 82215183AB

2020–2021, Jeep® Gladiator
2018–2021, Jeep® Wrangler JL

Front Bumper Skid Plate

Steering Linkage and Electronic Anti-Sway Bar Disconnect Skid Plate, under bumper. Same as production 10th Anniversary and Rubicon® X. For use on 10th Anniversary and Rubicon® X Bumpers.

P/N 82214330

2007–2018, Jeep® Wrangler JK



SKID PLATES CONTINUED...

Evaporative Fuel Canister Skid Plate

P/N 800RR340

2007–2018, Jeep® Wrangler JK

Transfer Case Skid Plate – steel

P/N 82208712

2005–2010, Jeep® Grand Cherokee



HOOD WINDSHIELD REST BUMPER

Note: 2011 and newer, requires hood bumpers. Quantity: 2.

P/N 68192987AA

2011-2018, Jeep® Wrangler JK

WINDSHIELD TIE-DOWN STRAPS

Windshield Tie-Down Straps are e-coated and powder-coated steel hooks with adjustable straps.

P/N 82215717

2020-2021, Jeep® Gladiator

2018-2021, Jeep® Wrangler JL

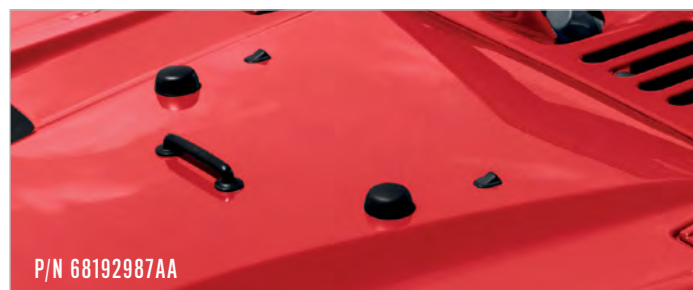

These LED Headlights and Fog Lights provide premium illumination for visibility during brutal weather conditions while minimizing obnoxious glare. With specific designs for each vehicle, you can find lights that give your Jeep® vehicle a premium, integrated look.



LED HEADLIGHTS

LED Headlights provide brilliant performance and off-road durability. These long-life Lights provide excellent roadside lighting, a defined beam pattern and feature the Jeep® Brand logo. The Lights come in a set of 2 and are for use in U.S. (non-daytime running lamps) and Canada (daytime running lamps) only.

Note: Matching Fog Light Kits are sold separately.

P/N 82215136AD

2020-2021, Jeep® Gladiator

2018-2021, Jeep® Wrangler JL

P/N 82214333AB

2011-2018, Jeep® Wrangler JK

LED FOG LIGHTS

P/N 82215163

2020-2021, Jeep® Gladiator

2018-2021, Jeep® Wrangler JL

For Plastic Bumper only.

P/N 82215549

2020-2021, Jeep® Gladiator

2018-2021, Jeep® Wrangler JL

For Rubicon® Steel Bumper and Jeep® Performance Parts Steel Bumpers.

P/N 82214785

2007-2018, Jeep® Wrangler JK

For Rubicon® Steel Bumper only.

P/N 82214674

2007-2018, Jeep® Wrangler JK

For Plastic Bumper only.

P/N 82214785

2007-2018, Jeep® Wrangler JK

For Jeep® Wrangler Rubicon® Hard Rock Steel Bumper.



OFF-ROAD LED LIGHTS*

See the world in a different light with our advanced, LED-technology Off-Road Lights Kit. By emitting an extraordinary actual output lumen count of 4,600 for each 5" Light and 8,000 lumens for each 7" Light in actual output (versus the industry raw count), these Lights provide superior performance without shadows and give increased visibility for a more secure off-road driving experience.

Made with an extremely durable, commercial-grade aluminum body, this Kit has been brutally tested in the field through vigorous shake and water pressure testing (IP69K rated). Each Kit contains 2 LED Lights, covers and wiring harness. The wiring harness includes pigtail with ground eyelet and blunt-cut circuit for power connection. These Kits pair well with our Auxiliary Switch Bank Kits on page 53. Off-Road Lights must remain turned off, or covered, on public roadways.

5" Off-Road LED Light Kit

P/N 82215385AB

2020-2021, Jeep® Gladiator
2018-2021, Jeep® Wrangler JL

7" Off-Road LED Light Kit

P/N 82215386AB

2020-2021, Jeep® Gladiator
2018-2021, Jeep® Wrangler JL

MOUNTING BRACKETS

Lower A-Pillar Mounting Bracket

P/N 82215427AB

2020-2021, Jeep® Gladiator
2018-2021, Jeep® Wrangler JL

Bumper-Mount Light Bracket

P/N 82215428

2020-2021, Jeep® Gladiator
2018-2021, Jeep® Wrangler JL
Note: Mounts directly to frame.

Winch Guard Light Mounting Bracket

P/N 82215729

2020-2021, Jeep® Gladiator
2018-2021, Jeep® Wrangler JL
Note: 2" bracket inside diameter (ID).



AUXILIARY SWITCH BANK KITS

Includes switch bank trim, switches, power distribution centre (PDC), bracket, wiring harness, cubby bin, tie straps and splice kit. Production pickup. Dealership body controller reconfiguration required.

Black

P/N 82215190AD

2020-2021, Jeep® Gladiator
2018-2021, Jeep® Wrangler JL

Chrome

P/N 82215798AD

2020-2021, Jeep® Gladiator
2018-2021, Jeep® Wrangler JL



Constructed of heavy-gauge steel tubing, our fully functional Rock Rails and Tube Steps can take on the toughest trails. Both provide lower body-side protection and meet all FCA production standards for corrosion resistance.

JEEP® PERFORMANCE PARTS ROCK RAILS

Designed with the serious off-roader in mind, these are engineered to provide added lower-body protection to the vehicle. They are roll-formed and use zinc-coated steel for superior corrosion resistance. The outer surface is e-coated and then DuraBull®-coated (truck bedliner coating) to provide superior protection and durability.

P/N 82215606
2020–2021, Jeep® Gladiator

P/N 82215129AB
2018–2021, 2-Door Jeep® Wrangler JL

P/N 82215165AB
2018–2021, 4-Door Jeep® Wrangler JL

BLACK, POWDER-COATED STEEL PRODUCTION RUBICON® ROCK RAILS

P/N 82215605
2020–2021, Jeep® Gladiator

P/N 82215128
2018–2021, 2-Door Jeep® Wrangler JL

P/N 82215126
2018–2021, 4-Door Jeep® Wrangler JL

SATIN BLACK ROCK RAILS

With functional heavy-duty tubular Tube Step. Bolt to existing mounting holes and feature reinforced mounting brackets.

P/N 82210574AH
2007–2018, 2-Door Jeep® Wrangler JK

P/N 82210575AH
2007–2020, 4-Door Jeep® Wrangler JK

SATIN BLACK PRODUCTION RUBICON® ROCK RAILS

P/N 82210585AD
2007–2018, 2-Door Jeep® Wrangler JK

P/N 82210586AD
2007–2018, 4-Door Jeep® Wrangler JK

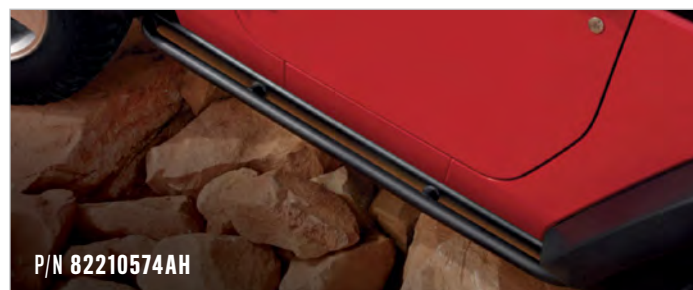

BLACK, POWDER-COATED STEEL ROCK RAILS

P/N 82213941AC
2014–2019, Jeep® Cherokee

P/N 82213525AD
2014–2018, Jeep® Grand Cherokee
Also used on production Trailhawk

P/N 82214641AE
2017–2019, Jeep® Compass

P/N 82214201AG
2015–2020, Jeep® Renegade

TUBE STEPS

Tubular Side Steps add both functionality and style. Available in either chrome or painted black aluminum, these provide superior protection for durability, and feature moulded Steps to provide sure-footed traction. These Steps are installed to the underbody and the sill/pinch weld flange utilizing the same brackets and hardware as the production side step version.

Black

P/N 82215609
2020–2021, Jeep® Gladiator

P/N 82215328AB
2018–2021, 2-Door Jeep® Wrangler JL

P/N 82215327AB
2018–2021, 4-Door Jeep® Wrangler JL

Chrome

P/N 82215610
2020–2021, Jeep® Gladiator

P/N 82215330
2018–2021, 2-Door Jeep® Wrangler JL

P/N 82215329
2018–2021, 4-Door Jeep® Wrangler JL





“JPP accessories is the highlight of my job. I love understanding and solving problems through Design. A big part of what inspires me to design JPP accessories is understanding our customers and enthusiasts and what their needs and demands are.”

NICHO VARDIS
Mopar® Design Manager



FENDER FLARES

Fender Flares allow you to install larger wheels, larger tires and Lift Kits* on your vehicle without tire interference in the wheel well. Assembly creates a low center of gravity for on-road comfort and off-road capability. These high-top flares are the same as production Rubicon® with either LED or halogen daytime running lights. Kit includes four different flares, one designed for each wheel well. Fender Flares meet all FCA standards.

Paintable with LED lights.

P/N 82215984
2020-2021, Jeep® Gladiator



P/N 82215741AC
2018-2021, 2-Door or 4-Door Jeep® Wrangler JL

Moulded in colour black with LED lights.

P/N 82215985
2020-2021, Jeep® Gladiator



P/N 82215743AC
2018-2021, 2-Door or 4-Door Jeep® Wrangler JL

Paintable with halogen lights.

P/N 82215668
2020-2021, Jeep® Gladiator



P/N 82215740AC
2018-2021, 2-Door or 4-Door Jeep® Wrangler JL

Moulded in colour black with halogen lights.

P/N 82215666
2020-2021, Jeep® Gladiator

P/N 82215742AC
2018-2021, 2-Door or 4-Door Jeep® Wrangler JL



TUBE DOOR KITS*

Enjoy the breeze and sun while adding the feeling of security. Mopar® Tube Doors* are constructed of 2" round steel tubes. Sold as a 2-Door Kit and 4-Door Kit.

Note: Do not drive your vehicle on public roads with the original equipment doors removed, as you will lose the protection they can provide. Tube Door Kits* are intended for use during off-road operation only. All occupants must wear seat belts during off-road operation with doors removed or Tube Door Kits installed.

P/N 77072498AB

2020-2021, Jeep® Gladiator
2018-2021, 4-Door Jeep® Wrangler JL

P/N 77072496AC

2018-2021, 2-Door Jeep® Wrangler JL

ADDITIONAL KITS FOR TUBE DOORS*

To make your Tube Door Kit* fully functional, you will need to add these additional parts to your vehicle.

2020-2021, Jeep® Gladiator
2018-2021, 4-Door Jeep® Wrangler JL
2018-2021, 2-Door Jeep® Wrangler JL

P/N 77072562AA

Mirror Kit for Tube Doors

P/N 77072564AA

Mesh Door Covers, Front and Rear

P/N 77072563AA

Mesh Door Covers, Front

GRAB HANDLES

Attach to the front (shown) or rear sport bar, and are made of steel with a sculpted overmold to fit your hand. Feature the Jeep® Brand grille logo.

Front handles

P/N 82215523AB

2020-2021, Jeep® Gladiator
2018-2021, Jeep® Wrangler JL

Rear handles

P/N 82215524AB

2020-2021, Jeep® Gladiator
2018-2021, Jeep® Wrangler JL



ALL-WEATHER FLOOR MATS

High-wall, bucket style to provide maximum coverage and protect your floor from wetness, snow, mud, dirt and grime. Available in black and feature a terrain-style design and the Jeep® Brand logo. The front mats are designed to fit the vehicle floor drain holes to allow for draining without removing the mat. Each mat features nibbed backing and grommets for retention posts to keep them in place.

P/N 82215626AB

2020-2021, Jeep® Gladiator

P/N 82215203AE

2018-2021, 4-Door Jeep® Wrangler JL

P/N 82215202AE

2018-2021, 2-Door Jeep® Wrangler JL

VEHICLE CAB COVERS (TRAIL COVER)

If you're looking for a cab cover, go with a high-quality, weather resistant nylon cap for your ride. With elastic loops that attach around tail lights and mirrors, plus two integrated cords to secure the cover, you'll get a cap that fits snugly over your Jeep® vehicle.

Black, water-resistant nylon.

P/N 82215600

2020-2021, Jeep® Gladiator

P/N 82215371

2018-2021, 2-Door Jeep® Wrangler JL

P/N 82215370

2018-2021, 4-Door Jeep® Wrangler JL

P/N 82210321

2007-2018, 2-Door Jeep® Wrangler JK

P/N 82210323

2007-2018, 4-Door Jeep® Wrangler JK

Silver, heat-reflective.

P/N 82210322AB

2007-2018, 2-Door Jeep® Wrangler JK

P/N 82210324AB

2007-2018, 4-Door Jeep® Wrangler JK

Note: Use without soft and hard tops. Can use with doors on or off the vehicle.





ENGINE COMPONENTS

Amplify your engine's performance with factory-engineered intake and exhaust systems that increase horsepower and torque.



PERFORMANCE INTAKE SYSTEMS



SNORKEL



EXHAUST SYSTEMS



PERFORMANCE INTAKE SYSTEMS

These bolt-on systems are designed to allow cooler outside air to flow through a directional filter, directly into the intake manifold. They provide noticeable horsepower and torque gains under varying atmospheric conditions. Kits include all mounting hardware and a washable/reusable filter. Do not oil Dry Media filters.

Cold Air Intake Systems

Cold Air Intake featuring Jeep® Brand logo and reusable black and silver drop-in filter. Draws fresh air from outside vehicle from hood cutout to increase engine performance. Includes bezel to finish cutout.

P/N 77072433AC

2020, Jeep® Gladiator equipped with 3.6L engine
2018–2020, Jeep® Wrangler JL equipped with 3.6L engine



Additional Jeep® Brand Vehicles Cold Air Intake Systems

P/N 77070052

2012–2018, Jeep® Wrangler JK
equipped with 3.6L engine

P/N 77060081

2007–2011, Jeep® Wrangler JK
equipped with 3.8L engine

P/N 77070054

2012–2017, Jeep® Grand Cherokee
equipped with 6.4L engine

P/N 77070041

2012–2018, Jeep® Grand Cherokee
equipped with 5.7L engine

P/N 77070042

2011–2015, Jeep® Grand Cherokee
equipped with 3.6L engine

P/N 77060011AB

2006–2009, Jeep® Grand Cherokee
equipped with 6.1L engine

P/N 77060010AB

2005–2009, Jeep® Grand Cherokee and
Jeep® Commander equipped with 5.7L engine

Cold Air Intake System With Oiled Filter

P/N P5153368

1997–2003, Jeep® Wrangler TJ
equipped with 4.0L engine

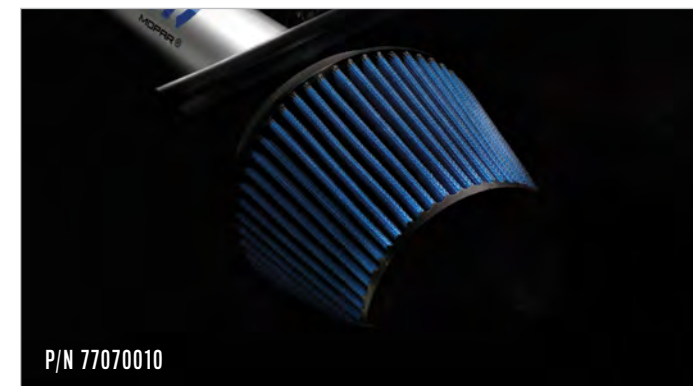

REPLACEMENT FILTERS FOR COLD AIR INTAKE SYSTEMS

Cold Air Intake Replacement Filters, Dry Media

P/N 77070010

For use with: P/N 77060003AC, P/N 77060006AB,
P/N 77060010AB, P/N 77060011AB or P/N 77070008

P/N 77070018

For use with: P/N 77060081 or P/N 77070002

P/N 68198994AA

For use with: P/N 77070041

P/N 68198999AA

For use with: P/N 77070052

P/N P5160245AA

For use with: P/N 77072433AC

HIGH FLOW, OE REPLACEMENT

P/N P5155085

2007–2009, 2002–2007, Jeep® Wrangler JK
equipped with 3.8L engine and Jeep® Liberty
equipped with 3.7L engine

P/N P4510473

1997–2003, Jeep® Wrangler TJ
equipped with 4.0L engine

P/N P4510474

1991–2001, Jeep® Cherokee

P/N P4510475

1999–2004, Jeep® Grand Cherokee



SNORKEL

Snorkel allows you to direct cool air into the engine when driving through conditions that threaten normal air inlets. The Snorkel is designed to fit air boxes on 2.0L and 3.6L engines.

P/N 82215350AC

2020, Jeep® Gladiator
2018-2020, Jeep® Wrangler JL

Note: Not compatible with the Mojave or vehicles with diesel engines.



EXHAUST SYSTEMS

Exhaust systems provide extra gain in performance, which gives your vehicle the capability to reach any destination on- or off-road. Choosing an exhaust system with deeper tone and bolder style will not only personalize your vehicle, but also improves its performance.

Cat-Back Exhaust System

Features T304 stainless steel construction (aircraft quality) with mandrel-bent tubing, stainless band Torca clamps, muffler and polished tips.

P/N P5153858

2007-2009, Jeep® Wrangler JK
equipped with 3.8L engine

Dual Rear Exit

P/N 82215642AB

Cat-Back Exhaust with chrome tips.
2020-2021, Jeep® Gladiator
equipped with 3.6L engine

P/N 82216276AA

Cat-Back Exhaust with black tips.
2020-2021, Jeep® Gladiator
equipped with 3.6L engine

P/N P5160244AA

2018-2021, Jeep® Wrangler JL
equipped with 3.6L engine

P/N 77070085

2014-2017, Jeep® Cherokee
equipped with 3.2L engine

P/N P5007792

2002-2005, Jeep® Liberty
equipped with 3.7L engine

4" Chrome Tips – Center

P/N P5153453

2006-2009, Jeep® Grand Cherokee SRT8®
equipped with 6.1L engine



MOPAR® PARTS & ACCESSORIES LIMITED WARRANTIES

MOPAR® BASIC LIMITED WARRANTY

Subject to the terms and exclusions below, Mopar® Parts and Magneti Marelli Parts offered by Mopar® sold in Canada, on or after October 1, 2014 and installed by an authorized FCA Canada Inc. dealership or studio are warranted against defects in workmanship or materials for 24 months for both parts and labour. Mopar parts sold wholesale to an automotive service facility and installed by a licensed technician are warranted against defects in workmanship or materials for 24 months/unlimited kilometres for parts and up to \$150.00 in labour reimbursement*. Mopar Parts and Magneti Marelli Parts offered by Mopar sold over the counter for vehicle Owner or Do-It-Yourself Installation are warranted for 24 months/unlimited kilometres for parts exchange only. Warranty commences on the retail date of purchase, or the installation date by an installer. Mopar Parts acquired or installed outside of Canada are not covered by the Mopar Basic Limited Warranty.

Mopar Parts and Magneti Marelli Parts offered by Mopar sold in Canada, before October 1, 2014 are covered by the 12 month unlimited kilometres warranty. There is no labour allowance for parts sold wholesale to an automotive service facility.

Mopar Parts which are replaced on an FCA Canada Inc. vehicle and still covered by the FCA New Vehicle Basic Limited Warranty are warranted for the remainder of the New Vehicle Basic 3-year/60,000-kilometre Limited Warranty, or for the Mopar Basic Limited Warranty from the original installation date, whichever is more favourable to the customer.

The Mopar Basic Limited Warranty covers the cost of towing a vehicle to the nearest authorized FCA Canada Inc. dealership if the failure of a covered part causes the vehicle to be inoperative. If a Mopar Part is installed in a FCA Canada Inc. vehicle by an authorized FCA Canada Inc. dealer, and if, while that part is still under warranty, it causes other parts to be damaged or to fail, those other parts will be repaired or replaced under warranty, regardless of whether the other parts were covered by an FCA warranty at the time of failure.

These warranties are the only express warranties made by FCA for Mopar Parts and Accessories and Magneti Marelli Parts offered by Mopar. Except where prohibited by law, this warranty is the sole and exclusive remedy. No person, including a dealer or employee of FCA Canada Inc. or its affiliated corporations, has the authority to vary or change these warranties. In order to validate warranty coverage, the customer must present the Original Bill of Sale.

Mopar Parts sold with a separate manufacturer's warranty are not eligible for the Mopar Basic Limited warranty. Warranty information on these parts is provided with the part or in its packaging. Examples include but are not limited to: Garmin Navigation, TomTom Navigation, Katzkin® Leather, Koss Headphones, Truck Bedliners, Master Shield Rust inhibitor, Paint Sealant and Fabric Protection.

Labour Reimbursement* Installers are eligible for labour reimbursement up to \$150. Installer warranty and labour reimbursement requests must be supported with the following documentation:

- Repair order must include the Vehicle Identification Number (VIN) and repair date
- Warranty concern
- Diagnostic steps taken to correct concern
- Labour time is calculated at installer's hourly rate multiplied by time taken to complete repair
- Labour time to be supported by a published time standard

Exceptions: The following Mopar Parts have time and kilometre limitations, or warranty coverage that differs from the general coverage described above:

- Magneti Marelli offered by Mopar® Alternators and Starters
- Mopar® Batteries
- Mopar® Collision Parts
- Mopar® Windshield Made with Corning Gorilla Glass
- Mopar® and Magneti Marelli offered by Mopar Catalytic Converters
- Mopar® Performance Parts

Note: Mopar Performance Parts with part numbers beginning with "P5" are sold "as-is" without warranty coverage of any kind by Mopar unless otherwise noted. Mopar Performance Parts with part numbers beginning with "PW" are covered by a 12-month/20,000 kilometres warranty. For all part numbers that begin with "77" the warranty is the Mopar Basic Limited Warranty.

- Mopar® Powertrain
- Mopar® Lifetime Limited Warranty on Value Line and Magneti Marelli Offered by Mopar Brake Pads/Shoes, Value Line and Magneti Marelli Offered by Mopar Shocks/Struts and Value Line Mufflers
- Wiper Blades and Light Bulbs remain at 12 months/unlimited kilometres
- Filters are warranted against manufacturing defects within the applicable maintenance interval of the vehicle

MOPAR® PERFORMANCE PARTS LIMITED WARRANTY

Mopar Performance Crate Engine Assemblies - Crate engine assemblies are warranted for "parts only" "as delivered" against defects in materials or workmanship for 90 days from the date of purchase. The following covered components for Performance Engine Assemblies, which prove to be defective in materials or workmanship, will be replaced on an exchange basis for 90 days: cylinder blocks and all internal parts; cylinder head assemblies; intake manifold; core plugs; valve covers; oil pan; timing gear and/or chain and cover; water pump; gasket and seals.

Mopar Performance Parts with part numbers beginning with "P5" are sold "as-is" without warranty coverage of any kind by Mopar unless otherwise noted.

Mopar Performance Parts with part numbers beginning with "PW" are covered by a 12-month/20,000 kilometres warranty.

For all part numbers that begin with "77" the warranty is the Mopar Basic Limited Warranty.

Warranty information contained in this document is accurate at time of print, but is subject to change. For the most current Mopar Parts Warranty information, visit www.mopar.ca.





1240 ©2020 FCA Canada Inc. All Rights Reserved. Chrysler, Dodge, Jeep, Ram, Mopar, the Jeep grille, Mopar Vehicle Protection, Rubicon, Sahara, Trail Rated, Uconnect, Willys and Wrangler are registered trademarks and Trail Rail is a trademark of FCA US LLC. FIAT is a registered trademark of FCA Group Marketing S.p.A., used with permission.

Dana and AdvanTEK are registered trademarks and Dana44 is a trademark of Dana Limited. DuraBull is a registered trademark of PPG Industries Ohio, Inc. FOX is a registered trademark of Fox Factory, Inc. Sunrider is a registered trademark of Bestop, Inc. Katzkin and the Katzkin logo are registered trademarks of Katzkin Leather Interiors, Inc. WARN, the WARN logo and Spydura are registered trademarks of Warn Industries.

Do not attempt water fording unless depth is known and consistent with the vehicle's water fording rating in the Owner's Manual. Traversing water can cause damage that may not be covered by the new vehicle warranty. Always off road responsibly in approved areas.

