

AUTEL[®]

MaxiSys[™]

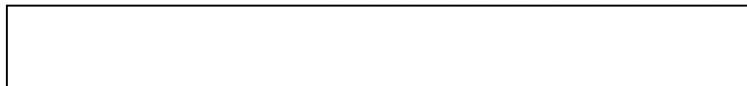

Autel[®], MaxiSys[™], MaxiDAS[®], MaxiScan[®], MaxiTPMS[®], MaxiVideo[™],
MaxiRecorder[™] MaxiCheck[™]
Autel Intelligent Technology Co. Ltd,

(, , ,)
Autel.

Autel

Autel
()
).

!

:



pro.auteltech.com
www.auteltech.com



8 800 300910 (Украина)



info@autel-ukraine.com.ua



!



!

Autel.

Autel



!



:

•

•

ANSI.

•

•

•

)

NEUTRAL (

)

PARK (

•

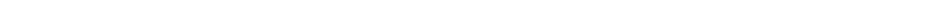

•

,

,

.

.

•

,

,

.

•

.

•

,

.

.

,

.

•

.

.

•

,

.

/

.

•

,

,

•

.

.

1.1	УСЛОВНЫЕ ОБОЗНАЧЕНИЯ	1
1.1.1	<i>Полужирный текст</i>	1
1.1.2	<i>Терминология</i>	1
1.1.3	<i>Примечания и важные сообщения</i>	1
1.1.4	<i>Гиперссылки</i>	2
1.1.5	<i>Процедуры</i>	2
2.1	ДИАГНОСТИЧЕСКИЙ СКАНЕР MAXiSYS	3
2.1.1	<i>Функциональное описание</i>	4
2.1.2	<i>Источники электропитания</i>	6
2.1.3	<i>Технические характеристики</i>	6
2.2	ИНТЕРФЕЙС СВЯЗИ С АВТОМОБИЛЕМ: ДИАГНОСТИЧЕСКИЙ ИНТЕРФЕЙС BLUETOOTH	8
2.2.1	<i>Функциональное описание</i>	8
2.2.2	<i>Технические характеристики</i>	9
2.2.3	<i>Источники электропитания</i>	9
2.3	ИНТЕРФЕЙС СВЯЗИ С АВТОМОБИЛЕМ: ПРОГРАММАТОР J2534 ДЛЯ ЭЛЕКТРОННЫХ БЛОКОВ УПРАВЛЕНИЯ	9
2.3.1	<i>Функциональное описание</i>	10
2.3.2	<i>Источники электропитания</i>	11
2.3.3	<i>Технические характеристики</i>	12
2.4	КОМПЛЕКТ ДОПОЛНИТЕЛЬНЫХ ПРИНАДЛЕЖНОСТЕЙ	13
2.4.1	<i>Коммуникационный кабель</i>	13
2.4.2	<i>Адаптеры OBD I</i>	13
2.4.3	<i>Прочие аксессуары</i>	14
3.1	ВКЛЮЧЕНИЕ ЭЛЕКТРОПИТАНИЯ	16
3.1.1	<i>Кнопки приложений</i>	17
3.1.2	<i>Указатель и кнопки навигации</i>	19
3.1.3	<i>Значки состояний системы</i>	21
3.2	ВЫКЛЮЧЕНИЕ ЭЛЕКТРОПИТАНИЯ	22
3.2.1	<i>Перезагрузка системы</i>	22
3.3	УСТАНОВКА ПРОГРАММНОГО ОБЕСПЕЧЕНИЯ	22
3.3.1	<i>Выполнение печати</i>	23
4.1	УСТАНОВКА СВЯЗИ С АВТОМОБИЛЕМ	25
4.1.1	<i>Подключение к автомобилю</i>	25
4.1.2	<i>Подключение через интерфейс связи с автомобилем</i>	28
4.1.3	<i>Отсутствие связи</i>	32
4.2	НАЧАЛО РАБОТЫ	33
4.2.1	<i>Структура меню выбора марки автомобиля</i>	34
4.3	ИДЕНТИФИКАЦИЯ АВТОМОБИЛЯ	36
4.3.1	<i>Автоматическое сканирование VIN-номера</i>	37

4.3.2	Ручной ввод VIN-номера.....	38
4.3.3	Выбор автомобиля вручную.....	39
4.3.4	Альтернативный вариант идентификации автомобиля.....	43
4.4	НАВИГАЦИЯ.....	43
4.4.1	Структура окна диагностики.....	43
4.4.2	Экранные сообщения.....	47
4.4.3	Выполнение выбора.....	48
4.5	ГЛАВНОЕ МЕНЮ.....	49
4.6	ДИАГНОСТИКА.....	49
4.6.1	Данные электронного блока управления.....	55
4.6.2	Считывание кодов.....	56
4.6.3	Стирание кодов.....	57
4.6.4	Оперативные данные.....	Ошибка! Закладка не определена.
4.6.5	Активная диагностика.....	66
4.6.6	Специальные функции.....	68
4.7	СЕРВИСНОЕ ОБСЛУЖИВАНИЕ.....	70
4.7.1	Описание функций.....	70
4.8	ПРОГРАММИРОВАНИЕ И КОДИРОВАНИЕ.....	72
4.9	ОСНОВНЫЕ ОПЕРАЦИИ OBD II.....	78
4.9.1	Общая процедура.....	78
4.9.2	Описание функций.....	80
4.10	ЗАВЕРШЕНИЕ ДИАГНОСТИКИ.....	86
5.1	ОПЕРАЦИИ.....	87
5.1.1	Файлы изображений.....	88
5.1.2	Файлы в формате PDF.....	90
5.1.3	Просмотр данных.....	90
5.1.4	Раздел Apps Manager [Менеджер приложений] (скоро будет добавлена дополнительная информация).....	91
5.1.5	Раздел Message [Сообщение] (скоро будет добавлена дополнительная информация).....	Ошибка! Закладка не определена.
5.1.6	Раздел Data Logging [Регистрация данных] (скоро будет добавлена дополнительная информация).....	92
6.1	НАВИГАЦИЯ.....	93
6.1.1	Терминология.....	95
6.2	ОПЕРАЦИИ.....	98
6.2.1	Главное окно.....	98
6.2.2	Ваше облако.....	99
6.2.3	Поиск исправления.....	102
6.2.4	Вопросы и ответы.....	103
6.2.5	Поддержка.....	103
7.1	ОПЕРАЦИИ.....	105

7.1.1	Выбор единиц измерения.....	105
7.1.2	Выбор языка интерфейса.....	106
7.1.3	Настройка печати.....	106
7.1.4	Проводная сеть.....	107
7.1.5	Служебные сообщения.....	108
7.1.6	Получение дополнительной информации.....	109
7.1.7	Настройка системы.....	110
8.1	ИСТОРИЯ АВТОМОБИЛЯ.....	112
8.1.1	Окно архивной диагностики.....	113
8.2	ИНФОРМАЦИЯ О МАСТЕРСКОЙ.....	116
8.3	МЕНЕДЖЕР ЗАКАЗЧИКОВ.....	117
8.3.1	Примечания к истории.....	119
10.1	УСТАНОВЛЕНИЕ СВЯЗИ ЧЕРЕЗ ИНТЕРФЕЙС BLUETOOTH.....	126
10.2	ПРОВОДНОЕ СЕТЕВОЕ ПОДКЛЮЧЕНИЕ.....	128
11.1	ОПЕРАЦИИ.....	130
12.1	РЕГИСТРАЦИЯ СКАНЕРА.....	133
12.2	СТРУКТУРА ОКНА ПРИЛОЖЕНИЯ ПОДДЕРЖКИ.....	134
12.3	Окно личной учетной записи.....	136
12.4	ОБРАЩЕНИЯ ПОЛЬЗОВАТЕЛЕЙ.....	137
12.5	СООБЩЕСТВА ПОДДЕРЖКИ.....	140
12.6	ОБУЧАЮЩИЕ ВИДЕОЗАПИСИ.....	143
12.7	БАЗА ДАННЫХ СЛУЖБЫ ПОДДЕРЖКИ.....	144
16.1	ДОПОЛНИТЕЛЬНЫЕ ПРИНАДЛЕЖНОСТИ.....	150
16.2	ОПЕРАЦИИ.....	153
18.1	ИНСТРУКЦИИ ПО ТЕХНИЧЕСКОМУ ОБСЛУЖИВАНИЮ.....	157
18.2	КОНТРОЛЬНЫЙ ПЕРЕЧЕНЬ ДЛЯ УСТРАНЕНИЯ НЕИСПРАВНОСТЕЙ.....	158
18.3	ДОПОЛНИТЕЛЬНАЯ ИНФОРМАЦИЯ ОБ ИСПОЛЬЗОВАНИИ АККУМУЛЯТОРНОЙ БАТАРЕИ	159
18.4	СЕРВИСНЫЕ ПРОЦЕДУРЫ.....	161

1

MaxiSys.

1.1

1.1.1



1.1.2

« »

1.1.3

! —

1.1.4

()

,

.

1.1.5

.

:

➤

:

1

Camera [].

2

,

3

.

.

,

.

2

MaxiSys™/MaxiSys Pro™

9,7-

A9

1,40

Android,

MaxiSys

MaxiSys

MaxiSys --

(VCI) --

Autel

VCI,

J2534,

Bluetooth ()

2.1

MaxiSys

2.1.1

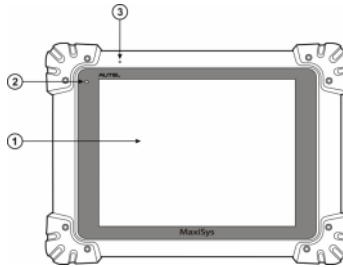

2-1 MaxiSys ()

1. 9,7-

2. -

3.

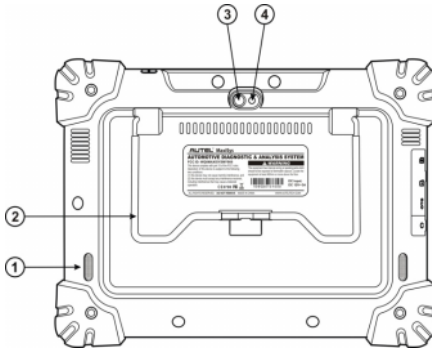

2-2 MaxiSys ()

1.

2. -

30°

- 3.
- 4.

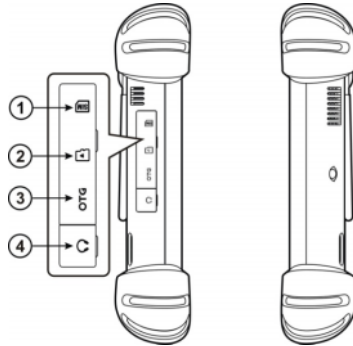

2-3

MaxiSys ()

1. SIM- ()
2. Mini SD (secure digital) ()
3. Mini USB ()
- 4.

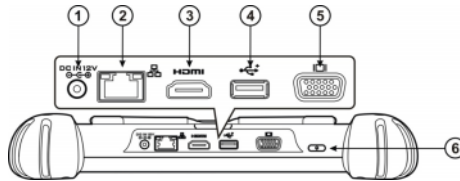

2-4

MaxiSys ()

- 1.
2. Ethernet
3. HDMI ()
4. USB
5. VGA ()
6. / - MaxiSys,

2.1.2

MaxiSys

:

-
-
-

6,5

2.1.3

Android™ 4.0 (Ice Cream Sandwich)

Samsung

Exynos 1,4

2 ,
9,7-

32

1024 x 768

- Ethernet:

- RJ45 (Ethernet) : 3G/4G
- (WCDMA LTE)
- Wi-Fi (802.11 a/b/g/n)
- USB: 2.0
- Bluetooth (2.1) + EDR , 5
- (ALS)
-
-
- 4-
- 3,5
- - , 11
- 000 , 3,7
-
- 12 (9-24) 12
- 6,5
- -10 +55°C (14 131°F)
- -20 +70°C (-4 +158°F)

) (300 x 220 x 50

: 1,42 ; (MaxiSys): 8,655 ; (MaxiSys Pro): 8,052

ISO 9142-2, ISO 14230-2, ISO 15765-4, K/L
 lines, Flashing Code, SAE-J1850 VPW,
 SAE-J1850 PWM, CAN ISO 11898,
 Highspeed, Middlespeed, Lowspeed
 Singlewire CAN, GM UART, UART Echo Byte
 Protocol, Honda Diag-H, TP 2.0, TP 1.6, SAE
 J1939, SAE J1708, Fault-Tolerant CAN

2.2

Bluetooth

2.2.1

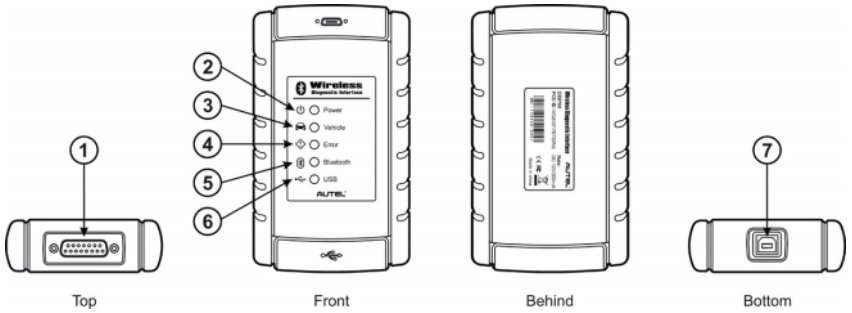

2-5

Bluetooth

MaxiSys

- 1. (15-)
- 2. — ,
- 3. —
- 4. — ;
- 5. Bluetooth — /
- 6. MaxiSys Bluetooth; —
- 7. USB MaxiSys USB-

J2534 ECU

:

Bluetooth
Bluetooth USB.
MaxiSys
Bluetooth
50
VCI.

2.2.2

• Bluetooth (2.1) + EDR
• USB 2.0
2,4
12 (.)
200 12 (.)
: 0°C +50°C
: -20°C +70°C
(x x) 147,5 x 85,5 x 29,0
0,215

2.2.3

Bluetooth
12
OBD II- EOBD-
(DLC).

2.3

:

J2534

2.3.1

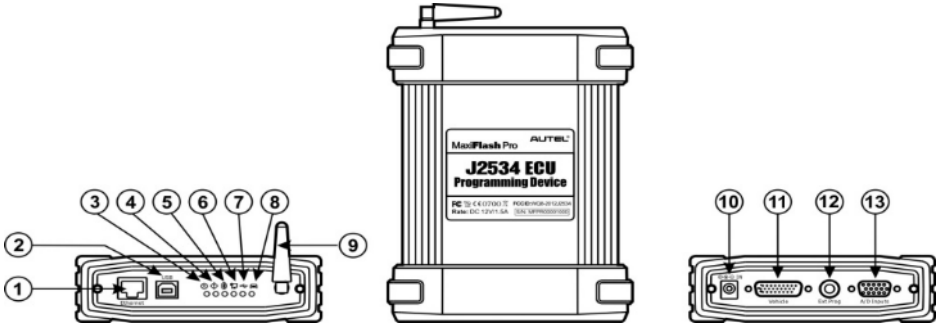

2-6

J2534 ECU,
MaxiSys Pro

- | | | | |
|----|-----------|---------|----------|
| 1. | | | Ethernet |
| 2. | USB | | |
| 3. | | — | |
| 4. | | — | |
| 5. | Bluetooth | — | MaxiSys |
| | Bluetooth | | |
| 6. | Ethernet | — | MaxiSys |
| | Ethernet | | |
| 7. | | USB — | |
| | | MaxiSys | |
| | USB- | | |
| 8. | | — | |

!

!

J2534 ECU

9. Bluetooth

10.

11. (26-)

12.

13. -

J2534

J2534 ECU

- Pass Thru
SAE J2534-1 SAE J2534-2.

(),

J2534 ECU

: Bluetooth, Ethernet USB.

MaxiSys

Bluetooth

50 .

VCI.

2.3.2

J2534

:

J2534 ECU

-
-

J2534
12

OBD II- EOBD-
(DLC). OBD II-
EOBD-

J2534

2.3.3

- Ethernet:
RJ45 (Ethernet)
- Bluetooth
- USB 2.0

6 26 (.)

300 6 (.)

200 12 (.)

110 24 (.)

: 0°C +60°C

: -65°C +100°C

(x x) 183,8 x 135,5 x 41,0
0,54

J2534 ECU.

2.4

2.4.1

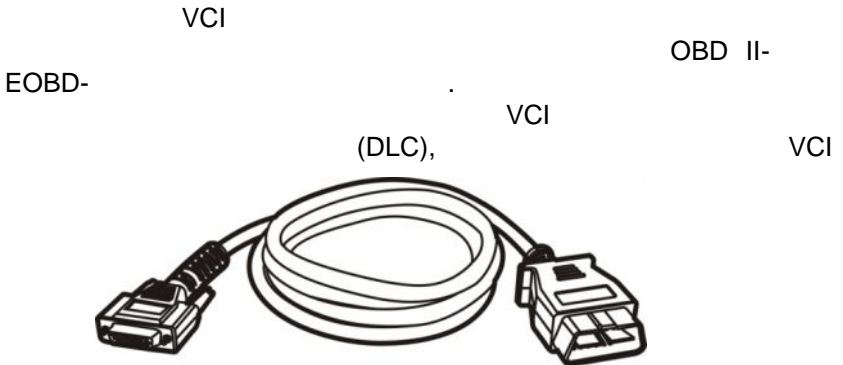

MaxiSys.

2-7

1,5

2.4.2

OBD I

OBD I

OBD II.



Benz-14



Chrysler-16



BMW-20



Kia-20



Nissan-14



GM/Daewoo-1
2



Honda-3



Fiat-3



PSA-2



Benz-38



VW/Audi-2+2



Chang'an-3



Mitsubishi/Hyundai -12+16

2.4.3



USB- (USB 2.0)
VCI.



Mini USB



/

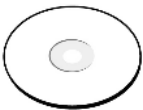

-

,

,

,



Ethernet

Pro).

VCI (

MaxiSys

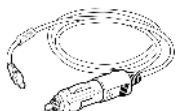

J2534

OBD II



J2534

(

MaxiSys Pro).

3

MaxiSys

2.1.2

6).

3.1

MaxiSys.



3-1





MaxiSys







- 1.
- 2.
- 3.





3.1.1

MaxiSys



3-1





Diagnostics []		25.
Data Manager []		87.
MaxiFix [MaxiFix]		MaxiFix, MaxiFix 93.
Settings []		MaxiSys 105.
Shop Manager []		

<p>]</p>		<p>Shop Manager 111.</p>
<p>Update []</p>		<p>MaxiSys 122.</p>
<p>VCI Manager [VCI]</p>		<p>Bluetooth-VCI Manager 125. <i>VCI</i></p>
<p>Remote Desk []</p>		<p>TeamViewer. <i>Remote</i> Desk 130.</p>
<p>Support []</p>		<p>Autel MaxiSys. 133.</p>
<p>Remote Program []</p>		<p>Pass-Thru, (145. ()</p>

Training []		145.
Quick Link []		148.
Digital Inspection []		149.
Scope []		Scope (156. ())

3.1.2

Locator []		
Back []		
Home []		Android.
Recent Apps []		

Chrome [Chrome]		- Chrome.
Camera []		.
Display & Sound []		.
VCI []		[VCI]. VCI Manager VCI.
MaxiSys [MaxiSys]		MaxiSys Android.

➤

:

1. **Camera** [].
2. ,
3. ,
4. ,
5. **Back** [] **Home** [],

Android.

3.1.3

Android.

MaxiSys

Android.

Android.

3.2

MaxiSys.

VCI,

Diagnostics

[]



MaxiSys:

1.

/

2.

-

3.2.1

/

8

3.3

MaxiSys/MaxiSys Pro

MaxiSys,
(Setup.exe).

1. PC Link [PC Link] –

MaxiSys

2. **Driver Program** [] – VCI.
3. **Network Configuration Program and Update Agent** [] – VCI (J2534 ECU).
4. **Update Agent** [] – VCI (Bluetooth).

➤

Setup.exe

1. -
2. Next [].
3. **Change** [],
Next [],
Next [],
4. **Install** []

3.3.1

MaxiSys

➤

1. PC Link ()

2.

Bluetooth

Ethernet.

[7.1.3](#)

106.

3. Printing Services []

4. **Print [],**

MaxiSys.

5. **Printer Server []**

6. **Print [],**

Printing Services []

VCI,

/

4

VCI

Diagnostics []

Diagnostics []

4.1

MaxiSys/MaxiSys Pro
VCI,

OBD II).

(

MaxiSys,

1.

VCI

2.

MaxiSys,

VCI

Bluetooth-, USB-
Ethernet

Ethernet-

J2534.

3.

VCI,

MaxiSys/MaxiSys Pro

4.1.1

VCI

OBD II

•

OBD II,

12 (.

J-1962).

•

OBD II

12 ,

OBD II

➤

OBD II

1.

VCI),

(.

2.

16-

OBD II

OBD I,

OBD II:

•

•

•

➤

OBD II

1.

VCI),

(.

2.

OBD I,

16-

3.

OBD I

➤

1.

2.

➤

Pro)

(*MaxiSys*

1.

(,) VCI
MaxiSys Bluetooth, VCI,

➤ VCI Bluetooth MaxiSys

1. MaxiSys, VCI
2. MaxiSys. VCI Manager [VCI]
3. VCI] VCI Manager [VCI, Bluetooth. Setting []

VCI

Scan [] VCI,

4. VCI
Maxi

5.

Paired []

6.

VCI

VCI

Bluetooth [10.1](#)
126.

USB-

USB-

MaxiSys

VCI.

VCI

USB-VCI ()

USB

VCI,

MaxiSys/MaxiSys Pro

USB-

MaxiSys

USB-

Ethernet

MaxiSys

J2534 ECU,
Pro.

MaxiSys

Ethernet-



- 1. **VCI** **Ethernet** **MaxiSys**
MaxiSys,
- 2. MaxiSys
J2534 ECU,
Ethernet
- 3. **VCI Manager [VCI]**
MaxiSys.
- 4. **Wired Network []**
Connection Mode [].
Ethernet Setting
[Ethernet].
- 5. :
• **DHCP [DHCP] –** IP-
• **Manual [] –** IP-
- 6. **Manual [],**
IP-

- 7. **Apply [],**
Ethernet Connected [],

VCI
MaxiSys Pro

128. [10.2](#)

VCI MaxiSys/MaxiSys Pro

4.1.3

- A.
- VCI, MaxiSys
- VCI,
- VCI
 - VCI
 - VCI
 - VCI
 - VCI
 - VCI

•

VCI.

•

, Bluetooth, Ethernet

VCI
USB.

•

VCI.

B.

VCI

•

VCI

•

•

•

•

•

•

4.2

[]

MaxiSys,

Diagnostics
VCI

125.

4.2.1

[] VCI MaxiSys, MaxiSys Diagnostics









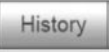

4-2

- 1.
- 2.

4-1

Home []		MaxiSys.

VIN Scan [VIN-]		Auto Detect [] , VIN- Manual Input [] , VIN-
All []		
History []		 8.1 112.
USA []		

Europe []		
Asia []		
Domestic []		
Search []		
Cancel []		

VCI

PDF-

(, . .)

4.3

MaxiSys

1. VIN-
2. VIN-
- 3.
4. OBD

4.3.1

VIN-

MaxiSys
VIN-

CAN.

VIN-

1. **Diagnostics []**

MaxiSys.

(4-2)

2. **VIN Scan [VIN-]**

3. **Auto Detect []**

VIN-

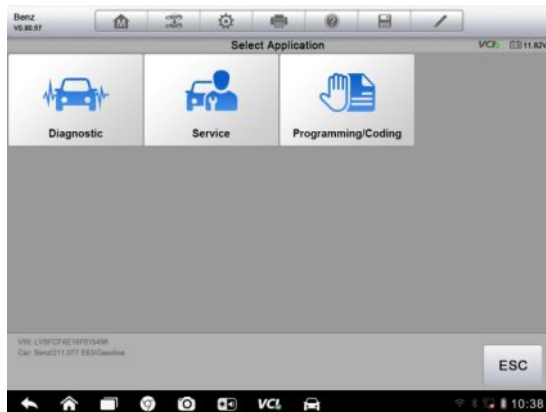

4-3

4.3.2

VIN-

VIN-
VIN-

MaxiSys

VIN-



VIN-

1. **Diagnostics []**
MaxiSys.
(4-2)
2. **VIN Scan [VIN-]**
3. **Manual Input []**
4. VIN-



4-4 VIN-

5. **Done []**

(4-3)

6. **Cancel** [],

4.3.3

VIN-

VIN- e ,

A.

Back

[]

B.

➤

(*Ford*)

1. **Diagnostics** []

MaxiSys.

. ([4-2](#))

2. **USA** [] **All** []

3. **Ford** [Ford]

4. **Manual Vehicle Entry** [
]
 (**4-5**).

Yes [],

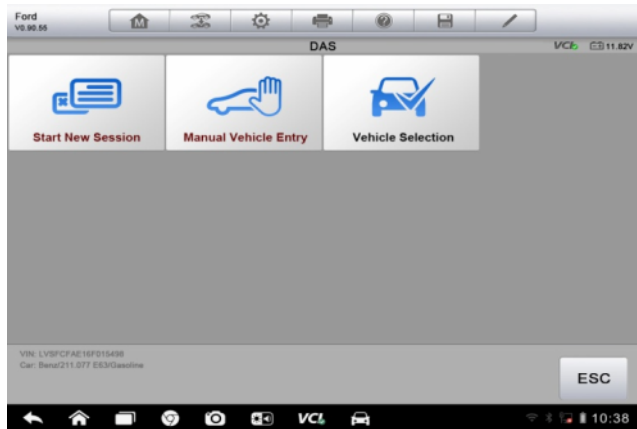

4-5

5. : **PCM Part Number**
 [], **Calibration Number** [
] **Tear Tag** [].

6. **PCM Part Number**
 [],



4-6

7.

8.

a) Yes [],

b) No [],

9.

Yes []
 (4-3)

C.

1.

MaxiSys.

Diagnostics []

(Ford)

-
2. . ([4-2](#))
USA [] All []
 3. Ford [Ford]
 4. Session [] Start New

5.

a) Yes [],

b) No [],

6.

Yes []

.(4-3)

4.3.4

OBD II

78.

OBD II
4.9

OBD,
EOBD.

4.4

4.4.1

4-7)

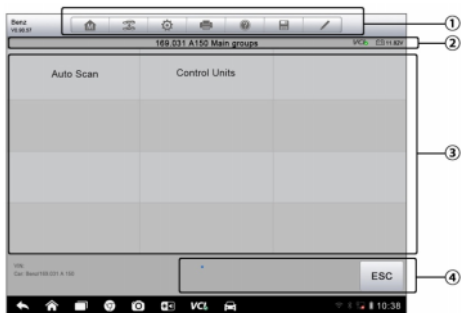





4-7

- 1.
- 2.
- 3.
- 4.

4-2

Home []		MaxiSys.
Vehicle Swap []		
Settings []		105.

Print []		3.3.1 23.
Help []		
Save []		<ul style="list-style-type: none"> • [Save This Page], • [Save All Data], PDF- (• [Start Saving] () Data Manager [] 87.
Data Logging []		()



1.

MaxiSys.

Diagnostics []
Print []

2. **Print** [] .

a) **Print This Page** [] –

b) **Print All Page** [] –
PDF-

3. ,

4. .

Bluetooth

Ethernet.

[3.3.1](#)

23.

1. –

2. **VCI** –

VCI.

3. –

4.4.2

C

4.4.3

Diagnostics [] ,

4.5

Diagnostics []

VCI

()

(4-3)

1. **Diagnosis** [] –

2. **Service** [] –

3. **Programming/Coding** [/] –

VCI

4.6

Diagnosis [] :

1. **Auto Scan** [] –

2. Control Units [] –

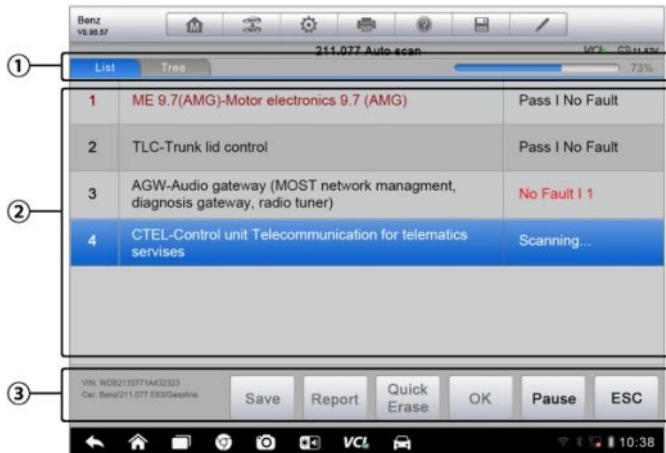

4-8

- 1.
- 2.
- 3.
-
- 1.

List [] –

2. Tree [] -

3. -

•

A. List []

1 -

2 -

3 -

-!-:

-?-:

Fault | #: [| #:] (#)

Pass | No Fault: [| :]

B. Tree []

Function Menu [] (4-9).

-

4-3

Back []	
Pause []	Continue []
OK []	
Quick Erase []	
Report []	
Save []	

Control Units []

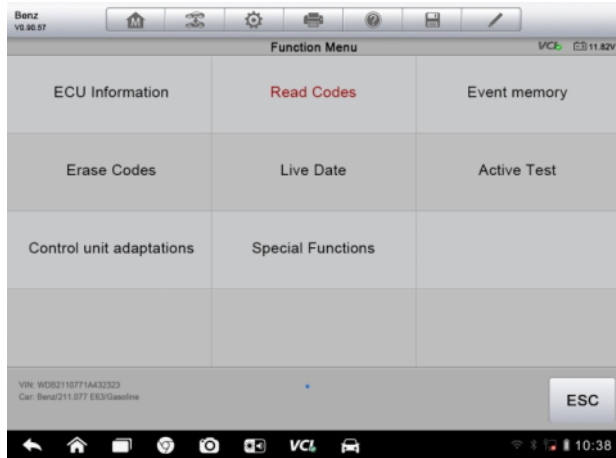

4-9

●ECU Information [] –

●Read Codes [] –

●Erase Codes [] –

•Live data [] –

•Active Test [] –

Actuators [],
Actuator Test []
Function Tests []

•Special Functions [] –

Control Unit Adaptations [],
Special Functions [],
Variant Coding [], Configuration []



1. VCI.
- 2.
3. **Diagnosis []**.
- 4.

Control Units []

].

5.

4.6.1

ECU Information

[].

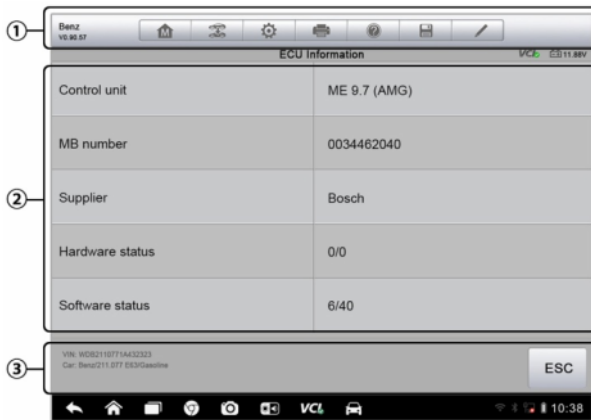

4-10

1.

4-2

44.

2.

3.

Back [] (ESC).

4.6.2

Read

Codes []

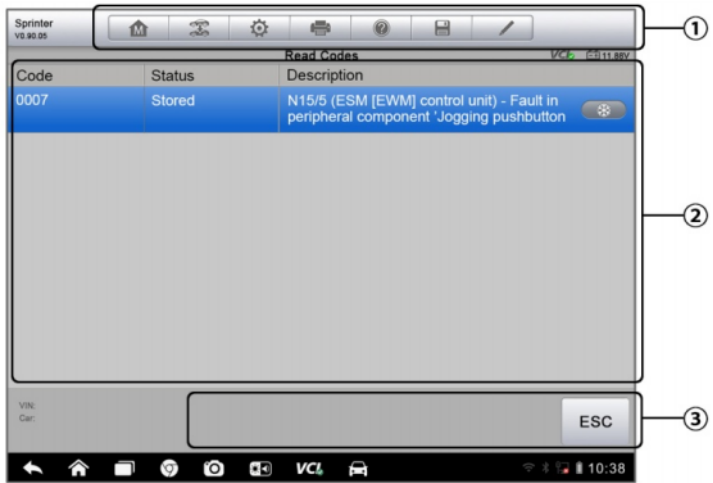

4-11

1. 4-2
44.

- 2.
- C Code [] -
 - Status [] -
 - Description [] -
 - -

-
3. **Back [] (ESC).**

4.6.3

On []

1. **Erase Codes []**
2.
 - a) **[Yes],**
 - b) **No [],**
3. **ESC**
- 4.

4.6.4

Parameter ID	Parameter Name	Value	Min/Max	Unit
PR064	WATER TEMPERATURE	-273.0	-273.0/-173.0	°C
PR055	ENGINE SPEED			
PR312	MANIFOLD PRESSURE	0.2	0/1	bar
PR071	COMPUTER SUPPLY VOLTAGE	0.5	0.0/1.0	V
PR887	THROTTLE VALVE SAFE MODE VAL.	0.3	0/1	%
PR469	CYLINDER 1 KNOCK VALUE	1		
PR471	CYLINDER 1 KNOCK VALUE	0.6		
PR473	CYLINDER 1 KNOCK VALUE	0.36		
PR475	CYLINDER 1 KNOCK VALUE	2		

4-12

1.

) (

4-2

44.

2.

- Name [] -

a)

b)

- Value [] -
- Range [] -
- Unit [] -



[]

Setting

[7.1.1](#)

105.

3.

4

Help [],

Analog Gauge [] -

Text [] -

(
[], ABORT [], (ON [], OFF [], ACTIVE

Waveform Graph [] -

- Text [] -
- Scale [] -
: x1, x2, x4 x8.
- Zoom-in [] -

Digital Gauge [] -

Full Screen Display [] -

- Edit [] -
- Scale [] -
: x1, x2, x4 x8.
- Zoom-out [] -

1.

2. Zoom-in [],

3. **Edit []**,

4.

5.

6.

7. , 4 7,

8. **Done []**,

Cancel

[]

4.

Back [] -

Record [] -

Data Manager [

]

Freeze [-] -

- **Previous Frame [] -**

- **Next Frame [] -**

Resume [] -

Flag [] -

Data Manager []

Clear Data [] -

To Top [] -

Graph Merge [] -

()

2-3

2-3

e



Show Selected [] -

/Show all [] -

Setting [] –

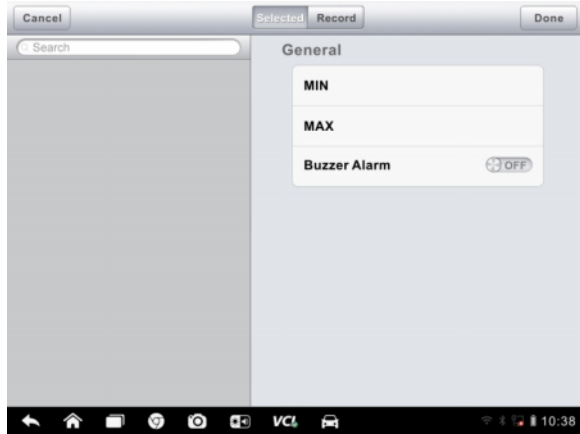

4-13

- Range [] –

a) MIN [] –

b) MAX [] –

c) Buzzer Alarm [] –



1. **Setting** []
Live data [].
 2. **Range** [].
 3. **Search** [].
 4. **MIN** []
 5. **MAX**
[]
 6. **ON/OFF** [/],
Buzzer Alarm [],
 7. **Done** [],
Cancel [],
(
) ,
,
- **Record** [] –
a) **Trigger Type** [] –

1) **Manual** [] –

2) **DTC** [] –

3) **DTC Check Mode** [] –

4) **Parameter** [] –

b) **Duration** [] –
()

c) **Trigger Point** [] –
()



1. **Setting** []
Live data []

2. **Record** []

3. **Trigger Type** []

4. **Duration** []

5. **Trigger Point** []

6. Done [],
Cancel [],

- Done [] -
- Cancel [] -

4.6.5

Active Test []

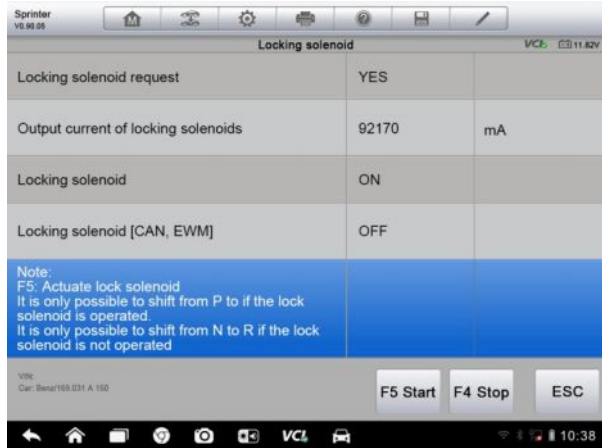

4-14

, Command Finished []
, Activation Successful []

ESC,

4.6.6

1.

Activated [, , Completed [],

2.

3.

4.

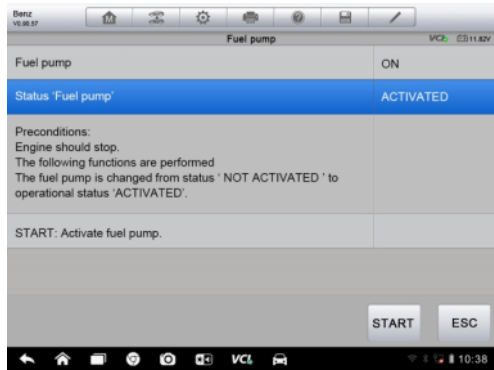

4-15

Completed [], Finished [] Successful
[].

ESC,

4.7

Service []

) (), (

:

-
-
-
-
-
-

4.7.1

Oil Life Reminder [

]

(TPMS)

4.8

OBD II

-
- -
 -
 -
 -

J2534,

A. **Coding** [] –

B. **Reprogramming** **Operations** []

] -

(

MaxiSys

,

)

,

.

.

,

.

.

.

.

,

.

,

,

.

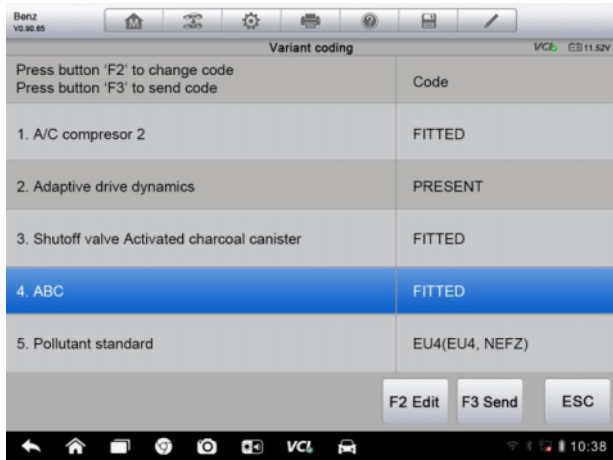

4-16

Variant Coding [

]

1.

2.

3.

Send []

[], Finished [], Successful [], Completed

ESC,

VIN-



4-17

	!	,	.
		,	.
.	,	,	.
	,	,	.
,			.

4.9

OBD II

II/EOBD (4-2).

(MIL),

II- EOBD-

4-2
44.

OBD

OBD

OBD

4.9.1



II/EOBD

1. **MaxiSys. Diagnostics []**

2. **EOBD []**

• **Auto Scan [] –**

• **Protocol [] –**

3. **Protocol []**



OBD II.

4-18

OBD II

4.

- DTC & FFD []
- I/M Readiness []
- Live Data []
- O2 Sensor Monitor []
- On-Board Monitor []
- Component Test []
- Vehicle Information []
- Vehicle Status [C]

4.9.2

DTC & FFD []

Trouble Codes		
Code	Status	Description
P0001	Stored	Fuel Volume Regulator Control Circuit/Open
P0002	Stored	Fuel Volume Regulator Control Circuit Range/Performance
P0003	Stored	Fuel Volume Regulator Control Circuit Low
P0004	Stored	Fuel Volume Regulator Control Circuit High
P0005	Stored	Fuel Volume Regulator Control Circuit/Open
P0006	Stored	Fuel Volume Regulator Control Circuit Low
P0007	Stored	Fuel Volume Regulator Control Circuit High

VIN: LV9FCAE19F016498
 Car: Benz211.077 EEMGasoline

Clear DTC ESC

4-19

OBD II/EOBD

MIL

a)

40-80

b)

e

MIL).

(

«

»

Complete [] Not Ready [] Not
].

Yes [],
No [],

I/M Readiness []

●Since DTCs Cleared []

●This Drive Cycle [] –

Live Data []

Monitor [

]

O2 Sensor

,

e

,
CAN.

,

CAN,

,

(VIN-),

(CVN)

,

OBD II,

(MIL)

,

4.10

Diagnostics []

Diagnostics []

, USB-



1.

Back [] **ESC**,

;

2.

Vehicle Swap [],

,

3.

[],

;

Back []

Home

4.

Home []

MaxiSys.

Diagnostics []

,

MaxiSys

MaxiSys

Android.

5

Data Manager []

Data Manager []



5-1

5.1

Data Manager []

5.1.1

Image []
 JPG-



5-2

1.

JPG Database [5-1

JPG]



88.

2.





5-1

JPG Database

[JPG]

<p>Back []</p>		
<p>Enter []</p> <p>Edit</p>		

Data Manager

Cancel []		
Search []		
Info []		
Print []		
Delete []		



1. MaxiSys **Data Image**
[]
2. **Image** [],
JPG-
- 3.
- 4.
5. **Info** [],
6. **Edit** [],
- 7.
8. **Done** [], **Cancel**
[]



Data Manager

1. MaxiSys **Data Image**
[].

2. **Image** [],
JPG-

3. **Enter Edit** [],

4.

5. **Delete** [], **Delete**
Selected [].

5.1.2

PDF

PDF [PDF]

PDF-
PDF-

PDF-

Reader

Adobe

Adobe Reader.

5.1.3

Review Data []

Data Manager

Review Data []

①

Name		Value	Unit
<input type="checkbox"/> BUS Power Mode	⊙	Accessory	
<input type="checkbox"/> Transport Mode	⊙	Active	
<input type="checkbox"/> Vehicle Speed	⊙	20	km/h
<input type="checkbox"/> Vehicle Speed (CAN-Bus)	⊙	20	km/h
② <input type="checkbox"/> Engine Speed	⊙	642	rpm
<input type="checkbox"/> OverSpeed Warning	⊙	Off	
<input type="checkbox"/> OverSpeed Function	⊙	Inactive	
<input type="checkbox"/> OverSpeed Buzzer	⊙	Enabled	
<input type="checkbox"/> Displayed Fuel Level	⊙	5	%

③

The screenshot shows a mobile application interface for reviewing vehicle data. It features a table with columns for Name, a status indicator (radio button), Value, and Unit. The table lists various parameters such as BUS Power Mode, Transport Mode, Vehicle Speed, Engine Speed, and OverSpeed Warning. Below the table is a control bar with a blue progress indicator and navigation icons. At the very bottom, an Android-style navigation bar is visible with icons for back, home, recent apps, and a dock containing icons for navigation, home, and a 'VCL' app.

5-3

1.

2.

3.

Back [],

5.1.4

Apps Manager [] (

)

MaxiSys.

5.1.5

Data Logging [

] (

48

6

MaxiFix

MaxiFix

(DTC)

MaxiSys,

MaxiFix

MaxiSys

MaxiFix

6.1

MaxiFix

12.1

133.

MaxiFix



6-1

MaxiFix

MaxiFix

1.

—

2.

—

MaxiFix.

3.

—

Honda > Crosstour > EX.

, 2013 >

MaxiFix.

1.

2.

[year]

3.

[make]

4.

[model]

5.

[submodel]

6.

[engine]

7.

6.1.1

MaxiFix

MaxiFix

MaxiFix

MaxiFix

MaxiFix.

1. **Autel** –

2. –

3. **MaxiFix** –
MaxiFix.

➤ **MaxiFix**

1. ,

2. ,

3. ,

Fixed It! [!]

Fixed It! [!],

Fixed It! [!],

Fixed It! [

!]

MaxiFix

Fixed It! [!]

,

.

6.2

MaxiFix.

●Home [] –

●Your Cloud [] –

●Search Fix [] –

MaxiFix (

●Q&A [] –

●Support [] –

6.2.1

Home [] –

MaxiFix.

●Leaderboard [] –

MaxiFix.

●My Recently Viewed [] –

Leaderboard [] MaxiFix.

MaxiFix.

- 1
- MaxiFix, 5
- MaxiFix, 10

6.2.2 MaxiFix

Your MaxiFix [MaxiFix] —

MaxiFix.
Your MaxiFix [MaxiFix]

●Opened Questions [] –

●Opened Questions [] –

●Your Tips [] –

● Ask the Experts [] –

● Enter a Tip [] –

Your MaxiFix [MaxiFix]

➤ MaxiFix?

1.

(),

2.

Your MaxiFix [MaxiFix],

Your MaxiFix [MaxiFix].

3.

Your MaxiFix [MaxiFix]

Ask the Experts [].

Question [].

Question []

● Subject [] –

● Symptoms [] –

● Diagnostics Steps Performed/Parts Replaced
[] –

● Your Question [] –

4.

Cancel [],

MaxiFix

MaxiFix

1. Your MaxiFix [MaxiFix]

2.

3. Your MaxiFix [MaxiFix]

Enter a Tip [].

Tip []

4. Title []

5. Content []

6. **Cancel []**,

Your MaxiFix [MaxiFix].

7. **Submit []**,

6.2.3

Search Fix [] —

•All [] —

•Questions [] –

•Tips [] –

•Real Fixes [] –

6.2.4

Q&A [] —

MaxiFix.

•Latest Questions [] –

•Latest Tips [] –

Fixed It! []!

6.2.5

Support [] —

MaxiFix.

1. MaxiFix.
2. Frequently Asked Questions (FAQ),
MaxiFix.

Support [],

.

:

,

-
-
-

7

Settings []

,

MaxiSys.

MaxiSys

:

- Unit []
- Language []
- Printing Setting []
- Wired Network []
- Push Message []
- About []
- System Settings []

7.1

.

7.1.1

Unit []

.

➤

1. Settings []

MaxiSys.

2. Unit []

].

3. : Metric

[] English []

4. **Home []**,

MaxiSys.

7.1.2

Language []

MaxiSys.



1. **Settings []**

MaxiSys.

2. **Language []**.

3.

4. **Home []**,

MaxiSys.

7.1.3

Printing Setting []

(Wi-Fi)

[3.3.1](#)

23.



1. **Settings []**

MaxiSys.

2. **Printing Setting**
[]

3. **Print to Network** [] –

4. **Home** [],
MaxiSys.

7.1.4

Wired Network []

Ethernet-

➤ **Ethernet-**

1. **Settings** []
MaxiSys.

2. **Wired Network** []

3. **ON/OFF** [/],

4. **Ethernet Configuration** [Ethernet-],

5. **DHCP [DHCP]** – IP-

• **Static IP** [IP-] –

6. **Static IP** [IP-],
IP-

IP-

7. **Save** [],
Ethernet-
Cancel [],

8. **Home** [],
MaxiSys.

7.1.5

Push Message []

Push Message []
MaxiSys

Autel

MaxiSys.



1. **Settings** []
MaxiSys.

2. **Push Message**
[]

3. **ON/OFF** [/],

4. **Home** [],

MaxiSys.

Push Message []

MaxiSys

MaxiSys.

Update [].

7.1.6

About []

MaxiSys:

➤ **MaxiSys**

1. **Settings** []

MaxiSys.

2. **About** [].

3. **Home** [],

MaxiSys,

7.1.7

System Settings []

Android,

Android:

(,);

Android. '

Android.

8

Shop Manager

Shop Manager []







- **Vehicle History** []
- **Workshop Information** []
- **Customer Manager** []

Shop Manager []





8-1

Shop

Manager []

Back []		
Diagnostics []		Diagnostics []
Enter Edit []		
Delete []		
Search []		
Cancel []		

Shop Manager

Edit []		
Add Account []		
History Notes []		
Vehicle History []		Vehicle History [],
Done []		

8.1

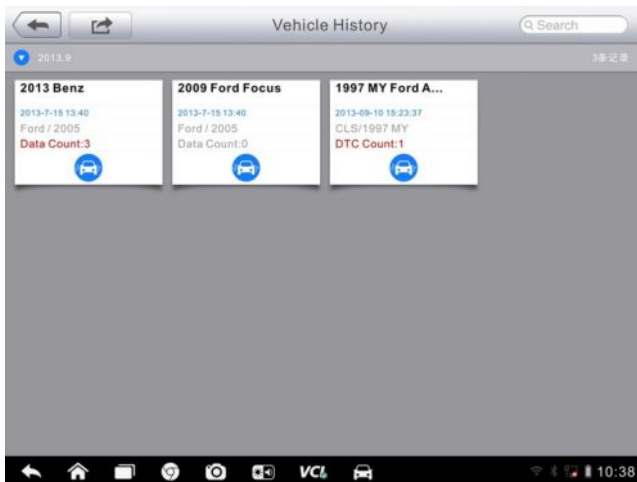

Shop Manager

- 1. Vehicle History []
 - 2. **8-1** Vehicle History []
 - 3. **Shop Manager** []
MaxiSys.
 - 4. **Vehicle History** []
 - 5. **Diagnostics** []
 - 6. Historical Test []
 - 7. Diagnostics []
 - 8. Diagnostics []
- 4.6 49.

8.1.1

Shop Manager

Historical Test []

The screenshot shows a web application window titled "Historical Test". The interface is organized into several sections:

- Vehicle Title:** Ford Mustang
- Vehicle Info:**
 - Year: 2008
 - Make: Ford
 - Model: Mustang
 - SubModel: [empty]
 - Engine: [empty]
- Service Record:**
 - Technician: [empty]
 - Technician Notes: [empty text area]
- Customer Info:**
 - First Name: [empty]
 - Last Name: John
 - Buttons: Add to Customer >
- DTC:**
 - Columns: Codes, Status, Descriptions, System
 - Content: No data
- Activate:** [empty text area with a green plus icon]

A floating menu is visible over the top right of the form, containing two buttons: "Print" (grey) and "Delete" (red).

8-2

Historical Test []

Shop Manager



1. **Shop Manager** [**MaxiSys.**]
2. **Vehicle History** [].
3. **Historical Test** [].
4. **Edit** [],
5. /

6. **Add to Customer** [], **Historical Test** []
7. **Done** [], **Cancel**

8.3

117.

[],

8.2

Workshop Information []

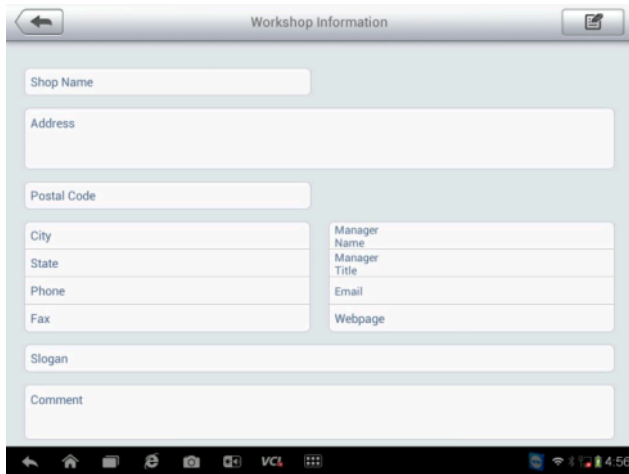

8-3

Workshop Information []



1. Shop Manager []
MaxiSys.

2. Workshop Information []

3. Edit []

4. ,

Shop Manager

Customer Manager

5. Done [], Cancel
[],

8.3

Customer Manager []

1. Shop Manager [MaxiSys.]
2. Customer Manager []
3. Add Account [].

4. ,+ , Take
Photo [], Choose Photo
[],

5. Add New Vehicle Information
[],

6. Done [], ,x.

Cancel [],



1. Shop Manager []
MaxiSys.

2. Customer Manager []

3.

Customer Information [C]

4. Edit [],

5.

6. Done [],

[],

Cancel



1. Shop Manager []
MaxiSys.

2. Customer Manager []

3.

Customer Information [C]

4. Edit [],

5. Delete Customer Information []

6.

Cancel [],

8.3.1

History Notes []



1. Shop Manager []

2. Customer Manager []
Vehicle History [].

3.

Customer Information [C] () ().

(Vehicle

History [].

4. History Notes []













History Notes [].

8-4 History Notes []

1. -
2. -

8-2 History Notes

Back []		
Delete []		
Search []		
Cancel []		
Edit []		
Add Notes []		History Notes []
Audio Record []		
Add Photos []		History Notes []
Take a Video []		History Notes []

Take a Photo []		Notes [] History
Save []		.

➤

1. History Notes [] .

2. **Add Notes** [] .

3. ,

4. ,

5. ,

6. **Save** [], **Cancel** [] .

9

MaxiSys () Update
 [].
 MaxiSys (,).

Maxisys .

[] MaxiSys. Settings ,
 (108). 7.1.5

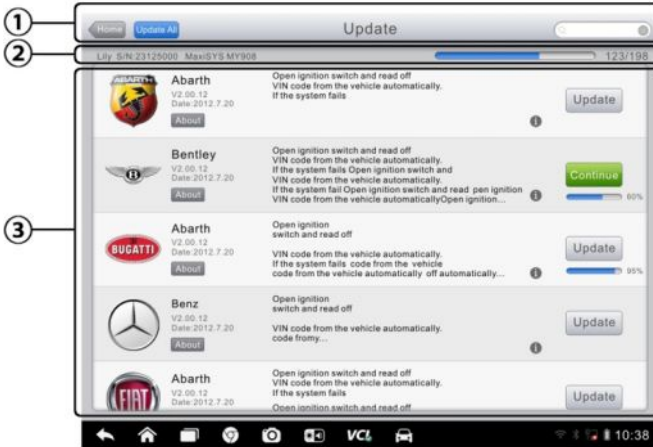

9-1 Update []

1.

- Home [] – MaxiSys.
- Update All [] –

-
- Search [] -

2.

- - MaxiSys.

- -

3.

- -

About [], PDF-

- -
,i ,

- -

a) Update [],

b) Pause [],

c) Continue [],



1.

MaxiSys,

2. **MaxiSys** **Update []** **Update**
[].

3. **Update All []**. **Update []**

4. **Pause [], Continue**
[]

5. . C

10

VCI Manager

MaxiSys
J2534

VCI (Bluetooth)

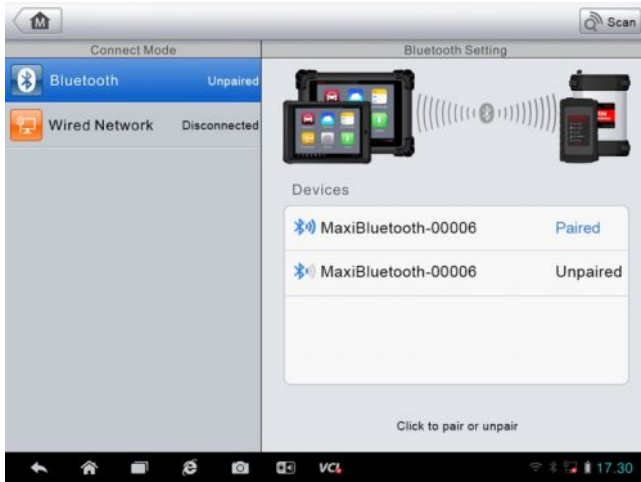

10-1

VCI

1. Connection Mode [] –

- Bluetooth – Paired [Unpaired []].
- J2534 ECU) – (Connected [Disconnected []].

2. Settings [] –

- Bluetooth Setting [Bluetooth] –

Bluetooth,

- Ethernet Setting [Ethernet] –

10.1

Bluetooth

VCI

MaxiSys



VCI

1.

MaxiSys.

2.

16-

(DLC).

3.

26-

J2534 ECU.

4.

VCI]

VCI Manager [

MaxiSys.

5.

Bluetooth

6.

Scan [],

7.

VCI

- 8. Maxi
,
,
,
Paired [
].
 - 9. VCI
 - 10. VCI.
 - 11. **Back** [],
,
- MaxiSys.

VCI

VCI

10.2

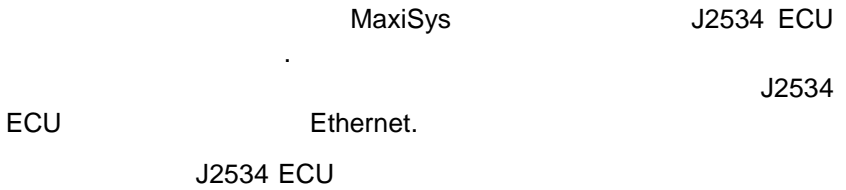

-
- J2534 ECU**
1. MaxiSys.
 2. 16- (DLC).
 3. 26- J2534 ECU.
 4. MaxiSys
 5. Ethernet VCI Manager [VCI] MaxiSys.
 6. Wired Network []
 7. Ethernet- :
 - DHCP [DHCP] – IP-
 - Manual [] – IP-

8. **Manual** [],
IP-

IP-

9. **Apply** [],

10. **Back** [], MaxiSys.

Ethernet Connected [],

VCI
MaxiSys Pro

11

Remote Desk

Remote Desk []
TeamViewer Quick Support,

Autel,

MaxiSys
TeamViewer.

11.1

TeamViewer
TeamViewer

TeamViewer
TeamViewer,

Remote

Desk []

Remote Desk []

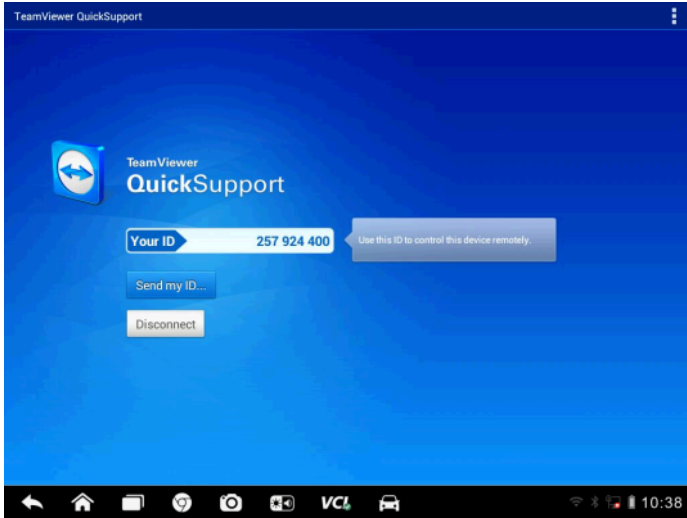

MaxiSys

11-1



1. MaxiSys.

2. Remote Desk []
MaxiSys.
TeamViewer,

3.

TeamViewer
: (<http://www.teamviewer.com>).

4.

5.

6.

Allow [

],

Deny [

],

TeamViewer.

12

Support []

Autel

MaxiSys.

Support []
Autel

MaxiSys,

12.1

Autel
MaxiSys

1. - : <http://pro.auteltech.com>.

2. Sign In []

3. **Create Autel ID [**
Autel],

4. **Agree**
Create
Autel
[],
Autel ID [Autel],

5.

6.

Settings []

About []

MaxiSys.

7.

Submit [],

12.2

Support []

().

- **Home** [] –

MaxiSys.

- **Back** [] –

- **Forward** [] –

●Refresh [] –

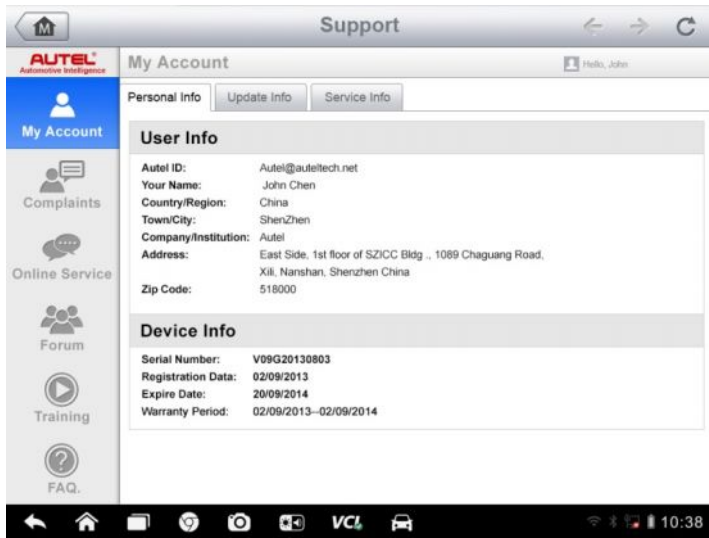

12-1

Support []

Support []

12.3

My Account []

(
, ,).

Personal Info []

User Info [] Device Info
[].

●User Info [] -

- Autel,
Autel, ,

●Device Info [] -

Update Info []

(
,).

Service Info []

Autel
(, ,

Service Info [

].

12.4

User Complaint []

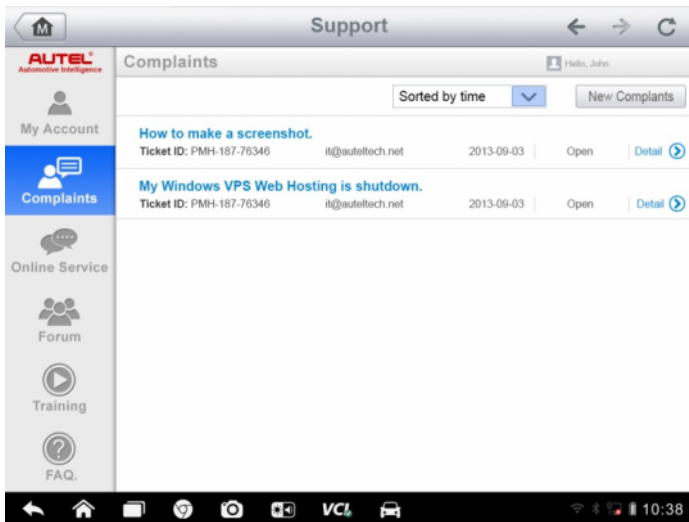

12-2

User Complaint []

1.

•

—

•

—

2.

- Open [] -
- Suspended [] -
- Waiting Customer Reply [] -
- Closed [] -



,>



1.

2.

Support []
MaxiSys.

Autel.

3.

Complaint []

4.

New Complaint [],

5.

Next [],

(

PDF-

6.

7.

8.

Submit [],

Autel,

Reset [],

1.

2.

MaxiSys.

Support []

Autel.

3. **Complaint** [],
4. ,> ,
5. **Post** **Reply** [],
6. ().
7. **Submit** [],
8. **States** []
9. **Update** [],

12.5

Communities []

Autel (<http://pro.auteltech.com>),

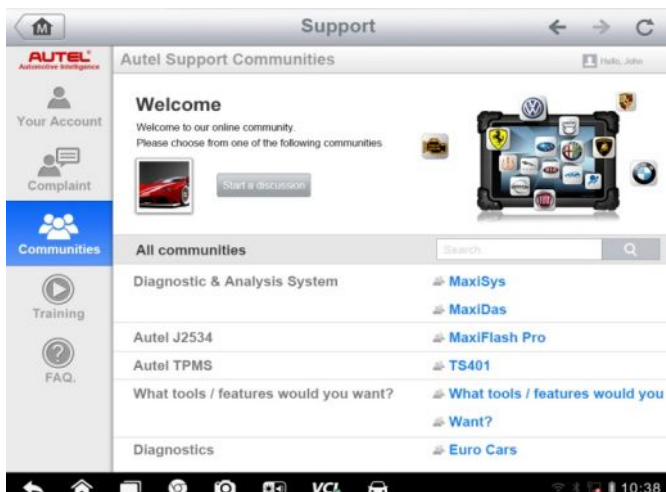

Autel.

12-3

Autel



1. **Start a discussion []**
Communities [].

2.

MaxiSys,

MaxiSys,

3.

4.

5.



1. Communities []

2. [], Categories

3. ,> ,

4.

post [

Go to original
],

5. Reply [],

original post [

Reply to
],

6.

OK,

Communities

[],

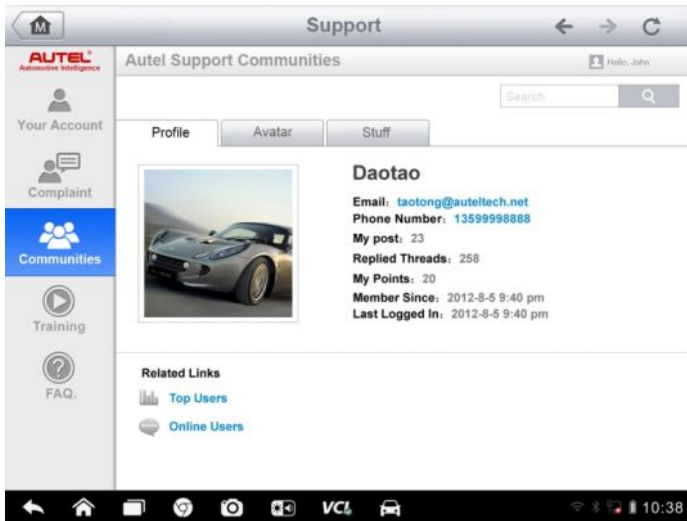

12-4

●Profile [] –

Related links

[]

(Top Users []),

●Avatar [] –

●Stuff [] –

12.6

Training []

Autel.

Autel.

(. .),

12.7

FAQ []

- Autel,

●Account [] –

Autel.

●Shopping & Payment [] –

- Autel.

13

Remote Program [

)

MaxiSys

]

Autel

MaxiSys

14

Training [

]

Training []



14-1

Training []

1.

- Home [] -
- Online [] -

MaxiSys

Autel.

- All [] -
- Product [] -
- Diagnostic [] -

2.

>

1. Support []
MaxiSys. Training [].

2.

3.

Play [],

4.

15

Quick Link []
Autel,



15-1 Quick Link []

1. Quick Link []
MaxiSys. Quick Link

[]

2. Chrome

3. !

16

Digital Inspection []
MaxiSys



! !

-

-

-

-

3

-

0 °C +45 °C).

✓

✓

✓

✓

16.1

(8,5 5,5)
MaxiSys

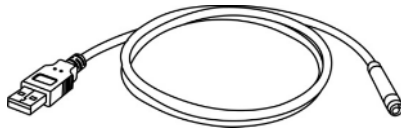

16-1

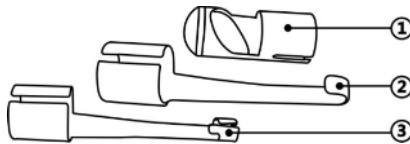

16-2

8,5

Digital Inspection

1.

—

,

2.

—

3.

—

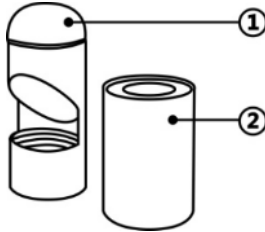

16-3

5,5

1.

—

2.

—

,

8,5

(16-2))

).

(,

(.

1.

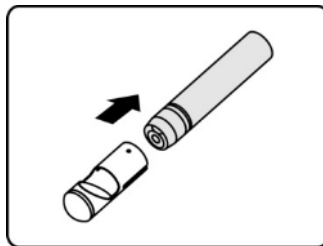

2.

5,5

16-3))

1.

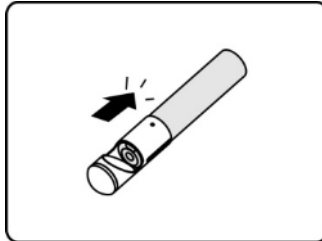
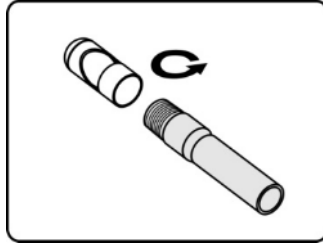

2.

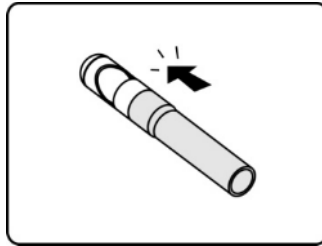

16.2

Digital Inspection []

MaxiSys

USB-



➤ Digital Inspection []

Inspection []

1. USB-

MaxiSys.

2.

MaxiSys,

3.

Digital Inspection []

]

MaxiSys.

Digital Inspection [],

Digital Inspection

4.

5.

6.

7.

8.

9.

10.

Back []

Home []

Digital Inspection []



Inspection []

Digital

1.

USB-

MaxiSys.

2.

MaxiSys,

3.

Digital Inspection []

]

MaxiSys.

Digital Inspection [],

4.

5.

6.

7.

Gallery [].

8.

9.

Play [],

10.

11.

12.

Back [] **Home** []

Digital Inspection [].

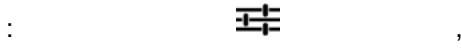

Android.

Scope

(

)

17

Scope ()

Scope [

]

,

,

,

.

.

18

MaxiSys

VCI

18.1

-

-

-

-

-

-

-

-

VCI.

-

•

•

•

18.2

A.

•

•

•

•

B.

•

C.

•

D.

:

•

•

•

Autel

18.3

« »,



!

•

•

•

•

USB-

•

•

•

•

•

•

18.4

- ()
- 1-877-288-3587/1-877-AUTELUS
() 0086-755-86147779 ();
- ;
- - : <http://pro.auteltech.com>
<http://www.maxidas.com>.
- (. - <http://www.maxidas.com>).
-
-
-
-
-
-
- ()

• ()

•
Visa Master Card

:

Rm. 106, 107, 109, 114, SZICC Bldg.,
Chaguang Road Southside, Xili Town,
Nanshan District, Shenzhen
518055, P.R. China

Autel /

:

-
-
-
-

19

12

Autel Intelligent Technology Co. Ltd (« »)
12

MaxiSys, ()

,

,

(

)

,

,

,

,

:

a)

,

,

,

,

,

;

,

b)

,

;

c)

,

;

d)

,

;

e)

,

f)

;

,

,

,

,

,

.

!

,

.

AUTEL[®]

Autel Intelligent Technology Co., Ltd.

All Rights Reserved

www.auteltech.com