

March 1985

Flight Characteristics of the AD-1 Oblique-Wing Research Aircraft

IN-08
58126
P-29

Alex G. Sim and
Robert E. Curry

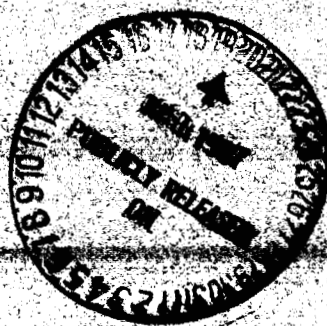

(NASA-TP-2223) FLIGHT CHARACTERISTICS OF
THE AD-1 OBLIQUE-WING RESEARCH AIRCRAFT
(NASA) 29 p

CSSL 01C

N87-1E570

Unclas
H1/08 43558

Date for general release March 31, 1987

NASA



**NASA
Technical
Paper
2223**

1985

Flight Characteristics of the AD-1 Oblique-Wing Research Aircraft

Alex G. Sim and
Robert E. Curry

*Ames Research Center
Dryden Flight Research Facility
Edwards, California*

NASA

National Aeronautics
and Space Administration

Scientific and Technical
Information Branch

INTRODUCTION

In recent years the oblique-wing configuration has been advocated by Dr. R. T. Jones (ref. 1). The first flight tests of the concept were conducted using a low-speed remotely piloted aircraft (ref. 2). Studies of the oblique-wing concept have shown substantially improved transonic aerodynamic performance at Mach numbers up to 1.4 and the elimination of sonic booms in flight at Mach numbers as high as 1.2 (ref. 3). Studies of subsonic, oblique-wing transport aircraft have shown the potential for either increased range or reduced takeoff gross weight (ref. 4). Common to both the subsonic and transonic configurations are the anticipated inherently low airport noise and generally better low-speed performance characteristics. An overview of oblique-wing technology is given in reference 5. Although the aerodynamic performance benefits of the oblique-wing configuration occur at transonic speeds, many of the characteristics associated with asymmetry are not strongly related to compressibility, and thus (to a limited extent) can be evaluated at low speeds. The purpose of the AD-1 project was to investigate the low-speed characteristics of an oblique-wing configuration.

The AD-1 was designed and fabricated to be a low-speed, low-cost airplane with which many of the problems associated with an aeroelastic oblique-wing airplane could be investigated. The "low cost, low speed" concept limited both the complexity of the vehicle and the scope of the technical objectives. Low speed allowed the use of a low-technology structure, fixed landing gear, and mechanical control system. Technical objectives were limited by the use of a 40-channel instrumentation system. The specific technical objectives of the AD-1 program were (1) assessment of the unique handling and flying qualities of an unaugmented, low-speed, oblique-wing vehicle; (2) general appraisal of the nature and complexity of a flight control system on an oblique-wing configuration; (3) verification of the static aeroelastic design criteria for the wing; and (4) comparison of the flight-determined aerodynamic data with predicted values.

The geometric configuration of the AD-1 airplane was selected from airplane configurations studied by the Boeing Commercial Airplane Company under contract to NASA (ref. 3). While the overall vehicle design was specified by NASA, the detailed design and load analyses were conducted under a contracted effort by the Rutan Aircraft Factory, Mojave, California. The airplane was fabricated under a contracted effort by the Ames Industrial Corporation, Bohemia, New York.

This report presents an overview of the basic flying characteristics of the AD-1 airplane. Pilot ratings and pilot comments were used to document vehicle handling qualities. A simulator study was used to illustrate the benefits of using a basic rate feedback control system to improve the handling qualities.

References 6 and 7 document the aerodynamics of the AD-1 airplane. Pilot ratings in this report refer to the Cooper-Harper rating scale, which is explained in reference 8 and shown in table 1.

NOMENCLATURE

Lift coefficient is referenced to the stability axis. All other coefficients, derivatives, and moments of inertia are referenced to the body axes. Wing sweep is the angle between the straight chord line on the wing and the perpendicular to the fuselage (fig. 1).

c_r	reference chord, m (ft)
c.g.	center of gravity
α	angle of attack, deg
η	fraction of semispan
Λ	wing sweep angle, deg

Coefficients:

C_L	lift force
C_l	rolling moment
C_m	pitching moment
C_n	yawing moment
C_Y	sideforce

Nondimensional derivatives:

C_{l_p}	damping in roll due to roll rate, per rad
C_{l_r}	damping in roll due to yaw rate, per rad
C_{l_β}	effective dihedral, per deg
$C_{l_{\delta_a}}$	aileron authority, per deg
C_{n_β}	directional stability, per deg

Inertias:

I_x	rolling moment, kg-m^2 (slug-ft ²)
I_{xy}	roll-pitch cross product, kg-m^2 (slug-ft ²)
I_{xz}	roll-yaw cross product, kg-m^2 (slug-ft ²)
I_y	pitching moment, kg-m^2 (slug-ft ²)

Gains:

K_p	roll, deg/deg/sec
K_q	pitch, deg/deg/sec
K_r	yaw, deg/deg/sec

Rates:

p	roll, deg/sec
q	pitch, deg/sec
r	yaw, deg/sec

VEHICLE DESCRIPTION

The general layout of the AD-1 airplane (fig. 1) consists of a high-fineness-ratio fuselage with two turbojet engines mounted on short pylons on the side of the fuselage, fixed gear, and a high-aspect-ratio aeroelastic oblique wing. The geometric configuration is similar to that of the transonic transport of reference 3. The wing can be pivoted in flight from 0° to 60° sweep, right wing forward, about a pivot point at the 40-percent root chord location. A total fuel capacity of 270 liters (72 gal) is stored in two fuselage tanks located fore and aft of the wing pivot location. In flight, the center of gravity (c.g.) was generally within a few percent of the nominal quarter root chord position. Additional physical characteristics are given in table 2.

Structurally, the airplane consists of a fiberglass-reinforced plastic sandwich with a core of rigid foam. Except for the wing pivot, all structural components were designed to a 6g limit load capability and a 175-knot limit airspeed. The wing pivot was designed to a load limit of $\pm 25g$.

The primary flight controls were conventional aileron, elevator, and rudder, and were actuated using a mechanical control system. The rudder pedals were mechanically linked to the upper rudder; yaw trim was provided by the electrically operated lower rudder. Pitch and roll trim were obtained from electrically operated tabs located on the elevator and right aileron, respectively. Throttle control was through an electronic engine control monitor. Wing sweep was initiated using a switch on the instrument panel. The wing could be returned to the unswept position using either the switch or a trigger on the pilot's center stick.

The instrument panel (fig. 2) was very basic, containing altitude, airspeed, normal acceleration, angles of attack and sideslip, wing sweep angle, the engine parameters, and rudder trim position (on the right side panel). There were no attitude instruments; therefore, all handling qualities maneuvers were performed using only visual references.

FLIGHT OPERATIONS

The operating procedures associated with a typical research flight are presented to provide insight into the general nature of the AD-1 airplane. A chase plane pilot augmented the AD-1's forward visibility and provided all non-research-related communications. Control room engineers monitored both the ground track and the operational flight limits. The flight envelopes are shown in figure 3.

The airplane was normally taxied using one engine to conserve fuel. However, it was often difficult to turn toward the running engine because the main landing gear was inboard of the engines and the nosewheel was lightly loaded. Pilot ratings of 5 to 6 were obtained for single engine taxi, while ratings of 3 were obtained when using both engines.

Takeoff consisted of lifting the nosewheel at a speed of about 60 knots and holding a pitch attitude of about 3° until takeoff occurred at a speed of about 85 knots. Prior to nosewheel lift-off, slight forward stick pressure was often used to prevent nosewheel bouncing. Pilot ratings of 2 to 3 were obtained for takeoff.

After takeoff, the vehicle would climb to 3800 m (12,500 ft) before research testing was begun. Since the best rate of climb was in the airspeed range between 100 and 120 knots, most of the climb was performed at a speed of 110 knots. The rate of climb at 900 m (3000 ft) was about 300 m/min (1000 ft/min) and decreased to about 200 m/min (660 ft/min) at 3700 m (12,000 ft). Single-engine performance in the pattern varied from a slightly positive rate of climb on a hot day with maximum gross weight to a rate of climb of about 60 m/min (200 ft/min) on a standard day with minimum fuel reserves. Although the initial climbs to the test altitude were performed with zero wing sweep, the rate of climb remained reasonably constant to about 35° wing sweep. The climb task usually received a pilot rating of 2.

Most of the research flying was conducted at an altitude of 3800 m (12,500 ft) and was terminated when the altitude dropped below 3000 m (10,000 ft). Maneuvers were performed to expand the flight envelope for flutter, divergence, and loads, to analyze the aerodynamics, and to evaluate the handling qualities. Structural excitation for flight flutter testing consisted primarily of stick raps. Maneuvers for the analysis of aerodynamics, flight loads, and handling qualities consisted of doublets, windup turns, slow sideslip variations, $1g$ decelerations, pullup-pushovers, descents, and aileron rolls.

Return to base consisted of a descent with the engines at idle and the wing at either 0° or 45° sweep. The approach to landing was usually long and flat because of the moderately high lift-to-drag ratio and the high idle thrust (about 360 N (80 lb)). Although speedbrakes or spoilers would have improved the approach flying qualities, they were not considered necessary to either the research tasks or the operational research flying of the airplane.

An 80-knot touchdown speed was used to provide an airplane attitude that allowed for adequate forward visibility and avoided scraping the tail (which occurred at a pitch attitude of 7.5°). Pilot comments indicated that the AD-1's landings were comparable to those of a low-performance sailplane. Pilot ratings were usually 3.

BASIC FLIGHT CHARACTERISTICS

In this section, basic stability, control, and aerodynamic characteristics of the AD-1 airplane are discussed in preparation for the PILOT RATINGS AND PILOT COMMENTS section. Insight into the vehicle's handling qualities can be obtained through an understanding of its traditional stability and control characteristics. These characteristics include the variation in aerodynamic performance with wing sweep, low thrust-to-weight ratio, low control forces, low directional stability, slight spiral instability, adverse aileron yaw, and a reduction in aileron control characteristics, roll damping, and roll inertia with increasing wing sweep. Additionally, in the oblique configuration (wing swept), the handling qualities are affected by many non-traditional stability and control characteristics. Included in these effects are the moment changes with angle of attack and load factor, the change in sideforce with angle of attack, initial stall on the trailing wing, and inertial coupling due to I_{xy} .

Traditional Characteristics

The maximum lift-to-drag ratio (fig. 4) decreases at the higher wing sweeps, causing increased speed stability and decreased maneuver performance. Because verification of oblique-wing aerodynamic performance was not an objective of the program, the AD-1 design concept did not emphasize minimization of drag. Although higher maximum speeds could be obtained with lower drag, the overall handling qualities would suffer because of poor speed stability and a relatively high idle thrust. Hence the additional precautions were not taken (and the expense was not incurred) to minimize drag.

At initial climbout, the available thrust-to-weight ratio was approximately 0.20, whereas at test altitude and an average gross weight, the available thrust-to-weight ratio was approximately 0.16. Thus the aircraft's performance was comparable to that of a light general aviation airplane. At airspeeds below 100 knots, the control forces were comparable to those of a low-performance sailplane.

The transient response to a rudder input took about three cycles to damp out and was a result of the low directional stability derivative, $C_{n\beta}$, which is shown in figure 5. This caused the vehicle to "wander" or "search" directionally and was more noticeable at high sweep angles and high angles of attack. For operational flying, the directional stability was considered adequate; however, for precise maneuvering, the low directional stability often contributed to degraded handling qualities. The transient response to elevator inputs was nearly deadbeat, whereas the transient response to aileron input provoked the spiral instability. The spiral instability was primarily a result of the effective dihedral derivative, $C_{l\beta}$, and a strong positive value for the damping in roll due to yaw rate derivative, C_{l_r} . Details of these derivatives are given in reference 6.

The reduction in the aileron roll authority derivative ($C_{l\delta_a}$), the roll damping derivative (C_{l_p}), and the rolling moment of inertia (I_x) caused by wing sweep is shown in figure 6. At 60° sweep, $C_{l\delta_a}$ is about 15 percent of its value at zero sweep, but with the concurrent reduction in both C_{l_p} and I_x , adequate maneuvering

roll authority is maintained (fig. 7). However, as would be expected, the decreases in I_x and C_{l_p} still degrade the handling qualities. Additional roll authority needed for trim is discussed in the next section.

Nontraditional Characteristics

With increasing angle of attack, the resultant aerodynamic forces on a wing rotate forward and become approximately perpendicular to the wing sweep angle. For an oblique-wing configuration, this effect creates a sideforce, which is reflected in the sideforce coefficient (fig. 8). To maintain a constant heading, the sideforce must be neutralized by using either sideslip, bank angle, or a combination of sideslip and bank angle. An example of these trim requirements for a lift coefficient of 0.3 and 60° of sweep is shown in figure 9. Most of the apparent sideforce and the resulting trim requirements could have been eliminated by tilting the wing pivot axis forward about 5° and increasing the unswept wing incidence to maintain the same unswept geometry (ref. 7). This modification would cause the bank angle of the wing to increase as wing sweep increased, thus allowing the fuselage to remain straight and level. This was not realized during the AD-1 design phase.

To illustrate that trim is required in all three axes, the 1g static aerodynamic moments are shown in figure 10. For trimmed flight, both the moments and the sideforce must be neutralized. A trimmed steady heading, airspeed, and altitude can be obtained using many combinations of elevator, aileron, and rudder trim. At high wing sweep, the most common technique for obtaining trimmed flight was to use sufficient right (negative) rudder trim to allow the center stick to be laterally neutralized. At 60° sweep and 140 knots, this yielded a trimmed flight condition with about 1° of nose-right (negative) sideslip and 7° of right-wing-down (positive) bank angle.

A properly designed aeroelastic oblique wing has a balanced span load at a design point. For a rigid oblique wing, when lift is increased, the span-load centroid is translated toward the trailing wingtip; for an overly flexible wing, the span-load centroid is translated toward the leading wingtip. The AD-1's design point is at a lift coefficient of 0.3 and 60° sweep, which is a condition attained near 140 knots airspeed. At higher airspeeds (lower lift coefficients), load increases on the leading (right) wing, whereas at lower airspeeds load increases on the trailing wing. At very slow speeds, the trailing tip will stall first, resulting in a left rolloff. Use of aileron to counter the roll aggravates the stall, causing the stall to occur at higher airspeeds. Figure 11, which shows an example of the flow over the upper surface of the wing at stall, indicates that stall begins at the trailing wingtip and gradually progresses inboard. This schematic of the flow was obtained from in-flight tuft photographs.

Reference 9 indicated that the AD-1 spin model had a "yaw into the leading wing" (yaw-right) established spin mode from which recovery was difficult without first unsweeping the wing. Reference 9 also indicated that the AD-1 model with the wing highly swept would not sustain a spin into the trailing wing (yaw left). However, experience with the airplane has been that at low speeds, the trailing (left) wing stalled first and caused the airplane to roll and yaw to the left, away from the potential spin problem. If recovery were not attempted, indications are that the airplane would go into a steep spiral to the left. Rapid pullups to stall at high airspeed were not attempted.

For other than 1g flight, large variations occurred in aerodynamic moments with load factor, as shown by the example of pitching moment in figure 12. These effects can be represented as incremental changes in the moments as a function of load factor, as shown in figure 13. In a physical sense, these effects are detrimental to the handling qualities but are less detrimental for slow maneuvers than for rapid ones. Thus, the airplane is particularly sensitive to turbulence. The positive pitching moment increment due to load factor is analogous to a positive (destabilizing) moment in longitudinal static stability. The negative rolling moment increment due to load factor has the effect of resisting turns to the right and steepening turns to the left. The negative yawing moment increment due to load factor has an "adverse yaw" effect for right turns and a "proverse yaw" effect for left turns. Thus, right rudder was needed to coordinate either left or right turns.

At the higher wing sweeps, the magnitude of the cross product of inertia, I_{xy} (fig. 14), is nearly as large as the roll inertia, I_x (fig. 6). With a high value for I_{xy} , a pitch-roll inertial coupling occurs, as shown by the example in equations (1) and (2) for 60° of wing sweep.

$$\dot{p} = \frac{1}{I_x} \left(1.06 \sum \text{Rolling moments} + 0.08 \sum \text{Pitching moments} \right) \quad (1)$$

$$\dot{q} = \frac{1}{I_y} \left(0.73 \sum \text{Rolling moments} + 1.06 \sum \text{Pitching moments} \right) \quad (2)$$

To illustrate the pitch-roll coupling, the equations were simplified by deleting the roll-yaw coupling effects of the more common and much smaller I_{xz} term. Although the equations show significant roll coupling into pitch, the actual airplane response contained only minimal coupling because of the very low I_x/I_y ratio (fig. 15) and the low I_x and low roll damping (fig. 6). At high sweeps, the resulting vehicle transient motion is primarily in roll.

PILOT RATINGS AND PILOT COMMENTS

Pilot ratings were obtained from both the envelope-expansion flights and from the guest-pilot-program flights. The envelope expansion was conducted using two pilots. Their ratings were generally obtained near the end of the envelope-expansion flights, after each pilot had previously flown to each rated flight condition. Pilots in the guest-pilot program had only one flight from which to evaluate and rate the handling qualities. The ratings from these two groups are presented separately. The handling qualities tasks are described in the appendix.

Although the AD-1 geometry was chosen for its similarity to supersonic oblique-wing transport designs, many of the maneuvers performed to evaluate the handling qualities were not transport-aircraft maneuvers. For example, windup turns are often used to evaluate the capability of a maneuvering airplane. Because deficiencies in transport-aircraft handling qualities tend to be amplified in maneuvers like windup turns, these types of maneuvers are excellent for highlighting deficiencies and for ascertaining the need for stability augmentation.

Envelope-Expansion Flight Results

Trim. — Below 30° of wing sweep, pilot ratings for the trim task (fig. 16) and pilot comments indicated satisfactory handling qualities. At higher wing sweep angles, the ratings remained adequate, but the task "required pilot compensation." Elevator trim authority "runs out" at airspeeds below 85 knots, requiring the pilot to hold "back stick." At sweep angles of 45° and above, it was possible to run out of aileron trim (and even aileron authority) if proper rudder trim was not used. For this reason, the airplane was retrimmed every 5° of sweep for sweep angles above 45°. At 60° sweep, a typical pilot comment was that the vehicle exhibited "a little lateral hunting which required a constant watch."

Descent. — Pilot ratings for the descent maneuvers (fig. 17) and pilot comments indicated that the aircraft was generally satisfactory below 30° of wing sweep but degraded at the higher sweep angles. With 60° of sweep at an airspeed of 84 knots, a pilot commented that there was "no problem holding the descent"; however, coming out of descent the vehicle develops some pitch and roll "oscillations and cross couples." With 60° of sweep at 140 knots, the pilot stated that "transition from descent caused some roll." Below 45° of sweep the task "required minimal compensation and did not produce significant coupling."

Aileron rolls. — Pilot ratings obtained for aileron rolls to both the left and the right are shown in figure 18. For sweep angles less than 45°, the pilot had a good command of bank angle with good roll rate and no tendency to overshoot. At 30° of sweep, only slight pitch coupling was noted. At sweep angles of 45° and above, the airplane resisted rolling to the right and often required rudder to adequately perform the maneuver. Proper rudder trim was needed to allow for adequate right roll authority. Pilot comments often indicated that rolls to the left were slightly easier than rolls to the right, even though there was a tendency to overshoot the desired bank angle. The degradation in the ratings was similar for left and right rolls, even though reasons for the degradation were different. Many comments indicated that the airplane "wandered" (primarily directionally), making it difficult to maintain coordinated flight using rudder.

Windup turns. — The windup-turn task was the most difficult handling qualities task performed because it required close attention to pitch, roll, and yaw. Pilot ratings for windup turns to the left and the right are presented in figure 19. Below 45° sweep, pilot comments indicated that there was no tendency to overshoot the desired g and that the maneuver required "minimal pilot workload." Above 45° sweep, the airplane exhibited different characteristics when turning right than when turning left. When the pilot increased bank angle to the right, the aircraft "seemed to want to roll out of the turn." Once the bank angle was established, there was "no tendency to overshoot g"; however, it was often difficult to attain higher levels of load factor because a right bank of about 55° was required to attain 1.5 g. At 60° of sweep, if proper rudder trim was not used, it was possible to run out of right aileron control authority before attaining the desired 1.5 g. When turning to the left, the airplane would tend to roll farther into the turn than the pilot had commanded. This was an uncomfortable situation that often required right aileron to be held in place to counter the increasing roll tendency. At 60° sweep, liberal right rudder was often used to roll back to a straight heading. Primarily during left turns, an oscillation (similar to dutch roll but with pitch added) would be superimposed on the maneuver, causing the pilots to refer to the maneuver as "jerky" or "ratchety." Proper rudder coordination to perform a "smooth" maneuver was not possible.

Pullup pushover. - The pullup pushover was not a rated maneuver; however, pilot comments indicated that at low sweep angles the aircraft was able to attain g "quickly and precisely." Above 45° sweep, the maneuvers were "sloppy, since cross controlling of pitch and roll was necessary."

Landings at 45° sweep. - Several landings were made with the wing at 45° sweep. Comments indicated "good control authority in all axes with no adverse ground effects." However, forward visibility was poor, and 3° to 4° of bank was needed to maintain constant heading. Pilot ratings increased from a 3 for landings at zero sweep to a 5 for landings at 45° of sweep.

Turbulence. - Throughout the envelope expansion, the presence of light turbulence degraded the handling qualities by 2 to 3 pilot ratings, which often resulted in overall unacceptable handling qualities. The dynamics resulting from the wing aeroelastics were the major factor in the poor turbulence response.

Guest Pilot Program

Pilot comments and ratings were obtained primarily for the trim task (fig. 20) and for the windup-turn maneuver (fig. 21). Not all tasks were rated by all pilots. The ratings and the corresponding pilot comments are generally consistent with those obtained from the envelope-expansion flights. All the pilots were able to fly the airplane to 60° of sweep and complete the planned maneuvers without intensive pre-flight training.

CONTROL SYSTEM AUGMENTATION

A stability augmentation system using rate feedback (fig. 22) was incorporated in a piloted simulation. This system was not implemented on the aircraft. The simulation was mechanized in a fixed-base, six-degree-of-freedom simulator that contained the final aerodynamic data base from references 5 and 6. The general layout of the instruments and controls was similar to the layout in the airplane, with the exception that an eight ball mounted above the instrument cluster was the only visual attitude reference.

Using only pilot A, pilot ratings were obtained from the unaugmented simulation (that is, gains at zero) at an airspeed of 140 knots (fig. 23). The ratings obtained were similar to but not exactly the same as those obtained in flight. Results show that a control system using only rate feedback is sufficient to yield acceptable handling qualities ratings at high wing sweeps. Although not formally rated, results for other airspeeds, wing sweeps, and maneuvers were virtually the same.

CONCLUDING REMARKS

The basic flight characteristics of the AD-1 airplane were discussed, including several stability and control characteristics that have either traditionally affected handling qualities or that are unique to an oblique-wing vehicle. Of particular significance were the low directional stability, the unusual trim requirements, the roll-pitch couplings, the dynamics resulting from the wing aeroelastics, and the stall. Pilot ratings that document many of the vehicle's handling qualities were

presented. At or below 30° of wing sweep, ratings indicate satisfactory handling qualities. Between 30° and 45° of sweep, ratings increase, generally indicating the beginning of a degradation in handling qualities caused by wing sweep. The primary degradation in handling qualities occurred between 45° and 60° of sweep. Light turbulence degraded the handling qualities by up to three pilot ratings. A control system using rate feedback was mechanized on the AD-1 simulator. Simulation studies indicated that only rate feedback was necessary to yield acceptable handling qualities at the high wing sweeps.

Ames Research Center

Dryden Flight Research Facility

National Aeronautics and Space Administration

Edwards, Calif., February 14, 1983

APPENDIX — HANDLING QUALITIES TASKS

Maneuvers used to evaluate the handling qualities included stabilizing on trim, descents, aileron rolls, windup turns, and pullup pushovers. Other maneuvers resulting from the overall operational flying tasks were valuable in describing the general nature of the vehicle. The modified Cooper-Harper pilot rating system (ref. 8) was used as a basis for all pilot ratings. The AD-1 airplane was rated as if it were a transport aircraft.

The trim task rating was an evaluation of the difficulty to attain and maintain a stabilized flight condition.

The descent task was a maneuver similar to the approach task. While airspeed was held constant, the throttles were retracted to idle for a 60-m (200-ft) descent in altitude. The evaluation considered the difficulty to obtain a stabilized descent and then smoothly recover at a new trim condition.

The aileron roll task was to stabilize on a new bank angle between 20° and 30° from the trimmed bank angle and then return to constant heading. Roll rates were typically 30 deg/sec. With the wing swept, aileron rolls were performed to both the left and right. Rudder was used when needed for coordination. The pilot evaluation considered roll authority, roll rate, and overshoot tendencies.

The windup turn consisted of an increase in load factor to 1.5g followed by roll-out on a 90° heading change. Airspeed was held constant, and power was used to try to maintain altitude. The pilots evaluated the ability to hold airspeed, smoothly attain the load factor, and roll out on a 90° heading change. At 60° wing sweep, the task was often modified to roll out on a 180° heading change. This provided more time to accomplish the maneuver but did not appear to change the final ratings.

The pullup-pushover task consisted of varying load factor up to 1.5g, down to 0.5g, and back to trim while holding constant heading. The pullup was performed first to avoid rapid buildups in initial airspeed. The evaluation considered the difficulty of smoothly varying load factor while maintaining heading. The duration of a typical maneuver was 30 sec.

REFERENCES

1. Jones, Robert T.: New Design Goals and a New Shape for the SST. *Astronaut. and Aeronaut.*, vol. 10, no. 12, Dec. 1972, pp. 66-70.
2. Maine, Richard E.: Aerodynamic Derivatives for an Oblique Wing Aircraft Estimated From Flight Data by Using a Maximum Likelihood Technique. NASA TP-1336, 1978.
3. Oblique Wing Transonic Transport Configuration Development. NASA CR-151928, 1977.
4. Bradley, Edward S.: An Analytical Study for Subsonic Oblique Wing Transport Concept. NASA CR-137897, 1976.
5. Nelms, Walter P., Jr.: Applications of Oblique-Wing Technology - An Overview. AIAA Paper 76-943, Sept. 1976.
6. Sim, Alex G.; and Curry, Robert E.: Flight-Determined Aerodynamic Derivatives of the AD-1 Oblique Wing Research Airplane. NASA TP-2222, 1984.
7. Curry, Robert E.; and Sim, Alex G.: AD-1 Total Forces, Moments, and Static Aeroelastic Characteristics of an Oblique-Wing Research Airplane. NASA TP-2224, 1984.
8. Cooper, George E.; and Harper, Robert P., Jr.: The Use of Pilot Rating in the Evaluation of Aircraft Handling Qualities. NASA TN D-5153, 1969.
9. White, William L.; and Bowman, James S., Jr.: Spin-Tunnel Investigation of a 1/13-Scale Model of the NASA AD-1 Oblique-Wing Research Aircraft. NASA TM-83236, 1982.

TABLE 1. — MODIFIED COOPER-HARPER HANDLING QUALITIES RATING SCALE AND MILITARY SPECIFICATION DEFINITION OF FLYING QUALITIES LEVELS

(a) Modified Cooper-Harper rating scale (from ref. 8).

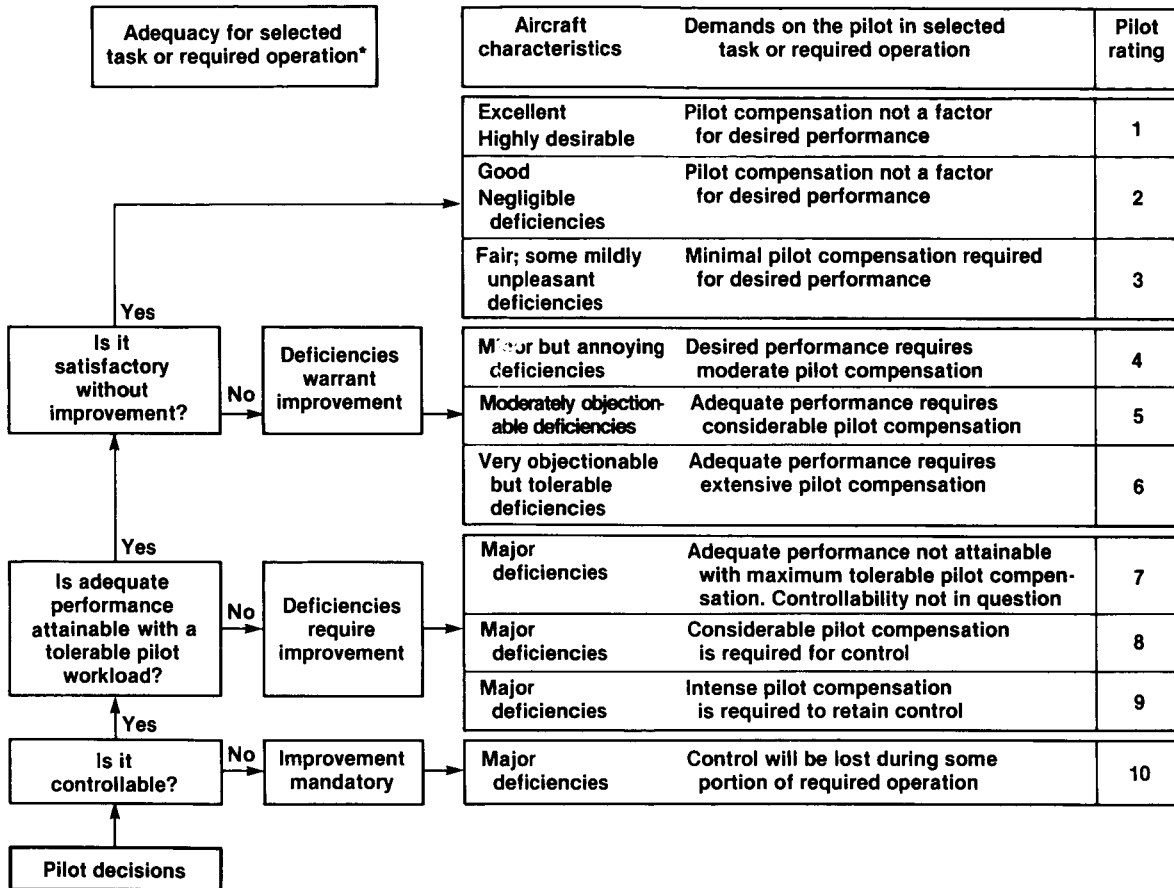

*Definition of required operation involves designation of flight phase and/or subphases with accompanying conditions

(b) Military Specification definition of levels of flying qualities.

Level 1	Flying qualities clearly adequate for the mission flight phase.
Level 2	Flying qualities adequate to accomplish the mission flight phase, but some increase in pilot workload or degradation in mission effectiveness, or both, exists.
Level 3	Flying qualities such that the airplane can be controlled safely, but pilot workload is excessive or mission effectiveness is inadequate, or both.

TABLE 2. - PHYSICAL CHARACTERISTICS OF AD-1 AIRPLANE

Total height, m (ft)	2.06 (6.75)
Total length, m (ft)	11.80 (38.80)
Wing ($\Lambda = 0^\circ$) -	
Reference and actual planform area, m^2 (ft^2)	8.60 (93.00)
Reference and unswept span, m (ft)	9.80 (32.30)
Reference and unswept chord (root), m (ft)	1.30 (4.28)
Aspect ratio	11.2
Airfoil	NACA 3612-02, 40 (constant)
Dihedral angle, deg	0
Twist, deg	-2
Root incidence angle, deg	2
Quarter chord sweep angle, deg	0
Leading edge sweep angle, deg	2
Average chord, m (ft)	0.88 (2.90)
Wing pivot location	$0.4c_r$
Sweep angle range, deg	0 to 60
Horizontal tail -	
Planform area, m^2 (ft^2)	2.40 (26.00)
Span, m (ft)	2.40 (8.00)
Average chord, m (ft)	1.00 (3.30)
Root chord, m (ft)	1.60 (5.40)
Dihedral angle, deg	0
Incidence angle, deg	0
Leading edge sweep angle, deg	45
Airfoil	NACA 0006
Vertical tail -	
Area (exposed), m^2 (ft^2)	1.30 (14.40)
Span (exposed), m (ft)	1.10 (3.70)
Average chord, m (ft)	1.20 (3.90)
Root chord, m (ft)	1.80 (5.80)
Leading edge sweep angle, deg	43
Airfoil	NACA 0006
Primary control surfaces -	
Aileron hinge line	$0.75c_r$
Aileron span (total), m (ft)	3.70 (12.00)
Aileron area, each, m^2 (ft^2)	0.28 (3.00)
Aileron root station, $\frac{y}{b/2}$	0.62
Aileron root chord, m (ft)	0.20 (0.65)
Aileron range, each, deg	± 25
Elevator hinge line sweep angle, deg	0
Elevator area, m^2 (ft^2)	0.46 (5.00)
Elevator average chord, m (ft)	0.19 (0.62)
Elevator root chord, m (ft)	0.23 (0.75)
Elevator range, deg	25° up to 15° down
Rudder hinge line sweep angle, deg	0
Rudder area, m^2 (ft^2)	0.14 (1.51)
Rudder average chord, m (ft)	0.24 (0.77)
Rudder root chord, m (ft)	0.28 (0.91)
Rudder range, deg	± 25
Masses -	
Empty weight, N (lb)	6450 (1450)
Useful load, N (lb)	2930 (695)
Fuel load, N (lb)	2110 (475)
Gross weight, N (lb)	9540 (2145)
Powerplant -	
Engines	Two TRS-18-046
Sea-level static thrust, each, N (lb)	979 (220)

ORIGINAL PAGE IS
OF POOR QUALITY.

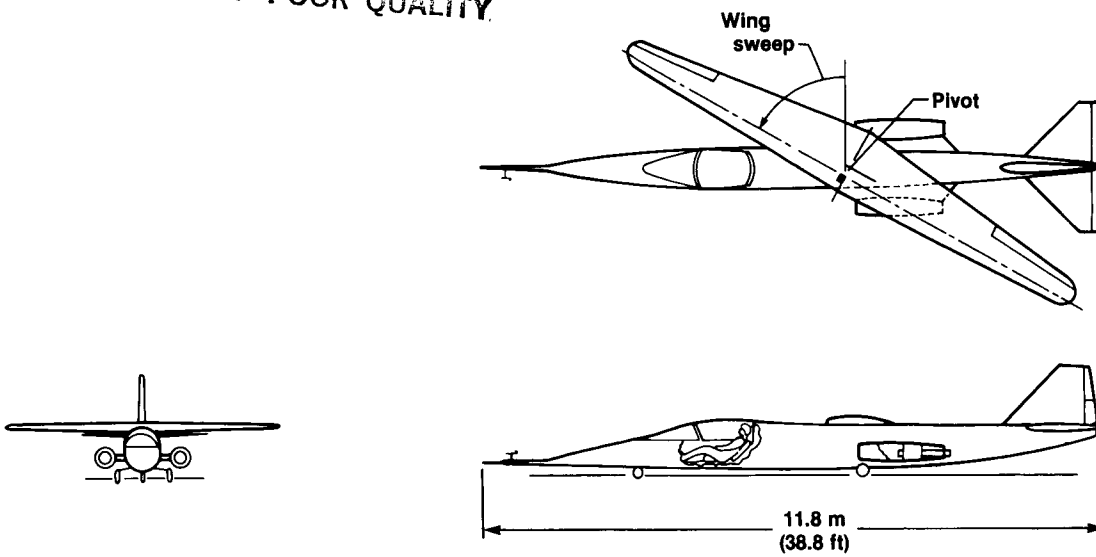
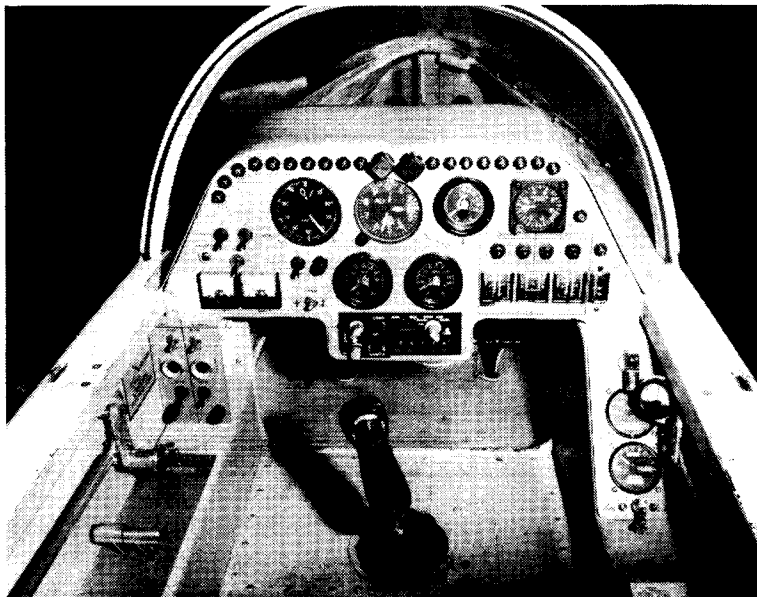
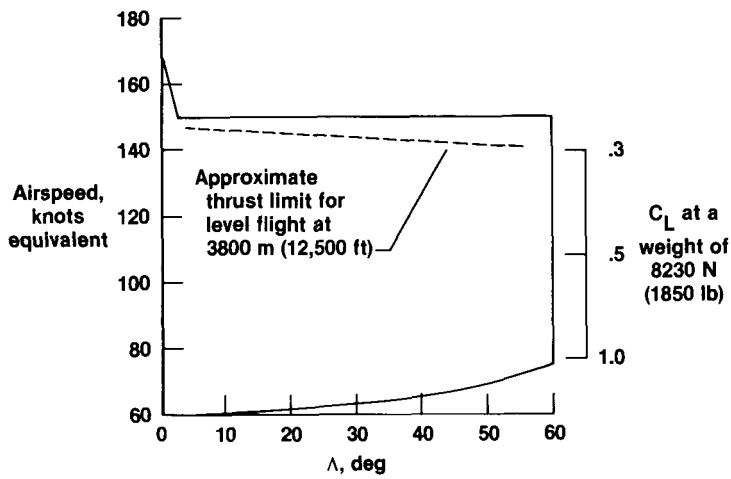

Figure 1. General configuration of AD-1 airplane.



E 39149

Figure 2. Instrument panel.



(a) Airspeed as a function of wing sweep.

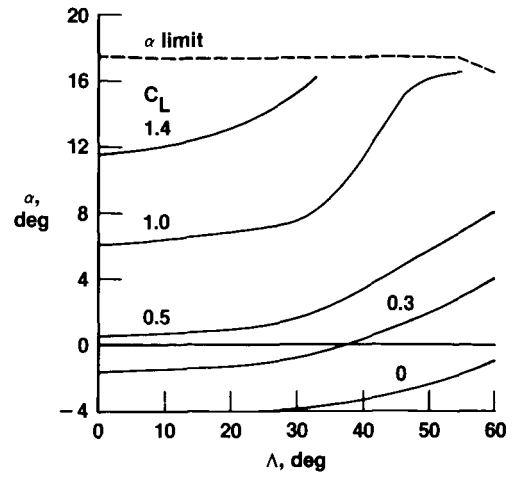

(b) Angle of attack as a function of wing sweep.

Figure 3. Flight envelope.

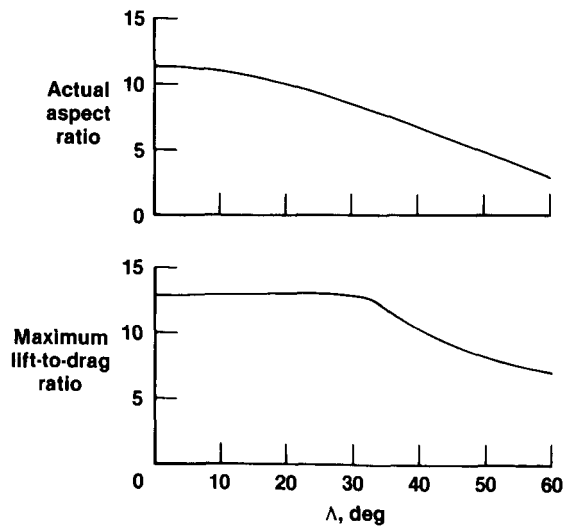

Figure 4. Actual aspect ratio and untrimmed maximum lift-to-drag ratio.

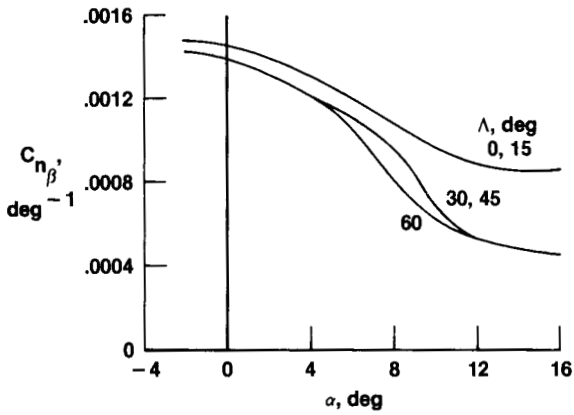

Figure 5. Directional stability derivative referenced to flight center of gravity.

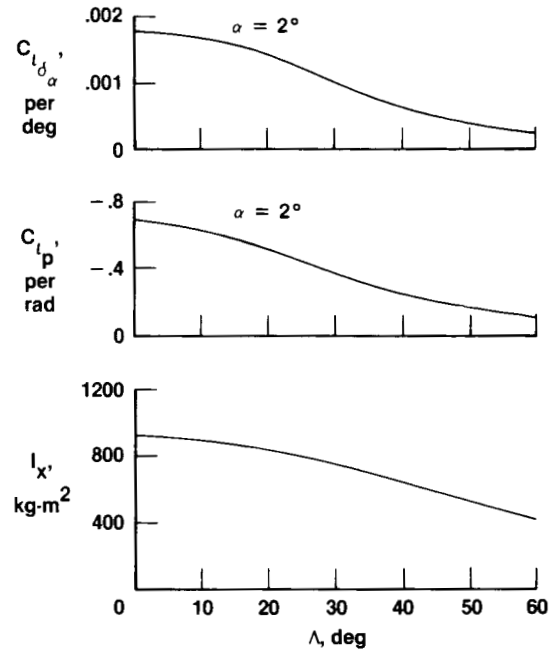

Figure 6. Roll control, damping, and moment of inertia variation with sweep.

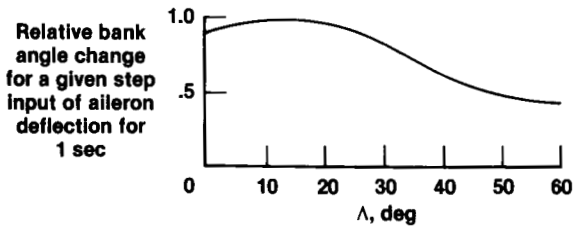

Figure 7. Relative aileron control power.

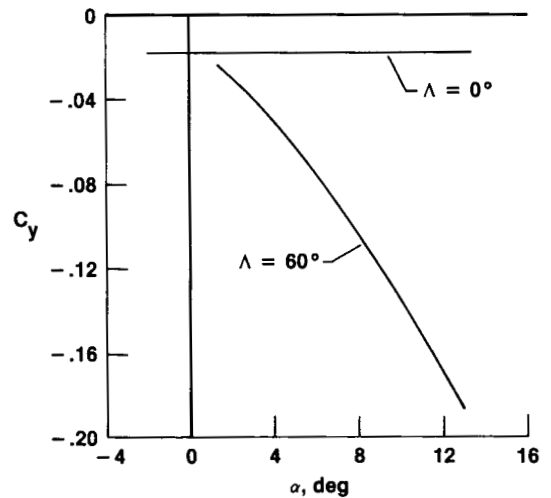

Figure 8. Variation in side-force coefficient with α .

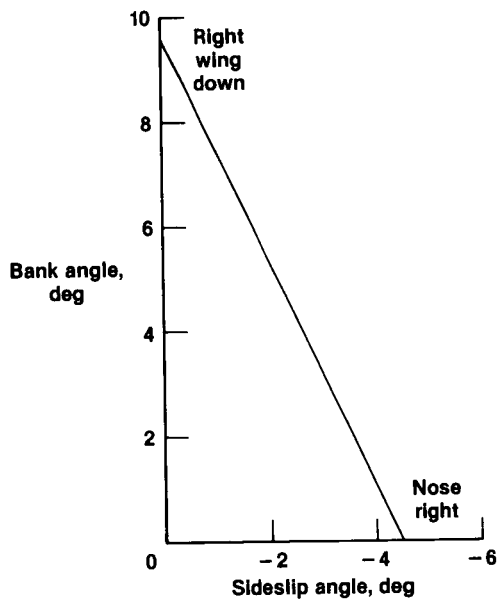

Figure 9. Bank angle or sideslip trim requirements necessary to compensate for sideforce. $C_L = 0.3$, $\Lambda = 60^\circ$.

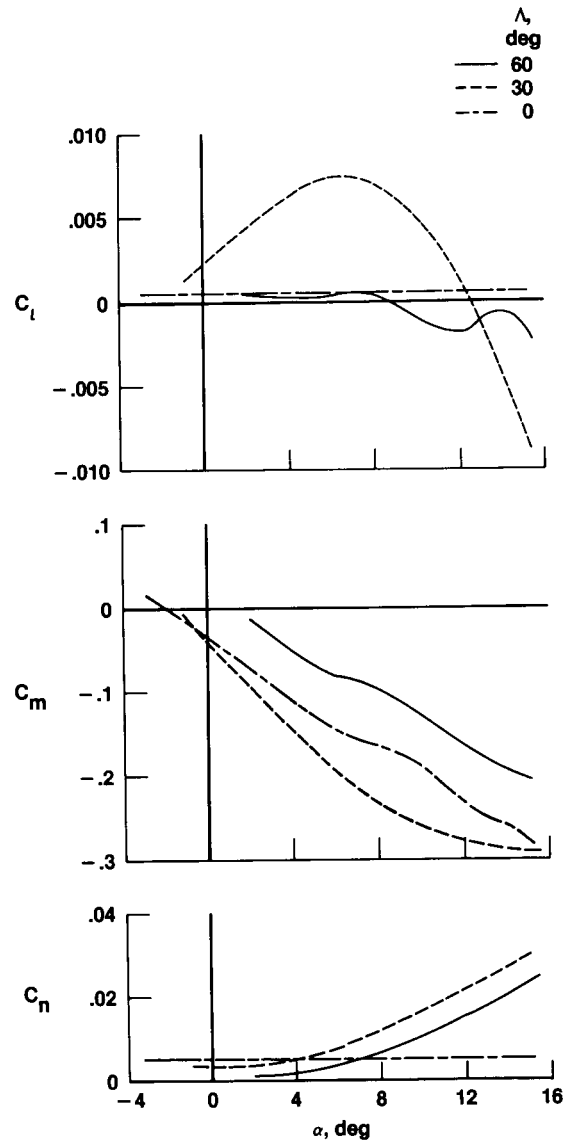

Figure 10. Untrimmed moment coefficients at unity load factor, referenced to flight center of gravity.

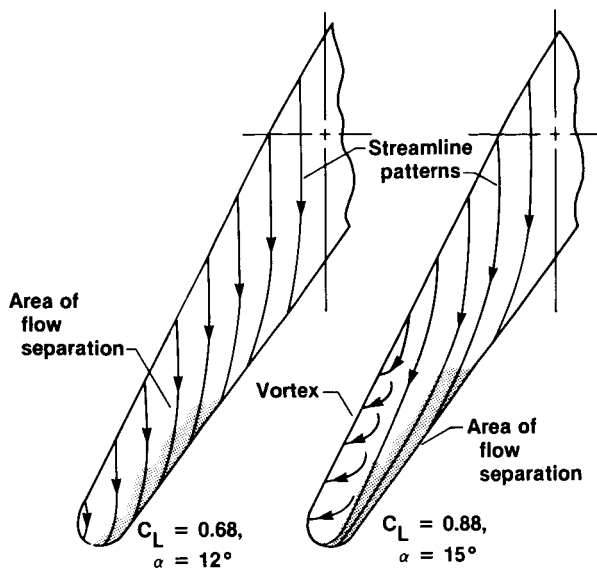

Figure 11. Trailing-wing upper-surface flow field for $\Lambda = 60^\circ$.

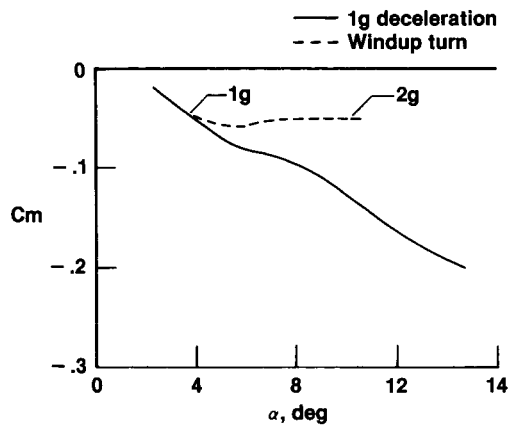

Figure 12. Untrimmed pitching moment during 1g and elevated-g flight. Flight c.g.

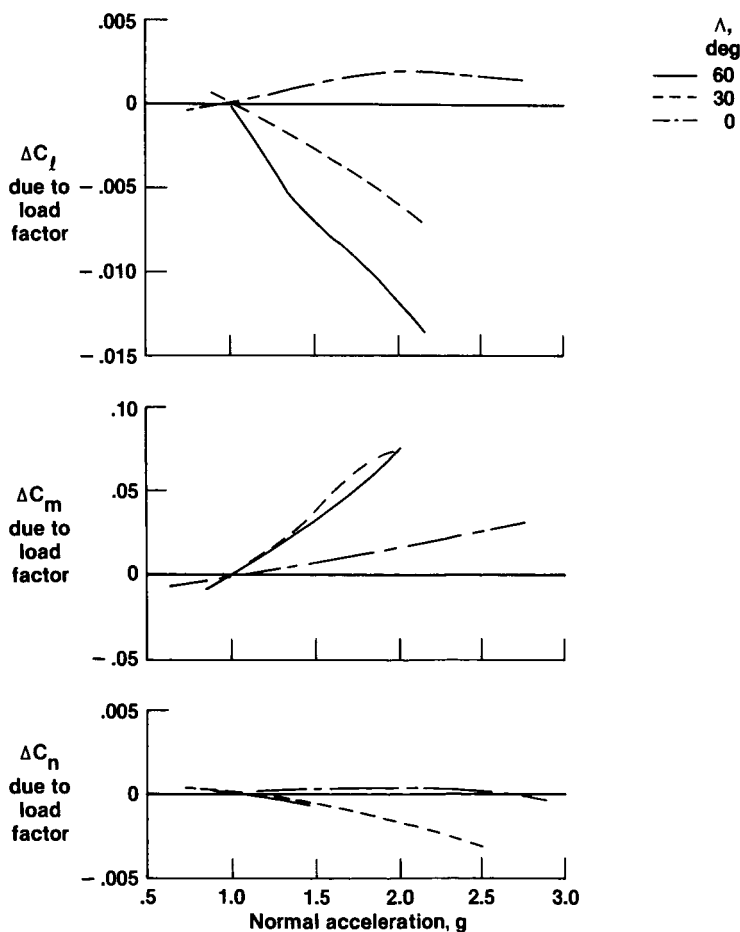

Figure 13. Effects of load factor on moment coefficients. Flight c.g.

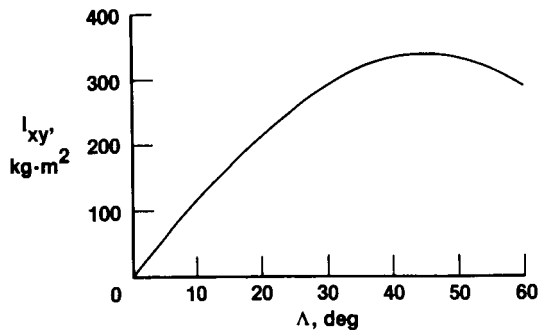

Figure 14. Roll-pitch cross product as a function of wing sweep.

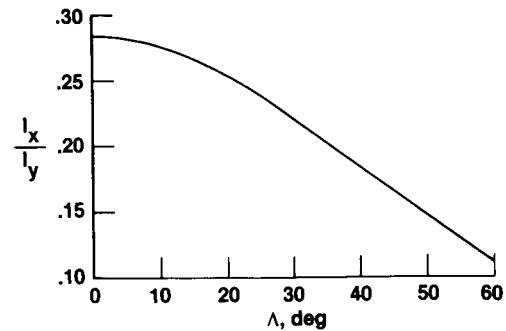

Figure 15. I_x/I_y as a function of wing sweep.

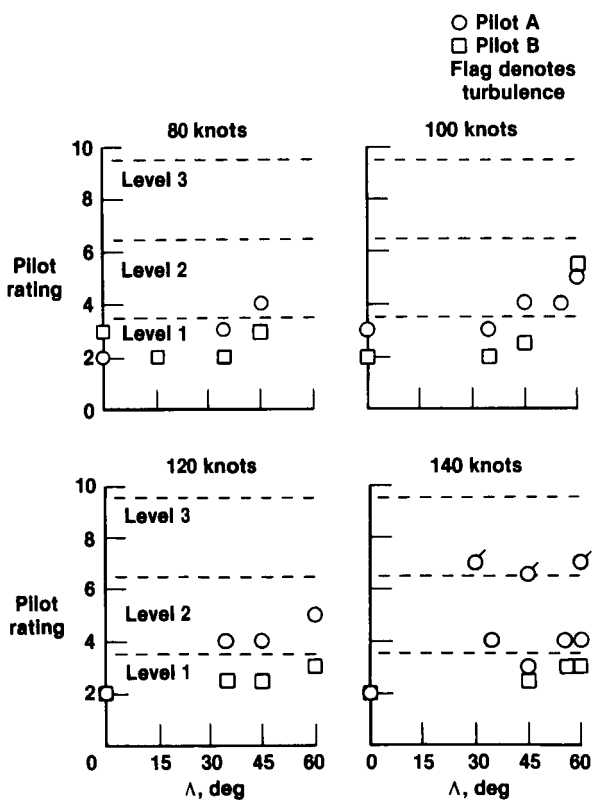

Figure 16. Pilot ratings for trim task.

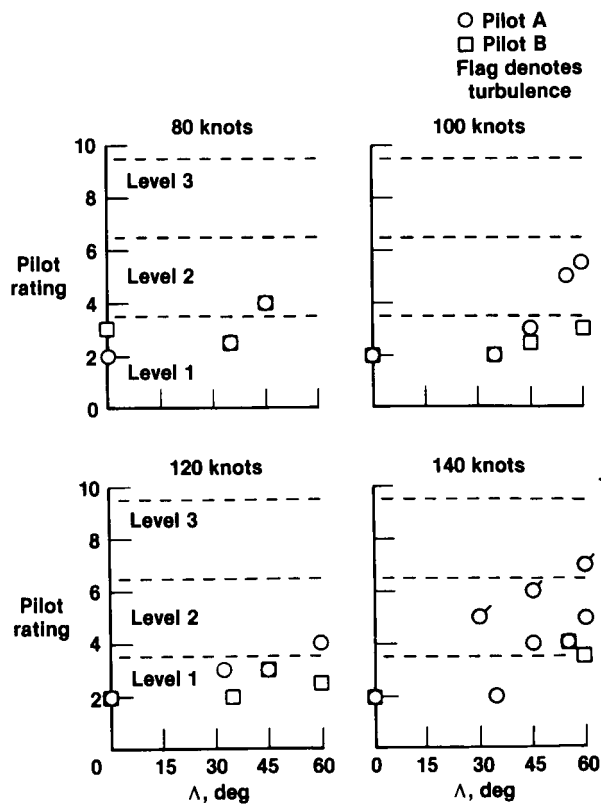
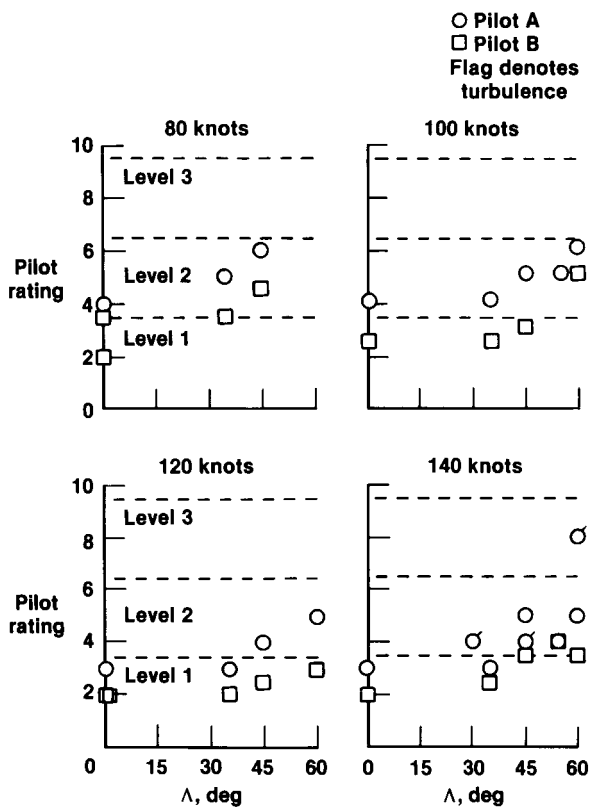
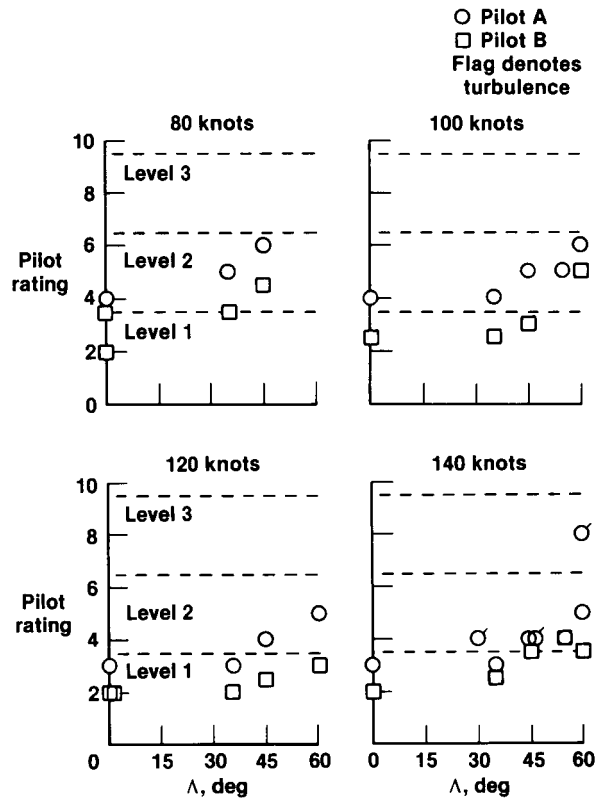

Figure 17. Pilot ratings for descent task.



(a) Right aileron rolls.



(b) Left aileron rolls.

Figure 18. Pilot ratings for aileron roll task.

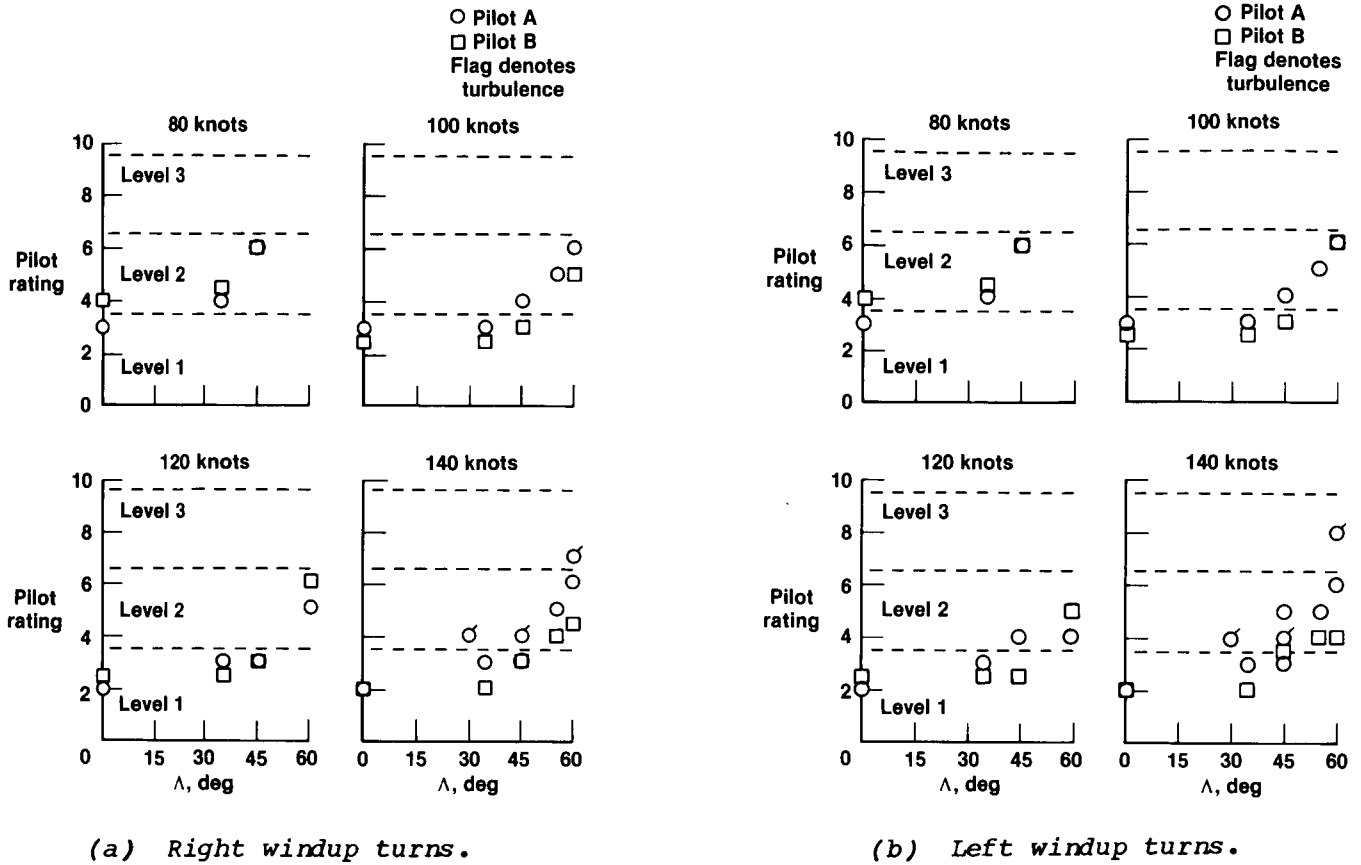

Figure 19. Pilot ratings for windup-turn task.

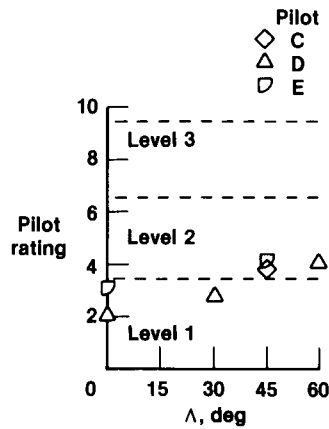
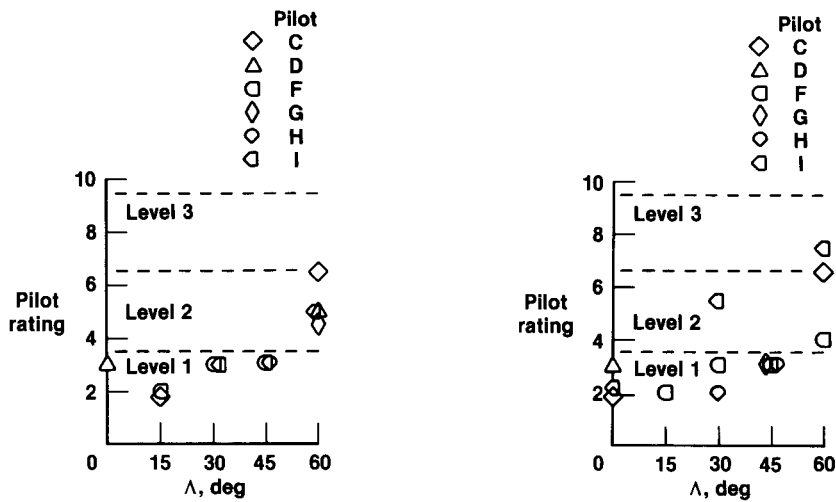

Figure 20. Guest-pilot ratings of trim task at 130 knots.



(a) Right windup turn.

(b) Left windup turn.

Figure 21. Guest pilot ratings of the windup-turn task at 130 knots.

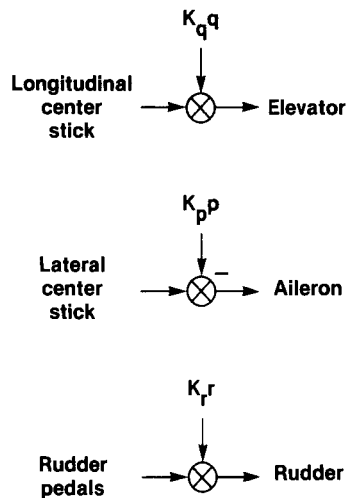
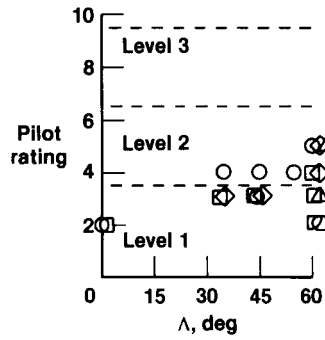
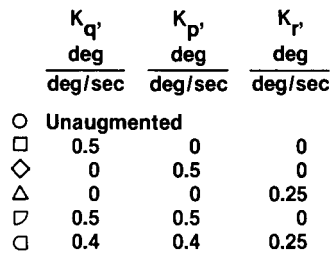
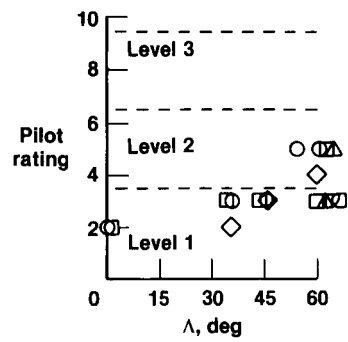
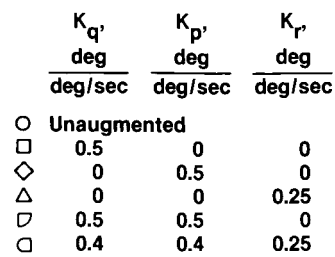

Figure 22. Simulator rate feedback control system option.



(a) Trim.



(b) Descent.

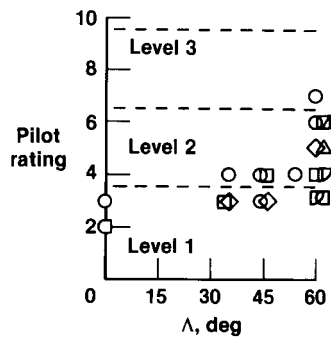
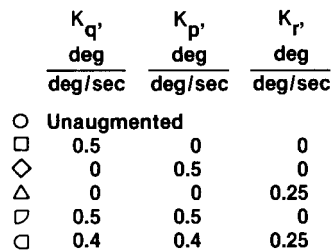

(c) Right aileron roll.

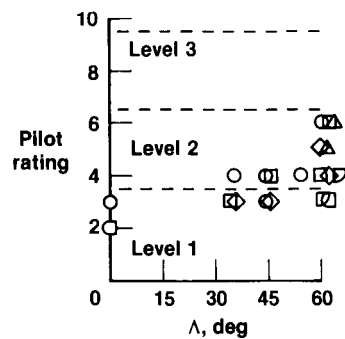
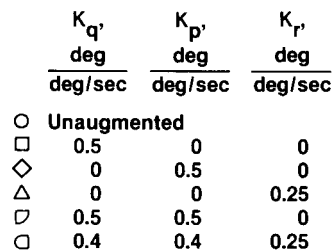

(d) Left aileron roll.

Figure 23. Simulator pilot ratings including the effects of using rate feedback augmentation at 140 knots.

	K_q , deg	K_p , deg	K_r , deg
	deg/sec	deg/sec	deg/sec
○ Unaugmented	0.5	0	0
◇	0	0.5	0
△	0	0	0.25
▽	0.5	0.5	0
□	0.4	0.4	0.25

	K_q , deg	K_p , deg	K_r , deg
	deg/sec	deg/sec	deg/sec
○ Unaugmented	0.5	0	0
◇	0	0.5	0
△	0	0	0.25
▽	0.5	0.5	0
□	0.4	0.4	0.25

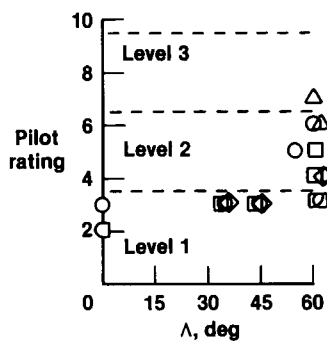

(e) Right windup turn.

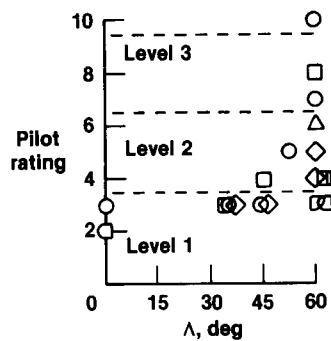

(f) Left windup turn.

Figure 23. Concluded.

1. Report No. NASA TP-2223	2. Government Accession No.	3. Recipient's Catalog No.	
4. Title and Subtitle Flight Characteristics of the AD-1 Oblique-Wing Research Aircraft		5. Report Date March 1985	
		6. Performing Organization Code	
7. Author(s) Alex G. Sim and Robert E. Curry		8. Performing Organization Report No. H-1180	
		10. Work Unit No.	
9. Performing Organization Name and Address NASA Ames Research Center Dryden Flight Research Facility P.O. Box 273 Edwards, California 93523		11. Contract or Grant No.	
		13. Type of Report and Period Covered Technical Paper	
12. Sponsoring Agency Name and Address National Aeronautics and Space Administration Washington, D.C. 20546		14. Sponsoring Agency Code RTOP 505-43-44	
		15. Supplementary Notes	
16. Abstract <p style="text-align: center;">The AD-1 is a low-speed oblique-wing research airplane. This report reviews the vehicle's basic flight characteristics, including many aerodynamic, stability, and control effects that are unique to an oblique-wing configuration. These effects include the change in sideforce with angle of attack, moment changes with angle of attack and load factor, initial stall on the trailing wing, and inertial coupling caused by a roll-pitch cross product of inertia. An assessment of the handling qualities includes pilot ratings and comments. Ratings were generally satisfactory through 30° of wing sweep but degraded with increased sweep. A piloted simulation study indicated that a basic rate feedback control system could be used to improve the handling qualities at higher wing sweeps.</p>			
17. Key Words (Suggested by Author(s)) AD-1 airplane Oblique-wing airplane Handling qualities Pilot ratings Inertial coupling Stability and control		18. Distribution Statement <div style="background-color: black; width: 150px; height: 15px; margin: 10px auto;"></div> <p style="text-align: right;">Subject Category 08</p>	
19. Security Classif. (of this report) Unclassified	20. Security Classif. (of this page) Unclassified	21. No. of Pages 27	22. Price

Available: NASA's Industrial Applications Centers