

3-AXIS LINEAR MOTOR DRIVE LASER CUTTING SYSTEM

LC-F1 NT Series

LC-3015FI NT, LC-4020FI NT

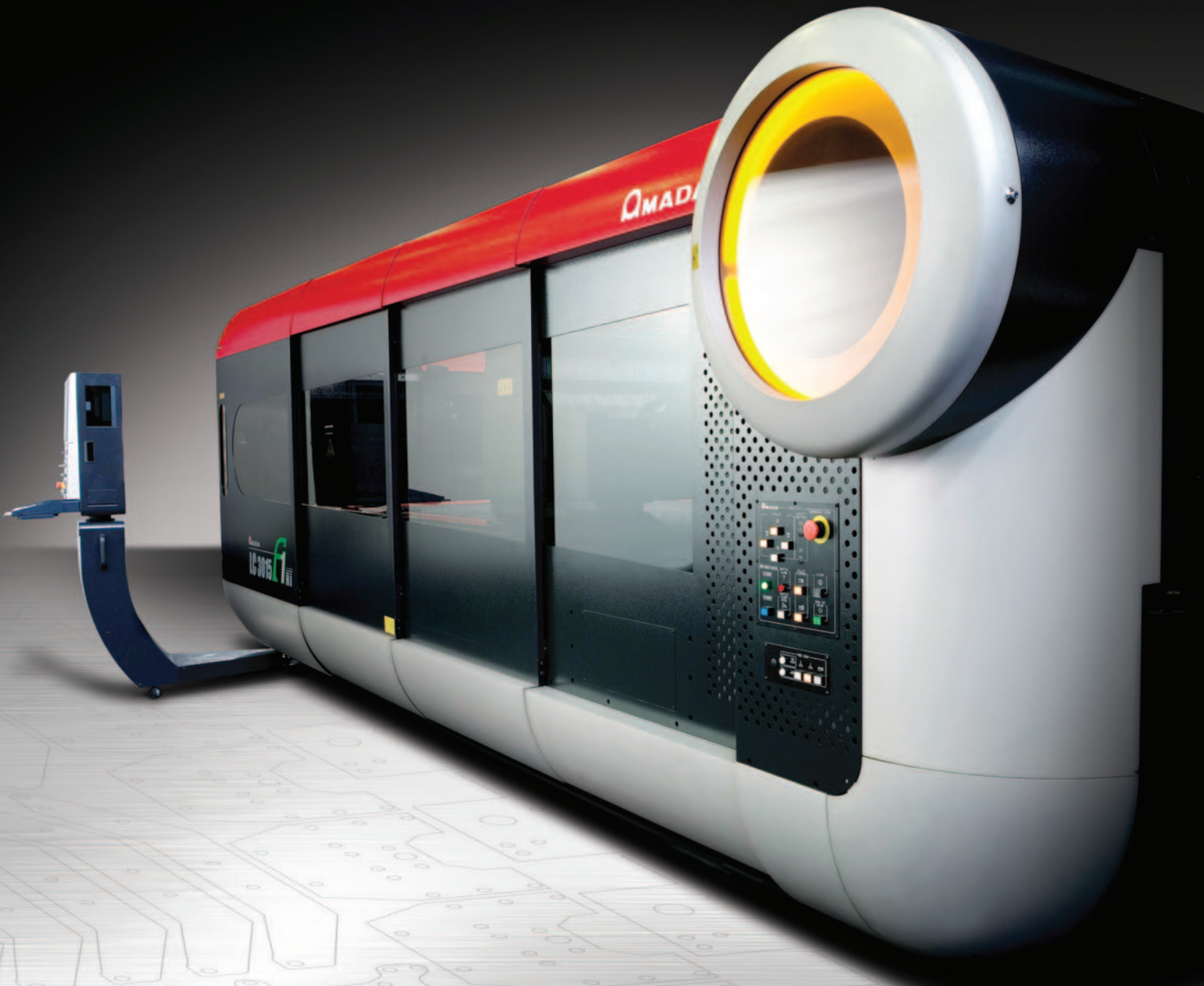

Ultra-fast. Ultra-precise. Full-range, fine-cutting laser system.

What do leading manufacturers need in a laser machine to stay competitive?

Amada engineered the LC-FI NT after carefully examining this question. The answer is to provide the optimal laser cutting system for every manufacturing requirement with the ability to produce high-quality parts efficiently and cost effectively. Based on a complete understanding of manufacturers' needs, Amada has developed the next generation in advanced laser cutting systems – the user-friendly and applications-oriented LC-FI NT.



5 Innovations attained through front-loading developments

1. **3-axis (X,Y,Z) linear motor drive system** is exceedingly fast and extraordinarily precise
2. **Amada-tuned oscillator** for quality cutting
3. **New AMNC/PC** with high-speed processor
4. **Twin-Adaptive optics** eliminate lens changes
5. **Cut-process monitoring** provides edge quality repeatability with auto-plasma detection



Seven achievements of the FI that have changed the laser machine concept.

1 EXCEPTIONALLY FAST PIERCING AND CUTTING WITH 3-AXIS LINEAR MOTOR DRIVE SYSTEM

Faster NC processing

Accelerated NC processing results in a dramatic reduction in piercing time

The combined speed of the AMNC control and the faster processing speed of the FI dramatically reduces overall processing time.

Processing time for the nested sheet shown on the right was reduced nearly twice as much (1.89) compared to a conventional machine. The efficiency of the AMNC control, reduced running costs by 56%.

Nesting sheet

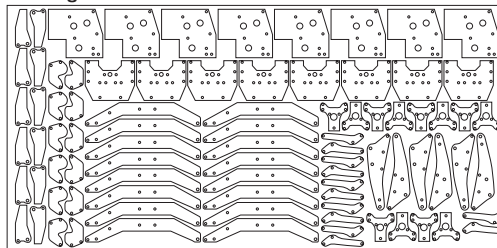

Mild steel, 0.031"
1 sheet, 4' x 8' material

Speed command
Conventional machine: 315ipm
LC-3015FIINT: 551ipm

Processing time
Conventional machine: 23min 50sec
LC-3015FIINT: 12 min 37sec

Shorter Processing Time

Shorter processing time at the same cut command speed!

A synergistic effect of faster axial acceleration/ deceleration and a faster travel speed result in a significant reduction of the fabrication process.

Cutting command speed, acceleration and cycle time*

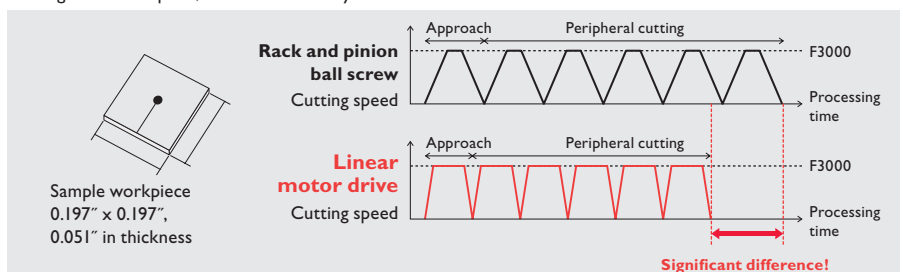

*Cycle time: The time from the beginning to end of a series of operations in a single process.

2 SUPERB CUTTING QUALITY WITH SHARP CORNERS OVER THE FULL THICKNESS RANGE

Amada-tuned oscillator AF4000i-B

Minimizes light fluctuation

Laser beam quality is improved by minimizing beam fluctuation unique to a high-speed axial flow.

Comparison of cut surface quality with conventional machine

Processing speed (ipm) comparison of cut surface roughness: Ra value (μm) 0.04" from top of face sheet (μm)

Processing	4kW oscillator (AF4000E) on conventional machine	4kW oscillator (AF4000i-B) on LC-FI NT	
Material thickness	Assist gas	Cut surface thickness	Cut surface thickness
Stainless steel 0.04"	Nitrogen 315"/min Ra=2.1		334.6"/min Ra=1.4
Stainless steel 0.12"	Nitrogen 118.1"/min Ra=1.9		118.1"/min Ra=1.2
Stainless steel 0.24"	Nitrogen 78.7"/min Ra=2.5		78.7"/min Ra=1.4
Mild steel 0.24"	Oxygen 118.1"/min Ra=2.2		118.1"/min Ra=1.1

Burn-free corners and edges

Smoother finish on cut surface

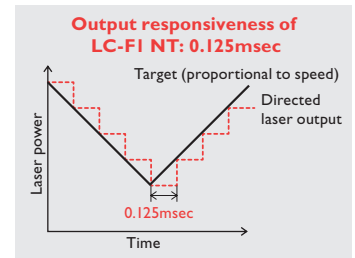
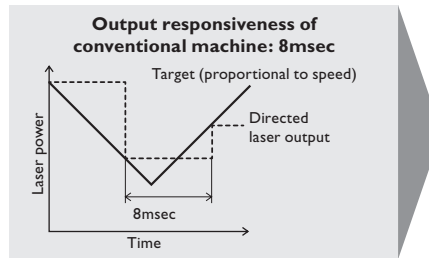
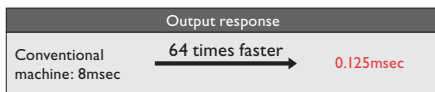

High-output responsiveness of 0.125msec with LC-FI NT oscillator allows thorough control of laser power

3 EXTRAORDINARILY PRECISE

Achieving high-accuracy and high-speed cutting

Constant precision cutting

A key element in the LC-FI NT's design is a 3-axis linear motor drive system, which allows for exceptionally high precision – enabled by true closed-loop feedback of the head position directly to the NC control.

Semi-closed loop control (Ball screw drive: Conventional machine)

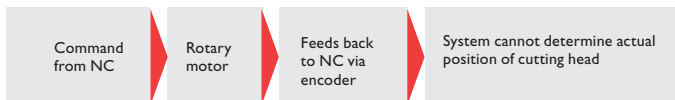
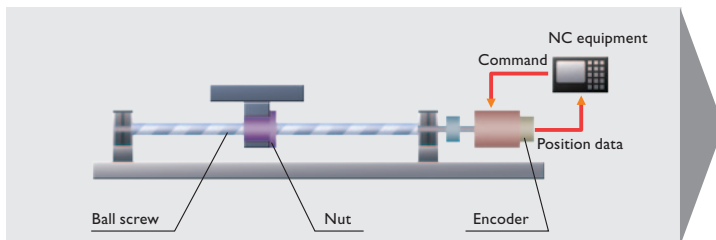

Full-closed loop (Linear motor drive: LC-FI NT)

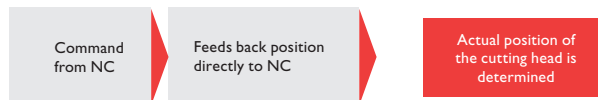
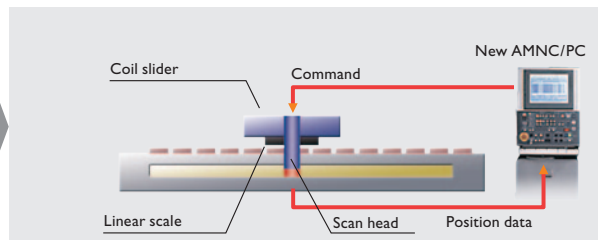

Linear drive system provides high-speed processing

Consistent precision cutting

A 3-axis linear motor drive system achieves high circularity without axial wear and tear.

Trajectory data of D300 (11.8") uniform circular motion (comparison with conventional machine)

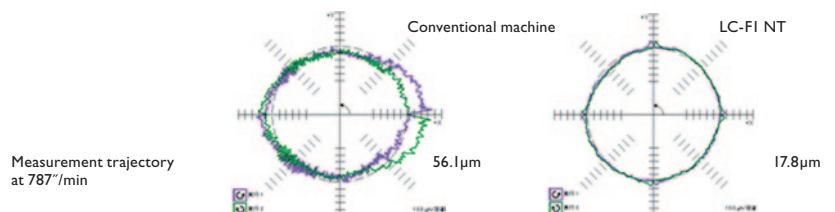

4 NO LENS CHANGE REQUIRED

Twin adaptive optics generate optimum beam

A single 7.5" lens handles thin to thick sheets

Two adaptive optics control the beam diameter for optimal cutting performance. A single 7.5" lens handles thin to thick sheets, reducing the costly time of replacing the lens.

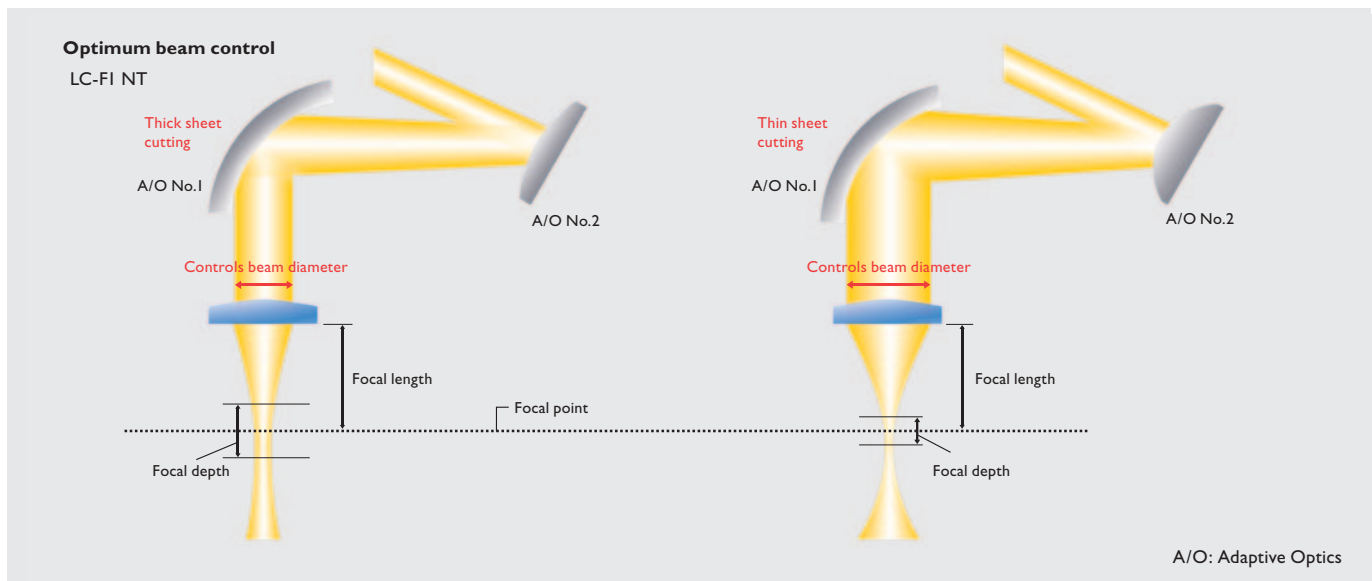
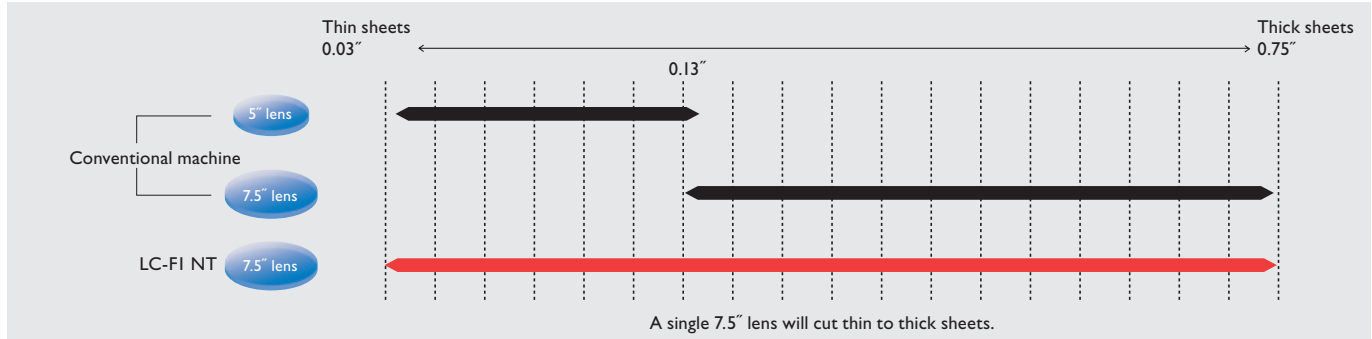

5 CONTINUAL PRODUCTION ON MIXED VARIANT MATERIAL AND THICKNESS

Automatic nozzle changer (optional)

Nozzle changes automatically based on the cutting condition

The optional nozzle changer assists in promoting continuous, unattended operation. An 8-station changer will automatically change, clean and calibrate both nozzle and head, based on the requirements specified for the material to be processed. This feature increases machine utilization, while reducing overall process time.



6 CUT-PROCESS MONITORING

Cut status detection function

Monitors cut status with feedback to the machine

Monitors the cut status with feedback from the machine, while constantly monitoring cut error factors such as piercing, gouging and plasma – all this in support of constant, stable cutting.

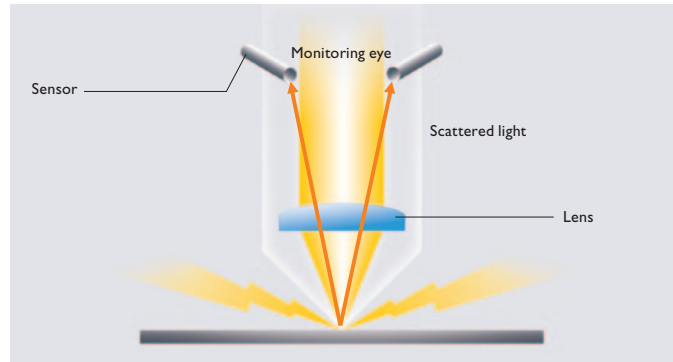

7 SITE-FRIENDLY WITH FULL ACCESS ENCLOSURES AND SELECTABLE RIGHT OR LEFT LAYOUT

Flexible layout for machine with shuttle table (LST)

Customers can choose a sheet output direction, right or left, for peripheral equipment according to their system layout. (Check actual availability of different configurations)

By placing all shuttle tables on the material entrance side, a single operator can manage multiple systems.

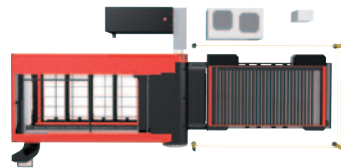
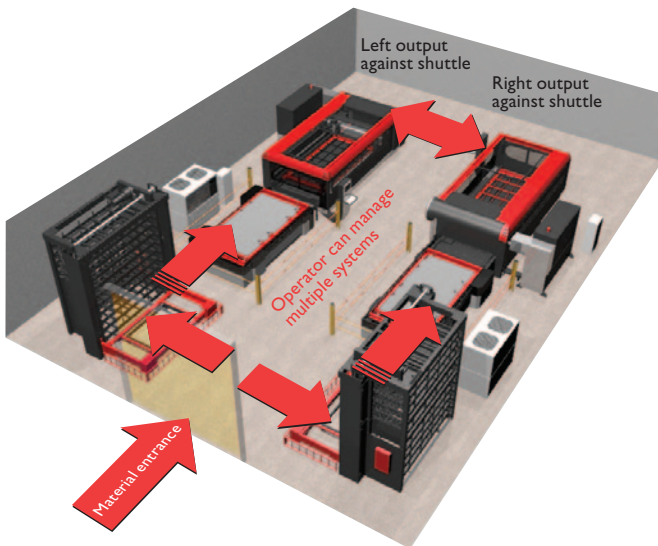

Shuttle table: Right output



Oscillator: Rear side (standard)

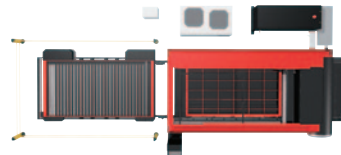

Shuttle table: Left output

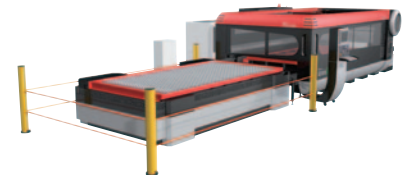

Oscillator: Rear side

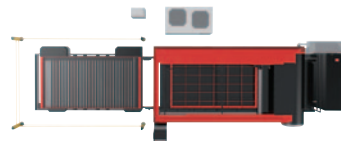

Shuttle table: Left output



Oscillator: Right side

Simple setup enabled by completely opening the enclosure

The unique machine design combined with a linear motor drive system, provides unmatched speed and versatility.

The fully open enclosure allows easy access for nozzle replacement and lens maintenance. It also allows the operator to load and unload materials from the main cutting area.



AMS AUTOMATION

MODULAR AUTOMATION DESIGNED FOR YOUR CUSTOM LAYOUT

AMS3015 10-Shelf + LC3015FI NT
Laser Cutting System



Amada is the global leader in the development and manufacture of automated equipment. In the late 1970's, Amada began manufacturing load/unload systems for turret punch presses and, in the 1980's, we also began producing automated systems for our laser machines. Today, Amada offers a diverse assortment of automation options that let you configure your system according to your specific operational requirements.

In order to compete successfully, manufacturers must be able to count on equipment that can respond to the changing needs of their facility. Unlike conventional automation, Amada's modular approach provides the flexibility required to expand as your manufacturing needs change.

Introduced in 2002, Amada's AMS (Automated Material Storage) system was engineered based on the following criteria:

1. Develop a system that can be expanded
2. Make all components standard modules
3. Allow modules to be configured to meet each customer's individual layout, expansion plan and changing needs

Varying in size and configuration, AMS systems are designed to help you improve productivity and increase profits by reducing lead-time and cutting costs.

SPECIFICATIONS

Model	AMS3015	AMS4020
Material Size	60" X 120"	80" X 160"
Material Weight	2,000 lbs.	3,000 lbs.
Shelving Options (Raw Material)	Single Cart, Dual Cart, 10-Shelf, 15-Shelf	Single Cart, Dual Cart, 10-Shelf, 15-Shelf
Shelving Options (Finished Process)	Single Cart, Dual Cart, 10-Shelf, 15-Shelf	Single Cart, Dual Cart, 10-Shelf, 15-Shelf
Maximum Weight per Shelf (Tower)	4,400 lbs.	4,400 lbs.
Part Removal/Stacking Available	YES	YES
Power Requirements	200/220V ±10% 50/60Hz	200/220V ±10% 50/60Hz

FORK PALLET CHANGER (ASF)

Single-sheet loading/unloading equipment + Shelf consisting of material pallet / finished parts pallet / cutting pallet

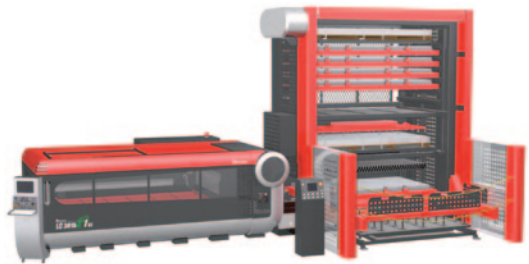

ASF SPECIFICATIONS

Model		ASF-3015F1
Pallet layout (standard)		Material pallet: 2 Finished parts pallet: 3 Cutting pallet: 2
Tower (overall height)		184.8"
Cycle time	Pallet change	40 sec
	Single sheet cycle	7 min 15 sec
Material pallet specifications ^{1 4}	Min. material size	36" x 36" x 0.03"
	Max. material size	120" x 60" x 0.5"
	Max. material height	7.5" (including 4" skid)
	Capacity	6000 lbs.
Cutting pallet specifications ^{2 4} (with 4 clamps)	Min. material size	31.5" x 6" x 0.03"
	Max. material size	120" x 60" x 1"
	Capacity	2000 lbs.
	Number of clamps	4 pneumatic
Finished parts pallet specifications	Min. part size	7" x 7" x 0.03"
	Max. stacking height	3.5" on the parts tray ³
	Capacity	6,000 lbs.

¹ The material pallet can be used without a skid.

² Specifications of the cutting pallet describe the fork without operation.

³ Amada supplies the equal number of parts trays to match the finished parts pallets.

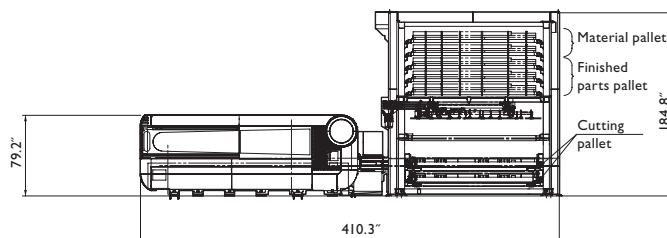
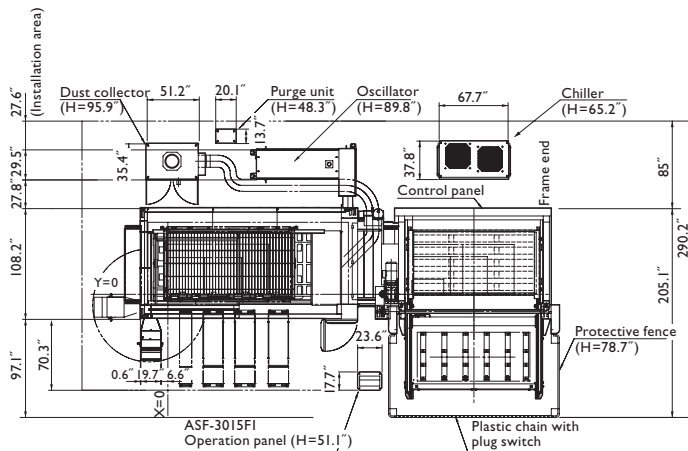

LC-3015F1 NT+ASF-3015F1 Fork pallet changer (right output)

MACHINE SPECIFICATIONS

Model	LC-3015F1 NT
Max. axis travel	120.9" x 61" x 3.9"
Max. mass of load	2,028 lbs.
Rapid traverse	X,Y,Z: 4,724"/min
Max. cutting speed	2,362"/min
Acceleration	X,Y: 1.5G Z: 3G
Cutting head	Cartridge-type cutting head
Z-axis sensor	HS-2007 (Anti-plasma, noise resistant)
NC	AMNC/PC
Oscillator model	AF-4000i-B (4kW)
Power requirement	Machine: 51 kVA / Oscillator: 55 kVA / Chiller: 27 kVA
Machine weight	28,660 lbs. (including oscillator)
Standard equipment	Full opening enclosure, CNC assist gas control (2.0MPa), CNC focus control, Oil shot, Cut process monitoring, Nozzle cleaner

* Specifications, machinery and equipment appearance are subject to change without notice for improvement purposes.

Note: LC3015F1 NT, LST3015F1 and ASF3015F1 (excluding hyphens) are the official machine names and model numbers for legal applications, such as machine installation permit, import/export permit and financing application. For legibility, LC-3015F1 NT, LST-3015F1 and ASF-3015F1 NT are used in this brochure.

Certain specifications described in this brochure may differ from the Amada products that are shipped. Please contact Amada for additional details.

DIMENSIONS

Shuttle table (LST)

Simple loading/unloading equipment (shuttle table) with two alternately-moving processing pallets

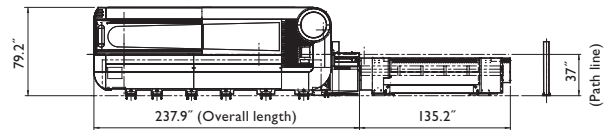
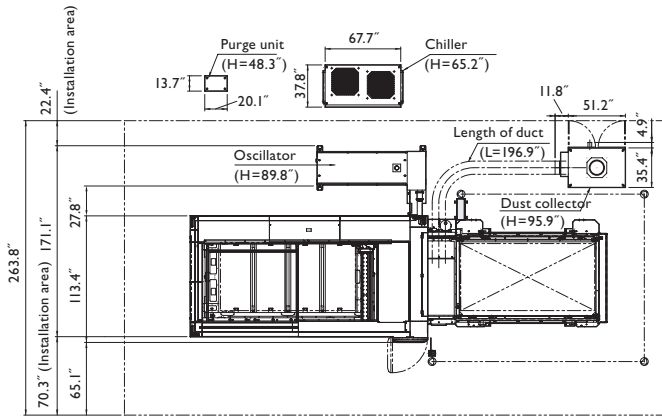
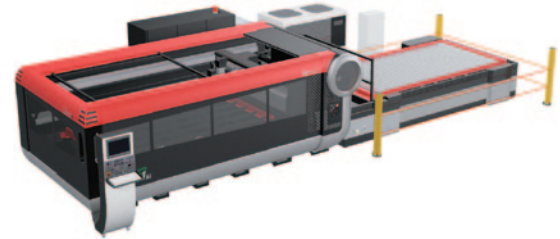

SPECIFICATIONS

Model		LST-3015F I
Material	Max. size	120" x 60" x 0.98"
	Max. mass of load	2,028 lbs./pallets
Work support		Metal plate
Operation method		Shuttle operation only

* Specifications, machinery and equipment appearance are subject to change without notice for improvement purposes.

Eco-friendly approach for future manufacturing.

LC-F1 NT is the first laser machine that took into consideration the hazardous chemical substances prohibited by the RoHS Directive*, to meet your strict demands for eco-friendly products. Also, LC-F1 NT contributes to CO₂ emission reduction by saving electricity usage through less power consumption and shorter processing time enabled by the processing speed improvement.

*The restriction of the use of certain hazardous substances enforced by U.S.



Substance prohibited by the RoHS Directive is not contained in our products.



- Before using this product, please read the operator's manual carefully and follow all applicable instructions.
- When using this product, appropriate protection equipment to the safety regulations of your country is necessary.



This product is using Class 4 invisible laser radiation for cutting and class 3R visible laser for indicating position.

- Class 4 laser : Avoid eye or skin exposure to direct or scattered radiation.
- Class 3R laser : Avoid eye exposure to direct radiation.

AMADA
Amada America, Inc.

7025 Firestone Boulevard • Buena Park, CA 90621 • (714) 739-2111 • FAX (714) 670-8020 • www.amada.com