

METREL test and measurement accessories:



**3-phase AktivGT /
Machine adapter Plus
A 1322 / A 1422
Instruction manual**
Version 1.1, Code no. 20 751 979

Distributor:

Manufacturer:

METREL d.d.
Ljubljanska cesta 77
1354 Horjul
Slovenia

web site: <http://www.metrel.si>
e-mail: metrel@metrel.si



Mark on your equipment certifies that this equipment meets the requirements of the EU (European Union) concerning safety and electromagnetic compatibility regulations

© 2012 METREL

No part of this publication may be reproduced or utilized in any form or by any means without permission in writing from METREL.

Table of contents

1	Preface	5
2	Safety and operational considerations	6
2.1	Warnings and notes.....	6
2.2	Standards applied	7
3	Description	8
4	Operation	10
4.1	Connections	10
4.2	Power supply considerations.....	11
4.3	Working with the adapter.....	12
4.4	Instrument data of the adapter	13
4.5	Messages.....	14
5	Measurements	16
5.1	Earth bond resistance measurement.....	16
5.1.1	<i>Compensation of test leads resistance</i>	16
5.2	Insulation resistance and substitute leakage current measurements	18
5.3	Insulation resistance (S-probe) and substitute leakage current (S-probe) measurements.....	19
5.4	Differential leakage current measurement.....	20
5.5	Touch leakage current measurement.....	21
5.6	Polarity / Active Polarity test.....	22
5.7	3-phase RCD test.....	24
5.8	Functional test	25
6	Measurements according to IEC / EN 60974-4 (A 1422 only)	26
6.1	Continuity of the protective circuit.....	26
6.1.1	<i>Compensation of test leads resistance</i>	26
6.2	Insulation resistance (supply circuit to protective circuit).....	27
6.3	Insulation resistance (welding circuit to protective circuit)	28
6.4	Insulation resistance (supply circuit to welding circuit)	29
6.5	Insulation resistance (supply circuit of class II equipment to accessible surfaces).....	30
6.6	Welding circuit leakage current	31
6.7	Primary leakage current	32
6.8	Touch leakage current.....	33
6.9	No load voltage	34
7	Maintenance	35
7.1	Cleaning	35
7.2	Service	35
8	Technical specifications	36
8.1	Test functions	36
8.1.1	<i>Earth bond resistance</i>	36
8.1.2	<i>Insulation resistance (including S-probe)</i>	36
8.1.3	<i>Substitute leakage current (including S-probe)</i>	36

8.1.4	Differential leakage current	36
8.1.5	Touch leakage current.....	36
8.1.6	Polarity / active polarity	37
8.1.7	3-phase portable RCD.....	37
8.1.8	Functional test.....	38
8.1.9	Continuity of the protective circuit (acc. to IEC/ EN 60974-4).....	39
8.1.10	Insulation resistance (supply circuit to protective circuit) (acc. to IEC/ EN 60974-4).....	39
8.1.11	Insulation resistance (welding circuit to protective circuit) (acc. to IEC/ EN 60974-4).....	40
8.1.12	Insulation resistance supply circuit to welding circuit (acc. to IEC/ EN 60974-4).....	40
8.1.13	Insulation resistance (supply circuit of class II equipment to accessible surfaces) (acc. to IEC/ EN 60974-4)	40
8.1.14	Welding circuit leakage current (acc. to IEC/ EN 60974-4)	41
8.1.15	Primary leakage current (acc. to IEC/ EN 60974-4)	41
8.1.16	Touch leakage current.....	41
8.1.17	No load voltage (acc. to IEC/ EN 60974-4)	41
8.2	General data.....	43

1 Preface

Congratulations for purchasing and using METREL 3-phase AktivGT / Machine adapter accessory with METREL test and measuring instruments.

The A 1322 / A 1422 enables testing of different types of three-phase electrical equipment.

Features:

- › All tests on 3-phase electrical equipment can be carried, including live leakage tests, power, portable RCD testing and polarity + active polarity test,
- › Simple connection to the PAT tester,
- › Simple test procedures, same as for single phase equipment,
- › Adapter is compatible with most of METREL PATs and machine testers,
- › A 1322 can be supplied from both 1-phase or 3-phase earthed power supply systems.

In addition A 1422 enables testing of electrical safety of welding machines according to IEC / EN 60974-4:

- › All appropriate tests (continuity of protective circuit, insulation tests, leakage and touch leakage tests, no-load voltage test) on 1 and 3-phase welding machines can be carried out.

Highlights:



- › Support for new types of PRCDs and PRCD protected equipment.
- › The accessory is automatically detected by the PAT tester. The test sequence for 3 phase equipment is automatically set on base of entered test code and input mains voltage.

A 1322 and A 1422 are three-phase accessories intended for using only with METREL appliance testers.

2 Safety and operational considerations

2.1 Warnings and notes

In order to reach high level of operator's safety while carrying out various tests and measurements as well as to keep the test accessory and equipment undamaged, it is necessary to consider the following general warnings:

-  **Warning means »Read the Instruction manual with special care to safety operation«. The symbol requires an action!**
- **If the A 1322 / A 1422 is used in a manner not specified in this Instruction manual or the manual of target test equipment, the protection provided by the A 1322 /**
- **A 1422 and equipment may be impaired!**
- **Read this user manual carefully, otherwise use of the A 1322 / A 1422 may be dangerous for the operator, for test equipment or for the tested object!**
- **Do not use the A 1322 / A 1422 if any damage is noticed!**
- **Consider all generally known precautions in order to avoid risk of electric shock while dealing with hazardous voltages!**
- **Tested appliance must be disconnected from any supply system and discharged!**
- **Service intervention is allowed to be carried out only by a competent authorized person!**
- **Do not touch free male connectors during the (active) polarity test.**
-  **Use only earthed 1- phase or 3- phase mains supply system to power A 1322 / A 1422 adapter! PE must have low impedance to earth, recommended is $< 0.3 \Omega$.**
- **Pay attention that tested appliance can be normally activated when it is connected to test socket of A 1322 / A 1422.**
- **Do not connect 3-phase appliances to the A 1322 / A 1422 test sockets in case the A 1322 / A 1422 is single phase supplied, this could lead to abnormal operation and/or damages of the 3-phase tested appliance.**

2.2 Standards applied

The instrument is manufactured and tested according to the following regulations, listed below.

Safety (LVD)

EN 61010 -1	Safety requirements for electrical equipment for measurement, control, and laboratory use – Part 1: General requirements
EN 61010 -2 -030	Safety requirements for electrical equipment for measurement, control and laboratory use – Part 2-030: Particular requirements for testing and measuring circuits
EN 61326 -1	Electrical equipment for measurement, control and laboratory use - EMC requirements - Part 1: General requirements

Application

A 1322 and A1422

VDE 0701 -0702	Prüfung nach Instandsetzung, Änderung elektrischer Geräte – Wiederholungsprüfung elektrischer Geräte - Teil 0702: Allgemeine Anforderungen für die elektrische Sicherheit
IEE Code of Practice	Code of Practice for In-service Inspection and Testing of Electrical Equipment

A 1422

IEC/EN 60974 - 4	Arc welding equipment - Part 4: Periodic inspection and testing
VDE 0544 - 4	

Note about EN and IEC standards:

Text of this manual contains references to European standards. All standards of EN 6xxxx (e.g. EN 61010) series are equivalent to IEC standards with the same number (e.g. IEC 61010) and differ only in amended parts required by European harmonization procedure.

3 Description

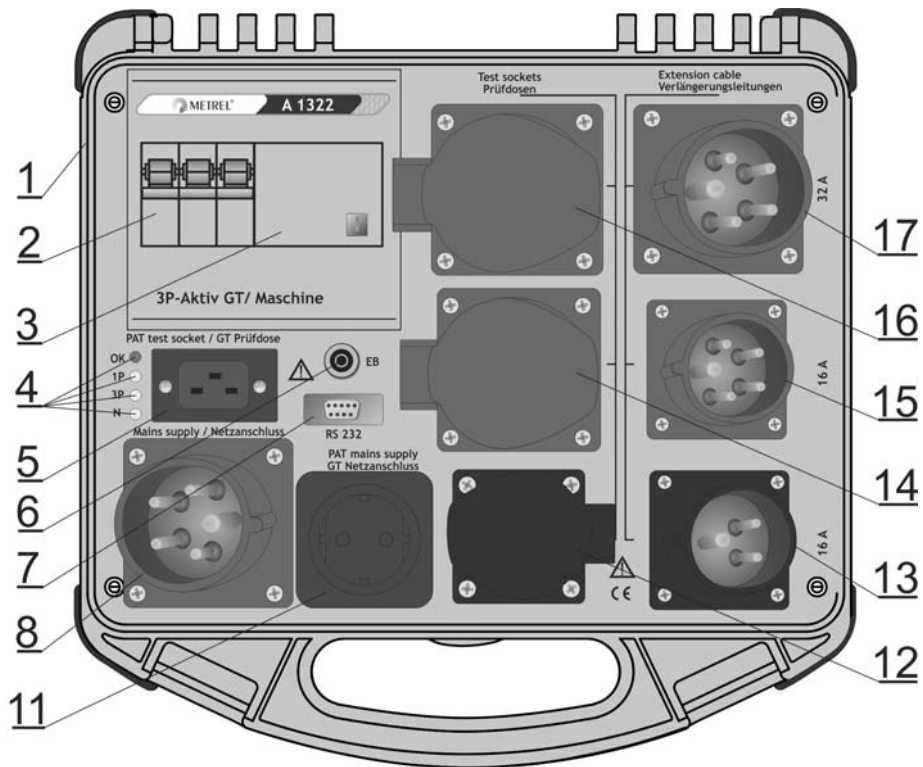

Figure 3.1: A 1322 front panel

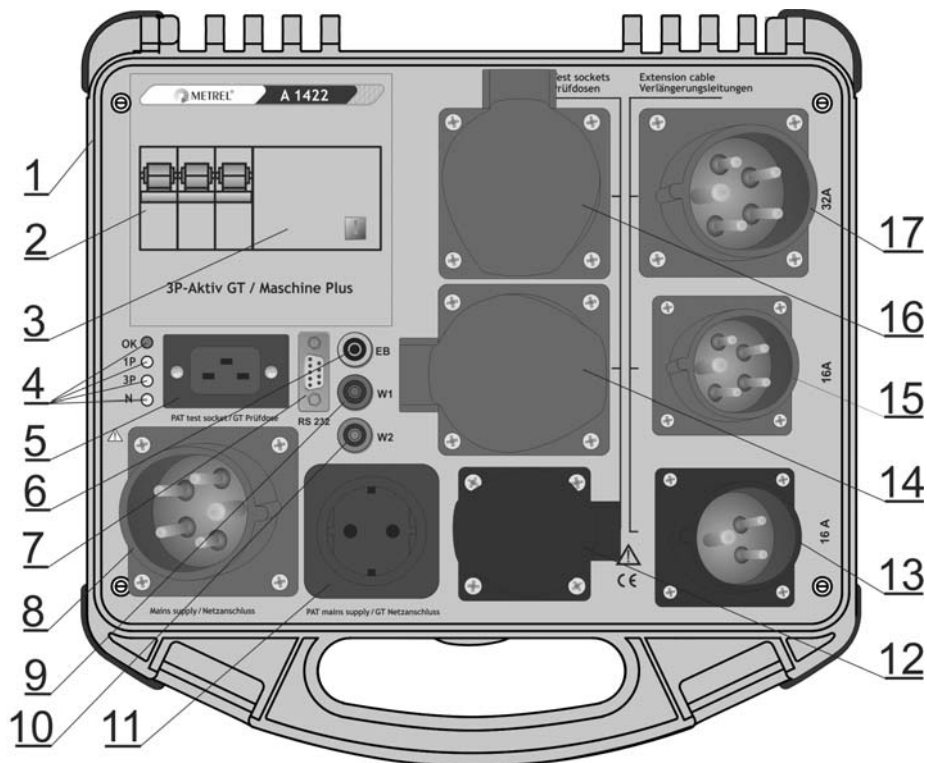





Figure 3.2: A 1422 front panel

Legend:

1	Plastic case.
2	Circuit breaker.
3	Contactor for enabling testing with mains supply (functional, power, leakage, PRCD).
4	Status indicators, (OK, 1P, 3P, N) see chapter 4.4, <i>Messages</i> .
5	PAT test socket. (For connection to appliance tester test socket.)  Never connect it to mains supply socket!
6	EB connection to the master instrument. See chapter 4.1 <i>Connections</i> for more information.
7	RS 232 connector for communication with master instrument.
8	Power supply plug connector, for power supply options see chapter 4.2, <i>Power supply considerations</i> .  Never operate the A 1322 / A 1422 at other mains supply as defined in chapter 4.2 and supply voltages other as defined in chapter 8.2.
9	W1 Test socket for connection of welding output of welding machine (A 1422 only).
10	W2 Test socket for connection of welding output of welding machine (A 1422 only).
11	Supply socket for master instrument. The socket is controlled via circuit breaker (2) Note: The master instrument can be supplied from the socket of the A 1322 / A 1422 or directly from any other wall socket with proper voltage and grounding.
12	Test sockets
13	- 16: 3-phase 32 A appliance; 17 + 16: 32 A 3-phase cord,
14	- 14: 3-phase 16 A appliance; 15 + 14: 16 A 3-phase cord,
14	- 12: single phase 16 A appliance; 13 + 12: 16 A single phase cord.
15	 Sockets 12, 14, 16 are intended for test purpose only! Never use the A
16	1322 / A 1422 for power supply distribution!
17	 Do not connect external supply to any of test sockets and/or plugs.

4 Operation

The A 1322 / A 1422 operates in conjunction with the master instrument (PAT or Machine tester).

Following is the list of applicable testers; in this manual they are referred as a master instrument:

- › MI 3310 SigmaPAT (SigmaGT) and
- › MI3321 MultiservicerXA.

4.1 Connections

Required and optional connections between A 1322 / A 1422 and the master instrument are shown in the following figure.

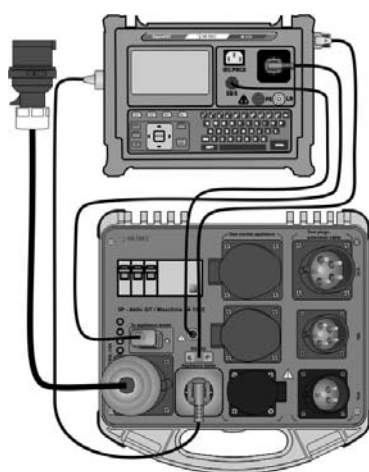

Figure 4.1: Connection of MI3310 instrument

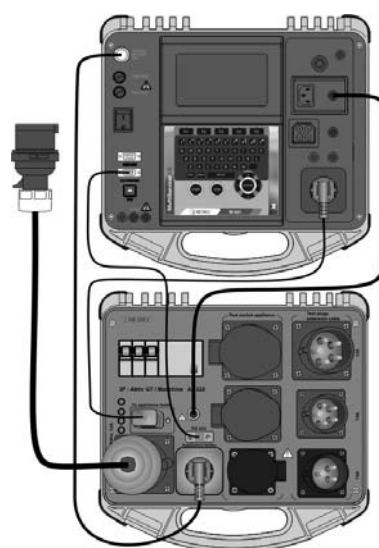

Figure 4.2: Connection of MI3321 instrument

Required connections are:

- Measuring connection between PAT test socket (5) on A 1322 / A 1422 and mains test socket of the master instrument, and
- RS232 communication interface between the A 1322 / A 1422 (7) and PC/Printer connector on the master instrument.

Optional connections:

- when measuring prolongation cords and PRCDs via test sockets 13,15,17 the EB(6) should be connected to the EB/S (or S/C1) terminal on the master instrument . The connection is used for earth bond and polarity tests. The EB(6) connection is not intended for measuring earth bond of appliances not connected to sockets 13,15,17, touch current, insulation resistance S, substitute leakage current S). For this tests the EB/S (or S/C1) terminal on the master instrument shall be used (no connection to the EB(6) socket on the A 1322 / A1422).
- The master instrument can be optionally supplied via power supply socket (1). It is recommended to use this connection, especially if no external 230 V wall sockets is available. The voltage on supply socket (11) is turned on/off with the fuse/circuit breaker (2) on A 1322 / A 1422.

4.2 Power supply considerations

The 3-phase 32 A socket (8) of A 1322 / A 1422 is intended for connection to mains supply. A1322 / A1422 can be connected to single-phase and 3-phase mains supply. The figure below shows connections of supply cords for both possibilities.

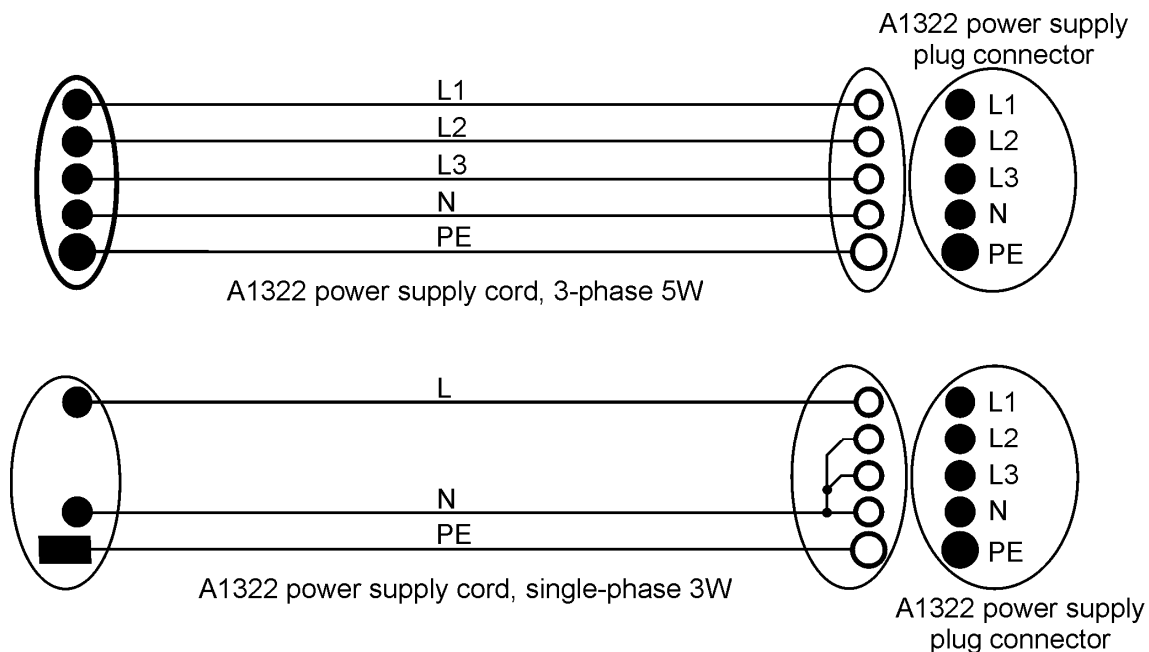

Figure 4.3: Mains supply cable for single-phase supply and 3-phase supply

The A 1322 / A 1422 works in TN/TT supply systems with distributed N and/or NPE and rated supply voltages U_{L-N} / U_{L-L} 230/400 V and/or 120/208 V.

Operation on 3-phase system without N conductor

The A 1322 / A 1422 can also be supplied in 3-phase 4W system (without N conductor). In this case the master instrument can not be supplied from the A 1322 / A 1422 and shall be connected to an external 1-phase wall socket.

Some tests can not be performed successfully:

- Active tests/measurements (differential and touch leakages, active polarity, PRCD testing and functional test) on 16 A (3 pole: L+N+PE) test socket.
- Active polarity test on 5 pole (L1+L2+L3+N+PE) 16 A and 32 A test sockets.
- PRCD testing on all test sockets.

4.3 Working with the adapter

Master instrument must be set in a special operating mode to support operation with A 1322 / A 1422. Following steps on the master PAT instrument are to be performed to enable/disable working with A 1322 / A 1422.

Step no.	Description
1	Press and hold the ESC key on alpha-numeric keyboard and switch on the master instrument .
2	Enter password A1322 for A 1322 or A1422 for A 1422 and press the ENTER key for confirmation.
3	In SET A 1322 (SET A 1422) menu select A 1322 ON (SET A 1422 ON) option to enable the support for A 1322 (or A 1422) on master instrument. Press the ENTER key for confirmation. Master instrument can now be used with A 1322 (or A 1422) 3-phase adapter.

Notes:

- › 3-phase adapter's data can be transferred and seen on the master instrument by pressing "**3Ph>Dat**" (F2) key on the *Instrument data* menu of the master instrument. See user manual of the master instrument for details.
- › To **disable** the support for A 1322 / A 1422 on master instrument, use **A 1322 OFF (A 1422 OFF)** option.

For using the A 1322 / A 1422, the following procedure shall be applied:

Item	Comment
› Connect A 1322 / A 1422 and the master instrument via RS232 interface.	See <i>chapter 4.1 Connections</i>
› Connect the master test socket and the A 1322 / A 1422 PAT test socket.	See <i>chapter 4.1 Connections</i>
› Connect the master instrument mains cord to the output power supply socket on A 1322 / A 1422.	See <i>chapter 4.1 Connections</i>
› Connect A 1322 / A 1422 to mains supply.	
› Turn on fuse/circuit breaker on A 1322 / A 1422.	The adapter beeps.
› Turn on the master instrument.	
› Select the test function.	See user manual of the master instrument.
› Measuring system is now ready for testing.	3PH appears on the upper left corner of the master instrument screen for indication of connected A 1322 / A 1422.
› Connect tested equipment to the proper test socket/plug	See <i>Chapter 5 Measurements / Chapter 6 Measurements according to IEC EN 60974-4 for proper connection of appliances / welding machines</i>

- Press Start on the master instrument to start the test sequence. *to a measuring system.* See user manual of the master instrument.

4.4 Instrument data of the adapter

Instrument data (serial number, hardware and firmware version, etc.) of A 1322 / A 1422 can be read when working with A 1322 / A 1422 is enabled on the master instrument. Actual instrument data of A 1322 / A 1422 can be uploaded to and stored in the master instrument if A 1322 / A 1422 is connected to the master instrument.

Instrument data of the A 1322 / A 1422 are available in Setup / Instrument data menu of the master instrument.

First select Instrument data from Setup menu.

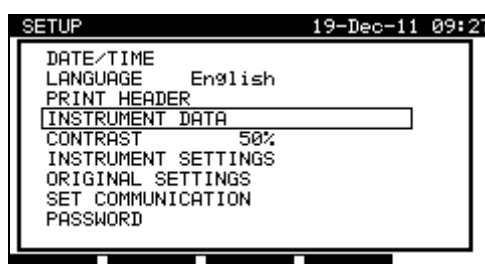

Figure 4.4: SETUP menu

In the Instrument data menu the instrument data of the master instrument are displayed first.

F1 (MORE): toggles between A 1322 / A 1422 and master instrument data.

F2 (3Ph>Dat): A 1322 / A 1422 instrument data is uploaded to the master instrument, stored into its memory and displayed.

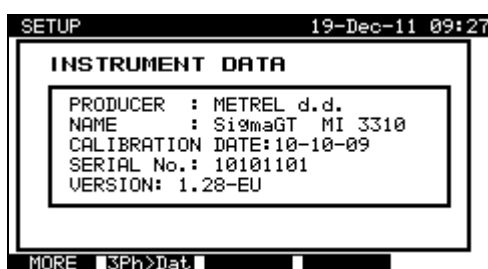

Figure 4.5: MI 3310 instrument data

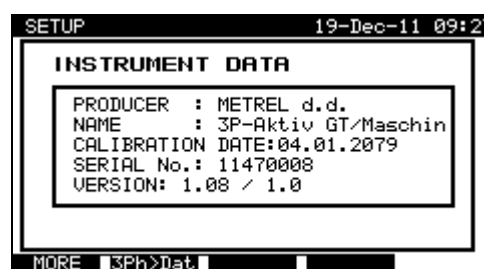

Figure 4.6: A 1322 / A 1422 instrument data

Note:

- For more information refer to user manual of the master instrument.

4.5 Messages

When master instrument works with A1322/A1422 some new messages are used. Refer to user manual of master instrument for detailed information.

Message	Description
SigmaGT is not connected to A1322 (A1422).	No connection between PAT mains test socket and A 1322 / A 1422 PAT test socket (5) ! Check connection / cable.
Connect PAT and A1322/A1422 via RS232.	No serial communication (RS232) connection between PAT and A1322/A1422 . Check serial communication cable.
MEASUREMENT ABORTED COMMUNICATION INTERRUPTED.	Serial communication between master instrument and A1322/A1422 was lost.
MEASUREMENT ABORTED BUCAUSE OF SAFETY!	Instrument skipped the required test because of a failed previous test.
MEASUREMENT ABORTED. Use 1-phase supply on A1322/A1422.	For performing selected test/measurement 1-phase supply voltage system is required.
For testing of RCDs with I _{dn} =100mA or 30mA, A1322/1422 must be used.	Selected test/measurement can only be performed using A1322/A1422. Connect A1322/A1422 to master instrument and start test again.
For this measurement use A1422.	Selected test/measurement can only be performed using A1422. Connect A1322/A1422 to master instrument and start test again.
EXTERNAL VOLTAGE ON TEST SOCKET TOO HIGH ON A1322/A1422.	DANGER! - Voltage on test socket (16A or 32A) is higher than approximately 25 V (AC or DC)! Disconnect the test probe from the DUT and determine why external voltage was detected!
EXTERNAL VOLTAGE ON TEST V16A/32A TOO HIGH ON A1322/A1422.	DANGER! - Voltage on test plug (16A or 32A) is higher than approximately 25 V (AC or DC)! Disconnect the test probe from the DUT and determine why external voltage was detected!
HARDWARE ERROR Return the instrument to the repair centre.	The instrument detects a serious failure.

Status indicators

LED indicator	Description
OK	Continuous: The A 1322 / A 1422 is ready for use.

	Blinking:	Hardware error.
1P	<p>Single-phase supply system status</p> <p>Continuous: A single-phase supply voltage is applied.</p> <p>Blinking: Warning for improper power supply voltage condition: Possible causes are:</p> <ul style="list-style-type: none"> - L and N wire crossed, - No earth connection or other wiring problem on supply socket, - Incorrect mains voltage. <p>Warning:</p> <ul style="list-style-type: none"> • The A 1322 / A 1422 must be properly earthed! See 4.2 Power supply considerations. 	
3P	<p>3-phase supply system status</p> <p>Continuous: A 3-phase supply voltage is applied</p> <p>Blinking: Warning for improper power supply voltage condition: Possible causes are:</p> <ul style="list-style-type: none"> - No earth connection or other wiring problem on supply socket, - L and N wire crossed when instrument is connected to 1-phase supply system, - Incorrect mains voltage. <p>Blinking at start-up 3-phase supply voltage is applied. Check phase rotation.</p> <p>Warning:</p> <ul style="list-style-type: none"> • The A1322 / A 1422 must be properly earthed! See 4.2 Power supply considerations. 	
N	<p>Power supply Neutral conductor status</p> <p>Light on: Power supply system with N conductor.</p> <p>Light off: No N conductor in the incoming power supply system.</p>	

5 Measurements

5.1 Earth bond resistance measurement

 Refer to chapter **Measurements – Single tests for appliances**, paragraphs **Earth bond resistance** in master instrument user manual for detailed information.

Procedure:

Item

- Prepare test system.
- Compensate test leads resistance (if necessary).
- Connect power supply plug of tested appliance into proper test socket.
- Connect probe to the accessible conductive part of the CLASS I appliance.
- Prepare and start measurement on the master instrument.
- Wait until measurement is finished or stop the measurement.
- Check result(s).
- Store result(s).

Comment

See chapter 4.3 *Working with the adapter*.
See chapter 5.1.1 *Compensation of test leads resistance*.
See figure below.

Optional

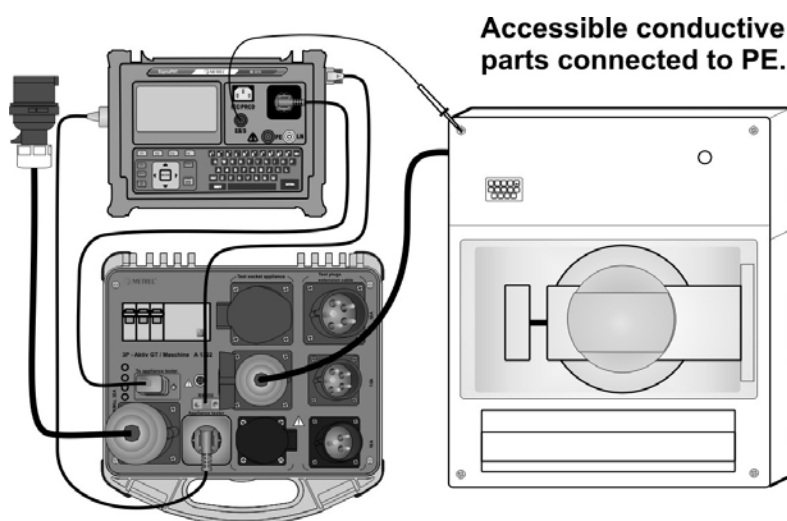

Figure 5.1: Earth bond resistance measurement

Note:

- Consider displayed warnings before starting measurement!

5.1.1 Compensation of test leads resistance

Test leads compensation enables to eliminate the influence of test leads resistance and instrument's internal resistance. If a compensation value is stored this is indicated in the message **C** on master instrument.

Compensation of test leads resistance procedure

Item	Comment
<ul style="list-style-type: none">Prepare test system.	See <i>chapter 4.3 Working with the adapter</i> .
<ul style="list-style-type: none">Connect test lead to EB/S (or S/C1) probe terminal on master instrument.	See <i>figure below</i> .
<ul style="list-style-type: none">Connect test lead from PAT EB/S probe (or Machine tester's S/C1 probe) to the PE pin of the test socket (32A 5p, 16A 5p or 16A 3p).	
<ul style="list-style-type: none">Select Earth bond function from Single test.	
<ul style="list-style-type: none">Select test current (200 mA or 10 A).	Regarding the type of cord.
<ul style="list-style-type: none">Press the CAL (F3) key for measurement.	
<ul style="list-style-type: none">If the calibration was performed successfully, 0.00 Ω is displayed.	
<ul style="list-style-type: none">Wait until measurement is finished.	
<ul style="list-style-type: none">Check result.	

Notes:

- 5 Ω is the limit value for resistance compensation. If the resistance is higher then the calibration value is reset to the default value and the message disappears.
- Both 10 A and 200 mA continuity functions are compensated at the same time.

5.2 Insulation resistance and substitute leakage current measurements

- 📖 Refer to chapter **Measurements – Single tests for appliances**, paragraph **Insulation resistance** in master instrument user manual for detailed information.
- 📖 Refer to chapter **Measurements – Single tests for appliances**, paragraph **Substitute leakage current** in master instrument user manual for detailed information.

Procedure:

Item

- Prepare test system.
- Connect power supply plug of tested appliance into proper test socket.
- Prepare and start measurement on the master instrument.
- Wait until measurement is finished or stop the measurement.
- Check result(s).
- Store result(s).

Comment

See *chapter 4.3 Working with the adapter.*
See *figure below.*

Optional

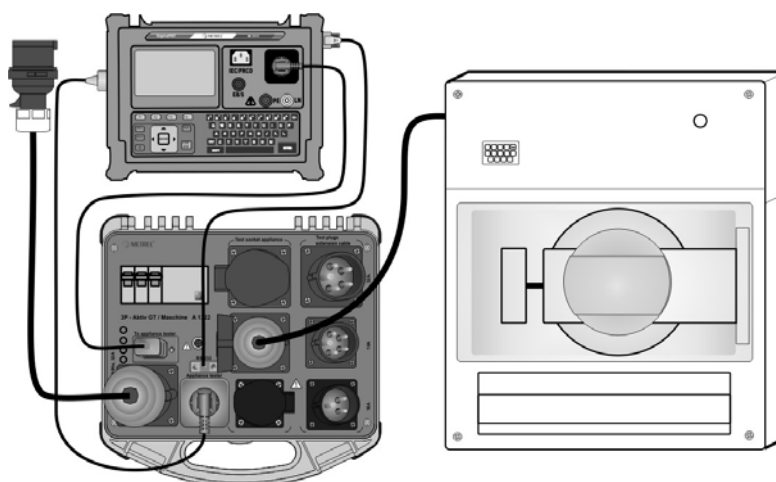

Figure 5.2: Insulation resistance and substitute leakage current measurements

Notes:

- Consider any warning on the display before starting the measurement!
- When EB/S (or S/C1) probe is connected during the test then the current through it is also considered.
- Do not touch or disconnect the DUT during the insulation resistance measurement or before it is fully discharged! The message »Discharging...« will be displayed while the voltage on the DUT is higher than 20 V!
- Substitute leakage current may differ substantially from that of conventional leakage current test because of the way the test is performed. For example, the difference in both leakage measurements will be affected by the presence of neutral to earth noise suppression capacitors.

5.3 Insulation resistance (S-probe) and substitute leakage current (S-probe) measurements

- 📖 Refer to chapter **Measurements – Single tests for appliances**, paragraph **Insulation resistance (S-probe)** in master instrument user manual for detailed information.
- 📖 Refer to chapter **Measurements – Single tests for appliances**, paragraph **Substitute leakage current (S-probe)** in master instrument user manual for detailed information.

Procedure:

Item

- › Prepare test system.
- › Connect power supply plug of tested appliance into proper test socket.
- › Connect probe to accessible isolated conductive part of the CLASS II appliance.
- › Prepare and start measurement on the master instrument.
- › Wait until measurement is finished or stop the measurement.
- › Check result(s).
- › Store result(s).

Comment

See *chapter 4.3 Working with the adapter.*
See *figure below.*

Optional

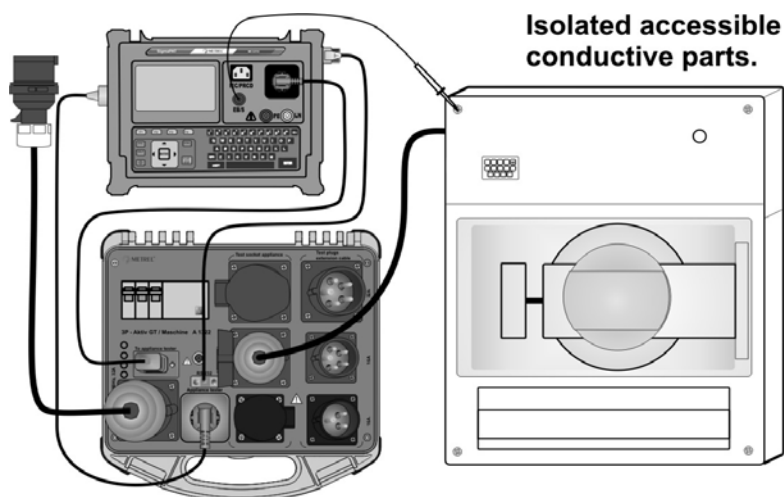

Figure 5.3: Insulation resistance (S-probe) and substitute leakage current (S-probe) measurements (on class II device or class II parts)

Notes:

- › Consider any displayed warning before starting measurement!
- › Do not touch / disconnect the DUT during the insulation resistance measurement or before it is fully discharged! The message »Discharging...« will be displayed while the voltage on the DUT is higher than 20 V!

5.4 Differential leakage current measurement

Refer to chapter **Measurements – Single tests for appliances**, paragraph **Differential leakage current** in master instrument user manual for detailed information.

Leakage current is measured via power supply cord of tested appliance.

Procedure:

Item	Comment
<ul style="list-style-type: none"> › Prepare test system. 	See chapter 4.3 Working with the adapter.
<ul style="list-style-type: none"> › Connect power supply plug of tested appliance into proper test socket. 	See figure below.
<ul style="list-style-type: none"> › Start measurement on the master instrument. 	
<ul style="list-style-type: none"> › Wait until measurement is finished or stop the measurement. 	
<ul style="list-style-type: none"> › Check result(s). 	
<ul style="list-style-type: none"> › Store result(s). 	Optional

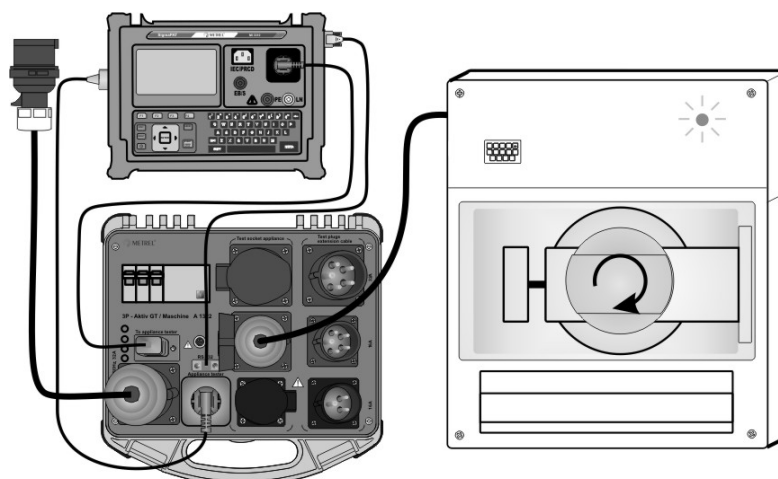

Figure 5.4: Differential leakage current measurement

Warning:

- › During the test, DUT is powered as for normal operation. Pay attention on possible electric shock, and danger of rotating/moving parts!

Note:

- › Consider any displayed warning before starting measurement!

5.6 Polarity / Active Polarity test

 Refer to chapter **Measurements – Single tests for appliances**, paragraph **Polarity test** in master instrument user manual for detailed information.

The Polarity test verifies integrity of extension cords, cable reels with distribution sockets and similar.

The standard (normal) polarity test is suitable for cords without built-in active protection. In case that tested item is equipped with active switch (RCD or similar) that requires voltage for normal operation, the active polarity test shall be applied.

Procedure:

Item

- › Prepare test system.
- › Connect EB/S (or S/C1) terminal on master instrument to the EB terminal on the adapter A 1322 / A 1422.
- › Connect tested power cord to proper test sockets.
- › Select test type [normal or active].
- › Start measurement on the master instrument.
- › If Active polarity, turn on switch on protected cord.
- › Wait until measurement is finished.
- › Check result(s).
- › Store result(s).

Comment

See *chapter 4.3 Working with the adapter*.

See *figures below*.

See *figures below*.

Regarding the type of cord.

To turn on the active switch.

Optional

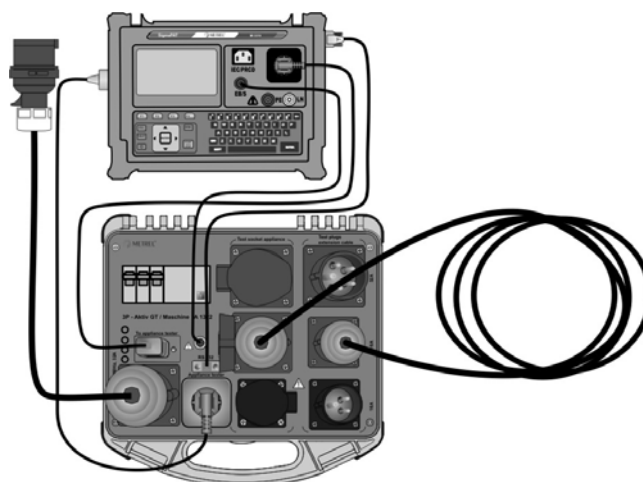

Figure 5.6: Normal polarity test

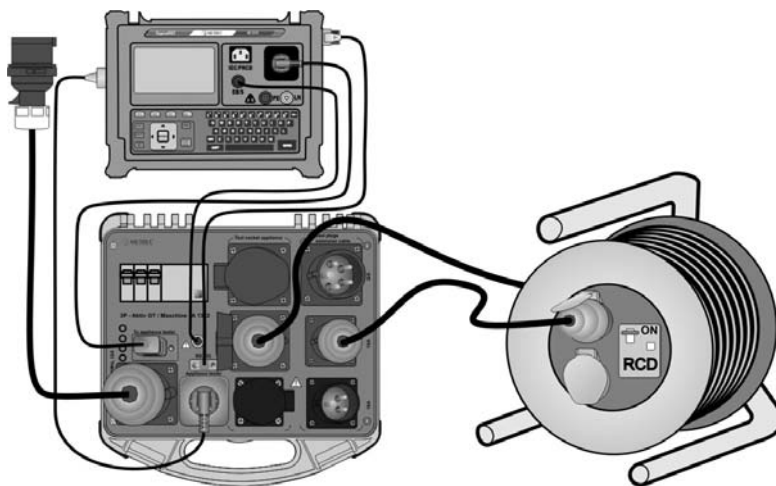

Figure 5.7: Active polarity test

Warning:

- Do not touch free male connectors during the (active) polarity test.

Note:

- Consider any displayed warning before starting measurement!

5.7 3-phase RCD test

Refer to chapter **Measurements – Single tests for appliances**, paragraph **RCD/PRCD test** in master instrument user manual for detailed information.

This test verifies that the PRCD protection works properly.

Procedure:

Item	Comment
<ul style="list-style-type: none"> ▸ Prepare test system. 	See <i>chapter 4.3 Working with the adapter</i> .
<ul style="list-style-type: none"> ▸ Connect the EB terminal on A 1322 / A 1422 and EB/S (or S/C1) terminal on master instrument. 	See <i>figure below</i> .
<ul style="list-style-type: none"> ▸ Connect tested PRCD to proper test sockets. 	See <i>figure below</i> .
<ul style="list-style-type: none"> ▸ Start measurement on the master instrument. ▸ Turn on PRCD. ▸ Wait until measurement is finished. ▸ Check result(s). ▸ Store result(s). 	Optional

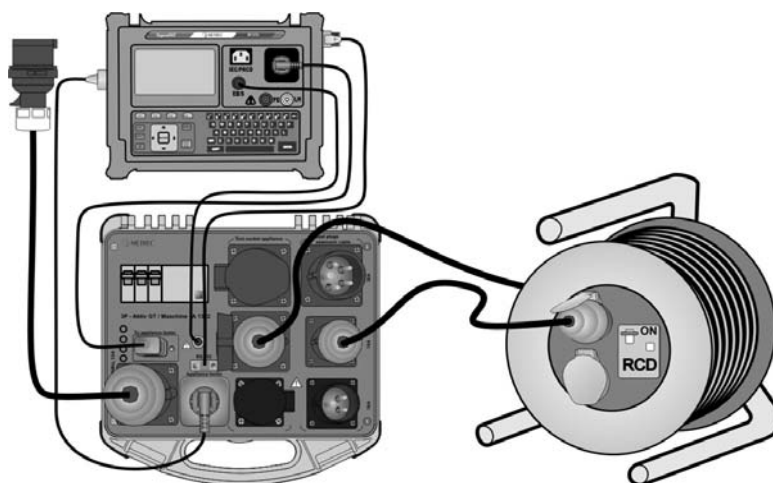

Figure 5.8: 3-phase RCD testing

Warning:

- Do not touch free male connectors during the test.

Note:

- Consider any displayed warning before starting measurement!

5.8 Functional test

 Refer to chapter **Measurements – Single tests for appliances**, paragraph **Functional test** in master instrument user manual for detailed information.

Functional test is intended for testing operation of the appliance and measurement of power consumption.

Procedure:

Item

- › Prepare test system.
- › Connect power supply plug of tested appliance into proper test socket.
- › Start measurement on the master instrument.
- › Wait until measurement is finished or stop the measurement.
- › Check result(s).
- › Store result(s).

Comment

See *chapter 4.3 Working with the adapter*.

See *figure below*.

Optional

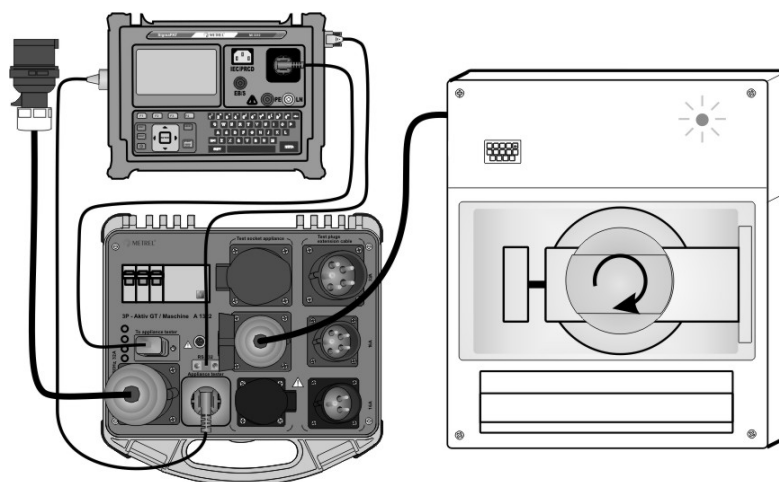

Figure 5.9: Functional test

Warning:

- › During the test, DUT is powered as for normal operation. Pay attention on possible electric shock, and danger of rotating/moving parts!

Note:

- › Consider any displayed warning before starting measurement!

6 Measurements according to IEC / EN 60974-4 (A 1422 only)

6.1 Continuity of the protective circuit

 Refer to chapter **Measurements – Single tests for welding machines**, paragraphs **Continuity of the protective circuit** in master instrument user manual for detailed information.

Procedure:

Item

- Prepare test system.
- Compensate test leads resistance (if necessary).
- Connect power supply plug of tested welding machine into proper test socket.
- Connect Earth Bond probe to the enclosure of the welding machine.
- Prepare and start measurement on the master instrument.
- Wait until measurement is finished or stop the measurement.
- Check result(s).
- Store result(s).

Comment

See chapter 4.3 *Working with the adapter*.
See chapter 5.1.1 *Compensation of test leads resistance*.
See figure below.

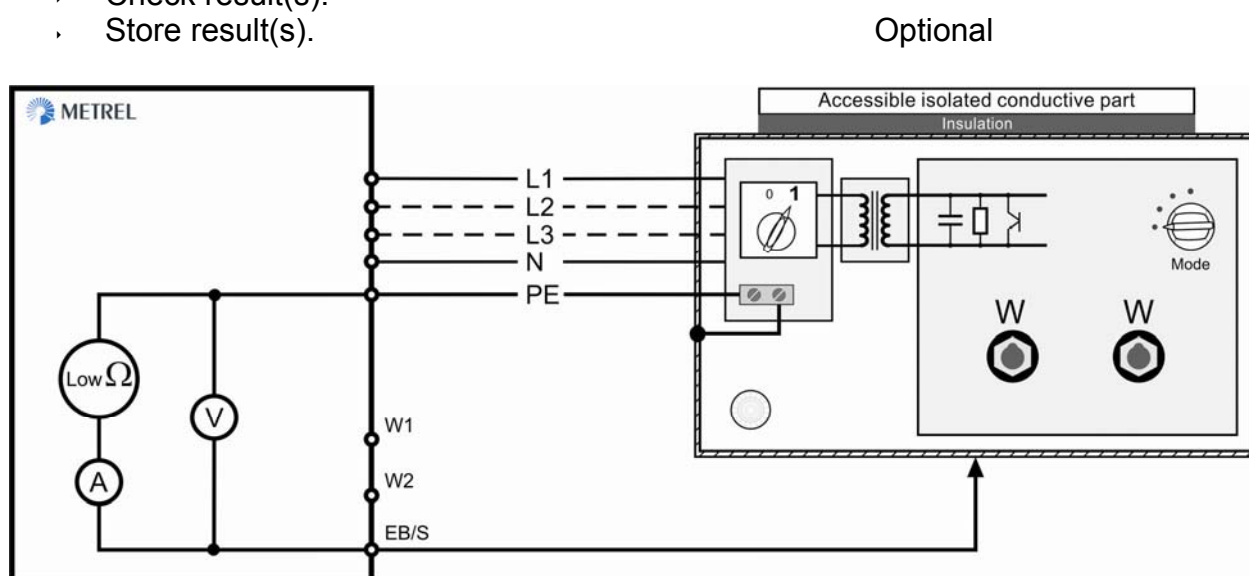

Figure 6.1: Continuity of the protective circuit measurement

Note:

- Consider displayed warnings before starting measurement!

6.1.1 Compensation of test leads resistance

Description in chapter 5.1.1 *Compensation of test leads resistance* can be used as reference.

6.2 Insulation resistance (supply circuit to protective circuit)

 Refer to chapter **Measurements – Single tests for welding machines**, paragraph **Insulation resistance (supply circuit to protective circuit)** in master instrument user manual for detailed information.

Procedure:

Item

- › Prepare test system.
- › Connect power supply plug of tested welding machine into proper test socket.
- › Prepare and start measurement on the master instrument.
- › Wait until measurement is finished or stop the measurement.
- › Check result(s).
- › Store result(s).

Comment

See chapter 4.3 Working with the adapter.
See figure below.

Optional

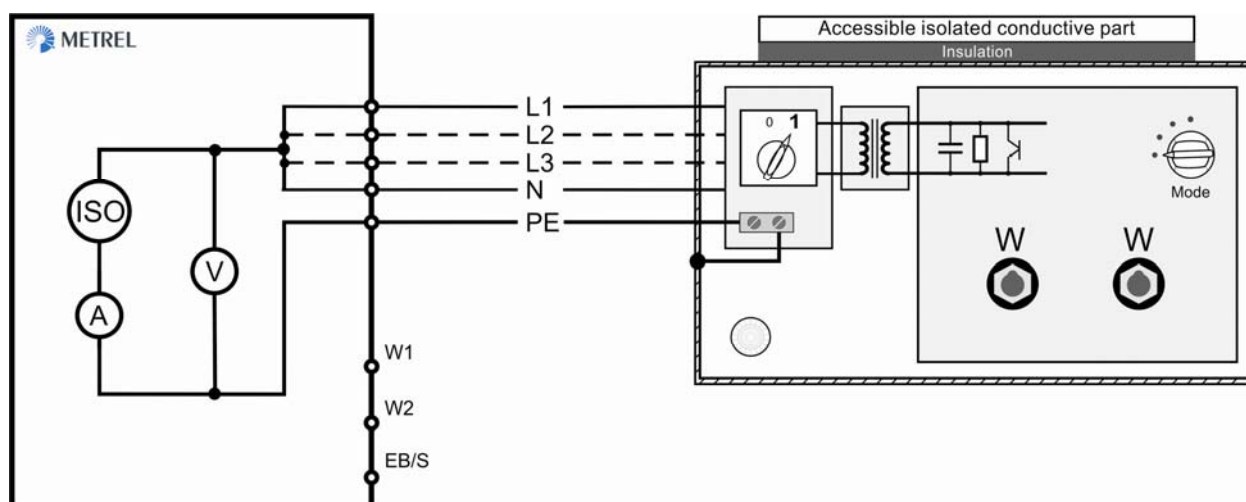

Figure 6.2: Insulation resistance (supply circuit to protective circuit) measurement

Notes:

- › Consider any warning on the display before starting the measurement!
- › Do not touch or disconnect the DUT during the insulation resistance measurement or before it is fully discharged! The message »Discharging...« will be displayed while the voltage on the DUT is higher than 20 V!

6.3 Insulation resistance (welding circuit to protective circuit)

Refer to chapter **Measurements – Single tests for welding machines**, paragraph **Insulation resistance (welding circuit to protective circuit)** in master instrument user manual for detailed information.

Procedure:

Item

- › Prepare test system.
- › Connect power supply plug of tested welding machine into proper test socket.
- › Connect welding terminals to W1 and W2 terminals on A 1422.
- › Prepare and start measurement on the master instrument.
- › Wait until measurement is finished or stop the measurement.
- › Check result(s).
- › Store result(s).

Comment

See chapter 4.3 Working with the adapter.
See figure below.

Optional

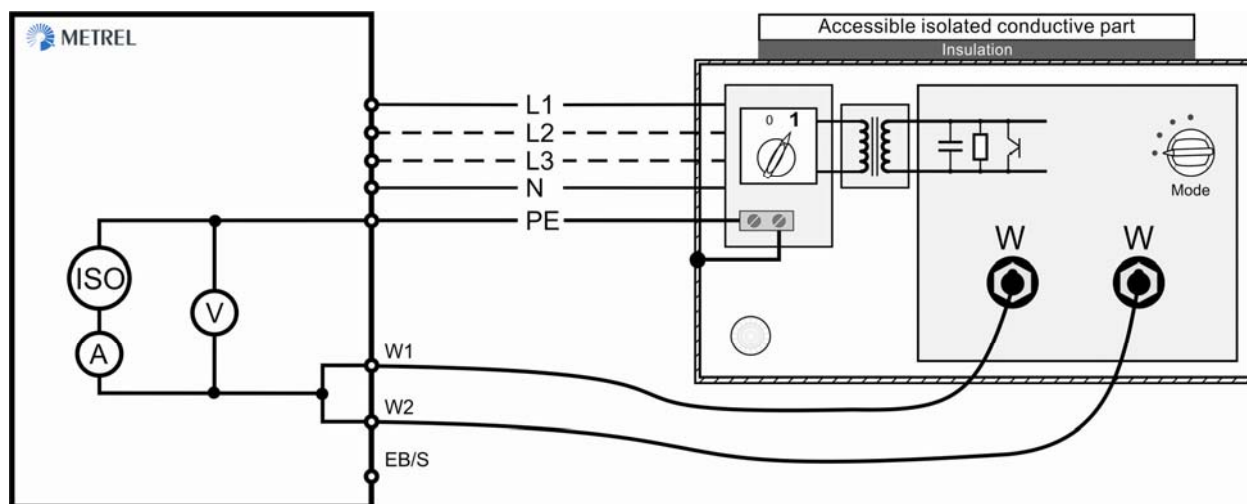

Figure 6.3: Insulation resistance (welding circuit to protective circuit) measurement

Notes:

- › Consider any warning on the display before starting the measurement!
- › Do not touch or disconnect the DUT during the insulation resistance measurement or before it is fully discharged! The message »Discharging...« will be displayed while the voltage on the DUT is higher than 20 V!

6.4 Insulation resistance (supply circuit to welding circuit)

Refer to chapter **Measurements – Single tests for welding machines**, paragraph **Insulation resistance (supply circuit to welding circuit)** in master instrument user manual for detailed information.

Procedure:

Item

- › Prepare test system.
- › Connect power supply plug of tested welding machine into proper test socket.
- › Connect welding terminals to W1 and W2 terminals on A 1422.
- › Prepare and start measurement on the master instrument.
- › Wait until measurement is finished or stop the measurement.
- › Check result(s).
- › Store result(s).

Comment

See chapter 4.3 Working with the adapter.
See figure below.

Optional

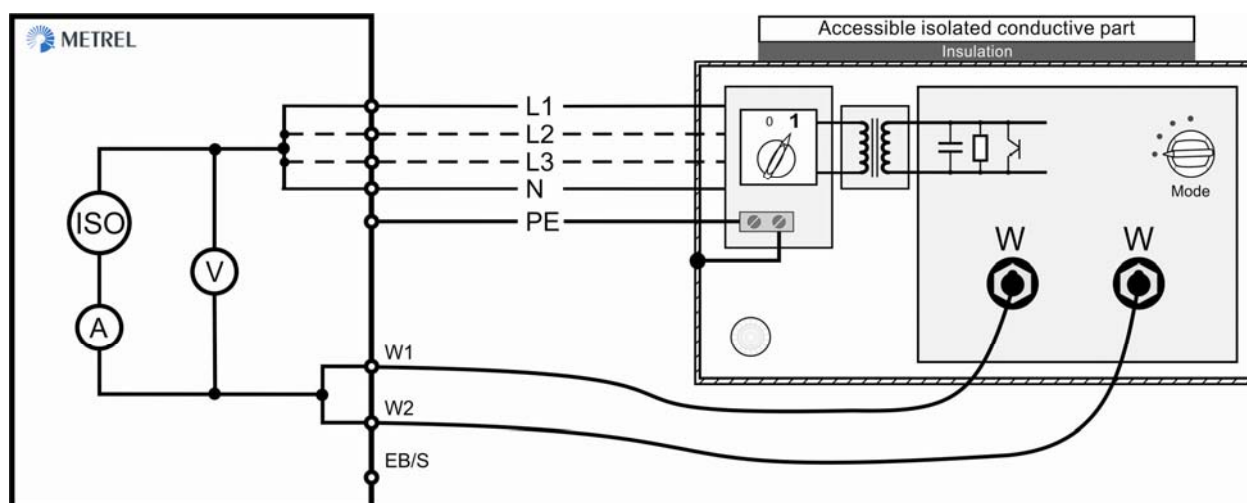

Figure 6.4: Insulation resistance (supply circuit to welding circuit) measurement

Notes:

- › Consider any warning on the display before starting the measurement!
- › Do not touch or disconnect the DUT during the insulation resistance measurement or before it is fully discharged! The message »Discharging...« will be displayed while the voltage on the DUT is higher than 20 V!

6.5 Insulation resistance (supply circuit of class II equipment to accessible surfaces)

Refer to chapter **Measurements – Single tests for welding machines**, paragraph **Insulation resistance (supply circuit of class II equipment to accessible surfaces)** in master instrument user manual for detailed information.

Procedure:

Item

- › Prepare test system.
- › Connect power supply plug of tested welding machine into proper test socket.
- › Connect probe to accessible isolated conductive part of the welding machine.
- › Prepare and start measurement on the master instrument.
- › Wait until measurement is finished or stop the measurement.
- › Check result(s).
- › Store result(s).

Comment

See chapter 4.3 Working with the adapter.
See figure below.

Optional

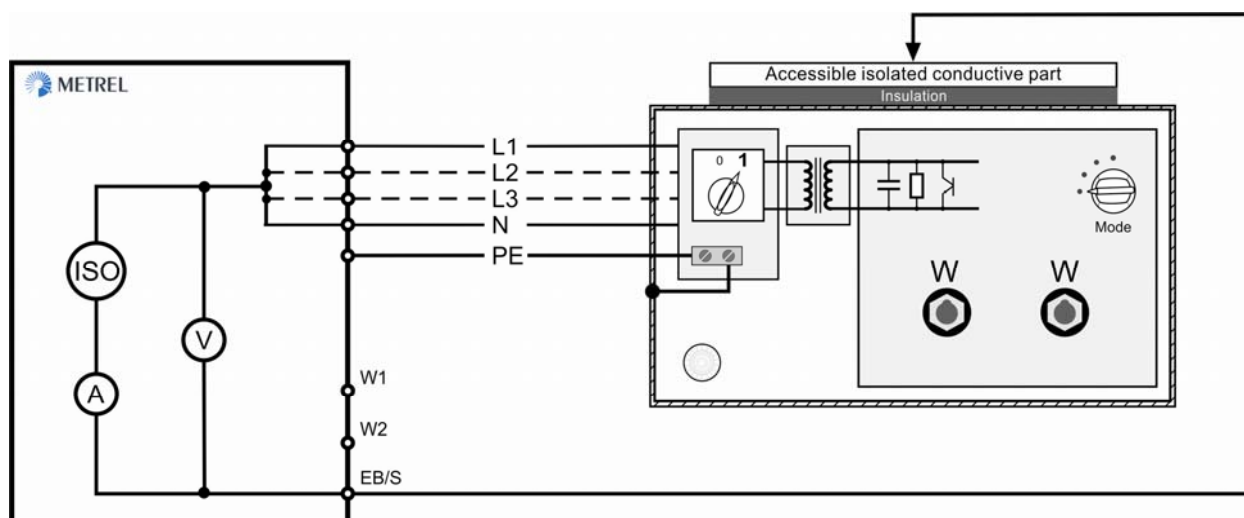

Figure 6.5: Insulation resistance (supply circuit of class II equipment to accessible surfaces)

Notes:

- › Consider any warning on the display before starting the measurement!
- › Do not touch or disconnect the DUT during the insulation resistance measurement or before it is fully discharged! The message »Discharging...« will be displayed while the voltage on the DUT is higher than 20 V!

6.6 Welding circuit leakage current

Refer to chapter **Measurements – Single tests for welding machines**, paragraph **Welding circuit leakage current** in master instrument user manual for detailed information.

Procedure:

Item

- › Prepare test system.
- › Connect power supply plug of tested welding machine into proper test socket.
- › Connect welding terminals to W1 and W2 terminals on A 1422.
- › Enable L-N change (for single-phase welding machines)
- › Start measurement on the master instrument.
- › Wait until measurement is finished or stop the measurement.
- › Check result(s).
- › Store result(s).

Comment

See chapter 4.3 *Working with the adapter*.
See figure below.

Optional

Optional

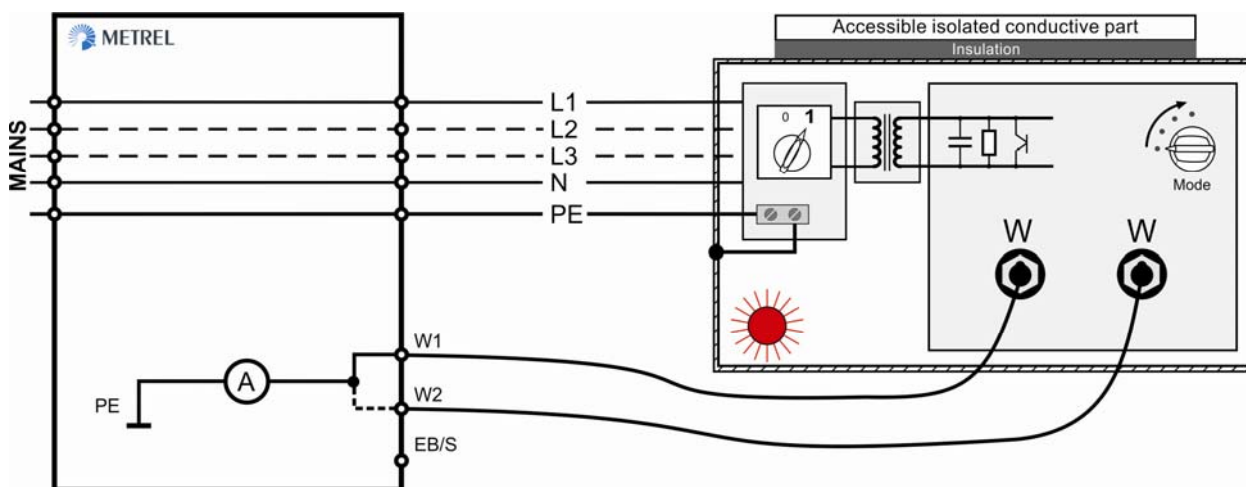

Figure 6.6: Welding circuit leakage current measurement

Warning:

- › During the test, DUT is powered as for normal operation. Pay attention on possible electric shock!

Note:

- › Consider any displayed warning before starting measurement!

6.7 Primary leakage current, functional test

 Refer to chapter **Measurements – Single tests for welding machines**, paragraph **Primary leakage current** in master instrument user manual for detailed information.

Procedure:

Item

- Prepare test system.
- Connect power supply plug of tested welding machine into proper test socket.
- Enable L-N change (for single-phase welding machines)
- Start measurement on the master instrument.
- Wait until measurement is finished or stop the measurement.
- Check result(s).
- Store result(s).

Comment

See chapter 4.3 Working with the adapter.
See figure below.

Optional

Optional

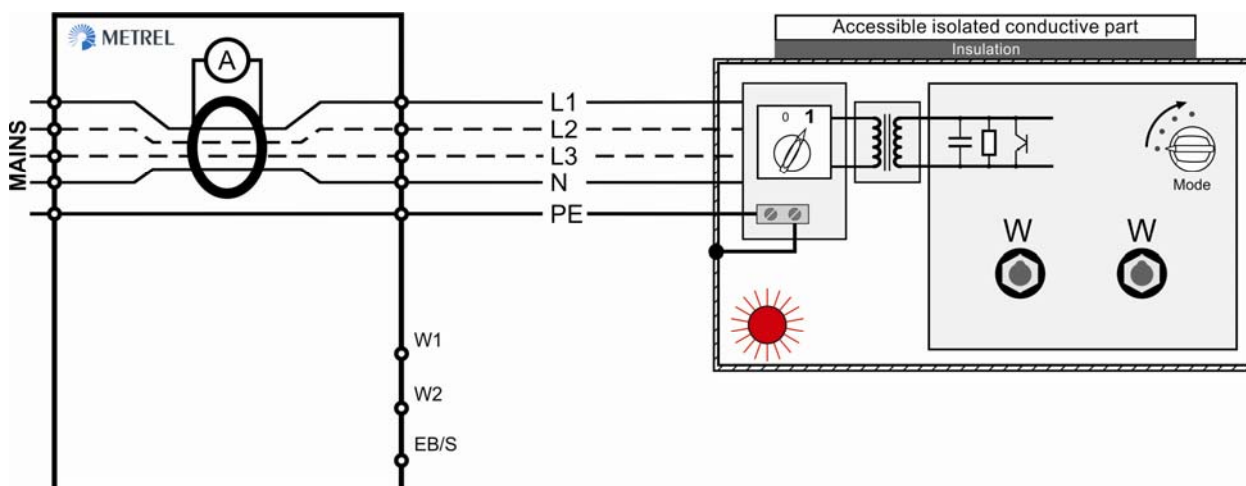

Figure 6.7: Primary leakage current measurement

Warning:

- During the test, DUT is powered as for normal operation. Pay attention on possible electric shock!

Note:

- Consider any displayed warning before starting measurement!

6.8 Touch leakage current

Refer to chapter **Measurements – Single tests for welding machines**, paragraph **Touch leakage current** in master instrument user manual for detailed information.

Procedure:

Item

- › Prepare test system.
- › Connect power supply plug of tested welding machine into proper test socket.
- › Connect probe to accessible isolated conductive part of the welding machine.
- › Enable L-N change (for single-phase welding machines)
- › Start measurement on the master instrument.
- › Wait until measurement is finished or stop the measurement.
- › Check result(s).
- › Store result(s).

Comment

See chapter 4.3 Working with the adapter.
See figure below.

Optional

Optional

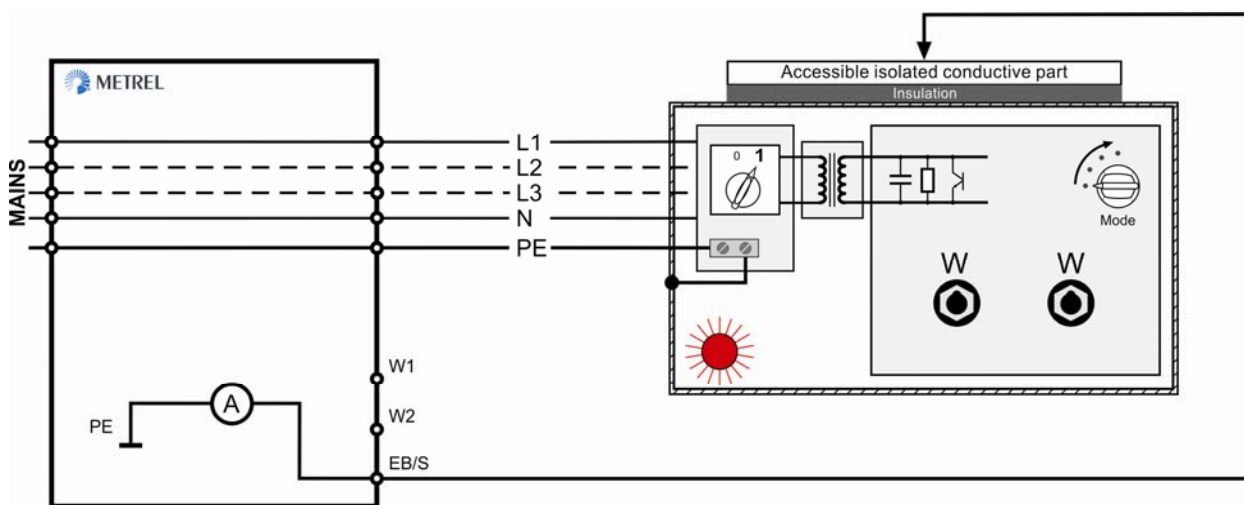

Figure 6.8: Touch leakage current measurement

Warning:

- › During the test, DUT is powered as for normal operation. Pay attention on possible electric shock!

Note:

- › Consider any displayed warning before starting measurement!

6.9 No load voltage

 Refer to chapter **Measurements – Single tests for welding machines**, paragraph **No load voltage** in master instrument user manual for detailed information.

Procedure:

Item

- › Prepare test system.
- › Connect power supply plug of tested welding machine into proper test socket.
- › Connect welding terminals to W1 and W2 terminals on A 1422.
- › Set type (AC or DC) and limits.
- › Start measurement on the master instrument.
- › Wait until measurement is finished.
- › Check result(s).
- › Store result(s).

Comment

See chapter 4.3 Working with the adapter.
See figure below.

Optional

Optional

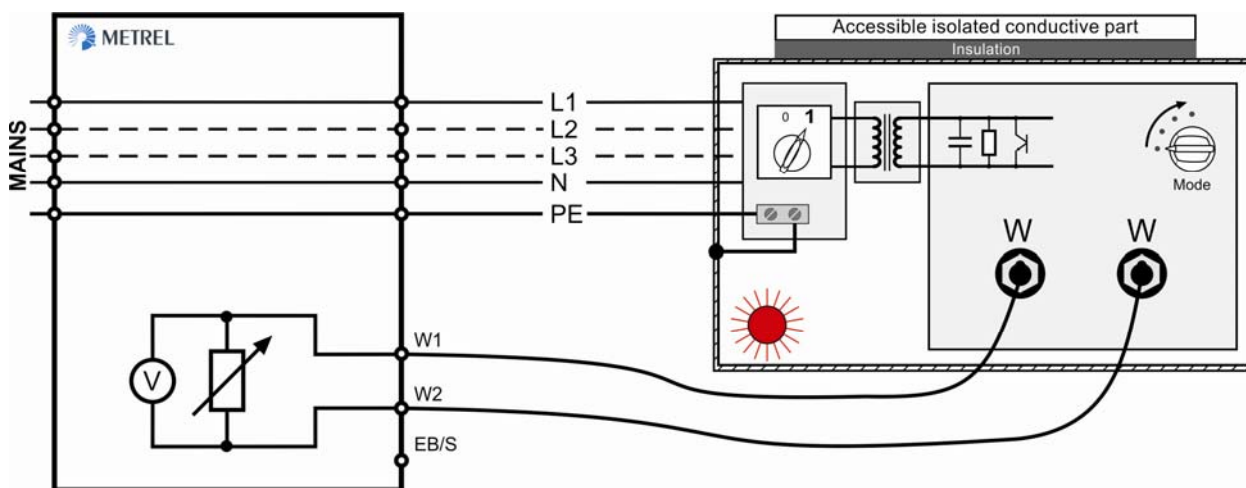

Figure 6.9: No load voltage measurement

Warning:

- › During the test, DUT is powered as for normal operation. Pay attention on possible electric shock!

Notes:

- › Consider any displayed warning before starting measurement!
- › The No load voltage should be checked in all operating modes of the welding machine.

7 Maintenance

Unauthorized person is not allowed to open the A 1322 / A 1422 3-phase adapter. There are no user replaceable components inside the adapter.

7.1 Cleaning

No special maintenance is required for the housing. To clean the surface of the 3-phase adapter use a soft cloth slightly moistened with soapy water or alcohol. Then leave the A 1322 / A 1422 to dry totally before use.

Warnings:

- › Do not use liquids based on petrol or hydrocarbons!
- › Do not spill cleaning liquid over the adapter!

7.2 Service

For repairs under warranty, or at any other time, please contact your distributor.

8 Technical specifications

8.1 Test functions

8.1.1 Earth bond resistance

 Refer to chapter **Technical specifications**, paragraph **Earth bond resistance** in master instrument user manual for detailed information.

8.1.2 Insulation resistance (including S-probe)

 Refer to chapter **Technical specifications**, paragraphs **Insulation resistance** and **Insulation resistance S-probe** in master instrument user manual for detailed information.

8.1.3 Substitute leakage current (including S-probe)

 Refer to chapter **Technical specifications**, paragraphs **Substitute leakage current** and **Substitute leakage current S-probe** in master instrument user manual for detailed information.

8.1.4 Differential leakage current

Differential leakage current readout

Range	Resolution	Accuracy
0.00 mA ÷ 9.99 mA	0.01 mA	±(5 % of reading + 5 digits)

Frequency response complies to EN61010 – Figure A1.

Pass levels* 0.25 mA, 0.50 mA, 0.75 mA, 1.00 mA, 1.50 mA, 2.25 mA,
2.50 mA, 3.50 mA, 4.00 mA, 4.50 mA, 5.00 mA, 5.50 mA,
6.00 mA, 7.00 mA, 8.00 mA, 9.00 mA

Test duration* 2 s, 3 s, 5 s, 10 s, 30 s, 60 s, 120 s, 180 s, none

Test terminals Test socket (A 1322 / A 1422: 16A-5p, 32A-5p or 16A-3p)

Additional error 0.01 mA / A

* Pass level and test duration are set on master instrument.

8.1.5 Touch leakage current

 Refer to chapter **Technical specifications**, paragraphs **Touch leakage current** in master instrument user manual for detailed information.

8.1.6 Polarity / active polarity

Standard test

Test voltage < 60 V (AC and DC)

Fault detections PASS, L1open / L1-PE shorted / L1-PE crossed, L2 open / L2-PE shorted / L2-PE crossed, L3 open / L3-PE shorted / L3-PE crossed, L1-N shorted, L2-N shorted, L3-N shorted, L1-N crossed, L2-N crossed, L3-N crossed, L1-L2 shorted, L1-L3 shorted, L2-L3 shorted, L1-L2 crossed, L1-L3 crossed, L2-L3 crossed, PE fault, N open, N-PE shorted, Multiple fault

Test terminals Test socket (A 1322 / A 1422: 16A-5p, 32A-5p or 16A-3p), test plug (A 1322 / A 1422: 16A-5p, 32A-5p or 16A-3p)

Active test

Test voltage Mains supply voltage, over-current protection

Fault detections PASS, L1open / L1-PE shorted / L1-PE crossed, L2 open / L2-PE shorted / L2-PE crossed, L3 open / L3-PE shorted / L3-PE crossed, L1-N shorted, L2-N shorted, L3-N shorted, L1-N crossed, L2-N crossed, L3-N crossed, L1-L2 shorted, L1-L3 shorted, L2-L3 shorted, L1-L2 crossed, L1-L3 crossed, L2-L3 crossed, PE fault, N open, N-PE shorted, Multiple fault

Test terminals Test socket (A 1322 / A 1422: 16A-5p, 32A-5p or 16A-3p), test plug (A 1322 / A 1422: 16A-5p, 32A-5p or 16A-3p)

8.1.7 3-phase portable RCD

Portable RCD trip-out time readout (AC and A type PRCD)

Range	Resolution	Accuracy
0 ms ÷ 300 ms ($\frac{1}{2} \times I_{\Delta N}$, $I_{\Delta N}$)	1 ms	±3 ms
0 ms ÷ 150 ms ($2 \times I_{\Delta N}$)	1 ms	
0 ms ÷ 40 ms ($5 \times I_{\Delta N}$)	1 ms	

Portable RCD trip-out current readout (B type portable RCD)

Range	Resolution	Accuracy
$0.2 \times I_{\Delta N}$ ÷ $2.2 \times I_{\Delta N}$	$0.05 \times I_{\Delta N}$	$\pm 0.1 \times I_{\Delta N}$

Test currents ($I_{\Delta N}$) 10 mA, 15 mA, 30 mA, 100 mA, 300 mA

Test current multipliers $\frac{1}{2} \times I_{\Delta N}$, $I_{\Delta N}$, $5 \times I_{\Delta N}$ (AC, A)

Test current shape sine-wave (AC), pulsed (A), smooth DC (B)

Start angle 0° (+), 180° (-), both (+, -)
 Test modes single, autotest
 Test terminals Test socket (A 1322 / A 1422: 16A-5p, 32A-5p or 16A-3p),
 test plug (A 1322 / A 1422: 16A-5p, 32A-5p or 16A-3p)
 Misc DC offset for pulsed (A) test current typical 6 mA

8.1.8 Functional test

Active power readout:

Range	Resolution	Accuracy
0.00 kW ÷ 24.00 kW	0.01 kW	±(5 % of reading + 5 digits)

Apparent power readout:

Range	Resolution	Accuracy
0.00 kVA ÷ 24.00 kVA	0.01 kVA	±(5 % of reading + 5 digits)

Reactive power readout:

Range	Resolution	Accuracy
0.00 kvar ÷ 24.00 kvar	0.01 kvar	±(5 % of reading + 5 digits)

Power factor readout:

Range	Resolution	Accuracy
0.00 ÷ 1.00	0.01	±(5 % of reading + 5 digits)

Test terminals Test socket (A 1322 / A 1422: 16A-5p, 32A-5p or 16A-3p)

8.1.9 Continuity of the protective circuit (acc. to IEC/ EN 60974-4)**Test current set to 10 A**

Range	Resolution	Accuracy
0.00 Ω ÷ 1.99 Ω	0.01 Ω	$\pm(5\%$ of reading + 3 digits)
2.00 Ω ÷ 19.99 Ω	0.01 Ω	$\pm 10\%$

Test current set to 200 mA

Range	Resolution	Accuracy
0.00 Ω ÷ 1.99 Ω	0.01 Ω	$\pm(5\%$ of reading + 3 digits)
2.00 Ω ÷ 9.99 Ω	0.01 Ω	$\pm 10\%$
10.0 Ω ÷ 19.9 Ω	0.1 Ω	$\pm 10\%$

Master instrument

powered by:battery* or mains for 200 mA test
mains for 10 A testTest currents:.....10 A ($\pm 5\%$) into 100 m Ω at mains voltage of 230 V
200 mA into 2.00 Ω

Open circuit voltage:.....<9 V AC

Test lead compensation...up to 5 Ω

Lead calibration:no

Pass levels [Ω]:.....0.10 ÷ 0.90, 1.00

Test duration [s]:.....2, 3, 5, 10, 30

Test method:.....2-wire measurement, floating to earth

Test terminals:EB/S (or S/C1) test probe terminal – test socket (A 1422:
16A-5p, 32A-5p or 16A-3p) (PE terminal)

* MI 3310 only

8.1.10 Insulation resistance (supply circuit to protective circuit) (acc. to IEC/ EN 60974-4)

Insulation LN-PE readout:

Range	Resolution	Accuracy
0.000 M Ω ÷ 0.500 M Ω	0.001 M Ω	$\pm(10\%$ of reading + 5 digits)
0.501 M Ω ÷ 1.999 M Ω	0.001 M Ω	$\pm(5\%$ of reading + 3 digits)
2.00 M Ω ÷ 19.99 M Ω	0.01 M Ω	
20.0 M Ω ÷ 199.9 M Ω	0.1 M Ω	

Nominal voltage:.....500 V DC (- 0 %, + 10 %)

Measuring current:.....min. 1 mA at 500 k Ω (500 V)

Short circuit current:.....max. 2.0 mA

Pass levels [M Ω]:.....2.50, 5.00, 10.00, none

Test duration [s]:.....2, 3, 5, 10, 30, 60, 120, 180, none

Test terminals:Test socket (A 1422: 16A-5p, 32A-5p or 16A-3p) (L1, L2, L3,
N terminals shorted) – test socket (A 1422: 16A-5p, 32A-5p or
16A-3p) (PE terminal)

8.1.11 Insulation resistance (welding circuit to protective circuit) (acc. to IEC/ EN 60974-4)

Insulation W-PE readout:

Range	Resolution	Accuracy
0.000 M Ω ÷ 0.500 M Ω	0.001 M Ω	\pm (10 % of reading + 5 digits)
0.501 M Ω ÷ 1.999 M Ω	0.001 M Ω	\pm (5 % of reading + 3 digits)
2.00 M Ω ÷ 19.99 M Ω	0.01 M Ω	
20.0 M Ω ÷ 199.9 M Ω	0.1 M Ω	

Nominal voltage:500 V DC (- 0 %, + 10 %)

Measuring current:min. 1 mA at 500 k Ω (500 V)

Short circuit current:max. 2.0 mA

Pass levels [M Ω]:2.50, 5.00, 10.00, none

Test duration [s]:2, 3, 5, 10, 30, 60, 120, 180, none

Test terminals:W1, W2 terminals shorted (A 1422) – test socket (A 1422:
16A-5p, 32A-5p or 16A-3p) (PE terminal)

8.1.12 Insulation resistance supply circuit to welding circuit (acc. to IEC/ EN 60974-4)

Insulation LN-W readout:

Range	Resolution	Accuracy
0.000 M Ω ÷ 0.500 M Ω	0.001 M Ω	\pm (10 % of reading + 5 digits)
0.501 M Ω ÷ 1.999 M Ω	0.001 M Ω	\pm (5 % of reading + 3 digits)
2.00 M Ω ÷ 19.99 M Ω	0.01 M Ω	
20.0 M Ω ÷ 199.9 M Ω	0.1 M Ω	

Nominal voltage:500 V DC (- 0 %, + 10 %)

Measuring current:min. 1 mA at 500 k Ω (500 V)

Short circuit current:max. 2.0 mA

Pass levels [M Ω]:5.00, 10.00, 20.00, none

Test duration [s]:2, 3, 5, 10, 30, 60, 120, 180, none

Test terminals:Test socket (A 1422: 16A-5p, 32A-5p or 16A-3p) (L1, L2, L3,
N terminals shorted) – (W1, W2 terminals on A 1422 shorted)

8.1.13 Insulation resistance (supply circuit of class II equipment to accessible surfaces) (acc. to IEC/ EN 60974-4)

Insulation LN-P readout:

Range	Resolution	Accuracy
0.000 M Ω ÷ 0.500 M Ω	0.001 M Ω	\pm (10 % of reading + 5 digits)
0.501 M Ω ÷ 1.999 M Ω	0.001 M Ω	\pm (5 % of reading + 3 digits)
2.00 M Ω ÷ 19.99 M Ω	0.01 M Ω	

Nominal voltage:.....500 V DC (- 0 %, + 10 %)
 Measuring current:.....min. 1 mA at 500 k Ω (500 V)
 Short circuit current:.....max. 2.0 mA
 Pass levels [M Ω]:.....5.00, 10.00, none
 Test duration [s]:.....2, 3, 5, 10, 30, 60, 120, 180, none
 Test terminals:Test socket (A 1422: 16A-5p, 32A-5p or 16A-3p) (L1, L2, L3, N terminals shorted) – EB/S (or S/C1) terminal on master instrument)

8.1.14 Welding circuit leakage current (acc. to IEC/ EN 60974-4)

Welding circuit leakage current readout:

Range	Resolution	Accuracy
0.00 mA ÷ 14.99 mA	0.01 mA	±(5 % of reading + 5 digits)

Frequency response complies to EN60974-4 – Figure 1.

Pass levels* 3.50 mA, 5.00 mA, 10.0 mA, none
 Test duration* 2 s, 3 s, 5 s, 10 s, 30 s, 60 s, 120 s, 180 s, none
 Test terminals Test socket (A 1422: 16A-5p, 32A-5p or 16A-3p) – (W1 and W2 terminals on A 1422)

* Pass level and test duration are set on master instrument.

8.1.15 Primary leakage current (acc. to IEC/ EN 60974-4)

Primary leakage current readout:

Range	Resolution	Accuracy
0.00 mA ÷ 14.99 mA	0.01 mA	±(5 % of reading + 5 digits)

Frequency response complies to EN60974 – Figure 2.

Pass levels* 3.50 mA, 5.00 mA, 10 mA, none
 Test duration 2 s, 3 s, 5 s, 10 s, 30 s, 60 s, 120 s, 180 s, none
 Test terminals Test socket (A 1422: 16A-5p, 32A-5p or 16A-3p)
 Additional error 0.01 mA / A

* Pass level and test duration are set on master instrument.

8.1.16 Touch leakage current

 Refer to chapter **Technical specifications**, paragraphs **Touch leakage current** in master instrument user manual for detailed information.

8.1.17 No load voltage (acc. to IEC/ EN 60974-4)

No load voltage readout: (a.c. peak or d.c. peak)

Range	Resolution	Accuracy
0.0 V ÷ 199.9 V	0.1 V	±(5 % of reading + 5 digits)

No load voltage readout: (a.c. r.m.s.)

Range	Resolution	Accuracy
0.0 V ÷ 139.9 V	0.1 V	±(5 % of reading + 5 digits)

Measurement circuit according to EN60974 – Figure 4.

Pass levels* d.c. 113 V peak / a.c. 68 V peak and 48 V r.m.s.,
 d.c. 113 V peak / a.c. 113 V peak and 80 V r.m.s.,
 d.c. 141 V peak / a.c. 141 V peak and 100 V r.m.s.,
 none.

Test terminals Test socket (A 1422: 16A-5p, 32A-5p or 16A-3p) and
 terminals W1 / W2

* Pass levels are set on master instrument.

8.2 General data

Supply voltage single-phase	230 V \pm 10 %
Supply voltage 3-phase	230/400 V \pm 10 %
	120/208 V \pm 10 %
Maximum test current	32 A, 40 A max (10 min)

Overvoltage category	300 V CAT II
Protection classification	I
Pollution degree	2
Protection degree	IP 20 (connectors)
Protection degree	IP 66 (closed and locked cover)
Case	Shock proof plastic, portable
Dimensions (w \times h \times l)	335 mm \times 160 mm \times 335 mm
Weight	7.2 kg

Reference conditions

Reference temperature range	15 °C \div 35 °C
Reference humidity range	35 %RH \div 65 %RH

Operation conditions

Working temperature range	0 °C \div 40 °C
Maximum relative humidity	85 %RH (0 °C \div 40 °C), non-condensing

Storage conditions

Temperature range	-10 °C \div +60 °C
Maximum relative humidity	90 %RH (-10 °C \div +40 °C)
	80 %RH (40 °C \div 60 °C)

