

33% Pawnee 80cc ARF

Assembly Manual



HANGAR 9[®]

Notice

All instructions, warranties and other collateral documents are subject to change at the sole discretion of Horizon Hobby, Inc. For up-to-date product literature, visit <http://www.horizonhobby.com> and click on the support tab for this product.

Meaning of Special Language

The following terms are used throughout the product literature to indicate various levels of potential harm when operating this product:

NOTICE: Procedures, which if not properly followed, create a possibility of physical property damage AND little or no possibility of injury.

CAUTION: Procedures, which if not properly followed, create the probability of physical property damage AND a possibility of serious injury.

WARNING: Procedures, which if not properly followed, create the probability of property damage, collateral damage, and serious injury OR create a high probability of superficial injury.



WARNING: Read the ENTIRE instruction manual to become familiar with the features of the product before operating. Failure to operate the product correctly can result in damage to the product, personal property and cause serious injury.

This is a sophisticated hobby product and NOT a toy. It must be operated with caution and common sense and requires some basic mechanical ability. Failure to operate this Product in a safe and responsible manner could result in injury or damage to the product or other property. This product is not intended for use by children without direct adult supervision. Do not attempt disassembly, use with incompatible components or augment product in any way without the approval of Horizon Hobby, Inc. This manual contains instructions for safety, operation and maintenance. It is essential to read and follow all the instructions and warnings in the manual, prior to assembly, setup or use, in order to operate correctly and avoid damage or serious injury.

Table of Contents

Notice.....	2
Meaning of Special Language	2
Introduction	2
Product Support	2
Specifications.....	2
Contents of Kit and Parts Listing	3
Safety Precautions and Warnings	3
Important Information Regarding Warranty.....	4
Using the Manual.....	4
UltraCote Covering Colors	4
Recommended Engine	4
Transmitter Requirements.....	4
Radio Equipment Requirements	4
Required Tools.....	4
Required Adhesives	4
Field Equipment Required	4
Optional Field Equipment	5
Before Starting Assembly	5
Binding the Radio System	5
Aileron and Flap Servo Installation	5
Wing Strut Installation	10
Rudder and Elevator Servo Installation.....	12
Landing Gear Installation	15
Stabilizer Installation.....	17
Elevator Linkage Installation	19
Tail Wheel Installation	20
Tail Strut Installation	20
Rudder Preparation.....	21
Rudder Installation.....	23
Engine and Cowling Installation.....	24
Receiver and Switch Harness Installation	27
Wing Installation	28
Center of Gravity	30
Control Throws	30
Preflight	31
Range Test Your Radio	31
Safety Do's and Don'ts for Pilots	32
Daily Flight Checks.....	32
Flying the Hangar 9 33% Pawnee 80cc ARF	32
Limited Warranty	33
Warranty Services.....	33
Compliance Information for the European Union.....	34
Academy of Model Aeronautics National Model Aircraft Safety Code	35

Introduction

Congratulations on the purchase of your new Hangar 9 33% Pawnee 80cc. As of right now, all that stands between you and your first flight is a weekend's worth of final assembly. This aircraft builds fast and easy with no complicated building techniques required.

We sincerely hope you have as much fun with the Pawnee as we did testing it. If you get a chance, let us know how your experience was by visiting Hangar-9.com and clicking on the "Contact Us" section. We look forward to hearing from you.

Happy flying,
The Hangar 9 Team

Product Support

For technical assistance with this product, please contact the appropriate Horizon Product Support office. See warranty for more information.

Specifications

Wingspan	130.0 in (3.30m)
Length	94.0 in (2.40m)
Wing Area	2616 sq in (168.7 sq dm)
Weight	34–38 lb (15.5–17.25 kg)
Radio	6-channel (or greater) with 8 servos
Engine	2-stroke gas, 60cc–100cc
Spinner size:	3 ³ / ₄ -inch (95mm)

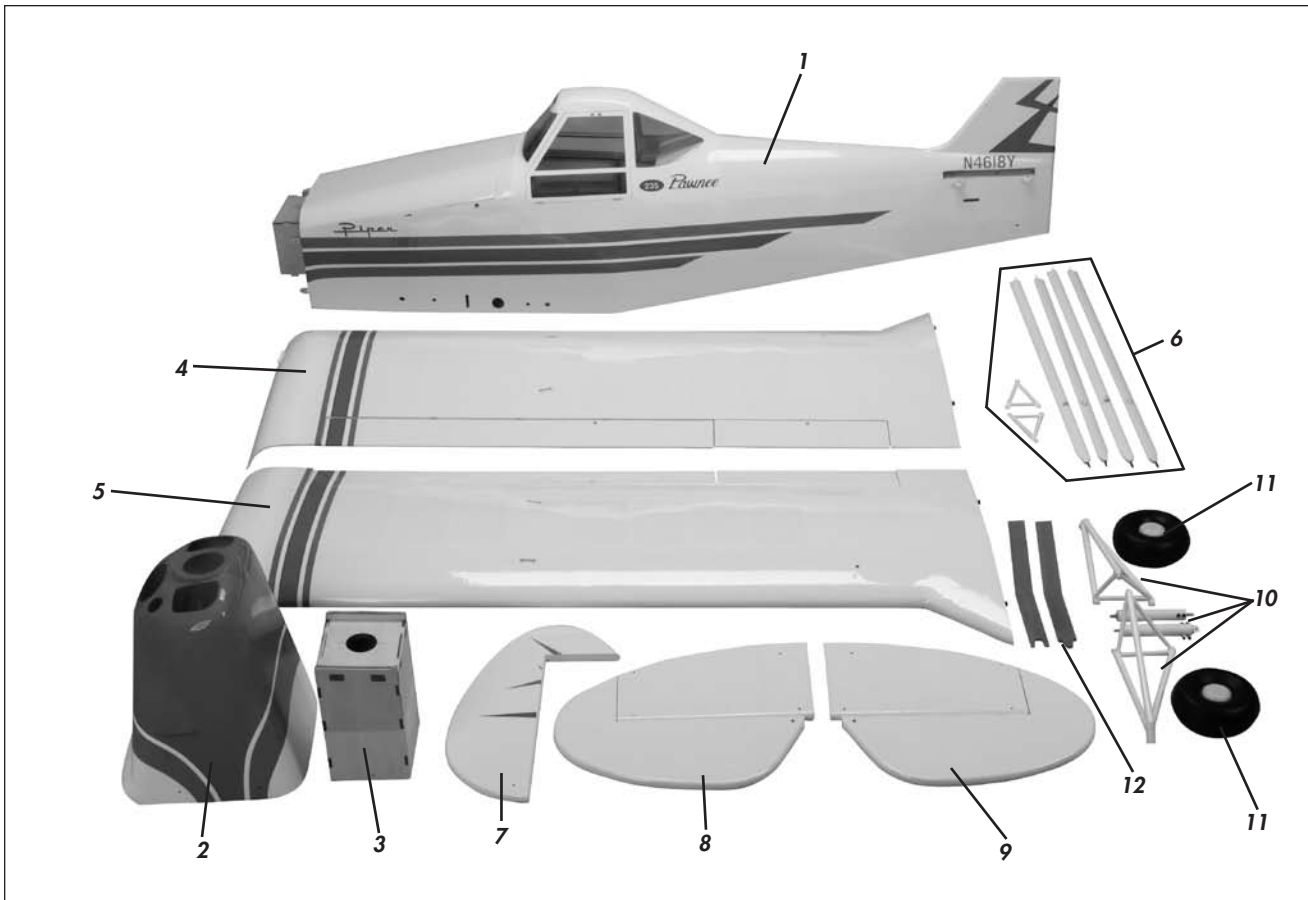

Contents of Kit and Parts Listing

Replacement items

- | | | |
|-----|-----------|--------------------------------|
| 1. | HAN519001 | Fuselage with Hatch |
| 2. | HAN519002 | Cowling |
| 3. | HAN519003 | Motor Box with Template |
| 4. | HAN519004 | Left Wing |
| 5. | HAN519005 | Right Wing |
| 6. | HAN519006 | Strut Set |
| 7. | HAN519007 | Rudder |
| 8. | HAN519008 | Left Stabilizer with Elevator |
| 9. | HAN519009 | Right Stabilizer with Elevator |
| 10. | HAN519010 | Landing Gear and Shocks |
| 11. | HAN519012 | Wheel Set |
| 12. | HAN519013 | Wing Spar |

Items not shown

- | | |
|-----------|-----------------------|
| HAN519011 | Tail Wheel Assembly |
| HAN519014 | Main Hardware Package |
| HAN519015 | ABS Fairings |

Safety Precautions and Warnings

Read and follow all instructions and safety precautions before use. Improper use can result in fire, serious injury and damage to property.

COMPONENTS

Use only with compatible components. Should any compatibility questions exist, please refer to the product instructions, the component instructions or contact Horizon Hobby, Inc.

FLIGHT

Fly only in open areas to ensure safety. It is recommended flying be done at AMA (Academy of Model Aeronautics) approved flying sites. Consult local ordinances before choosing a flying location.

PROPELLER

Keep loose items that can get entangled in the propeller away from the prop, including loose clothing, or other objects such as pencils and screwdrivers. Especially keep your hands away from the propeller as injury can occur.

BATTERIES

Notes on Lithium Polymer Batteries

When used improperly, lithium polymer batteries are significantly more volatile than alkaline or Ni-Cd/Ni-MH batteries used in RC applications. Always follow the manufacturer's instructions when using and disposing of any batteries. Mishandling of Li-Po batteries can result in fire, causing serious injury and damage.

SMALL PARTS

This kit includes small parts and should not be left unattended near children as choking and serious injury could result.

Age Recommendation: Not for children under 14 years. This is not a toy.

Safe Operating Recommendations

- Inspect your model before every flight to make certain it is airworthy.
- Be aware of any other radio frequency user who may present an interference problem.
- Always be courteous and respectful of other users of your selected flight area.
- Choose an area clear of obstacles and large enough to safely accommodate your flying activity.
- Make certain this area is clear of friends and spectators prior to launching your aircraft.
- Be aware of other activities in the vicinity of your flight path that could cause potential conflict.
- Carefully plan your flight path prior to launch.
- Abide by any and all established AMA National Model Aircraft Safety Codes.

Important Information Regarding Warranty

Please read our Warranty and Liability Limitations section on page 59 before building this product. If you as the purchaser or user are not prepared to accept the liability associated with the use of this Product, you are advised to return this Product immediately in new and unused condition to the place of purchase.

Using the Manual

This manual is divided into sections to help make assembly easier to understand, and to provide breaks between each major section. In addition, check boxes have been placed next to each step to keep track of the steps completed. Steps with a single box (☐) are performed once, while steps with two boxes (☐☐) indicate the step will require repeating, such as for a right or left wing panel, two servos, etc. Remember to take your time and follow the directions.

UltraCote® Covering Colors

White	HANU870
True Red	HANU866
Sky Blue	HANU875

Recommended Engine

Zenoah® GT80 Twin Cylinder	ZENE80T
24" Diameter Gas-Series Prop, A-Pitch	VSS2401
Spinner	TRUTT-3752-B-M-DA100

Transmitter Requirements

This model requires a minimum of a 5-channel radio to operate all the functions of your aircraft. We suggest the following radio systems available through Horizon Hobby or your local hobby distributor.

JR 9503	JRP2930X
JR 11X	JRP1100X
Spektrum™ DX8	SPM8800
Spektrum DX10t	SPM2800US
JR® DSM2™ or DSMX™ Systems	

Radio Equipment Requirements

The following items are recommended when installing the 9-Channel AR9100 receiver (SPMAR9100) in your aircraft:

AR9000 DSM2 9-Channel Receiver	SPMAR9010
3-inch (152mm) Servo Extension (2)	JRPA093
12-inch (305mm) Servo Extension (4)	JRPA098
18-inch (457mm) Servo Extension (3)	JRPA099
24-inch (610mm) Servo Extension	JRPA102
36-inch (915mm) Servo Extension (3)	JRPA103
6.0V Receiver Battery, 2700mAh	JRPB5008
Aluminum Servo Arm, 3-inch (152mm)	JRPA237
Aluminum Servo Arm, 1½-inch (38mm) (7)	HAN9154
A6020 Digital Aircraft Servo, High-Torque (8)	SPMSA6020

Required Tools

Crimping tool	Drill
Epoxy brush	Felt-tipped pen
Flat blade screwdriver	Fuel tubing
Hobby knife with #11 blade	Isopropyl alcohol
Light machine oil	Linkage wrench (optional)
Low-tack tape	Medium grit sandpaper
Mixing cup	Mixing stick
Nut driver: 1/4-inch	Paper towel
Pencil	Petroleum jelly
Phillips screwdriver: #1	Pin vise
Pliers	Scissors
Side cutter	Ruler
String or dental floss	Toothpicks
Drill bit: 1/16-inch (1.5mm), 5/64-inch (2mm), 5/16-inch (8mm)	
Hex wrench: 1.5mm, 5/64-inch, 3/32-inch, 1/8-inch, 3/16-inch	
Open-end wrench: 3/16-inch, 7mm, 1/4-inch, 11/32-inch	

Required Adhesives

Formula 560 Canopy Glue	(PAAPT56)
30-Minute Epoxy, 8 oz	(PAAPT39)
Thin CA	(PAAPT08)
Threadlock	(PAAPT42)

Field Equipment Required

Ultra Fuel Pump Glow/Gas	HAN155
G62/38/45/445 Spark Plug	ZEN6242
Evolution® 2-cycle oil	EVOX1001Q
Pilot Figure	HAN8265

Optional Field Equipment

Self-stick weights, 6 oz (HAN3626)
Cleaner and towels
Pro-Link Wrench (HAN3558)

Before Starting Assembly

Before beginning the assembly of your model, remove each part from its bag for inspection. Closely inspect the fuselage, wing panels, rudder and stabilizer for damage. If you find any damaged or missing parts, contact the place of purchase.

If you find any wrinkles in the covering, use a heat gun (HAN100) and covering glove (HAN150) or covering iron (HAN101) with a sealing iron sock (HAN141) to remove them. Use caution while working around areas where the colors overlap to prevent separating the colors.

Binding the Radio System

Before starting the assembly of your model, we recommend preparing your radio system for installation. This includes charging the transmitter and receiver batteries, as well as centering the trims and sticks on your transmitter. If using a computer radio, make sure to reset a model memory and name it for this particular model. We also recommend binding the transmitter and receiver at this time following the instructions provided with your radio system.

Note: We highly recommend re-binding the radio system once all the control throws are set. This will keep the servos from moving to their endpoints until the transmitter and receiver connect.

Aileron and Flap Servo Installation

Required Parts

Wing panel (right and left)	Ball end with hardware (4)
Control horn, long (2)	Control horn, short (2)
8-32 flanged nut (4)	Servo with hardware (4)
Receiver	Receiver battery
Transmitter	
Aluminum servo arm, 1½-inch (38mm) (4)	
18-inch (457mm) servo extension (2)	
3-inch (152mm) servo extension (2)	
Servo hardware (4)	
4-40 x 2-inch adjustable link (2)	
4-40 x 3-inch adjustable link (2)	
2mm x 10mm wood screw (16)	
8-32 x 2¼-inch countersunk machine screw (4)	
¾ x 3/8 x 9/16 (19mm x 9.5mm x 14mm) hardwood block (8)	

Required Tools and Adhesives

30-minute epoxy	Mixing stick
Ruler	Pencil
Medium grit sandpaper	Drill
Drill bit: 5/64-inch (2mm)	Phillips screwdriver: #1
Thin CA	String or dental floss
Nut driver: 1/4-inch	Flat blade screwdriver
Threadlock	Open-end wrench: 11/32-inch
Canopy glue	Linkage wrench (optional)
Isopropyl alcohol	Paper towels
Hex wrench: 3/32-inch, 2.5mm	

Note: Before beginning this section of the manual, set the throws for the flap servo at the transmitter to 0% in both the up and down positions. This will center the flap servo, allowing you to properly install the servo arm and linkage.

□ 1. Locate the items necessary to install the aileron and flap servos and linkages. You will also need the left and right wing panels for this section of the manual.

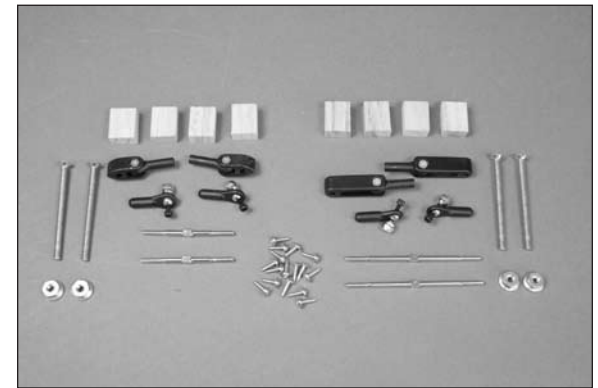

□□ 2. Check the hinges in each wing panel to make sure there is no excess adhesive that might prevent them from moving. Use a hobby knife and a #11 blade to remove any excess adhesive if any is found.

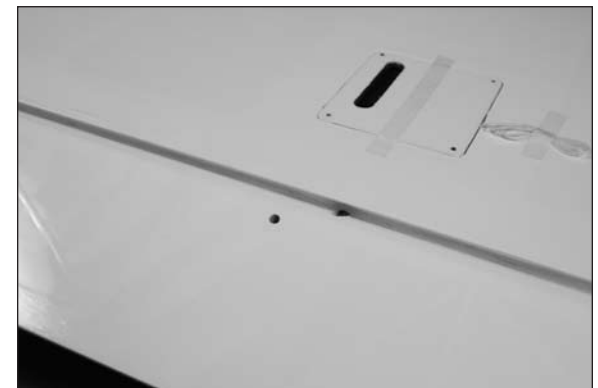

□□□□ 3. Remove the aileron servo cover from the wing. Remove the cover for the flap servo at this time as well. Make sure to mark the covers so they can be placed back into the wing in the correct locations.

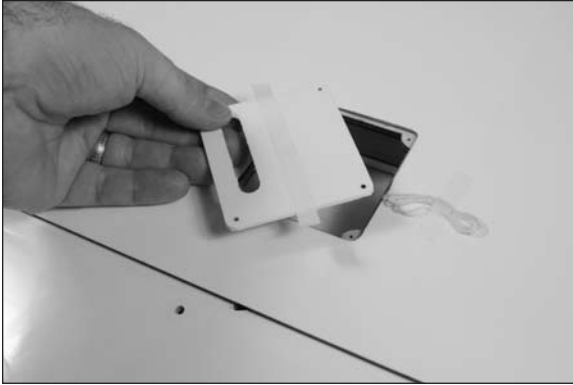

Hint. You can also use a JR Match maker (JRPA915) to center the servos before installation.

□□□□ 4. Attach the servo arm to the servo after centering the servo using the radio system. Make sure the arm is perpendicular to the servo centerline. Also install the grommets and brass eyelets in the servo.

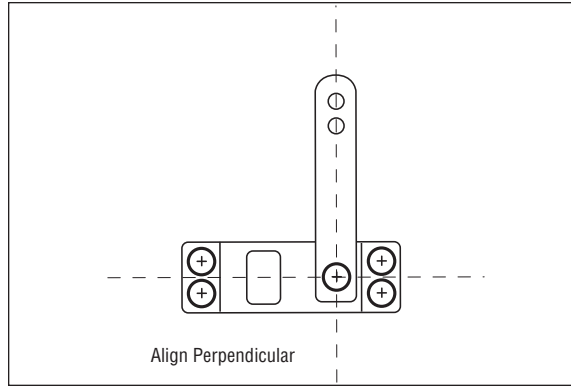
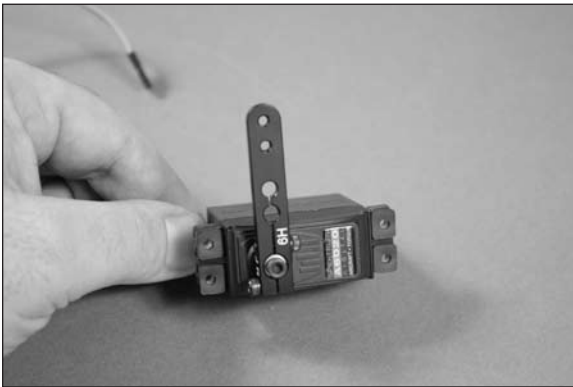

□□□□ 5. Prepare both the right and left aileron servos at this time. Note the position of the servo horn on the servos shown.

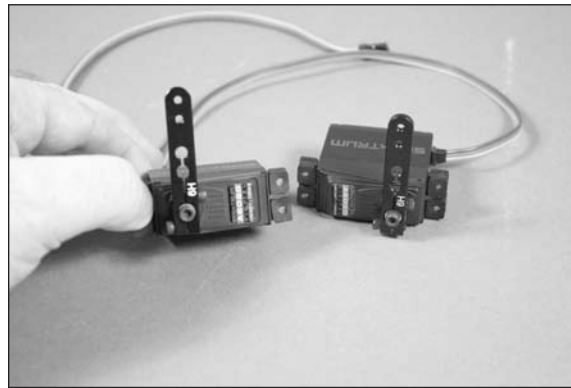

□□□□ 6. Place the servo on the cover, centering the servo arm in the opening. Use a pencil to mark the location of the servo mounting tabs.



□□□□ 7. Use medium grit sandpaper to scuff the end of the servo mounting block to provide a better surface for the adhesive.

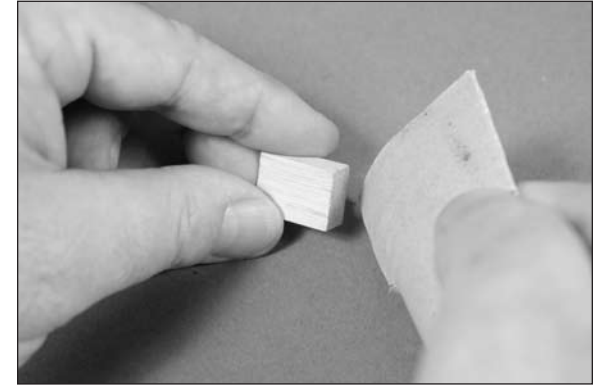

□□□□ 8. Use 30-minute epoxy to glue the two servo mounting blocks to the servo cover. Allow the epoxy to fully cure before proceeding.

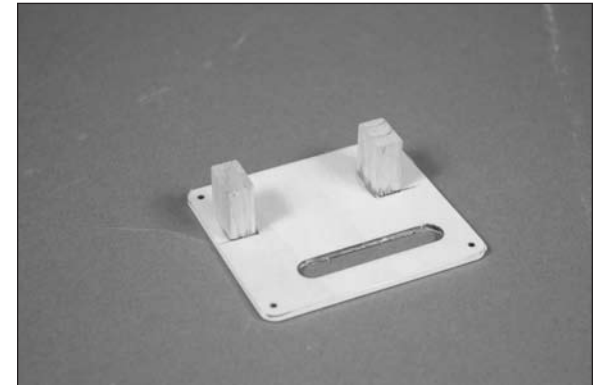

□□□□ 9. Place the servo between the blocks. Position the servo so there is a 1/32-inch (.5mm) gap between the servo and cover. Use a pencil to mark the location for the servo mounting screws on the servo mounting blocks.

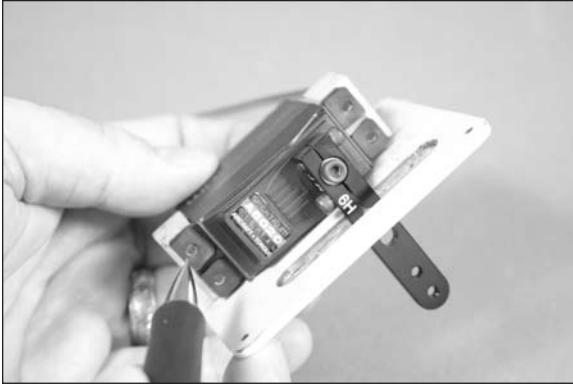

□□□□ 10. Use a 5/64-inch (2mm) drill bit to drill the four holes for the servo mounting screws.

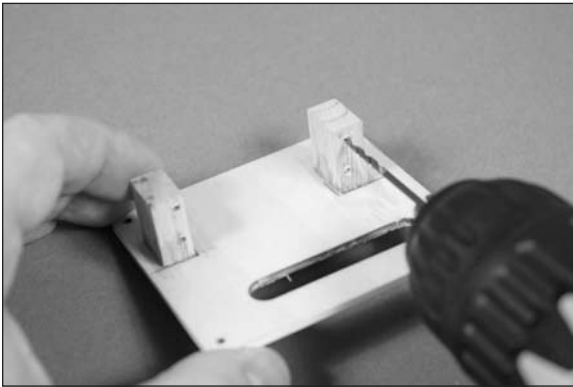

□□□□ 11. Use a #1 Phillips screwdriver to thread a servo mounting screw into each of the holes to cut threads in the surrounding wood. Remove the screw before proceeding to the next step.

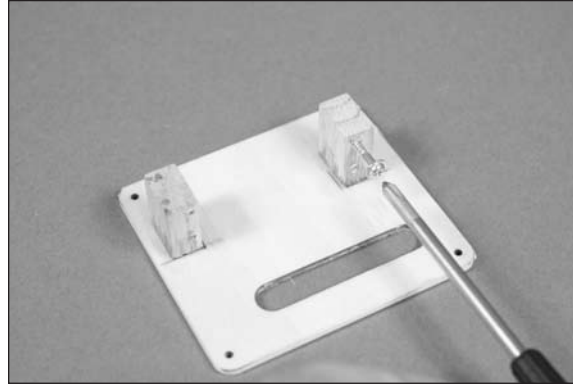

□□□□ 12. Apply 2–3 drops of thin CA in each hole to harden the surrounding wood. Allow the CA to cure before proceeding.

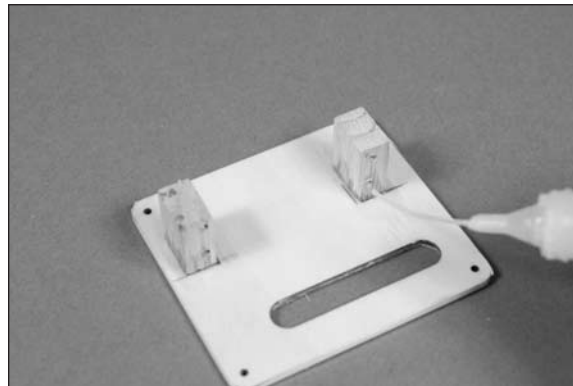

□□□□ 13. Use four servo mounting screws and a #1 Phillips screwdriver to secure the servo in position.

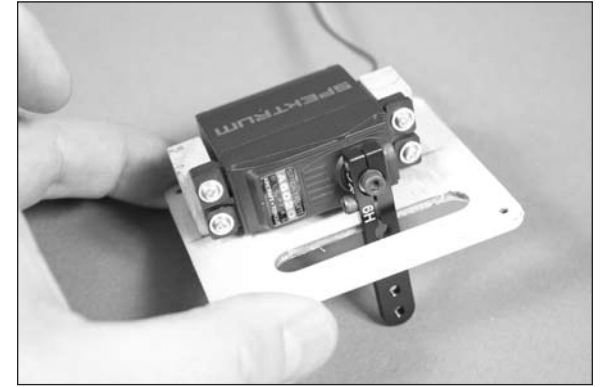

□□□□ 14. Use string or dental floss to secure an 18-inch (457mm) servo extension to the aileron servo lead.

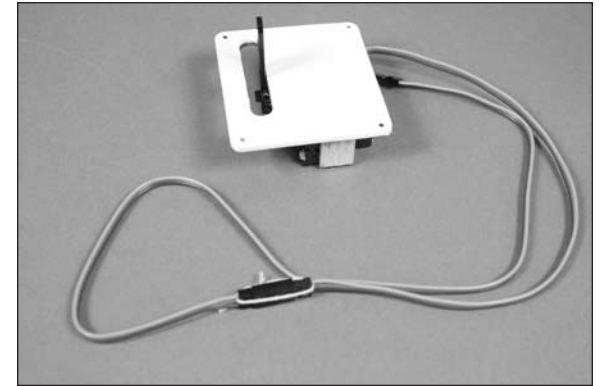

Note: Use a 3-inch (152mm) servo extension when preparing the flap servos for installation.

□□□□ 15. Use a 3/32-inch hex wrench and 1/4-inch open-end wrench to secure the ball end to the servo arm. The servo arm is located in the inner hole, which is 1 1/4-inch (31mm) from the center of the servo as shown.

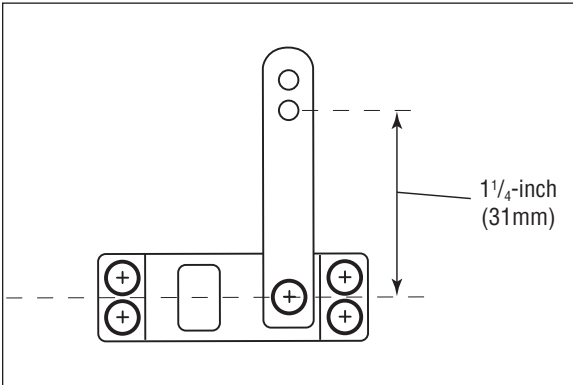
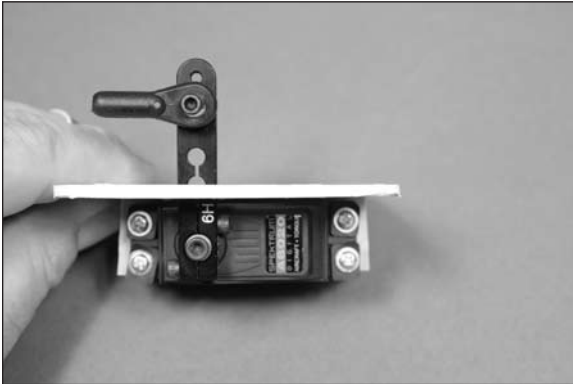

□□□□ 16. Use a #1 Phillips screwdriver to thread a 2mm x 10mm wood screw into each of the holes to cut threads in the surrounding wood. Remove the screw before proceeding to the next step.



□□□□ 17. Apply 2-3 drops of thin CA in each hole to harden the surrounding wood. Allow the CA to cure before proceeding.

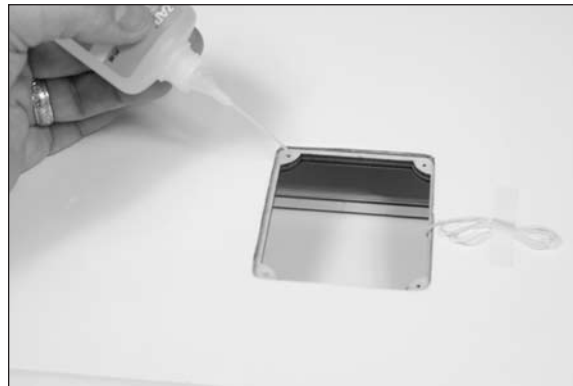

□□□□ 18. Tie the string to the end of the servo extension. Use the string to pull the servo extension through the wing to the opening for the flap servo.

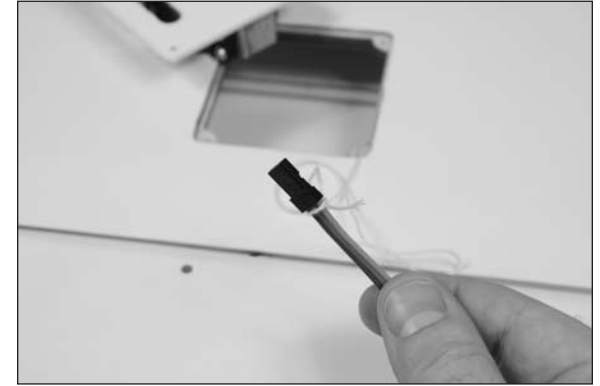

□□□□ 19. Secure the aileron servo cover in the wing using four 2mm x 10mm sheet metal screws and a #1 Phillips screwdriver.

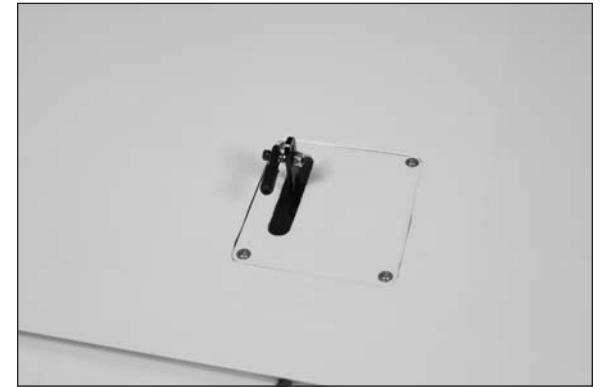

□□□□ 20. Slide the 8-32 x 2¹/₄-inch countersunk machine screw into the hole in the aileron. Mix a small amount of 30-minute epoxy and apply it to the last 1/2-inch (13mm) of the screw. Once the screw is in position, Use isopropyl alcohol and a paper towel to remove any excess epoxy.

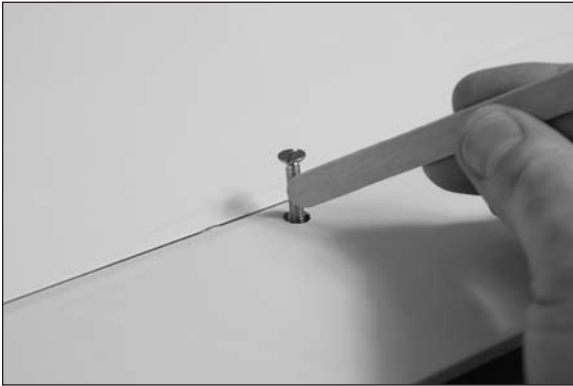

□□□□ 21. Apply a drop of threadlock on the screw near the aileron surface. Use an 11/32-inch open-end wrench to tighten the 8-32 flanged nut against the wing to secure the position of the screw.

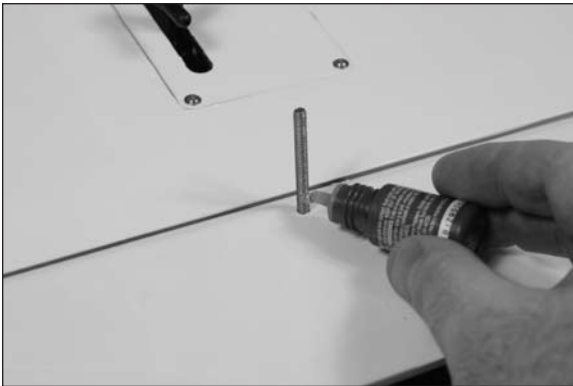

□□□□ 22. Thread the short control horn on the screw for the aileron until it is 1¹/₈-inch (29mm) from the control surface as shown. Use the short control horn for the aileron, and the long control horn for the flaps.

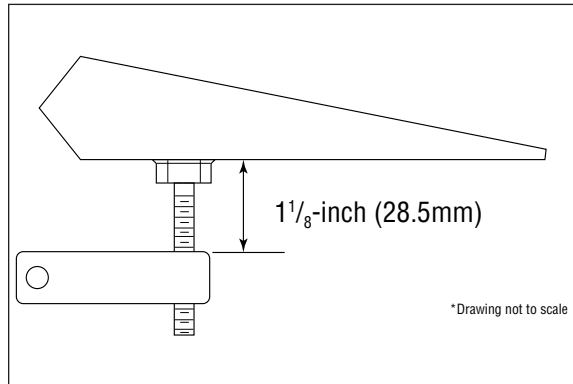

□□□ 23. Repeat Steps 2 through 22 to install the remaining aileron servos, as well as the flap servos.

□ 24. Install the 4-40 x 3-inch adjustable link between the control horn and ball end. With the servo centered, adjust the link so the aileron is centered as well. Install the linkage for both ailerons at this time.



□ 25. Use a 4-40 x 2-inch adjustable link for the flap servo installation. Adjust the linkage to achieve the mid-flap position as shown. The servo horn can be angled toward the leading edge to achieve mechanical differential.

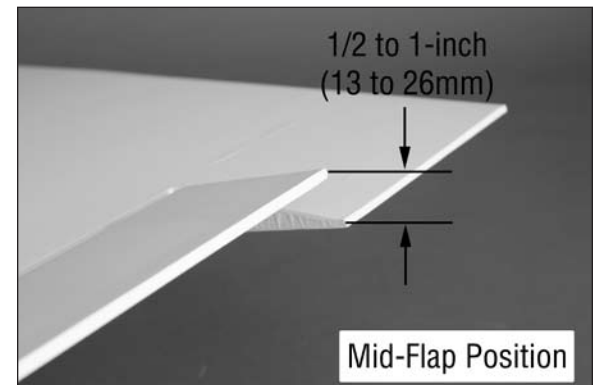

Note: If you are using a 2-position flap switch, still set the center position as a starting point for the flap linkage installation.

- 26. Next, set the full-flap position. Use the travel adjustment to set the down flap position as shown.

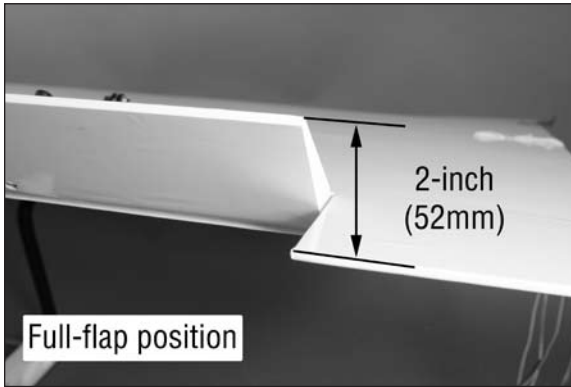

- 27. Set the flap switch to the up flap position. Use the travel adjustment to move the servo so the flap is aligned with the wing as shown.

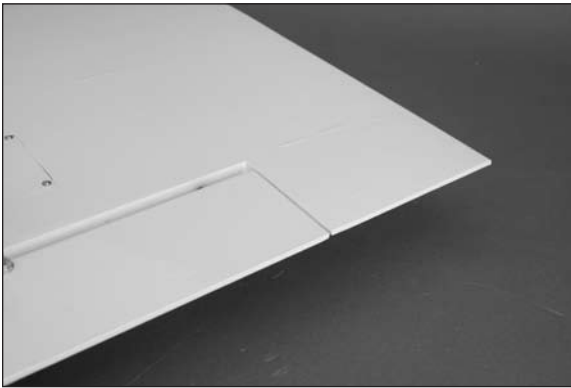

- 28. Install the remaining 4-40 x 2-inch adjustable link for the opposite flap servo. Adjust the linkage so when the transmitter is set to the up flap position, the flap is aligned with the wing. The mid and down flap positions will then match the opposite flap without any additional adjustments to the radio.

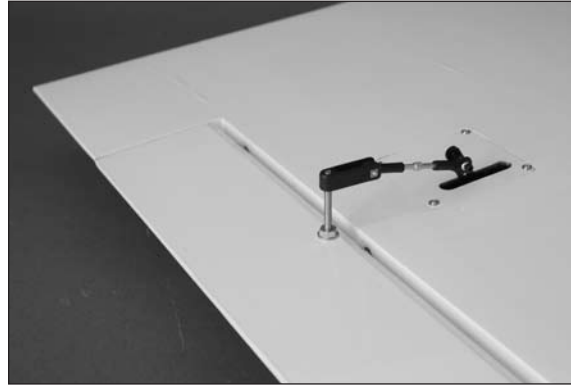

- 29. (Optional) A clear lens and a string have been provided if a lighting system is to be installed in the wing. Use canopy glue to secure the lens to the wing to either cover the opening, or to finish off the lighting system.



Wing Strut Installation

Required Parts

Wing panel (right and left)	Strut pin (6)
Strut pin clip (6)	Safety tubing (6)
4-40 lock nut (4)	Wing strut support (2)
Wing strut mount (4)	
Wing strut, long (right and left)	
Wing strut, short (right and left)	
Threaded wing strut fitting (2)	
4-40 x 1/2-inch socket head cap screw (8)	
4-40 x 5/8-inch socket head cap screw (4)	
Wing strut cover, front (right and left)	
Wing strut cover, rear (right and left)	

Required Tools and Adhesives

Hex wrench: 3/32-inch	Threadlock
Nut driver: 1/4-inch	Canopy glue
Low-tack tape	

- 1. Locate the items necessary to install the struts. You will also need the left and right wing panels for this section of the manual.

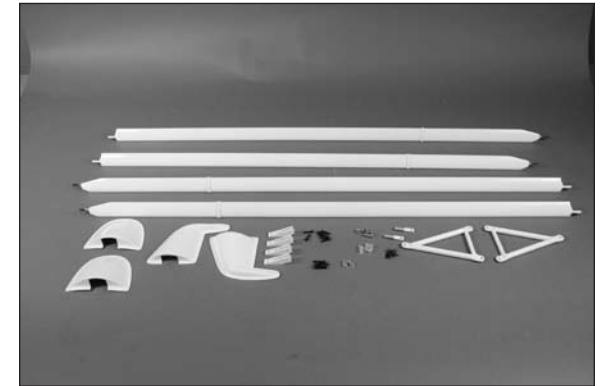

Note: Always use threadlock on metal-to-metal fasteners to prevent them from vibrating loose.

- 2. Attach two wing strut mounts to wing using 4-40 x 1/2-inch socket head cap screw and 3/32-inch hex wrench.



- 3. Install the threaded wing strut fitting in the wing so threads are flush to the wing surface. It will be at an angle when installed so it aligns with the strut support.

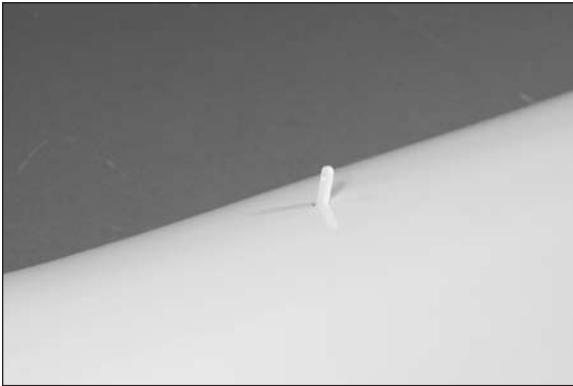

- 4. Attach long wing strut to rear fitting with 4-40 x 5/8-inch socket head cap screw and 4-40 lock nut. Use 1/4-inch nut driver and 3/32-inch hex wrench to tighten hardware. Make sure the airfoil on strut matches wing and jury strut fitting faces to wing.



- 5. Attach short wing strut to front fitting with 4-40 x 5/8-inch socket head cap screw and 4-40 lock nut. Use 1/4-inch nut driver and 3/32-inch hex wrench to tighten hardware. Make sure the airfoil on strut matches wing, and jury strut fitting faces to wing.



- 6. Slide safety tubing onto the strut pin. Prepare three pins at this time.

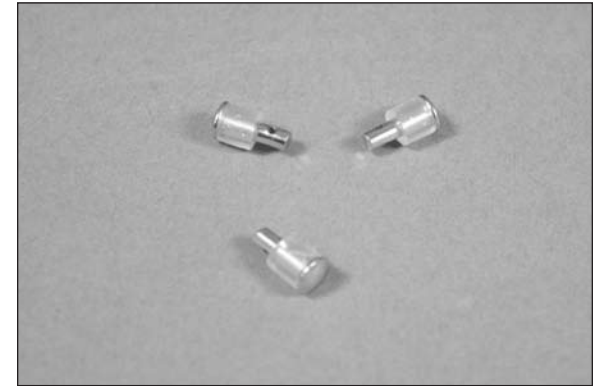

- 7. Attach jury strut with the three pins prepared in previous step and three strut pin clips. The jury strut angles slightly forward from rear strut as shown.

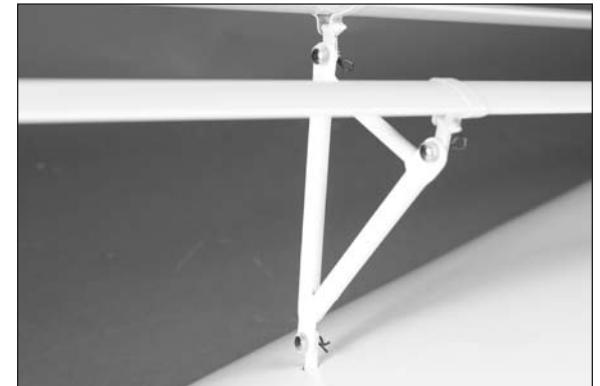

☐☐ 8. Use canopy glue to glue the front and rear wing strut covers to the wing. Use low-tack tape to hold the covers in position until the glue cures.

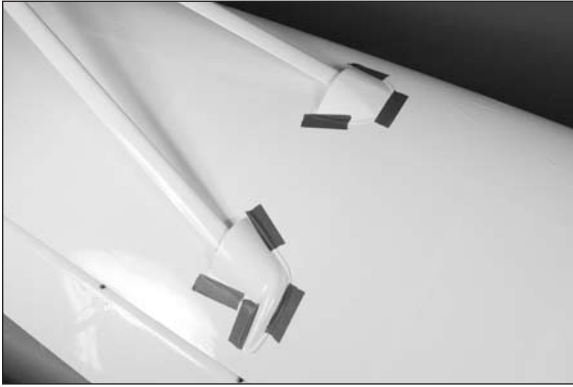

☐ 9. Repeat steps 2 through 8 to install the remaining strut to the opposite wing panel.

Rudder and Elevator Servo Installation

Required Parts

Fuselage	Servo with hardware (3)
Rudder cable (2)	Ball end with hardware (2)
Cable fitting (2)	#4 washer (3)
Cable crimp (2)	Receiver
Receiver battery	Transmitter
String or dental floss	Hook and loop strap
24-inch (610mm) servo extension	
36-inch (915mm) servo extension (3)	
4-40 x 1/2-inch socket head cap screw (3)	
2mm x 8mm sheet metal screw (8)	
Aluminum Servo Arm, 3-inch (152mm)	
Aluminum Servo Arm, 1 1/2-inch (38mm) (2)	

Required Tools and Adhesives

Crimping tool	Phillips screwdriver: #1
Fuel tubing	Nut driver: 1/4-inch
Pliers	Threadlock
Thin CA	Hex wrench: 3/32-inch

☐ 1. Locate the items necessary to install the elevator and rudder servos in the fuselage. You will also need to have the fuselage for this section of the manual.



☐ 2. Center the rudder servo. Attach the 3-inch (152mm) servo arm to the rudder servo using the hardware provided with the arm and servo.

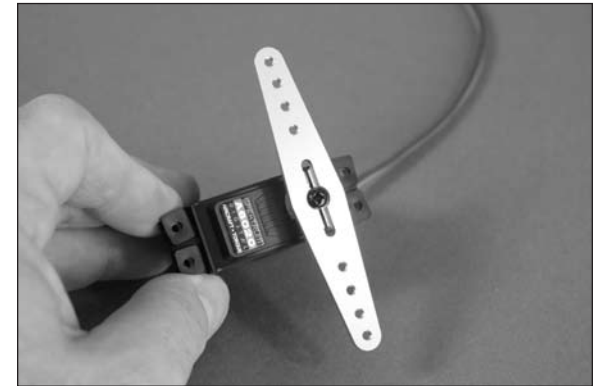
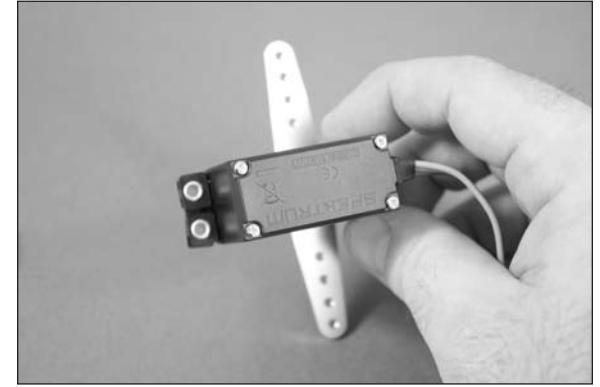

☐☐ 3. Locate the rudder cable and pass one end of the cable through the brass crimp.

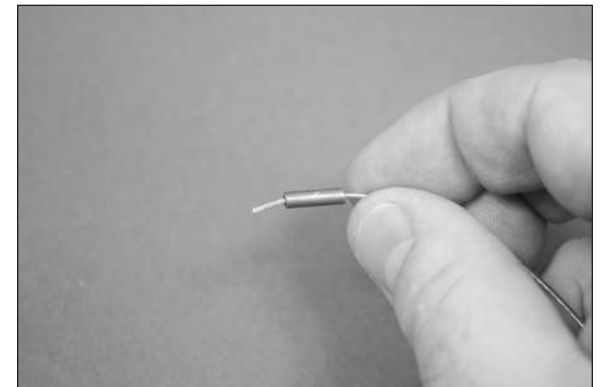

□□ 4. The cable then goes through the hole in the cable fitting. Run the cable back through the crimp

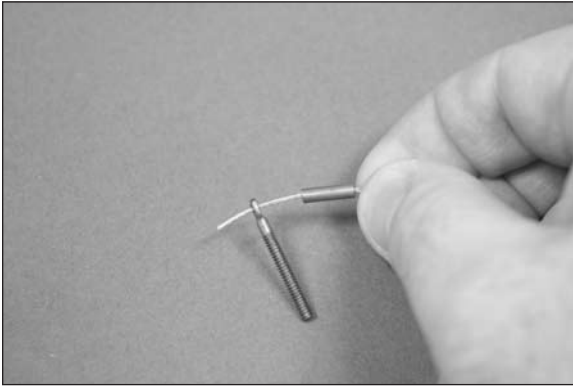

□□ 6. Pull the slack cable taut. Use a crimping tool to secure the cable and crimp in position.

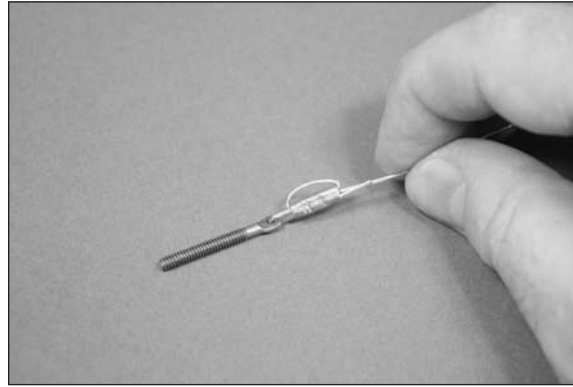

□□ 7. Thread the cable fitting in the ball end. To make sure the fitting is secure, turn the fitting 12 rotations in the ball end.



□□ 5. Loop the cable back through the crimp. This will make the cable secure when it is crimped in the next step.

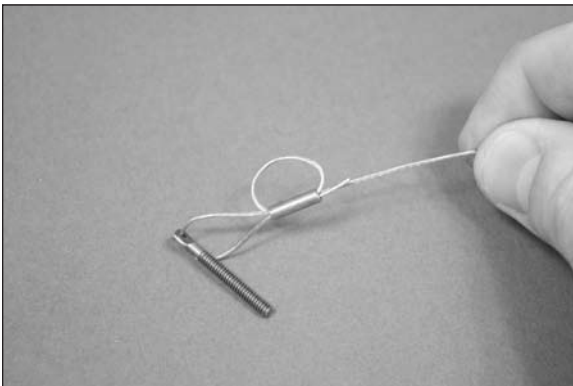

□ 8. Repeat steps 3 through 7 to prepare a second ball end and cable.

□ 9. Use a 3/32-inch hex wrench and 1/4-inch open-end wrench to secure the two ball ends to the rudder servo arm. Position the ball ends so they are 1 1/4-inch (31mm) from the center of the horn, or in the first hole in from the end.

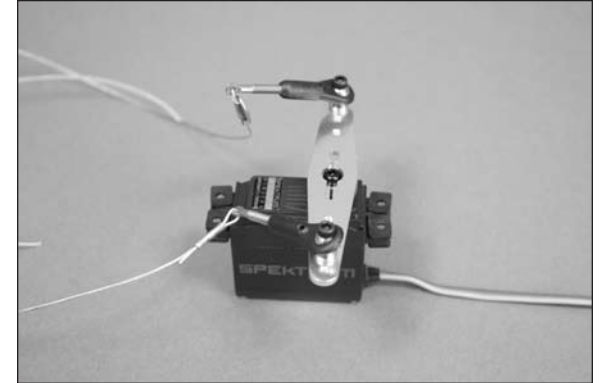

□□□ 10. Use string or dental floss to secure a 36-inch (915mm) servo extension to the rudder servo lead. Mark the lead so it can be easily identified when the servo is installed in the fuselage.

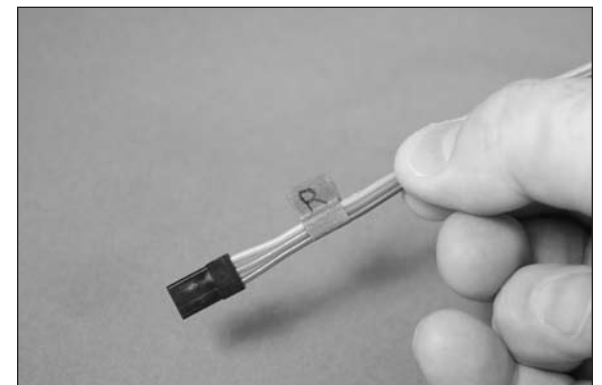
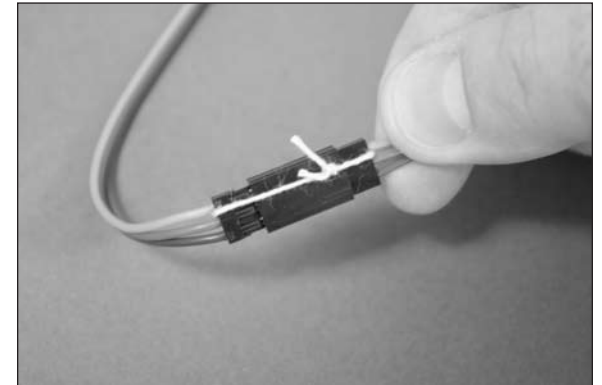

□ 11. Repeat step 10 to secure a 36-inch (915mm) extension on each of the elevator servos. Again, remember to mark the leads of the servos so they can be easily identified.

□ 12. Remove the battery and servo hatch covers from the rear of the fuselage. Set the covers aside in a safe location. They will be installed later in this section of the manual.

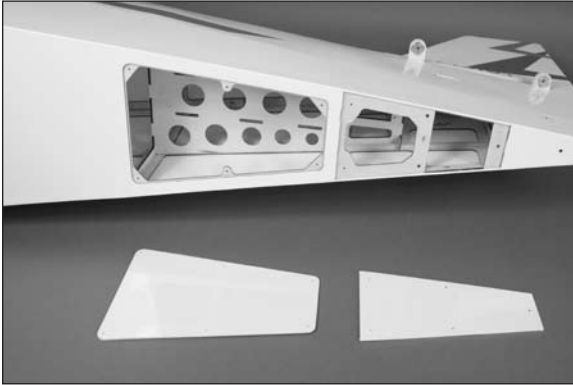

□ 13. Installing the screws for the servos can be difficult. Use a small piece of fuel tubing to hold the servo mounting screw on a #1 Phillips screwdriver so it can be installed in the fuselage.



□ 14. Thread the servo mounting screw into the holes for the rudder and elevator servos. Remove the screw before proceeding to the next step.

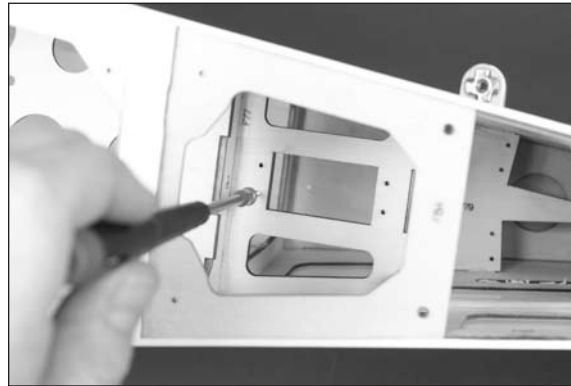

□ 15. Place 2-3 drops of thin CA in each hole to harden the surrounding wood.

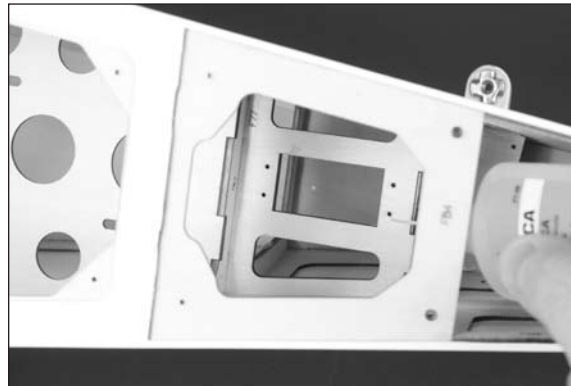

□ 16. Mount the elevator servos in the fuselage using a #1 Phillips screwdriver and the screws supplied with the servos. The servo arms can then be installed through the side of the fuselage. Access the pinch bolts on the servo horns by using the radio to move the servo arms 45-degrees to gain access through the slot in the fuselage. Make sure the servo leads fall through the fuselage toward the cockpit. Note the position of the servos in the fuselage.

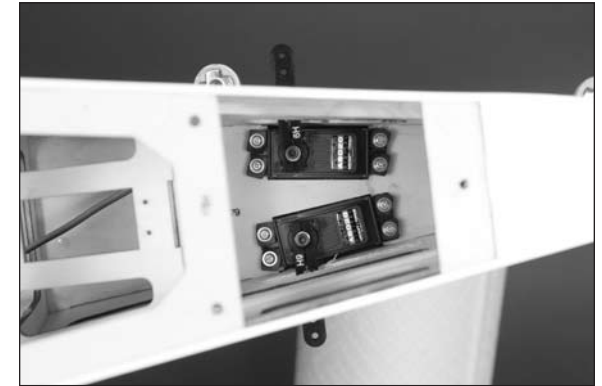

□ 17. Mount the rudder servo in the fuselage using a #1 Phillips screwdriver and the screws supplied with the servo. Make sure the servo lead falls through the fuselage toward the cockpit. Note the position of the rudder servo in the fuselage. Guide the cables for the rudder through the openings in the sides of the fuselage. Note that the cables cross inside the fuselage.



Note: Always use threadlock on metal-to-metal fasteners to prevent them from vibrating loose.

□ 18. Secure the cover over the servos using two 2mm x 8mm sheet metal screws and three 4-40 x 1/2-inch socket head cap screws. Use a #4 washer on each of the 4-40 screws. Tighten the sheet metal screws using a #1 Phillips screwdriver, and a 3/32-inch hex wrench for the 4-40 screws.



Landing Gear Installation

Required Parts

Fuselage	Landing gear shock (2)
Main wheel (2)	Landing gear bracket (4)
Wheel axle (2)	Shock end (2)
8-32 lock nut (6)	#8 washer (16)
#8 lock washer (2)	
8-32 x 3/4-inch socket head cap screw (10)	
8-32 x 1-inch socket head cap screw (4)	
8/32 x 2-inch socket head cap screw (2)	
6-32 x 1/4-inch setscrew (2)	
Wheel collar with setscrew (2)	
Main landing gear (right and left)	

Required Tools and Adhesives

Threadlock	Light machine oil
Flat blade screwdriver	
Hex wrench: 1.5mm, 5/64-inch, 1/8-inch	
Open-end wrench: 11/32-inch	

□ 1. Locate the items necessary to install the landing gear. You will also need the fuselage for this section of the manual.



□ 2. Use a 5/64-inch hex wrench to remove the two screws that secure the hatch to the fuselage. Remove the hatch and set it aside in a safe location.

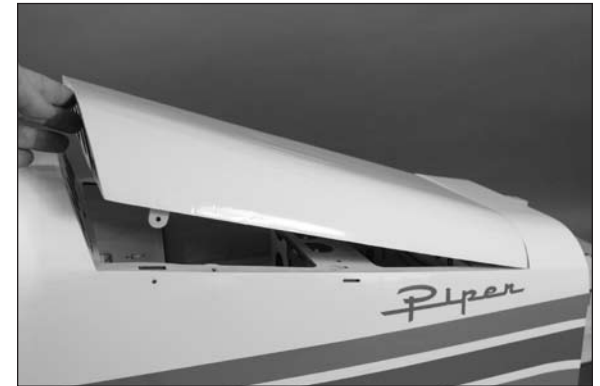

Note: Always use threadlock on metal-to-metal fasteners to prevent them from vibrating loose.

- 3. Use four 8-32 x 3/4-inch socket head cap screws and four #8 washers to attach the two landing gear brackets to the bottom of the fuselage. Leave the screws slightly loose so the gear can be installed. Tighten the screws using a 1/8-inch hex wrench.



- 4. Use two 8-32 x 1-inch socket head cap screws, four #8 washers and two 8-32 lock nuts to attach the main landing gear to the brackets. Use a 1/8-inch hex wrench and 11/32-inch open-end wrench to tighten the hardware. Make sure not to over-tighten the hardware as the gear must move freely in the brackets.



- 5. Fully tighten the screws that secure the landing gear brackets to the fuselage at this time using a 1/8-inch hex wrench. Double-check that the gear can still move freely in the brackets. If not, adjust the hardware as necessary.

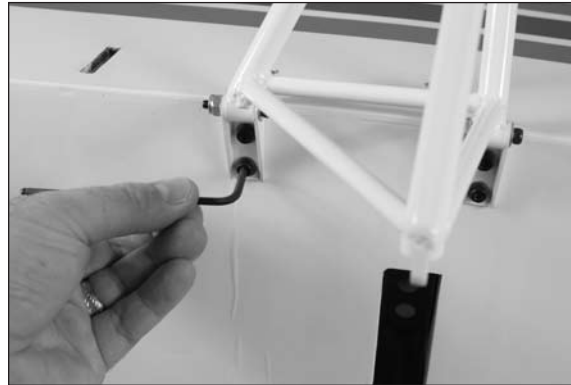

Note: Always use threadlock on metal-to-metal fasteners to prevent them from vibrating loose.

- 6. Thread the shock end on the shock. Screw the end on so the threads are flush to the inside of the bracket. You must use threadlock on the shock end to prevent it from vibrating loose over time.



- 7. Attach the shock end to the main landing gear using an 8/32 x 1-inch socket head cap screw and 8/32 lock nut. Use an open-end 11/32-inch wrench and 1/8-inch hex wrench to tighten the hardware. Check to make sure the shock can pivot on the gear, and if not, adjust as necessary until it can move freely.



Note: Always use threadlock on metal-to-metal fasteners to prevent them from vibrating loose.

- 8. Slide a #8 lock washer, then a #8 washer on an 8/32 x 2-inch socket head cap screw. Slide the screw through the bushing, then on through the hole in the top of the shock. The screw then threads into a blind nut that has been installed in the fuselage. Tighten the screw using a 1/8-inch hex wrench.

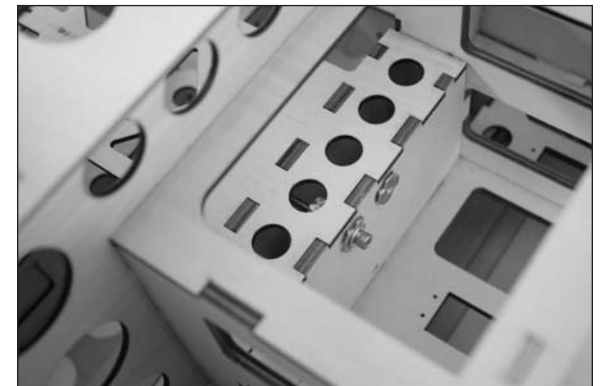

Note: Always use threadlock on metal-to-metal fasteners to prevent them from vibrating loose.

- 9. Slide the wheel collar on the axle. The flat on the axle will be the one closest to the end of the axle. Use a 1.5mm hex wrench to tighten the setscrew in the wheel collar on the flat of the axle.

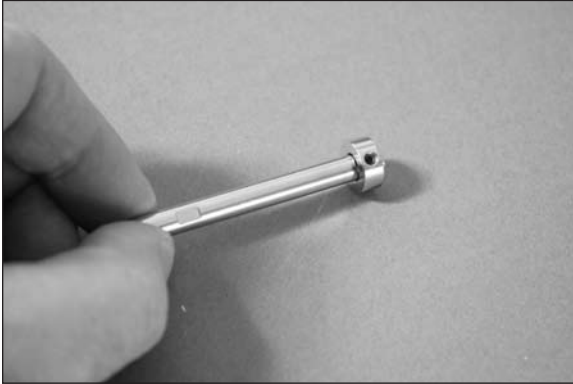

- 10. Remove the hub cap from the wheel using a small flat blade screwdriver. Place a drop of light machine oil on the axle, then slide the axle through the wheel from the side with the hub cap as shown.



Note: Always use threadlock on metal-to-metal fasteners to prevent them from vibrating loose.

- 11. Slide the axle into the gear. Use a 6/32 x 1/4-inch setscrew and 5/64-inch hex wrench to secure the axle in position. Make sure to tighten the setscrew on the flat of the axle, and that the wheel can rotate freely on the axle. Once the axle is secure, place the hub cap back in position on the wheel.

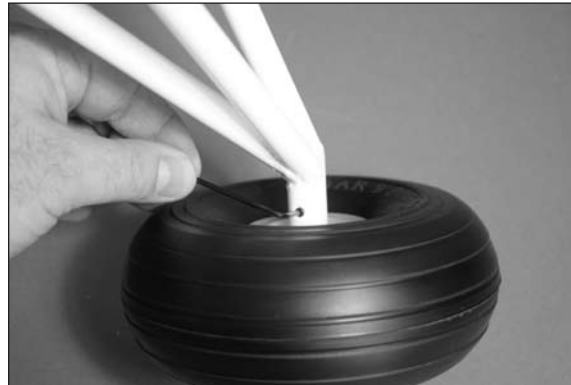

Hint: Place a drop of silicone adhesive on the inside edge of the hub cap if you find it is not secure when in position.

- 12. Repeat steps 3 through 11 to install the remaining landing gear and wheel.

Stabilizer Installation

Required Parts

Fuselage assembly
#8 washer (4)
Stabilizer assembly (right and left)
8-32 x 1 1/4-inch socket head cap screw (4)
Aluminum stabilizer tube, short
Aluminum stabilizer tube, long

Required Tools and Adhesives

Hex wrench: 3/32-inch, 1/8-inch
Threadlock
Open-end wrench: 1/4-inch

- 1. Locate the items to attach the stabilizer halves to the fuselage. You will also need the fuselage, as well as the left and right stabilizers for this section of the manual.

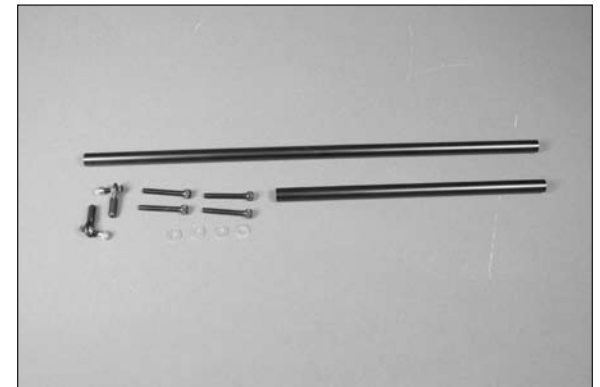

- 2. Use a 3/32-inch hex wrench and 1/4-inch open-end wrench to attach the ball end to the top side of the servo horn. Install both ball ends at this time.



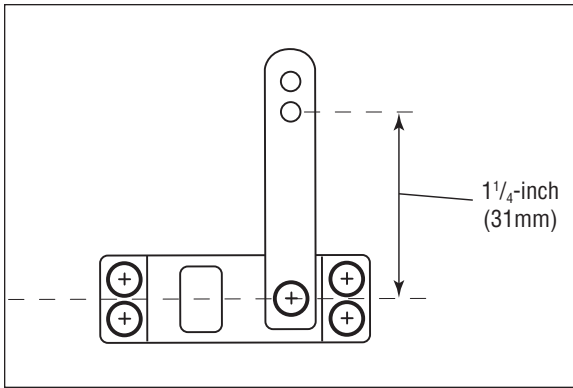

□ 3. There is a right and left stabilizer and elevator assembly. When installing them, make sure the countersunk hole for the elevator control horn screw faces toward the top of the airframe.

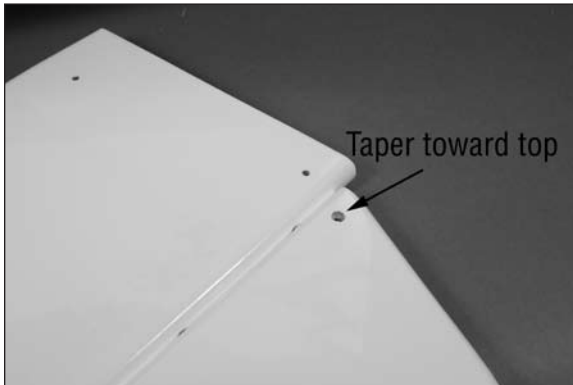

□ 4. Slide the aluminum tubes for the stabilizer into the stabilizer. Note the longer tube is closer to the elevator as shown in the photo below.



□ 5. Slide the stabilizer assembly into the slot at the rear of the fuselage.



Note: Always use threadlock on metal-to-metal fasteners to prevent them from vibrating loose.

□ 6. Use two 8-32 x 1 1/4-inch socket head cap screws and two #8 washers to keep the stabilizer half in position. Do not tighten the screws at this time.



□ 7. Slide the remaining stabilizer into position. Start the screws that secure the stabilizer. Once all the screws have been started, use a 1/8-inch hex wrench to fully tighten the screws, securing the stabilizer to the fuselage.



Elevator Linkage Installation

Required Parts

- Fuselage assembly
- Control horn with ball end (2)
- 8-32 x 2 $\frac{1}{4}$ -inch countersunk machine screw (4)
- 4-40 x 4 $\frac{1}{2}$ -inch adjustable link (2)
- 8-32 flanged nut (2)

Required Tools and Adhesives

- Flat blade screwdriver
- Mixing cup
- Isopropyl alcohol
- Open-end wrench: 11/32-inch
- Paper towels
- Linkage wrench (optional)

- 1. Locate the items necessary to install the elevator linkages. You will also need the fuselage assembly for this section of the manual.

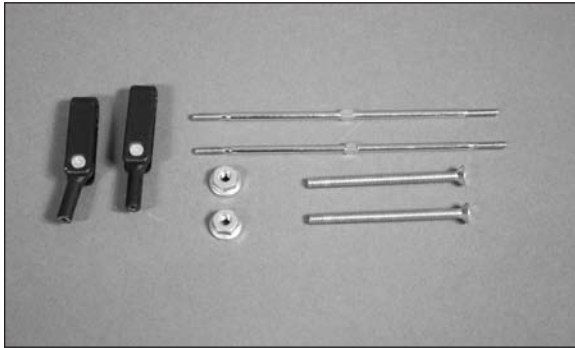

- 2. Slide the 8-32 x 2 $\frac{1}{4}$ -inch countersunk machine screw through the elevator from the top of the elevator. Thread an 8-32 flanged nut on the screw. While using a flat blade screwdriver to hold the screw, thread the control horn on the screw.



Note: Always use threadlock on metal-to-metal fasteners to prevent them from vibrating loose.

- 3. Use an 11/32-inch open-end wrench to tighten the nut against the elevator to secure the screw. We recommend using 30-minute epoxy on the screw as described in the aileron and flap section of the manual. Adjust the position of the control horn so it is 1 $\frac{1}{8}$ -inch (28mm) as shown in the drawing.

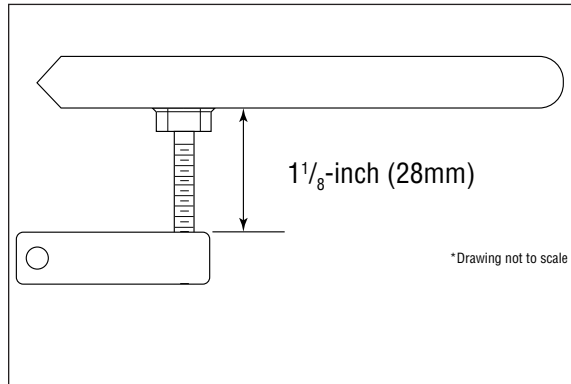

- 4. Install the 4-40 x 4 $\frac{1}{2}$ -inch adjustable link between the control horn and ball end. With the servo centered, adjust the link so the elevator is aligned with the stabilizer.

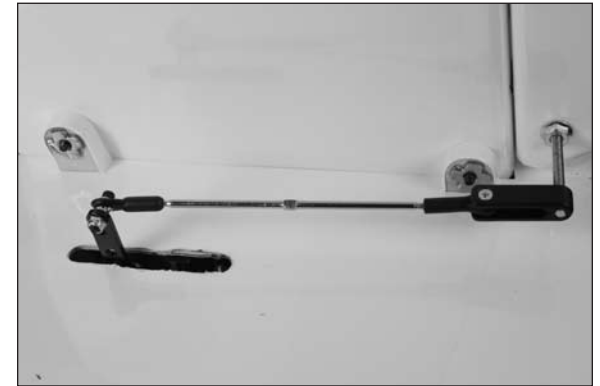

- 5. Repeat steps 2 through 4 for the remaining elevator linkage.

Tail Wheel Installation

Required Parts

Fuselage assembly	Tail gear assembly
Aluminum strut fitting	#4 washer (2)
4-40 x 5/8-inch socket head cap screw (2)	

Required Tools and Adhesives

Hex wrench: 3/32-inch Threadlock

□ 1. Locate the items necessary to attach the tail wheel to the fuselage. You will also need the fuselage for this section of the manual.

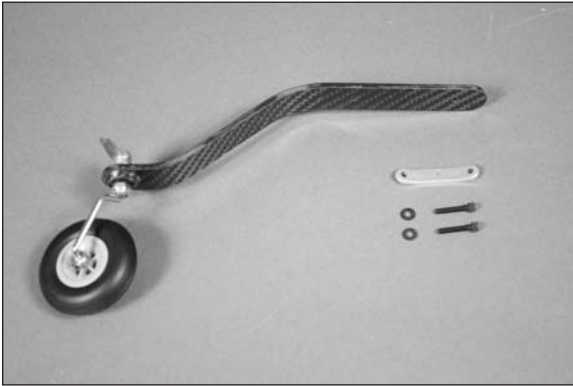

Note: Always use threadlock on metal-to-metal fasteners to prevent them from vibrating loose.

□ 2. Use two 4-40 x 5/8-inch socket head cap screws and a 3/32-inch hex wrench to secure the tail gear assembly and strut fitting to the fuselage as shown.



Tail Strut Installation

Required Parts

Fuselage assembly	Metal clevis (16)
Silicone clevis retainer (16)	4-40 nut (16)
Brass strut fitting (14)	4-40 lock nut (6)
#4 washer (12)	
4-40 x 1-inch socket head cap screw (6)	
4-40 x 1 1/8-inch threaded rod (6)	
4-40 x 1 1/8-inch threaded rod (2)	

Required Tools and Adhesives

Hex wrench: 3/32-inch Threadlock
Pliers
Open-end wrench: 3/16-inch, 1/4-inch

□ 1. Locate the items necessary to install the tail struts. You will also need the fuselage for this section of the manual.

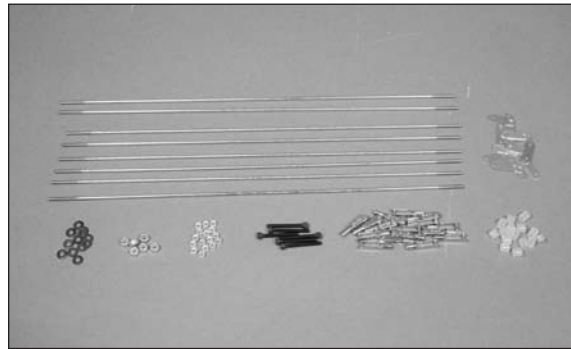

□ 2. Use pliers to make a slight bend in each of the brass strut fittings.



□ 3. Use six 4-40 x 1-inch socket head cap screws, six 4-40 lock nuts and twelve #4 washers to attach the brass strut fittings to the fin and stabilizer. The larger hole is used to attach the strut fitting, while the smaller hole is used to attach the clevises. Tighten the hardware using a 3/32-inch hex wrench and 1/4-inch open-end wrench.



- 4. Attach the last two brass strut fittings to the bottom of the fuselage by removing the screws that hold the servo cover in position. Tighten the screws using a 3/32-hex wrench.

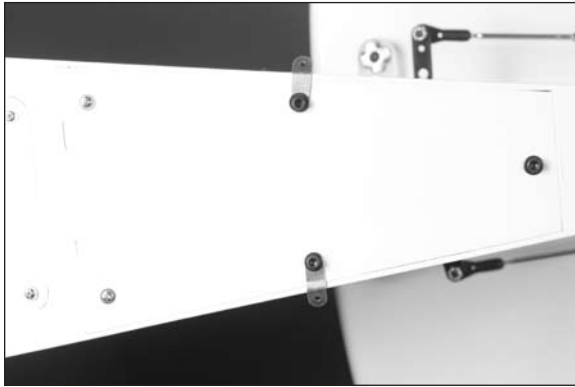

- 5. Thread a 4-40 nut on each of the threaded rods. After sliding a silicone clevis retainer on each of the clevises, thread the clevis on the rod until the end of the rod can be seen between the forks of the clevis. Make sure to set aside the two longer 4-40 x 11⁷/₈-inch threaded rods so they can be installed in the correct location on your model.



Note: Always use threadlock on metal-to-metal fasteners to prevent them from vibrating loose.

- 6. Attach the rods to the brass strut fittings on the stabilizer. Adjust each rod so they fit to their specific location without forcing them into position. The longer 4-40 x 11⁷/₈-inch threaded rods are used on the underside of the stabilizer toward the rear of the fuselage. Once all the rods are installed, use a 3/16-inch open-end wrench to tighten the 4-40 nuts against the clevises to keep them from moving. Slide the clevis retainer over the clevises to keep them from opening accidentally in flight.



Rudder Preparation

Required Parts

Rudder	8-32 flanged nut (2)
Rudder tiller arm	8-32 x 4-inch threaded rod
#4 x 5/8-inch sheet metal screw (2)	
Control horn with ball end (2)	

Required Tools and Adhesives

Phillips screwdriver: #1	Pin vise
Thin CA	Felt-tipped pen
Drill bit: 1/16-inch (1.5mm)	
Open-end wrench: 11/32-inch	

- 1. Locate the items to prepare the rudder for installation on the fuselage. You will also need to have the rudder for this section of the manual.



Note: Always use threadlock on metal-to-metal fasteners to prevent them from vibrating loose.

- 2. Insert the 8-32 x 4-inch threaded rod into the hole in the rudder. Thread an 8-32 flanged nut on either side of the rudder to secure the threaded rod.



□ 3. Measure the rod to make sure it is centered in the rudder as shown

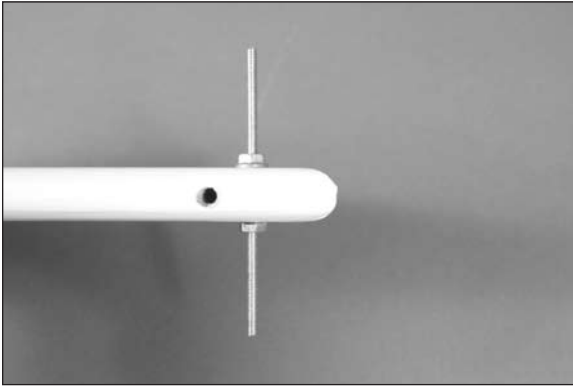

□ 4. Thread a control horn on each end of the threaded rod so the measurement from the control surface to the clevis is 1 1/8-inch (28mm) as shown in the drawing.

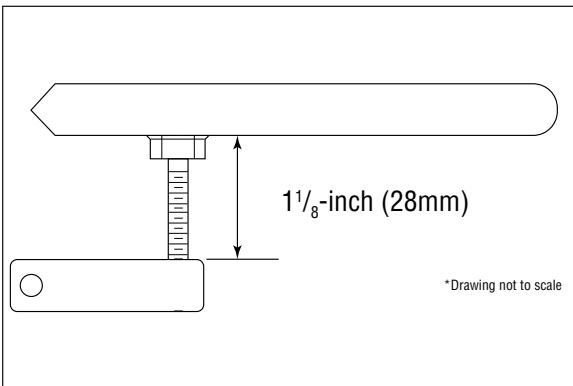

□ 5. Position the rudder tiller arm on the bottom of the rudder. Use a felt-tipped pen to mark the locations for the two mounting screws.



□ 6. Use a pin vise and 1/16-inch (1.5mm) drill bit to drill the two holes for the tiller arm mounting screws.



□ 7. Use a #1 Phillips screwdriver to thread a #4 x 5/8-inch sheet metal screw in each of the holes drilled in the previous step to cut threads in the surrounding wood. Remove the screw and apply 2–3 drops of thin CA in each hole to harden the threads.

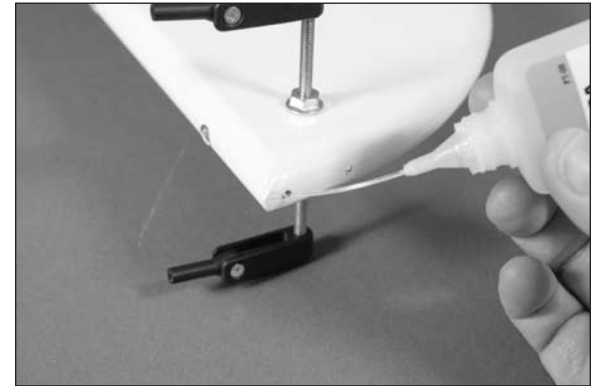
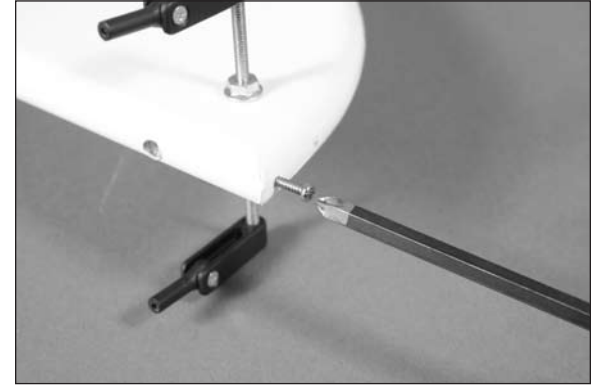

□ 8. Secure the rudder tiller arm using two #4 x 5/8-inch sheet metal screws and a #1 Phillips screwdriver.

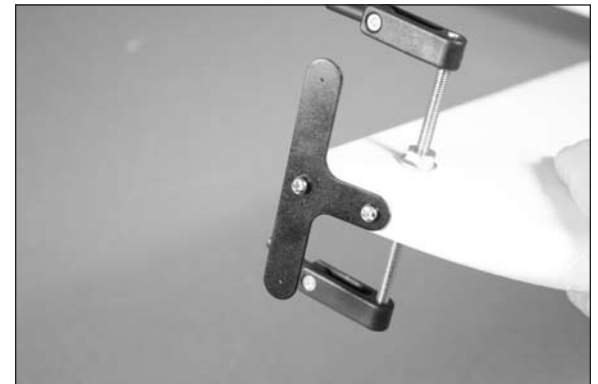

Rudder Installation

Required Parts

Fuselage assembly
Brass crimp, cable (2)
Pin hinge (4)
Tail wheel spring (2)
Cable fitting (2)
Brass crimp, tail wheel spring (4)

Required Tools and Adhesives

Petroleum jelly
Toothpicks
Pliers
30-minute epoxy
Hobby knife with #11 blade
Crimping tool

□ 1. Locate the items to attach the rudder to the fuselage. You will also need rudder and fuselage assemblies for this section of the manual.

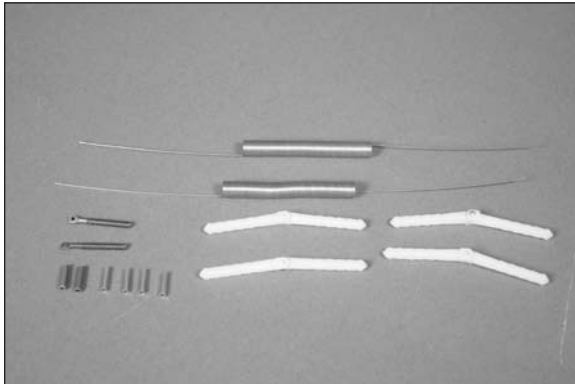

□ 2. Apply a thin coat of petroleum jelly to the hinge point of each of the four hinges. This will keep epoxy from entering the hinge, which could restrict their movement.

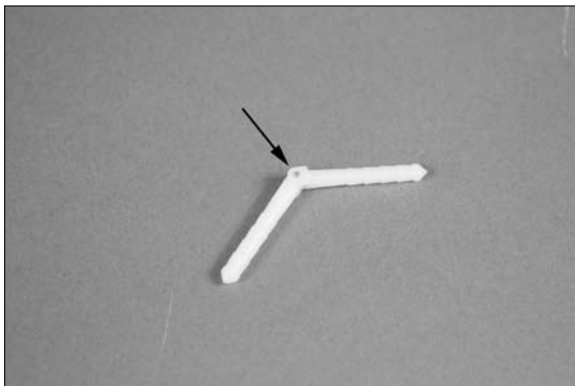

□ 3. Place the hinges in the rudder. When positioned to full throw, they will be perpendicular to the hinge line. They also will be inserted so the hinge point is aligned with the hinge line of the rudder. Use a hobby knife and #11 blade to trim the rudder as necessary to fit the hinges.

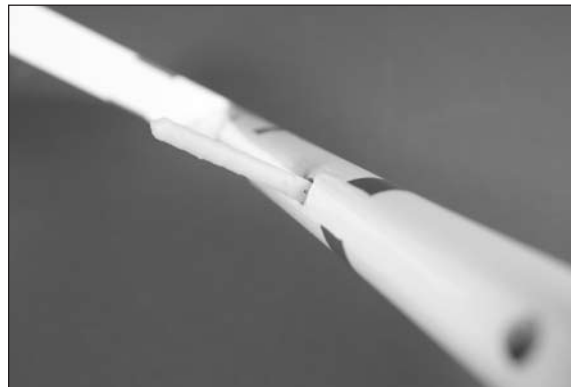
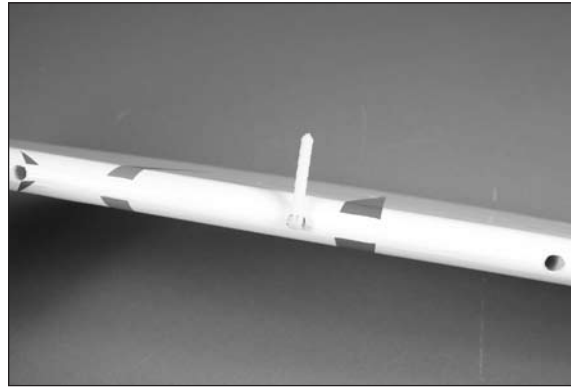

□ 4. Use a toothpick and 30-minute epoxy to glue the hinges in the rudder. Make sure to apply epoxy to both the hinges and into the holes in the rudder. Use isopropyl alcohol and a paper towel to remove any excess epoxy. Allow the epoxy to fully cure before proceeding.

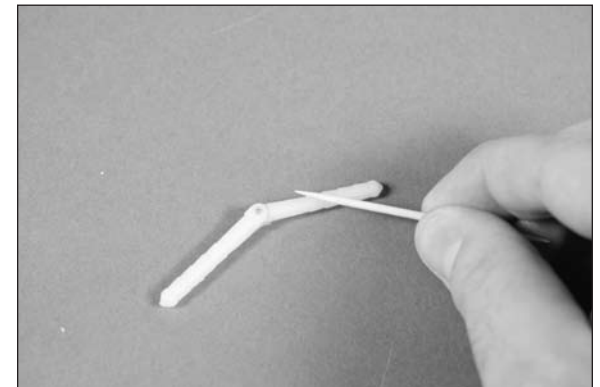
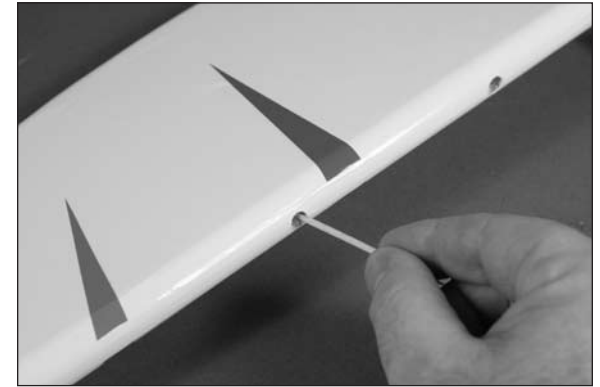

□ 5. Thread a cable fitting into each of the ball ends. To make sure the fitting is secure, turn the fitting 12 rotations in the ball end.



□ 6. Test fit the rudder to the fin. Trim the holes as necessary to fit the rudder tightly to the fin.



□ 7. Use 30-minute epoxy to glue the hinges to the fin. Allow the epoxy to fully cure before proceeding.



□ 8. Use brass crimps to secure the cable to the cable fittings. Make sure the radio system is on and the rudder servo centered before using crimping pliers to secure the crimps to the cable.

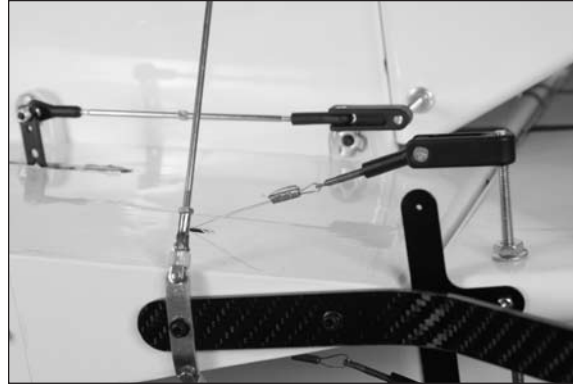

□ 9. Use the smaller brass crimps to secure the tail wheel springs to the rudder tiller arm and the tail wheel arm. Use crimping pliers to secure the crimps in position.

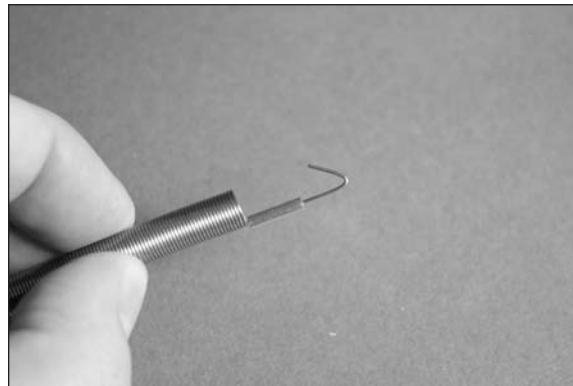

Engine and Cowling Installation

Required Parts

Fuselage assembly	Engine mount box
1/4-20 blind nut (4)	1/4-inch washer (4)
1/4-inch lock washer (4)	Ball end with hardware (2)
#4 tapered washer (5)	Foam disk (5)
Cowling	Transmitter
Receiver	Receiver battery
Servo with hardware	Fuel tank assembly
Tie wrap, 12-inch (305mm) (2)	
Aluminum servo arm, 1 1/2-inch (38mm)	
18-inch (457mm) servo extension	
4-40 x 1 3/4-inch adjustable linkage	
4-40 x 3/4-inch button head cap screw	
4-40 x 1/2-inch button head cap screw (4)	
Engine with hardware and accessories	
1/4-20 x 1 1/4-inch socket head screw (4)	
Plywood engine mounting template	

Required Tools and Adhesives

Drill	Thin CA
Straight edge or ruler	Phillips screwdriver: #1
30-minute epoxy	Isopropyl alcohol
Epoxy brush	Mixing cup
Mixing stick	Pencil
Paper towel	Side cutter
Open-end wrench: 1/4-inch	
Hex wrench: 5/64-inch, 3/16-inch	
Drill bit: 1/16-inch (1.5mm), 5/16-inch (8mm)	
Linkage wrench (optional)	

□ 1. Locate the items necessary to install the engine. You will also need the fuselage assembly and the cowling for this section of the manual.

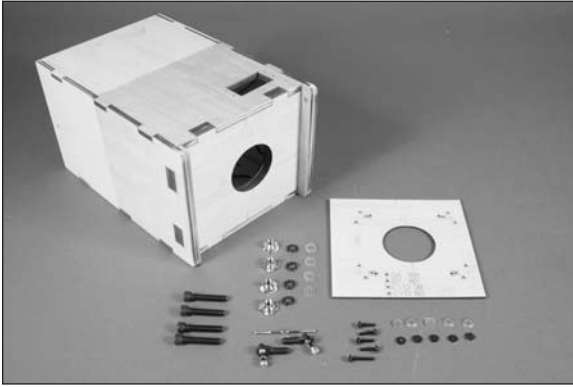

□ 2. Tape the plywood template to the front of the engine mount box. Make sure the top of the template faces the side of the box with the opening for the throttle servo. Use a drill and 1/16-inch (1.5mm) drill bit to drill the holes for your particular engine.

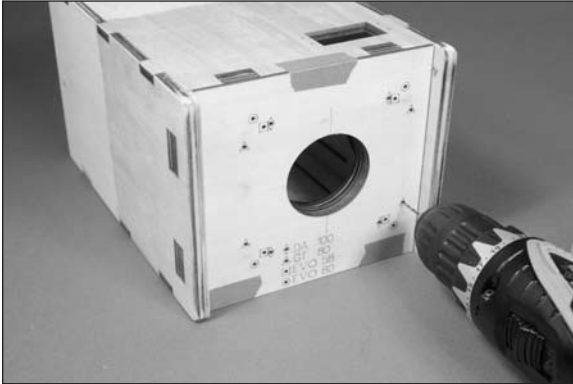

□ 3. Remove the template and use a drill and 5/16-inch (8mm) drill bit to enlarge the mounting holes. You will also need to drill a hole for the fuel tubing suited to your particular engine.

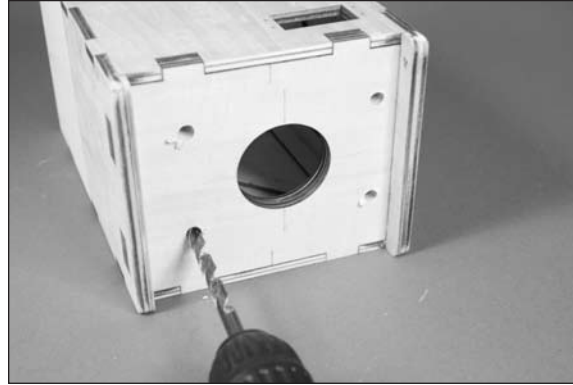

Note: Always use threadlock on metal-to-metal fasteners to prevent them from vibrating loose.

□ 4. Use four 1/4-inch blind nuts, four 1/4-inch washers, four 1/4-inch lock washers and four 1/4-20 x 1 1/4-inch socket head screws to secure the engine to the engine box. Tighten the hardware using a 3/16-inch hex wrench.



□ 5. Thread the servo mounting screw into the holes for the throttle servo. Remove the screw before proceeding to the next step.

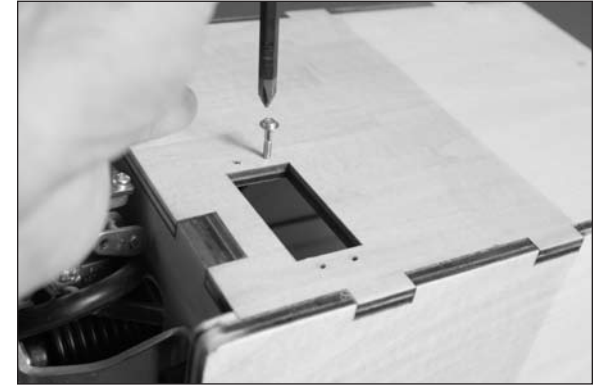

□ 6. Place 2–3 drops of thin CA in each hole to harden the surrounding wood.



□ 7. Install the grommets and brass eyelets in the throttle servo. Secure the servo using a #1 Phillips screwdriver and the hardware included with the servo. Make sure to prepare and harden the holes as described through the earlier sections of the manual for servo installation.

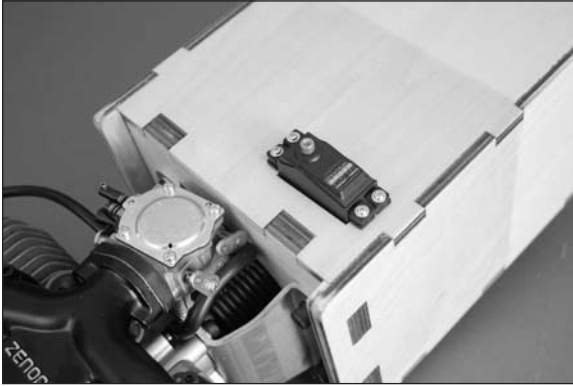

□ 8. Attach the servo arm to the throttle servo. Install the two ball links and the 4-40 x 1³/₄-inch adjustable linkage. Use the radio system to check the operation of the throttle servo to make sure it operates the carburetor correctly.

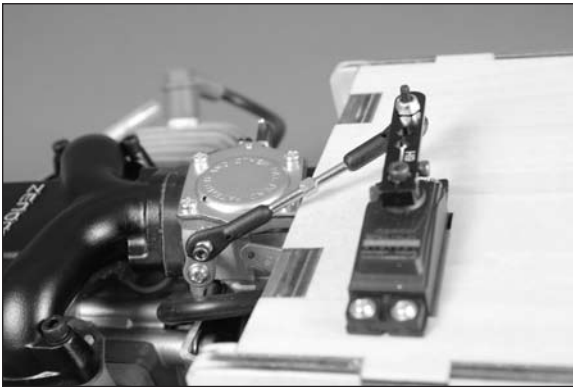

□ 9. Slide the engine mount box into the fuselage as shown.

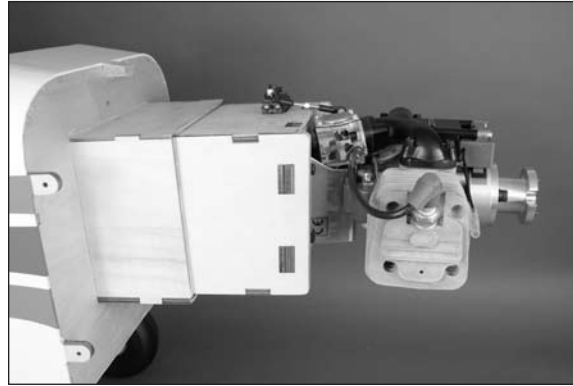

□ 10. Prepare the five cowl mounting screws using five tapered washers, five foam disks, four 4-40 x 1/2-inch button head screws and one 4-40 x 3/4-inch button head screw. Note that the tapered washers will have the cone facing out toward the head of the screw.

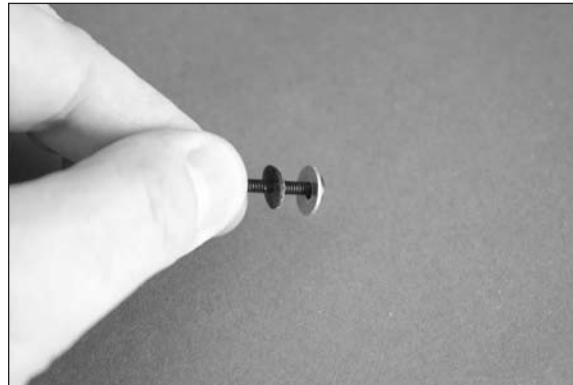

□ 11. Slide the cowl into position and secure it using the screws prepared in the previous step. The longer 4-40 x 3/4-inch screw is used to secure the cowl at the top-center of the cowl. Use a 5/64-inch hex wrench to tighten the cowl mounting screws.

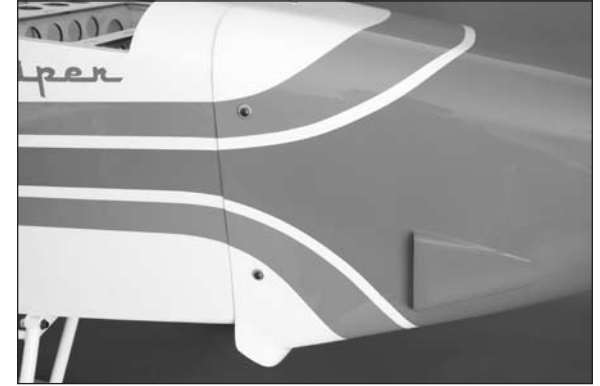

□ 12. Use a straight edge on the drive washer of the engine to check the gap for the spinner. Adjust the position of the engine box in the fuselage until there is a 3/32-inch (2mm) gap between the straight edge and cowl as shown.



Note: The previous step only works when using a spinner with a flat backplate. If the backplate of your particular spinner will be recessed on the driver washer, use the backplate to set the gap between the cowl and spinner backplate.

□ 13. Carefully remove the cowl so as not to disturb the position of the engine. Use a pencil to transfer the edge of the fuselage in the engine box so it can be returned to its location after it is removed from the fuselage.

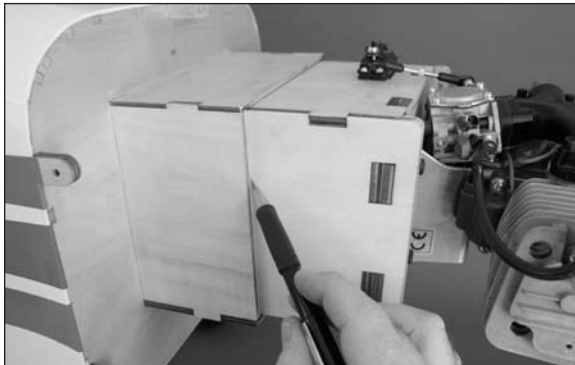

□ 14. Use 30-minute epoxy to secure the engine mounting box in the fuselage. Make sure to apply epoxy to all surfaces that will come in contact with each other on both the engine mounting box and fuselage. Slide the engine mounting box back into position and use isopropyl alcohol and a paper towel to remove any excess epoxy.

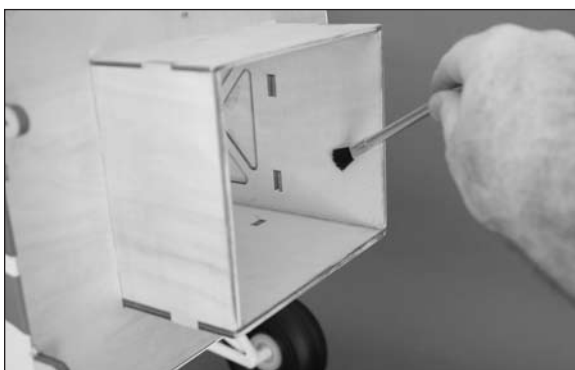
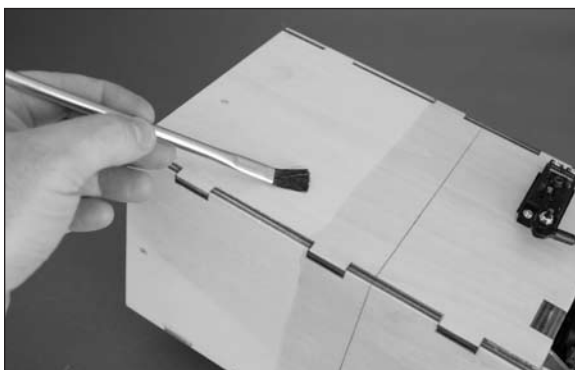

□ 15. Secure the fuel tank in the airframe using two 12-inch (305mm) tie wraps. Route the fuel lines to the engine and out of the bottom of the fuselage. Make sure to secure the fuel tube to the fuel inlet nipple of the engine to prevent it from coming loose in flight.



Note: We use a Fuel Filler with a "T" Fitting and Overflow Fitting (HAN116) to allow fueling of the model without the necessity of removing the cowl.

□ 16. Complete the engine installation by installing the mufflers and any other accessories necessary to operate your engine. Place the cowl on the airframe and trim as necessary to clear the exhaust and accessories. Once the cowl is secured to the fuselage, install the propeller and spinner.

Hint: Place a drop of canopy glue on the cowl mounting screws to help keep them from vibrating loose in flight.

Receiver and Switch Harness Installation

Required Parts

Fuselage assembly	Hook and loop strap
Foam rubber (not included)	Receiver
Switch harness	
12-inch (305mm) servo extension (4)	
Hook and loop tape (not included)	

Required Tools and Adhesives

Phillips screwdriver: #1 Hobby knife with #11 blade
Scissors

□ 1. Open the door to the cockpit by squeezing the two screws together and pulling the door open. Remember to squeeze the screws together to close the door as well.



2. Use foam rubber and a hook and loop strap to secure the receiver in the fuselage. Make sure to plug the servos into the correct ports of the receiver, as well as the 12-inch (305mm) extensions into the aileron and flap ports of the receiver.



3. Use hook and loop tape (not included) to mount the remote receiver as far away from the main receiver as possible. Make sure the antenna on the remote receiver is positioned vertically in comparison to the horizontal positioning of the main receiver antenna.



4. Use a hobby knife with a #11 blade to remove the covering from the fuselage for the switch harness. Mount the harness using the hardware provided with the harness.

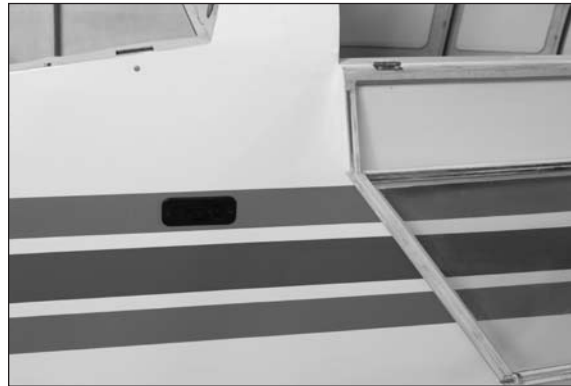
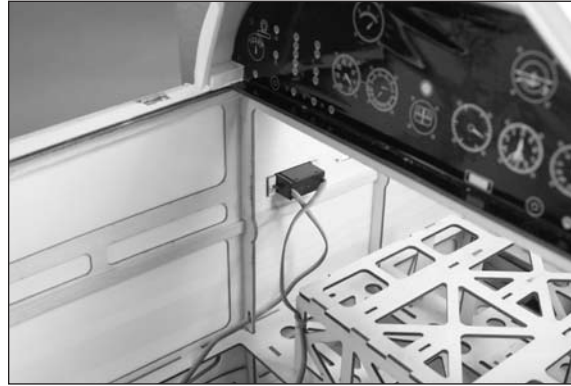

Note: Multiple locations have been provided for the switch harness installation. Use a location that best suits your radio installation, battery and receiver positioning in the fuselage.

Wing Installation

Required Parts

Fuselage assembly	#8 washer (4)
Strut end (4)	4mm nut (4)
Strut pin (4)	Strut pin clip (4)
Safety tubing (4)	
Wing assembly (right and left)	
Aluminum wing joiner (A and B)	
1/4-20 x 2-inch nylon wing bolt	
8-32 x 3/4-inch socket head cap screw (4)	
Strut attachment mount (2)	

Required Tools and Adhesives

Open-end wrench: 7mm Hex wrench: 1/8-inch
Threadlock

1. Locate the items necessary to attach the wing panels to the fuselage. You will also need the fuselage assembly, as well as the right and left wing panels for this section of the manual.

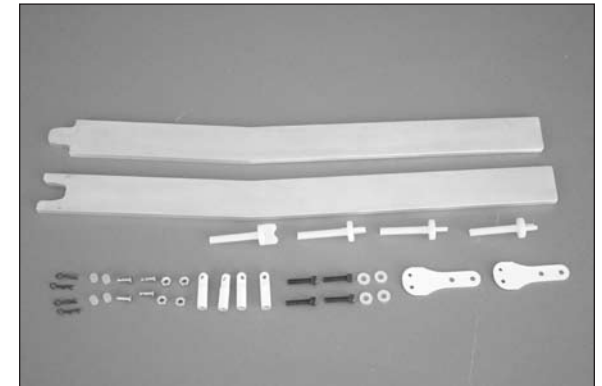

Note: Always use threadlock on metal-to-metal fasteners to prevent them from vibrating loose.

- 2. Use two 8-32 x 3/4-inch socket head cap screws and two #8 washers to secure the strut attachment mount in position. Note that the mount will angle down slightly toward the wing. Use a 1/8-inch hex wrench to tighten the screws.

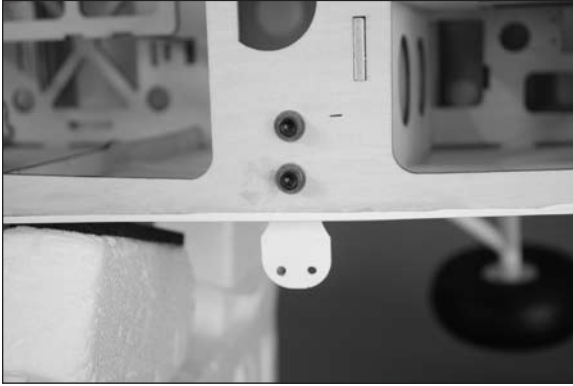

- 3. Thread a 4mm nut and a strut end on each of the struts. The final position of the ends will be adjusted once the wing is on the fuselage.

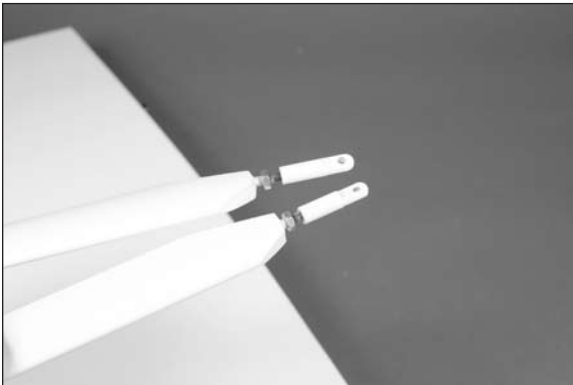

- 4. Slide the aluminum wing joiner into the pocket in the wing. Slide the joiner in only as far as it will easily slide, as forcing it could cause damage to the wing. Note the joiner faces up toward the top of the wing.

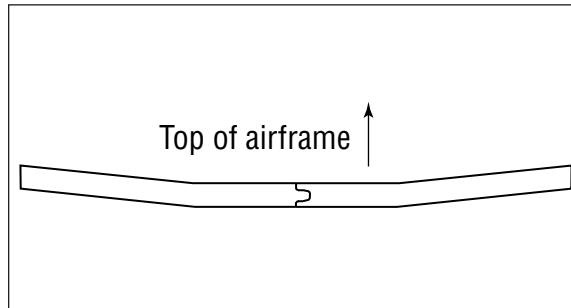

- 5. Slide the wing into position on the fuselage. Make sure to guide any wiring from the wing into the fuselage so the wing panel will rest tightly against the fuselage. Use two 1/4-20 x 2-inch nylon wing bolts to secure the wing to the fuselage.

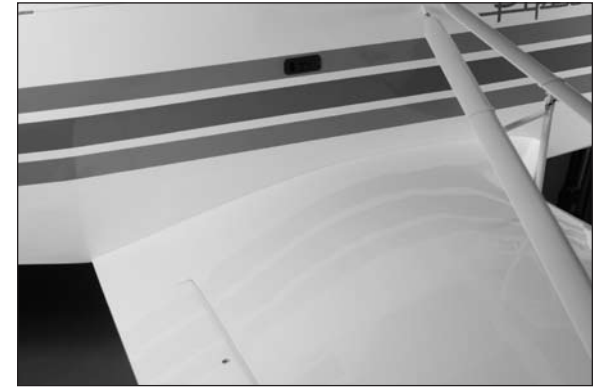

Note: Always use threadlock on metal-to-metal fasteners to prevent them from vibrating loose.

- 6. Adjust the position of the strut ends so they align with the strut attachment mount on the wing. Once the pins have been installed, place a drop of threadlock on the thread, then use a 7mm open-end wrench to tighten the 4mm nuts against the ends to secure the ends in position.



- 7. Repeat steps 2 through 6 to attach the remaining wing panel to the fuselage.

Center of Gravity

An important part of preparing the aircraft for flight is properly balancing the model.



CAUTION: Do not inadvertently skip this step!

Before balancing your model, make sure it is fully assembled and ready for flight. Balance your model with the fuel tank empty.

The recommended Center of Gravity (CG) location for your model is 8½-inch to 9-inch (216mm–229mm) located at the wing root near the fuselage. Measure back from the leading edge as shown and mark the location of the CG on the top of the wing with a felt-tipped pen.

With a helper, lift the aircraft with your index finger at the location marked on the wing. If the nose of your aircraft hangs low, add weight to the rear of the aircraft. If the tail hangs low, add weight to the nose of the aircraft. Stick-on weights are available at your local hobby store and work well for this purpose.

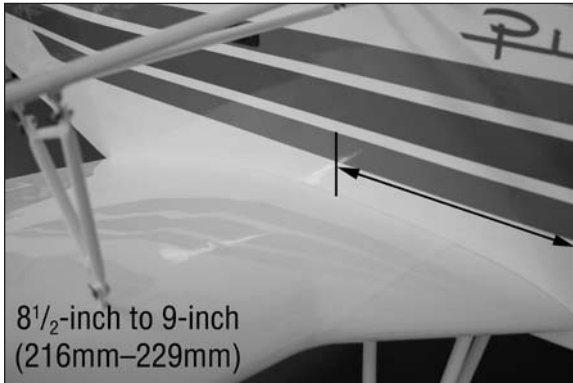

After the first flights, the CG position can be further adjusted for your personal preference.

Note: The receiver battery can be located in multiple locations in your aircraft. Although the location shown is for the installation of the recommended engine, please locate the battery in the fuselage to achieve the correct Center of Gravity without adding additional weight to your aircraft.

1. Secure a 24-inch (610mm) servo extension on the batter pack lead. Wrap the battery in foam and secure its location using a hook and loop strap.



2. Once the receiver battery has been installed, use six 2mm x 8mm sheet metal screws and a #1 Phillips screwdriver to secure the cover over the battery compartment.



Control Throws

Setting the control throws for your model does require some attention to detail. To correctly set the throws, it is highly suggested to use the following procedure to achieve the greatest mechanical advantage from your servos:

1. Determine the maximum amount of control surface throw from the throws listed. Use the high-rate throws to set the maximum amount of throw, then use your computer radio for the lower rate listed.

2. Set the Travel Adjust to about 15% under the max. (On a JR transmitter, that is 135%.) Make sure to set both directions during this process.

3. Adjust the position of the clevis on the control horn and position of the ball link on the servo arm to achieve the high rate throws listed. It is highly recommended not to change the position on the servo arm unless absolutely necessary. Use Travel Adjust (ATV) to finalize the throws (that is why we left a little margin in the percentages).

4. If setting a dual elevator or aileron, match the linkage locations. Increase or decrease the Travel Adjust (ATV) a few points as necessary to fine-tune the throws to match up left and right sides and up and down throws so all is symmetrical.

This is all necessary to tune the mechanical advantage as best as possible. When setting up your model, the mechanical advantage will be less because of the large throws, and thus, the servo will work harder and wear faster. Using an insufficient servo for the job, or trying to get too much throw, will cause something to give; probably the servo.

There isn't an exact geometry to the linkage, as it depends on how much throw each individual modeler requires. The linkage geometry should always be maximized so the servo isn't working any harder than it has to.

Aileron:*High-Rate:*

Up:	1½-inches	38mm
Down:	1-inches	26mm

Elevator:*High-Rate:*

Up:	1¾-inches	45mm
Down:	1¼-inches	32mm

Rudder:*High-Rate:*

Right:	2-inches	52mm
Left:	2-inches	52mm

Flap:

Mid:	1-inches	26mm
Full:	2-inches	52mm

These are general guidelines measured from our own flight tests. You can experiment with higher rates to match your preferred style of flying.

Travel Adjust, Sub-Trim and Dual Rates are not listed and should be adjusted according to each individual model and preference.

Note: We highly recommend re-binding the radio system once all the control throws are set. This will keep the servos from moving to their endpoints until the transmitter and receiver connect.

Preflight

For those of you who are veterans of large models, this is old news; but to you newcomers to the world of large models, this is very important information:

While many smaller models are not critical of proper battery use, and are tolerant of improper control linkage setups and flying techniques, large models are not. Don't let that scare you away from large models, however, they are truly one of the best flying experiences in RC that money can buy. Please pay particular attention to the following areas—

Maintain the proper mechanical advantage on all control surface linkages.

Just as with unsealed hinge gaps, mechanical advantage is often another cause of flutter. Please follow the control horn and servo arm lengths recommended in this manual. Shorter arms on the servo or longer control horns on the elevator and ailerons are fine, but do not try to go the other way to increase throw. It can cause flutter or servo failure on the Pawnee. The recommended linkage setups are more than adequate to achieve full 3D throws.

Check the radio installation and make sure all the control surfaces are moving correctly (i.e. the correct direction and with the recommended throws). Test run the engine and make sure it transitions smoothly from idle to full throttle and back. Also ensure the engine is tuned according to the manufacturer's instructions, and it will run consistently at full throttle when adjusted.

Check all the control horns, servo horns and clevises to make sure they are secure and in good condition. Replace any items that would be considered questionable. Failure of any of these components in flight could mean the loss of your aircraft.

Never attempt to make full-throttle dives!

Large models perform much more like full-size aircraft than small models. If the airframe goes too fast, such as in a high-throttle dive, it may fail.

Hardware checks

Double-check the setscrews in all control horns to be sure they are very tight. Periodically check these to be sure they have not loosened over time. Always use threadlock on metal-to-metal fasteners.

Receiver battery selection

Be sure adequate batteries are used to power the receiver. We recommended a minimum of 2700mAh capacity.

Range check

Always range check the radio system per the manufacturer's instructions before the initial test flight, as well as at periodically scheduled intervals.

Check the voltage of the on-board packs

ALWAYS use an expanded scale voltmeter with a 1-amp load to check the receiver battery packs and the ignition pack before each and every flight. If there is any doubt that the packs are questionable, DO NOT FLY until the packs are recharged.

Range Test Your Radio

Before each flying session, and especially with a new model, it is important to perform a range check. It is helpful to have another person available to assist during the range check. If you are using a Spektrum transmitter, please refer to your transmitter's manual for detailed instructions on the range check process.

Safety Do's and Don'ts for Pilots

- Consult local laws and ordinances before choosing a location to fly your aircraft.
- Check all control surfaces prior to each takeoff.
- Do not fly your model near spectators, parking areas or any other area that could result in injury to people or damage of property.
- Do not fly during adverse weather conditions. Poor visibility can cause disorientation and loss of control of your aircraft. Strong winds can cause similar problems.
- Do not take chances. If at any time during flight you observe any erratic or abnormal operation, land immediately and do not resume flight until the cause of the problem has been ascertained and corrected. Safety can never be taken lightly.
- Do not fly near power lines.

Daily Flight Checks

- Check the battery voltage of the transmitter battery. Do not fly below the manufacturer's recommended voltage. Doing so may cause your aircraft to crash.

When you check these batteries, ensure you have the polarities correct on your expanded scale voltmeter.

- Check all hardware (linkages, screws, nuts, and bolts) prior to each day's flight. Be sure that binding does not occur and that all parts are properly secured.
- Ensure all surfaces are moving in the proper manner.
- Perform a ground range check before each day's flying session.
- Prior to starting your aircraft, turn off your transmitter, then turn it back on. Do this each time you start your aircraft. If any critical switches are on without your knowledge, the transmitter alarm will sound a warning.
- Check that all trim levers are in the proper location.
- All servo pigtails and switch harness plugs should be secured in the receiver. Make sure the switch harness moves freely in both directions.

Flying the Hangar 9 33% Pawnee 80cc ARF

Congratulations on purchasing your H9 Pawnee! We are confident you will have a wonderful flying experience with this incredibly designed aircraft. The Pawnee has fantastic slow-speed flight characteristics, and you will enjoy using the flaps for all sorts of aerobatic flight maneuvers and shooting tons of touch and go's.

PRE FLIGHT

Make sure all strut attachments are secure. Make sure all stabilizer bolts are tight and linkages are secure. Check fuel and battery levels. Make sure cockpit doors are closed and secured properly. Once you have done your pre flight checks, you're ready to fly.

TAKE OFF

The Pawnee will take off at very low speeds. For initial flights, we recommend using full throttle for the initial climb out before reducing speed. Taxi model into the wind and do a final control check before advancing the throttle slowly. The Pawnee has a lot of development that went into the undercarriage and it is designed so that it will track fairly straight with a small amount of right rudder. Continue to advance the throttle to 100% power until flying speed is achieved. As mentioned, the Pawnee will want to fly, so be ready for it to lift off quicker than you would expect for a model this size. Once you have reached a safe altitude, reduce power settings substantially depending on which engine choice you have used. If using a 60cc engine, half-throttle will be plenty for a scale cruise. With an 80 to 100cc engine, you can fly on 1/3–1/4 power once initial climb out has been achieved. The Pawnee also has a full scale working undercarriage, so even the roughest field will be ok. In testing, many takeoffs were done on extremely rough grass fields with no problems.

LANDING

Landings are the most fun with the Pawnee. For the first few landings, we recommend landing without flaps. Slowly reduce power and position the aircraft off the end of the runway approximately 100' high and 200' out. Continue to reduce the power back to idle. The Pawnee, without flaps, will have a fairly flat approach concluded with a very slow touch down. It likes to three-point as well as wheel land. If you want a guaranteed no-bounce landing, wheel landings are better. The next step is to try the flaps. We would recommend only using the first stage to start, same approach as without flaps, except that you want to be a little closer off the end of the runway when reducing the power to idle on final approach. Now here is where the fun starts—you will notice that you can do a slightly steeper approach and touchdown speed will be even slower (about 20% slower than with no flaps). When deploying the flaps, you will notice no trim change. This is one of the characteristics of the Pawnee, so all that will happen is a slight slowing of the model when you deploy the flaps. The next landing is the full-flap approach. Again, same sort of approach as before, however, you need to be even closer on the final approach before reducing the power settings to idle. With full-flap, the Pawnee can come in real steep without increasing speed.

GENERAL FLYING

The Pawnee is a real pussy cat. In fact, it's almost like a trainer to fly. It is very difficult to stall. Some fun things to do is simulated crop dusting; flying real low to the ground with the first stage of flaps deployed. The Pawnee is also quite aerobatic. It will loop and roll and do quite a variety of other maneuvers. Spins, 4-point rolls, even rolling circles have been performed on the prototypes.

We hope you enjoy your Pawnee as much as we have when developing this great aircraft for Hangar 9.

Limited Warranty

WHAT THIS WARRANTY COVERS

Horizon Hobby, Inc. (“Horizon”) warrants to the original purchaser that the product purchased (the “Product”) will be free from defects in materials and workmanship at the date of purchase.

WHAT IS NOT COVERED

This warranty is not transferable and does not cover (i) cosmetic damage, (ii) damage due to acts of God, accident, misuse, abuse, negligence, commercial use, or due to improper use, installation, operation or maintenance, (iii) modification of or to any part of the Product, (iv) attempted service by anyone other than a Horizon Hobby authorized service center, or (v) Products not purchased from an authorized Horizon dealer.

OTHER THAN THE EXPRESS WARRANTY ABOVE, HORIZON MAKES NO OTHER WARRANTY OR REPRESENTATION, AND HEREBY DISCLAIMS ANY AND ALL IMPLIED WARRANTIES, INCLUDING, WITHOUT LIMITATION, THE IMPLIED WARRANTIES OF NON-INFRINGEMENT, MERCHANTABILITY AND FITNESS FOR A PARTICULAR PURPOSE. THE PURCHASER ACKNOWLEDGES THAT THEY ALONE HAVE DETERMINED THAT THE PRODUCT WILL SUITABLY MEET THE REQUIREMENTS OF THE PURCHASER’S INTENDED USE.

PURCHASER’S REMEDY

Horizon’s sole obligation and purchaser’s sole and exclusive remedy shall be that Horizon will, at its option, either (i) service, or (ii) replace, any Product determined by Horizon to be defective. Horizon reserves the right to inspect any and all Product(s) involved in a warranty claim. Service or replacement decisions are at the sole discretion of Horizon. Proof of purchase is required for all warranty claims. SERVICE OR REPLACEMENT AS PROVIDED UNDER THIS WARRANTY IS THE PURCHASER’S SOLE AND EXCLUSIVE REMEDY.

LIMITATION OF LIABILITY

HORIZON SHALL NOT BE LIABLE FOR SPECIAL, INDIRECT, INCIDENTAL OR CONSEQUENTIAL DAMAGES, LOSS OF PROFITS OR PRODUCTION OR COMMERCIAL LOSS IN ANY WAY, REGARDLESS OF WHETHER SUCH CLAIM IS BASED IN CONTRACT, WARRANTY, TORT, NEGLIGENCE, STRICT LIABILITY OR ANY OTHER THEORY OF LIABILITY, EVEN IF HORIZON HAS BEEN ADVISED OF THE POSSIBILITY OF SUCH DAMAGES. Further, in no event shall the liability of Horizon exceed the individual price of the Product on which liability is asserted. As Horizon has no control over use, setup, final assembly, modification or misuse, no liability shall be assumed nor accepted for any resulting damage or injury. By the act of use, setup or assembly, the user accepts all resulting liability. If you as the purchaser or user are not prepared to accept the liability associated with the use of the Product, purchaser is advised to return the Product immediately in new and unused condition to the place of purchase.

LAW

These terms are governed by Illinois law (without regard to conflict of law principals). This warranty gives you specific legal rights, and you may also have other rights which vary from state to state. Horizon reserves the right to change or modify this warranty at any time without notice.

Warranty Services

QUESTIONS, ASSISTANCE, AND SERVICES

Your local hobby store and/or place of purchase cannot provide warranty support or service. Once assembly, setup or use of the Product has been started, you must contact Horizon directly. This will enable Horizon to better answer your questions and service you in the event that you may need any assistance. For questions or assistance, please direct your email to productsupport@horizonhobby.com, or call 877.504.0233 toll free to speak to a Product Support representative. You may also find information on our website at www.horizonhobby.com.

INSPECTION OR SERVICES

If this Product needs to be inspected or serviced, please use the Horizon Online Service Request submission process found on our website or call Horizon to obtain a Return Merchandise Authorization (RMA) number. Pack the Product securely using a shipping carton. Please note that original boxes may be included, but are not designed to withstand the rigors of shipping without additional protection. Ship via a carrier that provides tracking and insurance for lost or damaged parcels, as Horizon is not responsible for merchandise until it arrives and is accepted at our facility. An Online Service Request is available at <http://www.horizonhobby.com> under the Support tab. If you do not have internet access, please contact Horizon Product Support to obtain a RMA number along with instructions for submitting your product for service. When calling Horizon, you will be asked to provide your complete name, street address, email address and phone number where you can be reached during business hours. When sending product into Horizon, please include your RMA number, a list of the included items, and a brief summary of the problem. A copy of your original sales receipt must be included for warranty consideration. Be sure your name, address, and RMA number are clearly written on the outside of the shipping carton.

Notice: Do not ship Li-Po batteries to Horizon. If you have any issue with a Li-Po battery, please contact the appropriate Horizon Product Support office.

WARRANTY REQUIREMENTS

For Warranty consideration, you must include your original sales receipt verifying the proof-of-purchase date. Provided warranty conditions have been met, your Product will be serviced or replaced free of charge. Service or replacement decisions are at the sole discretion of Horizon.

NON-WARRANTY SERVICE

Should your service not be covered by warranty service will be completed and payment will be required without notification or estimate of the expense unless the expense exceeds 50% of the retail purchase cost. By submitting the item for service, you are agreeing to payment of the service without notification. Service estimates are available upon request. You must include this request with your item submitted for service. Non-warranty service estimates will be billed a minimum of ½ hour of labor. In addition, you will be billed for return freight. Horizon accepts money orders and cashiers checks, as well as Visa, MasterCard, American Express, and Discover cards. By submitting any item to Horizon for service, you are agreeing to Horizon's Terms and Conditions found on our website <http://www.horizonhobby.com/Service/Request/>.

UNITED STATES

(Electronics and engines)

Horizon Service Center
4105 Fieldstone Rd
Champaign, Illinois
61822 USA

productsupport@horizonhobby.com
877-504-0233

Online Repair Request visit:
www.horizonhobby.com/repairs

(All other products)

Horizon Product Support
4105 Fieldstone Rd
Champaign, Illinois
61822 USA

productsupport@horizonhobby.com
877-504-0233

UNITED KINGDOM

Horizon Hobby Limited
Units 1-4 Ployters Rd
Staple Tye
Harlow, Essex
CM18 7NS
United Kingdom
sales@horizonhobby.co.uk
+44 (0) 1279 641 097

GERMANY

Horizon Technischer Service
Hamburger Str. 10
25335 Elmshorn
Germany
service@horizonhobby.de
+49 4121 46199 66

FRANCE

Horizon Hobby SAS
14 Rue Gustave Eiffel
Zone d'Activité du Réveil Matin
91230 Montgeron
+33 (0) 1 60 47 44 70

Compliance Information for the European Union



INSTRUCTIONS FOR DISPOSAL OF WEEE BY USERS IN THE EUROPEAN UNION

This product must not be disposed of with other waste. Instead, it is the user's responsibility to dispose of their waste equipment by handing it over to a designated collection point for the recycling of waste electrical and electronic equipment. The separate collection and recycling of your waste equipment at the time of disposal will help to conserve natural resources and ensure that it is recycled in a manner that protects human health and the environment. For more information about where you can drop off your waste equipment for recycling, please contact your local city office, your household waste disposal service or where you purchased the product.

Academy of Model Aeronautics National Model Aircraft Safety Code

Effective January 1, 2011

A. GENERAL

A model aircraft is a non-human-carrying aircraft capable of sustained flight in the atmosphere. It may not exceed limitations of this code and is intended exclusively for sport, recreation and/or competition. All model flights must be conducted in accordance with this safety code and any additional rules specific to the flying site.

1. Model aircraft will not be flown:
 - (a) In a careless or reckless manner.
 - (b) At a location where model aircraft activities are prohibited.
2. Model aircraft pilots will:
 - (a) Yield the right of way to all man-carrying aircraft.
 - (b) See and avoid all aircraft and a spotter must be used when appropriate. (AMA Document #540-D-See and Avoid Guidance.)
 - (c) Not fly higher than approximately 400 feet above ground level within three (3) miles of an airport, without notifying the airport operator.
 - (d) Not interfere with operations and traffic patterns at any airport, heliport or seaplane base except where there is a mixed use agreement.
 - (e) Not exceed a takeoff weight, including fuel, of 55 pounds unless in compliance with the AMA Large Model Aircraft program. (AMA Document 520-A)
 - (f) Ensure the aircraft is identified with the name and address or AMA number of the owner on the inside or affixed to the outside of the model aircraft. (This does not apply to model aircraft flown indoors).
 - (g) Not operate aircraft with metal-blade propellers or with gaseous boosts except for helicopters operated under the provisions of AMA Document #555.
 - (h) Not operate model aircraft while under the influence of alcohol or while using any drug which could adversely affect the pilot's ability to safely control the model.
 - (i) Not operate model aircraft carrying pyrotechnic devices which explode or burn, or any device which propels a projectile or drops any object that creates a hazard to persons or property.

Exceptions:

- Free Flight fuses or devices that burn producing smoke and are securely attached to the model aircraft during flight.

- Rocket motors (using solid propellant) up to a G-series size may be used provided they remain attached to the model during flight. Model rockets may be flown in accordance with the National Model Rocketry Safety Code but may not be launched from model aircraft.
- Officially designated AMA Air Show Teams (AST) are authorized to use devices and practices as defined within the Team AMA Program Document (AMA Document #718).
 - (j) Not operate a turbine-powered aircraft, unless in compliance with the AMA turbine regulations. (AMA Document #510-A).
- 3. Model aircraft will not be flown in AMA sanctioned events, air shows or model demonstrations unless:
 - (a) The aircraft, control system and pilot skills have successfully demonstrated all maneuvers intended or anticipated prior to the specific event.
 - (b) An inexperienced pilot is assisted by an experienced pilot.
- 4. When and where required by rule, helmets must be properly worn and fastened. They must be OSHA, DOT, ANSI, SNELL or NOCSAE approved or comply with comparable standards.

B. RADIO CONTROL (RC)

1. All pilots shall avoid flying directly over unprotected people, vessels, vehicles or structures and shall avoid endangerment of life and property of others.
2. A successful radio equipment ground-range check in accordance with manufacturer's recommendations will be completed before the first flight of a new or repaired model aircraft.
3. At all flying sites a safety line(s) must be established in front of which all flying takes place (AMA Document #706-Recommended Field Layout):
 - (a) Only personnel associated with flying the model aircraft are allowed at or in front of the safety line.
 - (b) At air shows or demonstrations, a straight safety line must be established.
 - (c) An area away from the safety line must be maintained for spectators.
 - (d) Intentional flying behind the safety line is prohibited.
4. RC model aircraft must use the radio-control frequencies currently allowed by the Federal Communications Commission (FCC). Only individuals properly licensed by the FCC are authorized to operate equipment on Amateur Band frequencies.
5. RC model aircraft will not operate within three (3) miles of any pre-existing flying site without a frequency-management agreement (AMA Documents #922- Testing for RF Interference; #923- Frequency Management Agreement)

6. With the exception of events flown under official AMA Competition Regulations, excluding takeoff and landing, no powered model may be flown outdoors closer than 25 feet to any individual, except for the pilot and the pilot's helper(s) located at the flight line.
7. Under no circumstances may a pilot or other person touch a model aircraft in flight while it is still under power, except to divert it from striking an individual. This does not apply to model aircraft flown indoors.
8. RC night flying requires a lighting system providing the pilot with a clear view of the model's attitude and orientation at all times.
9. The pilot of a RC model aircraft shall:
 - (a) Maintain control during the entire flight, maintaining visual contact without enhancement other than by corrective lenses prescribed for the pilot.
 - (b) Fly using the assistance of a camera or First-Person View (FPV) only in accordance with the procedures outlined in AMA Document #550.

C. FREE FLIGHT

1. Must be at least 100 feet downwind of spectators and automobile parking when the model aircraft is launched.
2. Launch area must be clear of all individuals except mechanics, officials, and other fliers.
3. An effective device will be used to extinguish any fuse on the model aircraft after the fuse has completed its function.

D. CONTROL LINE

1. The complete control system (including the safety thong where applicable) must have an inspection and pull test prior to flying.
2. The pull test will be in accordance with the current Competition Regulations for the applicable model aircraft category.
3. Model aircraft not fitting a specific category shall use those pull-test requirements as indicated for Control Line Precision Aerobatics.
4. The flying area must be clear of all utility wires or poles and a model aircraft will not be flown closer than 50 feet to any above-ground electric utility lines.
5. The flying area must be clear of all nonessential participants and spectators before the engine is started.



© 2011 Horizon Hobby, Inc.
horizonhobby.com
Hangar9.com

*The Spektrum trademark is used with permission of Bachmann Industries, Inc.
Hangar 9, UltraCote, Evolution, and JR are trademarks or registered
trademarks of Horizon Hobby, Inc.
All other trademarks, service marks and logos are the property of their respective owners.*