



3651 N. Hwy 89  
Chino Valley, AZ 86323  
(928) 636-7080 • www.p-a-g.net

## DODGE DAKOTA 3" BODY LIFT INSTALLATION INSTRUCTIONS 2003-04 KIT # 60153

### ⚠ WARNING

Installation of a Performance Automotive Group body lift kit will change the vehicle's center of gravity and handling characteristics both on- and off-road. You must drive the vehicle safely! Extreme care must be taken to prevent vehicle rollover or loss of control, which could result in serious injury or death. Avoid sudden sharp turns or abrupt maneuvers and always make sure all vehicle occupants have their seat belts fastened.

### ⚠ WARNING

Before you install this kit, read and understand all instructions, warnings, cautions, and notes in this instruction sheet and in the vehicle owner's manual.

### ⚠ CAUTION

Proper installation of this kit requires knowledge of the factory recommended procedures for removal and installation of original equipment components. We recommend that the factory shop manual and any special tools needed to service your vehicle be on hand during the installation. Installation of this kit without proper knowledge of the factory recommended procedures may affect the performance of these components and the safety of the vehicle. We strongly recommend that a certified mechanic familiar with the installation of similar components install this kit.

### ⚠ WARNING

This kit should only be installed on a vehicle that is in good working condition. Before you install the kit, thoroughly inspect the vehicle for corrosion or deformation of the sheet metal around the factory body mounts. If the vehicle is suspected to have been in a collision or misused, do not install this kit. Off-road use of your vehicle with this kit installed may increase the stress applied to the factory body mounts. We do not recommend that any vehicle with a body lift kit installed be involved in any extreme off-road maneuvers such as jumping. Failure to observe this warning may result in serious personal injury and/or severe damage to your vehicle.

### ⚠ WARNING

Many states and municipalities have laws restricting bumper heights and vehicle lifts. Consult state and local laws to determine if the changes you intend to make to the vehicle comply with the law. Before combining a body lift with a suspension lift, consult an installation professional to see how this will affect the vehicle.

### ⚠ WARNING

The installation of larger tires may reduce the effectiveness of the Braking System.

### ⚠ WARNING

Always wear eye protection when operating power tools.

### ⚠ WARNING

Before you install this kit, block the vehicle tires to prevent the vehicle from rolling.

### ⚠ WARNING

Accidental deployment of the air bag can result in serious personal injury or death. To avoid accidental deployment during installation of the kit, the Supplemental Restraint System (SRS, or airbag) must remain deactivated. Do not allow anyone near the airbag during installation. Refer to the factory service manual or owner's manual for the recommended procedure to disable the SRS. After you install the kit, reactivate the SRS before driving the vehicle.

### ⚠ NOTE

Performance Automotive Group recommends using the Loctite® supplied in the kit on the threads of all kit nuts and bolts unless specified otherwise in these instructions.

# Before Starting Installation

## ⚠ NOTE

Kit parts are prefaced by the word **kit** and appear in **bold** print.

1. Carefully read all warnings and instructions completely before beginning.
2. Verify all parts have been received in this kit by checking the parts list at the end of this document.

## ⚠ NOTE

If parts are missing from kit, please be prepared to provide the following information:

1. **Name** of purchase location
  2. **Bar Code** on side of box
  3. **Date** above bar code
  4. **Date** inside box cover
  5. **Inspector #** from inside box cover
3. **Only install this kit on the vehicle for which it is specified.** If anytime during the installation you encounter something different from what is outlined in the instructions, call technical support at (928) 636-7080.
  4. Special tools needed:
    - a. Welder or access to a professional welding shop.

## ⚠ NOTE

On automatic transmission with short bed, no welding is required. On automatic transmission with long bed, welding is required, but the vehicle can be driven and the kit **spacers** (bed) can be welded onto the frame later. On manual transmission, before the vehicle can be driven, the kit **extension** (manual transmission shift lever) must be welded to the shift lever.

- b. Die grinder or similar tool capable of cutting thick plastic (lower fan shroud).
5. Park the vehicle on a clean, dry, flat, level surface and block the tires so the vehicle cannot roll in either direction.

## Measurements

1. Measure and record distance between front bumper and fenders.

Driver Side \_\_\_\_\_ Passenger Side \_\_\_\_\_

2. Measure and record distance between cab and bed.

Driver Side \_\_\_\_\_ Passenger Side \_\_\_\_\_

3. Measure and record distance between rear bumper and bed.

Driver Side \_\_\_\_\_ Passenger Side \_\_\_\_\_

## Engine Compartment

1. Battery Cables

- a. Disconnect both battery cables. Disconnect negative cable first, then positive cable.

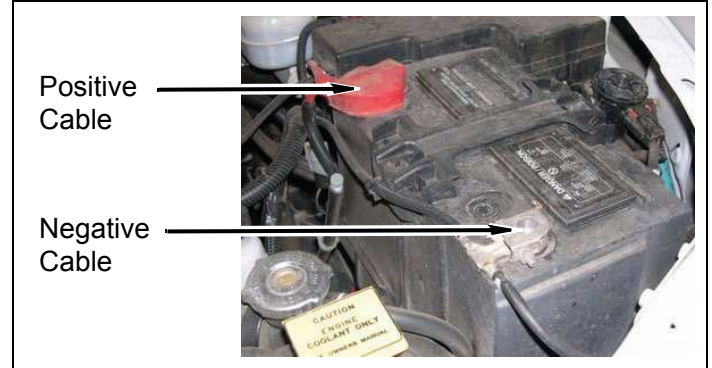

## Inside Cab

1. Airbag Fuse

## ⚠ NOTE

The location of the airbag fuse(s) may vary; check the owner's manual.

- a. Remove fuse box cover from end of dash.

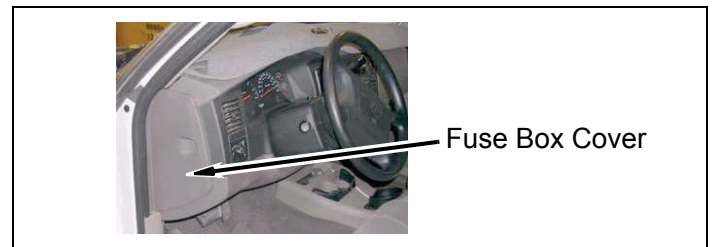

- b. Remove two airbag fuses (20 and 21) from fuse box.

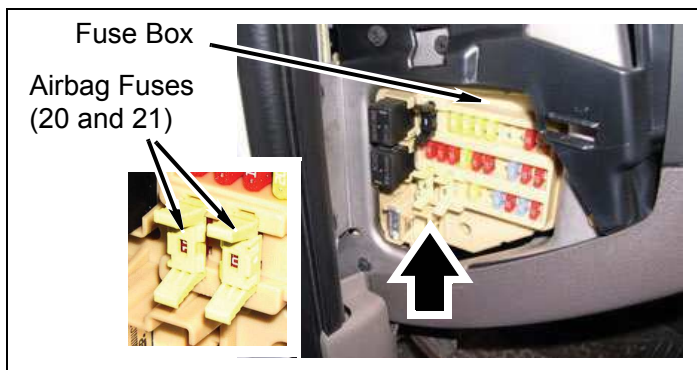

- c. Remove four bolts and two front bumper side braces from frame.

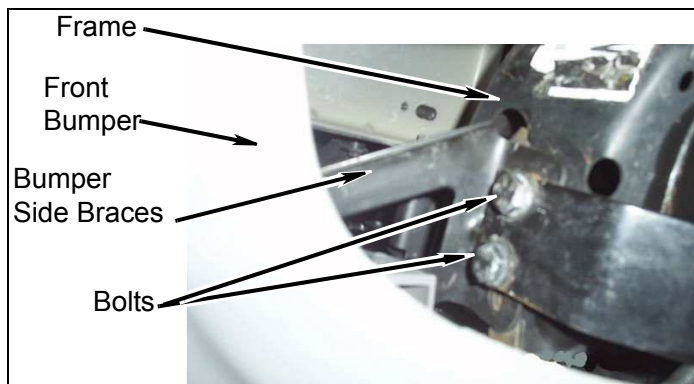

## Prepare to Install Kit

### Front of Vehicle

#### 1. Front Bumper

- a. Remove seven push pins and splash shield from core support and crossmember.

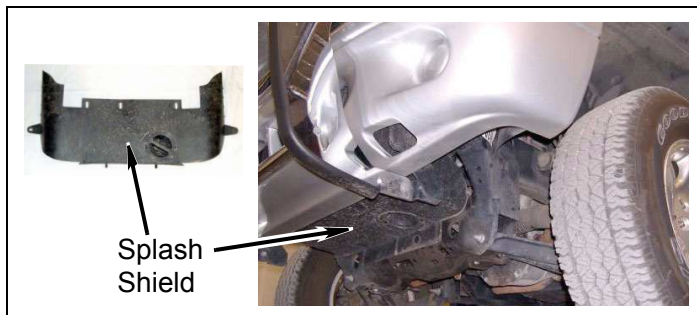

- b. If equipped, disconnect wire harness connectors from driving lights.

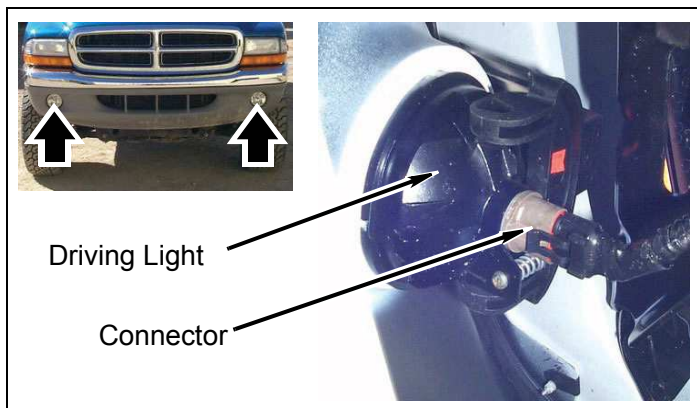

- d. Remove four push pins and rubber cover from core support.

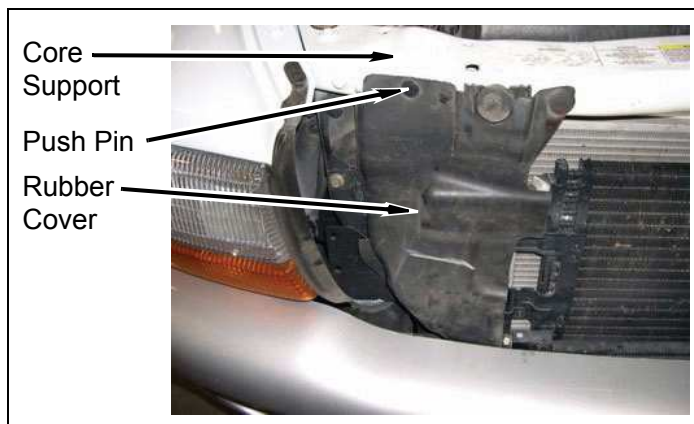

- e. Remove four bolts and front bumper from frame.

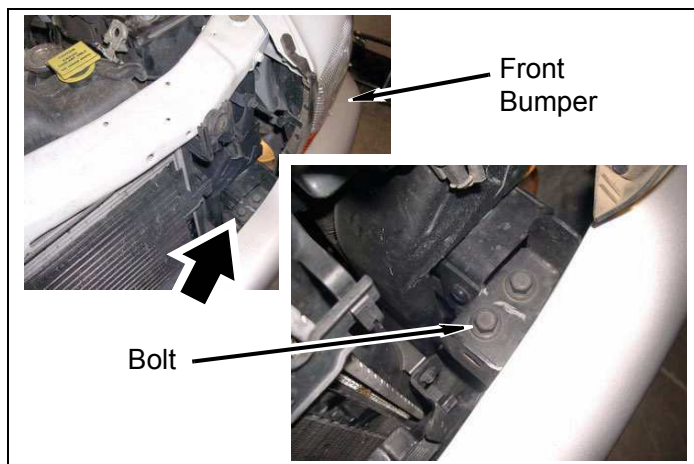

### Engine Compartment

#### 1. Fan Shroud

**⚠ WARNING**

If the engine cooling system is hot, the coolant will be HOT and UNDER PRESSURE. To prevent serious personal injury, wait until the cooling system is completely cool before removing the radiator cap.

a. Remove radiator cap.

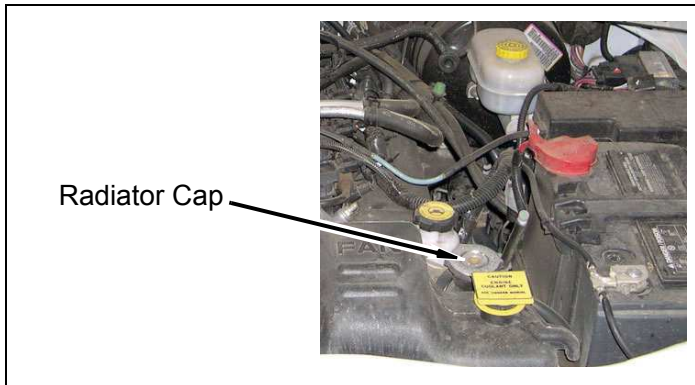

b. Drain radiator into a clean container.



c. Disconnect wiring harness connector from washer fluid pump.

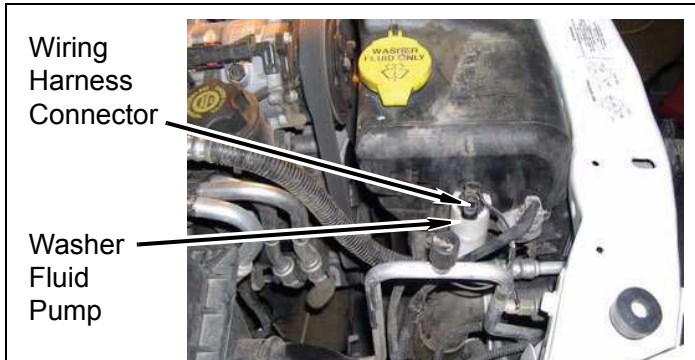

d. Disconnect hose from washer fluid pump. Cap the hose nipple.

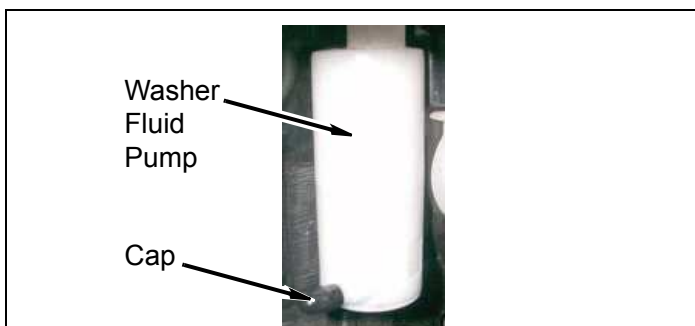

e. Disconnect wiring harness connector from washer fluid sensor.

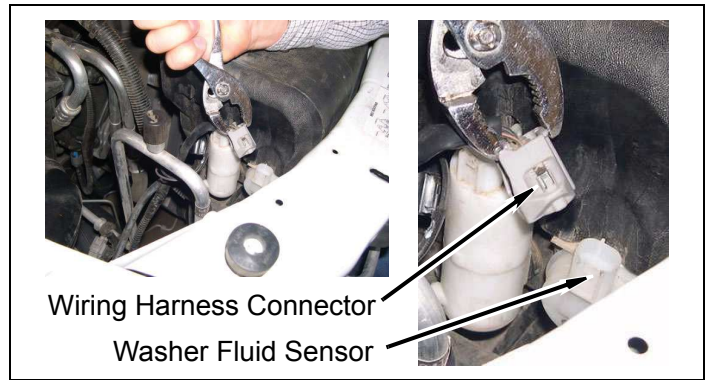

f. Remove seven wire harness clips and wire harness from core support below fan shroud.

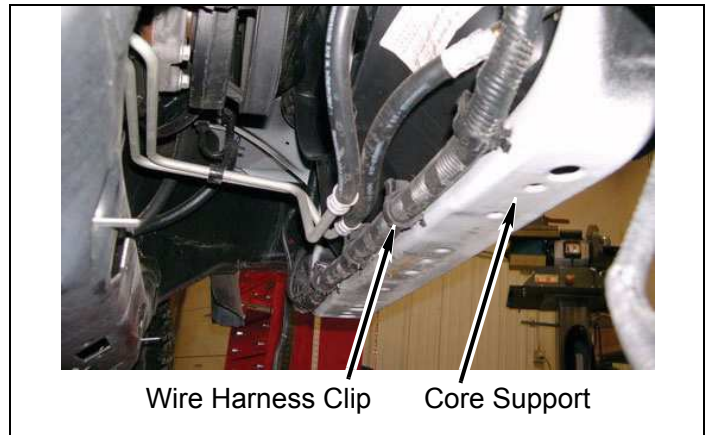

g. Disconnect coolant overflow hose from nipple below radiator cap.

h. Disconnect upper radiator hose from engine.

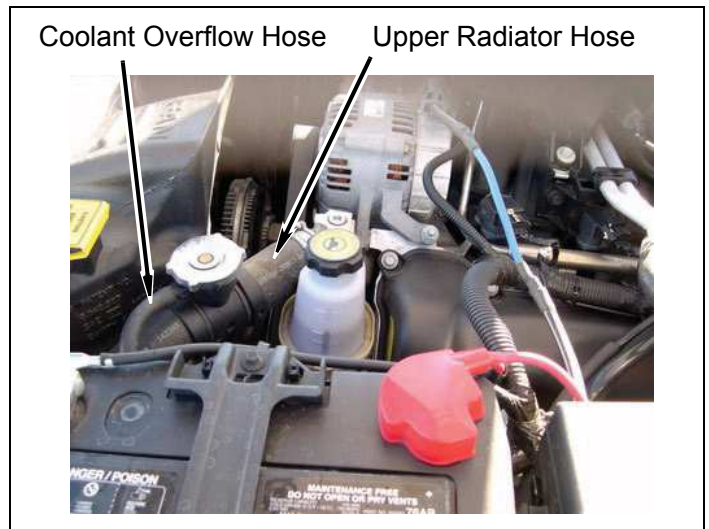

- i. Remove two bolts holding upper fan shroud to radiator.

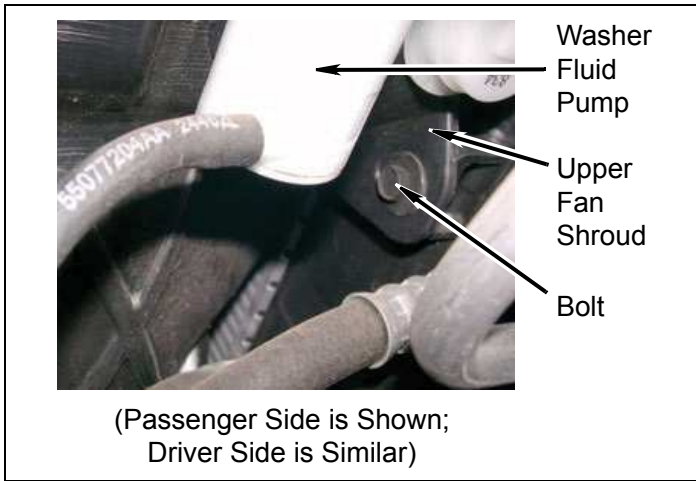

- j. Remove upper fan shroud from engine compartment.



- k. Remove four bolts holding fan to fan clutch. Move fan toward engine and let it rest on water pump shaft.

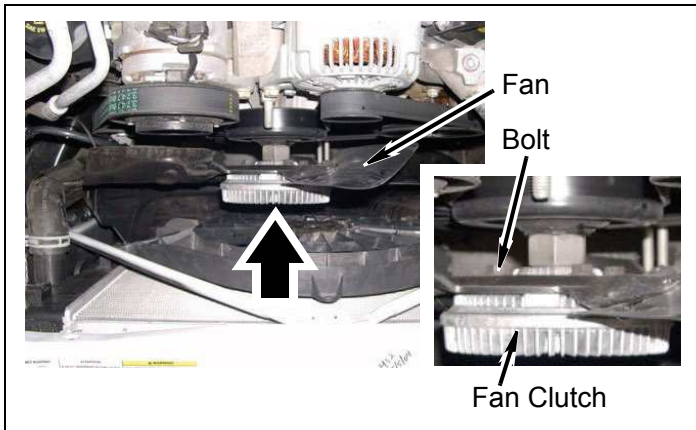

- l. Write the letter "R" on lower radiator hose where it is connected to radiator.

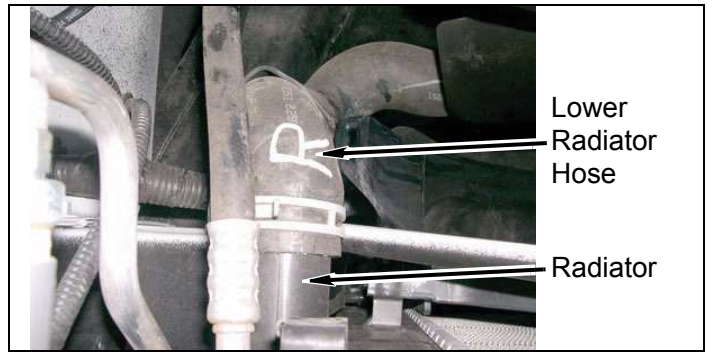

- m. Squeeze two clamps and remove lower radiator hose.



- n. Remove wiring harness connector from lower fan shroud.

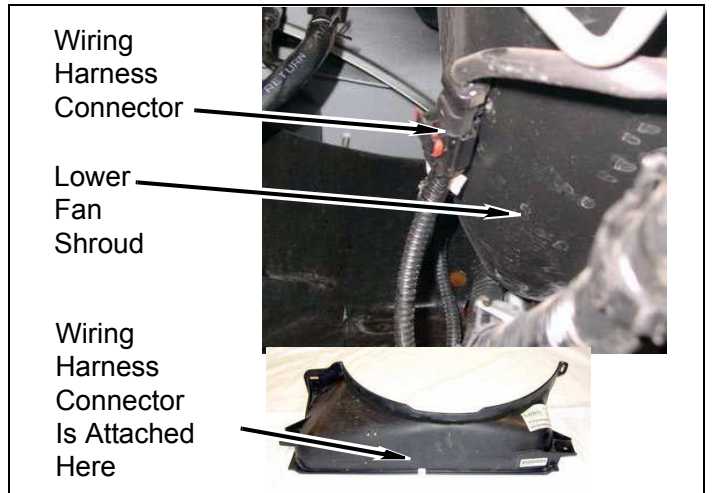

- o. Remove two bolts from lower fan shroud and radiator. Remove lower fan shroud from engine compartment.

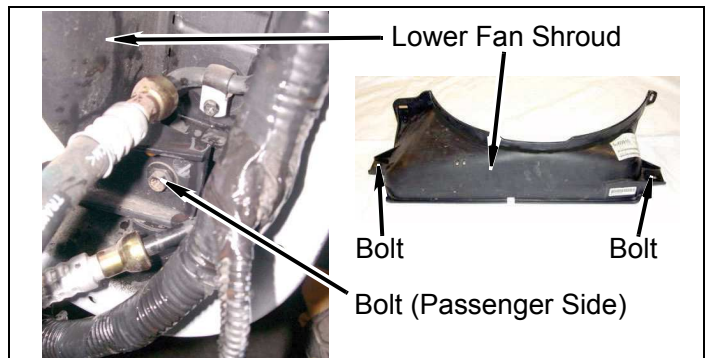

## 2. Air Filter Cover and Hose

- a. Loosen clamp and disconnect intake air hose from intake air box.

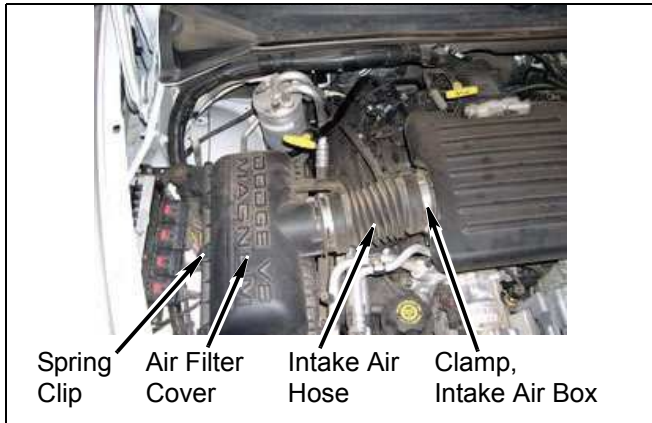

- b. Release spring clips holding air filter cover to air filter box.
- c. Slide air filter cover toward front of vehicle to release it from hook. Remove cover and hose as an assembly.

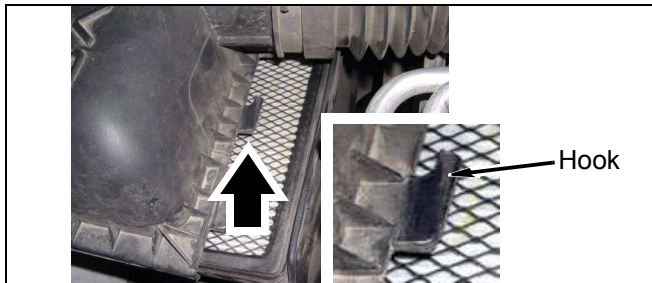

## 3. Ground Wires

- a. **Driver Side:** Remove nut and ground wire from stud on firewall.



- b. **Passenger Side:** Remove nut and ground wires from stud on firewall.

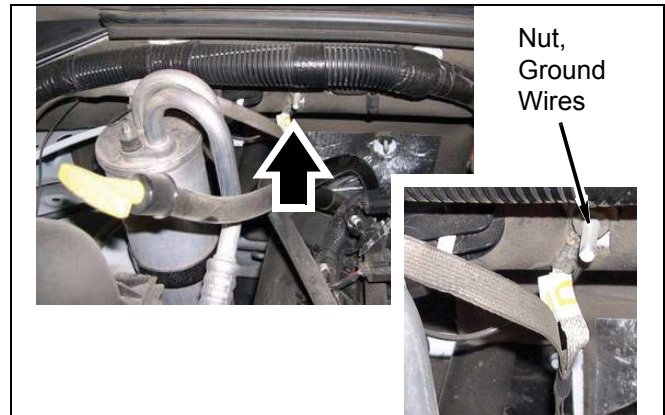

## 4. Wire Harness

- a. Remove wire harness from stud on driver side valve cover bolt.

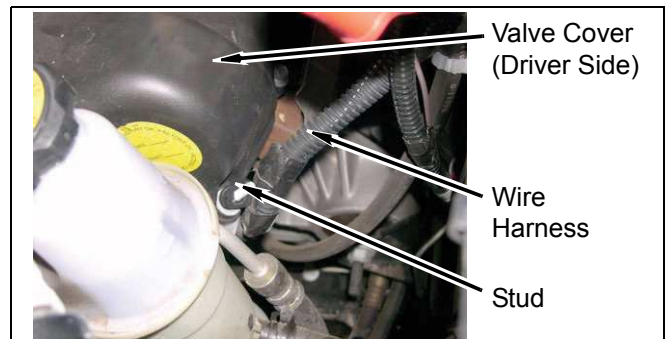

## 5. Steering Shaft

### ⚠ WARNING

Accidental deployment of the air bag can result in serious personal injury or death. To avoid accidental deployment during installation of the lift kit, the Supplemental Restraint System (SRS, or airbag) must remain deactivated. Do not allow anyone near the airbag during installation. Refer to the factory service manual or owner's manual for the recommended procedure to disable the SRS. After kit installation, the SRS must be reactivated before driving the vehicle.

### ⚠ CAUTION

If the following step is not performed, the airbag clock-spring could be damaged. Do not turn the steering wheel while the steering shaft is disconnected.

- a. Strap steering wheel to prevent accidental movement.
- b. Remove bolt from "U"-joint at upper steering shaft below brake booster.

c. Pull "U"-joint off upper steering shaft.

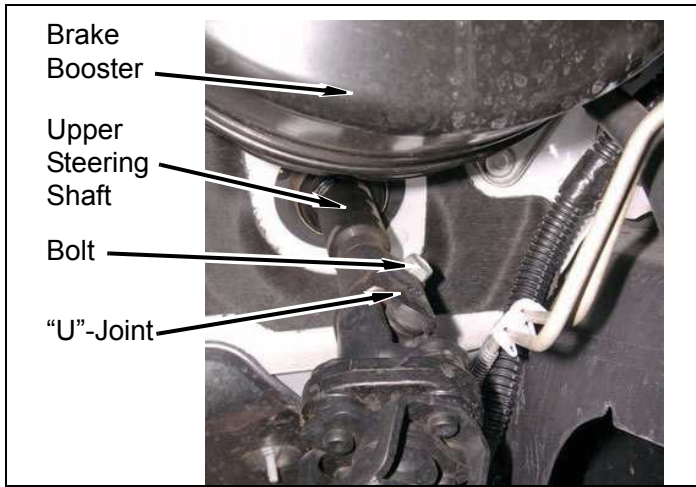

b. Remove plastic clip holding brake lines to frame. Leave brake lines attached to plastic clip for support.

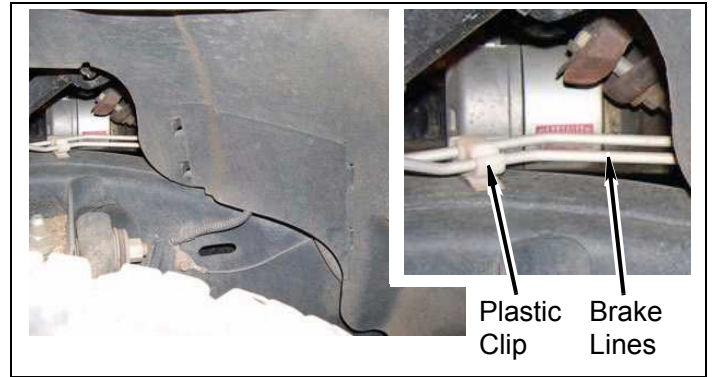

**6. Automatic Transmission: Shift Cable**

a. Remove clip securing automatic transmission shift cable to frame near steering shaft.

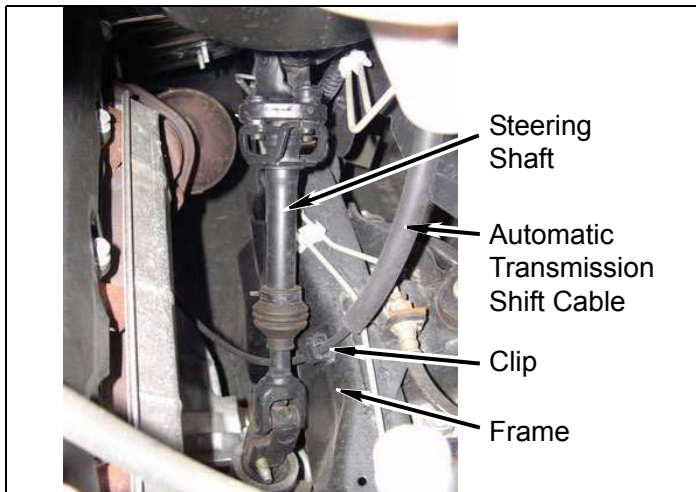

c. Remove bolt and brake line bracket from frame.



d. Remove two bolts and brake distribution block bracket from frame.



**7. Brake Lines**

a. Remove plastic cover from inner front fender.

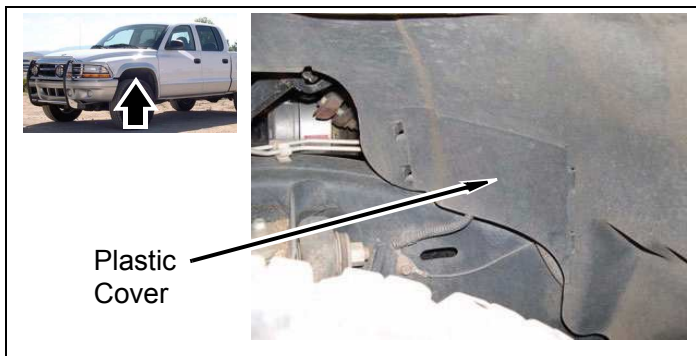

**8. Ground Wires**

a. Remove bolt and ground wires from frame.



**9. Wire Harness**

- a. Remove wire harness clip from driver side frame.

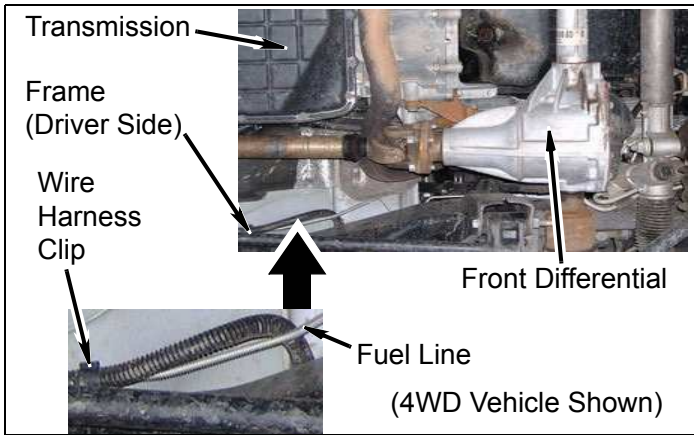

**Inside Cab**

**1. Manual Transmission: Shift Lever**

- a. Remove screws and upper shift boot from shift console. Lift upper shift boot out of way.

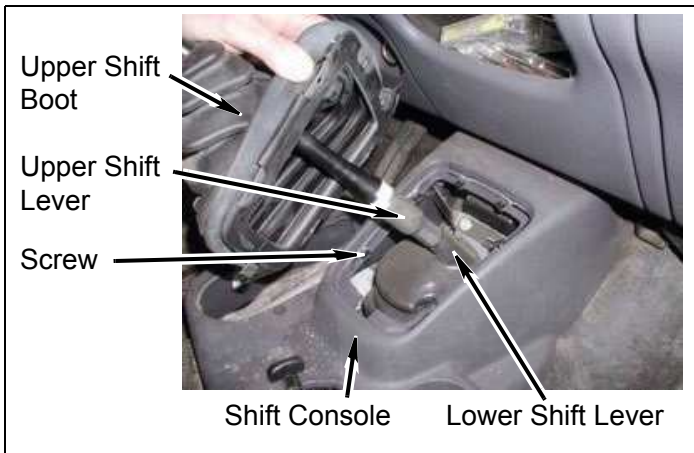

- b. Remove upper shift lever from lower shift lever. Set aside the upper shift lever and upper boot.

- c. Remove screws and shift console from floor.

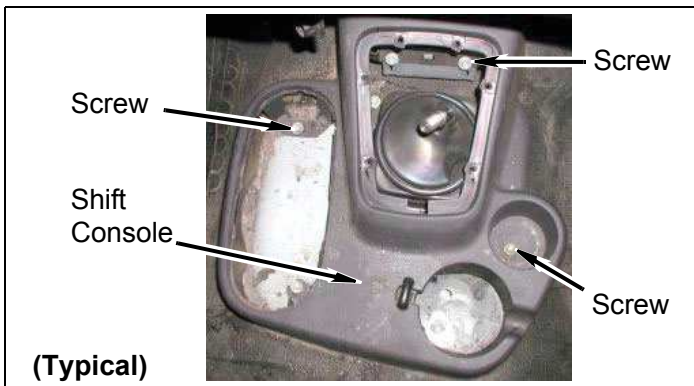

- d. Remove six screws and the lower shift boot from floor.

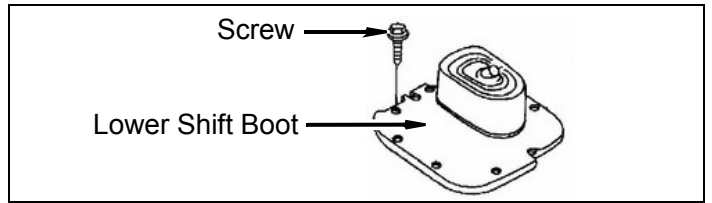

**Rear of Vehicle**

**1. Fuel Filler**

**⚠ WARNING**  
 Use extreme caution when working near fuel lines and fuel tank. Clean up spilled fuel immediately. A spark could cause an explosion or fire resulting in serious personal injury and property damage.

- a. Remove gas cap.
- b. Remove three torx screws from bed and fuel filler neck.
- c. Bend two metal tabs upward. Rotate fuel filler neck and let it drop down through hole.

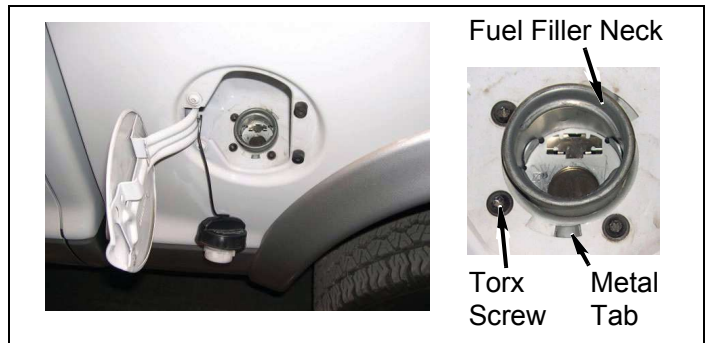

**2. Spare Tire**

- a. Lower spare tire to ground (refer to owner's manual).
- b. Remove cotter pin and crank rod from winch..

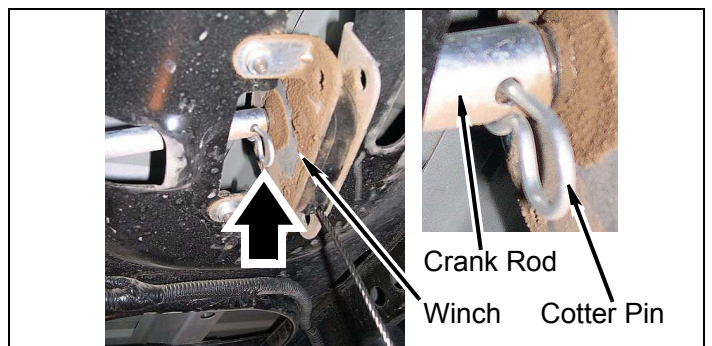



### 3. Rear Bumper

- a. Disconnect wiring harness connector for license plate lights.



Wiring Harness Connector for License Plate Lights

- b. Remove six bolts, nuts, and rear bumper from frame.

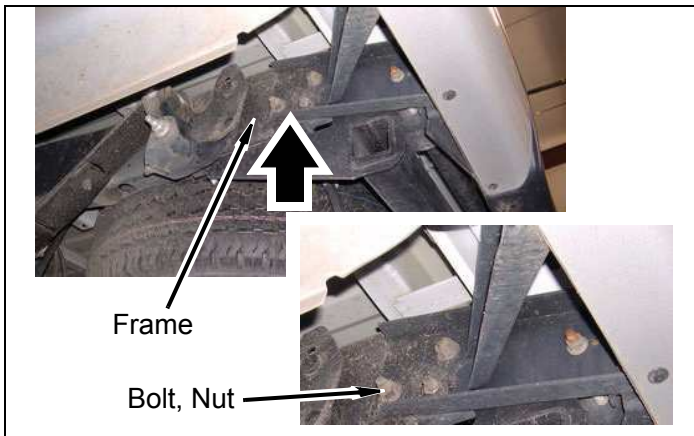

Frame

Bolt, Nut

- b. Slide bed rearward a few inches to prevent contact between cab and bed during lifting.

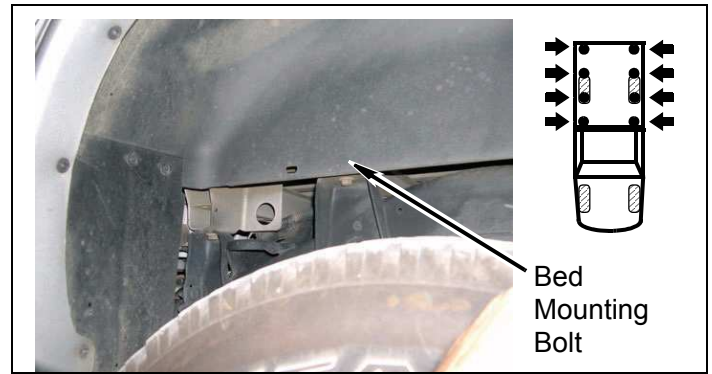

Bed Mounting Bolt

### Cab

#### 1. Lift Cab

- a. Loosen, but DO NOT remove, cab mounting bolt from core support mount on driver side.

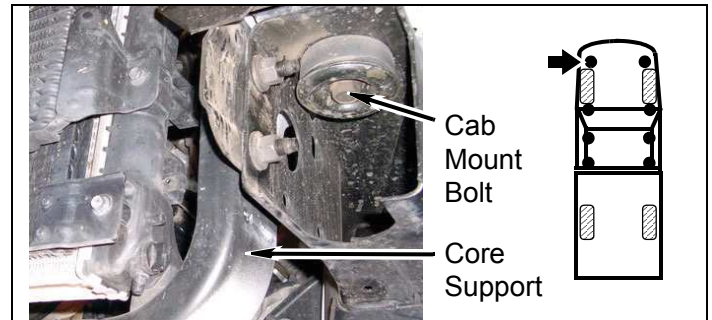

Cab Mount Bolt

Core Support

- b. Loosen, but DO NOT remove, remaining cab mounting bolts on driver side (two bolts on vehicles with regular cab; three bolts on vehicles with extended and crew cab).

## Install Kit

### Rear of Vehicle

#### 1. Bed

- a. Remove bed mounting bolts (six bolts on vehicles with short bed; eight bolts on vehicles with long bed).

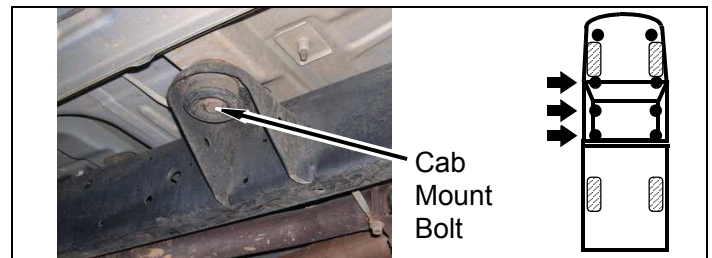

Cab Mount Bolt

- c. Remove bolt and lower bushing from each cab mount on passenger side.

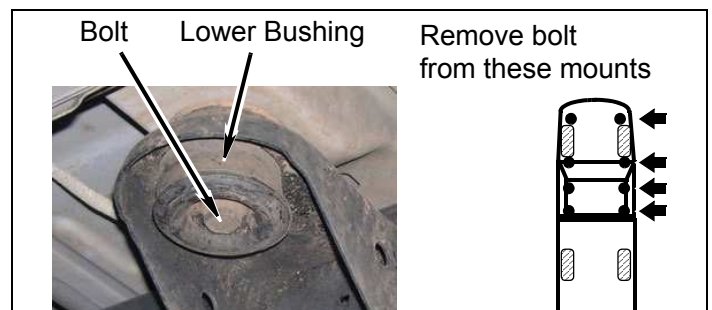

Bolt Lower Bushing

Remove bolt from these mounts

**⚠ WARNING**

Use extreme caution when lifting body from frame. To prevent serious personal injury, ensure the lifting device is securely placed. Keep your hands out from between the body and frame.

**⚠ CAUTION**

Before lifting the body, close the doors to prevent the body from flexing. When lifting the body, continually check hoses, wires, lines, etc. to be sure that everything is flexing properly and not binding, or damage to the vehicle could result. Be especially careful of the A/C hoses at the firewall and core support. Ensure brake lines stretch while lifting. Bending the lines to gain ample slack may be necessary. Be extremely careful not to kink the lines.

2. Cab Passenger Side

- a. Using a hydraulic jack and a wooden block (under the body seam, inboard of the rocker panel), slowly lift passenger side of cab a little more than 3".

**⚠ WARNING**

The kit **blocks** must be installed in addition to the factory upper and lower bushings. Installing the kit **blocks** without the factory upper and lower bushings could result in damage to the vehicle or serious personal injury.

- b. Install a kit **block** (3" height x 3" diameter) on upper bushing at each cab mount.

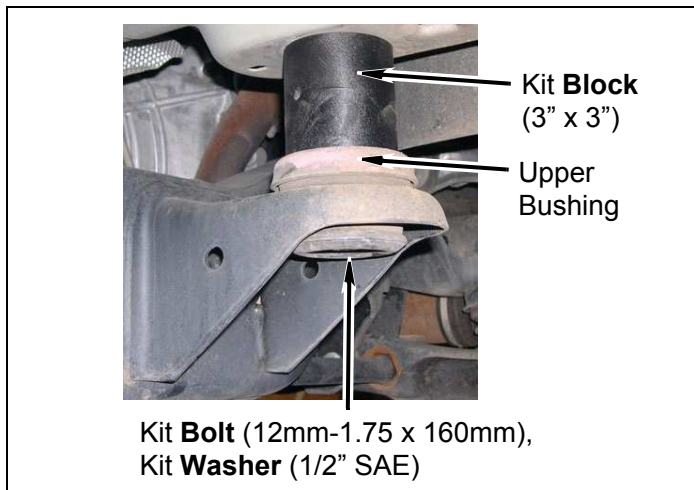

- c. Lower cab onto kit **blocks**.
- d. Install a kit **bolt** (12mm-1.75 x 160mm) at each cab mount. DO NOT tighten.

3. Cab Driver Side

- a. Repeat previous steps on driver side of cab.
- b. Remove each kit **bolt**, one at a time, and apply a few drops of Loctite® to threads. Install kit **bolt**, kit **washer** (1/2" SAE), and lower bushing. Tighten kit **bolt** to 55 lb.-ft.

**Bed**

1. Lift Bed

**⚠ WARNING**

Use extreme caution when lifting the bed from the frame. To prevent serious personal injury, ensure the lifting device is securely placed. Keep your hands out from between the bed and frame.

**⚠ CAUTION**

To prevent damage to the vehicle while lifting the bed, continually check hoses, wires, brake lines, etc. to ensure everything is flexing properly and not binding. Ensure clearance between bed and cab is maintained.

- a. Slowly lift both sides of bed a little more than 3" and install a kit **block** at each mount. At the two rearmost mounts, install a 2" diameter kit **block**. At all other mounts, install a 3" diameter kit **block**.

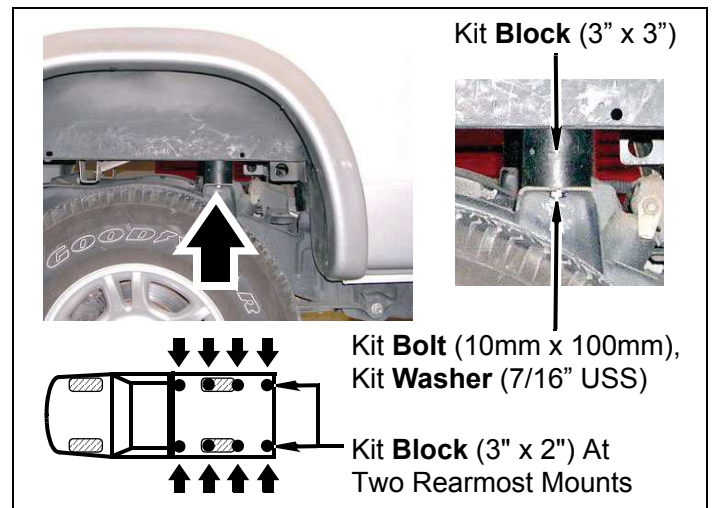

- b. Lower bed onto kit **blocks**.
- c. At each bed mount, install a kit **bolt** (10mm x 100mm). DO NOT tighten.
- d. Set bed-to-cab spacing according to previous measurement.

- e. Remove each kit **bolt**, one at a time, and apply a few drops of Loctite® to threads. Install kit **bolt** with kit **washer** (7/16" USS). Tighten kit **bolt** to 35 lb.-ft.

## Rear of Vehicle

### 1. Spare Tire Winch

- a. Remove two bolts and spare tire winch from mounting plate.

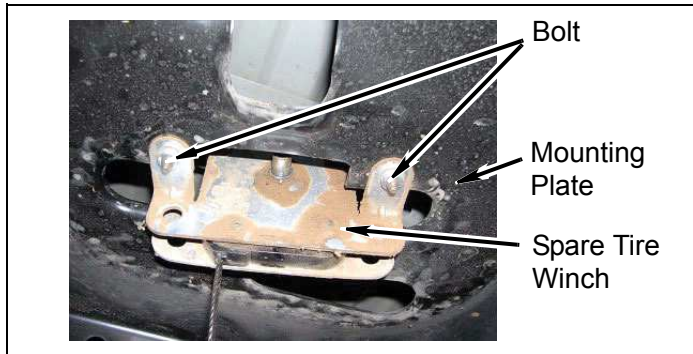

- b. Install spare tire winch on mounting plate with two kit **spacers**, two kit **bolts** (8mm x 30mm), and two kit **washers** (8mm).

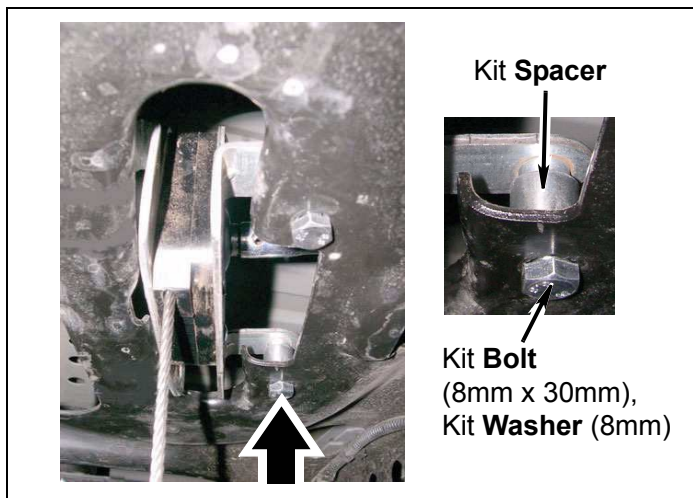

- c. Set kit **brackets** ("L"-shaped) against mounting plate and spare tire winch. Move kit **brackets** away from spare tire winch about 1/8". Using kit **brackets** as a template, mark mounting plate.

- d. Drill 5/16" holes in mounting plate where marked.

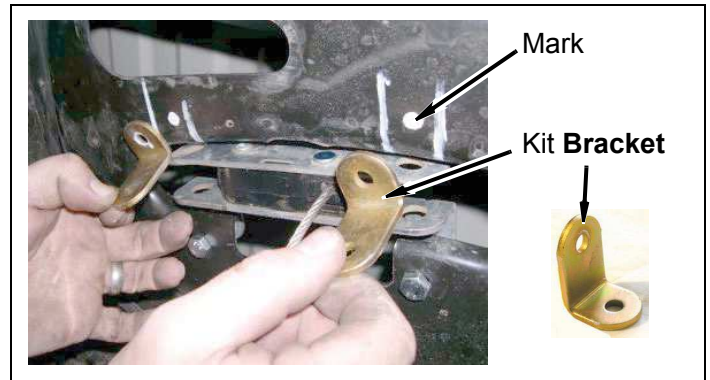

- e. Install kit **brackets** on top of mounting plate with two kit **bolts** (1/4" x 1"), four kit **washers** (1/4" SAE), and two kit **nuts** (1/4" nylock).

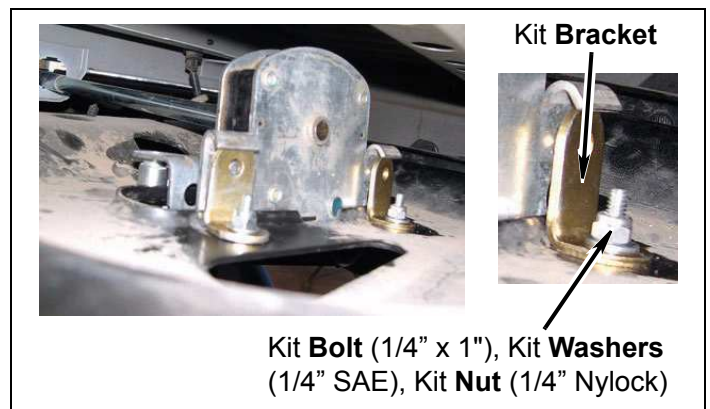

- f. Insert crank rod through hole and attach it to spare tire winch with cotter pin.

### 2. Rear Bumper

#### ⚠ WARNING

The following procedure is intended only to enhance the appearance of the vehicle. The rear bumper will no longer be rated for towing of any kind. Towing with the rear bumper after it has been lifted can result in death, serious personal injury, or damage to the vehicle. Towing after the bumper has been lifted should be accomplished using a rated Class III receiver type hitch.

- a. Remove four bolts, six nuts, and rear bumper brackets from rear bumper and vibration damper.

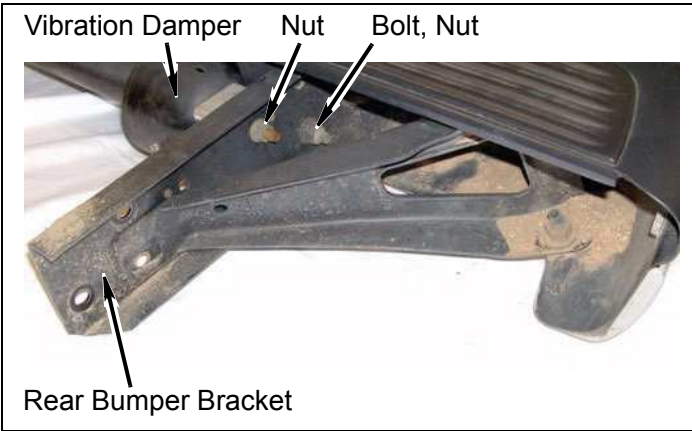

- b. Apply a few drops of Loctite® to threads of rear bumper nuts.
- c. Install two kit **brackets** (rear bumper) on rear bumper and vibration damper with four bolts and six nuts.

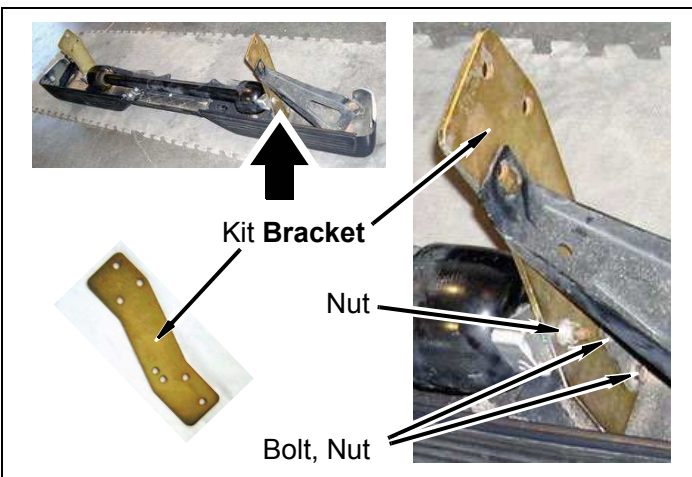

- d. Install rear bumper on frame with six bolts and six nuts. **DO NOT** tighten.
- e. Adjust bumper clearance according to measurements taken earlier. Tighten nuts to 55 lb-ft.

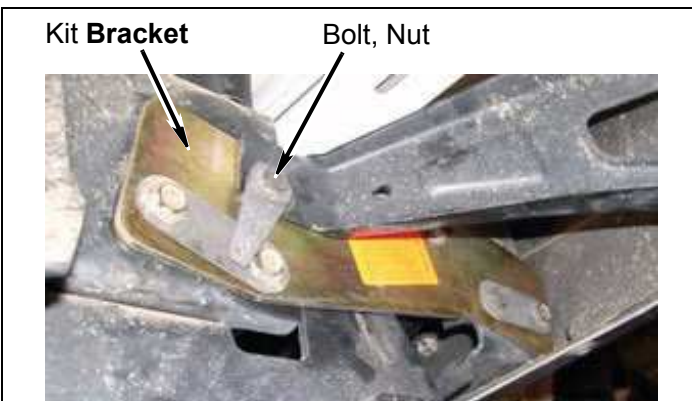

- f. Connect wire harness connector for license plate lights.



- g. Install spare tire.

### 3. Fuel Filler

**⚠ WARNING**  
Use extreme caution when working near the fuel lines and the fuel tank. Clean up spilled fuel immediately. A spark could cause an explosion or fire resulting in serious personal injury and property damage.

- a. Install fuel filler neck on bed with three screws.
- b. Bend metal tabs down. Install gas cap.

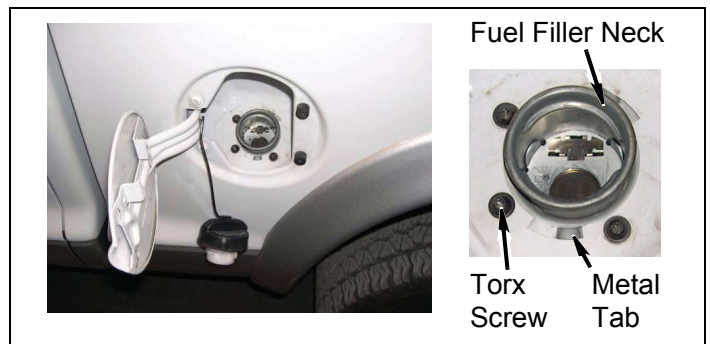

### 4. Bed Spacers

**⚠ CAUTION**  
A certified welder should perform all welding.

- a. **Long-bed:** Tack-weld two kit **spacers** (bed) to frame below bed crosschannel.

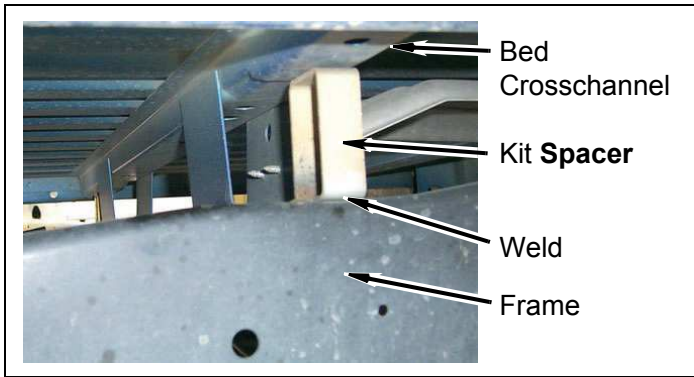

- d. Scribe a cut line on lower shift lever below bend.

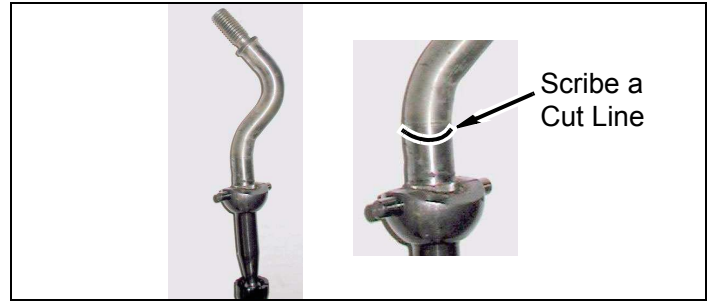

- e. Scribe a vertical line on lower shift lever and kit **extension** (manual transmission shift lever) to ensure pieces of shift lever remain properly oriented after welding.

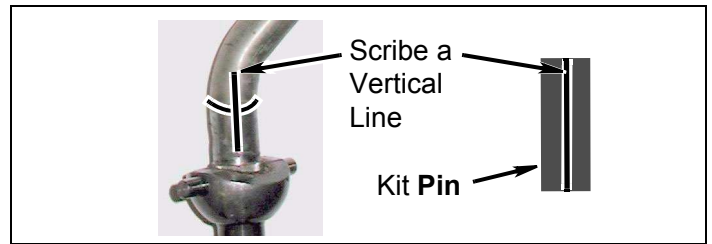

- f. Cut lower shift lever in half through line.

- g. Ensure scribed lines are aligned. Weld kit **extension** in place.

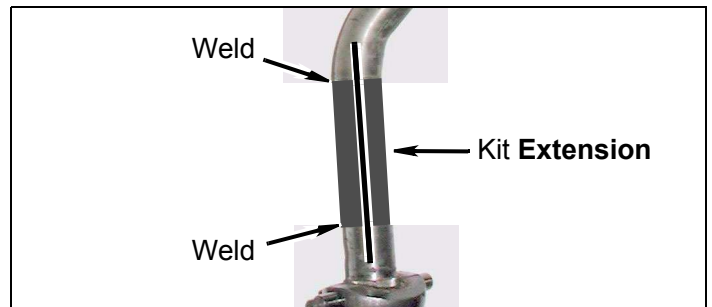

## Inside Cab

### 1. Manual Transmission: Shift Lever

- a. Remove dust cover, four screws, and locking plate from shift tower.

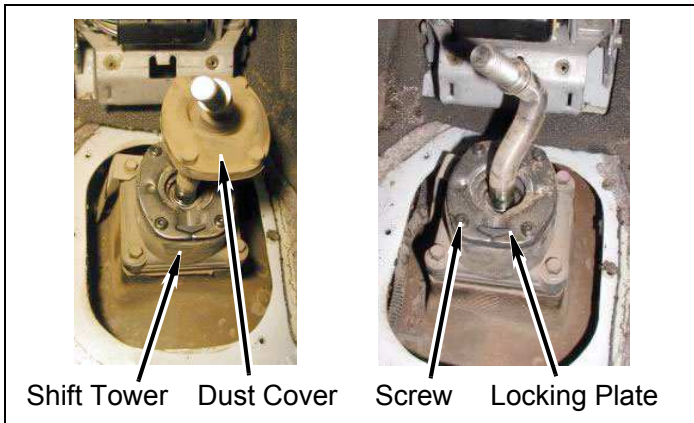

- b. Remove lower shift lever from shift tower.



- c. Remove washer, pivot pins, and insulator from lower shift lever to prevent heat damage during welding.

### 2. Brake Lines

- a. Install two kit **brackets** ("Z"-shaped) on frame with two bolts.

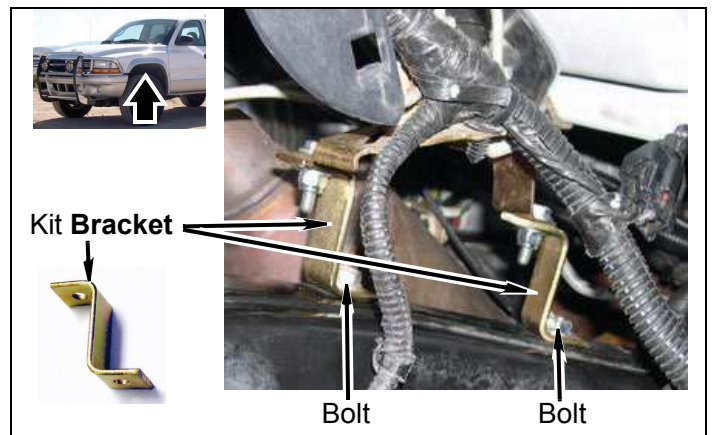

### ⚠ CAUTION

A certified welder should perform all welding.

- b. Install brake distribution block bracket on kit **brackets** with two kit **bolts** (1/4" x 1"), four kit **washers** (1/4" SAE), and two kit **nuts** (1/4" nylock).

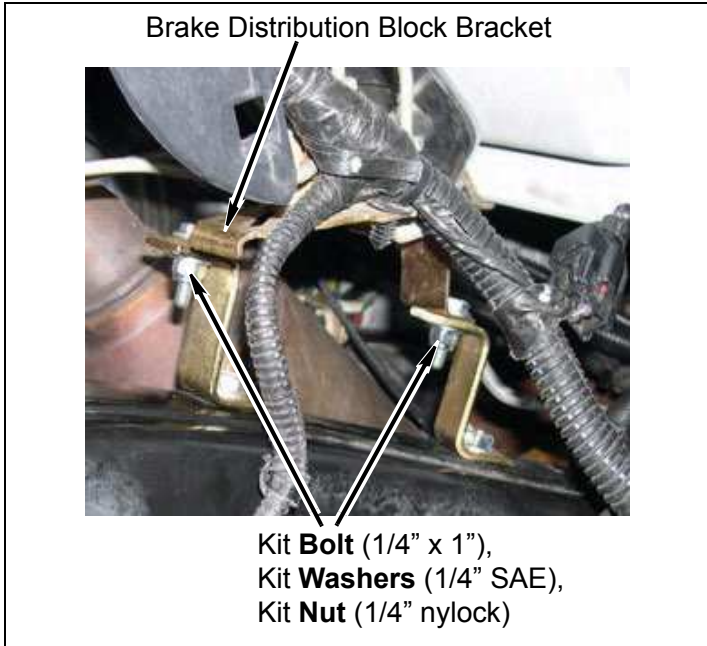

- c. Install kit **bracket** ("J"-shaped) on frame with bolt.
- d. Install brake line bracket on kit **bracket** with kit **bolt** (1/4" x 1"), kit **washer** (1/4" SAE), and kit **nut** (1/4" nylock).

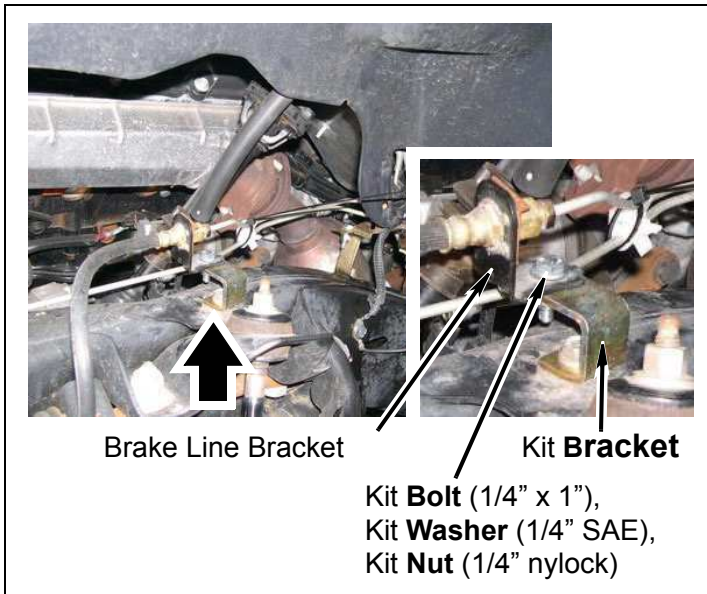

- 3. Ground Wires

- a. Install kit **bolt** (5/16" x 3/4" self-tapping) and ground wires on frame in hole above original hole.

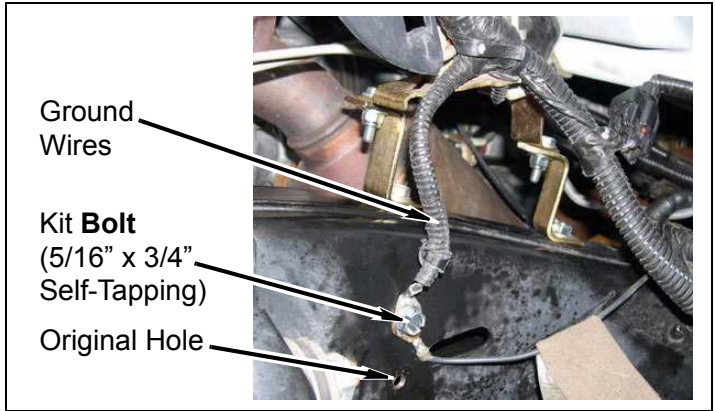

- 4. Plastic Cover

- a. Install plastic cover on driver side inner fender.



## Engine Compartment

- 1. **Automatic Transmission: Shift Cable**

- a. If possible, secure automatic transmission shift cable to frame with clip. If cable binding occurs, secure cable to a suitable object with a zip tie to prevent it from contacting the steering shaft.

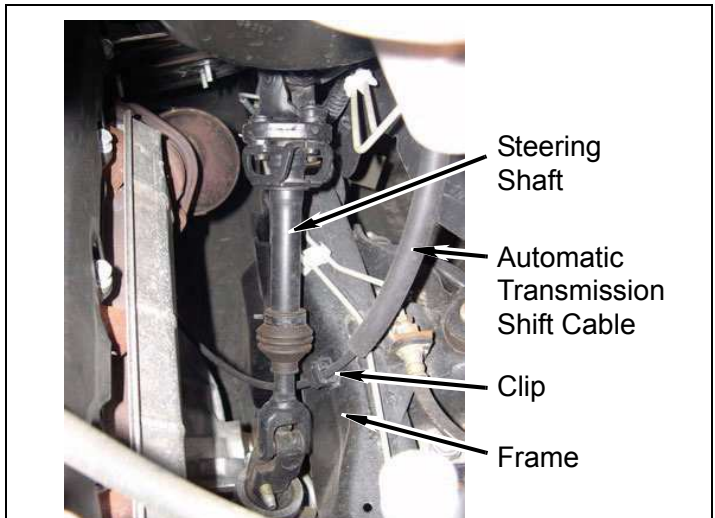

## 2. Steering Shaft

### ⚠WARNING

Ensure the kit **extension** (steering) is securely installed as specified in the instructions. Failure to do so may cause steering malfunction, resulting in loss of vehicle control.

- Install kit **extension** (steering) on upper steering shaft.

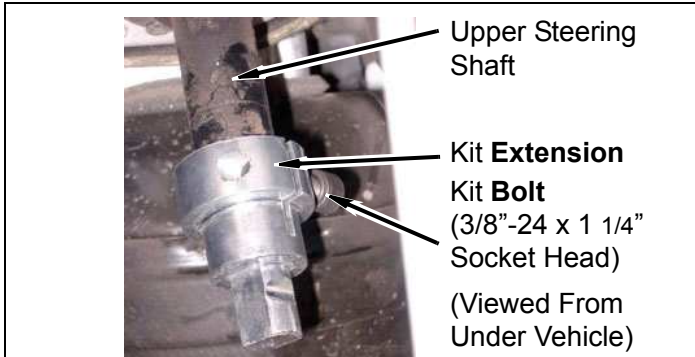

- Install intermediate steering shaft on kit **extension**.

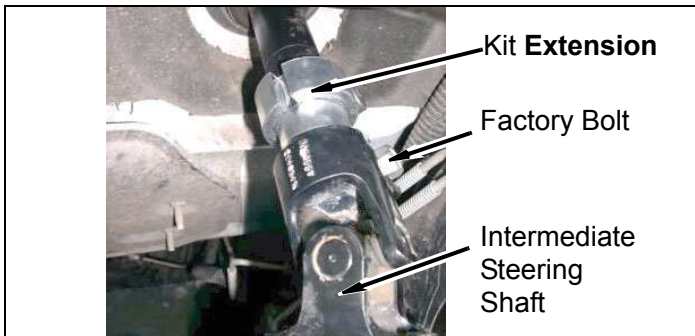

- Apply a few drops of Loctite® to kit **bolt** (3/8" x 1 1/4" Allen head) and factory bolt.
- Install and tighten kit **bolt** and factory bolt to 33 lb.-ft.

## 3. Lower Radiator Hose

- Cut lower radiator hose as shown.
- Install kit **extension** (lower radiator hose) with two kit **clamps** (#36).

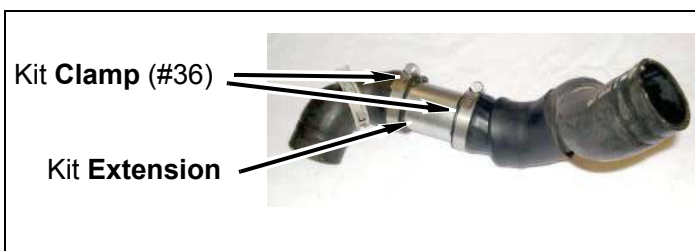

- Install lower radiator hose making sure the "R" is toward radiator.

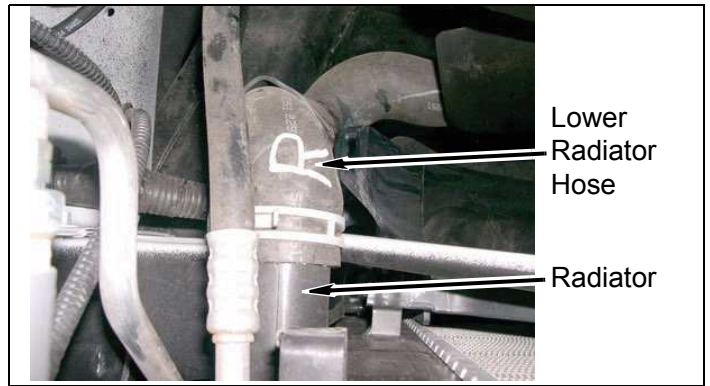

## 4. Fan Shroud

- Mark and cut lip from bottom of lower fan shroud.



- Position lower fan shroud in engine compartment.

- c. Install fan on water pump with four bolts.
- d. Position upper fan shroud in engine compartment.
- e. Install upper and lower fan shrouds on radiator with four bolts. Ensure distance between end of fan blades and fan shroud is even all the way around.
- f. Install seven wire harness clips in holes on rear face of core support.

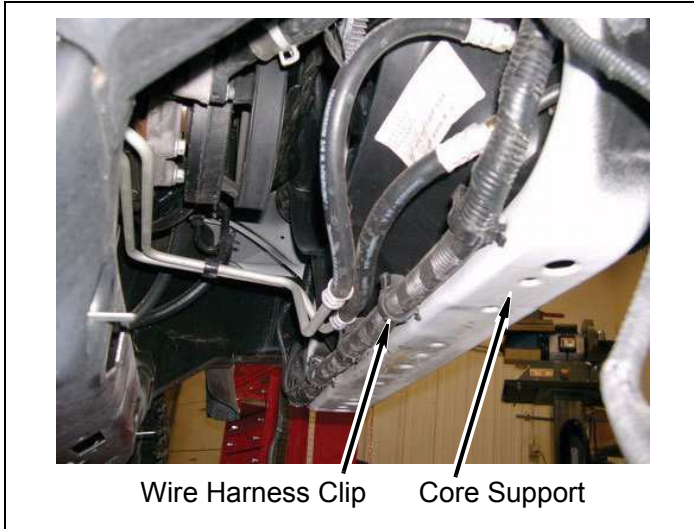

- g. Connect upper radiator hose to engine with hose clamp.



**CAUTION**  
 Ensure proper coolant level is reached when filling the radiator. Failure to check coolant level could result in an engine that runs above the normal operating temperature. Refer to vehicle service manual for proper coolant filling procedures.

- h. Fill radiator.
- i. Connect washer fluid hose and wire harness connector to washer fluid pump.

- j. Connect wire harness connector to washer fluid sensor.
- k. Fill washer fluid reservoir (if drained).

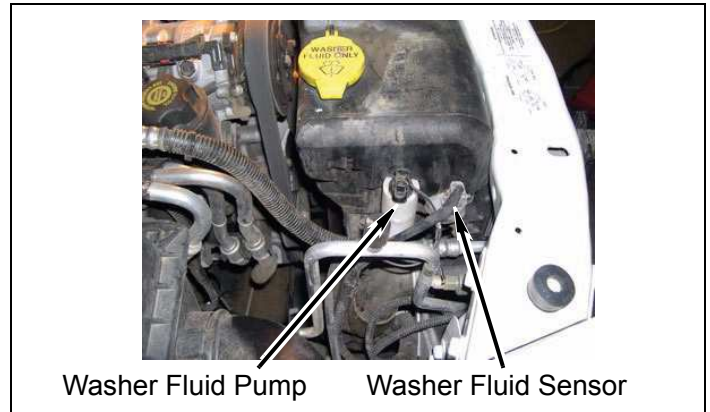

5. Ground Wire

- a. **Driver Side:** Install ground wire on stud with nut.



6. Ground Wires

- a. **Passenger Side:** Install kit **extension** (firewall ground strap) and insulated ground wire (if present) on firewall with nut.
- b. Install ground wire on stud of kit **extension** with kit **nut** (1/4" nylock) and kit **washer** (1/4" SAE).

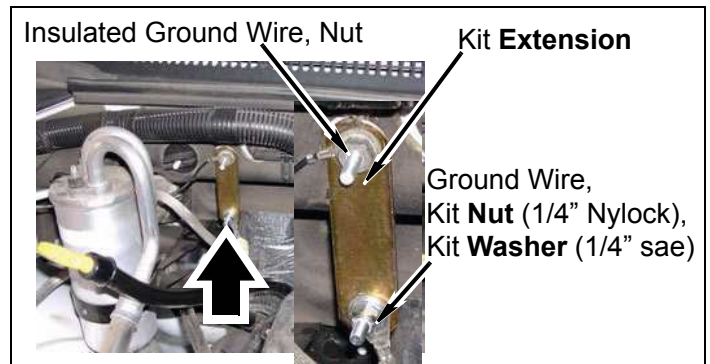



## 7. Intake Air Box

- a. Loosen bolt holding intake air box to bracket on driver side of intake air box.

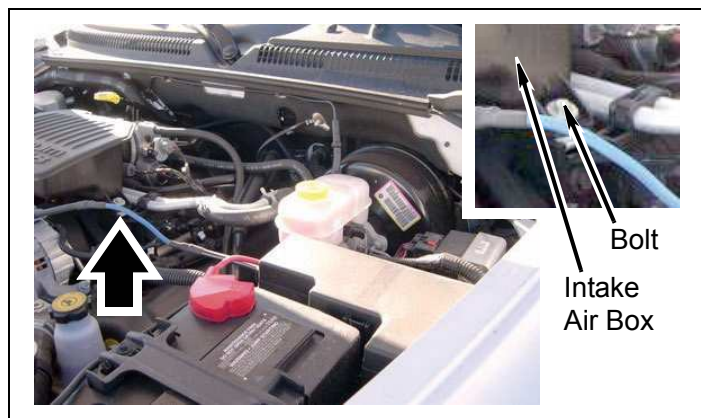

- b. Remove bolt and "U"-nut holding intake air box to bracket on passenger side of intake air box.

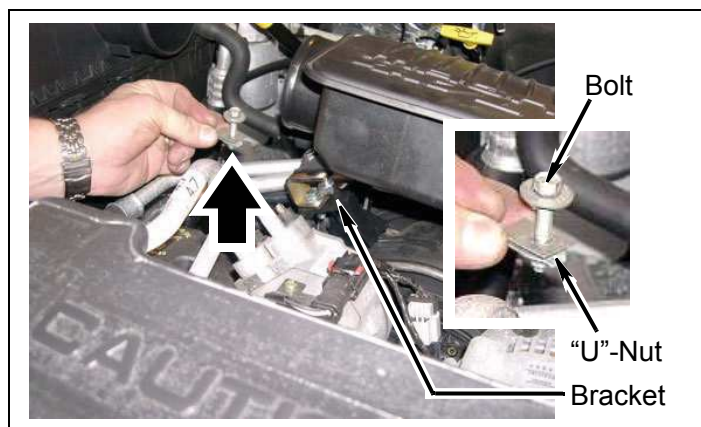

- c. Install kit **bracket** ("J"-shaped) on bracket with kit **bolt** (5/16" x 1") and kit **"U"-nut** (5/16").

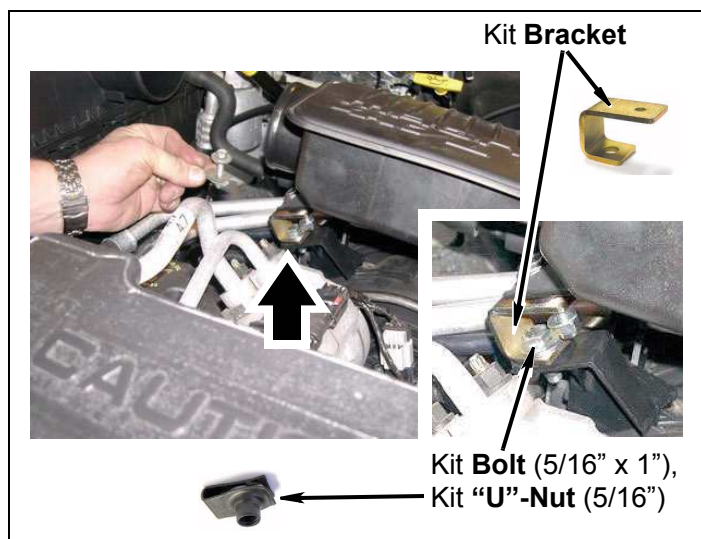

- d. Install intake air box on kit **bracket** ("J"-shaped) with kit **bolt** (1/4" x 1 1/2"), kit **washer** (1/4" SAE), and kit **nut** (1/4" nylock).

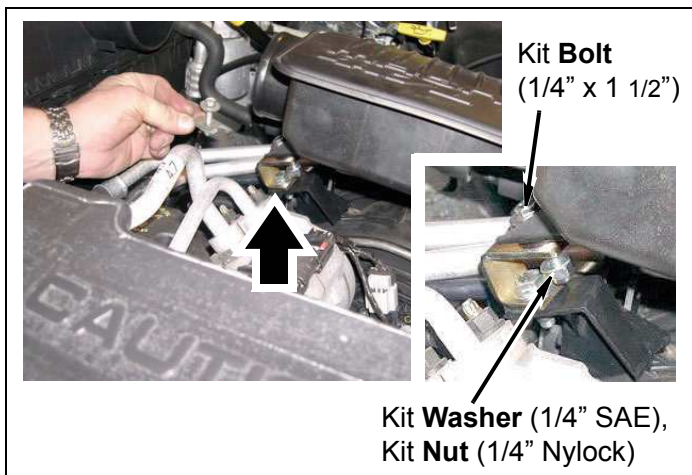

## 8. Air Filter Cover and Intake Air Hose

- a. Install air filter cover on air filter box.

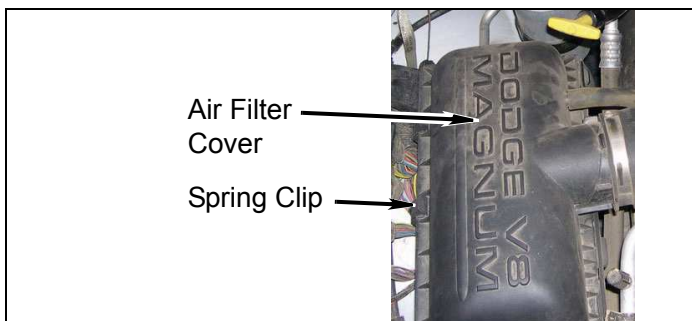

- b. Connect intake air hose to intake air box. Tighten clamp securely.



## Front of Vehicle

### 1. Front Bumper

- a. Apply a few drops of Loctite® to threads of front bumper bolts.

- b. Install two kit **brackets** (front bumper) on frame with four bolts. Tighten bolts to 55 lb-ft.

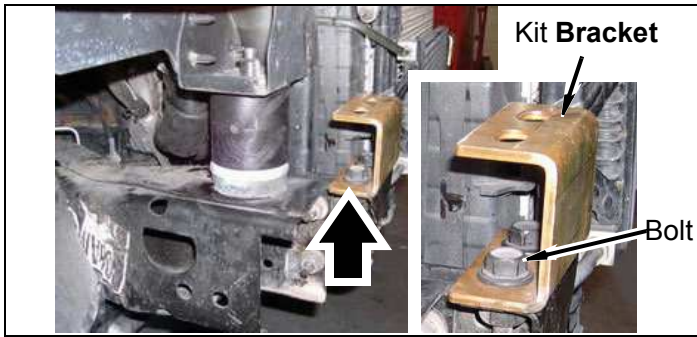

- c. Install front bumper on kit **brackets** with four kit **bolts** (7/16" x 1 1/2"), eight kit **washers** (7/16" USS), and four kit **nuts** (7/16" nylock)..

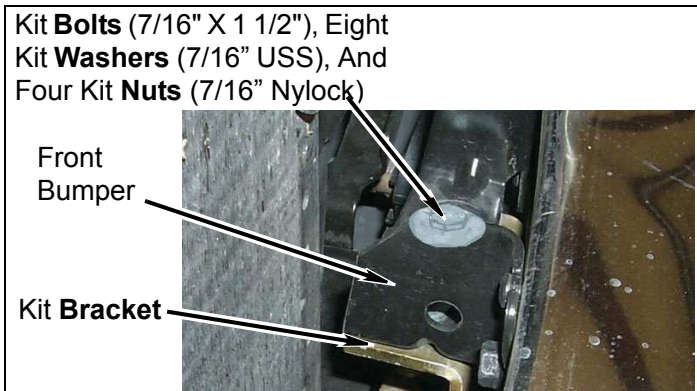

- d. Install flap on core support with four push pins.

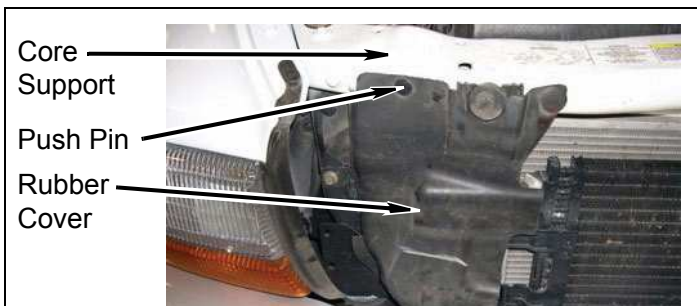

- e. Install two kit **brackets** (side bumper) on frame and side bumper braces with four bolts and four kit **bolts** ( 7/16" x 1"), eight kit **washers** (7/16" USS), and four kit **nuts** (7/16" nylock).

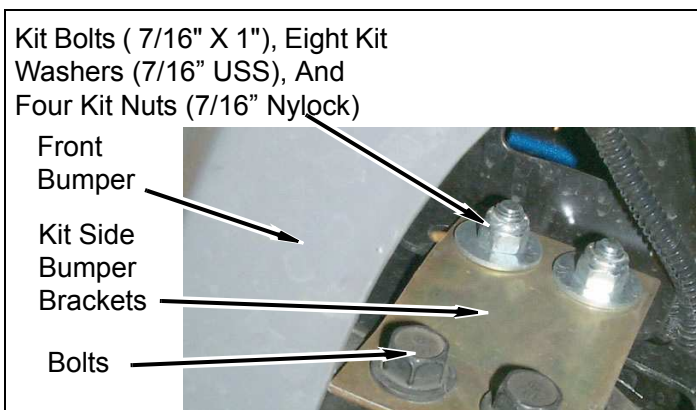

- f. If equipped, connect wire harness connectors to driving lights.

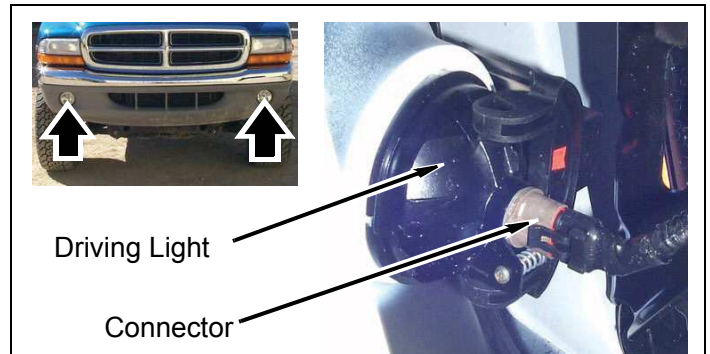

- g. Trim each side of splash shield.



- h. Elongate holes in splash shield to 5/16" from edge.

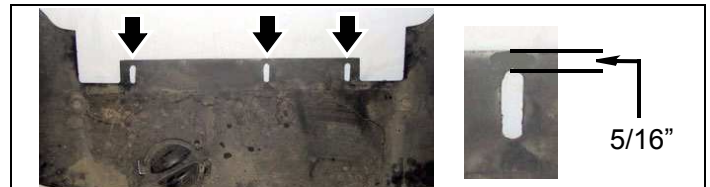

- i. Install splash shield on core support and cross-member with seven push pins.

- j. Adjust bumper to body clearance. Tighten bolts to 55 lb-ft.

## After Completing Installation

### Inside Cab

1. Fuse Box

- a. Install two airbag fuses. (20 and 21)

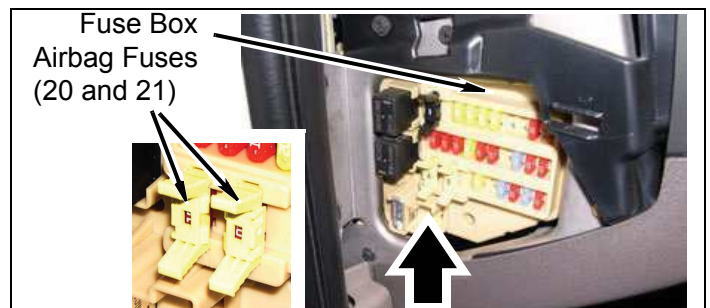

- b. Install fuse box cover.

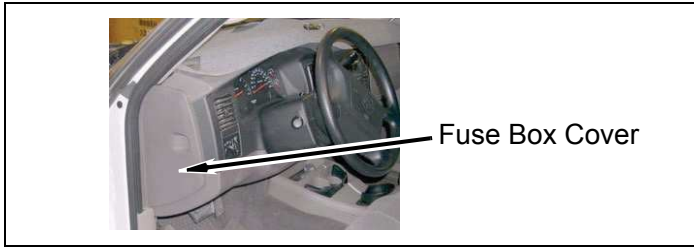

## Engine Compartment

### 1. Battery Cables

- a. Connect both battery cables. Connect positive cable first, then negative cable.

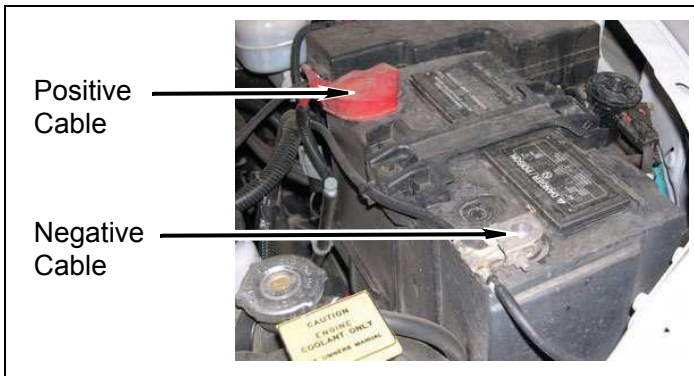

## Miscellaneous

1. Apply kit **label** (warning) to dashboard in plain sight of all vehicle occupants.
2. Check all fasteners to ensure they are tight.
3. Ensure all wires, hoses, cables, etc. are properly connected and there is ample slack.

### ⚠WARNING

If the engine cooling system is hot, the coolant will be **HOT** and **UNDER PRESSURE**. To prevent serious personal injury, wait until the cooling system is completely cool before removing the cap from the radiator.

4. Start engine and top off cooling system. Purge air from cooling system according to manufacturer's instructions. Install radiator cap.

## Dynamic Vehicle Check

1. Test-drive vehicle. Check steering in both directions to ensure that there is no bind. Check operation of clutch, brake system, and parking brake. Check

operation of transmission and transfer case. Ensure there is full engagement in all gears and 4WD ranges.

2. Check operation of all electrical accessories.

### ⚠WARNING

Retorque all fasteners after 500 miles and after off road use. All body lift components should be visually inspected and fasteners retorqued during routine vehicle servicing.

### ⚠CAUTION

Performance Automotive Group does not recommend any particular wheel and tire combinations for use with its body lifts and cannot assume responsibility for the customer's choice of wheels and tires. Refer to your owner's manual for recommended tire sizes and warnings related to the use of oversized tires. Larger wheel and tire combinations increase stress and wear on steering and suspension components, which leads to increased maintenance and higher risk for component failure. Larger wheel and tire combinations also alter speedometer calibration, braking effectiveness, center of gravity, and handling characteristics. Consult an experienced local off road shop to find what wheel and tire combinations work best with your vehicle.

### ⚠NOTE

All warranty information, instruction sheets, and other documents regarding the installation of this product must be retained by the vehicle owner. Information contained in the instructions and on the warranty card will be required for any warranty claims. The vehicle owner needs to understand the modifications made to the vehicle and how they affect vehicle handling and performance. Failure to provide the vehicle owner with this information can result in damage to the vehicle and severe personal injury.

# Kit Parts List

Qty.	Description
2	<b>Block</b> , 3" height x 2" diameter
14	<b>Block</b> , 3" height x 3" diameter
2	<b>Bolt</b> , 8mm-1.25 x 30mm
8	<b>Bolt</b> , 10mm-1.50 x 100mm
8	<b>Bolt</b> , 12mm-1.75 x 160mm
5	<b>Bolt</b> , 1/4" x 1"
1	<b>Bolt</b> , 1/4" x 1 1/2"
1	<b>Bolt</b> , 3/8"-24 x 1 1/4" socket head
1	<b>Bolt</b> , 5/16" x 3/4" self-tapping
1	<b>Bolt</b> , 5/16" x 1"
4	<b>Bolt</b> , 7/16" x 1"
4	<b>Bolt</b> , 7/16" x 1 1/2"
1	<b>Bracket</b> , firewall ground strap
2	<b>Bracket</b> , front bumper
2	<b>Bracket</b> , "J"-shaped
2	<b>Bracket</b> , "L"-shaped
2	<b>Bracket</b> , rear bumper
2	<b>Bracket</b> , "Z"-shaped
2	<b>Clamp</b> , hose #36
1	<b>Extension</b> , lower radiator hose
1	<b>Extension</b> , manual transmission shift lever
1	<b>Extension</b> , steering
5	<b>Nut</b> , 1/4" Nylock
8	<b>Nut</b> , 7/16" Nylock
2	<b>Spacer</b> , bed
2	<b>Spacer</b> , spare tire winch
1	"U"-Nut, 5/16"
2	<b>Washer</b> , 8mm
10	<b>Washer</b> , 1/4" SAE
1	<b>Washer</b> , 5/16" SAE
24	<b>Washer</b> , 7/16" USS
8	<b>Washer</b> , 1/2" SAE



**Block**, 3" height x 2" diameter



**Block**, 3" height x 3" diameter



**Bracket**, front bumper



**Bracket**, rear bumper



**Extension**, steering



**Spacer**, bed

## ⚠ NOTE

Depending on the vehicle configuration (automatic or manual transmission, 2WD or 4WD, cab length, bed length, etc.), some parts may not be required.

Rev. 02, Copyright 11/04 Performance Automotive Group