

**CIGWELD**  
*Professional*

# Welding Consumables Pocket Guide

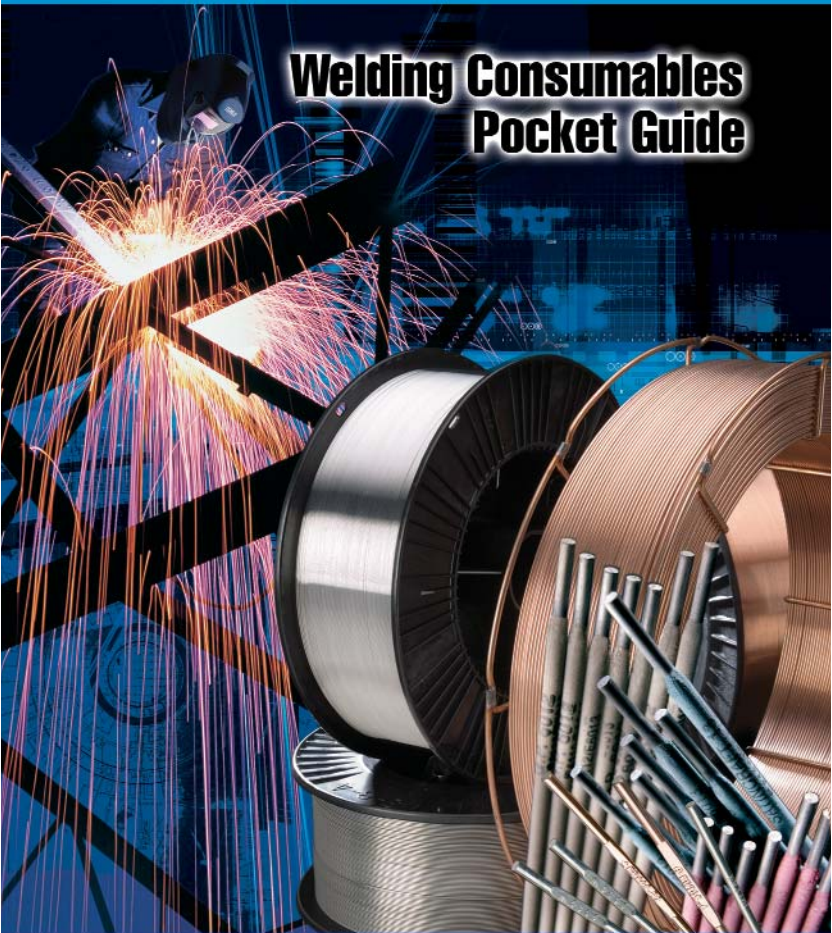

**THERMADYNE**  
A Global Cutting & Welding Market Leader™

## INDEX

1	Contents in Detail	3
2	Mild Steel and Iron Powder Electrodes	27
3	Hydrogen Controlled Electrodes	39
4	Stainless Steel and Special Electrodes	55
5	Cobalarc Hardfacing Consumables	71
6	Gas Metal Arc Welding (MIG) Wires	103
7	Flux Cored Arc Welding (FCAW) Wires	127
8	Submerged Arc Wires and Fluxes	171
9	Gas and TIG Welding Consumables	179
10	Solders and Fluxes	211
11	Miscellaneous Products	223
12	Technical and Trade Information	227

**Notice about CIGWELD's Welding Consumables Pocket Guide (manual).**

The information in this Pocket Guide has been prepared as a reference only for use exclusively with the products identified in it. Each user should properly assess the information in the specific context of the intended application. Throughout this manual there are specific safety warnings. Disobeying or failing to heed these warnings can result, in some circumstances, in the unchecked emission of poisonous gases, or burns from explosion or electric shock.

Although care has been taken in compiling this information, CIGWELD will not be liable for any direct, indirect, special or consequential damage (including damage resulting from its negligence), arising out of, or connected with the use of, or reliance on, this information except for liability imposed by legislation (including the Trade Practices Act), that cannot be excluded.

CIGWELD does not make or give any express or implied warranties or representations except for those that are implied by legislation (including the Trade Practices Act), that cannot be excluded.

Where the preceding paragraphs cannot legally operate, and to the extent permitted by law, CIGWELD's liability for breach of any term or warranty implied by law is limited to and completely discharged at CIGWELD's option, by either:

- replacement of the manual in hard copy form;
- payment of the cost of replacing the manual or acquiring an equivalent one.

© 2008 CIGWELD All rights reserved.

A.B.N. 56 007 226 815

## QUALITY ASSURANCE AND QUALITY CONTROL

CIGWELD's stated quality policy is to continuously satisfy our customer's expectations by supplying goods and services of the highest quality. The Welding Consumables Quality Management System has been approved by Lloyd's Register Quality Assurance Limited (LRQA) to the quality management standard AS/NZS ISO 9001 'quality systems - model for quality assurance in production, installation and servicing'. This third party approval (certification) represents CIGWELD's commitment to quality and a program of continuous improvement.

The quality system applies a high level of documentation and vigorous control from receipt of order, through purchase of raw materials, all aspects of production and testing to final despatch - to ensure a consistent product that meets the customer's specified requirements.



FORM L019A (8/90) The use of the Accreditation Mark indicates Accreditation in respect of those activities covered by the Accreditation Certificate Number 001.

## CONTENTS IN DETAIL

Product Index by AS/NZS & AWS/ASME-SFA Classifications...	4
Product Index by Alphabetical Order...	8
Packaging Information...	11
Comparable Consumables by Welding Process...	13
Product Certification Available from CIGWELD...	15
Recommended Storage, Care & Conditioning of CIGWELD Consumables...	16
Welding Position Symbols, used throughout this guide...	22
Shipping Society Approvals for CIGWELD Consumables	24
Technical and Trade Information...	227
12.1 Terms & Definitions...	229
12.2 Basic types of welded joints...	233
12.3 Welding Positions & Symbols...	237
12.4 Defects in welding...	243
12.5 Distortion, causes & control...	249
12.6 Safety in Welding...	254
12.7 Consumables Classification Tables...	258
12.8 Shielding Gas Information...	276
12.9 Welding Guide...	286
12.9.1 Welding of Steel...	286
12.9.2 Welding of Stainless Steel...	310
12.9.3 Welding of Aluminium...	320
12.9.4 Welding of Cast Iron...	348
12.9.5 Welding of Copper & Copper Alloys...	357
12.9.6 Welding of Dissimilar Metals...	368
12.10 Hardfacing Information...	370
12.11 Deposition Data...	392
12.12 Technical Facts & Figures...	399

## PRODUCT INDEX BY AS/NZS AND AWS/ASME-SFA STANDARDS

### Mild Steel and Iron Powder Electrodes

Product Name	AS/NZS Classification	AWS/ASME-SFA Classification	Page No:
PipeArc 6010P	1553.1: E4110-2	A5.1: E6010	37
Ferrocrafft 11	1553.1: E4111-2	A5.1: E6011	36
GP 6012	1553.1: E4112-0	A5.1: E6013	28
Ferrocrafft 12XP	1553.1: E4112-0	A5.1: E6013	29
Speedex 12	1553.1: E4112-0	A5.1: E6013	30
Satincrafft 13	1553.1: E4113-0	A5.1: E6013	31
Weldcrafft	1553.1: E4113-2	A5.1: E6013	32
Speedex 13	1553.1: E4113-0	A5.1: E6013	33
Ferrocrafft 21	1553.1: E4814-2	A5.1: E7014	34
Ferrocrafft 22	1553.1: E4824-2	A5.1: E7024	35

### Hydrogen Controlled Electrodes

Product Name	AS/NZS Classification	AWS/ASME-SFA Classification	Page No:
Ferrocrafft 16TXP - Hermetically Sealed	1553.1: E4816-2 H10	A5.1: E7016 H8	41
Ferrocrafft 7016	1553.1: E4816-5 H10	A5.1: E7016 H8	42
Ferrocrafft 55U	1553.1: E4816-2 H10	A5.1: E7016 H8	43
Ferrocrafft 61	1553.1: E4818-3 H10	A5.1: E7018	44
Ferrocrafft 61 H4 - Hermetically Sealed	1553.1: E4818-5 H5R	A5.1: E7018-1 H4R	45
Ferrocrafft 61 Ni H4 - Hermetically Sealed	1553.2: E4818-G H5R	A5.5: E7018-G H4R	46
Alloycrafft 70-A1 - Hermetically Sealed	1553.2: E4818 A1H5R	A5.5: E7018-A1 H4R	47
Alloycrafft 80-B2 - Hermetically Sealed	1553.2: E5518-B2 H5R	A5.5: E8018-B2 H4R	48
Alloycrafft 80-C1 - Hermetically Sealed	1553.2: E5518-C1 H5R	A5.5: E8018-C1 H4R	49
Alloycrafft 90-B3 - Hermetically Sealed	1553.2: E6218-B3 H5R	A5.5: E9018-B3 H4R	50
Alloycrafft 90 - Hermetically Sealed	1553.2: E6218-M H5R	A5.5: E9018M H4R	51
Alloycrafft 110 - Hermetically Sealed	1553.2: E7618-M H5R	A5.5: E11018M H4R	52

### Stainless Steel and Special Electrodes

Product Name	AS/NZS Classification	AWS/ASME-SFA Classification	Page No:
Satincrome 308L-17	1553.3: E308L-17	A5.4: E308L-17	56
Satincrome 309Mo-17	1553.3: E309Mo-17	A5.4: E309Mo-17	57
Satincrome 316L-17	1553.3: E316L-17	A5.4: E316L-17	58
Satincrome 318-17	1553.3: E318-17	A5.4: E318-17	59
Murex Speedex 308L-16	1553.3: E308L-16	A5.4: E308L-16	60
Murex Speedex 309L-16	1553.3: E309L-16	A5.4: E309L-16	61
Murex Speedex 316L-16	1553.3: E316L-16	A5.4: E316L-16	62
Murex Speedex 312-16	1553.3: E312-16	A5.4: E312-16	63
Weldall	1553.3: E312-17	A5.4: E312-17	64
Castcrafft 55	---	A5.15: ENiFe-Cl	65
Castcrafft 100	---	A5.15: ENi-Cl	66
Bronzecrafft AC-DC	2567: E6200-A2	A5.6: CuSn-C	67
Arcair DC Carbons	---	---	68

**PRODUCT INDEX BY AS/NZS AND AWS/ASME-SFA STANDARDS**
**Hardfacing Electrodes & Wires**

Product Name	AS/NZS Classification	AWS/ASME-SFA Classification	Page No:
Cobalarc Mangcraft	2576: 1215-A4	---	73
Cobalarc Austex	2576: 1315-A4	---	72
Cobalarc 350	2576: 1435-A4	---	74
Cobalarc Toolcraft	2576: 1560-A4	---	77
Cobalarc 650	2576: 1855-A4	---	75
Cobalarc 750	2576: 1860-A4	---	76
Cobalarc CR70	2576: 2355-A4	---	78
Cobalarc 1e	2576: 2360-A4	---	82
Cobalarc 9e	2576: 2460-A4	---	81
Cobalarc Borochrome	2576: 2560-A4	---	79
Stoody Tube Borium	2576: 3460-A1	---	82
Stoody 104 (Cobalarc 104-SA)	2576: 1125-B1	---	93
Stoody Buildup-O (Cobalarc 250-O)	2576: 1125-B7	---	85
Stoody Dynamang-O (Cobalarc Mang Nickel-O)	2576: 1215-B7	---	84
Stoody Super Buildup-O (Cobalarc 350-G/O)	2576: 1435-B5/B7	---	86
Stoody 107 (Cobalarc 107-SA)	2576: 1440-B1	---	95
Stoody 105 (Cobalarc 105-SA)	2576: 1445-B1	---	94
Stoody 110 MC (Cobalarc Crome Mang-O)	2576: 1715-B7	---	92
Stoody 965-O (Cobalarc 650-G/O)	2576: 1855-B5/B7	---	87
Cobalarc 850-O	2576: 1865-B7	---	88
Stoody 600 (Cobalarc Impactaclad-O)	2576: 1955-B7	---	96
Stoody 101 HC-G/O (Cobalarc Coarseclad-G/O (1.2, 1.6))	2576: 2360-B5/B7	---	89
Stoody 100 HC-O (Cobalarc Coarseclad-O (2.4 & 2.8))	2576: 2360-B7	---	90
Stoody 143-O (Cobalarc Abraso-clad-O)	2576: 2460-B7	---	97
Stoody Fineclad-O (Cobalarc Fineclad-O)	2576: 2565-B7	---	91
Stoody 145 Open Arc Wire	2576: 2560-B7	---	98
Stoody RA45-O	2576: 1845-B7	---	99
Stoody 'S' Flux	2576:	---	100

**Gas Metal Arc Welding (MIG) Wires**

Product Name	AS/NZS Classification	AWS/ASME-SFA Classification	Page No:
Autocraft LW1	2717.1: E54-GC/M-W503AH	A5.18: ER70S-4	105
Autocraft Super Steel	2717.1: E52-GC/M-W503AH	A5.18: ER70S-2	106
Autocraft LW1-6	2717.1: E56-GC/M-W503AH	A5.18: ER70S-6	107
Autocraft Mn-Mo	2717.1: E5D2-GM-W559AH	A5.28: ER80S-D2	110
Autocraft NiCrMo	2717.1: E5MG-GM-W769AH	A5.28: ER110S-G	111
Autocraft CrMo1	2717.1: E5B2-GM-W559AH	A5.28: ER80S-B2	112
Autocraft AL1100 (Pure)	2717.2: E1100	A5.10: ER1100	118
Autocraft AL4043 (5% Sil)	2717.2: E4043	A5.10: ER4043	119
Autocraft AL5356 (5% Mag)	2717.2: E5356	A5.10: ER5356	120
Autocraft AL5183	2717.2: E5183	A5.10: ER5183	122
Autocraft 2209	2717.3: E52209	A5.9: ER2209	117
Autocraft 307Si	2717.3: E5307Si	A5.9: ER307Si	113
Autocraft 308LSi	2717.3: E5308LSi	A5.9: ER308LSi	114
Autocraft 309LSi	2717.3: E5309LSi	A5.9: ER309LSi	115
Autocraft 316LSi	2717.3: E5316LSi	A5.9: ER316LSi	116
Autocraft Deoxidised Copper	---	A5.7: ERCu	123
Autocraft Silicon Bronze	---	A5.7: ERCuSi-A	124

## PRODUCT INDEX BY AS/NZS AND AWS/ASME-SFA STANDARDS

### Flux Cored Arc Welding (FCAW) Wires

Product Name	AS/NZS Classification	AWS/ASME-SFA Classification	Page No:
Satin-Cor XP	2203.1: ETD-GCp-W502A. CM1 H10	A5.20: E70T-1 H8	129
	<b>1.6mm only</b> 2203.1: ETD-GC/Mp-W502A. CM1 H10	A5.20: E70T-1 H8, E70T-1M H8	
Verti-Cor XP	2203.1: ETP-GCp-W503A. CM1 H10	A5.20: E71T-1 H8	130
	2203.1: ETP-GMp-W503A. CM1 H10	A5.20: E71T-1M H8	130
Verti-Cor Ultra	2203.1: ETP-GCp-W502A. CM1 H10	A5.20: E71T-1 H8	132
Verti-Cor 3XP	2203.1: ETP-GCp-W503A. CM1 H10	A5.20: E71T-1 H8	134
	2203.1: ETP-GMp-W503A. CM1 H10	A5.20: E71T-12M H8	134
Verti-Cor 3XP H4	2203.1: ETP-GMp-W503A. CM1 H5	A5.20: E71T1-12M H4	136
Verti-Cor 81 A1 H4	2203.1: ETP-GMp-553 A1 H5	A5.29: E81T-1A1 H4	138
Verti-Cor 81Ni 1	2203.1: ETP-GMp-W554A. Ni1 H10	A5.29: E81T1-1 Ni1 H8	139
Verti-Cor 81Ni1 H4	2203.1: ETP-GMp-W554A Ni1 H5	A5.29: E81T-1 Ni1 H4	140
	2203.1: ETP-GCp-W554A Ni1 H5	A5.29: E81T-1 Ni1M H4	140
Verti-Cor 81Ni 2	2203.1: ETP-GMp-W559A. Ni2 H10	A5.29: E81T1-1 Ni2 M H8	142
Verti-Cor 91 K2 H4	2203.1: ETP-GMp-W629A K2 H5	A5.29: E91T-1 K2 M H4	144
Verti-Cor 111 K3 H4	2203.1: ETP-GMp-W768A K3H5	A5.29: E111T1-K3M H4	145
Supre-Cor 5	2203.1: ETP-GCn/p-W505A. CM1 H5	A5.20: E71T-5 H4	146
	2203.1: ETP-GMn/p-W505A. CM1 H5	A5.20: E71T-5M H4	146
Supre-Cor XP H4	2203.1: ETP-GCn-W503A. CM1 H5	A5.20: E70T-5 H4	148
	2203.1: ETP-GMn-W503A. CM1 H5	A5.20: E70T-5M H4	148
Metal-Cor XP	2203.1: ETD-GMn/p-W503A CM1 H5	A5.18: E70C-6M H4	149
Metal-Cor 5	2203.1: ETD-GMn/p-W505A CM1 H5	A5.18: E70C-6M H4	151
Tensi-Cor 110T XP H4	2203.1: ETD-GCn/p-W769A. K4 H5	A5.29: E110T5 K4 H4	152
	2203.1: ETD-GMn/p-W769A K4 H5	A5.29: E110T5 K4M H4	152
Nicore 55	equivalent electrode classification →	A5.15: ENiFe-Cl	154
Shield-Cor 4XP	2203.1: ETD-GNp-W500A CM2 H15	A5.20: E70T-4	155
Shield-Cor 8XP	2203.1: ETD-GNn-W503A CM1	A5.20: E71T-8	156
Shield-Cor 8Ni	2203.1: ETD-GNn-W504A Ni1	A5.29: E71T-Ni1	157
Shield-Cor 11	2203.1: ETP-GNn-W500A. CM2	A5.20: E71T-11	158
Shield-Cor 15	2203.1: ETPS-GNn-W500A. CM2	A5.20: E71T-GS	160
Verti-Cor 308LT	---	A5.22: E308LT1-1	162
	---	A5.22: E308LT1-4	162
Verti-Cor 309LT	---	A5.22: E309LT1-1	164
	---	A5.22: E309LT1-4	164
Verti-Cor 316LT	---	A5.22: E316LT1-1	166
	---	A5.22: E316LT1-4	166
Stoody 308LT-0	---	A5.22: E308LT0-3	168
Stoody 309LT-0	---	A5.22: E309LT0-3	169

### Submerged Arc Wires and Fluxes

Product Name	AS/NZS Classification	AWS/ASME-SFA Classification	Page No:
Autocraft SA1	1858.1: EL12	A5.17: EL12	173
Autocraft SA2	1858.1: EM12K	A5.17: EM12K	174
Satinarc 15 with SA1	1858.1: EL12-FGH-W403A	A5.17: F6A2-EL 12	176
Satinarc 15 with SA2	1858.1: EM12K-FGH-W403A	A5.17: F7A2-EM12K	176
Satinarc 4 with SA1	1851.1: EL12-FMM-W403A	A5.17: F6A2-EL12	175
Satinarc 4 with SA2	1851.1: EM12K-FMM-W503A	A5.17: F7A4-EM12K	175
	---	A5.17: F6P4-EM12K	175

**PRODUCT INDEX BY AS/NZS AND AWS/ASME-SFA STANDARDS**
**Gas and TIG Welding Consumables**

Product Name	AS/NZS Classification	AWS/ASME-SFA Classification	Page No:
Comweld Mild Steel	1167.2: RG	A5.2: R45	184
Comweld High Test	1167.2: R1	A5.2: R60	185
Comweld Super Steel	1167.2: R2	A5.18: ER70S-2	189
Comweld LW1-3	1167.2: R3	A5.18: ER70S-3	187
Comweld LW1	1167.2: R4	A5.18: ER70S-4	186
Comweld LW1-6	1167.2: R6	A5.18: ER70S-6	188
Comweld CrMo1	1167.2: RB2	A5.28: ER80S-B2	190
Comweld CrMo2	1167.2: RB3	A5.28: ER90S-B3	191
Comweld 2209 Duplex Stainless Steel	1167.2: R2209	A5.9: ER2209	195
Comweld 308L Stainless Steel	1167.2: R308L	A5.9: ER308L	192
Comweld 309L Stainless Steel	1167.2: R309L	A5.9: ER309L	193
Comweld 316L Stainless Steel	1167.2: R316L	A5.9: ER316L	194
Comweld AL1100 (Pure)	1167.2: R1100	A5.10: R1100	196
Comweld AL4043 (5% Sil.)	1167.2: R4043	A5.10: R4043	197
Comweld AL4047 (10% Sil.)	1167.2: R4047	A5.10: R4047	198
Comweld AL5356 (5% Mag.)	1167.2: R5356	A5.10: R5356	199
Comweld G.P. Cast Iron Rod	1167.2: RC11	---	200
Comweld Galvanising Bar	---	---	201
Comweld Tobin Bronze Rod	1167.1 & 2: RCuZn-A	A5.8 & 27: RBCuZn-A	204
Comweld Comcoat T	1167.1 & 2: RCuZn-A	A5.8 & 27: RBCuZn-A	205
Comweld Manganese Bronze Rod	1167.1 & 2: RCuZn-C	A5.8 & 27: RBCuZn-C	202
Comweld Comcoat C	1167.1 & 2: RCuZn-C	A5.8 & 27: RBCuZn-C	203
Comweld Nickel Bronze Rod	1167.1 & 2: RCuZn-D	A5.8 & 27: RBCuZn-D	206
Comweld Comcoat N	1167.1 & 2: RCuZn-D	A5.8 & 27: RBCuZn-D	207
Comweld Silicon Bronze Rod (801)	1167.2: RCuSi-A	A5.7: RCuSi-A	208

**Solders and Fluxes**

Comweld 40/60 Soft Solder	1834.1: 40Sn	---	212
Comweld 50/50 Soft Solder	1834.1: 50Sn	---	213
Comweld 965 Solder	1834.1: 96.5Sn / 3.5Ag	---	214
Comweld Metal Mate Solder Kit	1834.1: 96.5Sn / 3.5Ag	---	215
Comweld Aluminium Flux	---	---	216
Comweld Copper and Brass Flux	---	---	217
Comweld Silver Brazing Flux No. 2	---	---	218
Comweld G.P. Silver Brazing Flux	---	---	219
Comweld 965 Soldering Flux	---	---	220
Comweld VAPAFLUX	---	---	221

**Miscellaneous Products**

Product Name	AS/NZS Classification	AWS/ASME-SFA Classification	Page No:
ChromeBright (Pickling Paste)	---	---	224



## PRODUCT INDEX BY ALPHABETICAL

Product Name	AS/NZS Classification	AWS/ASME-SFA Classification	Page No:
Alloycraft 110	1553.2: E7618-M	A5.5: E11018M H4R	52
Alloycraft 70-A1	1553.2: E4818-A1. H5R	A5.5: E7018-A1 H4R	47
Alloycraft 80-B2	1553.2: E5518-B2	A5.5: E8018-B2 H4R	48
Alloycraft 80-C1	1553.2: E5518-C1	A5.5: E8018-C1 H4R	49
Alloycraft 90	1553.2: E6218-M	A5.5: E9018M H4R	51
Alloycraft 90-B3	1553.2: E6218-B3	A5.5: E9018-B3 H4R	50
Autocraft AL1100 (Pure)	2717.2: E1100	A5.10: ER1100	118
Autocraft AL4043 (5% Sil)	2717.2: E4043	A5.10: ER4043	119
Autocraft AL5356 (5% Mag)	2717.2: E5356	A5.10: ER5356	120
Autocraft AL5183	2717.2: E5183	A5.10: ER5183	122
Arcair DC Carbons	---	---	68
Autocraft 2209	2717.3: E52209	A5.9: ER2209	117
Autocraft 307Si	2717.3: E5307Si	A5.9: ER307Si	113
Autocraft 308LSi	2717.3: E5308LSi	A5.9: ER308LSi	114
Autocraft 309LSi	2717.3: E5309LSi	A5.9: ER309LSi	115
Autocraft 316LSi	2717.3: E5316LSi	A5.9: ER316LSi	116
Autocraft CrMo1	2717.1: E5B2-GM-W559AH	A5.28: ER80S-B2	112
Autocraft Deoxidised Copper	---	A5.7: ERcu	123
Autocraft LW1	2717.1: E54-GC/M-W503AH	A5.18: ER70S-4	105
Autocraft LW1-6	2717.1: E56-GC/M-W503AH	A5.18: ER70S-6	107
Autocraft Mn-Mo	2717.1: E5D2-GM-W559AH	A5.28: ER80S-D2	110
Autocraft NiCrMo	2717.1: E5MG-GM-W769AH	A5.28: ER110S-G	111
Autocraft SA1	1858.1: EL12	A5.17: EL12	173
Autocraft SA2	1858.1: EM12K	A5.17: EM12K	174
Autocraft Silicon Bronze	---	A5.7: ERcuSi-A	124
Autocraft Super Steel	2717.1: E52-GM-W503AH	A5.18: ER70S-2	106
Bronzecraft AC-DC	2567: E6200-A2	A5.6: CuSn-C	67
Castcraft 100	---	A5.15: ENI-CI	66
Castcraft 55	---	A5.15: ENiFe-CI	65
ChromeBright (Pickling Paste)	---	---	224
Cobalarc 350	2576: 1435-A4	---	74
Cobalarc 650	2576: 1855-A4	---	75
Cobalarc 750	2576: 1860-A4	---	76
Cobalarc 1e	2576: 2360-A4	---	81
Cobalarc 9e	2576: 2460-A4	---	82
Cobalarc Austex	2576: 1315-A4	---	72
Cobalarc Borochrome	2576: 2560-A4	---	79
Cobalarc CR70	2576: 2355-A4	---	78
Cobalarc Mangcraft	2576: 1215-A4	---	73
Cobalarc Toolcraft	2576: 1560-A4	---	77
Comweld 2209	---	A5.9: ER2209	195
Comweld 308L Stainless Steel	1167.2: R308L	A5.9: ER308L	192
Comweld 309L Stainless Steel	1167.2: R309L	A5.9: ER309L	193
Comweld 316L Stainless Steel	1167.2: R316L	A5.9: ER316L	194
Comweld 40/60 Soft Solder	1834.1: 40Sn	---	212
Comweld 50/50 Soft Solder	1834.1: 50Sn	---	213
Comweld 965 Solder	1834.1: 96.5Sn / 3.5Ag	---	214
Comweld 965 Soldering Flux	---	---	220
Comweld AL1100 (Pure)	1167.2: R1100	A5.10: R1100	196
Comweld AL4043 (5% Sil.)	1167.2: R4043	A5.10: R4043	197
Comweld AL4047 (10% Sil.)	1167.2: R4047	A5.10: R4047	198
Comweld AL5356 (5% Mag.)	1167.2: R5356	A5.10: R5356	199
Comweld Aluminium Flux	---	---	216
Comweld Comcoat C	1167.1 & 2: RCuZn-C	A5.8 & 27: RBCuZn-C	203
Comweld Comcoat N	1167.1 & 2: RCuZn-D	A5.8 & 27: RBCuZn-D	207

**PRODUCT INDEX BY ALPHABETICAL**

Product Name	AS/NZS Classification	AWS/ASME-SFA Classification	Page No:
Comweld Comcoat T	1167.1 & 2: RCuZn-A	A5.8 & 27: RBCuZn-A	205
Comweld Copper and Brass Flux	---	---	217
Comweld CrMo1	1167.2: RB2	A5.28: ER80S-B2	190
Comweld CrMo2	1167.2: RB3	A5.28: ER90S-B3	191
Comweld G.P. Cast Iron Rod	1167.2: RC11	---	200
Comweld G.P. Silver Brazing Flux	---	---	219
Comweld Galvanising Bar	---	---	201
Comweld High Test	1167.2: R1	A5.2: R60	185
Comweld LW1	1167.2: R4	A5.18: ER70S-4	186
Comweld LW1-3	1167.2: R3	A5.18: ER70S-3	187
Comweld LW1-6	1167.2: R6	A5.18: ER70S-6	188
Comweld Manganese Bronze Rod	1167.1 & 2: RCuZn-C	A5.8 & 27: RBCuZn-C	202
Comweld Metal Mate Solder Kit	1834.1: 96.5Sn / 3.5Ag	---	215
Comweld Mild Steel	1167.2: RG	A5.2: R45	184
Comweld Nickel Bronze Rod	1167.1 & 2: RCuZn-D	A5.8 & 27: RBCuZn-D	206
Comweld Silicon Bronze Rod (801)	1167.2: RCuSi-A	A5.7: RCuSi-A	208
Comweld Silver Brazing Flux No. 2	---	---	218
Comweld Super Steel	1167.2: R2	A5.18: ER70S-2	189
Comweld Tobin Bronze Rod	1167.1 & 2: RCuZn-A	A5.8 & 27: RBCuZn-A	205
Comweld VAPAFUX	---	---	221
Ferrocrafft 11	1553.1: E4111-2	A5.1: E6011	36
Ferrocrafft 12XP	1553.1: E4112-0	A5.1: E6013	29
Ferrocrafft 16TXP	1553.1: E4816-2 H10	A5.1: E7016 H8	41
Ferrocrafft 21	1553.1: E4814-2	A5.1: E7014	34
Ferrocrafft 22	1553.1: E4824-2	A5.1: E7024	35
Ferrocrafft 55U	1553.1: E4816-2 H10	A5.1: E7016 H8	43
Ferrocrafft 61	1553.1: E4818-3 H10	A5.1: E7018	44
Ferrocrafft 61 H4	1553.1: E4818-5 H5 R	A5.1: E7018-1 H4 R	45
Ferrocrafft 61 Ni H4	1553.2: E4818-G H5	A5.5: E7018-G H4	46
Ferrocrafft 7016	1553.1: E4816-3 H10	A5.1: E7016 H8	41
GP 6012	1553.1: E4112-0	A5.1: E6013	28
Metal-Cor XP (*1.2mm only)	2203.1: *ETP-GMn/p-W503A. CM1 H5	A5.18: E70C-6M	150
	2203.1: ETD-GMn/p-W503A. CM1 H5	A5.18: E70C-6M	1150
Metal-Cor 5	2203.1: ETD-GMn/p-W505A. CM1 H5	A5.18: E70C-6M	152
Murex Speedex 12	1553.1: E4112-0	A5.1: E6013	30
Murex Speedex 13	1553.1: E4113-0	A5.1: E6013	31
Murex Speedex 308L-16	1553.3: E308L-16	A5.4: E308L-16	60
Murex Speedex 309L-16	1553.3: E309L-16	A5.4: E309L-16	61
Murex Speedex 312-16	1553.3: E312-16	A5.4: E312-16	63
Murex Speedex 316L-16	1553.3: E316L-16	A5.4: E316L-16	62
Nicore 55	equivalent electrode classification →	A5.15: ENiFe-CI	155
PipeArc 6010P	1553.1: E4110-2	A5.1: E6010	37
Satinarc 15 with Autocraft SA1	1858.1: EL12-FGH-W403A	A5.17: F6A2-EL12	176
Satinarc 15 with Autocraft SA2	1858.1: EM12K-FGH-W503A	A5.17: F7A2-EM12K	176
Satinarc 4 with Autocraft SA1	1858.1: EL12-FMM-W403A	A5.17: F6A2-EL12	175
Satinarc 4 with Autocraft SA2	1858.1: EM12K-FMM-W503A	A5.17: F7A4-EM12K	175
	---	A5.17: F6P4-EM12K	175
Satin-Cor XP	2203.1: ETD-GCp-W502A. CM1 H10	A5.20: E70T-1 H8	129
1.6mm only	2203.1: ETD-GMp-W502A CM1 H10	A5.20: E70T-1M H8	129
Satincraft 13	1553.1: E4113-0	A5.1: E6013	31
Satinchrome 308L-17	1553.3: E308L-17	A5.4: E308L-17	56
Satinchrome 309Mo-17	1553.3: E309Mo-17	A5.4: E309Mo-17	57
Satinchrome 316L-17	1553.3: E316L-17	A5.4: E316L-17	58
Satinchrome 318-17	1553.3: E318-17	A5.4: E318-17	59

## PRODUCT INDEX BY ALPHABETICAL

Product Name	AS/NZS Classification	AWS/ASME-SFA Classification	Page No:
Shield-Cor 11	2203.1: ETP-GNn-W500A. CM2	A5.20: E71T-11	158
Shield-Cor 15	2203.1: ETPS-GNn-W500A. CM2	A5.20: E71T-GS	160
Shield-Cor 4XP	2203.1: ETD-GNp-W500A. CM2 H15	A5.20: E70T-4	147
Shield-Cor 8XP	2203.1: ETD-GNn-W503A. CM1 H10	A5.20: E71T-8	156
Shield-Cor 8Ni	2203.1: ETD-GNn-W504A. Ni1 H10	A5.20: E71T-Ni1	157
Stoody 100 HC-O	2576: 2360-B7	---	90
Stoody 101 HC-G/O	2576: 2360-B5/B7	---	89
Stoody 104	2576: 1125-B1	---	93
Stoody 105	2576: 1445-B1	---	94
Stoody 107	2576: 1440-B1	---	95
Stoody 110 MC	2576: 1715-B7	---	92
Stoody 143-O	2576: 2460-B7	---	97
Stoody 145 Open Arc Wire	---	---	98
Stoody 600	2576: 1955-B7	---	96
Stoody 850-O	2576: 1865-B7	---	88
Stoody 965-G/O	2576: 1855-B5/B7	---	87
Stoody Buildup-O	2576: 1125-B7	---	85
Stoody Dynamang-O	2576: 1215-B7	---	84
Stoody Fineclad-O	2576: 2565-B7	---	91
Stoody RA45-O	2576: 1845-B7	---	99
Stoody 'S' Flux	---	---	100
Stoody SOS 308L	2576: 1315-B7	A5.22: E308LT0-3	168
Stoody SOS 309L	2576: 1315-B7	A5.22: E309LT0-3	169
Stoody Super Buildup-G/O	2576: 1435-B5/B7	---	86
Stoody Tube Borium	2576: 3460-A1	---	82
Supre-Cor 5	2203.1: ETP-GCn/p-W504A. CM1 H5 2203.1: ETP-GMn/p-W504A. CM1 H5	A5.20: E71T-5 H4 A5.20: E71T-5MJ H4	146 146
Supre-Cor XP H4	2203.1: ETP-GCn/p-W504A. CM1 H5 2203.1: ETP-GMn/p-W504A. CM1 H5	A5.20: E70T-5 H4 A5.20: E70T-5M H4	148 148
Tensi-Cor 110TXP H4	2203.1: ETD-GCp-W769A. K4 H5 2203.1: ETD-GMp/W769A. K4 H5	A5.29: E110T5-K4 A5.29: E110T5-K4 M H4	152 152
Verti-Cor 308LT	---	A5.22: E308LT1-1 A5.22: E308LT1-4	162 162
Verti-Cor 309LT	---	A5.22: E309LT1-1 A5.22: E309LT1-4	164 164
Verti-Cor 316LT	---	A5.22: E316LT1-1 A5.22: E316LT1-4	166 166
Verti-Cor 111K3 H4	2203.1: ETP-GMp-W768A. K3 H10	A5.29: E111T1-K3MH8	145
Verti-Cor 3XP	2203.1: ETP-GCp-W503A. CM1 H10 2203.1: ETP-GMp-W503A. CM1 H10	A5.20: E71T-1 H8 A5.20: E71T-12M H8	134 134
Verti-Cor 3XP H4	2205.1: ETP-GMp-W503A. CM1 H5	A5.20: E71T-12 M H4	136
Verti-Cor 81Ni 1	2203.1: ETP-GMp-W554A. Ni1 H10	A5.29: E81T1-Ni1 M	139
Verti-Cor 81Ni 1 H4	2203.1: ETP-GMp-W554A Ni1 H5 2203.1: ETP-GCp-W554A Ni1 H4	A5.29: E81T-1 Ni1 M H4 A5.29: E81T1-Ni1 H4	140 140
Verti-Cor 81 Ni2	2203.1: ETP-GMp-W559A Ni2 H10	A5.29: E81T-1 Ni2 M H8	142
Verti-Cor 91 K2 H4	2203.1: ETP-GMp-W629A K2 H5	A5.29: E91T-1 K2 M H8	144
Verti-Cor Ultra	2203.1: ETP-GCp-W502A. CM1 H10	A5.20: E71T-1 H8	132
Verti-Cor XP	2203.1: ETP-GCp-W503A. CM1 H10 2203.1: ETP-GMp-W503A. CM1 H10	A5.20: E71T-1 H8 A5.20: E71T-1M H8	130 130
Weldall	1553.3: E312-17	A5.4: E312-17	65
Weldcraft	1553.1: E4113-2	A5.1: E6013	32

## PACKAGING INFORMATION

### Pallet Weights of Electrodes:

12kg Cartons	= 85 Ctn per pallet	= 1,020kg
15kg Standard Cartons	= 72 Ctn per pallet	= 1,080kg
25kg Cartons	= 40 Ctn per pallet	= 1,000kg

### Average Pallet (Skid) Dimensions:

A	=	650mm
B	=	1,140mm
C	=	1,155mm
D	=	480mm

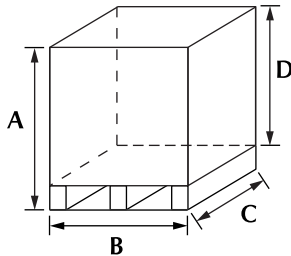

### MIG (GMAW) & Flux Cored (FCAW) Wires:

15kg Spools of MIG Wire	= 54 Spools per pallet	= 810kg
150kg AutoPaks of MIG Wire	= 4 Packs per pallet	= 600kg
250kg AutoPaks of MIG Wire	= 4 Packs per pallet	= 1,000kg
300kg AutoPaks of MIG Wire	= 4 Packs per pallet	= 1,200kg
13kg Spools of MIG Wire	= 54 Spools per pallet	= 702kg
25kg Coils of FCAW Wire	= 24 Coils per pallet	= 600kg
200kg AutoPaks of FCAW Wire	= 4 Packs per pallet	= 800kg
230kg AutoPaks of FCAW Wire	= 4 Packs per pallet	= 920kg

### Spool Dimensions:

SEE NEXT PAGE FOR SPOOL DIAGRAMS

CIGWELD Name		MiniSpool	HandiSpool	Spool	Coil
Spool Dimensions		ø100mm 4 Inch	ø200mm 8 Inch	ø270 or 300mm 12 Inch	ø400mm 16 Inch
A	Flange O.D.	100mm	200mm	270 or 300mm	400mm
B	Hub I.D.	16mm	52mm	52mm	300mm
C	Barrel Diameter	57mm	104mm	135 or 207mm	---
D	Width Outside	45mm	55mm	100mm	100mm
E	Width Inside	40mm	45mm	95mm	---
F	Engaging Hole	---	11mm	11mm	---
G	Hole offset	---	44mm	44mm	---
Weight Range		0.45-1kg	4.5-5kg	12.5-15kg	25-30kg

PACKAGING INFORMATION

SPOOL DIAGRAMS (not to scale):

MINISPOOLS, HANDISPOOLS & STANDARD SPOOLS:

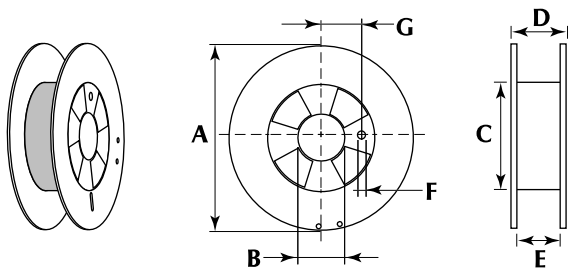

COIL:

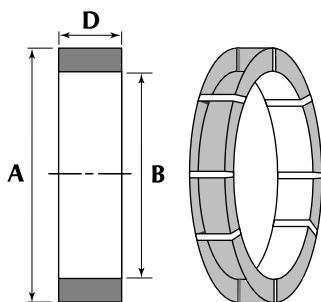

## COMPARABLE \* CONSUMABLES BY WELDING PROCESS

MMAW	GMAW	FCAW	GTAW
Speedex 12 (E6013)	Autocraft LW1/LW1-6 (ER70S-4/6)	Shield-Cor 15 (E71T-GS)	Comweld High Test (R60)
Speedex 13 (E6013)	Autocraft LW1/LW1-6 (ER70S-4/6)	Shield-Cor 11 (E71T-11)	Comweld High Test (R60)
Ferrocrafft 12XP (E6013)	Autocraft LW1/LW1-6 (ER70S-4/6)	Shield-Cor 15 (E71T-GS)	Comweld High Test (R60)
Satincraft 13 (E6013)	Autocraft LW1/LW1-6 (ER70S-4/6)	Shield-Cor 11 (E71T-11)	Comweld High Test (R60)
Ferrocrafft 21 (E7014)	Autocraft LW1/LW1-6 (ER70S-4/6)	Verti-Cor 3XP & 3XP H4 & XP (E71T-1 H8) (E71T-12 M)	Comweld LW1 (ER70S-4)
Ferrocrafft 22 (E7024)	Autocraft LW1/LW1-6 (ER70S-4/6)	Metal-Cor XP/ Metal-Cor 5 (E70C-6M)	Comweld LW1 (ER70S-4)
Ferrocrafft 7016 (E7016-1)	Autocraft Super Steel (ER70S-2)	Supre-Cor 5 (E71T-5 H4 & E71T-5 M H4)	Comweld Super Steel (ER70S-2)
Ferrocrafft 61 (E7018)	Autocraft Super Steel (ER70S-2)	Supre-Cor 5 (E71T-5 H4)	Comweld Super Steel (ER70S-2)
Alloycraft 80-B2 (E8018-B2)	Autocraft CrMo1 (ER80S-B2)	----	Comweld CrMo1 (ER80S-B2)
Alloycraft 90-B3 (E9018-B3)	Autocraft CrMo2 (ER90S-B3)	----	Comweld CrMo2 (ER90S-B3)
Alloycraft 90 (E9018-M)	—	Verti-Cor 91K2H4 (E91T1-K2 M H4)	—
Alloycraft 110 (E11018-M)	Autocraft NiCrMo (ER110S-G)	Tensi-Cor 110TXP (110T5-K4 & K4M)	—
Castcraft 55 (EniFe-CI)	—	Nicore 55 (ENiFe-CI)	Comweld G.P. Cast Iron (RC11)
—	Autocraft 2209 (ER2209)	—	Comweld 2209 (ER2209)
Satinchrome 308L-17 (E308L-17)	Autocraft 308LSi (ER308LSi)	Verti-Cor 308LT (E308LT1-1/4)	Comweld 308L (ER308L)
----	----	Stoody SOS 308L (E308LT)	----
Satinchrome 309Mo-17 (E309Mo-17)	Autocraft 309LSi (ER309LSi)	Verti-Cor 309LT (E309LT1-1)	Comweld 309L (ER309L)
----	----	Stoody SOS 309L (E309LT)	----
Satinchrome 316L-17 (E316L-17)	Autocraft 316LSi (ER316LSi)	Verti-Cor 316LT (E316LT1-1)	Comweld 316L (ER316L)
Speedex 308L-16 (E308L-16)	Autocraft 308LSi (ER308LSi)	Verti-Cor 308LT (E308LT1-1/4)	Comweld 308L (ER308L)
Speedex 309L-16 (E309L-16)	Autocraft 309LSi (ER309LSi)	Verti-Cor 309LT (E309LT1-1)	Comweld 309L (ER309L)
Speedex 316L-16 (E316L-16)	Autocraft 316LSi (ER316LSi)	Verti-Cor 316LT (E316LT1-1)	Comweld 316L (ER316L)
—	Autocraft AL1100 (ER1100)	—	Comweld AL1100 (ER1100)
—	Autocraft AL4043 (ER4043)	—	Comweld AL4043 (ER4043)

## COMPARABLE\* HARDFACING CONSUMABLES BY PROCESS

MMAW	FCAW	SAW	GTAW
—	Autocraft AL5356 (ER5356)	—	Comweld AL5356 (ER5356)
Bronzecraft AC-DC (ECuSn-C)	Autocraft Si Bronze (ERCuSi-A)	—	Comweld Si Bronze (RCuSi-A)
Cobalarc Mangcraft (1215-A4)	Stoody Dynamang (1215-B5 / B7)	—	—
----	Stoody Build-up-O (1125 B7)	Stoody 104 (1125 B1)	----
Cobalarc Austex (1315-A4)	Verti-Cor 309LT (E309LT1-1)	—	Comweld 309L (ER309L)
----	Stoody SOS 309L (E309LT)	----	----
Cobalarc 350 (1435-A4)	Stoody Super Buildup (1435-B5 / B7)	Stoody 105 (1445 B1)	—
Cobalarc 650 (1855-A4)	Stoody 965 G/O (1855-B5 / B7)	—	—
Cobalarc 750 (1860-A4)	Stoody 965 G/O (1855-B5 / B7)	—	—
Cobalarc CR70 (2355-A4)	Stoody 101 HC-G/O (2360-B5 / B7)	—	—
Cobalarc Borochrome (2560-A4)	Stoody Fineclad (2565-B7)	—	—

\* Comparable consumables may not be interchangeable for all welding applications. Please contact your local CIGWELD representative for advice regarding the suitability of specific process / consumable combinations for the particular application in question.

Note: **Autocraft 307si (GMAW)** can be used in many of the same applications as Cobalarc Austex and 309L/Lsi. Consult your CIGWELD representative for accurate recommendations.

## PRODUCT CERTIFICATION

Most CIGWELD welding consumables are approved by Lloyd's Register of Shipping (LRS), American Bureau of Shipping (ABS), and Det Norske Veritas (DNV) for use in ship building and general fabrication. These third party approvals are renewed annually at CIGWELD by completing a series of tests on various sizes of consumables under the supervision of a surveyor from each shipping and testing society. CIGWELD lists the relevant approvals to the above mentioned societies, as well as Australian and New Zealand (AS/NZS) and American (AWS/ASME-SFA) standards/classifications on the individual product data pages throughout this pocket guide.

The following lists Product Certification available from CIGWELD. There are four main certificates available, the most popular being the CONFORMANCE CERTIFICATE (BATCH) and the MATERIAL SAFETY DATA SHEET (MSDS). To obtain further information on CIGWELD Product Certificates please call or fax the following numbers: PH: 1300 654 674 FAX: +61 3 9474 7391



### Conformance Certificate:

Demonstrates that the product complies to relevant Standards, Regulations and Specifications. The certificate certifies that the product supplied is equivalent to that used in annual Shipping Society approval tests (ABS/DNV/LRS) and/or Standards Conformance tests (AS/NZS & AWS). Includes conformance test results. Available for all manufactured main line products. "Issued Free Of Charge".

### Quality Assurance Certificate:

Is only issued where Conformance Certificates are not available. Results are derived from CIGWELD's internal batch testing procedures. The results quoted are normally chemical analysis and limited mechanical properties.

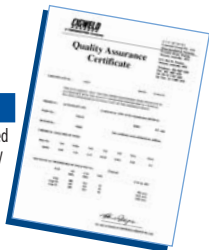

### EN 10204 & ISO 10474 3.1 (formerly 3.1b) Certificates

The content of these certificates is agreed upon by the customer and the manufacturer and must be requested at the time of ordering.

Certificates showing actual chemistry fall into the Conformance / Quality Assurance Certificate group but Certificates showing actual mechanical values may fall under the Special Test report category. Please consult your Cigweld representative.



### Special Test Report:

Includes results of tests carried out to relevant Standards and specific customer requirements. Tests can be quite extensive (eg. product for certain applications may require tests for weld metal composition, mechanical properties, diffusible hydrogen, x-ray soundness etc.)

The "Fee charged" for a Special Test Report will depend on the specific tests carried out.



### Material Safety Data Sheets (MSDS):

Provides information on the products and the hazards associated with them to allow the safe handling and use of the products at work. The MSDS describes the identity, physical and chemical properties and uses of the product, health hazard information, precautions for use and safe handling information. "Issued Free Of Charge".



## STORAGE, CARE & CONDITIONING OF ELECTRODES

### 1. Introduction

- ▲ During manufacture, CIGWELD electrodes are baked at specific temperatures to either virtually eliminate any moisture, eg. hydrogen controlled types, or reduce moisture to a predetermined low level eg. general rutile type electrodes.
- ▲ Electrode coatings exposed to the atmosphere however, will gradually absorb moisture. Moisture resistant (MR) type flux coatings will be more resistant to moisture re-absorption and flux coating rehydration.

#### 1.1 Excessive moisture in electrodes may produce one or more of the following effects:

- |  |                                 |
|--|---------------------------------|
| ▲ Introduction of hydrogen into weld metal with increased danger of heat affected zone cracking. | ▲ Spalling of flux coating.     |
| ▲ Porosity in weld metal.  | ▲ Fiery unstable arc.           |
| ▲ Blistering of electrode tip.   | ▲ High arc voltage.             |
| ▲ Formation of "white fur" on the flux coating.  | ▲ Excessive spatter.            |
|  | ▲ Difficulty with slag removal. |
|  | ▲ Undercut.                     |

Electrodes indicating any of the above should be reconditioned following the procedures set out in this recommendation, which will usually return the electrodes to their original as manufactured condition.

### 2. Before Work Commences

#### 2.1 Before using CIGWELD electrodes, the welder should be aware of the following points regarding handling:

- 2.1.1 CIGWELD electrodes should be kept dry and clean at all times, free of moisture, grease, oil, paint, grinding dust and condensation.
- 2.1.2 Electrodes which show visible signs of mechanical damage, appear wet or moist and show signs of rust (especially on hydrogen controlled electrodes) should not be used for welding.
- 2.1.3 Product which shows visible signs of damage (ie water or otherwise) should be returned to the supervisor or person responsible for inspection and possible reconditioning before approval for use.

### 3. Storage of CIGWELD Electrodes Before Use

- 3.1 When held under the recommended storage conditions\*, original unopened packs of CIGWELD electrodes are expected to remain in "factory fresh" condition for at least 12 months and hermetically sealed containers indefinitely.

#### \* Recommended Storage Conditions:

In weather proof, unheated storage rooms/cupboards/containers/warehouses. Stacked on racks or pallets clear of the floor and walls.

## STORAGE, CARE & CONDITIONING OF ELECTRODES

### 3. Storage of CIGWELD Electrodes Before Use cont.

- 3.2 For storage over twelve (12) months or under adverse (damp or high humidity) climatic conditions, the use of heated, store rooms/cupboards/containers/ warehouses maintained at the following parameters are recommended:

#### 3.3 Storage Table

**Section A:** Electrodes should be kept at 10-15°C (50-60°F) above ambient temperature with a maximum of 60°C (140°F) and at a maximum humidity of 60% R.H.

Speedex 12 GP 6012 Feroecraft 12XP Speedex 13 Satincraft 13 Weldcraft	Arcair DC Carbons Cobalarc, Extruded electrode Range Castcraft, Cast Iron Range Bronzecraft AC-DC Feroecraft 21 Feroecraft 22
--	--

**Section B:** Electrodes should be kept at 10-15°C (50-60°F) above ambient temperature with a maximum of 40°C (105°F) and at a maximum humidity of 60% R.H.

Feroecraft 11	PipeArc 6010P
---------------	---------------

**Section C:** Electrodes should be kept at 10-15°C (50-60°F) above ambient temperature with a maximum of 40°C (105°F) and at a maximum humidity of 50% R.H.

Feroecraft 16TXP Alloycraft 80-B2 Alloycraft 80-C1 Alloycraft 90-B3 Feroecraft 61 Satinrome, Stainless Steel Range Speedex Stainless Steel Range	Feroecraft 7016 Feroecraft 55U Alloycraft 90 Alloycraft 110 Feroecraft 61 Ni H4 Feroecraft 61 H4 Weldall Speedex 16
--	--

### 4. Conditioning of CIGWELD Electrodes

- 4.1 The term conditioning refers to special treatments sometimes given to electrodes prior to use in critical applications. In practice, conditioning treatments are rarely applied to any but basic coated (low hydrogen) electrodes when they are to be used for applications requiring specific hydrogen controlled levels eg.  $\leq 5$  mls  $H_2$  /100g of Deposited Weld Metal.

In high temperature baking basic coated electrodes, it is important not to exceed the recommended maximum of temperature and time as this can result in chemical changes in the coatings which will permanently impair electrode performance. For the same reason, it is not advisable to repeatedly high temperature bake hydrogen controlled electrodes.

CIGWELD hydrogen controlled electrodes have a very robust flux construction and as a result they can be redried generally between 2 to 3 times.

## STORAGE, CARE & CONDITIONING OF ELECTRODES

### 4. Conditioning of CIGWELD Electrodes cont.

Conditioning should be carried out in ventilated air ovens or hot boxes (see paragraph 6.1.2) set at a starting temperature of 100°C (210°F) and then raised to the correct temperatures for the various types of electrodes (as in Table 4.2). Electrodes should be unpacked and spaced evenly onto trays or racks, avoiding deep layering of electrodes so as to enable even drying.

#### 4.2 CIGWELD Electrode Reconditioning Table

##### Section A: General Purpose Electrodes

The electrodes in this group normally do not require reconditioning before use if stored correctly, however if electrodes absorb moisture and require reconditioning, heat to 135°C ± 20°C (275°F ± 70°F) and hold for 1-1½ hours. \*General purpose electrodes can be overried so restrict the maximum temperature to 155°C.

Speedex 12	Weldcraft
GP 6012	Cobalarc, Extruded electrode Range
Ferrocrafft 12XP	Ferrocrafft 21
Speedex 13	Ferrocrafft 22
Satincraft 13	Arcair DC Carbons

##### Section B: Cast Iron and Bronze Electrodes

The electrodes in this group do not require reconditioning before use if stored correctly, however if electrodes absorb moisture and require reconditioning heat to 95°C ± 10°C (200°F ± 50°F) and hold for 1-1½ hours.

Castcraft, Cast Iron Range	Bronzecraft AC-DC
----------------------------	-------------------

##### Section C: Cellulose Electrodes

CIGWELD Cellulose Coated electrodes again do not normally require reconditioning before use if stored correctly, and actually rely upon a small percentage of moisture in the flux coating to obtain precise operating parameters. Reconditioning is not recommended, but if required please consult the CIGWELD Welding Consumables factory for more information.

Ferrocrafft 11	
PipeArc 6010P	

##### Section D: Stainless Steel Electrodes

The electrodes in this group if required may be reconditioned by heating to 250°C ± 20°C (480°F ± 70°F) and hold for 1-2 hours.

Satinrome range	Weldall
Speedex range	

##### Section E: Hydrogen Controlled Electrodes - Low Hydrogen Status

Electrodes that are capable of meeting AS/NZS 1553.1 low "H<sub>10</sub>" hydrogen classification and AWS A5.1 "H<sub>8</sub>" status, should be reconditioned by heating to 300°C ± 15°C (570°F ± 60°F) and holding for 2 hours and thereafter use from a hot box set at 100-120°C (210-250°F).

Ferrocrafft 16TXP	Ferrocrafft 61
Ferrocrafft 7016	
Ferrocrafft 55U	

## STORAGE, CARE & CONDITIONING OF ELECTRODES

### 4. Conditioning of CIGWELD Electrodes cont.

#### Section F: Hydrogen Controlled Electrodes - Very Low Hydrogen Status

Electrodes that are capable of meeting AS/NZS 1553.1 low "H<sub>5</sub>" hydrogen classification and AWS A5.1 "H<sub>4</sub>" status, should be reconditioned by heating to 350°C ± 15°C (660°F ± 60°F) and holding for 2 hours and thereafter use from a hot box set at 100-120°C (210-250°F).

Alloycraft 80-C1	Alloycraft 90-B3
Alloycraft 90	Alloycraft 80-B2
Alloycraft 110	Ferrocrafft 61 H4
Alloycraft 70-A1	Ferrocrafft 61 Ni H4

**Section G:** CIGWELD hermetically sealed containers, which are known to be airtight on initial opening may, where good workshop practice is adopted, be used for critical welding without reconditioning, provided the containers are first opened immediately prior to use, ensuring that the electrodes are not used in adverse (high temperature or high humidity) climatic conditions less than at 30-35°C (85-95°F) and a maximum humidity of 80% RH. Once opened, electrodes should be used within a maximum of 4 hours. Thereafter, if "H<sub>4</sub>" or "H<sub>5</sub>" levels of diffusible hydrogen are a critical requirement, electrodes should be reconditioned as described in paragraph 4.2, Section F.

### 5. After Reconditioning

CIGWELD electrodes which have been reconditioned and are not required for immediate use, must be either placed in heated storage or stored in airtight containers at ambient temperatures, following the recommendations in paragraph 2.

### 6. Work In Progress

- 6.1 Once work has commenced, it is recommended good workshop practice where possible to draw only those electrodes which are estimated "sufficient" for the immediate job at hand, whether those electrodes be from a holding oven or packets and cartons.
  - 6.1.1 CIGWELD products for heating and storage:
    - a. VB1689 portable drying oven, maximum temperature 120°C (250°F).
    - b. VB1690 bench drying oven, maximum temperature 260°C (500°F).
- 6.2 Electrodes which show signs of moisture absorption as in paragraph 1 (1.1) should be quarantined and reconditioned as in paragraph 4.

For further information regarding CIGWELD electrodes, please contact the CIGWELD Customer Service Centre on 1300 654 674.

## STORAGE, CARE & CONDITIONING OF ELECTRODES

### Recommended Storage and Care of CIGWELD Welding Wires and Rods:

- ▲ Gas Metal Arc Welding (GMAW / MIG)
- ▲ Flux Cored Arc Welding (FCAW)
- ▲ Gas Tungsten Arc Welding (GTAW / TIG)

### 1. Introduction

#### CIGWELD Solid Welding Wires and Rods

Generally solid welding wires and rods as used for MIG and TIG welding will not pick up moisture or contaminants until the original packs are opened and this is normally limited to surface contamination mainly in the form of condensation, rust, oil and grease or other hydrocarbons. When solid welding wires and rods are kept clean, dry and free of airborne contaminants the welding consumable will provide\* consistent, reliable hydrogen levels and sound weld metal.

\*The proviso in MIG and TIG welding to achieving a quality weld are the other variables such as equipment set-up, parent metal, correct choice of welding consumable, operator technique and shielding gas quality.

#### CIGWELD Flux Cored Arc Welding Wires

CIGWELD Flux Cored welding wires are fabricated from selected high quality flux core ingredients and low residual steel strip. Raw material selection, storage and handling and manufacturing processes are closely controlled to ensure very low moisture levels in the final product.

CIGWELD Flux Cored welding wires are manufactured to tight size tolerances from steel strip and as such have a closed seam which runs along the length of the wire. Under conditions of prolonged exposure (several days) to a high humidity atmosphere (> 70% RH) it is possible for the flux core to absorb moisture through the closed seam.

#### 1.1 Excessive moisture in CIGWELD flux cored wires may produce one or more of the following effects:

- |  |                       |
|--|-----------------------|
| ▲ Introduction of hydrogen into weld metal with increased danger of heat affected zone cracking. | ▲ Fiery unstable arc. |
| ▲ Porosity in weld metal.  | ▲ High arc voltage.   |
|  | ▲ Excessive spatter.  |
|  | ▲ Undercut.           |

### 2. Before Work Commences

#### 2.1 Before using CIGWELD welding wires, the welder should be aware of the following points regarding handling:

- 2.1.1 CIGWELD welding wires should be kept dry and clean at all times, free of moisture, grease, oil, paint, grinding dust, condensation and other airborne particles.
- 2.1.2 Welding wires which show visible signs of mechanical damage or display excessive surface rust should not be used for welding.
- 2.1.3 In some cases where packaging has been damaged either in transit or during storage/handling the surface of the outer layers of the wire and rod may form an oxide film, which can cause poor feedability and current pick up. Increases in hydrogen levels in the weld deposit from this oxide film may occur.
- 2.1.4 Product which shows visible signs of damage (i.e. water or otherwise) should be returned to the supervisor or person responsible for inspection and approval for use.

## STORAGE, CARE & CONDITIONING OF ELECTRODES

### 3. Storage of CIGWELD Welding Wires Before Use

- 3.1 When held under the recommended storage conditions\*, original unopened packs of CIGWELD welding wires are expected to remain in "factory fresh" condition for at least 12 months.

**\* Recommended Storage Conditions:**

In weather proof, unheated storage rooms/cupboards/containers/warehouses. Stacked on racks or pallets clear of the floor and walls.

- 3.2 For storage over twelve (12) months or under adverse (damp or high humidity) climatic conditions, the use of heated, store rooms/cupboards/containers/warehouses maintained at 10-15°C (50-60°F) above ambient temperature (with a maximum of 40°C (105°F) and at a maximum humidity of 60% R.H is recommended:

### 4. Work In Progress

- 4.1 After opening, CIGWELD Welding Wires and Rods are normally consumed in two ways;

- (a) either the welding consumable is used the same day or;
- (b) a portion of the welding consumable is left on or near the welding machine overnight or for an extended period of time.

- 4.1.1 The following points are recommended as good workshop practice when welding wires and rods are used on the job.

(a) In the case of FCAW and MIG welding the welding consumable should be protected at all times from contaminants, such as moisture and airborne particles, by either enclosing the wire in a sealed wirefeeder unit or by using PVC, leather or canvas spool covers which are standard on most MIG welding machines. Periodic cleaning of the underside of spool covers is recommended by appropriate means.

(b) For TIG welding it is recommended good workshop practice where possible to draw only those welding rods which are estimated "sufficient" for the immediate job at hand, those welding rods not required for immediate use, should be either kept in their original resealable packets or stored in airtight containers at ambient temperatures following the recommendations in paragraph 3.

- 4.1.2 For FCAW and MIG welding wires left on welding machines:

(a) Overnight: Wires should be covered with spool covers or if in areas of adverse weather or climatic conditions the wire should be stored as below.

(b) Extended periods: Wires which are not used for periods in excess of three days\* should be first removed from the welding machine ensuring that the wire is cut off at the wirefeeder unit\*\*. Wires should then be repacked in their original packaging as follows:

- Wrap the wire with any Vapour Phase Inhibitor (VPI) paper supplied.
- Replace the wire in the original thick plastic bag and seal with an elastic band.
- Pack into the original resealable cardboard packet and store as in paragraph 3.

\* Maximum exposure time will be dependant on prevailing atmospheric conditions (i.e.. Temperature and humidity).

\*\*This is done so no contaminated wire comes into contact with the clean wire on the spool or coil. Feed rollers deform the surface of the wire, which normally runs through a spring steel conduit which are from time to time cleaned out with compressed air, which itself contains oil, or hydrocarbon containing mineral spirits.

For further information regarding CIGWELD electrodes, please contact the CIGWELD Customer Service Centre on 1300 654 674.

## WELDING POSITION SYMBOLS

For fillet and butt welding applications - manual electrodes:

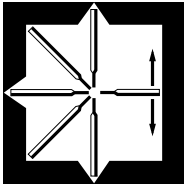

All Positional

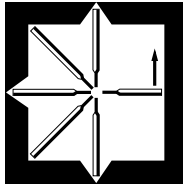

All Positional Except  
Vertical Down

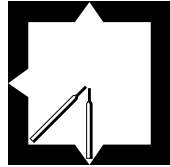

Downhand

For hard surfacing applications - electrodes and tubular wires:

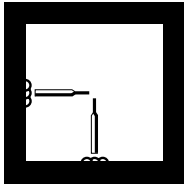

Downhand &  
Horizontal

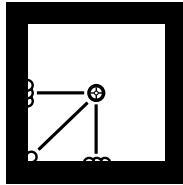

Downhand &  
Horizontal

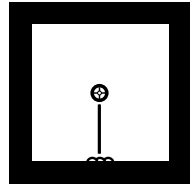

Downhand

For fillet and butt welding applications - GMAW and FCAW wires:

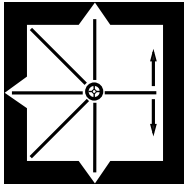

All Positional  
Welding Applications

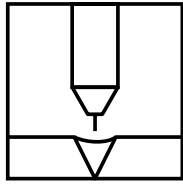

Flat

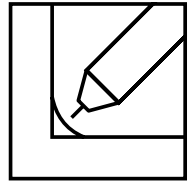

HV Fillet

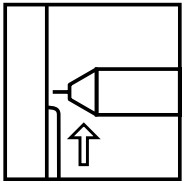

Vertical Up

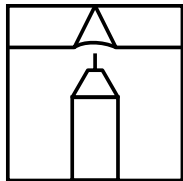

Overhead

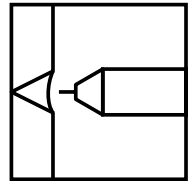

Horizontal

MUREX WELDING POSITION SYMBOLS



DOWNHAND



HORIZONTAL



VERTICAL



OVERHEAD



HORIZONTAL/  
VERTICAL



VERTICAL  
DOWN

HEADING BAR ICONS



Alternating Current



Direct Current negative or positive



Direct Current electrode negative



Direct Current



Alternating or Direct Current electrode positive



Open Current Voltage



Alternating and Direct Current



Alternating or Direct Current electrode negative



Open Circuit Voltage rating



Alternating or Direct Current



Direct Current electrode positive



Weld Metal hardness



Requires no gas shielding



Requires gas shielding



Copper Coated Wire



Thermal conductivity



Melting point



## SHIPPING SOCIETY APPROVALS

CIGWELD product	AS/NZS Class	AWS Class	Shielding gas for Approvals	ABS Grade	LRS Grade	DNV Grade
<b>Manual Arc Electrodes</b>						
Ferrocrafter 11	1553.1: E4111-2	A5.1: E6011	-	3 / A5.1 E6011	3, 3Y	3
GP6012	1553.1: E4112-0	A5.1: E6013	-	2	2	2
Ferrocrafter 12XP	1553.1: E4112-0	A5.1: E6013	-	2, 2Y / A5.1 E6013	2, 2Y	2
Saitincraft 13	1553.1: E4113-0	A5.1: E6013	-	2 / A5.1 6013	2	2
Weldcraft	1553.1: E4113-2	A5.1: E6013	-	3	3	3
Ferrocrafter 21	1553.1: E4814-2	A5.1: E7014	-	3 / A5.1 E7014	3	3
Ferrocrafter 22	1553.1: E4824-2	A5.1: E7024	-	2, 2Y / E7024	3	3
PipeArc 6010P	1553.1: E4110-2	A5.1: E6010	-	3 / A5.1 E6010	3	3
Ferrocrafter 16TYP	1553.1: E4816-2	A5.1: E7016	-	3H10, 3Y	3, 3YH15	3YH10
Ferrocrafter 55U	1553.1: E4816-2	A5.1: E7016	-	-	3, 3YH15	3YH10
Ferrocrafter 7016	1553.1: E4816-3	A5.1: E7016	-	3H10, 3Y	3YH10	3YH10
Ferrocrafter 61	1553.1: E4818-3	A5.1: E7018	-	3H15, 3Y / A5.1 E7018	3, 3YH15	3YH10
Ferrocrafter 61 H4	1553.1: E4818-1	A5.1: E7018-1	-	3H5, 3Y,	3, 3YH5	3YH5
Ferrocrafter 61 Ni H4	1553.1: E4818-G	A5.5: E7018-G	-	-	3, 3YH15	-
Alloycraft 80-C1	1553.2: E5518-C1	A5.5: E8018-C1	-	A5.5 E8018-C1	-	-
Saitincrome 308L-17	1553.3: E308L-17	A5.4: E308L-17	-	A5.4: E308L-17	-	-
Saitincrome 309Mo-17	1553.3: E309Mo-17	A5.4: E309Mo-17	-	A5.4: E309Mo-17	-	-
Saitincrome 316L-17	1553.3: E316L-17	A5.4: E316L-17	-	A5.4: E316L-17	-	-
<b>Gas Metal Arc Welding (MIG) Wires</b>						
Autocraft LW1	2717.1: E54-GC/M-W503AH	A5.18: ER70S-4	CO <sub>2</sub> , Argon + 25%CO <sub>2</sub>	3SA	3S	IIYMS
Autocraft LW1-6	2717.1: E56-GC/M-W503AH	A5.18: ER70S-6	CO <sub>2</sub> , Argon + 25%CO <sub>2</sub>	3S, 3YSA	3S, 3Y5	IIYMS
Autocraft AL5356	2717.2: E5356	A5.10: ER5356	Argon	A5.10: ER5356	A5.10: ER5356	A5.10: ER5356

# SHIPPING SOCIETY APPROVALS

CIGWELD product	AS/NZS Class	AWIS Class	Shielding gas for Approvals	ABS Grade	LRS Grade	DNV Grade
<b>Flux Cored Arc (FC) Welding Wires</b>						
Satnacor XP	2203.1: ETD-GCp-W502A CM1 H10	A5.20: E70T-1H8	CO2	2SAH10, 2YSAH10 3A, 3YA E70T-1 2YS	2S	-
Verticor XP	2203.1: ETP-GCp-W503A CM1 H10	A5.20: E71T-1H8	CO2	3SA 3YSA	3S, 3YS H10	IIIYMS H10
Verticor Ultra	2203.1: ETP-GM/p-W503A CM1 H10	A5.20: E71T-1M H8	Argon + 20% CO2	3SA, 3YSA	3S, 3YS	IIIYMS
Verticor 3XP	2203.1: ETP-GCp-W502A CM1 H10	A5.20: E71T-1H8	CO2	2YSA H10	2YS H10	IIYMS H
Verticor 3XP H4	2203.1: ETP-GCp-W503A CM1 H10	A5.20: E71T-1 H8	Argon + 20% CO2	3S, 3YS H10	3S, 3YS H10	IIIYMS H
Verticor81 Ni1 H4	2203.1: ETP-GM/p-W503A CM1 H4	A5.20: E71T-12M H8	Argon + 20% CO2	3SA, 3YSA H	3S, 3YS	IIIYMS H
Suprecor 5	2203.1: ETP-GM/p-W505A Ni1 H5	A5.20: E71T-12M H4	Argon + 20% CO2	3SA, 3YSA H5	3S, 3YS H5	IIIYMS H
Suprecor XP H4	2203.1: ETP-GM/p-W554A Ni1 H5	A5.29: E81T-1 Ni1 H4	CO2	4YSA H5	4Y40S H10	
(2.4mm only)	2203.1: ETP-GCp-W554A Ni1 H5	A5.29: E81T-1 Ni1 M H4	Argon + 20% CO2	4YSA H5	3S, 3YS H5	
Metal-Cor XP	2203.1: ETP-GCn/p-W505A CM1 H5	A5.20: E71T-5 H4	CO2	3SA, 3YSA H	3S, 3YS H	IIIYMS H
Metal-Cor 5	2203.1: ETP-GMn/p-W505A CM1 H5	A5.20: E71T-5M H4	Argon + 20% CO2	3SA, 3YSA H	3S, 3YS H	IIIYMS H
	2203.1: ETP-GCn/p-W504A CM1 H5	A5.20: E70T-5 H4	CO2	4SA, 4YSA H5	3S, 4YS H5	-
	2203.1: ETP-GMn/p-W504A CM1 H5	A5.20: E70T-5M H4	Argon + 20% CO2	4SA, 4YSA H5	3S, 4YS H5	
	2203.1: ETD-GMn/p-W503A CM1 H5	A5.18: E70C-6M H4	Argon + 20% CO2	3SA, 3YSA	3S, 3YS	IIIYMS
	2203.1: ETD-GMn/p-W505A CM1 H5	A5.18: E70C-6M H4	Argon + 20% CO2	4SA, 4YSA H5	3S, 4YS H4	IVYMS H5
<b>Gas Tungsten Arc (TIG) rods</b>						
Comweld AL5356	1167.2: R5356	A5.10: R5356	-	A5.10: R5356	-	-



<b>Description</b>	<b>Page No</b>
GP 6012	28
Ferrocrafft 12XP	29
Speedex 12	30
Satincrafft 13	31
Weldcrafft	32
Speedex 13	33
Ferrocrafft 21	34
Ferrocrafft 22	35
Ferrocrafft 11	36
PipeArc 6010P	37

## GP 6012

45  
OCVDC  
AC

- ▲ General Purpose Versatile Electrode.
- ▲ High Operator Appeal!
- ▲ All Positional Welding Capabilities.
- ▲ Ideal for the Vertical-Down Welding of Thin Steel Sections.
- ▲ Quite, Smooth Arc Action.
- ▲ Excellent for welding joints with poor fit-up.

## Classifications:

AS/NZS 1553.1: E4112-0.  
AWS/ASME-SFA A5.1: E6013.

## Description and Applications:

GP 6012 is a versatile, user friendly, G.P. electrode, suitable for welding in all positions. GP 6012 has a unique flux coating that offers exceptional welder appeal and makes for easy welding of the most difficult jobs.

Features include:

- ◆ Quick freezing, self releasing slag for exceptional control when welding in the vertical-down and other difficult positions.
- ◆ Excellent slag detachability under high heat build-up conditions.
- ◆ Superb for welding joints with poor fit-up (gaps and misalignment etc).
- ◆ Easy arc starting and stability on low voltage (greater than 45 O.C.V.) AC current welding machines.
- ◆ Medium penetrating arc, useful for welding thin and light gauge steels.
- ◆ Impressive touch welding capabilities.

Due to GP 6012's host of versatile features it is suitable for a wide range of welding applications in the light to medium structural steel industry including,

- ◆ Wrought iron furniture,
- ◆ Mild steel plate, sheet metal and galvanised iron sheet,
- ◆ Rolling stock and railway maintenance work,
- ◆ Square or rectangular hollow tube sections (RHS etc),
- ◆ Pipes and low pressure pipelines,
- ◆ Ducting, hoppers and tanks,
- ◆ Plus a wide range of G.P. welding applications such as, gates, security grills, barbecues, trolleys, letter boxes, trestles, billy carts, shelved storage units etc.

## Packaging and Operating Data:

AC (minimum 45 O.C.V.), DC+ or DC- polarity.

Electrode Size mm	Electrode Length mm	Approx No. Rods/kg	Current Range (amps)	Packet	Carton	Part No
2.5	300	55	55-80	5kg	15kg - 3 x 5kg	611142
3.2	380	30	90-130	5kg	15kg - 3 x 5kg	611143
4.0	380	19	130-180	5kg	15kg - 3 x 5kg	611144

## APPROVALS:

Lloyds Register of Shipping	Grade 2.
American Bureau of Shipping	Grade 2.
Det Norske Veritas	Grade 2.

## TYPICAL ALL WELD METAL MECHANICAL PROPERTIES:

Yield Stress	430 MPa
Tensile Strength	490 MPa
Elongation	29%
CVN Impact Values	80J av @ 0°C.

## TYPICAL ALL WELD METAL ANALYSIS:

C: 0.07%	Mn: 0.45%	Si: 0.30%
----------	-----------	-----------

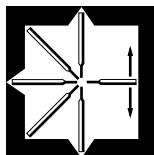

All positional - welding

- ▲ General Purpose "XP series" Electrode.
- ▲ Easy Striking - Hot or Cold!
- ▲ Xtra smooth Performance (XP).
- ▲ Versatile - All Positional Capabilities.
- ▲ Ideal for Vertical Down Fillet Welding.
- ▲ RED flux colour for easy I.D.

### Classifications:

AS/NZS 1553.1: E4112-0.  
 AWS/ASME-SFA A5.1: E6013.

### Description and Applications:

Ferrocraft 12XP is an Xtra smooth Performance (XP) general purpose electrode manufactured at CIGWELD's Welding Consumables Plant. It offers smooth, stable running and superb fillet shapes in all welding positions including vertical down/up and overhead.

Ferrocraft 12XP is recommended for all your general purpose repair, maintenance and fabrication welding jobs around the home, workshop, farm, fabshop and jobbing shop. It is the ideal vertical-down fillet welding electrode producing a fast freezing viscous slag.

Typical applications of Ferrocraft 12XP include the all positional fillet welding of steel furniture, plates, fences, gates, pipes and tanks etc.

### Packaging and Operating Data:

AC (minimum 45 O.C.V.), DC+ or DC- polarity.

Electrode Size mm	Electrode Length mm	Approx Rods/Kg	Current Range (amps)	Packet	Carton	Easyweld Handipak	Part No
2.0	300	95	40-70	half pack 2.5kg	15kg - 6 x 2.5kg		612231
						90 Rods	322128
2.5	300	55	60-100	5kg	15kg - 3 x 5kg		611232
2.5	300	55	60-100	half pack 2.5kg	15kg - 6 x 2.5kg		612232
				1kg			322129
3.2	380	30	90-130	5kg	15kg - 3 x 5kg		611233
3.2	380	30	90-130	half pack 2.5kg	15kg - 6 x 2.5kg		612233
				1kg			322138
4.0	380	19	130-180	5kg	15kg - 3 x 5kg		611234

### Easyweld Blister Pack:

10 x 2.5mm/5 x 3.2mm rod Ferrocraft 12XP Blister Pack 322123

### APPROVALS:

Lloyds Register of Shipping	Grade 2, 2Y.
American Bureau of Shipping	Grade 2, 2Y.
Det Norske Veritas	Grade 2.
American Bureau of Shipping	AWS A5.1 E6013.

### TYPICAL ALL WELD METAL MECHANICAL PROPERTIES:

Yield Stress	460 MPa
Tensile Strength	500 MPa
Elongation	27%
CVN Impact Values	75J av @ 0°C.

### TYPICAL ALL WELD METAL ANALYSIS:

C: 0.07%    Mn: 0.60%    Si: 0.50%

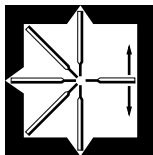

All positional - welding

# MUREX™

- ★ Speedex™ 12 is a user friendly E4112/E6013 electrode.
- ★ For fillet and butt welding in all positions including vertical down.
- ★ Ideal for the welding of thin steel.
- ★ Speedex™ 12 produces a quiet smooth arc with low spatter loss.
- ★ Excellent for misaligned joints.
- ★ Quick freezing, self detaching slag.
- ★ For use on welding machines with a 45 O.C.V. rating or greater.
- ★ Suitable for welding mild steel, sheet metal, galvanised iron, wrought iron, RHS tubing.
- ★ Uses for Speedex™ 12 include tanks, gates, trailers, ornamental iron work, back yard projects, frames etc.

#### CLASSIFICATIONS:

AS/NZS 1553.1:	E4112-0.
AWS A5.1:	E6013.

#### MECHANICAL PROPERTIES (TYPICAL):

Yield Stress	430 MPa
Tensile Strength	490 MPa
Elongation	29%
CVN Impact Values	80J av @ 0°C

#### CHEMICAL ANALYSIS (TYPICAL):

C: 0.07%	Mn: 0.45%
Si: 0.30%	

#### PART NUMBERS:

2.5mm (5kg)	SP1225
2.5mm (2.5kg)	SP12125
2.5mm (1kg)	SP12251
3.2mm (5kg)	SP1232
3.2mm (2.5kg)	SP12132
3.2mm (1kg)	SP12321
4.0mm (5kg)	SP1240

#### WELDING POSITIONS



DOWNHAND



HORIZONTAL



VERTICAL



OVERHEAD

HORIZONTAL/  
VERTICALVERTICAL  
DOWN

#### OPERATING PARAMETERS & PACKAGING DETAILS:

Ø (mm)	Amperage	Polarity	OCV	Length (mm)	Pk	Carton
2.5	55-80	AC /DC electrode +/-	45A min	300	5kg	15kg
2.5	55-80			300	2.5kg	15kg – 6 x 2.5kg
3.2	90-130	AC /DC electrode +/-	45A min	380	5kg	15kg
3.2	90-130			380	2.5kg	15kg – 6 x 2.5kg
4.0	130-180	AC /DC electrode +/-	45A min	380	5kg	15kg

- ▲ General Purpose, Rutile Type Electrode.
- ▲ Outstanding Operator Appeal!
- ▲ Versatile - All Positional Capabilities.
- ▲ Smooth Mitre Fillet Welds with Low Spatter.
- ▲ BLUE flux colour for instant I.D.

### Classifications:

AS/NZS 1553.1: E4113-0.  
AWS/ASME-SFA A5.1: E6013.

### Description and Applications:

Flat, horizontal-vertical, vertical-up and overhead - you can weld in any position with SatinCRAFT 13.

That's the beauty of Australia's most popular G.P. electrode.

Operating with either AC (min 45 O.C.V.) or DC current, SatinCRAFT 13 produces smooth professional mitre fillet welds in all positions (except vertical-down) with very low spatter levels, positive re-strike (hot or cold) and self-releasing slag.

Applications include the general workshop, field and structural welding of mild or galvanised steel

components such as pipes, tanks, frames, fences and gates etc. SatinCRAFT 13 is particularly recommended for the lap and fillet welding of thin walled galvanised and mild steels where the low spatter levels and excellent edge wetting produce superior results.

### APPROVALS:

Lloyds Register of Shipping	Grade 2.
American Bureau of Shipping	Grade 2.
Det Norske Veritas	Grade 2.
American Bureau of Shipping	AWS A5.1 E6013.

### TYPICAL ALL WELD METAL MECHANICAL PROPERTIES:

Yield Stress	460 MPa
Tensile Strength	520 MPa
Elongation	28%
CVN Impact Values	60J av @ 0°C.

### TYPICAL ALL WELD METAL ANALYSIS:

C: 0.07%	Mn: 0.60%	Si: 0.50%
----------	-----------	-----------

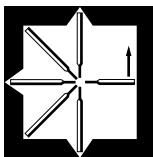

All positional - except vertical down

### Packaging and Operating Data:

AC (minimum 45 O.C.V.), DC+ or DC- polarity.

Electrode Size mm	Length mm	Approx No. Rods/kg	Current Range (amps)	Packet	Carton	Easyweld Handipaks	Part No
2.5	300	53	55-90	5kg	15kg - 3 x 5kg		611182
2.5	300	53	55-90	half pack 2.5kg	15kg - 6 x 2.5kg		612182
				1kg			610182
						50 rod	322135
3.2	380	29	90-135	5kg	15kg - 3 x 5kg		611183
				half pack 2.5kg	15kg - 6 x 2.5kg		612183
				1kg			610183
		25				25 rod	322136
4.0	380	20	135-180	5kg	15kg - 3 x 5kg		611184

### Easyweld Blister Pack:

10 x 2.5mm/5 x 3.2mm rod SatinCRAFT Blue Blister Pak	322203
--	--------



## WELDCRAFT



- ▲ Rutile - Basic Type Electrode.
- ▲ Higher Radiographic Quality.
- ▲ Improved Grade 2 Impact Properties.
- ▲ Versatile "Out-Of-Position" Capabilities.

## Classifications:

AS/NZS 1553.1:	E4113-2.
AWS/ASME-SFA A5.1:	E6013.

## Description and Applications:

Weldcraft is a popular, rutile - basic type electrode which combines excellent all positional welding capabilities (except vertical-down) with improved radiographic weld deposit soundness and impact toughness.

Weldcraft gives better control of the weld pool in vertical-up and overhead welding applications.

As a direct result superior weld profile, edge wetting, penetration and slag lift are consistently achieved. Weld contours in the flat and horizontal-vertical positions are slightly convex and free from undercut.

Weldcraft is suitable for "on site" and workshop welding where better mechanical properties are required and the work cannot be re-positioned to allow welding in the downhand. The electrode is recommended for welding joints subjected to radiographic examination in pressure vessel, ship building, bridge and storage tank fabrications.

## APPROVALS:

Lloyds Register of Shipping	Grade 3.
American Bureau of Shipping	Grade 3.
Det Norske Veritas	Grade 3.

## TYPICAL ALL WELD METAL MECHANICAL PROPERTIES:

Yield Stress	420 MPa
Tensile Strength	490 MPa
Elongation	28%
CVN Impact Values	60J av @ -20°C.

## TYPICAL ALL WELD METAL ANALYSIS:

C: 0.07%	Mn: 0.60%	Si: 0.50%
----------	-----------	-----------

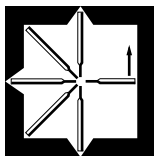

All positional - except vertical down

## Packaging and Operating Data:

AC (minimum 50 O.C.V.), DC+ or DC- polarity.

Size mm	Electrode		Approx No. Rods/kg	Current Range (amps)	Packet	Carton	Part No
	Length mm						
2.5	300		51	60-95	5kg	15kg - 3 x 5kg	611202
3.2	380		27	95-135	5kg	15kg - 3 x 5kg	611203
4.0	380		17	130-185	5kg	15kg - 3 x 5kg	611204

# MUREX™

- ★ Speedex™ 13 is an easy running E4113/E6013 general purpose electrode.
- ★ For fillet and butt welding in all positions except vertical down.
- ★ Self-lifting slag with low spatter loss.
- ★ Speedex™ 13 is recommended for welding thin sections of mild steel and galvanised steels.
- ★ Easy to re-start.
- ★ Speedex™ 13 is ideal for general purpose work such as frames, tanks, gates and light structural work.

#### CLASSIFICATIONS:

AS/NZS 1553.1:	E4113-0.
AWS A5.1:	E6013.

#### MECHANICAL PROPERTIES (TYPICAL):

Yield Stress	430 MPa
Tensile Strength	500 MPa
Elongation	28%
CVN Impact Values	60J av @ 0°C

#### CHEMICAL ANALYSIS (TYPICAL):

C: 0.08%	Mn: 0.43%
Si: 0.35%	

#### PART NUMBERS:

2.5mm	SP1325
3.2mm	SP1332
4.0mm	SP1340

#### WELDING POSITIONS



DOWNHAND



HORIZONTAL



VERTICAL



OVERHEAD

HORIZONTAL/  
VERTICAL

#### OPERATING PARAMETERS & PACKAGING DETAILS:

Ø (mm)	Amperage	Polarity	OCV	Length (mm)	Pk	Carton
2.5	60-90	AC /DC electrode +/-	45A min	300	5kg	15kg
3.2	90-135	AC /DC electrode +/-	45A min	380	5kg	15kg
4.0	135-180	AC /DC electrode +/-	45A min	380	5kg	15kg

## FERROCRAFT 21

45  
OCVDC  
AC

- ▲ Rutile Type, Medium Iron Powder Electrode.
- ▲ Excellent Operator Appeal!
- ▲ Versatile - All Positional Capabilities.
- ▲ Easy Striking - Hot or Cold!
- ▲ Ideal for Vertical Down Fillet Welding.
- ▲ Reliable Impact Toughness to -20°C.

## Classifications:

AS/NZS 1553.1: E4814-2.  
AWS/ASME-SFA A5.1: E7014.

## Description and Applications:

Ferrocraft 21 is a popular rutile type, medium iron powder electrode developed and manufactured in Australia by CIGWELD. It offers many features including smooth stable AC / DC running on low O.C.V. welding machines, excellent fillet shapes in all welding positions (including vertical-down/up and overhead) and a higher electrode efficiency of 110%. In addition, Ferrocraft 21 produces good radiographic quality, a self releasing slag and improved "Grade 2" (min 47J av @ -20°C) impact properties.

Ferrocraft 21 is suitable for workshop or 'on-site' repair, maintenance and fabrication welding jobs where the iron powder addition gives improved usability over conventional E4112 rutile type electrodes.

It is the ideal vertical-down fillet welding electrode for thinner steel sections using "Touch Welding" techniques. It produces a controllable fast freezing slag with outstanding slag lift and minimum undercut.

## APPROVALS:

Lloyds Register of Shipping	Grade 3.
American Bureau of Shipping	Grade 3.
Det Norske Veritas	Grade 3.
American Bureau of Shipping	AWS A5.1 E7014.

## TYPICAL ALL WELD METAL MECHANICAL PROPERTIES:

Yield Stress	430 MPa
Tensile Strength	500 MPa
Elongation	30%
CVN Impact Values.	90J av @ -20°C.

## TYPICAL ALL WELD METAL ANALYSIS:

C: 0.06%	Mn: 0.65%	Si: 0.30%
----------	-----------	-----------

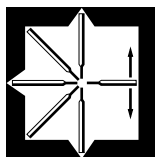
All positional - welding<sup>#</sup>

## Packaging and Operating Data:

AC (minimum 45 O.C.V.), DC+ or DC- polarity.

Electrode Size mm	Length mm	Approx No. Rods/kg	Current Range (amps)	Packet	Carton	Easyweld Handipaks	Part No
				5kg	15kg - 3 x 5kg		
2.5	300	50	55-100	5kg	15kg - 3 x 5kg		611242
2.5	300	50	55-100			50 rod	322130
3.2	380	26	95-140	5kg	15kg - 3 x 5kg		611243
4.0	380	17	140-195	5kg	15kg - 3 x 5kg		611244
5.0	450	9	200-260	5kg	15kg - 3 x 5kg		611245

## Easyweld Blister Pack:

10 x 2.5mm/5 x 3.2mm rod Ferrocraft 21 Blister Pack 322205

# -5.0mm Ferrocraft 21 is not recommended for out-of-position (ie vertical or overhead) welding applications.

- ▲ Rutile Type High Iron Powder Electrode.
- ▲ High Productivity Fillet and Butt Welding in All Downhand Positions.
- ▲ Self Releasing Slag.

### Classifications:

AS/NZS 1553.1: E4824-0.  
 AWS/ASME-SFA A5.1: E7024.

### Description and Applications:

Ferrocrafft 22 is a rutile type high iron powder electrode for the higher productivity fillet and butt welding of mild steel in all downhand ( flat and horizontal-vertical ) positions.

Slag lift and "side wall" wash at weld toes are superb and welding speeds are approximately double those of conventional electrodes of equal size and length.

Ferrocrafft 22 is recommended for high production welding where large standing fillet welds are required. It is the ideal electrode for heavy structural welding applications such as tanks, frames, girders and beams, ship structures and rolling stock and general fabrication in the workshop or on-site.

### APPROVALS:

Lloyd's Register of Shipping	Grade 2Y.
American Bureau of Shipping	Grade 2.
Det Norske Veritas	Grade 2.
American Bureau of Shipping	AWS A5.1 E7024.

### TYPICAL ALL WELD METAL MECHANICAL PROPERTIES:

Yield Stress	440 MPa
Tensile Strength	512 MPa
Elongation	25%
CVN Impact Values	60J av @ 0°C.

### TYPICAL ALL WELD METAL ANALYSIS:

C: 0.05%	Mn: 0.75%	Si: 0.25%
----------	-----------	-----------



### Packaging and Operating Data:

AC (minimum 45 O.C.V.), DC+ or DC- polarity.

Electrode Size mm	Electrode Length mm	Approx No. Rods/kg	Current Range (amps)	Packet	Carton	Part No
				5kg	15kg – 3 x 5kg	611252
2.5	350	34	85-120	5kg	15kg – 3 x 5kg	611252
3.2	380	18	130-170	5kg	15kg – 3 x 5kg	611253
4.0	450	11	185-235	5kg	15kg – 3 x 5kg	611254
5.0	450	7	260-320	5kg	15kg – 3 x 5kg	611255

# - Ferrocrafft 22 is formulated to operate with AC (min 45 O.C.V.), DC+ or DC- polarity. The preferred polarity for DC fillet welding is DC+.

## FERROCRAFT 11

65  
OCVDC  
AC

- ▲ Cellulose Pipe Welding Electrode.
- ▲ All Positional, AC / DC Capabilities.
- ▲ High Penetration, Root Pass Applications.
- ▲ WHITE flux colour for easy I.D.

## Classifications:

AS/NZS 1553.1: E4111-2.  
AWS/ASME-SFA A5.1: E6011.

## Description and Applications:

Ferrocrafft 11 is a cellulose electrode suitable for high penetration welding applications using both AC and DC power sources.

The deep penetration and fast freezing weld metal of Ferrocrafft 11 make it ideal for the all positional (including vertical up/down and overhead) root pass welding of full penetration joints. A small iron powder addition to the Ferrocrafft 11 flux coating gives it improved arc stability and smoother arc transfer.

Ferrocrafft 11 is recommended for root pass welding where the 'stovepipe' or 'flick' techniques can be used to achieve full root penetration. Typical applications include the root, hot, fill and capping pass welding of pipelines, pressure vessels, storage tanks, workshop and field constructions.

## APPROVALS:

Lloyds Register of Shipping	Grade 3, 3Y.
American Bureau of Shipping	Grade 3.
Det Norske Veritas	Grade 3.
American Bureau of Shipping	AWS A5.1 E6011.

## TYPICAL ALL WELD METAL MECHANICAL PROPERTIES:

Yield Stress	415 MPa
Tensile Strength	500 MPa
Elongation	28%
CVN Impact Values	90J av @ -20°C.

## TYPICAL ALL WELD METAL ANALYSIS:

C: 0.12%	Mn: 0.47%	Si: 0.10%
S: 0.007%	P: 0.011%	

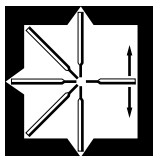

All positional - welding

## Packaging and Operating Data:

AC (minimum 65 O.C.V.), DC+ or DC- polarity.

Electrode Size mm	Electrode Length mm	Approx. No. Rods/kg	Current Range (amps)	Packet	Carton	Part No
2.5	300	62	65-85	5kg	15kg - 3 x 5kg	611132
3.2	380	33	95-125	5kg	15kg - 3 x 5kg	611133
4.0	380	22	130-160	5kg	15kg - 3 x 5kg	611134



## PIPEARC 6010P

- ▲ User Friendly Pipe Welding Electrode.
- ▲ Quieter, Forceful, Deep Penetrating Arc.
- ▲ Lower Spatter Levels and Easy Slag Removal.
- ▲ Finer Ripples with Consistent Bead Shape.
- ▲ Excellent Reverse Bead Formation on Butts.
- ▲ Versatile "Out-of-Position" Capabilities.
- ▲ Batch Numbered for On-the-Job Traceability.

### Classifications:

AS/NZS 1553.1: E4110-2.  
AWS/ASME-SFA A5.1: E6010.

### Description and Applications:

PipeArc 6010P is a user friendly, high cellulose type electrode for welding mild steel in all welding positions. PipeArc 6010P exhibits a quiet and forceful deep penetrating arc, quick freezing slag, extra low spatter levels and easy slag removal.

PipeArc 6010P is designed specifically for pipe line welding using Direct Current Electrode Positive (DC+). It can be used for the root, fill and capping pass welding of full penetration joints in a wide range of steels using "stovepipe" and "flick" techniques. Root passes (root runs) in single "V" butt preparations completed with PipeArc 6010P produce full and uniform penetration with excellent reverse bead formation.

This electrode can be used for a wide range of applications such as, site fabrication work in the oil, LPG and LNG gas industries, shipbuilding, maintenance and general purpose work. PipeArc 6010P is used to weld out (root, fill and cap) steel pipes such as API 5L, 5LX grades X42 to X52.

For the welding of "V" butt (groove weld) joints in higher strength steels, including 5LX grades X60, X65 and X70, PipeArc 6010P is recommended for root pass welding only. The fill and capping passes should be completed with PipeArc 7010P for X60 & X65 grades and PipeArc 8010P for X70 grades.

### Packaging and Operating Data:

DC+ (Direct Current Electrode Positive) polarity.

Electrode Size mm	Length mm	Approx No. Rods/kg	Current Range (amps)	Packet	Carton	Part No
2.5	300	66	45-85	5kg	15kg - 3 x 5kg	615602
3.2	350	39	70-125	5kg	15kg - 3 x 5kg	615603
4.0	350	25	120-190	5kg	15kg - 3 x 5kg	615604
4.8	350	18	160-250	5kg	15kg - 3 x 5kg	615605

### APPROVALS:

American Bureau of Shipping	AWS A5.1 E6010.
American Bureau of Shipping	Grade 3.
Det Norske Veritas	Grade 3.
Lloyd's Register of Shipping	Grade 3.

### TYPICAL ALL WELD METAL ANALYSIS:

C: 0.11%	Mn: 0.46%	Si: 0.15%
S: 0.011%	P: 0.012%	

### TYPICAL ALL WELD METAL MECHANICAL PROPERTIES:

Yield Stress	400 MPa
Tensile Strength	510 MPa
Elongation	30%
CVN Impact Values	65J av @ -20°C. 40J av @ -30°C.

The results quoted in this data sheet are obtained from the listed Shipping Societies (ABS, DNV, LRS) Conformance Tests and Procedures. Actual weld metal mechanical properties achieved with PipeArc 6010P are influenced by many factors including, base metal analysis, welding parameters / heat input used, number of weld passes and run placement etc. On the job mechanical tests may produce different results.

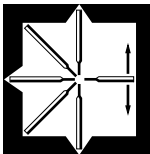

All positional - welding



## HYDROGEN CONTROLLED ELECTRODES

Description	Page No
Storage and Reconditioning of Electrodes	40
Ferrocrafft 16TXP - Hermetically Sealed	41
Ferrocrafft 7016	42
Ferrocrafft 55U	43
Ferrocrafft 61	44
Ferrocrafft 61 H4 - Hermetically Sealed	45
Ferrocrafft 61 Ni H4 - Hermetically Sealed	46
Alloycraft 70 A1- Hermetically Sealed	47
Alloycraft 80-B2 - Hermetically Sealed	48
Alloycraft 80-C1 - Hermetically Sealed	49
Alloycraft 90-B3 - Hermetically Sealed	50
Alloycraft 90 - Hermetically Sealed	51
Alloycraft 110 - Hermetically Sealed	52



## FERROCRAFT AND ALLOYCRAFT

## Advice on Storage and Reconditioning of CIGWELD Hydrogen Controlled Electrodes.

### Storage Environments:

Undamaged packs/cartons of Ferrocrafft and Alloycrafft electrodes stored at 50% R.H. or less and kept at 10-15°C (50-60°F) above ambient temperature with a maximum of 40°C (105°F) stored off the ground and away from walls in cupboards, containers or warehouses are expected to maintain their designated hydrogen levels indefinitely.

### Moisture Re-absorption:

Cardboard packs/cartons of Ferrocrafft and Alloycrafft may lose their designated hydrogen status due to moisture re-absorption from poor storage environments. Where electrodes have been exposed to moisture or where hydrogen control is important, the following procedures are recommended for reconditioning.

### Hermetically Sealed:

Hermetically sealed, hydrogen controlled electrodes are air tight sealed to maintain product in an original "FACTORY FRESH" condition for an indefinite period provided the seal is unbroken.

### Reconditioning and Hydrogen/Moisture Requirements:

AS/NZS 1553.1 low "H10" hydrogen status and AWS A5.1 "H8" hydrogen status.	AS/NZS 1553.1 very low "H5" hydrogen status and AWS A5.1 "H4" very low hydrogen status.
FERROCRAFT 16TXP FERROCRAFT 7016 FERROCRAFT 55U FERROCRAFT 61	FERROCRAFT 61 H4 FERROCRAFT 61 Ni H4 ALLOYCRAFT 70-A1 ALLOYCRAFT 80-B2 ALLOYCRAFT 90 ALLOYCRAFT 110 ALLOYCRAFT 80-C1 ALLOYCRAFT 90-B3
Rebake for maximum of 2 hrs @ 300°C (570°F) in a vented oven and thereafter use from a hot box set at 100 - 120°C (210 - 250°F).	Rebake for maximum of 2 hrs @ 350°C (660°F) in a vented oven and thereafter use from a hot box set at 100 - 120°C (210 - 250°F).

- ▲ Hermetically Sealed Ring Pull Cans.
- ▲ “XP series” E4816 / E7016 Type Electrode.
- ▲ Excellent Operator Appeal / Hydrogen Controlled.
- ▲ LONGER 350mm 2.5mm Size For Fewer Electrode Change-overs and Less Wastage.
- ▲ Easy operation, reliable Grade 3 weld metal properties and low hydrogen status of Ferrocraft 16TXP make the electrode ideal for maintenance welding jobs, including the repair of earth moving equipment and the “buttering” of steel sections prior to the application of hard surfacing.

### TYPICAL ALL WELD METAL MECHANICAL PROPERTIES:

Yield Stress.	460 MPa.
Tensile Strength	550 MPa.
Elongation	27%.
CVN Impact Values	90 J av @ -20°C.

### TYPICAL ALL WELD METAL ANALYSIS:

C: 0.07%	Mn: 1.50%	Si: 0.65%
S: 0.010%	P: 0.015%	

### TYPICAL DIFFUSIBLE HYDROGEN LEVELS TO AS3752:

7.0–7.5 mls of hydrogen / 100gms of deposited weld metal

### APPROVALS:

Lloyds Register of Shipping	Grade 3, 3Y H15.
American Bureau of Shipping	Grade 3H10, 3Y
Det Norske Veritas	Grade 3Y H10.

### Classifications:

AS/NZS 1553.1	E4816-2 H10.
AWS/ASME-SFA A5.1:	E7016 H8.

### Description and Applications:

Ferrocraft 16TXP is an 'XP series', E4816/E7016 type hydrogen controlled welding electrode from CIGWELD offering exceptional AC/DC welding performance in all welding positions, including vertical-up and overhead. It maintains the high level of quality, performance and operator appeal already established with Ferrocraft 12XP.

Ferrocraft 16TXP produces excellent AC performance, particularly on portable 240V AC welding machines such as the CIGWELD Compact Turbo and Easywelder Turbo. Ferrocraft 16TXP offers excellent low current performance which is important for achieving the best bead shape whilst producing no undercut in the difficult vertical-up and overhead positions.

Ferrocraft is an easy-to-use, E4816/E7016 type electrode for the all positional fillet and butt welding of heavier mild steel sections or joints under high restraint. It is also suitable for a wide range of welding applications on selected Carbon-Manganese, low alloy and cast steels. The easy operation, reliable Grade 3 weld metal properties and low hydrogen status of Ferrocraft 16TXP make the electrode ideal for maintenance welding jobs, including the repair of earth moving equipment and the 'buttering' of steel sections prior to the application of hard surfacing.

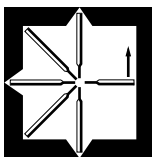

All positional - except vertical down

### Packaging and Operating Data:

AC (minimum 50 O.C.V.), DC+ or DC- polarity.

Electrode Size mm	Electrode Length mm	Approx No. Rods/kg	Current Range (amps)	Can	Carton	Easyweld Handpack	Part No
2.5	350	55	50–90	3kg	12kg – 4 x 3kg		613562
3.2	350	30	85–140	3kg	12kg – 4 x 3kg		613563
4.0	350	21	135–190	3kg	12kg – 4 x 3kg		613564

# - Ferrocraft 16TXP – Hermetically Sealed is formulated to operate with AC (50 O.C.V. min), DC+ or DC- polarity. The preferred polarity for fillet welding and fill and capping passes is DC+.

## FERROCRAFT 7016

50  
OCVDC  
AC

- ▲ Fully Basic Hydrogen Controlled E4816 / E7016 Type Electrode.
- ▲ Excellent Operator Appeal in All Positions.
- ▲ Ideal for Fill and Capping Passes.
- ▲ Excellent Impact Toughness to  $-30^{\circ}\text{C}$ .

## Classifications:

AS/NZS 1553.1:	E4816-3 H10.
AWS/ASME-SFA A5.1:	E7016 H8.
BS EN 499:	E42 4 B 12 H10

## Description and Applications:

Ferrocrafft 7016 is a basic, hydrogen controlled electrode that deposits weld metal in the 550MPa class. It gives excellent operator appeal in all welding positions, except vertical-down and exhibits a smooth, penetrating arc with excellent bead appearance and shape. The full covering slag is easy to control and remove. Ferrocrafft 7016 is a versatile hydrogen controlled

electrode, giving excellent all round arc performance and reliable impact toughness to  $-30^{\circ}\text{C}$ .

Ferrocrafft 7016 is designed for all positional (except vertical-down) fillet and butt welding jobs where "hydrogen control" is required and the emphasis is on operator appeal. It is also recommended for more critical applications where low temperature impact toughness to  $-30^{\circ}\text{C}$  is required.

Typical applications include pressure vessel fabrication, bridge and ship building and equipment repair and maintenance work.

## APPROVALS:

Lloyd's Register of Shipping	Grade 3YH10.
American Bureau of Shipping	Grade 3H10, 3Y.
Det Norske Veritas	Grade 3Y H10.
American Bureau of Shipping	AWS A5.1 E7016.

## TYPICAL MECHANICAL PROPERTIES:

Yield Stress	480 MPa
Tensile Strength	570 MPa
Elongation	25%
CVN Impact Values	125J av @ $-20^{\circ}\text{C}$ 100J av @ $-30^{\circ}\text{C}$

## TYPICAL ALL WELD METAL ANALYSIS:

C: 0.08%	Mn: 1.10%	Si: 0.65%
S: 0.009%	P: 0.019%	

## TYPICAL DIFFUSIBLE HYDROGEN LEVELS TO AS3752:

5.0 - 6.0 mls of hydrogen / 100gms of deposited weld metal \*

\* Reconditioned for 2 hours maximum @  $300^{\circ}\text{C}$ .

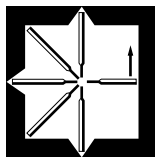

All positional - except vertical down welding

## Packaging and Operating Data:

AC (minimum 50 O.C.V.), DC+ or DC- polarity.

Size mm	Electrode		Approx No. Rods/kg	Current Range (amps)	Packet	Carton	Part No
	Length mm						
3.2	380		29	90-130	5kg	15kg - 3 x 5kg	611743
4.0	380		19	120-180	5kg	15kg - 3 x 5kg	611744

# - Ferrocrafft 7016 is formulated to operate with AC (55 O.C.V.), DC+ or DC- polarity.. The preferred polarity for fillet welding and fill and capping passes is DC+.

- ▲ Hydrogen Controlled E4816 / E7016 Type Electrode.
- ▲ Ideal for Root Pass Welding Applications.
- ▲ Thin Coated for Easier Joint Access.
- ▲ Purple End Tip Colour for instant I.D.

### Classifications:

AS/NZS 1553.1: E4816-2 H10.  
 AWS/ASME-SFA A5.1: E7016 H8.

### Description and Applications:

Ferrocraft 55U is a basic, hydrogen controlled electrode from CIGWELD offering very smooth running, excellent arc characteristics and good slag control.

Designed specifically for the all positional (except vertical down) root pass welding of steel pipes and plates, Ferrocraft 55U has a thin flux coating for easier joint access. When using the correct welding technique, polarity and current setting sound penetration beads of excellent appearance and even contour can be achieved. Depending on the joint properties required, Ferrocraft 55U is suitable for fill and capping passes.

### APPROVALS:

Lloyd's Register of Shipping Grade 3, 3YH15.  
 Det Norske Veritas Grade 3YH10.

### TYPICAL ALL WELD METAL MECHANICAL PROPERTIES:

Yield Stress 460 MPa.  
 Tensile Strength 570 MPa.  
 Elongation 29%.  
 CVN Impact Values 70 J av @ -20°C.

### TYPICAL ALL WELD METAL ANALYSIS:

C: 0.07% Mn: 0.80% Si: 0.77%  
 S: 0.007% P: 0.013%

### TYPICAL DIFFUSIBLE HYDROGEN LEVELS TO AS3752:

7.0 - 7.5 mls of hydrogen / 100gms of deposited weld metal \*.

\* Reconditioned for 2 hours maximum @ 300°C.

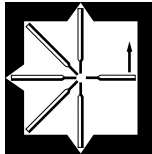

All positional - except vertical down

### Packaging and Operating Data:

AC (minimum 70 O.C.V.), DC+ or DC- polarity.

Electrode Size mm	Electrode Length mm	Approx No. Rods/kg	Current Range (amps)	Packet	Carton	Part No
2.5	350	53	40-90	5kg	15kg - 3 x 5kg	611492
3.2	380	31	60-140	5kg	15kg - 3 x 5kg	611493
4.0	380	19	90-180	5kg	15kg - 3 x 5kg	611494

# - Ferrocraft 55U is formulated to operate on low welding current to accommodate poor joint fit up and large root gaps. The electrode is suitable for AC (minimum 70 O.C.V.), DC+ or DC- polarity. The preferred polarity for ease of use in root pass welding is DC-. Where it is necessary to maximise weld metal toughness fill and capping passes should be deposited with DC+ polarity.

## FERROCRAFT 61



- ▲ Basic Coated, Hydrogen Controlled E4818 / E7018 Type Electrode.
- ▲ Superb AC/DC Operator Appeal.
- ▲ Excellent Out-of-Position Welding.
- ▲ Reliable Impact Properties to -30°C.
- ▲ BATCH NUMBER Identification.

## Classifications:

AS /NZS 1553.1: E4818-3 H10.  
AWS/ASME-SFA A5.1: E7018.

## Description and Applications:

Ferrocrafft 61 is the latest smooth running, user friendly hydrogen controlled electrode from CIGWELD. Ferrocrafft 61 gives improved side wall wash and reduced undercut at weld toes and produces very low spatter levels for an electrode of its type. Fillet weld shape is excellent and exhibits a true mitre to slightly convex profile.

Improved arc characteristics and stability on low Open Circuit Voltage welding machines ( $\geq 55$  O.C.V.) ensure Ferrocrafft 61 has the high operator appeal Welders demand from today's manual arc electrodes.

Ferrocrafft 61 is specifically designed for all positional (especially vertical-up) fillet and butt welding applications on heavier steel sections under high restraint such as machinery parts, pressure vessels, mining equipment, pipework, ship construction and all maintenance and repair work; on site, in the workshop or on the land.

## APPROVALS:

Lloyd's Register of Shipping	Grade 3, 3YH15.
American Bureau of Shipping	Grade 3H15, 3Y.
Det Norske Veritas	Grade 3YH10.
American Bureau of Shipping	AWS A5.1 E7018.

## TYPICAL ALL WELD METAL MECHANICAL PROPERTIES:

Yield Stress.	450 MPa.
Tensile Strength	545 MPa.
Elongation	29%.
CVN Impact Values	160 J av @ -20°C.
	130 J av @ -30°C.

## TYPICAL ALL WELD METAL ANALYSIS:

C: 0.06%	Mn: 1.45%	Si: 0.45%
S: 0.010%	P: 0.012%	

## TYPICAL DIFFUSIBLE HYDROGEN LEVELS TO AS3752:

8.5 - 9.0 mls of hydrogen / 100gms of deposited weld metal \*

\* Reconditioned for 2 hours maximum @ 300°C.

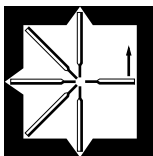

All positional - except vertical down

## Packaging and Operating Data:

AC (minimum 55 O.C.V.), DC+ or DC- polarity.

Electrode Size mm	Length mm	Approx No. Rods/kg	Current Range (amps)	Packet	Carton	Part No
2.5	350	42	65-100	5kg	15kg - 3 x 5kg	611342
3.2	380	24	95-150	5kg	15kg - 3 x 5kg	611343
4.0	380	16	145-220	5kg	15kg - 3 x 5kg	611344
5.0	450	9	195-270	5kg	15kg - 3 x 5kg	611345

# - Ferrocrafft 61 is formulated to operate with AC (55 O.C.V min), DC+ or DC- polarity. The preferred polarity for fillet welding and fill and capping passes is DC+.

- ▲ Highly Basic, E4818 / E7018 Type Hydrogen controlled electrode.
- ▲ Advanced moisture resistant flux coating.
- ▲ Very low "H5 / H4" diffusible hydrogen class.
- ▲ C-Mn weld deposit for reliable impact properties to -40°C.
- ▲ Recommended for critical DC welding applications.
- ▲ Batch Number Identification.

### Classifications:

AS /NZS 1553.1: E4818-5 H5R.  
 AWS/ASME-SFA A5.1: E7018-1 H4R.

### Description and Applications:

Ferrocrafft 61 H4 is a highly basic hydrogen controlled electrode offering excellent weldability and weld deposit mechanical properties. Ferrocrafft 61 H4 is the first choice for critical welding applications where reliable weld deposit impact toughness to -40°C is required.

Ferrocrafft 61 H4 electrodes are individually BATCH NUMBERED for total "on the job traceability". The advanced moisture resistant flux coating of Ferrocrafft 61 H4 ensures excellent resistance to hydrogen induced cold cracking in two important ways.

- Firstly Ferrocrafft 61 H4 meets the very low AWS: H4 and AS: H5 Hydrogen status straight from the hermetically sealed can.
- Secondly Ferrocrafft 61 H4 meets the AS1553.1 moisture resistant "R" classification of < or = 10mls of diffusible Hydrogen / 100 grams of deposited weld metal after 9 hours exposure to 27°C and 80% relative humidity.

### TYPICAL ALL WELD METAL MECHANICAL PROPERTIES:

Yield Stress.	450 MPa.
Tensile Strength	545 MPa.
Elongation	28%.
CVN Impact Values	150 J av @ -20°C.
	100 J av @ -40°C.
	80 J av @ -50°C.

### TYPICAL ALL WELD METAL ANALYSIS:

C: 0.07%	Mn: 1.50%	Si: 0.35%
S: 0.07%	P: 0.012%	

### TYPICAL DIFFUSIBLE HYDROGEN LEVELS TO AS3752:

3.0 - 3.5 mls of hydrogen / 100gms of deposited weld metal .

### APPROVALS:

Lloyd's Register of Shipping	Grade 3, 3YH5.
American Bureau of Shipping	Grade 3H5, 3Y.
Det Norske Veritas	Grade 3YH5.

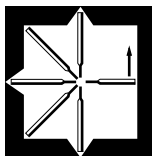

All positional - except vertical down

### Packaging and Operating Data:

AC (minimum 75 O.C.V.), DC+ or DC- polarity.

Electrode Size mm	Electrode Length mm	Approx No. Rods/kg	Current Range (amps)	Can	Carton	Part No
2.5	350	42	65-100	3kg	12kg - 4 x 3kg	614342
3.2	350	26	95-150	3kg	12kg - 4 x 3kg	614343
4.0	350	17	145-220	3kg	12kg - 4 x 3kg	614344

## FERROCRAFT 61 Ni H4 – Hermetically Sealed

75  
OCVDC  
AC

- ▲ Hermetically sealed cans.
- ▲ Highly Basic, E4818-G / E7018-G Type Hydrogen Controlled Electrode.
- ▲ Very Low "H5 / H4" Diffusible Hydrogen Class.
- ▲ C - Mn - Ni Weld Deposit for Reliable Impact Properties to -50°C.
- ▲ BATCH NUMBER Identification.
- ▲ Recommended for the critical welding of C-Mn, microalloyed and low alloy structural steels in the 350-450 MPa yield strength class.
- ▲ Applications include the all positional (except vertical down) fillet and butt welding of pressure vessels, offshore platforms, pipes, earth moving equipment.

## Classifications:

AS/NZS 1553.2: E4818-G. H5R  
AWS/ASME-SFA A5.5: E7018-G. H4R

## APPROVALS:

Lloyd's Register of Shipping Grade 3, 3YH5.

## TYPICAL ALL WELD METAL MECHANICAL PROPERTIES:

Yield Stress	450 MPa.
Tensile Strength	560 MPa.
Elongation	27%.
CVN Impact Values	130 J av @ -20°C. 80 J av @ -40°C. 60 J av @ -50°C.

## TYPICAL ALL WELD METAL ANALYSIS:

C: 0.07% Mn: 1.20% Si: 0.25%  
Ni: 0.9% S: 0.007% P: 0.012%

## TYPICAL DIFFUSIBLE HYDROGEN LEVELS TO AS3752:

3.0 - 3.5 mls of hydrogen / 100gms of deposited weld metal .

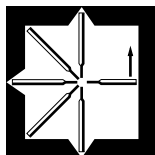

All positional - except  
vertical-down

## Description and Applications:

Ferrocrafft 61 Ni H4 is a new highly basic, hydrogen controlled electrode offering excellent weldability and weld deposit mechanical properties. Ferrocrafft 61 Ni H4 is the first choice for critical DC welding applications where reliable weld deposit impact toughness to -50 degrees C is required. Ferrocrafft 61 Ni H4 electrodes are individually BATCH NUMBERED for total "on the job traceability". The advanced moisture resistant flux coating of Ferrocrafft 61 Ni H4 ensures excellent resistance to hydrogen induced cold cracking in two important ways.

- Firstly Ferrocrafft 61 Ni H4 meets the very low AWS: H4 and AS: H5 Hydrogen status straight from the hermetically sealed can.
- Secondly Ferrocrafft 61Ni H4 meets the AS1553.1 moisture resistant "R" classification of < or = 10mls of diffusible Hydrogen / 100 grams of deposited weld metal after 9 hours exposure to 27 degrees C and 80% relative humidity.

## Packaging and Operating Data:

AC (minimum 75 O.C.V.), DC+ or DC- polarity.

Electrode Size mm	Length mm	Approx No. Rods/kg	Current Range (amps)	Packet	Carton	Part No
2.5	350	42	65-100	3kg	12kg – 4 x 3kg	611812
3.2	350	26	110-145	3kg	12kg – 4 x 3kg	611813
4.0	350	17	140-200	3kg	12kg – 4 x 3kg	611814

# - Ferrocrafft 61 Ni H4 is formulated to operate with AC (min 75 O.C.V.), DC+ or DC- polarity. The preferred polarity for fillet welding and fill and capping passes is DC+.

- ▲ Hermetically sealed cans.
- ▲ Improved high strength, low alloy steel electrode.
- ▲ Advanced moisture resistant flux coating.
- ▲ Very low "H5" diffusible hydrogen class.
- ▲ 480MPa tensile class.
- ▲ Recommended for DC welding applications.
- ▲ Batch Numbered for identification.

### Classifications:

AS /NZS 1553.2:	E4818-A1. H5R
AWS/ASME-SFA	A5.5: E7018-A1 H4R.

### Description and Applications:

Alloycraft 70-A1 is a new low iron powder, moisture resistant, hydrogen controlled electrode offering excellent weldability and weld deposit mechanical properties and 'very low' diffusible hydrogen levels. Alloycraft 70-A1 is suitable for the all positional (except vertical down) DC welding of a wide range of low alloy and medium tensile steels. Alloycraft 70-A1 contains a nominal 0.5% Molybdenum alloy addition in the deposited weld metal and produces strong, tough weld deposits of the 480 MPa tensile class in the 'as welded' condition.

The advanced moisture resistant flux coating of Alloycraft 70-A1 ensures excellent resistance to hydrogen induced cold cracking. Alloycraft 70-A1 is recommended for the full or under matching strength welding of medium strength steels. Some applicable ASTM steel grades include: Grade A182, F1, Grade A335, P1, Grade A336, F1.

Used for the fabrication and maintenance of selected Mo bearing steel pipes, plates, castings and forgings in pressure vessels, boilers, power house projects and oil refineries.

### TYPICAL ALL WELD METAL MECHANICAL PROPERTIES:

Yield Stress.	480 MPa.
Tensile Strength	570 MPa.
Elongation	25%.

### TYPICAL ALL WELD METAL ANALYSIS:

C: 0.03%	Mn: 0.77%	Si: 0.37%
Mo: 0.53%	S: 0.013%	P: 0.015%

### TYPICAL DIFFUSIBLE HYDROGEN LEVELS TO AS3752:

3.0 - 3.5 mls of hydrogen / 100gms of deposited weld metal .

### APPROVALS:

Lloyd's Register of Shipping	Grade 3, 3YH5.
American Bureau of Shipping	Grade 3H5, 3Y.
Det Norske Veritas	Grade 3YH5.

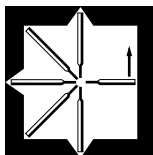

All positional - except vertical down

### Packaging and Operating Data:

AC (minimum 75 O.C.V.), DC+ or DC- polarity.

Electrode Size mm	Length mm	Approx No. Rods/kg	Current Range (amps)	Can	Carton	Part No
*2.5	350	42	65-100	3kg	12kg - 4 x 3kg	611842
*3.2	350	26	95-150	3kg	12kg - 4 x 3kg	611843
*4.0	350	17	145-220	3kg	12kg - 4 x 3kg	611844

# - Alloycraft 70-A1 is formulated to operate with AC (min 70 O.C.V.), DC+ or DC- polarity. The preferred polarity for DC welding is DC+.

\*Non-stock item available on indent only.



## ALLOYCRAFT 80-B2 – Hermetically Sealed

70  
OCVDC  
AC

- ▲ Hermetically sealed cans.
- ▲ Improved High Strength, Low Alloy Steel Electrode.
- ▲ Advanced Flux Coating.
- ▲ Very Low "H5/H4" Diffusible Hydrogen Class.
- ▲ 550 MPa Tensile Class
- ▲ BATCH NUMBERED for On-the-Job Traceability.
- ▲ Recommended for the all positional (except vertical down) welding of Chromium and Chromium – Molybdenum bearing steels as used in elevated temperature applications.

## TYPICAL ALL WELD METAL MECHANICAL PROPERTIES:

0.2% Proof Stress	570 MPa.
Tensile Strength	670 MPa.
Elongation	24%.

## TYPICAL ALL WELD METAL ANALYSIS:

C: 0.08%	Mn: 0.82%	Si: 0.39%
Mo: 0.65%	Cr: 1.40%	S: 0.013%
P: 0.015%		

## TYPICAL DIFFUSIBLE HYDROGEN LEVELS TO AS3752:

3.0 - 3.5 mls of hydrogen / 100gms of deposited weld metal .

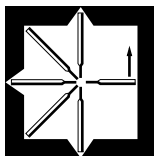

All positional - except vertical down

## Classifications:

AS/NZS 1553.2:	E5518-B2 H5R
AWS/ASME-SFA A5.5:	E8018-B2 H4R

## Description and Applications:

Alloycraft 80-B2 is a basic hydrogen controlled Cr - Mo bearing electrode offering excellent weldability and weld deposit mechanical properties and "very low" diffusible hydrogen levels.

Alloycraft 80-B2 is suitable for the all positional (except vertical down) DC welding of a wide range of low alloy and medium strength steels. Alloycraft 80-B2 contains a nominal 1.25% Chromium and 0.5% Molybdenum alloy addition in the deposited weld metal and produces strong, tough weld deposits of the 550 MPa tensile class in the "as welded" condition.

Alloycraft 80-B2 is recommended for the all positional (except vertical down) welding of Chromium and Chromium - Molybdenum bearing steels as used in elevated temperature applications. Some applicable ASTM steel grades include: Grade A182, F11, F12, Grade A217, WC6, Grade A387, C, Grade A426, CP2, CP11, CP12, and AS2074 Grades L5B, L5G, L5H as used in steel pipes, boiler work, castings and forgings in the power station, refinery and petrochemical industries.

## Packaging and Operating Data:

AC (minimum 70 O.C.V.), DCEP (DC+) or DCEN (DC-) polarity.

Electrode Size mm	Electrode Length mm	Approx No. Rods/kg	Current Range (amps)	Can	Carton	Part No
2.5	350	40	65-100	3kg	12kg - 4 x 3kg	611922
3.2	350	26	105-150	3kg	12kg - 4 x 3kg	611923
4.0	350	17	145-200	3kg	12kg - 4 x 3kg	611924

- ▲ Hermetically sealed cans.
- ▲ Improved High Strength, Low Alloy Steel Electrode.
- ▲ Very Low "H5/H4" Diffusible Hydrogen Class.
- ▲ 550 MPa Tensile Class, Reliable Impact Toughness to -60°C.
- ▲ BATCH NUMBERED for On-the-Job Traceability.
- ▲ Suitable for the full or under matching strength welding of high strength nickel bearing steels as used for low temperature applications.

### TYPICAL ALL WELD METAL MECHANICAL PROPERTIES:

0.2% Proof Stress	550 MPa.
Tensile Strength	630 MPa.
Elongation	26%.
CVN Impact Values	75 J av @ -60°C.

### TYPICAL ALL WELD METAL ANALYSIS:

C: 0.05%	Mn: 1.1%	Si: 0.38%
Ni: 2.46%		S: 0.013%
P: 0.015%		

### TYPICAL DIFFUSIBLE HYDROGEN LEVELS TO AS3752:

3.0 - 3.5 mls of hydrogen / 100gms of deposited weld metal.

### Classifications:

AS/NZS 1553.2:	E5518-C1 H5R
AWS/ASME-SFA A5.5:	E8018-C1 H4R

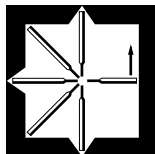

All positional - except vertical down

### Description and Applications:

Alloycraft 80-C1 is a basic hydrogen controlled electrode offering excellent weldability / weld deposit mechanical properties and "very low, H5" diffusible hydrogen levels. Alloycraft 80-C1 is suitable for the all positional (except vertical down) DC welding of a wide range of low alloy and medium strength steels. Alloycraft 80-C1 contains a nominal 2.5% Nickel alloy addition in the deposited weld metal and produces strong, tough weld deposits of the 550 MPa tensile class in the "as welded" condition.

The advanced flux coating of Alloycraft 80-C1 ensures excellent resistance to hydrogen induced cold cracking in two important ways.

Alloycraft 80-C1 meets the AS/NZS 1553.1 very low "H5" hydrogen class after the recommended reconditioning treatment (see Storage and Reconditioning recommendations for details).

Alloycraft 80-C1 is suitable for the full or under matching strength welding of high strength nickel bearing steels as used for low temperature applications. Some applicable ASTM steel grades include: Grade A148, 80-40, 80-50, Grade A217, WC4, WC5, WC6, Grade A352, LC2, Grade A420, WPL9, Grade A43T Class 2, and Grade A707, L1-L4 as used in structural, transport, mining and earthmoving applications. Alloycraft 80-C1 is also good colour match for Austen T.

### Packaging and Operating Data:

AC (minimum 70 O.C.V.), DC+ or DC- polarity.

Electrode Size mm	Electrode Length mm	Approx No. Rods/kg	Current Range (amps)	Can	Carton	Part No
3.2	350	26	110-145	3kg	12kg -4 x 3kg	611833
4.0	350	17	140-200	3kg	12kg -4 x 3kg	611834
5.0	350	11	190-270	3kg	12kg -4 x 3kg	611835

# - Alloycraft 80-C1 is formulated to operate with AC (min 70 O.C.V.), DC+ or DC- polarity. The preferred polarity for DC welding is DC+.

## ALLOYCRAFT 90-B3 – Hermetically Sealed

70  
OCVDC  
AC

- ▲ Hermetically sealed cans.
- ▲ Improved High Strength, Low Alloy Steel Electrode.
- ▲ Very Low "H5/H4" Diffusible Hydrogen Class.
- ▲ 620 MPa Tensile Class.
- ▲ BATCH NUMBERED for On-the-Job Traceability.
- ▲ Recommended for the all positional (except-down) welding of Cr-Mo and Cr-Mo-V bearing steels as used for high temperature applications.

## Classifications:

AS/NZS 1553.2:	E6218-B3 H5R
AWS/ASME-SFA A5.5:	E9018-B3 H4R

## TYPICAL ALL WELD METAL MECHANICAL PROPERTIES:

0.2% Proof Stress	630 MPa.
Tensile Strength	720 MPa.
Elongation	20%.

## TYPICAL ALL WELD METAL ANALYSIS:

C: 0.08%	Mn: 0.85%	Si: 0.35%
Mo: 1.05%	Cr: 2.20%	S: 0.013%
P: 0.015%		

## TYPICAL DIFFUSIBLE HYDROGEN LEVELS TO AS3752:

3.0 - 3.5 mls of hydrogen / 100gms of deposited weld metal .

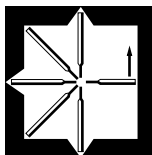

All positional - except vertical down

## Description and Applications:

Alloycraft 90-B3 is a basic hydrogen controlled Cr - Mo bearing electrode offering excellent weldability and weld deposit mechanical properties and "very low" diffusible hydrogen levels.

Alloycraft 90-B3 is suitable for the all positional (except vertical down) DC welding of a wide range low alloy and medium tensile strength steels. Alloycraft 90-B3 contains a nominal 2.25% Chromium and 1.0% Molybdenum and produces strong, tough weld deposits of the 620 MPa tensile class in the "as welded" condition.

Alloycraft 90-B3 is recommended for the all positional (except vertical-down) welding of Cr - Mo and Cr - Mo - V bearing steels as used for high temperature applications. Some applicable ASTM steel grades include: Grade A335 P22, Grade A182, F21, F22, Grade A426 CP21, CP22 as used in Cr- Mo-V piping, creep resistant steels , castings and forgings in the powerhouse and petrochemical industries.

## Packaging and Operating Data:

AC (minimum 70 O.C.V.), DCEP (DC+) or DCEN (DC-) polarity.

Size mm	Electrode		Approx No. Rods/kg	Current Range (amps)	Can	Carton	Part No
	Length mm						
3.2	350		26	105-150	3kg	12kg -4 x 3kg	611963
4.0	350		17	145-200	3kg	12kg -4 x 3kg	611964

- ▲ Hermetically sealed cans.
- ▲ Improved High Strength, Low Alloy Steel Electrode.
- ▲ Very Low "H5/H4" Diffusible Hydrogen Class.
- ▲ 620 MPa Tensile Class, Reliable Impact Toughness to -40°C.
- ▲ BATCH NUMBERED for On-the-Job Traceability.
- ▲ Applications include the full or under matching strength welding of high strength steels, including Bisalloy 60, 70 and 80, Welten 60 and 80, AS2074 Gr L6, Comsteel 023/026. ASTM A514 and A517 used in structural, transport, mining and earthmoving applications.

### COMPARABLE CIGWELD PRODUCTS

Verti-cor 91 K2 H4  
AWS A5.20: E91T1-K2 H4

### TYPICAL ALL WELD METAL MECHANICAL PROPERTIES:

0.2% Proof Stress	590 MPa.
Tensile Strength	680 MPa.
Elongation	26%.
CVN Impact Values	90 J av @ -40°C.

### TYPICAL ALL WELD METAL ANALYSIS:

C: 0.07%	Mn: 1.0%	Si: 0.40%
Ni: 1.6%	Mo: 0.3%	

### TYPICAL DIFFUSIBLE HYDROGEN LEVELS TO AS3752:

3.0 - 3.5 mls of hydrogen / 100gms of deposited weld metal.

### Classifications:

AS/NZS 1553.2:	E6218-M H5R
AWS/ASME-SFA A5.5:	E9018M H4R

### Description and Applications:

Alloycraft 90 is a basic hydrogen controlled electrode offering excellent weldability / weld deposit mechanical properties and "very low, H5" diffusible hydrogen levels.

Alloycraft 90 is suitable for the all positional (except vertical down) DC welding of a wide range higher strength steels. Alloycraft 90 produces strong, tough weld deposits of the 620 MPa tensile class in the "as welded" condition.

Alloycraft 90 meets the AS/NZS 1553.1 very low "H5" hydrogen class after the recommended reconditioning treatment (see Storage and Reconditioning recommendations for details).

Typical applications of Alloycraft 90 include the full or under matching strength welding of high strength steels, including Bisalloy 60, 70 and 80, Welten 60 and 80, AS2074 Gr L6, Comsteel 023/026, ASTM A514 and A517 used in structural, transport, mining and earthmoving applications.

### Packaging and Operating Data:

AC (minimum 70 O.C.V.), DC+ or DC- polarity.

Electrode Size mm	Electrode Length mm	Approx No. Rods/kg	Current Range (amps)	Can	Carton	Part No
3.2	350	26	110-145	3kg	12kg -4 x 3kg	611873
4.0	350	17	140-200	3kg	12kg -4 x 3kg	611874
5.0	350	11	190-270	3kg	12kg -4 x 3kg	611875

# - Alloycraft 90 is formulated to operate with AC (min 70 O.C.V.), DC+ or DC- polarity. The preferred polarity for DC welding is DC-.

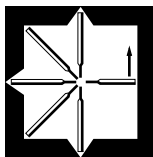

All positional - except vertical down

## ALLOYCRAFT 110 – Hermetically Sealed



- ▲ Hermetically sealed cans.
- ▲ Improved High Strength, Low Alloy Steel Electrode.
- ▲ Very Low "H5/H4" Diffusible Hydrogen Class.
- ▲ 760 MPa Tensile Class, Reliable Impact Toughness to -40°C.
- ▲ BATCH NUMBERED for On-the-Job Traceability.
- ▲ Applications include the full strength welding of high strength steels, including Bisalloy 80, USST1 and T1A, welten 80, HY80, AS2074 Grade L6A and ASTM A533 type A, A514 and A517 grades used in structural transport, mining and earthmoving applications.

**Classifications:**

AS/NZS 1553.2:	E7618-M H5R
AWS/ASME-SFA A5.5:	E11018M H4R

**Description and Applications:**

Alloycraft 110 is a basic hydrogen controlled electrode offering excellent weldability / weld deposit mechanical properties and "very low, H5" diffusible hydrogen levels.

Alloycraft 110 is suitable for the all positional (except vertical down) DC welding of a wide range of high strength steels. Alloycraft 110 produces strong, tough weld deposits of the 760 MPa tensile class in the "as welded" condition.

Alloycraft 110 meets the AS/NZS 1553.1 very low "H5" hydrogen class after the recommended reconditioning treatment (see Storage and Reconditioning recommendations for details).

Typical applications of Alloycraft 110 include the full strength welding of high strength steels, including Bisalloy 80, USST1 and T1A, Welten 80, HY80, AS2074 Grade L6A and ASTM A533 type A, A514 and A517 grades used in structural, transport, mining and earthmoving applications.

**Packaging and Operating Data:**

AC (minimum 70 O.C.V.), DC+ or DC- polarity.

Electrode Size mm	Length mm	Approx No. Rods/kg	Current Range (amps)	Can	Carton	Part No
3.2	350	26	110-145	3kg	12kg -4 x 3kg	611893
4.0	350	17	140-200	3kg	12kg -4 x 3kg	611894

# - Alloycraft 110 is formulated to operate with AC (min 70 O.C.V.), DC+ or DC- polarity. The preferred polarity for DC welding is DC+.

**COMPARABLE CIGWELD PRODUCTS:**

Tensi-cor 110 TXP H4  
AWS A5.20: E110T-5 K4 H4 & E110T-5 K4 M H4

**TYPICAL ALL WELD METAL MECHANICAL PROPERTIES:**

0.2% Proof Stress	710 MPa.
Tensile Strength	820 MPa.
Elongation.	22%.
CVN Impact Values.	60 J av @ -50°C.

**TYPICAL ALL WELD METAL ANALYSIS:**

C: 0.07%	Mn: 1.5%	Si: 0.45%
Ni: 2.1%	Mo: 0.4%	Cr: 0.2%

**TYPICAL DIFFUSIBLE HYDROGEN LEVELS TO AS3752:**

3.0 - 3.5 mls of hydrogen / 100gms of deposited weld metal .

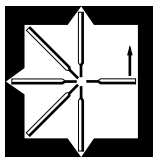

All positional - except vertical down





Description	Page No
Satinchrome 308L-17	56
Satinchrome 309Mo-17	57
Satinchrome 316L-17	58
Satinchrome 318-17	59
MUREX™ Speedex 308L-16	60
MUREX™ Speedex 309L-16	61
MUREX™ Speedex 316L-16	62
MUREX™ Speedex 312-16	63
Weldall	64
Castcraft 55	65
Castcraft 100	66
Bronzecraft AC-DC	67
Arcair DC Carbons	68



## SATINCROME 308L-17

45  
OCVAC  
DC+

- ▲ Rutile Type, Stainless Steel Electrode.
- ▲ Outstanding Operator Appeal!
- ▲ Now with Improved Slag Lift!
- ▲ All Positional (except vertical down) Welding Capabilities.
- ▲ Advanced Moisture Resistant Flux Coating.

## Classifications:

AS/NZS 1553.3: E308L-17.  
AWS/ASME-SFA A5.4: E308L-17.

## Description and Applications:

Satincrome 308L-17 is a smooth running, rutile type stainless steel electrode manufactured by CIGWELD for the all positional (except vertical-down) fillet and butt welding of 19Cr/10Ni type stainless steels.

The features of Satincrome 308L-17 include high AC arc stability, sound radiographic quality, smooth arc transfer characteristics, very low spatter levels and excellent bead shape and contour. The advanced moisture resistant (MR) flux coating provides improved resistance to start-of-run porosity. Slag lift of Satincrome 308L-17 is enhanced in all welding positions, it is self peeling and non-spitting.

Applications of Satincrome 308L-17 include the single and multi-pass welding of 19Cr/10Ni type stainless steel grades including 201, 202, 301, 302, 303, 304, 304L, 305, 308 etc.

## COMPARABLE CIGWELD PRODUCTS:

Autocraft 308LSi GMAW wire  
AWS A5.9: ER308LSi.  
Comweld 308L Gas/TIG wire  
AWS A5.9: ER308L.  
Shieldcrome 308LT & FCAW wires  
AWS A5.22: E308LT1-1/4

## APPROVALS:

American Bureau of Shipping AWS A5.4: E308L-17.

## TYPICAL ALL WELD METAL MECHANICAL PROPERTIES:

0.2% Proof Stress	500 MPa
Tensile Strength	630 MPa
Elongation	40%
CVN Impact Values	75J av @ +20°C.

## TYPICAL ALL WELD METAL ANALYSIS:

C: 0.025%	Mn: 0.76%	Si: 0.87%
Cr: 20.4%	Ni: 9.8%	S: 0.010%
P: 0.017%		

## FERRITE NUMBER:

3.0 - 10.0 FN\*  
\* - using Severn Gauge

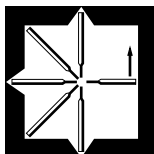

All positional - except  
vertical down

## Packaging and Operating Data:

AC (minimum 45 O.C.V.), DC+ polarity.

Electrode Size mm	Length mm	Approx No. Rods/kg	Current Range (amps)	Packet	Carton	Part No
2.5	300	47	40-70	2.5kg	15kg - 6 x 2.5kg	611602
3.2	350	28	75-110	2.5kg	15kg - 6 x 2.5kg	611603
4.0	350	18	110-150	2.5kg	15kg - 6 x 2.5kg	611604

- ▲ Rutile Type, Stainless Steel Electrode.
- ▲ Outstanding Operator Appeal!
- ▲ Now with Improved Slag Lift!
- ▲ All Positional (except vertical down) Welding Capabilities.
- ▲ Advanced Moisture Resistant Flux Coating.

### Classifications:

AS/NZS 1553.3: E309Mo-17.  
AWS/ASME-SFA A5.4: E309Mo-17.

### Description and Applications:

Satinchrome 309Mo-17 is a rutile type, high alloy stainless steel electrode manufactured by CIGWELD for the all positional (except vertical-down) fillet and butt welding of 24Cr/13Ni type stainless steels.

The features of Satinchrome 309Mo-17 include high AC arc stability, sound radiographic quality, smooth arc transfer characteristics, very low spatter levels and excellent bead shape and contour. The advanced moisture resistant (MR) flux coating provides improved resistance to start-of-run porosity.

Slag lift of Satinchrome 309Mo-17 is enhanced in all welding positions, it is self peeling and non-spitting.

Applications of Satinchrome 309Mo-17 include the single and multi-pass welding of matching 309 and 309L stainless steels. Satinchrome 309Mo-17 is also suitable for the dissimilar welding of other "300 series" austenitic stainless steels and selected "400 series" ferritic grades to mild or low alloy steels such as 403, 405, 410, 416, 420, 430, 430F-Se, 446 etc and BHP 3CR12.

### Packaging and Operating Data:

AC (minimum 45 O.C.V.), DC+ polarity.

Electrode Size mm	Length mm	Approx No. Rods/kg	Current Range (amps)	Packet	Carton	Part No
2.5	300	52	40-70	2.5kg	15kg - 6 x 2.5kg	611692
3.2	350	30	75-110	2.5kg	15kg - 6 x 2.5kg	611693
4.0	350	19	110-150	2.5kg	15kg - 6 x 2.5kg	611694

### COMPARABLE CIGWELD PRODUCTS:

Autocraft 309LSi GMAW wire  
AWS A5.9: ER309LSi.  
Comweld 309L Gas/TIG wire  
AWS A5.9: ER309L.  
Shieldcrome 309LT & FCAW wires  
AWS A5.22: E309LT-1

### APPROVALS:

American Bureau of Shipping AWS A5.4: E309Mo-17.

### TYPICAL ALL WELD METAL MECHANICAL PROPERTIES:

0.2% Proof Stress	500 MPa
Tensile Strength	620 MPa
Elongation	35%
CVN Impact Values	60 J av @ +20°C.

### TYPICAL ALL WELD METAL ANALYSIS:

C: 0.05%	Mn: 0.75%	Si: 0.9%
Cr: 23.0%	Ni: 13.0%	Mo: 2.2%
S: 0.012%	P: 0.017%	

### FERRITE NUMBER:

15.0 - 20.0 FN\*

\* - using Severn Gauge

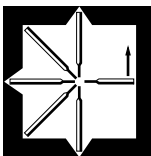

All positional - except vertical down

## SATINCROME 316L-17

45  
OCVAC  
DC+

- ▲ Rutile Type, Stainless Steel Electrode.
- ▲ Outstanding Operator Appeal!
- ▲ Now with Improved Slag Lift!
- ▲ All Positional (except vertical down) Welding Capabilities.
- ▲ Advanced Moisture Resistant Flux Coating.

## Classifications:

AS/NZS 1553.3: E316L-17.  
AWS/ASME-SFA A5.4: E316L-17.

## Description and Applications:

Satinchrome 316L-17 is a low carbon, rutile type stainless steel electrode manufactured by CIGWELD for the all positional (except vertical-down) fillet and butt welding of 19Cr/10Ni type stainless steels. The features of Satinchrome 316L-17 include high AC arc stability, sound radiographic quality, smooth arc transfer characteristics, very low spatter levels and excellent bead shape and contour. The advanced moisture resistant (MR) flux coating provides improved resistance to start-of-run porosity. Slag lift of Satinchrome 316L-17 is enhanced in all welding positions, it is self peeling and non-spitting. Applications of Satinchrome 316L-17 include the single and multi-pass welding of matching Molybdenum bearing stainless steels, 316 and 316L.

Satinchrome 316L-17 is also suitable for the general purpose welding of other "300 series" austenitic stainless steels including 301, 302, 303 and 304/304L, 305, 3CR12 types. The 2.5% Molybdenum content gives increased resistance to pitting corrosion and raises the creep strength for higher temperature applications.

## Packaging and Operating Data:

AC (minimum 45 O.C.V.), DC+ polarity.

Electrode Size mm	Electrode Length mm	Approx. No. Rods/kg	Current Range (amps)	Packet	Carton	Easyweld Handipack	Part No
2.0	300	87	35-55	2.5kg	15kg - 6 x 2.5kg		611661
2.5	300	46	40-70	2.5kg	15kg - 6 x 2.5kg		611662
3.2	350	28	75-110	2.5kg	15kg - 6 x 2.5kg		611663
4.0	350	18	110-150	2.5kg	15kg - 6 x 2.5kg		611664

## Easyweld Blister Pack:

10 x 2.5mm/5 x 3.2mm rod Satinchrome 316L-17 Blister Pack

322215

## COMPARABLE CIGWELD PRODUCTS:

Autocraft 316LSi GMAW wire  
AWS A5.9: ER316LSi  
Comweld 316L Gas/TIG wire  
AWS A5.9: ER316L.  
Shieldchrome 316LT & FCAW wires  
AWS A5.20: E316LT1-1

## APPROVALS:

American Bureau of Shipping AWS A5.4: E316L-17.

## TYPICAL ALL WELD METAL MECHANICAL PROPERTIES:

0.2% Proof Stress	480 MPa
Tensile Strength.	600 MPa
Elongation	40%
CVN Impact Values	30 J av @ -120°C.

## TYPICAL ALL WELD METAL ANALYSIS:

C: 0.025%	Mn: 0.8%	Si: 0.85%
Cr: 19.4%	Ni: 11.5%	Mo: 2.5%
S: 0.011%	P: 0.017%	

## FERRITE NUMBER:

3.0 - 10.0 FN\*

\* - using Severn Gauge

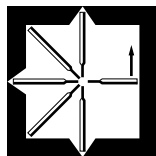

All positional - except vertical down

(Supersedes Satincraft 318-16)

- ▲ Rutile Type, Stainless Steel Electrode.
- ▲ Outstanding Operator Appeal!
- ▲ Now with Improved Slag Lift!
- ▲ All Positional (except vertical down) Welding Capabilities.
- ▲ Advanced Moisture Resistant Flux Coating.

### Classifications:

AS/NZS 1553.3: E318-17.  
AWS/ASME-SFA A5.4: E318-17.

### Description and Applications:

Satincrome 318-17 is a Niobium stabilised, rutile type stainless steel electrode manufactured by CIGWELD for the all positional (except vertical-down) fillet and butt welding of stabilised and unstabilised 19Cr/10Ni type stainless steels, such as 316, 318 and 321.

The features of Satincrome 318-17 include high AC arc stability, sound radiographic quality, smooth arc transfer characteristics, very low spatter levels and excellent bead shape and contour. The advanced moisture resistant (MR) flux coating provides improved resistance to start-of-run porosity. Slag lift of Satincrome 318-17 is enhanced in all welding positions, it is self peeling and non-spitting.

The Molybdenum content of Satincrome 318-17 gives improved resistance to pitting corrosion and the Niobium addition gives improved resistance to intergranular corrosion and good strength retention at elevated temperatures up to  $\approx 700^{\circ}\text{C}$ .

### Packaging and Operating Data:

AC (minimum 45 O.C.V.), DC+ polarity.

Electrode Size mm	Electrode Length mm	Approx No. Rods/kg	Current Range (amps)	Packet	Carton	Easyweld Handipaks	Part No
2.5	300	46	40-70	2.5kg	15kg - 6 x 2.5kg		611652
						20 rod	322105
3.2	350	28	75-110	2.5kg	15kg - 6 x 2.5kg		611653

### TYPICAL ALL WELD METAL MECHANICAL PROPERTIES:

0.2% Proof Stress	490 MPa
Tensile Strength	610 MPa
Elongation	36%

### TYPICAL ALL WELD METAL ANALYSIS:

C: 0.04%	Mn: 0.8%	Si: 0.90%
Cr: 19.0%	Ni: 12.0%	Mo: 2.3%
Nb: 0.35%	S: 0.017%	P: 0.024%

### FERRITE NUMBER:

5.0 - 10.0 FN\*

\* - using Sevens Gauge

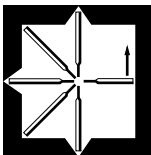

All positional - except vertical down

## SPEDEX 308L-16

45  
OCVAC  
DC+**Murex™**

- ★ Speedex™ 308L-16 is a E308L-16 type stainless steel electrode.
- ★ Designed for fillet & butt welding in all positions except vertical-down.
- ★ Speedex™ 308L-16 offers low spatter levels with smooth running.
- ★ Ideal for welding 304 and 304L stainless steel grades.
- ★ Applications for Speedex™ 308L-16 include stainless steel tanks, vessels, componentry.

Speedex™ 308L-16 is a E308L-16 type stainless steel electrode developed for the fillet & butt welding of 304 & 304L stainless steel grades.

Speedex™ 308L-16 offers low spatter levels with smooth running.

Applications for Speedex™ 308L-16 include the welding of stainless steel pipes, tanks and vessels.

**CLASSIFICATIONS:**

AS/NZS 1553.3:	E308L-16.
AWS A5.4:	E308L-16.

**MECHANICAL PROPERTIES (TYPICAL):**

Yield Stress	500 MPa
Tensile Strength	630 MPa
Elongation	40%
CVN Impact Values	75J av @ +20°C

**CHEMICAL ANALYSIS (TYPICAL):**

C: 0.03%	Cr: 20 %
Mn: 0.76%	Ni: 10%
Si: 0.87%	

**PART NUMBERS:**

2.5mm	SPS30825
3.2mm	SPS30832
4.0mm	SPS30840

**WELDING POSITIONS**

DOWNHAND



HORIZONTAL



VERTICAL



OVERHEAD

HORIZONTAL/  
VERTICAL**OPERATING PARAMETERS & PACKAGING DETAILS:**

Ø (mm)	Amperage	Polarity	OCV	Length (mm)	Pk	Carton
2.5	40-70	AC /DC electrode positive	45A min	300	2.5kg	15kg
3.2	75-110	AC /DC electrode positive	45A min	350	2.5kg	15kg
4.0	110-150	AC /DC electrode positive	45A min	350	2.5kg	15kg

# Murex™

- ★ Speedex™ 309L-16 is a E309L-16 type stainless steel electrode.
- ★ Designed for fillet & butt welding in all positions except vertical down.
- ★ Speedex™ 309L-16 is a smoothing running electrode producing low spatter levels.
- ★ Ideal for the welding of matching 309 and 309L grades of stainless steel & dissimilar steels.
- ★ Also suitable as an intermediate buffer layer prior to hardfacing or as a stainless steel overlay on mild steel.

Speedex™ 309L-16 is a E309L-16 type stainless steel electrode designed for fillet & butt welding of matching 309 & 309L grades of stainless steel.

Speedex™ 309L-16 offers low spatter levels and smooth running.

Applications for Speedex 309L-16 include the welding of matching stainless steel grades and used as an intermediate buffer layer prior to hardfacing. It is also recommended for the dissimilar joining of mild steel to stainless steel

## WELDING POSITIONS



DOWNHAND



HORIZONTAL



VERTICAL



OVERHEAD

HORIZONTAL/  
VERTICAL

## CLASSIFICATIONS:

AS/NZS 1553.3:	E309L-16.
AWS A5.4:	E309L-16.

## MECHANICAL PROPERTIES (TYPICAL):

Yield Stress	500 MPa
Tensile Strength	620 MPa
Elongation	35%
CVN Impact Values	60J av @ +20°C

## CHEMICAL ANALYSIS (TYPICAL):

C: 0.03%	Cr: 23 %
Mn: 0.75%	Ni: 13%
Si: 0.9%	

## PART NUMBERS:

2.5mm	SPS30925
3.2mm	SPS30932
4.0mm	SPS30940

## OPERATING PARAMETERS & PACKAGING DETAILS:

Ø (mm)	Amperage	Polarity	OCV	Length (mm)	Pk	Carton
2.5	40-70	AC /DC electrode positive	45A min	300	2.5kg	15kg
3.2	75-110	AC /DC electrode positive	45A min	350	2.5kg	15kg
4.0	110-150	AC /DC electrode positive	45A min	350	2.5kg	15kg

# Murex™

- ★ Speedex™ 316L-16 is a E316L-16 type stainless steel electrode.
- ★ Designed for fillet and butt welding in all positions except vertical-down.
- ★ Speedex™ 316L-16 produces low spatter levels as well as smooth running.
- ★ For the welding of matching 316 and 316L stainless steel grades.

Speedex™ 316L-16 is a E308L-16 type stainless steel electrode designed for fillet & butt welding of matching 316 & 316L stainless steel grades.

Speedex™ 316L-16 offers low spatter levels with smooth running.

Applications for Speedex™ 316L-16 include the welding of matching grades used in pipes, tanks, vessels and componentry.

#### CLASSIFICATIONS:

AS/NZS 1553.3:	E316L-16.
AWS A5.4:	E316L-16.

#### MECHANICAL PROPERTIES (TYPICAL):

Yield Stress	480 MPa
Tensile Strength	630 MPa
Elongation	40%
CVN Impact Values	30J av @ -120°C

#### CHEMICAL ANALYSIS (TYPICAL):

C: 0.03%	Cr: 19.5 %
Mn: 0.8%	Ni: 11.5%
Si: 0.85%	Mo: 2.5%

#### PART NUMBERS:

2.5mm	SPS31625
3.2mm	SPS31632
4.0mm	SPS31640
5.0mm	SPS31650

#### WELDING POSITIONS



DOWNHAND



HORIZONTAL



VERTICAL



OVERHEAD

HORIZONTAL/  
VERTICAL

#### OPERATING PARAMETERS & PACKAGING DETAILS:

Ø (mm)	Amperage	Polarity	OCV	Length (mm)	Pk	Carton
2.5	40-70	AC /DC electrode positive	45A min	300	2.5kg	15kg
3.2	75-110	AC /DC electrode positive	45A min	350	2.5kg	15kg
4.0	110-150	AC /DC electrode positive	45A min	350	2.5kg	15kg
5.0	145-210	AC /DC electrode positive	45A min	350	2.5kg	15kg

# MUREX™

- ★ Speedex™ 312-16 is a E312-16 type stainless steel electrode designed for fillet & butt welding in all positions except vertical down.
- ★ Speedex™ 312-16 produces low spatter levels as well as smooth running.
- ★ Applications include the joining of stainless steels to mild steel and the welding of "unknown" steels.

Speedex™ 312-16 is designed for repair and maintenance applications on tool and die steels and steels of unknown compositions.

Speedex™ 312-16 is also recommended for joining dissimilar steels such as mild steel to stainless steel.

## WELDING POSITIONS



DOWNHAND



HORIZONTAL



VERTICAL



OVERHEAD

HORIZONTAL/  
VERTICAL

## CLASSIFICATIONS:

AS/NZS 1553.3:	E312-16.
AWS A5.4:	E312-16.

## MECHANICAL PROPERTIES (TYPICAL):

Yield Stress	635 MPa
Tensile Strength	785 MPa
Elongation	25%
CVN Impact Values	30J av @ +20°C

## CHEMICAL ANALYSIS (TYPICAL):

C: 0.10%	Cr: 26.5%
Mn: 0.62%	Ni: 9.15%
Si: 0.89%	

## PART NUMBERS:

2.5mm	SPS31225
3.2mm	SPS31232
4.0mm	SPS31240

## OPERATING PARAMETERS & PACKAGING DETAILS:

Ø (mm)	Amperage	Polarity	OCV	Length (mm)	Pk	Carton
2.5	40-80	AC /DC electrode positive	45A min	300	2.5kg	15kg
3.2	75-110	AC /DC electrode positive	45A min	350	2.5kg	15kg
4.0	110-150	AC /DC electrode positive	45A min	350	2.5kg	15kg



## WELDALL

45  
OCVAC  
DC+

- ▲ Easy-to-Use Rutile Type, High Alloy Electrode.
- ▲ Outstanding Operator Appeal!
- ▲ WELDS ALL Steels!
- ▲ Ideal for Repair & Maintenance Jobs.
- ▲ Easy Arc Starting and Excellent Stability on Low O.C.V. Welding Machines.
- ▲ Not Recommended for Welding Cast Irons.

## Classifications:

AS/NZS 1553.3 E312-17.  
AWS/ASME-SFA A5.4: E312-17.

## Description and Applications:

WELDALL is a highly alloyed stainless steel electrode which deposits a strong and ductile duplex austenite-ferrite weld metal extremely resistant to cracking.

WELDALL has a host of features which make it suitable for the welding of all types of steels. These include:

- ◆ Easy arc starting and excellent stability on low Open Circuit Voltage (O.C.V) welding machines such as the CIGWELD Easywelder EC.
- ◆ Rutile type flux coating gives smooth, stable running in all positions (except vertical down) especially on low current settings.
- ◆ High ferrite ( $\approx 40\%$ ) austenitic stainless steel deposit gives excellent resistance to hot cracking, even when diluted with carbon, austenitic and high alloy steels.
- ◆ Weld deposit gives excellent resistance to corrosion and oxidation.

WELDALL is recommended for the repair and maintenance of all steels, particularly those of unknown composition. It is suitable for:

- ◆ Joining dissimilar steels, such as stainless steel to carbon steel.
- ◆ Repairing die or tool steels.
- ◆ Use as a protective overlay against corrosion.
- ◆ Use as an intermediate or buffer layer prior to hard surfacing.

## TYPICAL ALL WELD METAL MECHANICAL PROPERTIES:

0.2% Proof Stress	630 MPa
Tensile Strength	780 MPa
Elongation	25%
CVN Impact Values	30 J av @ +20°C.

## TYPICAL ALL WELD METAL ANALYSIS:

C: 0.11%	Mn: 0.60%	Si: 0.88%
Cr: 27.0%	Ni: 9.10%	S: 0.011%
P: 0.020%		

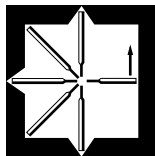

All positional - except vertical down

## Packaging and Operating Data:

AC (minimum 45 O.C.V.), DC+ polarity.

Electrode Size mm	Electrode Length mm	Approx. No. Rods/kg	Current Range (amps)	Packet	Carton	Easyweld Handipaks	Part No
2.5	300	57	40-80	2.5kg	15kg - 6 x 2.5kg	20 rod	611702 322101
3.2	350	30	75-110	2.5kg	15kg - 6 x 2.5kg	15 rod	611703 322102
4.0	350	20	110-150	2.5kg	15kg - 6 x 2.5kg		611704

## Easyweld Blister Pack:

10 x 2.5mm/5 x 3.2mm rod Weldall Blister Pack	322216
---	--------

- ▲ Maintenance Welding of S.G. Cast Irons.
- ▲ Joins Cast Iron to Steel.
- ▲ Lime Fluorspar / Graphite Coating.
- ▲ Higher Strength Nickel / Iron Deposit.
- ▲ Easy starting and Stable Running on Portable 240V Welding Machines.

### Classifications:

AWS/ASME-SFA A5.15: ENiFe-Cl.

### Description and Applications:

Castcraft 55 is a basic, graphite coated Nickel / Iron electrode manufactured by CIGWELD for the higher strength repair and maintenance welding of Spheroidal Graphite (S.G.) irons, austenitic cast irons, meehanites and a wide range of grey cast irons.

It produces a soft stable arc with minimal penetration and spatter and is very tolerant to parent metal contaminants such as oil and dirt. The ductile Nickel / Iron weld deposit is machinable

with the higher strength required for welding S.G. irons. Where higher joint strength is important, Castcraft 55 may be used for root and fill passes followed by capping passes with Castcraft 100 for a smoother surface finish.

### CORE WIRE:

Nickel Iron (55% Ni, 45% Fe)

### TYPICAL ALL WELD METAL MECHANICAL PROPERTIES:

Tensile Strength	500 MPa
Hardness.	220 HV <sub>30</sub>

### TYPICAL ALL WELD METAL ANALYSIS:

C: 0.95%	Mn: 0.65%	Si: 0.25%
Al: 0.25%	Ni: 53%	Fe: Bal

### COMPARABLE CIGWELD PRODUCTS:

Nicore 55 Cast Iron Flux Cored Wire  
AWS A5.15: ENiFe-Cl.



All downhand welding

### Procedure for Welding Oil Contaminated Cast Iron:

For welding oil impregnated cast iron an increased arc length of up to  $\approx 6$ mm is recommended to reduce the porosity in the weld deposit (caused by the oil) to an acceptable level. For heavy oil contamination, preheating the cast iron up to 200°C will also help to reduce porosity levels.

### Packaging and Operating Data:

AC (minimum 45 O.C.V.), DC- polarity.

Electrode Size mm	Electrode Length mm	Approx No. Rods/kg	Current Range (amps)	Packet	Carton	Part No
2.5	300	49	35-85	2.5kg	15kg – 6 x 2.5kg	611722
3.2	350	31	75–120	2.5kg	15kg – 6 x 2.5kg	611723

## CASTCRAFT 100

45  
OCVAC  
DC+

- ▲ Maintenance Welding of Cast Irons.
- ▲ Lime Fluorspar / Graphite Coating.
- ▲ Soft, Ductile Nickel Deposit.
- ▲ Easy starting and Stable Running on Portable 240V Welding Machines.
- ▲ Smoother Weld Deposit Surface Finish.

## Classifications:

AWS/ASME-SFA A5.15: ENi-CI.

## Description and Applications:

Castcraft 100 is a basic, graphite coated electrode manufactured by CIGWELD for the repair and maintenance of a wide range of cast iron components.

It produces a soft stable arc with minimal penetration and spatter and is very tolerant to parent metal contaminants such as oil and dirt. The ductile Nickel based weld deposit is readily machinable with good colour match to most cast irons.

Applications of Castcraft 100 include the repair and reclamation of engine blocks, cylinder heads, differential housings, gear boxes, pump and machine housings and cast iron pulleys etc. In some applications Castcraft 100 is preferred to Castcraft 55 because of the better 'wetting' action of the high nickel weld deposit.

## Procedure for Welding Oil Contaminated Cast Iron:

For welding oil impregnated cast iron an increased arc length of up to  $\approx 6$ mm is recommended to reduce the porosity in the weld deposit (caused by the oil) to an acceptable level. For heavy oil contamination, preheating the cast iron up to 200°C will also help to reduce porosity levels.

## Packaging and Operating Data:

AC (minimum 45 O.C.V.), DC- polarity.

Electrode Size mm	Electrode Length mm	Approx No. Rods/kg	Current Range (amps)	Packet	Carton	Easyweld Handipaks	Part No
2.5	300	49	55-85	2.5kg	15kg - 6 x 2.5kg		611732
						20 rod	322110
3.2	350	31	75-120	2.5kg	15kg - 6 x 2.5kg		611733
						15 rod	322111

## Easyweld Blister Pack:

10 x 2.5mm/5 x 3.2mm rod Castcraft 100 Blister Pack

322217

## CORE WIRE:

Nickel (98% Ni)

## TYPICAL ALL WELD METAL MECHANICAL PROPERTIES:

Tensile Strength	400 MPa
Hardness	170 HV <sub>30</sub>

## TYPICAL ALL WELD METAL ANALYSIS:

C: 1.0%	Mn: 0.05%	Fe: 0.5%
Si: 0.1%	Al: 0.2%	Ni: Bal



All downhand welding

- ▲ For Welding Copper and Copper Alloys.
- ▲ Also for Joining Copper and Copper Alloys to Steel.
- ▲ Easy to use, High Quality Weld Deposit Appearance.

**Classifications:**

AS/NZS 2576: E 6200 - A2  
AWS/ASME-SFA A5.6: E CuSn - C

**Description and Applications:**

Fully extruded phosphor bronze electrode containing approximately 7% tin.

The covering is a fully extruded graphite / lime fluorspar type giving an extremely soft arc action similar to the CASTCRAFT series.

The BRONZECRAFT AC-DC electrode deposits dense, sound weld metal comparable in physical properties and colour to phosphor bronze.

Suitable for welding copper and copper base alloys. Building up parts in gun-metal, phosphor bronze, aluminium bronze and silicon bronze alloys.

- ◆ Bronze ship propellers
- ◆ Copper bus-bars
- ◆ Copper to steel
- ◆ Bearing surfaces
- ◆ Impeller blades

Suitable also for some cast irons.

**Packaging and Operating Data:**

AC (minimum 45 O.C.V.), DC- polarity.

Electrode Size mm	Electrode Length mm	Approx No. Rods/kg	Current Range (amps)	Packet	Carton	Part No
3.2	350	30	70-110	2.5kg	15kg - 6 x 2.5kg	611783

**TYPICAL ALL WELD METAL MECHANICAL PROPERTIES:**

0.2% Proof Stress	315 MPa
Tensile Strength	460 MPa
Elongation	22%
Hardness.	120 HV30

**TYPICAL ALL WELD METAL ANALYSIS:**

Mn: 0.02%	Sn: 7.50%	Al: 0.008%
P: 0.26%	Fe: 0.20%	Cu: Bal

**COMPARABLE CIGWELD PRODUCTS:**

Autocraft Silicon Bronze Copper Alloy MIG Wire  
AWS A5.7: ERCuSi-A.

Comweld Silicon Bronze Copper Alloy TIG Wire  
AWS A5.7: RCuSi-A.

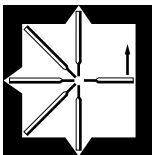

All positional - except vertical down

- ▲ Fast, Clean, Smooth, hassle-free Gouging.
- ▲ Able to Remove Metal from a Wide Range of Common Ferrous & Non-Ferrous Metals.
- ▲ Designed for DC Operation.
- ▲ Superior arc stability.

### Description and Applications:

CIGWELD Arcair DC gouging carbons are made by mixing carbon/graphite with a binder, baking, and then coating with a controlled thickness of copper. Carbons are available in three types; Pointed, Jointed and Flat.

- ◆ Pointed carbons are the standard all purpose gouging electrode. Controlled copper coating improves electrical conductivity providing more efficient, cooler operation and helps maintain electrode diameter at the point of the arc.
- ◆ Jointed carbons have the added benefit of working without stub loss, with each rod having a female socket and matching male tang. They can be used with semi and fully automatic torches.
- ◆ Flat carbons are specially designed for close tolerance metal removal and scarfing applications, producing a rectangular groove.

Air-carbon arc gouging is done in the downhand, vertical, horizontal and overhead position with a stick out of 180mm and an electrode angle of approximately 35 degrees, depending on the application.

**The groove width obtained will be approximately 3mm wider than the carbon size.**

The gouging action occurs when the arc is struck, removing molten metal as the electrode is moved along the workpiece. A slow travel speed produces a deep groove, a fast travel speed produces a shallow groove.

The air flow must be turned on before gouging commences. The operator must ensure that adequate eye (shade 12-14), ear and clothing protection is worn.

**Severing** (cutting) is a form of gouging where the operator holds the electrode at a steeper travel angle ( $70 - 80^\circ$ ) to the workpiece and moves the arc in a sawing motion (Figure 1). A gouging carbon can cut non-ferrous materials 1.5 times its own thickness.

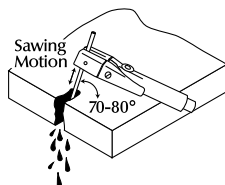

**Washing** is a form of gouging that allows the removal of metal from large areas, hardfacing deposits and riser pads on castings. An arc is struck and then the electrode is weaved from side to side using a travel angle of  $15 - 70^\circ$  to the workpiece, depending on the required depth of the gouge. (Figure 2)

Electrode has shallower angle than Severing

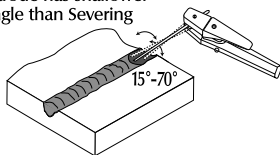

**Bevelling** can be achieved by using a travel angle of 90 degrees and a work angle equal to the bevel angle (Figure 3).

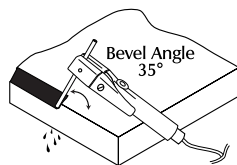

CIGWELD Arcair gouging carbons are used for the efficient gouging, back gouging, plate edge preparation, touching up and removal of old or defective hardfacing and stainless steel weld deposits. They are used for reworking plates, dies, castings, pipes, armour plating etc. They gouge and sever ferrous and non-ferrous metals such as carbon steel, low alloy steel, stainless steel, cast iron, nickel alloys (nickel less than 80%), magnesium alloys and aluminium on DCEP. Copper alloys, aluminium bronze alloys and aluminium nickel bronze alloys can be gouged using DCEN.

Air carbon-arc gouging is used in many industries such as agriculture, automotive, heavy fabrication, construction, foundries, maintenance and repair shops, mining and quarrying, military, shipyards, power plants, railroads, steel mills to name a few.

#### Conditioning Data:

If carbons are damp, they should be redried at 180°C for 10 hours, otherwise they may shatter.

#### HIGH EFFICIENCY GOUGING CARBONS:

Arcair's high efficiency gouging carbon takes carbon technology and performance to a new level. Formulated with a reduced carbon content and increased copper coating they can carry a current up to 800 amps (an increased carrying capacity of 25%) while giving up to 10% greater metal removal. The improved outer strength of these carbons allows for additional stick out length and the fluted exterior adds to the improved current flow and carrying capacity.

#### Packaging and Operating Data:

	CIGWELD Part No.	Size (mm)	Rods per pack	Current range (Amps)	Air Pressure (kPa)	(L/min)
POINTED	22043003	6.5 x 305	50	300 - 400	550 - 690	450
	22053003	8 x 305	50	350 - 450	550 - 690	450
	22063003	9.5 x 305	50	450 - 600	550 - 690	450
JOINTED	24104003	16 x 430	100	1000 - 1250	550 - 690	930
	24124003	19 x 430	100	1250 - 1600	550 - 690	930
FLAT	35033003	15 x 5 x 305	50	450 - 600	550 - 690	450
HIGH EFFICIENCY	22155006	9.5	50	450-800	550-690	450

# Arcair®





<b>Description</b>	<b>Page No</b>
Cobalarc Austex	72
Cobalarc Mangcraft	73
Cobalarc 350	74
Cobalarc 650	75
Cobalarc 750	76
Cobalarc Toolcraft	77
Cobalarc CR70	78
Cobalarc BoroChrome	79
Cobalarc 1e	80
Cobalarc 9e	81
Stody Tube Borium AC-DC (Cobalarc 4)	82
Stody Dynamang-O (Cobalarc Mang Nickel-O)	84
Stody Buildup-O (Cobalarc 250-O)	85
Stody Super Buildup-G/O (Cobalarc 350-G/O)	86
Stody 965-G/O (Cobalarc 650-G/O)	87
Stody 850-O	88
Stody 101 HC-G/O (Cobalarc Coarseclad-G/O (1.2, 1.6))	89
Stody 100 HC-O (Cobalarc Coarseclad-O (2.4 & 2.8))	90
Stody Fineclad-O (Cobalarc Fineclad-O)	91
Stody 110 MC (Cobalarc Crome Mang-O)	92
Stody 104 (Cobalarc 104-SA)	93
Stody 105 (Cobalarc 105-SA)	94
Stody 107 (Cobalarc 107-SA)	95
Stody 600 (Cobalarc Impactaclad-O)	96
Stody 143-O (Cobalarc Abrasoclad-O)	97
Stody 145 Open Arc Wire	98
Stody RA45-0	99
Stody 'S' Flux	100



## COBALARC AUSTEX

HV<sub>30</sub>  
40050  
OCVDC  
AC

- ▲ Metal Enriched, Rutile Type Electrode.
- ▲ For Joining Dissimilar steels or as a Buffer Layer Prior to Hard Surfacing.
- ▲ Tough, Machinable Austenitic Stainless Steel Deposit.

3.2mm size can be used for vertical welding by depositing overlapping horizontal stringer passes.

## Classifications:

AS/NZS 2576: 1315-A4.  
W.T.I.A. Tech Note 4: 1315-A4.

## Description and Applications:

Cobalarc AUSTEX is a metal enriched, rutile type extruded electrode manufactured by CIGWELD. It produces a smooth arc action and higher deposition rates than conventional stainless steel electrodes.

Deposited weld metal has high strength and toughness in combination with excellent corrosion resistance and tolerance to dilution. Under heavy impact weld deposits will work harden.

Typical applications of Cobalarc AUSTEX include the joining of dissimilar steels, in particular austenitic manganese steels or stainless steels to mild steel and deposition as a buffer layer prior to hard surfacing.

The high tolerance to dilution makes Cobalarc AUSTEX ideal for crack repairs on high carbon steel components or manganese steel castings.

## Packaging and Operating Data:

AC (50 O.C.V.), DC+ or DC- polarity.

Size mm	Electrode		Current Range (amps)	Packet	Carton	Part No
	Length mm	No. of Electrodes per kg.				
3.2	380	20	105-140	5kg	15kg - 3 x 5kg	613973
4.0	380	13	140-180	5kg	15kg - 3 x 5kg	613974
5.0	450	7	170-210	5kg	15kg - 3 x 5kg	613975

## TYPICAL ALL WELD METAL DEPOSIT ANALYSIS:

C: 0.10% Mn: 1.50% Si: 0.90%  
Cr: 24.5% Ni: 9.3%

## TYPICAL WELD DEPOSIT HARDNESS:

	HRC	HV <sub>30</sub>
All Weld Metal Deposit	20	240
Work Hardened Deposit	40	400

## FINISHING RECOMMENDATIONS:

Machinable with Carbide Tools.

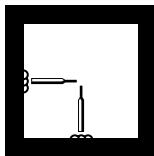

Downhand & Horizontal joining and build-up applications:-

3.2mm size can be used for vertical welding by depositing overlapping horizontal stringer passes.

- ▲ **Austenitic Manganese Steel Electrode for Building Up & Reinforcing 11-14% Manganese Steel Components.**
- ▲ **Tough and Impact Resistant.**
- ▲ **Work Hardens Under Impact.**

### Classifications:

AS/NZS 2576: 1215 - A4.  
 W.T.I.A. Tech Note 4: 1215 - A4.

### Description and Applications:

Cobalarc MANGCRAFT is a smooth running electrode depositing austenitic manganese steel weld metal. The deposits are extremely tough with high resistance to impact. They will work harden under impact loading giving added abrasion resistance.

Mangcraft is used for rebuilding austenitic manganese steel components either to finished dimensions or prior to applying an overlay of more abrasion resistant material.

Typical components include dredge bucket lips, swing hammers, grizzleys, bucket teeth, blow bars, crusher jaws, liners and concaves. Keep austenitic manganese steels cool during welding. Do not preheat. Use intermittent or staggered weld runs and water quench at frequent intervals if necessary.

### Packaging and Operating Data:

AC (55 O.C.V.), DC+ or DC- polarity.

Electrode Size mm	Electrode Length mm	No. of Electrodes per kg.	Current Range (amps)	Packet	Carton	Part No
4.0	380	17	130-170	5kg	15kg - 3 x 5kg	611504
5.0	450	10	150-200	5kg	15kg - 3 x 5kg	611505

### TYPICAL ALL WELD METAL DEPOSIT ANALYSIS:

C: 0.60% Mn: 12.0% Si: 0.10%

### TYPICAL WELD DEPOSIT HARDNESS:

	HRC	HV30
All Weld Metal Deposit	15	---
Work Hardened Deposit	43	425

### FINISHING RECOMMENDATIONS:

Machinable with Carbide Tools.

### COMPARABLE CIGWELD PRODUCTS:

Stoody Dynamang-O tubular wire  
 AS/NZS 2576: 1215-B7

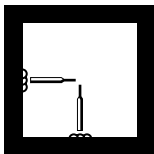

Downhand & Horizontal build-up applications

## COBALARC 350

HV<sub>30</sub>  
35050  
OCVDC  
AC

- ▲ Metal Enriched, Rutile Type Electrode.
- ▲ For Re-building Worn Steel Components.
- ▲ Tough, Machinable Low Carbon Martensitic Steel Deposit.
- ▲ For the manual arc build-up and surfacing of steel gear, shafts, rails, shovel pads, track links, rolls and wheels etc.

3.2mm and 4.0mm sizes can be used for vertical welding by depositing overlapping horizontal stringer passes.

## Classifications:

AS/NZS 2576: 1435-A4.  
W.T.I.A. Tech Note 4: 1435-A4.

## Description and Applications:

Cobalarc 350 is a metal enriched, rutile type electrode recommended for the multi-layer build-up and surfacing of steel components subjected to metal-to-metal wear and compressive loading.

## TYPICAL ALL WELD METAL DEPOSIT ANALYSIS:

C: 0.07% Mn: 0.85% Si: 0.30%  
Cr: 1.85% Mo: 0.5%

## TYPICAL WELD DEPOSIT HARDNESS:

	HRC	HV <sub>30</sub>
Single Layer on Mild Steel	28	290
All Weld Metal Deposit	35	350

## FINISHING RECOMMENDATIONS:

Machinable.

## COMPARABLE CIGWELD PRODUCTS:

Stoody Super Build up-O tubular wire  
AS/NZS 2576: 1435-B5/B7

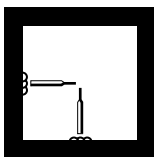

Downhand & Horizontal surfacing and build-up applications:-  
3.2mm and 4.0mm sizes can be used for vertical welding by depositing overlapping horizontal stringer passes.

Depositing a tough, air hardening low carbon martensitic steel weld deposit Cobalarc 350 is recommended for the manual arc build-up and surfacing of steel gears, shafts, rails, shovel pads, track links, rolls and wheels etc.

## Packaging and Operating Data:

AC (minimum 55 O.C.V.), DC+ or DC- polarity.

Size mm	Electrode		No. of Electrodes per kg.	Current Range (amps)	Packet	Carton	Part No
	Length mm						
3.2	380		25	100-150	5kg	15kg - 3 x 5kg	611443
4.0	380		16	140-200	5kg	15kg - 3 x 5kg	611444
4.0	380		16	140-200	1kg	12kg - 12 x 1kg	610444

- ▲ Basic Type Manual Arc Welding Electrode.
- ▲ Resistant to Hard Particle Abrasion and Moderate Impact Loading.
- ▲ Air Hardening, Crack Free, Martensitic Steel Deposit - 650 HV<sub>30</sub>

### Classifications:

AS/NZS 2576: 1855-A4.  
W.T.I.A. Tech Note 4: 1855-A4.

### Description and Applications:

Cobalarc 650 is a basic electrode for the hard surfacing of steel components subjected to wet or dry hard particle abrasion and low to moderate impact loading.

The air hardening, low alloy steel deposit of Cobalarc 650 remains crack free on most steels under normal welding conditions and is therefore recommended for hard surfacing components subject to flexing during service.

The basic flux coating gives excellent resistance to rust, mill scale, dirt and oil on the surface being hardfaced.

Typical applications include the surfacing of agricultural points, shares and tynes, grader and dozer blades, conveyor screws and post hole augers etc.

### Packaging and Operating Data:

AC (minimum 55 O.C.V.), DC+ or DC- polarity.

Electrode Size mm	Electrode Length mm	No. of Electrodes per kg.	Current Range (amps)	Packet	Carton	Part No
3.2	380	31	105-135	5kg	15kg - 3 x 5kg	611463
4.0	380	21	140-180	5kg	15kg - 3 x 5kg	611464

### TYPICAL ALL WELD METAL DEPOSIT ANALYSIS:

C: 0.58%	Mn: 1.1%	Si: 0.6%
Cr: 5.3%	Mo: 0.25%	

### TYPICAL WELD DEPOSIT HARDNESS:

	HRC	HV <sub>30</sub>
Single Layer on Mild Steel	55	600
All Weld Metal Deposit	57	640

### FINISHING RECOMMENDATIONS:

Not Machinable / Grinding only.

### COMPARABLE CIGWELD PRODUCTS:

Stoody 965 G/O tubular wire  
AS/NZS 2576: 1855-B5/B7  
Stoody 850-O tubular wire  
AS/NZS 2576: 1865-B7

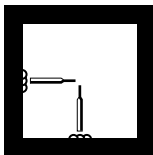

Downhand & Horizontal surfacing applications: -  
3.2mm and 4.0mm sizes can be used for vertical welding by depositing overlapping horizontal stringer passes.

## COBALARC 750

HV<sub>30</sub>  
80045  
OCVAC  
DC+

- ▲ Rutile type, AC/DC Hard Surfacing Electrode.
- ▲ Resistant to Hard Particle Abrasion.
- ▲ Air Hardening, Crack Free, Martensitic Steel Deposit - 750 HV<sub>30</sub>
- ▲ Easy Arc Starting and Stable Running on Portable AC Welding Sets (≥ 45 O.C.V. ).

## Classifications:

AS/NZS 2576:	1860-A4.
W.T.I.A. Tech Note 4:	1860-A4.

## Description and Applications:

Cobalarc 750 is a NEW smooth running, rutile type electrode specifically designed for AC hard surfacing applications in the workshop or on the land.

It gives smooth stable arcing on AC or DC welding machines and is particularly suitable for surfacing with portable AC welding sets (with ≥ 45 Open Circuit Volts) such as the CIGWELD Easywelder. Cobalarc 750 should be used with a touch welding or short arc technique and 1-2 layers are recommended for maximum deposit hardness.

When hard surfacing high carbon or low alloy steel components a buffer or buttering layer of

Ferrocrafft 16TXP or Ferrocrafft 7016 is recommended prior to depositing Cobalarc 750.

Typical applications include the surfacing of agricultural equipment and components including points, shares, post hole augers, ripper teeth and tyres etc.

## Packaging and Operating Data:

AC (minimum 45 O.C.V.), DC+ polarity.

Electrode Size mm	Electrode Length mm	No. of Electrodes per kg.	Current Range (amps)	Packet	Carton	Part No
3.2	380	26	95-130	5kg	15kg - 3 x 5kg	611473
4.0	380	17	120-170	5kg	15kg - 3 x 5kg	611474

## Easyweld Blister Pack:

10 x 3.2mm rod Cobalarc 750 Blister Pack	322218
--	--------

## TYPICAL ALL WELD METAL DEPOSIT ANALYSIS:

C: 0.60%	Mn: 0.46%	Si: 0.75%
Cr: 5.9%	Mo: 0.40%	

## TYPICAL WELD DEPOSIT HARDNESS:

	HRC	HV <sub>30</sub>
Single Layer on Mild Steel	64	800
Two Layers on Mild Steel*	62	750

\*Not recommended for multi-pass welding heavier than 3 layers

## FINISHING RECOMMENDATIONS:

Not Machinable / Grinding only.

## COMPARABLE CIGWELD PRODUCTS:

Cobalarc 650 manual arc electrode  
AS/NZS 2576: 1855-A4  
Stoody 965-G/O tubular wire  
AS/NZS 2576: 1855-B5/B7  
Stoody 850-O tubular wire  
AS/NZS 2576: 1865-B7

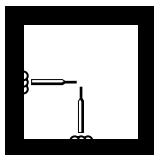

Downhand & Horizontal hard surfacing applications:-  
3.2mm and 4.0mm sizes can be used for vertical welding by depositing overlapping horizontal stringer passes.

- ▲ Versatile Manual Arc Welding Electrode.
- ▲ Secondary Hardening, Shock Resistant Properties.
- ▲ Crack Free Cr-Mo Steel Deposit for Repairing Blades, Dies, Punches etc.
- ▲ Also Suitable for General Hard Surfacing in Low Stress Abrasion Conditions.

3.2mm size can be used for vertical welding by depositing overlapping horizontal stringer passes.

### Classifications:

AS/NZS 2576: 1560-A4.

W.T.I.A. Tech Note 4: 1560-A4.

### Description and Applications:

Cobalarc Toolcraft is a versatile electrode for welding on mild, carbon and low alloy steels. The weld deposit has excellent abrasion / shock resistance and secondary hardness retention to 500°C.

The air hardening, low alloy Cr-Mo steel deposit of Cobalarc Toolcraft remains crack free on most steels under normal welding conditions and deposits can be ground to produce a long-lasting cutting edge.

Typical applications include the maintenance/repair of guillotine blades, cutting knives, punches, axes, lathe tools, chisels and debarking hammers. Cobalarc Toolcraft is also suitable for general hard surfacing applications under low stress abrasion conditions.

### Deposit Annealing and Hardening:

Cobalarc Toolcraft deposits can be annealed by slow heating to 800°C, holding at temperature for one hour followed by furnace cooling.

For deposit re-hardening to ≈ 60 HR<sub>c</sub> preheat slowly to 800 - 850°C then rapidly to 1250 - 1300°C, hold at temperature for ≈ 10 minutes and then quench in oil. For full hardness, temper twice at 520 - 530°C for one hour.

### Packaging and Operating Data:

AC (minimum 45 O.C.V.), DC+ polarity.

Electrode		No. of Electrodes per kg.	Current Range (amps)	Packet	Carton	Part No
Size mm	Length mm					
2.5	300	54	60-90	20 rods		322115
3.2	380	28	90-125	5kg	15kg - 3 x 5kg	611523

### TYPICAL ALL WELD METAL DEPOSIT ANALYSIS:

C: 0.58%	Mn: 0.10%	Si: 0.20%
Cr: 5.5%	Mo: 6.8%	

### TYPICAL WELD DEPOSIT HARDNESS:

	HR <sub>c</sub>	HV <sub>30</sub>
Single Layer on Mild Steel	55	600
All Weld Metal Deposit	60	700

### FINISHING RECOMMENDATIONS:

Not Machinable / Grinding only.

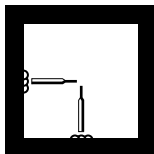

Downhand & Horizontal surfacing applications:-  
3.2mm size can be used for vertical welding by depositing overlapping horizontal stringer passes.

## COBALARC CR70

HV<sub>30</sub>  
59050  
OCVAC  
DC+

- ▲ Highly Alloyed Manual Arc Electrode.
- ▲ High Chromium Carbide Iron Deposit.
- ▲ Primary Chromium Iron Carbides in a Single Layer.
- ▲ Ideal for Coarse Abrasion and Low to Moderate Impact Loading.
- ▲ Typical applications of Cobalarc CR70 include the hard surfacing of crusher cones and mantles, swing hammers, bucket teeth and lips, dozer end plates and sugar mill rolls etc.

3.2mm and 4.0mm sizes can be used for vertical welding by depositing overlapping horizontal stringer passes.

## Classifications:

AS/NZS 2576: 2355-A4.  
W.T.I.A. Tech Note 4: 2355-A4.

## Description and Applications:

Cobalarc CR70 is a popular high alloy extruded hard surfacing electrode manufactured by CIGWELD. The weld deposit of Cobalarc CR70 produces a high level of primary chromium carbides resistant to coarse abrasion (in particular gouging abrasion) and moderate impact loading at temperatures up to  $\approx 650^{\circ}\text{C}$ .

Weld deposits can be finished by grinding and are best limited to two layers because of relief checking.

Typical applications of Cobalarc CR70 include the hard surfacing of crusher cones and mantles, swing hammers, bucket teeth and lips, dozer end plates and sugar mill rolls etc.

## Packaging and Operating Data:

AC (minimum 50 O.C.V.), DC+ polarity.

Electrode Size mm	Electrode Length mm	No. of Electrodes per kg.	Current Range (amps)	Packet	Carton	Part No
3.2	380	18	90-140	5kg	15kg - 3 x 5kg	613493
4.0	380	11	130-200	5kg	15kg - 3 x 5kg	613494
5.0	450	6	180-250	5kg	15kg - 3 x 5kg	613495

## TYPICAL WELD DEPOSIT ANALYSIS:

Single Layer on Mild Steel:

C: 3.3% Mn: 1.5% Si: 1.0% Cr: 25%

All Weld Metal Deposit:

C: 4.0% Mn: 1.8% Si: 1.2% Cr: 31%

## TYPICAL WELD DEPOSIT HARDNESS:

	HR <sub>C</sub>	HV <sub>30</sub>
Single Layer on Mild Steel	55	600
All Weld Metal Deposit	59	690

Deposits contain Chromium Carbides with hardness up to 1,500 HV.

## FINISHING RECOMMENDATIONS:

Grinding only.

## COMPARABLE CIGWELD PRODUCTS:

Stoody 100 HC-G/O tubular wire  
AS/NZS 2576: 2360-B5/B7

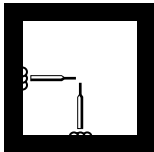

Downhand & Horizontal surfacing applications:-  
3.2mm and 4.0mm sizes can be used for vertical welding by depositing overlapping horizontal stringer passes.

- ▲ Highly Alloyed Manual Arc Electrode.
- ▲ Martensitic Chromium Carbide Iron Deposit.
- ▲ Ideal for Fine Particle (Wet or Dry) Abrasion and Low Impact Loading.
- ▲ Primary Chromium Iron Carbides in a Hard, Martensitic Matrix.

### Classifications:

AS/NZS 2576: 2560-A4.  
 W.T.I.A. Tech Note 4: 2560-A4.

### Description and Applications:

Cobalarc BOROCHROME is a popular high alloy extruded hardsurfacing electrode manufactured by CIGWELD. The addition of nominally 1% Boron to Cobalarc BOROCHROME produces an ultra fine, martensitic matrix in the weld deposit particularly resistant to wet or dry abrasive or erosive media. Weld deposits can be finished by grinding and are best limited to two layers because of relief checking. Typical applications of Cobalarc BOROCHROME include the hard surfacing of sand chutes, dredge components, ripper shanks, screens, grizzly bars, scraper blades and bucket lips and teeth.

### TYPICAL WELD DEPOSIT ANALYSIS:

Single Layer on Mild Steel:		
C: 2.7%	Mn: 0.4%	Si: 1.8%
Cr: 20.0%	V: 1.4%	B: 1.0%
All Weld Metal Deposit:		
C: 3.2%	Mn: 0.4%	Si: 2.4%
Cr: 24.0%	V: 1.7%	B: 1.2%

### TYPICAL WELD DEPOSIT HARDNESS:

	HR <sub>C</sub>	HV <sub>30</sub>
Single Layer on Mild Steel	58	660
All Weld Metal Deposit	60	700
Deposits contain Chromium Carbides with hardness up to 1,500 HV.		

### FINISHING RECOMMENDATIONS:

Grinding only.

### COMPARABLE CIGWELD PRODUCTS:

Stoody FINECLAD-O tubular wire  
 AS/NZS 2576: 2565-B7

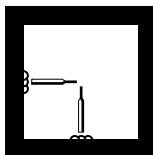

Downhand & Horizontal surfacing applications

### Packaging and Operating Data:

AC (minimum 50 O.C.V.), DC+ polarity.

Electrode		No. of Electrodes per kg.	Current Range (amps)	Packet	Carton	Part No
Size mm	Length mm					
4.0	380	11	140-180	5kg	15kg – 3 x 5kg	613964
5.0	450	6	170-210	5kg	15kg – 3 x 5kg	613965



## COBALARC 1e

HV<sub>30</sub>  
73055  
OCVAC  
DC+

- ▲ Highly Alloyed Extruded Electrode.
- ▲ High Chromium Carbide Iron Deposit.
- ▲ Ideal for Coarse Abrasion and Low to Moderate Impact Loading.
- ▲ For wear resistant overlays on austenitic manganese steels.

## Classifications:

AS/NZS 2576:	2360-A4.
W.T.I.A. Tech Note 4:	2360-A4.

## Description and Applications:

Cobalarc 1e electrodes deposit an abrasion resistant weld deposit specially formulated for use on austenitic manganese steels. It is ideal for service involving abrasion combined with heavy impact.

For hardfacing 11-14% manganese steel items such as swing hammers, crusher jaws, bucket lips and teeth, grizzlies, gyratory and cone crusher parts, shovel dipper gums, etc.

Relief checking of the deposit is normal so the build-up is best limited to two layers.

## TYPICAL WELD DEPOSIT ANALYSIS:

All Weld Metal Deposit:

C: 5.00% Mn: 1.10% Si: 1.3% Cr: 35.0%

## TYPICAL WELD DEPOSIT HARDNESS:

	HRc	HV <sub>30</sub>
Single Layer on Mild Steel	58	660
All Weld Metal Deposit	61	730

Deposits contain complex chromium carbides with hardness up to 1,500 HV.

## FINISHING RECOMMENDATIONS:

Grinding only.

## COMPARABLE CIGWELD PRODUCTS:

Cobalarc CR70 extruded electrode

AS/NZ 2576: 2355-A4

Stoody 100 HC-G/O tubular wire

AS/NZ 2576: 2360-B7

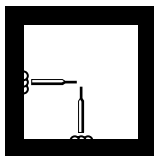

Downhand & Horizontal surfacing applications.

## Packaging and Operating Data:

AC (minimum 50 O.C.V.), DC+ polarity.

Size mm	Electrode		No. of Electrodes per kg.	Current Range (amps)	Packet	Carton	Part No
	Length mm						
4.0	380		10	130-190	5kg	15kg - 3 x 5kg	613210
5.0	450		5	180-260	5kg	15kg - 3 x 5kg	613235

- ▲ Highly Alloyed Extruded Electrode
- ▲ Versatile, Complex Carbide Iron Deposit.
- ▲ Resistant to both Coarse and Fine Abrasion and Moderate to Heavy Impact Loading.
- ▲ Typical applications include the hard surfacing of railway ballast tampers, dredge buckets and lips, earth moving equipment, power shovels, rolling mill guides, sizing screens, ripper teeth and crushing equipment.

### Classifications:

AS/NZS 2576:	2460-A4.
W.T.I.A. Tech Note 4:	2460-A4.

### Description and Applications:

Cobalarc 9e is the most versatile extruded hard surfacing electrode in the CIGWELD range.

The complex chromium rich carbides in Cobalarc 9e make it highly resistant to both coarse and fine abrasion while retaining the toughness to withstand moderate to heavy impact.

Typical applications of Cobalarc 9e include the hard surfacing of railway ballast tampers, dredge buckets and lips, earth moving equipment, power shovels, rolling mill guides, sizing screens, ripper teeth and crushing equipment.

### Packaging and Operating Data:

AC (minimum 50 O.C.V.), DC+ polarity.

Size mm	Electrode		Current Range (amps)	Packet	Carton	Part No
	Length mm	No. of Electrodes per kg.				
3.2	380	17	90-140	5kg	15kg - 3 x 5kg	613350
4.0	380	10	130-190	5kg	15kg - 3 x 5kg	613360
5.0	450	5	180-260	5kg	15kg - 3 x 5kg	613370

### TYPICAL WELD DEPOSIT ANALYSIS:

Single Layer on Mild Steel:

C: 4.8%	Mn: 1.1%	Si: 1.4%	Cr: 30.0%
Ni: 0.5%	Mo: 1.7%	V: 0.2%	

### TYPICAL WELD DEPOSIT HARDNESS:

	HRC	HV <sub>30</sub>
Single Layer on Mild Steel	58	660
All Weld Metal Deposit	63	780

Deposits contain complex Chromium Carbides with hardness up to 1,500 HV.

### FINISHING RECOMMENDATIONS:

Grinding only.

### COMPARABLE CIGWELD PRODUCT:

Stoody 143-O tubular wire

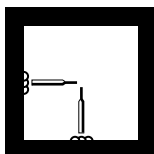

Downhand & Horizontal surfacing applications:-  
5.0mm and 6.3mm sizes can be used for vertical surfacing by depositing overlapping horizontal stringer passes.

## STOODY TUBE BORIUM AC/DC

HV<sub>30</sub>  
73055  
OCVAC  
DC+

## Replaces Cobalarc 4

- ▲ Highly Alloyed Tubular Electrode.
- ▲ Partially Dissolved Tungsten Carbides bonded in an Iron Rich Matrix.
- ▲ Resistant to Extreme Abrasion and Low Impact Loading.

## Classifications:

AS/NZS 2576:	3460-A4.
W.T.I.A. Tech Note 4:	3460-A4.

## Description and Applications:

Stoody AC-DC Tube Borium is a tubular hard surfacing electrode which deposits a highly wear resistant weld metal consisting of very hard partially dissolved tungsten carbides in an iron rich matrix.

Stoody AC-DC Tube Borium coated electrode is manufactured by metering crushed tungsten carbide particles of controlled mesh size into steel tubes. It receives a thin graphitic coating. The tungsten carbide particles are available in a variety of sizes – fine mesh size increases wear resistance and coarse improves cutting efficiency.

Typical applications include: hard surfacing of fan and pump impellers, pug mill augers and knives, furrowing shovels, scraper/ mixer blades, rasp bars, muller plows, sand and gravel chutes, feed screws, ripper tynes, subsoiler points and tool joints.

Stoody AC-DC Tube Borium should not be used in applications involving heavy impact or shock loading.

## OPERATIONAL CHARACTERISTICS/WELDING PARAMETERS:

Diameter	4.0mm	4.8mm	6.4mm
Mesh Size	20-30	20-30	10-30
Position	Flat	Flat	Flat

## TYPICAL WELD DEPOSIT ANALYSIS\*:

Single Layer on Mild Steel:			
C: 3.1%	Mn: 0.9%	W: 44%	Cr: 6%
All Weld Metal Deposit:			
C: 3.7%	Mn: 1.0%	W: 53%	Cr: 7%

## TYPICAL WELD DEPOSIT HARDNESS:

	HRC	HV <sub>30</sub>
Single Layer on Mild Steel	62	750
All Weld Metal Deposit	64	800

Deposits contain Tungsten Carbides with hardness up to 2,200 HV.

\* Actual weld deposit consists of undissolved Tungsten Carbide particles in a eutectic matrix of C-W-Cr-Fe. The analysis of the matrix will vary with the proportion of Tungsten Carbides dissolved during welding.

## FINISHING RECOMMENDATIONS:

Grinding only.

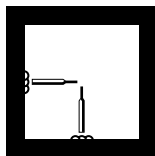

Downhand & Horizontal surfacing applications.

## Packaging and Operating Data:

AC (minimum 50 O.C.V.), DC+ polarity.

Electrode Size mm	Electrode Length mm	No. of Electrodes per kg.	Current Range (amps)	Packet	Carton	Part No
5.5	350	9	120-150	4.5kg vack pack		10229500

NOTE: one size only



## STOODY DYNAMANG-O



(Replaces Cobalarc Mang Nickel-O)

- ▲ Self Shielded (-O), Tubular Hardfacing Wire.
- ▲ Tough, Work Hardening Austenitic Manganese Steel Deposit.
- ▲ Typical applications include the repair of Manganese steel crusher rolls, jaw and hammer crushers, gyratory mantles, blow bars and dredge pump cutters etc.
- ▲ 1.6mm size can be used for vertical surfacing by depositing overlapping horizontal stringer passes.

**Classifications:**

AS/NZS 2576: 1215-B7.  
W.T.I.A. Tech Note 4: 1215-B7.

**Description and Applications:**

Stoody Dynamang-O is a high alloy tubular wire depositing a manganese steel weld metal for the repair and joining of matching Manganese steel components used in the quarrying and mining industries.

Resultant weld deposits have high strength and elongation and are extremely resistant to impact loading. Stoody Dynamang-O can be multi-layered to any thickness without relief checking and deposits will work harden during service under high impact loading.

Typical applications include the repair of Manganese steel crusher rolls, jaw and hammer crushers, gyratory mantles, blow bars and dredge pump cutters etc.

**Packaging and Operating Data:**

DC Electrode Positive.

Wire Dia. mm	Current Range (amps)	Voltage Range (volts)	Electrode Stickout mm	Pack Type	Pack Weight	Part No
1.6	200-250	23-27	12-25	Spool	15kg	11446700
2.8	275-375	25-28	20-45	Coil	27kg	11249900

**TYPICAL ALL WELD METAL DEPOSIT ANALYSIS:**

C: 0.90% Mn: 13.40% Si: 0.37%  
Ni: 2.7% Cr: 2.50%

**TYPICAL WELD DEPOSIT PROPERTIES:**

Yield Stress 615 MPa  
Tensile Strength 810 MPa  
Elongation 21%

**TYPICAL WELD DEPOSIT HARDNESS:**

	HRC	HV <sub>30</sub>
All Weld Metal Deposit	17	220
Work Hardened	42	410

**FINISHING RECOMMENDATIONS:**

Machinable as Deposited.

**RECOMMENDED SHIELDING GAS:**

- Open arc or welding grade CO<sub>2</sub> ISO14175: C1

**COMPARABLE CIGWELD PRODUCTS:**

Cobalarc Mangcraft extruded electrode  
AS/NZS 2576: 1215-A4

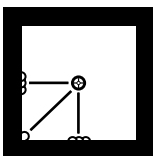

Downhand & Horizontal surfacing applications:-

1.6mm size can be used for vertical surfacing by depositing overlapping horizontal stringer passes.

(Replaces Cobalarc 250-O)

- ▲ Self shielded (-O), tubular build-up wire.
- ▲ Tough, machinable low carbon pearlitic steel deposit.
- ▲ Resistant to high compressive loading.
- ▲ Ideal as an underbase prior to hardfacing.
- ▲ For re-building worn steel components.

### Classifications:

AS/NZS 2576: 1125-B7.

W.T.I.A.Tech Note 4: 1125-B7.

### Description and Applications:

Stoody Buildup-O is an open arc tubular wire developed for the re-building of steel components subjected to high compressive loading and plastic deformation.

Producing excellent machinability in the 'as welded' condition, weld deposits of Stoody Buildup-O can be multi-layered and readily hot forged.

Typical applications of Stoody Buildup-O include the semi or fully automatic build-up of steel rolls, wheels, sprockets, shafts and track links.

### Packaging and Operating Data:

DC electrode positive.

Wire diameter mm	Current Range (amps)	Voltage Range (volts)	Electrode Stickout (ESO) mm	Pack Type	Pack Weight	Part No
2.4	200-350	24-28	20-30	Coil	27kg	11183600
2.8#	300-450	26-30	20-35	Coil	27kg	11000100
2.8#	300-450	26-30	20-35	Half Pack	90kg	11813100
2.8#	300-450	26-30	20-35	Drum	226kg	11869900

#Indent items

### TYPICAL ALL WELD DEPOSIT ANALYSIS:

C: 0.10% Mn: 2.00% Si: 0.50%

Cr: 1.00% Mo: 0.25% Fe: bal

### TYPICAL WELD DEPOSIT HARDNESS:

	HRC	HV30
Single Layer on Mild Steel	28	290

### FINISHING RECOMMENDATIONS:

Machinable.

### RECOMMENDED SHIELDING GASES:

- Open arc or welding grade CO<sub>2</sub> ISO14175: C1

### COMPARABLE CIGWELD PRODUCTS:

Cobalarc 350 extruded electrode

AS/NZS 2576:1435-A4

Stoody Super Build Up-G/O

AS/NZS 2576:1435-B5/B7

## STOODY SUPER BUILDUP-G/O

HV<sub>30</sub>  
400DC  
+

(Replaces Cobalarc 350-G/O)

- ▲ Gas (-G) and Self Shielded (-O), Tubular Hardfacing Wires.
- ▲ Tough, Machinable Low Carbon Martensitic Steel Deposit.
- ▲ Recommended for the build-up and surfacing of steel track rolls, idler wheels, track pads, drive sprockets, pins, links and other components subject to abrasion and/or metal-to-metal wear.
- ▲ 1.2mm and 1.6mm sizes can be used for vertical surfacing by depositing overlapping horizontal stringer passes.
- ▲ 1.2mm and 1.6mm wires are B5 type wires which require a shielding gas.

## Classifications:

1.2mm &amp; 1.6mm

AS/NZS 2576:

1435-B5

W.T.I.A. Tech Note 4:

1435-B5

## TYPICAL ALL WELD METAL DEPOSIT ANALYSIS:

C: 0.20%	Mn: 1.5%	Si: 0.4%
Cr: 2.0%	Mo: 0.5%	Fe: balance

## TYPICAL WELD DEPOSIT HARDNESS:

	HRC	HV <sub>30</sub>
Single Layer on Mild Steel	30	300
All Weld Metal Deposit	40	390

## FINISHING RECOMMENDATIONS:

Machinable. Carbide tools recommended.

## RECOMMENDED SHIELDING GASES:

1.2mm &amp; 1.6mm Super Buildup-G

- Ar + 1-3% O<sub>2</sub> ISO14175: M13
- Ar + 10-25% CO<sub>2</sub> or equivalent ISO14175: M21

## COMPARABLE CIGWELD PRODUCTS:

Cobalarc 350 extruded electrode

AS/NZS 2576: 1435-A4

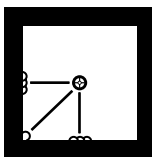

Downhand & Horizontal build-up applications:-  
1.2mm and 1.6mm sizes can be used for vertical surfacing by depositing overlapping horizontal stringer passes.

## Description and Applications:

Stoody Super Buildup-G/O is a tubular hard surfacing wire designed for the re-building or surfacing of steel components subjected to metal-to-metal wear and compressive loading.

1.2mm Stoody Super Buildup-G/O is ideal for all positional surfacing applications with Transmig 250 and 275 power plants.

Depositing a tough, air hardening low carbon martensitic steel weld deposit, Stoody Super Buildup-G/O is recommended for the semi-automatic build-up and surfacing of steel track rolls, idler wheels, track pads, drive sprockets, pins, links and other components subjected to abrasion and/or metal-to-metal wear.

## Packaging and Operating Data:

DC Electrode Positive.

Wire Dia. mm	Current Range (amps)	Voltage Range (volts)	Recommended Stickout (ESO) mm	Pack Type	Pack Weight	Part No
1.2	120-220	18-24	15-20	Spool	15kg	11423600
1.6	140-250	23-26	15-25	Spool	15kg	11946200



(Replaces Cobalarc 650-G/O)

- ▲ Gas (-G) and Self Shielded (-O), Tubular Hardfacing Wires.
- ▲ Air Hardening, Crack Free, Martensitic Steel Deposit.
- ▲ Resistant to Hard Particle Abrasion and Moderate Impact Loading.
- ▲ Typical applications include the surfacing of agricultural points, shares and tynes, sand dredge cutter heads, dredge rollers and tumblers, conveyor screws, bucket lips, etc.
- ▲ 1.2mm and 1.6mm sizes can be used for vertical surfacing by depositing overlapping horizontal stringer passes.
- ▲ 1.2mm and 1.6mm wires are B5 type wires which require a shielding gas. 2.4mm size is a B7 type open arc wire which requires no shielding gas.

#### Classifications:

	1.2mm & 1.6mm	2.4mm*
AS/NZS 2576:	1855-B5	1855-B7.
W.T.I.A. Tech Note 4:	1855-B5	1855-B7.

\* - 1.2mm and 1.6mm Stooddy 965-G wires are B5 type wires which require a shielding gas. 2.4mm Stooddy 965-O is a B7 type open arc wire which requires no shielding gas.

#### Description and Applications:

Stooddy 965-G/O is a tubular hard surfacing wire for surfacing components subjected to wet or dry hard particle abrasion and low to moderate impact loading. The air hardening martensitic steel weld deposit of Stooddy 965-G/O remains crack free on most steels under normal welding conditions and is therefore recommended for the surfacing of components subject to flexing during service. 1.2mm Stooddy 965-G/O is ideal for all positional surfacing applications with the Transmig 210, 275 and 350 power sources.

Typical applications include the surfacing of agricultural points, shares and tynes, sand dredge cutter heads, dredge rollers and tumblers, conveyor screws, bucket lips, etc.

#### Packaging and Operating Data:

DC Electrode Positive.

Wire Dia mm	Current Range (amps)	Voltage Range (volts)	Recommended Stickout (ESO) mm	Pack Type	Pack Weight	Part No
1.2	120-220	18-24	15-20	Spool	15kg	11423100
1.6	140-250	23-26	20-25	Spool	15kg	11501500
1.6	140-250	23-26	20-25	Handispool	4.5kg	11945700
2.4	200-350	24-28	20-30	Coil	27kg	11946100

#### TYPICAL ALL WELD METAL DEPOSIT ANALYSIS:

C: 0.60%	Mn: 1.70%	Si: 1.40%
Cr: 6.20%	Fe: balance	

#### TYPICAL WELD DEPOSIT HARDNESS:

	HRC	HV <sub>30</sub>
Single Layer on Mild Steel	55	600
All Weld Metal Deposit	60	700

#### FINISHING RECOMMENDATIONS:

Not Machinable. Grinding only.

#### RECOMMENDED SHIELDING GASES:

1.2mm & 1.6mm 965-G	
• Ar + 1-3% O <sub>2</sub> or equivalent	ISO14175: M13
2.4mm 965-O	
• Open arc or welding grade CO <sub>2</sub>	ISO14175: C1

#### COMPARABLE CIGWELD PRODUCTS:

Cobalarc 650 extruded electrode  
AS/NZS 2576: 1855-A4

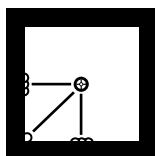

Downhand & Horizontal build-up applications:-  
1.2mm and 1.6mm sizes can be used for vertical surfacing by depositing overlapping horizontal stringer passes.



## STOODY 850-0



- ▲ Self Shielded (-O), Tubular Hardfacing Wire.
- ▲ Air Hardening, Crack Prone High Carbon, Martensitic Steel Deposit.
- ▲ Resistant to Severe Abrasion and Low Impact Loading.
- ▲ Typical applications include the hard surfacing of agricultural, mining and materials handling equipment including tynes, points, conveyor screws, dredge buckets, cane harvester cutters/elevators and sugar mill scraper plates.
- ▲ 1.2mm size can be used for vertical surfacing by depositing overlapping horizontal stringer passes.

## Classifications:

AS/NZS 2576:	1865-B7.
W.T.I.A. Tech Note 4:	1865-B7.

## TYPICAL ALL WELD METAL DEPOSIT ANALYSIS:

C: 0.95%	Mn: 0.6%	Si: 0.9%
Cr: 6.5%	Mo: 3.5%	B: 1.5%

## TYPICAL WELD DEPOSIT HARDNESS:

	HR <sub>C</sub>	HV <sub>30</sub>
Single Layer on Mild Steel	62	750
All Weld Metal Deposit	65	830

## FINISHING RECOMMENDATIONS:

Grinding only.

## RECOMMENDED SHIELDING GAS:

- Open arc or welding grade CO<sub>2</sub>
- ISO14175: C1

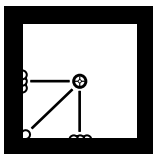

Downhand & Horizontal surfacing applications:-

1.2mm size can be used for vertical surfacing by depositing overlapping horizontal stringer passes.

## Description and Applications:

Stoody 850-0 is a self shielded (or open arc) hard surfacing wire which deposits a high carbon martensitic steel for excellent resistance to severe, fine (wet or dry) abrasion and low impact loading.

Weld deposits are air hardening and prone to fine relief checking. Stoody 850-0 should not be used in applications involving heavy impact or shock loading.

1.2mm Stoody 850-0 is ideal for all positional surfacing applications with the Transmig 250 and 275 power plant.

Typical applications include the hard surfacing of agricultural, mining and materials handling equipment including tynes, points, conveyor screws, dredge buckets, cane harvester cutters / elevators and sugar mill scraper plates.

## Packaging and Operating Data:

DC Electrode Positive

Wire Dia mm	Current Range (amps)	Voltage Range (volts)	Recommended Stickout (ESO) mm	Pack Type	Pack Weight	Part No
1.2	120-220	18-24	15-20	Spool	15kg	11945500



(Replaces Cobalarc Coarseclad-G/O 1.2 & 1.6mm)

- ▲ High Alloy, Tubular Hardfacing Wire.
- ▲ High Chromium - Carbide Iron Deposit. For Ground Engaging Applications.
- ▲ Resistant to Severe Abrasion and Low to Moderate Impact Loading.
- ▲ Typical applications include the hard surfacing of crusher cones and mantles, swing hammers, earthmoving buckets, scarifier points and sugar harvesting and milling equipment.
- ▲ 1.2mm size is suitable for vertical-up surfacing using a wide weaving technique.

### Classifications:

	1.2mm*	1.6mm*
AS/NZS 2576:	2360-B5	2360-B7.
W.T.I.A. Tech Note 4:	2360-B5	2360-B7.

\* 1.2mm 101 HC-G is a B5 type wire which requires a shielding gas.  
1.6mm 101 HC-O is a B7 type wire which requires no shielding gas.

### Description and Applications:

Stoody 101 HC-G/O is a high alloy tubular hardfacing wire depositing a high chromium carbide iron particularly resistant to severe coarse (large particle) abrasion. The weld deposit of Stoody 101 HC-G/O produces a high level of primary chromium carbides resistant to coarse abrasion (in particular gouging abrasion) at temperatures up to 650°C.

Weld deposits can be finished by grinding and relief checking is normal. Typical applications of Stoody 101 HC-G/O include the hard surfacing of crusher cones and mantles, swing hammers, earthmoving buckets, scarifier points and sugar harvesting and milling equipment. For high impact applications Stoody 101 HC-G/O deposits should be restricted to one layer.

### Weld Deposit Microstructure:

Two layers of Stoody 101 HC-G/O onto a mild steel component will produce approximately 25 - 30% primary chromium iron carbides in a carbide-ferrite matrix ideal for severe abrasion and low to moderate impact applications.

### Packaging and Operating Data:

DC Electrode Positive.

Wire Dia mm	Current Range (amps)	Voltage Range (volts)	Recommended Stickout (ESO) mm	Pack Type	Pack Weight	Part No
1.2	150-200	22-26	12-20	Spool	15kg	11436300
1.6	200-260	24-28	15-25	Spool	15kg	11304700
				Handispool	4.5kg	11945600

### TYPICAL WELD DEPOSIT ANALYSIS:

Single Layer on Mild Steel:			
C: 4.0%	Mn: 0.7%	Si: 0.7%	Cr: 14.0%
All Weld Metal Deposit:			
C: 5.2%	Mn: 0.7%	Si: 0.7%	Cr: 19.0%

### TYPICAL WELD DEPOSIT HARDNESS:

	HRC	HV30
Single Layer on Mild Steel	55	600
All Weld Metal Deposit	60	700

Deposits contain Chromium Carbides with hardness up to 1,500 HV (80 HRC).

### FINISHING RECOMMENDATIONS:

Grinding only.

### RECOMMENDED SHIELDING GAS:

1.2mm 101 HC-G	
• Ar+ 1-3% O <sub>2</sub> or equivalent	ISO14175: M13
1.6mm 101 HC-O	
• Open arc or welding grade CO <sub>2</sub>	ISO14175: C1

### COMPARABLE CIGWELD PRODUCTS:

Cobalarc CR70 extruded electrode  
AS/NZS 2576: 2355-A4

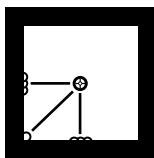

Downhand & Horizontal surfacing applications:-  
1.2mm size is suitable for vertical-up surfacing using a wide weaving technique.

## STOODY 100 HC-O



(Replaces Cobalarc Coarseclad-O 2.4 & 2.8mm)

- ▲ Self Shielded (-O), Tubular Hardfacing Wire.
- ▲ High Chromium Carbide Iron Deposit.
- ▲ For Ground Engaging Applications.
- ▲ Resistant to Coarse Abrasion and Low to Moderate Impact Loading.
- ▲ Primary Chromium Iron Carbides in Single Layer.

**Classifications:**

AS/NZS 2576: 2360-B7.  
W.T.I.A. Tech Note 4: 2360-B7.

**Description and Applications:**

Stoody 100 HC-O is a high alloy tubular hardfacing wire depositing a high chromium carbide iron particularly resistant to coarse (large particle) abrasion. The weld deposit of Stoody 100 HC-O produces a high level of primary chromium carbides resistant to coarse abrasion (in particular gouging abrasion) at temperatures up to 650°C.

Weld deposits can be finished by grinding and relief checking is normal. Typical applications of Stoody 100 HC-O include the hard surfacing of crusher cones and mantles, swing hammers, earthmoving buckets, blades and rippers. Also suitable for single layer wear plate manufacture.

For higher impact applications Stoody 100 HC-O deposits should be restricted to two layers.

**Weld Deposit Microstructure:**

Two layers of Stoody 100 HC-O onto a mild steel component will produce approximately 30% - 35% primary chromium iron carbides in a carbide-ferrite matrix ideal for coarse abrasion and low to moderate impact applications.

**Packaging and Operating Data:**

DC Electrode Positive.

Wire Diameter mm	Current Range (amps)	Voltage Range (volts)	Recommended Stickout (ESO) mm	Pack Type	Pack Weight	Part No
2.4	250-350	25-30	35-55	Coil	27kg	11313400
2.8	300-450	27-33	35-55	Coil	27kg	11001000
2.8	300-450	27-33	35-55	Drum	226kg	11235400

**TYPICAL WELD DEPOSIT ANALYSIS:**

Single Layer on Mild Steel:

C: 4.0% Mn: 1.0% Si: 1.0% Cr: 20% Mo: 0.7%  
All Weld Metal Deposit:

C: 4.5% Mn: 1.5% Si: 1.5% Cr: 25% Mo: 1%

**TYPICAL WELD DEPOSIT HARDNESS:**

	HR <sub>C</sub>	HV <sub>30</sub>
Single Layer on Mild Steel	55	600
All Weld Metal Deposit	63	780

Deposits contain Chromium Carbides with hardness up to 1,500 HV (80 HRC).

**FINISHING RECOMMENDATIONS:**

Grinding only.

**RECOMMENDED SHIELDING GAS:**

- Open arc or welding grade CO<sub>2</sub>
- ISO14175: C1

**COMPARABLE CIGWELD PRODUCTS:**

Cobalarc CR70 extruded electrode  
AS/NZS 2576: 2355-A4

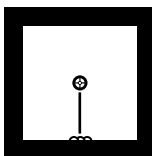

Downhand surfacing  
applications



(Replaces Cobalarc Fineclad-O)

- ▲ Self Shielded (-O), Tubular Hardfacing Wire.
- ▲ Chromium Iron Carbides in a Hard, Martensitic Matrix.
- ▲ Resistant to Fine, Wet or Dry Abrasion
- ▲ High Deposit Hardness - typically 65 HRC.
- ▲ Now available in 1.6mm size on 15kg spools.

### Classifications:

AS/NZS 2576: 2565-B7.  
W.T.I.A. Tech Note 4: 2565-B7.

### Description and Applications:

Stoody FINECLAD-O is a second generation Cobalarc tubular wire depositing a hard martensitic chromium carbide iron resistant to severe fine abrasion. The addition of nominally 0.8% Boron to Stoody FINECLAD-O produces an ultra fine, martensitic matrix in the weld deposit particularly resistant to wet or dry abrasive or erosive media.

Stoody FINECLAD-O also gives satisfactory performance under medium to coarse abrasion however this is limited to conditions of low impact loading. Weld deposits can be finished by grinding and relief checking is normal.

Typical applications of Stoody FINECLAD-O include the surfacing of sand chutes, dredge components, ripper shanks, screens, grizzly bars, scraper blades, and bucket teeth and lips etc.

### Weld Deposit Microstructure:

The addition of nominally 0.8% Boron to Stoody FINECLAD-O facilitates the formation of martensite in the eutectic. It also results in an ultra fine eutectic structure which in combination with the martensite fraction is responsible for Stoody FINECLAD-O's excellent resistance to fine wet/dry abrasion and erosion.

### Packaging and Operating Data:

DC Electrode Positive.

Wire Diameter mm	Current Range (amps)	Voltage Range (volts)	Electrode Stickout mm	Pack Type	Pack Weight	Part No
1.6	200-260	24-28	15-25	Spool	15kg	11945800
2.4	250-350	25-30	35-55	Coil	27kg	11945900

### TYPICAL WELD DEPOSIT ANALYSIS:

Single Layer on Mild Steel:

C: 3.5% Mn: 0.3% Si: 0.4%  
Cr: 14% B: 0.5%

All Weld Metal Deposit:

C: 4.8% Mn: 0.5% Si: 0.6%  
Cr: 20% B: 0.75%

### TYPICAL WELD DEPOSIT HARDNESS:

	HRC	HV <sub>30</sub>
Single Layer on Mild Steel	62	750
All Weld Metal Deposit	65	830

Deposits contain Chromium Carbides with hardness up to 1,500 HV (80 HRC).

### FINISHING RECOMMENDATIONS:

Grinding only.

### RECOMMENDED SHIELDING GAS:

- Open arc or welding grade CO<sub>2</sub>
- ISO14175: C1

### COMPARABLE CIGWELD PRODUCTS:

Cobalarc BoroChrome extruded electrode  
AS/NZS 2576: 2560-A4

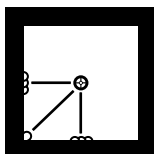

Downhand & Horizontal surfacing applications:-  
1.6mm size can be used for vertical surfacing by depositing overlapping horizontal stringer passes.

## STOODY 110 MC



(Replaces Cobalarc Crome Mang-O)

- ▲ Self shielded (-0) tubular hardfacing wire.
- ▲ Tough, work hardening high manganese/ high chromium stainless steel deposits.
- ▲ Repair, joining and surfacing of manganese steel components.
- ▲ Suitable for heavy build-up applications.

**Classifications:**

AS/NZS 2576: 1715-B7.

W.T.I.A. Tech Note 4: 1715-B7.

**Description and Applications:**

Stoody 110 MC is an open arc tubular wire depositing a high manganese and high chromium stainless steel weld metal for the repair, joining or surfacing of manganese steel components extensively used in the quarrying and mining industry.

Resultant weld deposits have high strength and toughness, good resistance to cavitation and corrosion and are extremely resistant to impact loading. Stoody 110 MC can be multi-layered to any thickness without relief checking and deposits will work harden during service under high impact loading.

Typical applications include the repair of manganese steel crusher rolls, jaw and hammer crushers, gyratory mantles, manganese frogs, drive tumblers and dredge pump cutters etc.

**Packaging and Operating Data:**

DC Electrode Positive

Electrode Size	Current Range (amps)	Voltage Range (volts)	Electrode Stickout mm	Pack Type	Pack Weight	Part No
1.6mm	150-210	22-28	15-25mm	Spool	15kg	11424400
2.8mm	200-375	25-28	20-35mm	Coil	27kg	11836900

**TYPICAL ALL WELD DEPOSIT ANALYSIS:**

C: 0.30%	Mn: 14.7%	Si: 0.37%
Cr: 16.8%	Ni: 0.65%	Fe: Balance

**TYPICAL WELD DEPOSIT PROPERTIES:**

Yield Strength	520 MPa
Tensile Strength	820 MPa
Elongation	40%

**TYPICAL WELD DEPOSIT HARDNESS:**

	HR <sub>C</sub>	HV <sub>30</sub>
All Weld Metal Deposit	17	220
Work Hardened	55	600

**FINISHING RECOMMENDATIONS:**

Machinable-as deposited

**RECOMMENDED SHIELDING GASES:**

- Open Arc or Welding Grade CO<sub>2</sub> ISO14175: C1

**COMPARABLE CIGWELD PRODUCTS:**

Cobalarc Mangcraft Extruded Electrode

AS/NZS 2576:1215-A4

Stoody Dynamang-O Open Arc Wire

AS/NZS 2576:1215-B7



(Replaces Cobalarc 104-SA)

- ▲ Submerged arc (-SA) tubular build-up wire.
- ▲ Tough, machinable, low carbon pearlitic steel deposit.
- ▲ Resistant to high compressive loading.
- ▲ For the unlimited build-up of worn steel components.

### Classifications:

AS/NZS 2576: 1125-B1.  
W.T.I.A.Tech Note 4: 1125-B1.

### Description and Applications:

Stoody 104 is a low alloy steel submerged arc tubular wire developed for the rebuilding of steel components subjected to high compressive loading and plastic deformation. Producing weld metal with excellent machinability in the 'as welded' condition, when used with Stoody S flux, Stoody 104 can be multi-layered and readily hot forged. Typical applications of Stoody 104/Stoody S flux include the submerged arc build-up of steel rolls, wheels, sprockets, shafts and track links etc.

### TYPICAL ALL WELD DEPOSIT ANALYSIS:

C: 0.07%	Mn: 2.90%	Si: 1.25%
Cr: 1.15%	Fe: bal	

### TYPICAL WELD DEPOSIT HARDNESS:

All weld metal deposit	HRC 29	HV <sub>30</sub> 290
------------------------	-----------	-------------------------

### FINISHING RECOMMENDATIONS:

Machinable.

### RECOMMENDED FLUX:

Stoody S

### DEPOSIT CHARACTERISTICS:

Abrasion resistance	Low
Impact resistance	Excellent
Compressive strength	Excellent
Hardness	29 HRC
Surface cross checks	No
Magnetic	Yes
Deposit Layers	Unlimited
Machinability	Yes

### COMPARABLE CIGWELD PRODUCTS:

Stoody Build Up-O self shielded tubular wire  
AS/NZS 2576:1125-B7

### Packaging and Operating Data:

AC, DC electrode positive or negative

Wire diameter mm	Current Range (amps)	Voltage Range (volts)	Electrode Stickout (ESO) mm	Pack Type	Pack Weight	Part No
3.2	350-400	26-30	25-35	Coil	27kg	11820300
3.2	350-400	26-30	25-35	Half Pack	90kg	11040900
3.2	350-400	26-30	25-35	Drum	226kg	11039500

## STOODY 105

HV<sub>30</sub>  
450AC  
DC

(Replaces Cobalarc 105-SA)

- ▲ Submerged arc tubular build-up wire.
- ▲ Tough, machinable, crack-free steel deposit.
- ▲ Resistant to high compressive loading.
- ▲ Ideal as an underbase prior to hardfacing.
- ▲ For re-building worn steel components.

**Classifications:**

AS/NZS 2576: 1445-B1.  
W.T.I.A.Tech Note 4: 1445-B1.

**Description and Applications:**

Stoody 105 is a submerged arc wire with very good resistance to abrasion in metal-to-metal wear. Multiple layer crack-free steel deposits can be obtained. When more than 3 layers are required, an underbase of Stoody 105 is recommended. Tungsten carbide tools and rigid, well powered equipment are required for machining. Deposits are difficult to flame cut. Applications include the rebuilding of: rollers, idlers, mine car wheels, arch wheels and charging car wheels.

**TYPICAL ALL WELD DEPOSIT ANALYSIS:**

C: 0.2%	Mn: 2.0%	Si: 1.3%
Cr: 2.8%	Mo: 0.4%	V: 0.15%
		Fe: bal

**TYPICAL WELD DEPOSIT HARDNESS:**

	HRC	HV <sub>30</sub>
3 layers maximum on Mild Steel	45	440

**FINISHING RECOMMENDATIONS:**

Machinable with difficulty.

**RECOMMENDED FLUX:**

Stoody S

**DEPOSIT CHARACTERISTICS:**

Abrasion resistance	Very good
Impact resistance	Good
Compressive strength	Good
Hardness	45HRC
Surface cross checks	No
Magnetic	Yes
Deposit Layers	Three
Machinability	With difficulty

**COMPARABLE CIGWELD PRODUCTS:**

Cobalarc 350 extruded electrode  
AS/NZS 2576:1435-A4  
Stoody Super Build Up-G/O  
AS/NZS 2576:1435-B5/B7

**Packaging and Operating Data:**

AC, DC electrode positive or negative.

Wire diameter mm	Current Range (amps)	Voltage Range (volts)	Electrode Stickout (ESO) mm	Pack Type	Pack Weight	Part No
3.2	350-400	28-30	25-35	Half Pack	90kg	11041000
3.2	350-400	26-30	25-35	Drum	226kg	11039600



(Replaces Cobalarc 107-SA)

- ▲ Submerged arc tubular build-up wire.
- ▲ Tough, machinable, crack-free steel deposit.
- ▲ Resistant to high compressive loading.
- ▲ Ideal as an underbase prior to hardfacing.
- ▲ For re-building worn steel components.

### Classifications:

AS/NZS 2576: 1440-B1.  
W.T.I.A.Tech Note 4: 1440-B1.

### Description and Applications:

Stoody 107 is a submerged arc wire with good resistance to metal-to-metal wear, excellent impact resistance, good compressive strength and resistance to plastic defatation. Multiple layer crack-free deposits can be obtained up to 20mm thick. Deposits are readily machinable with carbide tools and can be flame cut. Stoody 107 can be used for both the build-up and hardfacing of rollers and idlers. Applications include the rebuilding of rollers, idlers, carbon steel crane wheels, mine car wheels and house rollers.

### TYPICAL ALL WELD DEPOSIT ANALYSIS:

C: 0.14% Mn: 1.9% Si: 0.8%  
Cr: 2.2% Mo: 0.3% Fe: bal

### TYPICAL WELD DEPOSIT HARDNESS:

	HRC	HV <sub>30</sub>
Multiple Layer on Mild Steel	38	380

### FINISHING RECOMMENDATIONS:

Machinable.

### RECOMMENDED FLUX:

Stoody S

### DEPOSIT CHARACTERISTICS:

Abrasion resistance	Good
Impact resistance	Excellent
Compressive strength	Good
Hardness	38 HRC
Surface cross checks	No
Magnetic	Yes
Deposit thickness	up to 20mm
Machinability	Yes

### COMPARABLE CIGWELD PRODUCTS:

Cobalarc 350 extruded electrode  
AS/NZS 2576:1435-A4  
Stoody Super Build Up-G/O  
AS/NZS 2576:1435-B5/B7

### Packaging and Operating Data:

AC, DC electrode positive or negative.

Wire diameter mm	Current Range (amps)	Voltage Range (volts)	Electrode Stickout (ESO) mm	Pack Type	Pack Weight	Part No
3.2	350-400	28-30	25-35	Half Pack	90kg	11041200
3.2	350-400	26-30	25-35	Drum	226kg	11039800



## STOODY 600



(Replaces Cobalarc Impactaclad-0)

- ▲ Self shielded (-O) tubular hardfacing wires.
- ▲ Crack free, martensitic alloy steel containing hard, titanium carbides.
- ▲ Excellent resistance to high stress abrasion and heavy impact.

**Classifications:**

AS/NZS 2576: 1955-B7  
W.T.I.A. Tech Note 4: 1955-B7

**Description and Applications:**

Stoody 600 is a new generation tubular wire which deposits a martensitic alloy steel containing a high volume fraction of fine, hard titanium carbides.

The unique microstructure of Stoody 600 makes it particularly suitable for high stress abrasion and heavy impact conditions. A minimum of two layers of Stoody 600 is recommended for optimum service performance. Weld deposits are normally free from relief checking and have good hardness retention to  $\approx 500^{\circ}\text{C}$

Typical applications of Stoody 600 include the surfacing of mill hammers, bucket teeth and lips, tampers, agitator screws and other components subjected to extreme abrasion and moderate to heavy impact.

**Finishing Recommendations:**

The all weld metal microstructure of Stoody 600 shows an even dispersion ( $\approx 10\%$  by volume) of fine, hard titanium carbides in a high chromium martensitic matrix resistant to high stress abrasion and heavy impact loading

**Packaging and Operating Data:**

DC Electrode Positive

Wire diameter mm	Current Range (amps)	Voltage Range (volts)	Electrode Stickout (ESO) mm	Pack Type	Pack Weight	Part No
1.6mm	200-300	22-26	20-25mm	Spool	15kg	11886600
2.4mm	300-400	25-27	35-35mm	Coil	27kg	11846000
*2.4mm	400-500	26-28	30-35mm	Drum	226kg	11929400
*2.8mm	400-500	26-28	30-35mm	Coil	27kg	11814400

\*Non stock item available on indent only.

**TYPICAL ALL WELD DEPOSIT ANALYSIS:**

C: 1.7% Mn: 1.6% Si: 0.5%  
Cr: 7.5% Mo: 1.3% Ti: 5.3%

**TYPICAL WELD DEPOSIT HARDNESS:**

	HR <sub>C</sub>	HV <sub>30</sub>
Single Layer or Mild Steel	58	670
Two layers of Mild Steel	60	690
3-8 layers of Mild Steel	60	690

Deposits contain Titanium Carbides with hardness up to 3,200HV

**FINISHING RECOMMENDATIONS:**

Grinding Only

**RECOMMENDED SHIELDING GASES:**

Open Arc Operation

(Replaces Cobalarc Abrasoclad-O)

- ▲ Self shielded (-O), tubular hardfacing wire.
- ▲ Complex niobium / chromium carbide iron deposit.
- ▲ Resistant to sever fine or coarse abrasion and low to moderate impact.
- ▲ Now available in 1.6mm size on 15kg spools.

### Classifications:

AS/NZS 2576:	2460-B7
W.T.I.A.Tech Note 4:	2460-B7

### Description and Applications:

Stoody 143-O is a high alloy tubular hardfacing wire depositing a complex chromium carbide iron resistant to extreme abrasion and low to moderate impact loading. The addition of nominally 7% niobium to Stoody 143-O produces a complex chromium / niobium carbide iron weld deposit which is particularly resistant to severe low and high stress abrasion and low to moderate impact loading at temperatures up to ≈ 650°C.

The nodular niobium rich carbide structure of Stoody 143-O is capable of withstanding higher impact loading than standard chromium carbide alloy types. The low dilution sensitivity means that two layers will normally be sufficient to achieve optimum wear resistance. Stoody 143-O deposits will readily stress relief check and can only be finished by grinding. Typical applications include the surfacing of conveyor screws, pug mill paddles, wear plates, fan blades, coke chutes / shoes and grizzly bars, etc.

### Weld Deposit Microstructure:

The addition of nominally 7% niobium to Stoody 143-O initiates the formation of a complex niobium / chromium carbide iron structure which resists extreme high or low stress abrasion even under conditions of moderate impact.

### Packaging and Operating Data:

#### DC Electrode Positive

Wire diameter mm	Current Range (amps)	Voltage Range (volts)	Electrode Stickout (ESO) mm	Pack Type	Pack Weight	Part No
1.6	200-300	22-26	20-25	Spool	15kg	11877000
2.8	300-450	27-33	35-55	Coil	27kg	11867800
*2.8	300-450	27-33	35-55	Drum	226kg	11857800

\*Non-stock item available on indent only.

#### TYPICAL ALL WELD DEPOSIT ANALYSIS:

Single Layer on Mild Steel		
C: 3.7%	Mn: 0.6%	Si: 0.3%
Cr: 16%	Nb: 5%	
All Weld Metal Deposit		
C: 5.2%	Mn: 0.7%	Si: 0.4%
Cr: 22%	Nb: 7.3%	

#### TYPICAL WELD DEPOSIT HARDNESS:

	HRC	HV30
Single Layer on Mild Steel	58	670
All Weld Metal Deposit	62	760
Deposits contain niobium carbides with hardness up to 2,400 HV.		

#### FINISHING RECOMMENDATIONS:

Grinding only.

#### RECOMMENDED SHIELDING GASES:

- Open arc or welding grade CO<sub>2</sub> ISO14175: C1

#### COMPARABLE CIGWELD PRODUCTS:

Cobalarc 9e extruded electrode  
AS/NZS 2576: 2460-A4

## STOODY 145 OPEN ARC WIRE



- ▲ Self shielded (-O), tubular hardfacing wire.
- ▲ Complex niobium / chromium carbide iron deposit.
- ▲ Highly abrasion resistant with excellent corrosion resistance.
- ▲ Produces hardness at elevated temperatures.

## Classifications:

AS/NZS 2576:	2460-B7
W.T.I.A.Tech Note 4:	2460-B7

## Description and Applications:

Stoody 145 is a highly alloyed open arc wire, with high abrasion resistance, high corrosion resistance, and high hardness at elevated temperature. The Stoody 145 alloyed wire contains columbium (niobium), which contributes to its excellent high temperature abrasion resistance up to 1500°F (816°C).

- Iron and Steel Industry: Guides, Sinter Plant Parts, Blast Furnace Parts, Slag Rakes, Hot Ash Elbows, Exhaust Fan Blades, Crushers, Coke Pusher Shoes, Hot Screens, Tilt fingers, Hot Billet Handlers.
- Cement and Refractory: Cement Screws, Cement Dryers, Hot Cement Cones, Cement Furnace Parts, Mixer Blades, Presses.
- Non-Ferrous Metals: Copper Ladles, Slag Ladles, Zinc Pots, Tin Mill Parts, Copper Bar Guides, Zinc Scrapers.
- Mining: wear Plates, Excavator Bucket Teeth, Conveyor Screws, Slurry Pipes.

## Packaging and Operating Data:

Wire diameter mm	Current Range (amps)	Voltage Range (volts)	Wire Extension mm	Pack Type	Pack Weight	Part No
2.8	300-550	28-34	19-32	Coil	27kg	11414300
*2.8	300-550	28-34	19-32	Drum	90kg H/P	11484700
*2.8	300-550	28-34	19-32	Drum	226kg POP	11440200

\*Non-stock item available on indent only.

## TYPICAL DEPOSIT CHEMISTRY (WT%):

C: 5.8%	Cr: 24%	Mo: 6.3%	Mn: 1.0%	Nb: 5.1%
W: 1.8%	V: 0.8%	Si: 0.7%	Fe: Bal	

## FINISHING RECOMMENDATIONS:

Grinding Only

## DEPOSIT CHARACTERISTICS:

Abrasion resistance	Excellent
Impact resistance	Low
Hardness 2 Layers	56-61HRC
Surface cross checks	Yes
Machinability	Grind Only
Magnetic	Yes
Deposit thickness	2 Maximum
Hot Wear Applications	Up to 1500°F (816°C)

## COMPARABLE CIGWELD PRODUCTS:

- ▲ Self shielded (-O) tubular hardfacing wire.
- ▲ Seamless copper coated sheath for outstanding arc starting and wire feeding.
- ▲ Developed for the out-of-position 'open arc' hard surfacing of sugar mill rolls.
- ▲ Martensitic steel surfacing deposit for enhanced roll roughness and wear resistance.

### Classifications:

AS/NZS 2576: 1845-B7  
W.T.I.A.Tech Note 4: 1845-B7

### Description and Applications:

Stoody RA45-O is a seamless copper coated hard surfacing wire developed primarily for the semi or fully automatic 'open arc' surfacing of cast iron sugar mill rolls. Stoody RA45-O can also be used with shielding gas (carbon dioxide or Argon/carbon dioxide mixtures) or without shielding gas for the general purpose hard surfacing of ground engaging tools such as agricultural points, shares and tynes, conveyor screws and post hole augers.

For both the 'in-situ' maintenance and pre-season conditioning of cast iron sugar mill rolls, Stoody RA45-O deposits a superior wear resistant martensitic steel overlay resulting in improved roll efficiency and service life.

When roller arcing 'in-situ' with long gun cables, awkward torch angles, high welding currents and a wet bagasse blanket, the copper coated seamless sheath of Stoody RA45-O offers outstanding arc starting and deposit penetration in addition to uninterrupted wire feeding.

### Packaging and Operating Data:

Wire diameter mm	Current Range (amps)	Voltage Range (volts)	Wire Extension mm	Pack Type	Pack Weight	Part No
2.0	240-300	28-35	40-50	Coil	25kg	11121100
2.8	300-350	30-35	40-50	Coil	25kg	11122200

### TYPICAL WELD DEPOSIT HARDNESS:

	HRc	HV30
Single layer on cast iron	40	400
All weld metal deposit	45	440

### FINISHING RECOMMENDATIONS:

Grinding Only

### RECOMMENDED SHIELDING GAS:

Open arc  
Welding grade CO<sub>2</sub> or Argon + CO<sub>2</sub> gas mixtures

### COMPARABLE CIGWELD PRODUCTS:

Stoody 117 Hardfacing wire

### WELDING POSITIONS:

For roller arcing applications, Stoody RA45-O can be used in the flat, horizontal, vertical up and vertical down welding positions.

For conventional hardfacing applications Stoody RA45-O is restricted to use in the flat and horizontal welding positions.

## STOODY "S" FLUX

### Description and Applications:

Stoody "S" Flux is an active fused flux designed for use with Stoody Submerged Arc Welding Wires (other than the ThernaClad® wire). As the deposit composition is significantly altered from the wire composition, care should be exercised in the matching of this flux to the right wire.

### Packaging and Operating Data:

Stoody "S" Flux is available in 22kg Bags (Part Number: 11008400)





Description	Page No
Autocraft LW1	105
Autocraft Super Steel	106
Autocraft LW1-6	107
Autocraft Mn-Mo	110
Autocraft NiCrMo	111
Autocraft CrMo1	112
Autocraft 307Si	113
Autocraft 308LSi	114
Autocraft 309LSi	115
Autocraft 316LSi	116
Autocraft 2209	117
Autocraft AL1100 (Pure)	118
Autocraft AL4043 (5% Silicon)	119
Autocraft AL5356 (5% Magnesium)	120
Autocraft AL5183	122
Autocraft Deoxidised Copper	123
Autocraft Silicon Bronze	124



## CONTACT TIP TO WORK DISTANCE (CTWD) EXPLAINED

**Contact Tip to Work Distance (CTWD)**, also sometimes referred to as electrode stick out (ESO), is defined as the distance between the end of the contact tip and the workpiece. A schematic diagram of CTWD is shown below. CTWD includes the wire length from the contact tip, to the point where it enters the welding arc, and the arc length.

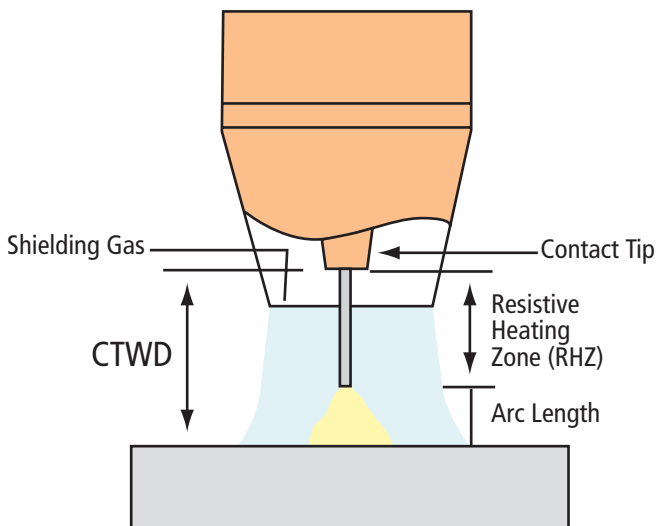

## AUTOCRAFT LW1



- ▲ For GMAW Welding of Mild & Low Alloy Steels.
- ▲ Increased Resistance to Copper Flaking at High Current Settings.
- ▲ Designed Primarily for Use with Argon Based Shielding Gases.
- ▲ Suitable for use with Short-arc, Spray & Pulsed arc Transfer Modes.

## Classifications:

AS/NZS 2717.1: ES4-GC/M-W503AH.  
AWS/ASME-SFA A5.18: ER70S-4.

## Description and Applications:

Autocraft LW1 is a high quality copper coated welding wire manufactured using the latest wire drawing technology. This state-of-the-art technology ensures; the highest quality copper coating - for improved wire feeding, electrical conductivity and lower contact tip wear. Improved copper coating gives increased resistance to copper flaking especially under high current welding conditions. Autocraft LW1 is suitable for the all positional multi-pass Gas Metal Arc welding of mild, low alloy and medium strength steels, as used in general fabrication, pressure vessels and structural work. Autocraft LW1 exhibits excellent operator appeal and very low spatter levels important for welding light to medium gauge sheet, pipe and tubular steel sections. Fillet welds exhibit a mitre to slightly concave profile with an even and smooth contour.

## Storage Recommendations:

When held under the recommended storage conditions unopened packs of Autocraft LW1 are expected to remain in 'factory fresh' condition for at least 12 months.

For storage over 12 months or under adverse (damp or high humidity) climatic conditions the use of heated weather proof store rooms/cupboards/containers maintained at 10-15°C above ambient temperature (with a maximum of 40°C) and at a maximum humidity of 60% R.H. is recommended. Product should be stacked on racks or pallets clear of the floor and walls.

## Packaging and Operating Data:

Wire Diameter mm	Voltage Range (volts)	Wire Feed Speed (metres/min)	Current Range (amps)	Pack Type*	Pack Weight	Part No
0.9	15-26	3.5-15	70-230	Spool	15kg	720115
1.2	18-32	2.5-15	120-350	Spool	15kg	720116

\* Spool (ø300mm);

## APPROVALS:

Lloyd's Register of Shipping	Grade 35
American Bureau of Shipping	Grade 35A
Det Norske Veritas	Grade IIIYMS

## TYPICAL WIRE ANALYSIS:

C: 0.08%	Mn: 1.16%	Si: 0.70%
S: 0.010%	P: 0.015%	

## TYPICAL DIFFUSIBLE HYDROGEN LEVELS TO AS3752:

1.0 - 2.0 mls of hydrogen / 100gms of deposited weld metal.

## TYPICAL ALL WELD METAL MECHANICAL PROPERTIES:

	Argon + 10-15%CO <sub>2</sub> :	Welding Grade CO <sub>2</sub> :
Yield Stress	450 MPa	410 MPa
Tensile Strength	550 MPa	525 MPa
Elongation	29%	32%
CVN Impact Val.	120 J @ -20°C	110 J @ -20°C

## RECOMMENDED SHIELDING GAS:

Ar + 10-15% CO <sub>2</sub> or equivalent	ISO14175: M 21, M24 M14 ISO14175: M21, M24
Ar + 15-25% CO <sub>2</sub> or equivalent	ISO14175: M21, M24
Ar + 5% CO <sub>2</sub> + 3% O <sub>2</sub>	ISO14175: M23
Welding Grade CO <sub>2</sub>	ISO14175: C1

## COMPARABLE CIGWELD PRODUCTS:

Comweld LW1 TIG rod:  
AWS/ASME-SFA A5.18: ER70S-4

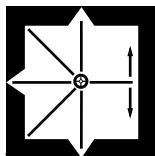

All positional welding applications

## AUTOCRAFT SUPER STEEL



- ▲ A Low Carbon, Triple Deoxidised Steel Wire for GMAW Welding Applications.
- ▲ For use with Welding Grade CO<sub>2</sub> or Argon Based Shielding Gases.
- ▲ Triple Deoxidised for Superior Weld Deposit Quality and Resistance to Porosity.
- ▲ Suitable for Use with Short-arc, Spray & Pulsed Arc Transfer Modes.

## Classifications:

AS/NZS 2717.1:	ES2-GC/M-W503AH.
AWS/ASME-SFA A5.18:	ER70S-2.

## Description and Applications:

Autocraft Super Steel is a copper coated 'triple deoxidised' steel welding wire recommended for the high quality Gas Metal Arc (MIG) welding of mild and medium strength steels.

Autocraft Super Steel is deoxidised with Titanium, Aluminium and Zirconium in addition to Manganese and Silicon for improved weld deposit quality. It is the ideal choice for the Gas Metal Arc (MIG) welding of rusty or mill scaled plates and pipes and the root pass welding of pipes, tanks, and heavy walled joints where good weld toughness and radiographic soundness are achieved under high dilution.

## Storage Recommendations:

When held under the recommended storage conditions unopened packs of Autocraft Super Steel are expected to remain in 'factory fresh' condition for at least 12 months.

For storage over 12 months or under adverse (damp or high humidity) climatic conditions the use of heated weather proof store rooms /cupboards /containers maintained at 10-15°C above ambient temperature (with a maximum of 40°C) and at a maximum humidity of 60% R.H. is recommended. Product should be stacked on racks or pallets clear of the floor and walls.

## Packaging and Operating Data:

Wire Diameter mm	Voltage Range (volts)	Wire Feed Speed (metres/min)	Current Range (amps)	Pack Type*	Pack Weight	Part No
1.2	18-32	3.5-15	120-350	Spool	15kg	720054

\* Spool (ø300mm).

## TYPICAL WIRE ANALYSIS:

C: 0.05%	Mn: 1.10%	Si: 0.55%
Ti: 0.10%	Zr: 0.06%	Al: 0.08%
S: 0.007%	P: 0.008%	Fe: Balance

## TYPICAL DIFFUSIBLE HYDROGEN LEVELS TO AS3752:

1.0 - 2.0 mls of hydrogen / 100gms of deposited weld metal.

## TYPICAL ALL WELD METAL MECHANICAL PROPERTIES:

Using	Ar + 20-25% CO <sub>2</sub> :
Yield Stress	425 MPa
Tensile Strength	520 MPa
Elongation	34%
CVN Impact Values	75 J av @ -20°C

## RECOMMENDED SHIELDING GAS:

- Ar + 15-25% CO<sub>2</sub> or equivalent ISO14175: M21, M24
- Ar + 1-3% O<sub>2</sub> or equivalent ISO14175: M13
- Welding Grade CO<sub>2</sub> ISO14175: C1

## COMPARABLE CIGWELD PRODUCTS:

Comweld Super Steel TIG rod  
AWS A5.18 ER70S-2

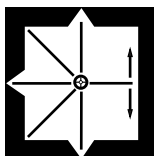

All positional welding applications



- ▲ A Higher Manganese / Silicon Wire for GMAW Welding of Mild & Low Alloy Steels.
- ▲ Designed for Use with CO<sub>2</sub> and Argon Based Shielding Gases.
- ▲ Wide Range of Minispool, Handispool and Autopak Packaging Options.

## Classifications:

AS/NZS 2717.1: E56-GC/M-W503AH.  
 AWS/ASME-SFA A5.18: ER70S-6.

## Description and Applications:

Autocraft LW1-6 is a high quality copper coated welding wire suitable for the all positional Gas Metal Arc Welding (GMAW) of mild and low alloy steels, used in general fabrication and structural work. The high quality copper coating ensures problem free feeding, smooth current pick-up and minimal contact tip wear. The higher silicon content of Autocraft LW1-6 ensures excellent operator appeal, improved fillet shape / side wall wash at weld toes and very low spatter levels important for welding light to medium gauge sheet and tubular steel sections. Fillet welds exhibit a mitre to slightly convex profile with an even and smooth contour. The higher Manganese / Silicon levels give improved weld metal deoxidation when welding steels with moderate amounts of rust or mill scale.

### Storage Recommendations:

When held under the recommended storage conditions unopened packs of Autocraft LW1-6 wires are expected to remain in 'factory fresh' condition for at least 12 months.

For storage over 12 months or under adverse (damp or high humidity) climatic conditions the use of heated weather proof store rooms/cupboards/containers maintained at 10-15°C above ambient temperature (with a maximum of 40°C) and at a maximum humidity of 60% R.H. is recommended. Product should be stacked on racks or pallets clear of the floor and walls.

### APPROVALS\*:

Lloyd's Register of Shipping	Grade 3S, 3YS
American Bureau of Shipping	Grade 3SA, 3YSA
Det Norske Veritas	Grade 111YMS

\* Approvals do not include 0.6mm Autocraft LW1-6

### TYPICAL WIRE ANALYSIS:

C: 0.07%	Mn: 1.55%	Si: 0.88%
S: 0.012%	P: 0.015%	

### TYPICAL DIFFUSIBLE HYDROGEN LEVELS TO AS3752:

1.0 - 2.0 mls of hydrogen / 100gms of deposited weld metal.

### TYPICAL ALL WELD METAL MECHANICAL PROPERTIES:

	Argon + 20-25% CO <sub>2</sub> Welding GradeCO <sub>2</sub> :	
Yield Stress	450 MPa	410 MPa
Tensile Strength	550 MPa	525 MPa
Elongation	29%	32%
CVN Impact Val.	120 J @ -20°C	110 J @ -20°C

### RECOMMENDED SHIELDING GAS:

Ar + 10-15% CO <sub>2</sub> or equivalent	ISO14175: M 21, M24 M14
Ar + 15-25% CO <sub>2</sub> or equivalent	ISO14175: M21, M24
Ar + 5% CO <sub>2</sub> + 3% O <sub>2</sub>	ISO14175: M23
Welding Grade CO <sub>2</sub>	ISO14175: C1

### COMPARABLE CIGWELD PRODUCTS:

Comweld LW1-6 TIG rod:  
 AWS/ASME-SFA A5.18: ER70S-6

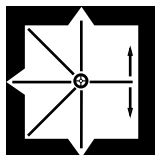

All positional welding applications

## AUTOCRAFT LW1-6



## Packaging and Operating Data:

Wire Dia mm	Voltage Range (volts)	Wire Feed Speed (metres/min)	Current Range (amps)	Pack Type*	Pack Weight	Part No
0.6	12-14	3.5-14	35-100	Mini Spool - Packs of 4 x 0.8kg		721104
				Handi Spool	5kg	721108
				Spool	15kg	720103
0.8	14-22	3.5-14	50-180	Mini Spool - Packs of 4 x 0.8kg		721105
				Handi Spool	5kg	721109
				Spool	15kg	720114
				Handispool	5kg	720161
0.9	15-26	3.5-15	70-230	Spool	15kg	720090
				AutoPak	250kg	720122A
1.0	16-29	3.5-15	100-280	Spool	15kg	720094
				AutoPak	250kg	720123A
1.2	18-32	2.5-15	120-350	Spool	15kg	720096
				AutoPak	250kg	720124A
1.6	18-34	2.5-10	180-390	Spool	15kg	720095
				**AutoPak	350kg	720125A

\* Mini Spool (ø100mm); Handi Spool (ø200mm); Spool (ø300mm); AutoPak (ø510mm x H.770mm);\*\* AutoPak (ø650mm x H820mm).

## AUTOPAK® Parts List:

AUTOPAK accessories "Standard Types".	Part Number.
1. Clear plastic AUTOPAK dome (510mm base diam. x 300mm height).	720001
2. AUTOPAK conduit assembly kit	720008



The advantages of AUTOPAK®.

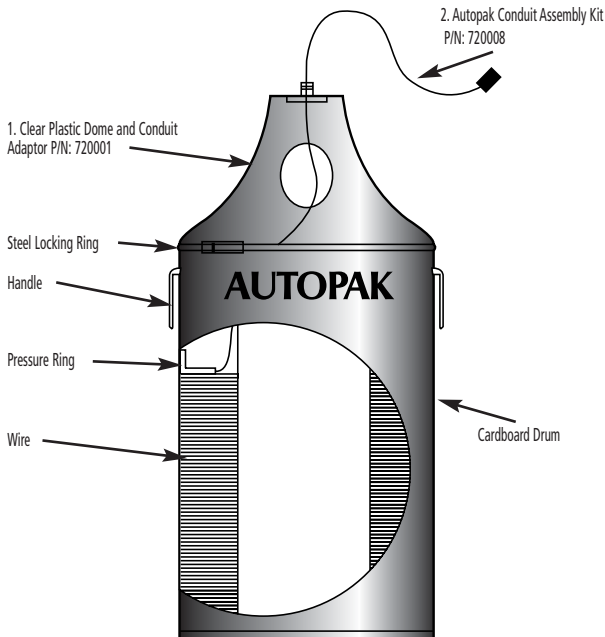

- ◆ Reduced downtime = Higher productivity outcomes.
- ◆ Straight/Twist free wire = Greater wire accuracy in the joint.
- ◆ Smaller Acceleration weight = Improved arc starting.
- ◆ Fully Enclosed pack and pay-off system = Less stress on wire-feed unit.
- ◆ Compact and manoeuvrable = Less wire slippage and burn backs.
- ◆ = Protection against dust, dirt and moisture.
- ◆ = Ease of use in confined and restricted locations. Autopak occupies only 0.2m<sup>2</sup> of floor space.

## AUTOCRAFT Mn-Mo



- ▲ A Manganese Molybdenum Steel Wire for the GMAW Welding of Higher Strength steels.
- ▲ For Use with Welding Grade CO<sub>2</sub> or Argon Based Shielding Gases.
- ▲ 550 MPa Tensile Class Weld Deposits.
- ▲ Suitable for Use with Short-arc, Spray & Pulsed Arc Transfer Modes.

## Classifications:

AS/NZS 2717.1: ESD2-GC/M-W559AH.  
AWS/ASME-SFA A5.28: ER80S-D2.

## Description and Applications:

Autocraft Mn-Mo is a copper coated, low alloy steel wire suitable for the all positional Gas Metal Arc Welding (GMAW) of medium to high strength steels.

Autocraft Mn-Mo produces a low alloy (nominally 1.7% Mn / 0.4% Mo) steel weld deposit of the 550 MPa tensile class. It gives excellent resistance to porosity when welding dirty or rusty plate due to its higher deoxidant levels.

Autocraft Mn-Mo is suitable for the all positional fillet and butt welding of a wide range of higher strength steels, particularly those used in the fabrication of pressure vessels, boilers and pipelines where service temperatures up to  $\approx 500^{\circ}\text{C}$  are experienced. Other applications include the lower strength fillet and butt welding of components subjected to dynamic loading.

## Storage Recommendations:

When held under the recommended storage conditions unopened packs of Autocraft Mn-Mo wires are expected to remain in 'factory fresh' condition for at least 12 months.

For storage over 12 months or under adverse (damp or high humidity) climatic conditions the use of heated weather proof store rooms /cupboards /containers maintained at  $10\text{-}15^{\circ}\text{C}$  above ambient temperature (with a maximum of  $40^{\circ}\text{C}$ ) and at a maximum humidity of 60% R.H. is recommended. Product should be stacked on racks or pallets clear of the floor and walls.

## Packaging and Operating Data:

Wire Diameter mm	Voltage Range (volts)	Wire Feed Speed (metres/min)	Current Range (amps)	Pack Type*	Pack Weight	Part No
0.9	16-28	3.5-15	70-230	Spool	15kg	720049
1.2	18-32	3.5-15	120-350	Spool	15kg	720052

\* Spool ( $\phi 300\text{mm}$ ).

## TYPICAL WIRE ANALYSIS:

C: 0.08%	Mn: 1.73%	Si: 0.65%
Mo: 0.45%	S: 0.011%	P: 0.017%

## TYPICAL DIFFUSIBLE HYDROGEN LEVELS TO AS3752:

1.0 - 2.0 mls of hydrogen / 100gms of deposited weld metal.

## TYPICAL ALL WELD METAL MECHANICAL PROPERTIES:

	Argon + 20-25% CO <sub>2</sub> :
Yield Stress	580 MPa
Tensile Strength	680 MPa
Elongation	24%
CVN Impact Values	80 J av @ +20°C

## RECOMMENDED SHIELDING GAS:

- Ar + 15-25% CO<sub>2</sub> or equivalent ISO14175: M21, M24
- Ar + 1-3% O<sub>2</sub> or equivalent ISO14175: M13
- Welding Grade CO<sub>2</sub> ISO14175: C1

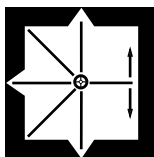

All positional welding applications



- ▲ A Low Alloy Steel Wire for the Gas Metal Welding of High Strength steels.
- ▲ For Use with Welding Grade CO<sub>2</sub> or Argon Based Shielding Gases.
- ▲ 760 MPa Tensile Class Weld Deposits.
- ▲ Suitable for Use with Short-arc, Spray & Pulsed Arc Transfer Modes.

### Classifications:

AS/NZS 2717.1: ESMG-GC/M-W769AH.  
 AWS/ASME-SFA A5.28: ER110S-G.

### Description and Applications:

Autocraft Ni Cr Mo. is a copper coated, low alloy steel wire suitable for the all positional Gas Metal Arc Welding of high strength steels.

Autocraft Ni Cr Mo. produces a low alloy (nominally, 1.4%Ni, 0.4%Cr, 0.30%Mo, 0.10%V) steel weld deposit of the 690 MPa tensile class.

Autocraft Ni Cr Mo. is suitable for the all positional fillet and butt welding of a wide range of high strength steels, particularly quenched and tempered types such as Bisalloy 80, USS-T1 types and Welten 80C etc. Autocraft Ni Cr Mo. is not suitable for use in weldments which are to be stress relieved. For these applications 'Vanadium free' welding wires such as Tensicor 110 TXP are recommended.

#### Storage Recommendations:

When held under the recommended storage conditions unopened packs of Autocraft Ni Cr Mo. wires are expected to remain in 'factory fresh' condition for at least 12 months.

For storage over 12 months or under adverse (damp or high humidity) climatic conditions the use of heated weather proof store rooms/cupboards/containers maintained at 10-15°C above ambient temperature (with a maximum of 40°C) and at a maximum humidity of 60% R.H. is recommended. Product should be stacked on racks or pallets clear of the floor and walls.

### Packaging and Operating Data:

Wire Diameter mm	Voltage Range (volts)	Wire Feed Speed (metres/min)	Current Range (amps)	Pack Type*	Pack Weight	Part No
1.2	18-32	3.5-15	120-350	Spool	15kg	720053

\* Spool (ø300mm).

### TYPICAL WIRE ANALYSIS:

C: 0.08%	Mn: 1.40%	Si: 0.60%
Ni: 1.40%	Cr: 0.40%	Mo: 0.25%
V: 0.10%		

### TYPICAL DIFFUSIBLE HYDROGEN LEVELS TO AS3752:

1.0 - 2.0 mls of hydrogen / 100gms of deposited weld metal.

### TYPICAL ALL WELD METAL MECHANICAL PROPERTIES:

	Ar + 1-3% O <sub>2</sub> :	Ar + 20-25% CO <sub>2</sub> :
Yield Stress	730 MPa	707 MPa
Tensile Strength	790 MPa	770 MPa
Elongation	17%	21%
CVN Impact Val.	130 J @ -29°C	72 J @ -29°C
	80 J @ -51°C	50 J @ -51°C

### RECOMMENDED SHIELDING GAS:

- Ar + 15-25% CO<sub>2</sub> or equivalent ISO14175: M21, M24
- Ar + 1-3% O<sub>2</sub> or equivalent ISO14175: M13
- Welding Grade CO<sub>2</sub> ISO14175: C1

The actual weld metal mechanical properties achieved with Autocraft Ni Cr Mo are influenced by many factors including, base metal analysis, welding parameters, shielding gas selection and number of passes etc. Please consult your nearest CIGWELD branch for welding procedure recommendations.

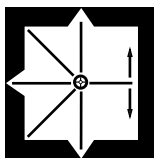

All positional welding applications



## AUTOCRAFT CrMo1



▲ For the Gas Metal Arc (GMA) Welding of Cr - Mo Creep Resistant Steels for Elevated Temperature and Corrosive Service.

▲ Also Recommended for the Dissimilar Joining of Cr - Mo Steels to Carbon Steels.

## Classifications:

AS/NZS 2717.1: ESB2-GM-W559AH.  
AWS/ASME-SFA A5.28: ER80S-B2.

## Description and Applications:

Autocraft CrMo1 is a copper coated steel Gas Metal Arc (GMA) welding wire alloyed with nominally 1.25% Chromium (Cr) and 0.50% Molybdenum (Mo).

It is recommended for the GMA welding of 1/2Cr-1/2Mo, 1Cr-1/2Mo and 1 1/4Cr-1/2Mo steel pipes, plates and castings used at elevated service temperatures (up to 550°C) in the power generation and petrochemical industries etc.

Autocraft CrMo1 is also suitable for the dissimilar GMA welding of Cr-Mo steel to carbon steel and for the welding of case hardenable steels or steels which can be subsequently heat treated.

## Storage Recommendations:

When held under the recommended storage conditions unopened packs of Autocraft CrMo1 are expected to remain in 'factory fresh' condition for at least 12 months.

For storage over 12 months or under adverse (damp or high humidity) climatic conditions the use of heated weather proof store rooms/cupboards/containers maintained at 10-15°C above ambient temperature (with a maximum of 40°C) and at a maximum humidity of 60% R.H. is recommended. Product should be stacked on racks or pallets clear of the floor and walls.

## TYPICAL WIRE ANALYSIS:

C: 0.09%	Mn: 0.60%	Si: 0.60%
Cr: 1.30%	Mo: 0.50%	P: 0.015%
S: 0.010%	Fe: Balance	

## TYPICAL DIFFUSIBLE HYDROGEN LEVELS TO AS3752:

1.0 - 2.0 mls of hydrogen / 100gms of deposited weld metal.

## TYPICAL ALL WELD METAL MECHANICAL PROPERTIES:

	Argon + 1-3% O <sub>2</sub> :
0.2% Proof Stress	500 MPa
Tensile Strength	600 MPa
Elongation	20%
CVN Impact Values	60 J av @ +20°C
Post weld heat treated at 620°C as required by AWS A5.28.	

## COMPARABLE CIGWELD PRODUCTS:

Alloycraft 80-B2 electrode  
AWS A5.5: E8018-B2  
Comweld CrMo1 TIG rod  
AWS A5.28: ER80S-B2

## RECOMMENDED SHIELDING GAS:

- Ar + 15-25% CO<sub>2</sub> or equivalent ISO14175: M21, M24
- Ar + 1-3% O<sub>2</sub> or equivalent ISO14175: M13

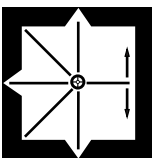

All positional welding applications

## Packaging and Operating Data:

Wire Diameter mm	Voltage Range (volts)	Wire Feed Speed (metres/min)	Current Range (amps)	Pack Type*	Pack Weight	Part No
1.2	18-32	3.5-15	120-350	Spool	15kg	720029

\* Spool (ø300mm).

## AUTOCRAFT 307Si



- ▲ For the GMAW Welding of hardenable steels, 13% Mn steels & difficult to weld steels.
- ▲ Extra Low Carbon ( < 0.07% ) Weld Deposits for Resistance to Intergranular Corrosion.
- ▲ High Silicon level for Improved Arc Stability and Increased Weld Pool Fluidity and Edge Wetting.
- ▲ New Ultrafeed matt finish.

## Classifications:

AS 2717.3:	ES307Si.
AWS/ASME-SFA A5.9:	ES307Si.

## Description and Applications:

Autocraft 307Si is a premium quality, low carbon 18% Cr, 8% Ni and 8% Mn stainless steel wire for the Gas Metal Arc Welding (GMAW) of hardenable steels, 13% Mn steels and difficult to weld steels.

Autocraft 307Si is also suitable for a wide range of other welding applications including:

- the dissimilar joining of '300 Series' and selected '400 Series' stainless steel grades to mild or low alloy steels
- an intermediate or buttering layer in the butt welding of clad steels,
- a stainless steel overlay on mild or low alloy steel and 13% Mn steels
- a buttering layer prior to surfacing.

The low carbon content ensures immunity from carbide precipitation and intergranular corrosion when welding low carbon stainless steel grades and the higher Silicon level offers improved arc stability, bead shape and edge wetting. Welds produced with Autocraft 307Si can be PWHT without the risk of sigma-phase and loss of ductility.

## Packaging and Operating Data:

These machine settings are a guide only. Actual voltage and welding current used will depend on machine characteristics, plate thickness, run size, shielding gas and operator technique etc.

Wire Diameter mm	Voltage Range (volts)	Wire Feed Speed (metres/min)	Current Range (amps)	Pack Type*	Pack Weight	Part No
0.9	16-24	4.5-15.0	70-200	Spool	15kg	721300
1.2	20-28	3.0-10.0	150-280	Spool	15kg	721301

\* Spool (ø300mm).

## TYPICAL WIRE ANALYSIS:

C: 0.07%	Mn: 8.90%	Si: 0.8%
Cr: 18.5%	Ni: 8.5%	P: 0.03%
S: 0.015%	Fe: Balance	

## FERRITE NUMBER:

10 – 15 FN

## TYPICAL ALL WELD METAL MECHANICAL PROPERTIES:

	Stainless:
0.2% Proof Stress	450 MPa
Tensile Strength	640 MPa
Elongation	40%
CVN Impact Values	150 J av @ 20°C

## COMPARABLE CIGWELD PRODUCTS:

Coabalarc Austex  
AS/NZS 2576 1315-A4

## RECOMMENDED SHIELDING GAS:

- Ar + 1-3% O<sub>2</sub> or equivalent ISO14175: M13
- Ar + 2-5% CO<sub>2</sub> or equivalent ISO14175: M12
- Ar + 2-4% CO<sub>2</sub> + 35% He

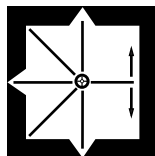

All positional welding applications

## AUTOCRAFT 308LSi



- ▲ For the GMAW Welding of 18%Cr / 8%Ni Type Stainless Steels.
- ▲ Extra Low Carbon ( < 0.03% ) Weld Deposits for Resistance to Intergranular Corrosion.
- ▲ High Silicon level for Improved Arc Stability and Increased Weld Pool Fluidity and Edge Wetting.
- ▲ NEW Ultrafeed Matt Finish.

## Classifications:

AS 2717.3:	ES308LSi.
AWS/ASME-SFA A5.9:	ER308LSi.

## Description and Applications:

Autocraft 308LSi is a premium quality, low carbon 20% Cr / 10% Ni stainless steel wire for the Gas Metal Arc Welding (GMAW) of a wide range of austenitic 18/8 type stainless steel pipes, plates, forgings and castings.

The low carbon content of Autocraft 308LSi ensures immunity from carbide precipitation and intergranular corrosion when welding low carbon stainless steel grades and the higher Silicon level offers improved arc stability, bead shape and edge wetting.

Autocraft 308LSi is recommended for the general welding of 301, 302, 321, 347, 409 and 444 type stainless steels and for the critical welding of 304 and 304L types in corrosion resistant and cryogenic applications.

## Packaging and Operating Data:

These machine settings are a guide only. Actual voltage and welding current used will depend on machine characteristics, plate thickness, run size, shielding gas and operator technique etc.

Wire Diameter mm	Voltage Range (volts)	Wire Feed Speed (metres/min)	Current Range (amps)	Pack Type*	Pack Weight	Part No
0.9	16-24	4.5-15.0	70-200	Spool	15kg	721271
1.2	20-28	3.0-10.0	150-280	Spool	15kg	721272

\* Spool (ø300mm).

## TYPICAL WIRE ANALYSIS:

C: 0.02%	Mn: 2.05%	Si: 0.80%
Cr: 19.95%	Ni: 10.25%	P: 0.020%
S: 0.005%	Fe: Balance	

## FERRITE NUMBER:

5 – 10 FN

## TYPICAL ALL WELD METAL MECHANICAL PROPERTIES:

	Ar + 1-3% O <sub>2</sub> :
0.2% Proof Stress	450 MPa
Tensile Strength	620 MPa
Elongation	36%
CVN Impact Values	90 J av @ -60°C

## COMPARABLE CIGWELD PRODUCTS:

Satinchrome 308L-17 electrode  
 AWS A5.4: E308L-17  
 Comweld 308L TIG rod  
 AWS A5.9: ER308L  
 Shieldchrome 308LT FCAW wires  
 AWS A5.22: E308LT1-1/4

## RECOMMENDED SHIELDING GAS:

- Ar + 1-3% O<sub>2</sub> or equivalent ISO14175: M13
- Ar + 2-5% CO<sub>2</sub> or equivalent ISO14175: M12
- Ar + 1-4% CO<sub>2</sub> + 1-5% H<sub>2</sub> or equivalent ISO14175: M11 (1)
- Ar + 1-4% CO<sub>2</sub> + 35% He

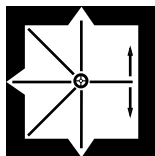

All positional welding applications

## AUTOCRAFT 309LSi



- ▲ For the GMAW Welding of 23%Cr / 12%Ni Type Stainless Steels.
- ▲ Extra Low Carbon (< 0.03% ) Weld Deposits for Resistance to Intergranular Corrosion.
- ▲ High Silicon level for Improved Arc Stability and Increased Weld Pool Fluidity and Edge Wetting.
- ▲ NEW Ultrafeed Matt Finish.

## Classifications:

AS 2717.3:	ES309LSi.
AWS/ASME-SFA A5.9:	ER309LSi.

## Description and Applications:

Autocraft 309LSi is a premium quality, low carbon 24% Cr / 13% Ni stainless steel wire for the Gas Metal Arc Welding (GMAW) of matching 309L type stainless steel.

Autocraft 309LSi is also suitable for a wide range of other welding applications including;

- ◆ The dissimilar joining of "300 series" and selected "400 series" stainless steel grades to mild or low alloy steels,
- ◆ An intermediate or buttering layer in the butt welding of clad steels,
- ◆ A stainless steel overlay on mild or low alloy steel,
- ◆ A 'buttering' layer prior to hardfacing.

The low carbon content ensures immunity from carbide precipitation and intergranular corrosion when welding low carbon stainless steel grades and the higher Silicon level offers improved arc stability, bead shape and edge wetting.

## TYPICAL WIRE ANALYSIS:

C: 0.02%	Mn: 2.10%	Si: 0.75%
Cr: 23.75%	Ni: 13.75%	P: 0.020%
S: 0.005%	Fe: Balance	

## FERRITE NUMBER:

10 – 15 FN

## TYPICAL ALL WELD METAL MECHANICAL PROPERTIES:

	Argon + 1-3% O <sub>2</sub> :
0.2% Proof Stress	450 MPa
Tensile Strength	610 MPa
Elongation	36%
CVN Impact Values	90 J av @ -110°C

## COMPARABLE CIGWELD PRODUCTS:

Satinrome 309Mo-17 electrode  
 AWS A5.4: E309Mo-17  
 Comweld 309L TIG rod  
 AWS A5.9: ER309L  
 Shieldrome 309LT FCAW wires  
 AWS A5.22: E309LT1-1/4

## RECOMMENDED SHIELDING GAS:

- Ar + 1-3% O<sub>2</sub> or equivalent ISO14175: M13
- Ar + 2-5% CO<sub>2</sub> or equivalent ISO14175: M12
- Ar + 1-4% CO<sub>2</sub> + 1-5% H<sub>2</sub> or equivalent ISO14175: M11 (1)
- Ar + 1-4% CO<sub>2</sub> + 35% He

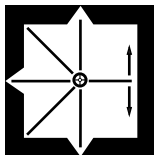

All positional welding applications

## Packaging and Operating Data:

These machine settings are a guide only. Actual voltage and welding current used will depend on machine characteristics, plate thickness, run size, shielding gas and operator technique etc.

Wire Diameter mm	Voltage Range (volts)	Wire Feed Speed (metres/min)	Current Range (amps)	Pack Type*	Pack Weight	Part No
0.9	16-24	4.5-15.0	70-200	Spool	15kg	721276
1.2	20-28	3.0-10.0	150-280	Spool	15kg	721277

\* Spool (ø300mm).

## AUTOCRAFT 316LSi



- ▲ For the GMAW Welding of 18%Cr / 8%Ni and 18%Cr / 8%Ni / 3%Mo Type Stainless Steels.
- ▲ Extra Low Carbon ( < 0.03% ) Weld Deposits for Resistance to Intergranular Corrosion.
- ▲ High Silicon level for Improved Arc Stability and Increased Weld Pool Fluidity and Edge Wetting.
- ▲ NEW Ultrafeed Matt Finish.

## Classifications:

AS 2717.3: E316LSi.  
AWS/ASME-SFA A5.9: ER316LSi.

## Description and Applications:

Autocraft 316LSi is a premium quality, low carbon 19% Cr / 13% Ni / 2.5Mo stainless steel wire for the Gas Metal Arc Welding (GMAW) of Molybdenum bearing stainless steels; in particular 316, 318 and 316L alloys.

Autocraft 316LSi is also suitable for the general welding of other 300 and 400 series stainless steels including 301, 302, 304/304L, 321, 347, 410 and 430.

The low carbon content ensures immunity from carbide precipitation and intergranular corrosion when welding low carbon stainless steel grades and the higher Silicon level offers improved arc stability, bead shape and edge wetting.

## TYPICAL WIRE ANALYSIS:

C: 0.02%	Mn: 1.52%	Si: 0.70%
Cr: 18.85%	Ni: 12.75%	Mo: 2.45%
P: 0.022%	S: 0.002%	Fe: Balance

## FERRITE NUMBER:

5 – 10 FN

## TYPICAL ALL WELD METAL MECHANICAL PROPERTIES:

	Argon + 1-3% O <sub>2</sub> :
0.2% Proof Stress	470 MPa
Tensile Strength	640 MPa
Elongation	38%
CVN Impact Valves	90 J av @ -60°C

## COMPARABLE CIGWELD PRODUCTS:

Satinchrome 316L-17 electrode  
AWS A5.4: E316L-17

Comweld 316L TIG rod  
AWS A5.9: ER316L

Shieldchrome 316LT FCAW wires  
AWS A5.22: E316LT1-1/4

## RECOMMENDED SHIELDING GAS:

- Ar + 1-3% O<sub>2</sub> or equivalent ISO14175: M13
- Ar + 2-5% CO<sub>2</sub> or equivalent ISO14175: M12
- Ar + 1-4% CO<sub>2</sub> + 1-5% H<sub>2</sub> or equivalent ISO14175: M11 (1)
- Ar + 1-4% CO<sub>2</sub> + 35% He

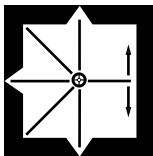

All positional welding applications

## Packaging and Operating Data:

These machine settings are a guide only. Actual voltage and welding current used will depend on machine characteristics, plate thickness, run size, shielding gas and operator technique etc.

Wire Dia mm	Voltage Range (volts)	Wire Feed Speed (metres/min)	Current Range (amps)	Pack Type*	Pack Weight	Part No
0.8	16–20	5.0–15.0	60–150	Mini spool (4 per pack)	4 x 1kg	721285
0.9	16–24	4.5–15.0	70–200	Handi spool	5kg	720283
0.9	16–24	4.5–15.0	70–200	Spool	15kg	721286
1.0	16–24	4.5–15.0	70–200	Spool	15kg	722386
1.2	20–28	3.0–10.0	150–280	Spool	15kg	721287

\* Mini spool (ø100mm); Handi spool (ø200mm); Spool (ø300mm).



- ▲ For the GMAW welding of 22%Cr/5%Ni/3%Mo duplex type stainless steels.
- ▲ Extra low carbon (<0.03%) corrosion resistance weld deposits.
- ▲ Precision layer wound for improved feedability and performance.
- ▲ New Ultrafeed matt finish.

**Classifications:**

AS 2717.3:	ES2209
AWS/ASME-SFA A5.9:	ER2209.
Werkstoffe No:	1.4462

**Description and Applications:**

Autocraft 2209 is a premium quality GMAW stainless steel welding wire suitable for the single and multi-pass fillet and butt welding of 22Cr/5Ni/3Mo type duplex stainless steels. Applications include the welding of duplex stainless steels (UNS S30000 series) as used for corrosion resistant applications as an alternative to 300 series austenitic stainless steels.

The most common duplex grades weldable with Autocraft 2209 include S39205 (2205 and Bohler A903) and S39230 (2304).

Autocraft 2209 has high resistance to intergranular and pitting corrosion. It has especially high resistance to stress corrosion in chloride and hydrogen sulphide containing media. Applications include the welding of stainless steel tanks and pipes in the chemistry industry.

**TYPICAL WIRE ANALYSIS:**

C: 0.012%	Mn: 1.60%	Si: 0.44%
Cr: 22.80%	Ni: 8.63%	Mo: 3.10%
N: 0.14%	P: 0.018%	S: 0.007%
Cu: 0.06%	Fe: Balance	

**FERRITE NUMBER:**

30- 50 FN (Procedure dependent)

**TYPICAL ALL WELD METAL MECHANICAL PROPERTIES:**

	Welding grade Argon:
0.2% Proof Stress	600 MPa
Tensile Strength	765 MPa
Elongation	28%
CVN Impact Value	60J av @ -40°C
	80J av @ -20°C
	100J av @ +20°C

**COMPARABLE CIGWELD PRODUCTS:**

Comweld 2209 TIG rod  
AWS A5.9: ER 2209

**RECOMMENDED SHIELDING GAS:**

- Ar + 1-3% O<sub>2</sub> or equivalent ISO14175: M13
- Ar + 2-5% CO<sub>2</sub> or equivalent ISO14175: M12

Some nitrogen bearing shielding gases assist in maintaining an optimum Austenite/Ferrite ratio. Consult your gas supplier for specific details.

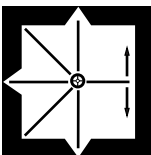

All positional welding applications

**Packaging and Operating Data:**

These machine settings are a guide only. Actual voltage and welding current used will depend on machine characteristics, plate thickness, run size, shielding gas and operator technique etc.

Wire Diameter mm	Voltage Range (volts)	Wire Feed Speed (metres/min)	Current Range (amps)	Pack Type*	Pack Weight	Part No
0.9	16-24	4.5-15.0	65-165	Spool	15kg	721261
1.2	20-26	3.0-10.0	180-280	Spool	15kg	721262

## AUTOCRAFT AL1100



- ▲ For the GMAW Welding of Selected Wrought Aluminium Alloys.
- ▲ Highest Quality - Precision Layer Wound.
- ▲ Patented Lubrication Process for Superior Wire Feedability.
- ▲ Superior Wire Cleanliness for Improved Resistance to Porosity.
- ▲ Tight Wire Diameter Control for Smooth, Consistent Arc Performance.
- ▲ Standard 7 kg Spools for Fewer Spool Change-overs.

**WIRE ANALYSIS LIMITS:**

Si: 0.06%	Fe: 0.06%	Cu: 0.005%
Mn: 0.01%	Mg: 0.01%	Zn: 0.03%
Ti: 0.01%	Total others: 0.01%	
Al: 99.88% min.		

\* Single values are maximum allowable, unless otherwise stated.

**TYPICAL ALL WELD METAL MECHANICAL PROPERTIES:**

Single-vee butt weld with 1060 Aluminium (reduced section tensile specimen):

	Welding grade Argon:
0.2% Proof Stress	34.5 MPa
Tensile Strength	69.0 MPa
Elongation (in 2 inches)	29%

**RECOMMENDED SHIELDING GAS:**

- Welding Grade Argon ISO14175:11
- Ar + 25% He or equivalent gases ISO14175:13
- He + 25% Ar or equivalent gases ISO14175:13

**Classifications:**

AS/NZS 2717.2:	E1100.
AWS/ASME-SFA A5.10:	ER1100.

**Description and Applications:**

Autocraft AL1100 is a premium quality, pure (99.88% min) Aluminium alloy recommended for the Gas Metal Arc Welding (GMAW) of selected 1XXX series wrought Aluminium alloys. The lower weld deposit strength, excellent corrosion resistance and high thermal and electrical conductivity make Autocraft AL1100 ideal for the joining of selected high purity 1XXX series Aluminium alloys used extensively in electrical and chemical industry applications. Autocraft AL1100 produces a good colour match in anodised 1XXX series welded joints. See CIGWELD Aluminium Alloy Selection Chart for detailed welding consumable selection criteria for a wide range of Aluminium alloy parent metals.

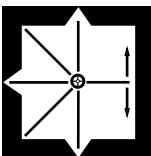

All positional welding applications

**Storage and Handling Recommendations:**

- ◆ Store in a heated room with uniform temperature control and, if possible, with humidity control as well.
- ◆ Store unpackaged Autocraft AL series wires for long periods in a heated cabinet at 10-15°C above ambient temperature.
- ◆ Hold Autocraft AL series welding wires in the welding area for 24 hours before unpacking to allow its temperature to equalise with that of the surrounding area.
- ◆ Use dust covers on open wire feed units to protect wire during welding.

**Packaging and Operating Data:**

These machine settings are a guide only. Actual voltage and welding current used will depend on machine characteristics, plate For 1XXX, 2XXX and 4XXX type welding wires use welding current settings on the lower side of the specified range and arc voltages on the higher side.

Wire Dia mm	Voltage Range (volts)	Wire Feed Speed (metres/min)	Current Range (amps)	Pack Type*	Pack Weight	Part No
1.6	23-28	5.0-9.5	200-350	Spool	7kg	722218
2.0	25-31	4.0-8.0	250-400	Spool	7kg	723218

\* Spool (ø300mm).



- ▲ For GMAW Welding of Selected Wrought and Cast Aluminium Alloys.
- ▲ Highest Quality - Precision Layer Wound.
- ▲ Patented Lubrication Process for Superior Wire Feedability.
- ▲ Superior Wire Cleanliness for Improved Resistance to Porosity.
- ▲ Tight Wire Diameter Control for Smooth, Consistent Arc Performance.
- ▲ Standard 7.0 kg Spools for Fewer Spool Change-overs.

### Classifications:

AS 2717.2: E4043.  
 AWS/ASME-SFA A5.10: ER4043.

### Description and Applications:

Autocraft AL4043 is a premium quality Aluminium - nominal 5% Silicon alloy suitable for the Gas Metal Arc Welding (GMAW) of a wide range of cast and wrought Aluminium alloys. Autocraft AL4043 is used extensively for the repair welding of many aluminium alloy castings. It's lower weld deposit strength, and excellent crack resistance make it suitable for the GMA welding of cast ( mainly 4XX & 6XX series ) and wrought ( selected 1XXX, 5XXX & 6XXX series ) aluminium alloys, except where an accurate colour match is required after anodising.

See CIGWELD Aluminium Alloy Selection Chart for detailed welding consumable selection criteria for a wide range of Aluminium alloy parent metals.

### Storage and Handling Recommendations:

- ◆ Store in a heated room with uniform temperature control and, if possible, with humidity control as well.
- ◆ Store un packaged Autocraft AL series wires for long periods in a heated cabinet at 10-15°C above ambient temperature.
- ◆ Hold Autocraft AL series welding wires in the welding area for 24 hours before unpacking to allow its temperature to equalise with that of the surrounding area.
- ◆ Use dust covers on open wire feed units to protect wire during welding.

### Packaging and Operating Data:

These machine settings are a guide only. Actual voltage and welding current used will depend on machine characteristics, plate thickness, run size, shielding gas and operator technique etc. For 5XXX type welding wires use welding current settings on the higher side of the range specified below and arc voltages on the lower side of the range. For 1XXX, 2XXX and 4XXX type welding wires use welding current settings on the lower side of the specified range and arc voltages on the higher side.

Wire Dia mm	Voltage Range (volts)	Wire Feed Speed (metres/min)	Current Range (amps)	Pack Type*	Pack Weight	Part No
1.2	20-25	5.5-12.0	150-250	Spool	7kg	722237
1.6	23-28	5.0-9.5	200-350	Spool	7kg	722238

\* Spool (ø300mm).

### WIRE ANALYSIS LIMITS:

Single values are maximum allowable, unless otherwise stated.

Si: 4.5-6.0%	Fe: 0.80%	Cu: 0.30%
Mn: 0.05%	Mg: 0.05%	Zn: 0.10%
Ti: 0.20%	Total others: 0.15%	
Al: Balance		

### TYPICAL ALL WELD METAL MECHANICAL PROPERTIES:

Single-vee butt weld with 6061-T6 Aluminium (reduced section tensile specimen) using welding grade Argon: Postweld heat

	As welded:	treated and aged:
0.2% Proof Stress	124 MPa	276 MPa
Tensile Strength	186 MPa	303 MPa
Elongation (in 2 inches)	8%	5%

### RECOMMENDED SHIELDING GAS:

- Welding Grade Argon ISO14175: I
- Ar + 25% He or equivalent gases ISO14175: I3
- He + 25% Ar or equivalent gases ISO14175: I3

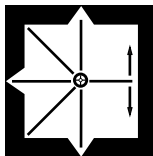

All positional welding applications



## AUTOCRAFT AL5356



- ▲ For GMAW Welding of Wrought and Cast Aluminium Alloys containing Magnesium.
- ▲ Patented Lubrication Process for Superior Wire Feedability.
- ▲ Superior Surface Cleanliness for Improved Resistance to Porosity.
- ▲ Tight Wire Diameter Control for Smooth, Consistent Arc Performance.
- ▲ DNV Shipping Society Approval.
- ▲ Standard 7.0 kg Spools for Fewer Spool Change-overs.

## Classifications:

AS 2717.2:	E5356.
AWS/ASME-SFA A5.10:	ER5356.

## Description and Applications:

Autocraft AL5356 is a premium quality, Aluminium - nominal 5% Magnesium alloy suitable for the Gas Metal Arc Welding (GMAW) of a wide range of cast and wrought Aluminium alloys. Autocraft AL5356 is the most popular Aluminium alloy in the CIGWELD range. It produces intermediate deposit strength and good ductility and corrosion resistance for the GMA welding of a wide range of 3XXX, 5XXX, 6XXX and 5XX Aluminium alloys.

See CIGWELD Aluminium Alloy Selection Chart for detailed welding consumable selection criteria for a wide range of Aluminium alloy parent metals.

## Storage and Handling Recommendations:

- ◆ Store in a heated room with uniform temperature control and, if possible, with humidity control as well.
- ◆ Store unpackaged Autocraft AL series wires for long periods in a heated cabinet at 10-15°C above ambient temperature.
- ◆ Hold Autocraft AL series welding wires in the welding area for 24 hours before unpacking to allow its temperature to equalise with that of the surrounding area.
- ◆ Use dust covers on open wire feed units to protect wire during welding.

## APPROVALS:

Det Norske Veritas (DNV).

Lloyds Register (LRS).

\* with welding grade Argon

## WIRE ANALYSIS LIMITS:

Single values are maximum allowable, unless otherwise stated.

Si: 0.25%	Fe: 0.40%	Cu: 0.10%
Mn: 0.05-0.2%	Mg: 4.5-5.5%	Cr: 0.05-0.20%
Zn: 0.10%	Ti: 0.06-0.20%	
Total others: 0.15%	Al: Balance	

## TYPICAL ALL WELD METAL MECHANICAL PROPERTIES:

Single-vee butt weld with 5086 Aluminium (reduced section tensile specimen):

	Welding grade Argon:
0.2% Proof Stress	130 MPa
Tensile Strength	269 MPa
Elongation (in 2 inches)	17%

## RECOMMENDED SHIELDING GAS:

- Welding Grade Argon ISO14175: I
- Ar + 25% He or equivalent gases ISO14175: B
- He + 25% Ar or equivalent gases ISO14175: B

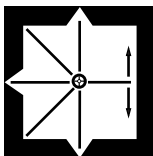

All positional welding applications

**Packaging and Operating Data:**

These machine settings are a guide only. Actual voltage and welding current used will depend on machine characteristics, plate thickness, run size, shielding gas and operator technique etc. For 5XXX type welding wires use welding current settings on the higher side of the range specified below and arc voltages on the lower side of the range. For 1XXX, 2XXX and 4XXX type welding wires use welding current settings on the lower side of the specified range and arc voltages on the higher side.

Wire Dia mm	Voltage Range (volts)	Wire Feed Speed (metres/min)	Current Range (amps)	Pack Type*	Pack Weight	Part No
0.8	14-21	6.0-20.0	50-150	Mini Spool (4 per pack)	4 x 0.5kg	721221
0.9	16-22	6.0-17.5	80-180	Spool	7kg	722226
1.0	17-23	6.0-16.5	110-220	Spool	7kg	722224
1.0	17-23	6.0-16.5	110-220	Handi Spool	2.0kg	723224
1.2	20-25	5.5-12.0	150-250	Spool	7kg	722227

\* Mini Spool (ø100mm); Handi Spool (ø200mm); Spool (ø300mm).

## AUTOCRAFT AL5183



- ▲ For GMAW welding of wrought and cast aluminium alloys containing magnesium.
- ▲ Superior surface cleanliness for improved resistance to porosity.

**Classifications:**

AS 2717.2: E5183.  
AWS/ASME-SFA A5.10: ER5183.

**Description and Applications:**

Autocraft AL5183 is a premium quality Aluminium welding wire that is typically used in the marine and structured industries, where higher strength and good fracture toughness is required. Autocraft AL5183 is ideally suited to the welding of Alloy 5083. Autocraft AL5183 is not suitable for heat treatment.

**TYPICAL ALL WELD METAL MECHANICAL PROPERTIES:**

Single-vee butt weld with 5083 Aluminium (reduced section tensile specimen)

Welding grade Argon:

0.2% Proof Stress 152 MPa

Tensile Strength 297 MPa

Elongation (in 2 inches) 16%

**WIRE ANALYSIS LIMITS:**

Single values are maximum allowable, unless otherwise stated.

Si: 0.40% Fe: 0.40% Cu: 0.10%

Mn: 0.5-1.0% Mg: 4.3-5.2% Cr: 0.05-0.25%

Zn: 0.25% Ti: 0.15%

Total others: 0.15% Al: Balance

**RECOMMENDED SHIELDING GAS:**

- Welding Grade Argon ISO14175: I
- Ar + 25% He or equivalent gases ISO14175: I3
- He + 25% Ar or equivalent gases ISO14175: I3

**APPROVALS:**

Det Norske Veritas (DNV)  
Lloyds register of Shipping  
American Bureau of Shipping

**Packaging and Operating Data:**

These machine settings are a guide only. Actual voltage and welding current used will depend on machine characteristics, plate thickness, run size, shielding gas and operator technique etc. For 5XXX type welding wires use welding current settings on the higher side of the range specified below and arc voltages on the lower side of the range. For 1XXX, 2XXX and 4XXX type welding wires use welding current settings on the lower side of the specified range and arc voltages on the higher side.

Wire Dia mm	Voltage Range (volts)	Wire Feed Speed (metres/min)	Current Range (amps)	Pack Type*	Pack Weight	Part No
1.0	17-23	6.0-16.5	110-220	Spool	7kg	722239
1.2	20-25	5.5-12.0	150-250	Spool	7kg	722240

\* Spool (ø300mm).



- ▲ For GMAW Joining and Overlay Applications.
- ▲ Fabricating Deoxidised Copper and Electrolytic Pitch Copper Components.
- ▲ Repair of Copper Castings.
- ▲ Lower Strength Welding of Galvanised Steels and Deoxidised Copper to Mild Steel Joints.

## Classifications:

AWS/ASME-SFA A5.7: ERcCu.

## Description and Applications:

Autocraft Deoxidised Copper is a versatile 98% pure Copper alloy for the GMAW welding of:

- ◆ Deoxidised and electrolytic tough pitch copper components
- ◆ Copper castings and galvanised steels
- ◆ Dissimilar mild steel to deoxidised copper joints

Autocraft Deoxidised Copper should only be used for the GMAW welding of galvanised steel and for dissimilar welding of mild steel to deoxidised copper where high strength joints are not required.

Typical applications include the GMAW welding of copper transformer connectors, copper bus bars, billet molds and heater elements etc.

Autocraft Deoxidised Copper can also be used as a corrosion resistant overlay.

## Packaging and Operating Data:

These machine settings are a guide only. Actual voltage and welding current used will depend on machine characteristics, plate thickness, run size, shielding gas and operator technique etc.

Wire Diameter mm	Voltage Range (volts)	Wire Feed Speed (metres/min)	Current Range (amps)	Pack Type*	Pack Weight	Part No
1.6	28-32	5.5-11.5	160-380	Spool	13kg	720260

\* Spool (ø300mm).

## TYPICAL ALL WELD METAL MECHANICAL PROPERTIES:

Welding grade Argon:	
0.2% Proof Stress	55 MPa
Tensile Strength	200 MPa
Elongation (in 2 inches)	30%
Electrical Conductivity	40% IACS
Hardness	55 BHN
Weld Metal Density	$7.47 \times 10^3 \text{ kg/m}^3$

## TYPICAL WIRE ANALYSIS LIMITS:

Mn: 0.5%	Si: 0.5%	P: 0.15%
Sn: 1.0%	Cu: 98.0% min	Others: 0.50%

Single values are maximum allowable, unless otherwise stated.

## RECOMMENDED SHIELDING GAS:

- Welding Grade Argon ISO14175: I
- Ar + 25% He or equivalent gases ISO14175: I3
- He + 25% Ar or equivalent gases ISO14175: I3

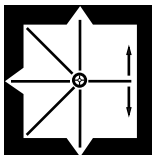

All positional welding applications

## AUTOCRAFT SILICON BRONZE



- ▲ For the GMAW Welding of Copper-Silicon Alloys including Cusilman and Everdur.
- ▲ Used for the Lower Strength Welding of Steels.
- ▲ Extensively used in Marine and Hot Water System Applications.

## Classifications:

AWS/ASME-SFA A5.7: ERcusi-A.

## Description and Applications:

Autocraft Silicon Bronze is a Copper based wire recommended for the Gas Metal Arc Welding (GMAW) of Copper-Silicon alloys used extensively in hot water systems, heat exchangers, calorifiers and marine components for their corrosion resistance.

Autocraft Silicon Bronze is highly recommended for the fillet welding of galvanised steels and irons and for the lower strength 'brazing' of light gauge steel sections as used in the automotive industry. It is also suitable for the MIG welding of Copper-Zinc alloys to themselves and to steels.

## TYPICAL WIRE ANALYSIS:

Fe: 0.25%	Mn: 1.0%	Si: 3.40%
Sn: 0.90%	Zn: 0.90%	Cu: Balance

## TYPICAL ALL WELD METAL MECHANICAL PROPERTIES:

Welding grade Argon:	
0.2% Proof Stress	170 MPa
Tensile Strength	380 MPa
Elongation (in 2 inches)	50%

## TYPICAL WELD DEPOSIT HARDNESS WITH

Argon + 16% CO<sub>2</sub> + 2.75% O<sub>2</sub>:

	HR <sub>B</sub>
Three Layers on Mild Steel	48

## COMPARABLE CIGWELD PRODUCTS:

Comweld Silicon Bronze rod  
AWS A5.7: ERcusi-A

## RECOMMENDED SHIELDING GAS:

- Welding Grade Argon ISO14175: I1
- Ar + 10-15% CO<sub>2</sub> or equiv. gases ISO14175: M21, M24, M14
- Ar + 20-25% CO<sub>2</sub> or equiv gases ISO14175: M21, M24
- Ar + > 0-3% O<sub>2</sub> or equiv gases ISO14175: M13
- He + 25% Ar or equivalent gases ISO14175: I3



All positional welding applications

## Packaging and Operating Data:

These machine settings are a guide only. Actual voltage and welding current used will depend on machine characteristics, plate thickness, run size, shielding gas and operator technique etc.

Wire Diameter mm	Voltage Range (volts)	Wire Feed Speed (metres/min)	Current Range (amps)	Pack Type*	Pack Weight	Part No
0.8	15-20	4.5-10.5	65-150	Handispool	4.5kg	720159
0.9	21-26	7.5-14.5	100-250	Spool	13kg	720015
1.2	22-28	5.5-11.5	160-380	Spool	13kg	720255

\* Spool (ø300mm).





Description	Page No
Satin-Cor XP	129
Verti-Cor XP	130
Verti-Cor Ultra	132
Verti-Cor 3XP	134
Verti-Cor 3XP H4 - Seamless	136
Verti-Cor 81 A1 H4	138
Verti-Cor 81 Ni1	139
Verti-Cor 81 Ni1 H4	140
Verti-Cor 81 Ni2	142
Verti-Cor 91 K2 H4	144
Verti-Cor 111K3 H4	145
Supre-Cor 5	146
Supre-Cor XP H4	148
Metal-Cor XP	149
Metal-Cor 5	151
Tensi-Cor 110TXP H4	152
Nicore 55	154
Shield-Cor 4XP	155
Shield-Cor 8XP	156
Shield-Cor 8Ni	157
Shield-Cor 11	158
Shield-Cor 15	160
Verti-Cor 308LT	162
Verti-Cor 309LT	164
Verti-Cor 316LT	166
Stoody SOS 308L	168
Stoody SOS 309L	169



## CONTACT TIP TO WORK DISTANCE (CTWD) EXPLAINED

**Contact Tip to Work Distance (CTWD)**, also sometimes referred to as electrode stick out (ESO), is defined as the distance between the end of the contact tip and the workpiece. A schematic diagram of CTWD is shown below. CTWD includes the wire length from the contact tip, to the point where it enters the welding arc, and the arc length.

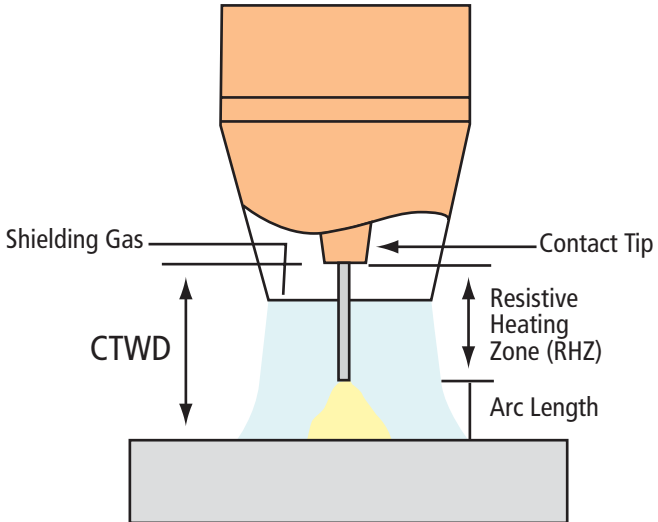



- ▲ Rutile Type Flux Cored Wire Formulated for Use with CO<sub>2</sub> Shielding Gas.
- ▲ 1.6mm can be used with Argon + 20-25% CO<sub>2</sub> or CO<sub>2</sub>.
- ▲ High Speed, Downhand Welding Applications.
- ▲ Excellent Operator Appeal.
- ▲ Superior Fillet Shape and Slag Lift.
- ▲ Precision Layer Wound.

### Classifications:

AS 2203.1: ETD-GCp-W502A. CM1 H10.

AWS/ASME-SFA A5.20: E70T-1H8.

#### 1.6mm ONLY:

AS 2203.1: ETD-GCp-W502A. CM1 H10.

ETD-GMp-W502A. CM1 H10.

AWS/ASME-SFA A5.20: E70T-1H8, E70T-1M H8

### Description and Applications:

Satin-Cor XP is a smooth running rutile type flux cored wire recommended for the high speed fillet and butt welding of mild and medium strength steels using welding grade carbon dioxide shielding gas. The 1.6mm size is formulated for use with either CO<sub>2</sub> or Argon + 20-25% CO<sub>2</sub>.

The fluid, full covering slag system of Satin-Cor XP gives superior fillet shapes in all downhand (flat, horizontal and horizontal-vertical) welding positions. The smooth arc transfer using CO<sub>2</sub> shielding gas produces low spatter levels and the full covering slag is easy to control and self-releasing in many joint preparations. Satin-Cor XP is designed for the high productivity, single and multi-pass welding of mild and medium strength steels in the flat, horizontal and horizontal-vertical positions. It is particularly recommended for the downhand fillet welding of structural steels of 6mm thickness or heavier.

### Operating Data:

All welding conditions recommended below are for use with semi-automatic operation, DC electrode positive and welding grade CO<sub>2</sub> shielding gas with a flow rate of 10-15 litres/min.

Wire Diameter (mm)	Current Range (amps)	Voltage Range (volts)	CTWD	Welding Positions	
1.6	350-450	28-33	25-30		Flat
2.4	400-550	28-33	25-35		
1.6	300-400	26-30	25-30		HV Fillet
2.4	350-450	26-30	25-30		
1.6	270-350	25-29	25-30		Horizontal
2.4	320-420	25-29	25-30		

These machine settings are a guide only. Actual voltage, welding current and CTWD used will depend on machine characteristics, plate thickness, run size, shielding gas and operator technique etc.

### APPROVALS\*:

Lloyds Register of Shipping	Grade 2YS H
American Bureau of Shipping	Grade 2SA H10, 2YSA H10
Det Norske Veritas	II YMS

\* - with welding grade CO<sub>2</sub> shielding gas.

### TYPICAL ALL WELD METAL ANALYSIS:

Using CO<sub>2</sub>

C: 0.04% Mn: 1.4% Si: 0.41%

Using Argon + 20-25% CO<sub>2</sub> (1.6mm only)

C: 0.05% Mn: 1.65% Si: 0.61%

### TYPICAL DIFFUSIBLE HYDROGEN LEVELS TO AS3752:

5- 6mls of hydrogen / 100gms of deposited weld metal.

For welded product using welding grade CO<sub>2</sub> shielding gas.

### TYPICAL ALL WELD METAL MECHANICAL PROPERTIES:

	CO <sub>2</sub>	Argon+20-25% CO <sub>2</sub>
Yield Stress.	430 MPa	465 MPa (1.6mm)
Tensile Strength	560 MPa	550 MPa
Elongation	25%	26%
CVN Impact Values	84J av @ 0°C	70J av @ 0°C

### RECOMMENDED SHIELDING GASES:

Welding Grade Carbon Dioxide (CO<sub>2</sub>) ISO14175: C1

Argon + 20-25% CO<sub>2</sub> or equivalent 1.6mm ONLY

ISO14175: M21

### Packaging Data:

Wire Diameter (mm)	Type	Pack Weight	Pack Part No.
1.6	Spool	15kg	720904
2.4	Coil	25kg	720906

## VERTI-COR XP



- ▲ Versatile, smooth running, general purpose, rutile type flux cored wire.
- ▲ Now with Grade 3 Shipping Society approvals on mixed gas and CO<sub>2</sub>.
- ▲ Excellent Operator Appeal.
- ▲ All positional capabilities.

### Classifications:

AS 2203.1:	ETP-GMp-W503A. CM1 H10. ETP-GCp-W503A. CM1 H10.
AWS/ASME-SFA A5.20:	E71T-1M H8; E71T-1 H8.

### Description and Applications:

Verti-Cor XP is a versatile rutile type flux cored wire designed for all positional fillet and butt welding applications using Argon +20-25% CO<sub>2</sub> and CO<sub>2</sub> shielding gases. Verti-Cor XP is characterised by its smooth transfer arc characteristic and all positional capabilities while offering smooth genuine mitre fillets in all positions.

Reliable Grade 3 impact properties on both mixed gas and CO<sub>2</sub> are other attributes of Verti-Cor XP.

### Typical Weld Metal Mechanical Properties:

Actual weld metal mechanical properties achieved with Verti-Cor XP are influenced by many factors including, base metal analysis, welding parameters/heat input used, shielding gas selection, number of weld passes and run placement, etc. Please consult your nearest CIGWELD distributor for welding procedure recommendations.

### APPROVALS\*:

Lloyds Register of Shipping	Grade 3S 3YS H10
American Bureau of Shipping	Grade 3SA, 3YSA
Det Norske Veritas	III YMS

\*with Argon + 20-25% CO<sub>2</sub> and CO<sub>2</sub> shielding gases.

### TYPICAL ALL WELD METAL ANALYSIS:

#### Using Argon + 20-25% CO<sub>2</sub>:

C: 0.032%	Mn: 1.44%	Si: 0.59%
S: 0.001%	P: 0.025%	

#### Using CO<sub>2</sub>:

C: 0.029%	Mn: 1.35%	Si: 0.42%
S: 0.012%	P: 0.013%	

### TYPICAL DIFFUSIBLE HYDROGEN LEVELS TO AS3752:

5-6 mls of hydrogen / 100gms of deposited weld metal for as manufactured product using Argon + 20-25% CO<sub>2</sub>.

### TYPICAL ALL WELD METAL MECHANICAL PROPERTIES:

	Using Argon: + 20-25% CO <sub>2</sub>	Using CO <sub>2</sub> :
Yield Stress	550 MPa	510 MPa
Tensile Strength	630 MPa	600 MPa
Elongation	26%	26%
CVN Impact Values 70J av @ 0°C.		60J av @ 0°C

### RECOMMENDED SHIELDING GASES:

- Argon + 20-25% CO<sub>2</sub> or equivalent ISO14175: M21, M24
- Welding Grade CO<sub>2</sub> ISO14175: C1

### Packaging Data:

Wire Diameter (mm)	Type	Pack Weight	Pack Part No.
1.2	Spool	15kg	720915
1.2	Autopak	200kg	720915A
1.6	Spool	15kg	720917
1.6	Autopak	200kg	720917A
2.0	Spool	15kg	720595
2.0	Coil	25kg	720596



### Operating Data:

All welding conditions recommended below are for use with semi-automatic operation, DC electrode positive using Argon + 20-25% CO<sub>2</sub> shielding gas with a flow rate of 15–20 litres/min.

Wire Diameter (mm)	Current Range (amps)	Voltage Range (volts)	CTWD	Welding Positions	
1.2	150-250	23-28	15-20		Flat
1.6	280-400	28-34	25-30		
2.0	400-480	29-32	25-30		
1.2	150-200	23-28	15-20		HV Fillet
1.6	250-350	28-34	25-30		
2.0	350-400	27-31	25-30		
1.2	120-180	22-27	15-20		Vertical up
1.6	200-250	23-27	20-25		
2.0	230-280	24-28	20-25		
1.2	140-180	22-27	15-20		Overhead
1.6	190-250	23-27	20-25		
2.0	220-260	23-27	20-25		

These machine settings are a guide only. Actual voltage, welding current and CTWD used will depend on machine characteristics, plate thickness, run size, shielding gas and operator technique etc.

## VERTI-COR ULTRA



- ▲ Rutile Type Flux Cored Wire Formulated Exclusively for CO<sub>2</sub> Shielding Gas.
- ▲ Versatile, All Positional Capabilities.
- ▲ Excellent Operator Appeal.
- ▲ Low Spatter and Fume Levels.

## Classifications:

AS 2203.1: ETP-GCp-W502A. CM1 H10.  
AWS/ASME-SFA A5.20: E71T-1H8.

## Description and Applications:

Verti-Cor Ultra is a smooth running all positional flux cored wire which offers improved operator appeal and lower fume and spatter levels under welding grade carbon dioxide shielding gas.

Verti-Cor Ultra offers significant welding improvements compared with conventional E71T-1 wires, in particular 50-60% less spatter and ≈ 20% less fume.

Verti-Cor Ultra is designed for the single and multi-pass welding of mild and medium strength steels in the downhand, vertical-up and overhead positions. It is recommended for general steel construction and fabrication welding where the work cannot be rotated to the downhand positions.

## Typical Weld Metal Mechanical Properties:

Actual weld metal mechanical properties achieved with Verti-Cor Ultra are influenced by many factors including, base metal analysis, welding parameters / heat input used, number of weld passes and run placement etc. Please consult your nearest CIGWELD branch for welding procedure recommendations.

## APPROVALS\*:

Lloyds Register of Shipping	Grade 2YS H10.
American Bureau of Shipping	Grade 2YSA H10.
Det Norske Veritas	IYMS H.

\* - with welding grade CO<sub>2</sub> shielding gas.

TYPICAL ALL WELD METAL ANALYSIS USING CO<sub>2</sub> SHIELDING GAS:

C: 0.04%	Mn: 1.24%	Si: 0.70%
Ti: 0.035%	B: 0.005%	

## TYPICAL DIFFUSIBLE HYDROGEN LEVELS TO AS3752:

5.0 - 6.0 mls of hydrogen / 100gms of deposited weld metal \*.

\* - for "as manufactured" product using welding grade CO<sub>2</sub> shielding gas.

## TYPICAL ALL WELD METAL MECHANICAL PROPERTIES:

Using welding grade CO <sub>2</sub> :	
Yield Stress	480 MPa
Tensile Strength	560 MPa
Elongation	28%
CVN Impact Values	80 J av @ 0°C.

## RECOMMENDED SHIELDING GAS:









- Welding Grade CO<sub>2</sub> ISO14175: C1

## Packaging Data:

Wire Diameter (mm)	Type	Pack Weight	Pack Part No.
1.2	Spool	15kg	720900
1.6	Spool	15kg	720902

**Operating Data:**

All welding conditions recommended below are for use with semi-automatic operation, DC electrode positive and welding grade CO<sub>2</sub> shielding gas with a flow rate of 10–15 litres/min.

Wire Diameter (mm)	Current Range (amps)	Voltage Range (volts)	CTWD	Welding Positions
1.2	250-300	27-31	20-25	 Flat
1.6	350-400	27-31	25-30	
1.2	230-280	26-30	20-25	 HV Fillet
1.6	310-360	26-30	25-30	
1.2	170-220	24-28	15-20	 Vertical up
1.6	200-250	24-28	15-20	
1.2	160-210	24-28	15-20	 Overhead
1.6	190-240	24-28	15-20	

These machine settings are a guide only. Actual voltage, welding current and CTWD used will depend on machine characteristics, plate thickness, run size, shielding gas and operator technique etc.

## VERTI-COR 3XP



DC+



- ▲ Microalloyed, Rutile Type Flux Cored Wire.
- ▲ Versatile, All Positional Capabilities.
- ▲ Grade 3 Shipping Society Approvals.

## Classifications:

AS 2203.1:	ETP-GMp-W503A. CM1 H10. ETP-GCp-W503A. CM1 H10.
AWS/ASME-SFA A5.20:	E71T-1 H8 , E71T-12M H8.

## Description and Applications:

Verti-Cor 3XP is a microalloyed rutile type flux cored wire designed for downhand, vertical-up and overhead fillet and butt welding applications.

Formulated to give smooth (low spatter) arc transfer, flat mitre fillet welds and excellent slag lift in all positions (except vertical-down), Verti-Cor 3XP is suitable for welding a wide range of mild and medium strength steels.

For optimum arc performance and weld deposit impact toughness Argon + 20-25% CO<sub>2</sub> or CO<sub>2</sub> shielding gases are recommended.

## Typical Weld Metal Mechanical Properties:

Actual weld metal mechanical properties achieved with Verti-Cor 3XP are influenced by many factors including, base metal analysis, welding parameters / heat input used, shielding gas selection, number of weld passes and run placement etc. Please consult your nearest CIGWELD branch for welding procedure recommendations.

## APPROVALS\*:

Lloyds Register of Shipping	Grade 3S, 3YS H.
American Bureau of Shipping	Grade 3SA, 3YSA H.
Det Norske Veritas	IIYMS H.

\*with Argon + 20-25% CO<sub>2</sub> or CO<sub>2</sub> shielding gases

## TYPICAL ALL WELD METAL ANALYSIS:

Using Argon + 20-25% CO<sub>2</sub>:

C: 0.07%	Mn: 1.16%	Si: 0.52%
Ti: 0.035%	B: 0.008%	

Using CO<sub>2</sub>:

C: 0.06%	Mn: 1.05%	Si: 0.42%
Ti: 0.035%	B: 0.007%	

## TYPICAL DIFFUSIBLE HYDROGEN LEVELS TO AS3752:

5.0–6.0 mls of hydrogen / 100gms of deposited weld metal \*

\* - for "as manufactured" product using Argoshield 52 shielding gas.

## TYPICAL ALL WELD METAL MECHANICAL PROPERTIES:

Using	Argon + 20-25% CO <sub>2</sub> :	CO <sub>2</sub> :
Yield Stress	480 MPa	460 MPa
Tensile Strength	560 MPa	530 MPa
Elongation	28%	30%
CVN,		
Impact Values	110J av @ 0°C.	90J av @ 0°C.
	90J av @ -20°C	75J av @ -20°C

## RECOMMENDED SHIELDING GASES:

- Argon + 20-25% CO<sub>2</sub> or equivalent ISO14175:  
M21, M24, M21 (1)
- Welding Grade CO<sub>2</sub> ISO14175: C1









## Packaging Data:

Wire Diameter (mm)	Type	Pack Weight	Pack Part No.
1.2	Spool	15kg	720919
1.6	Spool	15kg	720921



### Operating Data:

All welding conditions recommended below are for use with semi-automatic operation, DC electrode positive and Argon + 20-25% CO<sub>2</sub> shielding gas with a flow rate of 15–20 litres/min

Wire Diameter (mm)	Current Range (amps)	Voltage Range (volts)	CTWD	Welding Positions
1.2	250-300	27-31	20-25	 Flat
1.6	350-400	27-31	25-30	 Flat
1.2	230-280	26-30	20-25	 HV Fillet
1.6	310-360	26-30	25-30	 HV Fillet
1.2	170-220	24-28	15-20	 Vertical up
1.6	200-250	24-28	15-20	 Vertical up
1.2	160-210	24-28	15-20	 Overhead
1.6	190-240	24-28	15-20	 Overhead

These machine settings are a guide only. Actual voltage, welding current and CTWD used will depend on machine characteristics, plate thickness, run size, shielding gas and operator technique etc.



## VERTI-COR 3XP H4 - Seamless



- ▲ Next generation technology flux cored wire.
- ▲ Copper coated for smooth consistent feedability and current pick up.
- ▲ Rutile, all positional capabilities producing a flat mitre fillet bead shape.
- ▲ Ultra low splatter and fume levels.
- ▲ H4 diffusible hydrogen class with a typical weldmetal of 2.2 mls of hydrogen/100 gms.
- ▲ Excellent Operator Appeal.
- ▲ Grade 3 Shipping Society Approvals.

### Classifications:

AS/NZS 2203.1:	ETP-GMp-W503A. CM1 H5.
AWS/ASME-SFA A5.20:	E71T-12M H4.

### Description and Applications:

Verti-Cor 3XP H4 is a seamless copper coated, rutile type FC wire designed for downhand, vertical-up and overhead fillet and butt welding applications.

Verti-Cor 3XP H4 is suitable for welding a wide range of mild to medium strength steels with Argon + 20-25% CO<sub>2</sub> shielding gases (or equivalent) and is formulated to give smooth, mitre fillet welds in all positions with very low spatter levels and a self-releasing slag.

The advanced seamless copper coated tube technology gives rise to several unique features and benefits including:

- improved wire feeding which eliminates 'bird nests' at the wire feeder
- improved current transfer at the welding torch for smooth, consistent arc starting
- Very low AWS: H4 and AS: H5 diffusible hydrogen status for improved resistance to hydrogen induced cold cracking of the weld deposit
- The elimination of moisture reabsorption in the flux core for maintenance of the 'very low hydrogen status' following exposure to the atmosphere

### TYPICAL ALL WELD METAL MECHANICAL PROPERTIES:

Using Argon + 20-25% CO<sub>2</sub>:

Yield Stress	510 MPa
Tensile Strength	570 MPa
Elongation	30%
CVN,	
Impact Values	105J av @ -20°C

### TYPICAL ALL WELD METAL ANALYSIS:

Using Argon +20-25% CO<sub>2</sub>:

C: 0.05%	Mn: 1.25%	Si: 0.43%
P: 0.009	S: 0.007	

### TYPICAL DIFFUSIBLE HYDROGEN LEVELS TO AS3752:

2.2 mls of hydrogen / 100gms of deposited weld metal \*.  
 \* - for "as manufactured" product using Argon + 20-25% CO<sub>2</sub> shielding gas.

### APPROVALS\*:

Lloyds Register of Shipping	3S, 3YS H5
American Bureau of Shipping	S3A, 3YSA H5
* - with Argon +20-25% CO <sub>2</sub> shielding gas combinations.	

### RECOMMENDED SHIELDING GASES:









• Argon + 20-25% CO <sub>2</sub> .	ISO14175: M21,M24, M21 (1)
------------------------------------	-------------------------------

### Packaging Data:

Dia. (mm)	Wire Type	Pack	
		Weight	Part No.
1.2	Spool	12.5kg	722919
1.6	Spool	12.5kg	722921

**Operating Data:**

All welding conditions recommended below are for use with semi-automatic operation, DC electrode positive and Argon +20-25% CO<sub>2</sub> shielding gas with a flow rate of 15-20 litres/min

Wire Dia. (mm)	Current Range (amps)	Voltage Range (volts)	CTWD	Optimum Amps	Volts		Welding Positions
1.2	250-300	27-31	20-25	280	31		Flat
1.6	350-400	27-31	25-30	360	31		
1.2	230-280	26-30	20-25	260	28		HV Fillet
1.6	310-360	26-30	25-30	320	29		
1.2	170-220	24-28	15-20	200	24		Vertical up
1.6	200-250	24-28	15-20	240	25		
1.2	160-210	24-28	15-20	200	24		Overhead
1.6	190-240	24-28	15-20	220	24		

These machine settings are a guide only. Actual voltage, welding current and CTWD used will depend on machine characteristics, plate thickness, run size, shielding gas and operator technique etc.

## VERTI-COR 81 A1 H4



- ▲ Copper coated seamless wire delivering very low AWS H4 class hydrogen
- ▲ Higher strength low alloy rutile type flux cored wire
- ▲ Formulated for Use with Argon + 20-25% CO<sub>2</sub> or equivalent
- ▲ Versatile, All Positional Capabilities
- ▲ Excellent Operator Appeal
- ▲ Low fume levels

### Classifications:

AS 2203.1: ETP-GMp-W553 A1 H5.  
 AWS/ASME-SFA A5.29: E81T1-1 A1 M H4

### Description and Applications:

Verti-Cor 81 A1 H4 is a seamless copper coated rutile type flux cored wire suitable for the all positional welding of medium to high strength steels using Argon + 20-25% CO<sub>2</sub>. Verti-Cor 81 A1 H4 produces a low alloy (nominally 0.5% Mo) steel weld deposit of the 550 MPa tensile class. Verti-Cor 81 A1 H4 is easy to use in all positions and produces smooth arc transfer characteristics, low spatter levels, mitre fillet welds and a full covering, easily releasing slag, similar to Verti-Cor Ni1 H4.









Verti-Cor 81 A1 H4 is suitable for the fillet and butt welding of a broad range of higher strength steels in all welding positions except vertical down. Typical applications include the welding of creep resisting steels used in the pressure vessel and petrochemical industries.

### Typical Weld Metal Mechanical Properties:

Actual weld metal mechanical properties achieved with Verti-Cor 81 A1 H4 are influenced by many factors including, base metal analysis, welding parameters / heat input used, shielding gas selection, number of weld passes and run placement etc. Please consult your nearest CIGWELD branch for welding procedure recommendations.

### Operating Data:

All welding conditions recommended below are for use with semi-automatic operation, DC electrode positive and Argon + 20-25% CO<sub>2</sub> shielding gas with a flow rate of 15-20 litres/min.

Wire Diameter (mm)	Current Range (amps)	Voltage Range (volts)	CTWD	Welding Positions	
1.2	250-300	27-31	20-25		Flat
1.6	350-400	27-31	25-30		
1.2	230-280	26-30	20-25		HV Fillet
1.6	310-360	26-30	25-30		
1.2	170-220	24-28	15-20		Vertical up
1.6	200-250	24-28	15-20		
1.2	160-210	24-28	15-20		Overhead
1.6	190-240	24-28	15-20		

These machine settings are a guide only. Actual voltage, welding current and CTWD used will depend on machine characteristics, plate thickness, run size, shielding gas and operator technique etc.

### TYPICAL ALL WELD METAL ANALYSIS:

C: 0.085% Mn: 1.05% Si: 0.52%  
 S: 0.01% Mo: 0.5%

### TYPICAL DIFFUSIBLE HYDROGEN LEVELS TO AS3752:

3< mls of hydrogen / 100gms of deposited weld metal\*.

\*for "as manufactured" product using Argon + 20-25% CO<sub>2</sub> shielding gas.

### TYPICAL ALL WELD METAL MECHANICAL PROPERTIES:

Using Argon + 20-25% CO<sub>2</sub>:

Yield Stress	470 MPa
Tensile Strength	630 MPa
Elongation	22%
CVN Impact Values	50J av @ -20°C

### RECOMMENDED SHIELDING GAS:

• Argon + 20-25% CO<sub>2</sub> or equivalent ISO14175: M21, M24

### Packaging Data:

Wire Diameter (mm)	Type	Pack Weight	Pack Part No.
* 1.2	Spool	15kg	720557
* 1.6	Spool	15kg	720558

\*Non-stock item. Available on indent only.

## VERTI-COR 81 Ni1

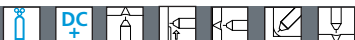

- ▲ Higher Strength Low Alloy, Rutile Type Flux Cored Wire
- ▲ Formulated for Use with Argon + 20-25% CO<sub>2</sub> or equivalent.
- ▲ Versatile, All Positional Capabilities.
- ▲ Excellent Operator Appeal.
- ▲ Improved vertical performance.

### Classifications:

AS 2203.1: ETP-GMP-W554A. Ni1 H10.  
AWS/ASME-SFA A5.29: E81T1-Ni1MH8

### Description and Applications:

Verti-Cor 81 Ni1 is a microalloyed, rutile type flux cored wire suitable for the all positional welding ( flat, horizontal-vertical, vertical-up and overhead etc) of medium to high strength steels. Formulated for use with Argon + 20-25% CO<sub>2</sub> shielding gas, Verti-Cor 81 Ni1 produces a low alloy ( nominally 1.0% Nickel ) steel weld deposit of the 550 MPa tensile class. Verti-Cor 81 Ni1 is easy-to-use in all positions and produces smooth arc transfer characteristics, low spatter levels, mitre fillet welds and a full covering easy releasing slag, similar to Verti-Cor 3XP.









Verti-Cor 81 Ni1 is suitable for the fillet and butt welding of a broad range of higher strength steels in all welding positions, except vertical-down. Typical applications include the under matching strength fillet welding of Bisalloy 60, 70 and 80 Quenched and Tempered steels.

### Typical Weld Metal Mechanical Properties:

Actual weld metal mechanical properties achieved with Verti-Cor 81 Ni1 are influenced by many factors including, base metal analysis, welding parameters / heat input used, shielding gas selection, number of weld passes and run placement etc. Please consult your nearest CIGWELD branch for welding procedure recommendations.

### Operating Data:

All welding conditions recommended below are for use with semi-automatic operation, DC electrode positive and Argon + 20-25% CO<sub>2</sub> shielding gas with a flow rate of 15–20 litres/min.

Wire Diameter (mm)	Current Range (amps)	Voltage Range (volts)	CTWD	Welding Positions
1.2	250-300	27-31	20-25	 Flat
1.6	350-400	27-31	25-30	
1.2	230-280	26-30	20-25	 HV Fillet
1.6	310-360	26-30	25–30	
1.2	170-220	24-28	15-20	 Vertical up
1.6	200-250	24-28	15-20	
1.2	160-210	24-28	15-20	 Overhead
1.6	190-240	24-28	15-20	

These machine settings are a guide only. Actual voltage, welding current and CTWD used will depend on machine characteristics, plate thickness, run size, shielding gas and operator technique etc.

### TYPICAL ALL WELD METAL ANALYSIS\*:

C: 0.06% Mn: 1.35% Si: 0.35%  
Ni: 0.90% Ti: 0.035% B: 0.007%.

\*Using Argon + 20-25% CO<sub>2</sub> shielding gas

### TYPICAL DIFFUSIBLE HYDROGEN LEVELS TO AS3752:

5.0–6.0 mls of hydrogen / 100gms of deposited weld metal\*.

\*for "as manufactured" product using Argon + 20-25% CO<sub>2</sub> shielding gas.

### TYPICAL ALL WELD METAL MECHANICAL PROPERTIES:

Using Argon + 20-25% CO<sub>2</sub>:  
Yield Stress 520 MPa  
Tensile Strength 600 MPa  
Elongation 26%  
CVN Impact Values 65J av @ -40°C

### RECOMMENDED SHIELDING GAS:

- Argon + 20-25% CO<sub>2</sub> or equivalent ISO14175: M21

### Packaging Data:

Wire Diameter (mm)	Type	Pack Weight	Pack Part No.
1.2	Spool	15kg	720390
1.6	Spool	15kg	720391

## VERTI-COR 81 Ni1 H4



- ▲ Higher Strength Low Alloy, Rutile Type Flux Cored Wire.
- ▲ Copper coated for smooth consistent feedability and current pick up.
- ▲ Formulated for use with either Argon + 20-25% CO<sub>2</sub> or CO<sub>2</sub> shielding gases.
- ▲ Versatile, All Positional Capabilities.
- ▲ Outstanding Operator Appeal.
- ▲ Low Fume Levels.
- ▲ Precision Layer Wound.

### Classifications:

AS 2203.1: ETP-GC/Mp-W554A. Ni1 H5  
 AWS/ASME-SFA A5.29: E81T1-Ni1M H4; E81T1-Ni1 H4

### Description and Applications:

Verti-Cor 81 Ni1 H4 is a higher strength rutile type flux cored wire suitable for the all positional welding of medium to high strength steels using Argon + 20-25% CO<sub>2</sub> or CO<sub>2</sub> shielding gases.

Verti-Cor 81 Ni1 H4 produces a low alloy (nominally 1% Nickel) steel weld deposit of the 550 Mpa tensile class. It is easy to use in all positions and produces smooth arc transfer characteristics, low spatter levels, mitre fillet welds and a full covering, easily releasing slag, similar to Verti-Cor 3XP.

Verti-Cor 81 Ni1 H4 is suitable for the fillet and butt welding of a broad range of higher strength steels in all welding positions except vertical down. Typical applications include the under matching strength welding of Bisalloy 60,70 & 80.

The advanced seamless copper coated tube technology gives rise to several unique features and benefits including:

- Improved wire feeding which eliminates "bird nests" at the wirefeeder
- Improved current transfer at the welding torch for smooth, consistent arc starting
- "Very low AWS: H4 and AS: H5 diffusible hydrogen status for improved resistance to hydrogen induced cold cracking of the weld deposit.

### Typical Weld Metal Mechanical Properties:

Actual weld metal mechanical properties achieved with Verti-Cor 81 Ni1 H4 are influenced by many factors including, base metal analysis, welding parameters/heat input used, shielding gas selection, number of weld passes and run placement, etc. Please consult your nearest CIGWELD distributor for welding procedure recommendations.

### APPROVALS\*:

Lloyds Register of Shipping	Grade 4Y, 4YS H10.
American Bureau of Shipping	Grade 4YSA H5.
Det Norske Veritas	IV YMS H10.

\*with Argon + 20-25% CO<sub>2</sub> or CO<sub>2</sub> shielding gases

### TYPICAL ALL WELD METAL ANALYSIS\*:

Using Argon + 20-25% CO<sub>2</sub>:

C: 0.06% Mn: 1.40% Si: 0.5% Ni: 1.0%

Using CO<sub>2</sub>:

C: 0.05% Mn: 1.1% Si: 0.38% Ni: 1.16%

### TYPICAL DIFFUSIBLE HYDROGEN LEVELS TO AS3752:

<3 mls of hydrogen / 100gms of deposited weld metal for as manufactured product using Argon +20-25% CO<sub>2</sub> or CO<sub>2</sub>.

### TYPICAL ALL WELD METAL MECHANICAL PROPERTIES:

Using	Argon + 20-25% CO <sub>2</sub> :	CO <sub>2</sub> :
Yield Stress	540 MPa	500 MPa
Tensile Strength	600 MPa	560 MPa
Elongation	22%	23%
CVN Impact Values	85J av @ -40°C	75J av @ -50°C

### RECOMMENDED SHIELDING GAS:

- Ar + 20-25% CO<sub>2</sub> or equivalent ISO14175: M21, M24
- Welding Grade CO<sub>2</sub> ISO14175: C1

### Packaging Data:

Wire Diameter (mm)	Type	Pack Weight	Pack Part No.
1.2	Spool	15kg	720550
1.6	Spool	15kg	720551
2.0	Spool	15kg	720591
2.0	Coil	25kg	720592

**Operating Data:**

All welding conditions recommended below are for use with semi-automatic operation, DC electrode positive and Argon + 20-25% CO<sub>2</sub> shielding gas with a flow rate of 15-20 litres/min.

Wire Diameter (mm)	Current Range (amps)	Voltage Range (volts)	CTWD	Welding Positions	
1.2	250-300	27-31	20-25		Flat
1.6	350-400	27-31	25-30		
2.0	380-460	28-32	25-30		
1.2	230-280	26-30	20-25		HV Fillet
1.6	310-360	26-30	25-30		
2.0	340-420	27-31	25-30		
1.2	170-220	24-28	15-20		Vertical up
1.6	200-250	24-28	15-20		
2.0	220-280	24-28	20-25		
1.2	160-210	24-28	15-20		Overhead
1.6	190-240	24-28	15-20		
2.0	210-270	23-27	20-25		

These machine settings are a guide only. Actual voltage, welding current and CTWD used will depend on machine characteristics, plate thickness, run size, shielding gas and operator technique etc.

## VERTI-COR 81 Ni2



- ▲ Higher Strength Low Alloy, Rutile Type Flux Cored Wire.
- ▲ Formulated for use with either Argon + 20-25% CO<sub>2</sub> or CO<sub>2</sub> shielding gases.
- ▲ Versatile, All Positional Capabilities.
- ▲ Outstanding Operator Appeal.
- ▲ Low Fume Levels.

## Classifications:

AS 2203.1: ETP-G/Mp-W559A.Ni2 H10  
 AWS/ASME-SFA A5.29: E81T1-Ni2M H8

## Description and Applications:

Verti-Cor 81 Ni2 is a higher strength rutile type flux cored wire suitable for the all positional welding of medium to high strength steels using Argon + 20-25% CO<sub>2</sub> or equivalent.

Verti-Cor 81 Ni2 produces a low alloy (nominally 2% Nickel) steel weld deposit of the 550 Mpa tensile class. It is easy to use in all positions and produces smooth arc transfer characteristics, low spatter levels, mitre fillet welds and a full covering, easily releasing slag, similar to Verti-Cor 81 Ni1.

Verti-Cor 81 Ni2 is suitable for the fillet and butt welding of a broad range of higher strength steels in all welding positions except vertical down. Typical applications include the under matching strength welding of Bisalloy 60,70 & 80 and aluminium killed steels for low temperature service such as off shore platforms.

## Typical Weld Metal Mechanical Properties:

Actual weld metal mechanical properties achieved with Verti-Cor 81 Ni1 H4 are influenced by many factors including, base metal analysis, welding parameters/heat input used, shielding gas selection, number of weld passes and run placement, etc. Please consult your nearest CIGWELD distributor for welding procedure recommendations.

## APPROVALS\*:

Lloyds Register of Shipping  
 American Bureau of Shipping  
 Det Norske Veritas

\*with Argon + 25% CO<sub>2</sub> shielding gases

## TYPICAL ALL WELD METAL ANALYSIS:

Using Argon + 25% CO<sub>2</sub>:

C: 0.02% Mn: 1.16% Si: 0.51% Ni: 2.0%

## TYPICAL DIFFUSIBLE HYDROGEN LEVELS TO AS3752:

<8 mls of hydrogen / 100gms of deposited weld metal for as manufactured product using Argon +25% CO<sub>2</sub>.

## TYPICAL ALL WELD METAL MECHANICAL PROPERTIES:

Using	Argon + 25%CO <sub>2</sub> :
Yield Stress	590 MPa
Tensile Strength	660 MPa
Elongation	27%
CVN Impact Values	70J av @ -40°C

## RECOMMENDED SHIELDING GAS:





- Ar + 20-25% CO<sub>2</sub> or equivalent ISO14175: M21, M24

## Packaging Data:

Wire Diameter (mm)	Type	Pack Weight	Pack Part No.
1.2	Spool	15kg	722390
1.6	Spool	15kg	722391

**Operating Data:**

All welding conditions recommended below are for use with semi-automatic operation, DC electrode positive and Argon + 25% CO<sub>2</sub> shielding gas with a flow rate of 15-20 litres/min.

Wire Diameter (mm)	Current Range (amps)	Voltage Range (volts)	CTWD	Welding Positions
1.2	250-300	27-31	20-25	 Flat
1.6	350-400	27-31	25-30	
1.2	230-280	26-30	20-25	 HV Fillet
1.6	310-360	26-30	25-30	
1.2	170-220	24-28	15-20	 Vertical up
1.6	200-250	24-28	15-20	
1.2	160-210	24-28	15-20	 Overhead
1.6	190-240	24-28	15-20	

These machine settings are a guide only. Actual voltage, welding current and CTWD used will depend on machine characteristics, plate thickness, run size, shielding gas and operator technique etc.



## VERTI-COR 91 K2 H4



- ▲ Copper coated seamless wire delivering very low H4 class hydrogen levels.
- ▲ Higher Strength Low Alloy, Rutile Type Flux Cored Wire
- ▲ Formulated for Use with Argon + 20-25% CO<sub>2</sub>.
- ▲ Very low hydrogen status.
- ▲ Low fume levels.

**Classifications:**

AS 2203.1: ETP-GMP-W629A. K2 H5.  
 AWS/ASME-SFA A5.29: E91T1-K2M H4

**Description and Applications:**

Verti-Cor 91 K2 H4 is a higher strength rutile type flux cored wire suitable for the all positional welding of medium to high strength steels using Argon + 20-25% CO<sub>2</sub> shielding gas. Verti-Cor 91 K2 H4 produces a low alloy (nominally 1.5% Nickel) steel weld deposit of the 550 Mpa tensile class. It is easy to use in all positions and produces smooth arc transfer characteristics, low spatter levels, mitre fillet welds and a full covering, easily releasing slag, similar to Verti-Cor 3XP H4.

Verti-cor 91 K2 H4 is suitable for the fillet and butt welding of a broad range of higher strength steels in all welding positions, except vertical-down. Typical applications include the full strength butt welding of Bisalloy 60 or the under matching strength fillet welding of Bisalloy 70 and 80 steels.

The advanced seamless copper coated tube technology gives rise to several unique features and benefits including:

- Improved wire feeding which eliminates "bird nests" at the wirefeeder
- Improved current transfer at the welding torch for smooth, consistent arc starting
- "Very low AWS: H4 and AS: H5 diffusible hydrogen status for improved resistance to hydrogen induced cold cracking of the weld deposit.

**Typical Weld Metal Mechanical Properties:**

Actual weld metal mechanical properties achieved with Verti-Cor 91 K2 H4 are influenced by many factors including, base metal analysis, welding parameters / heat input used, shielding gas selection, number of weld passes and run placement etc. Please consult your nearest CIGWELD branch for welding procedure recommendations.

**Operating Data:**

All welding conditions recommended below are for use with semi-automatic operation, DC electrode positive and Argon + 20-25% CO<sub>2</sub> shielding gas with a flow rate of 15–20 litres/min.

Wire Diameter (mm)	Current Range (amps)	Voltage Range (volts)	CTWD	Welding Positions	
1.2	250-300	27-31	20-25		Flat
1.6	350-400	27-31	25-30		
1.2	230-280	26-30	20-25		HV Fillet
1.6	310-360	26-30	25-30		
1.2	170-220	24-28	15-20		Vertical up
1.6	200-250	24-28	15-20		
1.2	160-210	24-28	15-20		Overhead
1.6	190-240	24-28	15-20		

These machine settings are a guide only. Actual voltage, welding current and CTWD used will depend on machine characteristics, plate thickness, run size, shielding gas and operator technique etc.

**TYPICAL ALL WELD METAL ANALYSIS\*:**

C: 0.05% Mn: 1.3% Si: 0.3% Ni: 1.2%

\*Using Argon + 20-25% CO<sub>2</sub> shielding gas

**TYPICAL DIFFUSIBLE HYDROGEN LEVELS TO AS3752:**

<3.5 mls of hydrogen / 100gms of deposited weld metal \*

\* for "as manufactured" product using Argon + 20-25% CO<sub>2</sub> shielding gas.

**TYPICAL ALL WELD METAL MECHANICAL PROPERTIES:**

Using Argon + 20-25% CO<sub>2</sub>:

Yield Stress	560 MPa
Tensile Strength	670 MPa
Elongation	22%
CVN Impact Values	>40J av @ -40°C

**RECOMMENDED SHIELDING GAS:**

- Argon + 20-25% CO<sub>2</sub> or equivalent ISO14175: M21, M24

**Packaging Data:**

Wire Diameter (mm)	Type	Pack Weight	Pack Part No.
1.2	Spool	15kg	720554
1.6	Spool	15kg	720555



- ▲ Rutile Type, Low Alloy Steel Flux Cored Wire.
- ▲ Versatile, All Positional Capabilities.
- ▲ Structural Welding of High Strength Steels.
- ▲ Formulated for Use with Argon + 20-25% CO<sub>2</sub> or equivalent gases.
- ▲ Precision Layer Wound on 15kg Steel Spools.
- ▲ Very low hydrogen status.

### Classifications:

AS 2203.1: ETP-GMP-W768A. K3 H5.  
AWS/ASME-SFA A5.29: E111T1-K3M H4.

### Description and Applications:

Verti-cor 111 K3 H4 is a rutile based, low alloy flux cored wire suitable for the all positional (except vertical down) welding of high strength steels. Formulated for use with Argon + 20 - 25% CO<sub>2</sub> or equivalent shielding gases, Verti-cor 111 K3 H4 produces a low alloy steel (nominally 2.0% Nickel, 1.7% Manganese and 0.5% Molybdenum) weld deposit of the 760MPa tensile class.

Verti-cor 111 K3 H4 is easy to use in all positions and produces smooth and stable arc transfer characteristics, low spatter levels, mitre fillet welds and a full covering self-releasing slag. The high strength weld deposits and all positional capabilities make Verti-cor 111 K3 H4 the ideal choice for the full strength butt and fillet welding of Bisalloy 80 and similar Quenched and Tempered steels.





Note: Verti-Cor 111 K3 H4 is not recommended for the crack repair of high strength steel castings. Fully basic consumables such as Alloycraft 110 electrodes or Tensi-cor 110TXP H4 flux cored wire are recommended for this application.

### Typical All Weld Metal Mechanical (AWM) Properties:

Actual weld metal mechanical properties achieved with Verti-cor 111 K3 H4 are influenced by many factors including, base metal analysis, welding parameters / heat input used, shielding gas selection, number of weld passes and run placement etc. Please consult your nearest CIGWELD branch for welding procedure recommendations.

### Operating Data:

All welding conditions recommended below are for use with semi-automatic operation, DC electrode positive and Argoshield 52 shielding gas with a flow rate of 15–20 litres/min.

Wire Diameter (mm)	Current Range (amps)	Voltage Range (volts)	CTWD	Welding Positions
1.2	250-300	27-31	20-25	 Flat
1.6	350-400	27-31	25-30	
1.2	230-280	26-30	20-25	 HV Fillet
1.6	310-360	26-30	25–30	
1.2	170-220	24-28	15-20	 Vertical up
1.6	200-250	24-28	15-20	
1.2	160-210	24-28	15-20	 Overhead
1.6	190-240	24-28	15-20	

These machine settings are a guide only. Actual voltage, welding current and E.S.O. used will depend on machine characteristics, plate thickness, run size, shielding gas and operator technique etc.

### TYPICAL ALL WELD METAL (AWM) ANALYSIS\* (Wt%):

C: 0.06% Mn: 1.65% Si: 0.36%  
Ni: 2.05% Mo: 0.46% B: 0.004%.

\* - Using Argoshield 52 shielding gas

### TYPICAL DIFFUSIBLE HYDROGEN LEVELS TO AS3752:

3.0 mls of hydrogen / 100gms of deposited weld metal \*.

\* - for "as manufactured" product using and Electrode Stickout (ESO) of 20mm with 1.2mm wire and 25mm with 1.6mm wire and mid-range current and voltage settings.

### TYPICAL ALL WELD METAL MECHANICAL PROPERTIES:

Using Argoshield 52:  
0.2% Proof Stress 775 MPa  
Tensile Strength 835 MPa  
Elongation 18%  
CVN Impact Values 55J av @ -20°C

### RECOMMENDED SHIELDING GAS:

• Argon + 20-25%CO<sub>2</sub> or equivalent ISO14175: M21 M24.

### Packaging Data:

Wire Diameter (mm)	Type	Pack Weight	Pack Part No.
1.2	Spool	15kg	721381
1.6	Spool	15kg	721382

## SUPRE-COR 5

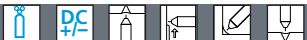

- ▲ Second Generation, Fully Basic Flux Cored Wire.
- ▲ Improved Low Temperature Impact Toughness to  $-50^{\circ}\text{C}$ .
- ▲ Improved Positional Capabilities of 1.2mm and 1.6mm sizes.
- ▲ Precision Layer Wound.

## Description Classifications:

AS 2203.1:	ETP-GCn/p-W505A. CM1 H5. ETP-GMn/p-W505A. CM1 H5.
AWS/ASME-SFA A5.20:	E71T-5 H4, E71T-5MJ H4.

## Description and Applications:

Supre-Cor 5 is a second generation, fully basic flux cored wire producing outstanding low temperature impact properties using  $\text{CO}_2$ , Argon or equivalent shielding gases. For all welding applications with Supre-Cor 5 electrode negative is the preferred polarity.

The premium quality weld metal and 'very low' hydrogen class of Supre-Cor 5 make it suitable for a wide range of critical applications including the fillet and butt welding of pressure vessels, offshore oil and gas platform structures and heavy earth moving equipment. Excellent weld deposit properties are achieved in both the 'as welded' and 'stress relieved' conditions.

## APPROVALS\*:

Lloyds Register of Shipping	Grade 3S, 3YS H10
American Bureau of Shipping	Grade 3SA, 3YSA H10
Det Norske Veritas	III YMS H10

\*with Argon + 20-25%  $\text{CO}_2$  shielding gas.

## TYPICAL ALL WELD METAL ANALYSIS:

Using Argon + 20-25%  $\text{CO}_2$ :

C: 0.07%      Mn: 1.38%      Si: 0.74%

Using  $\text{CO}_2$ :

C: 0.07%      Mn: 1.23%      Si: 0.56%

## TYPICAL DIFFUSIBLE HYDROGEN LEVELS TO AS3752:

<2.5 mls of hydrogen / 100gms of deposited weld metal .

## TYPICAL ALL WELD METAL MECHANICAL PROPERTIES:

	Argon + 20-25% $\text{CO}_2$ :	Using $\text{CO}_2$ :
Yield Stress	490 MPa	470 MPa
Tensile Strength	550 MPa	530 MPa
Elongation	28%	32%
CVN Impact Values	90J av @ $-51^{\circ}\text{C}$	80J av @ $-51^{\circ}\text{C}$

## RECOMMENDED SHIELDING GASES:





- Argon + 20-25%  $\text{CO}_2$  or equivalent      ISO14175: M21, M24
- Welding Grade  $\text{CO}_2$       ISO14175: C1

## Packaging Data:

Wire Diameter (mm)	Type	Pack Weight	Pack Part No.
1.2	Spool	15kg	720982
1.6	Spool	15kg	720983

**Operating Data:**

All welding conditions recommended below are for use with semi-automatic operation and DC electrode negative using Argon + 20-25% CO<sub>2</sub> shielding gas with a flow rate of 15-20 litres/min.

Wire Diameter (mm)	Current Range (amps)	Voltage Range (volts)	CTWD	Welding Positions
1.2	250-300	26-30	20-25	 Flat
1.6	330-380	26-30	25-30	
1.2	230-280	25-29	20-25	 HV Fillet
1.6	310-360	25-29	25-30	
1.2	160-210	23-27	15-20	 Vertical up
1.6	180-230	23-27	15-20	
1.2	160-210	23-27	15-20	 Overhead
1.6	180-230	23-27	15-20	

These machine settings are a guide only. Actual voltage, welding current and CTWD used will depend on machine characteristics, plate thickness, run size, shielding gas and operator technique etc.

## SUPRE-COR XP H4



- ▲ Next generation, fully basic copper coated tubular flux cored wire.
- ▲ Very Low H4 Hydrogen Status.
- ▲ Copper coating improves feedability, electrical conductivity and consumable parts life.
- ▲ Reliable Low Temperature Impact Toughness to  $-40^{\circ}\text{C}$ .

### Classifications:

AS 2203.1:	ETD-GCnp-W504A. CM1 H5. ETD-GMnp-W504A. CM1 H5.
AWS/ASME-SFA A5.20:	E70T-5 H4, E70T-5M H4.

### Description and Applications:

Supre-Cor XP H4 is a tubular, copper coated basic flux cored wire recommended for use with Argon + 20 - 25%CO<sub>2</sub> and CO<sub>2</sub> (or equivalent) shielding gases. Supre-Cor XP H4 is available in 2.4mm size only and is suitable for the downhand fillet and butt welding of heavy earthmoving and mining equipment. Supre-Cor XP H4 has an easily removable slag covering an excellent bead shape and low spatter level for a fully basic wire. The advanced seamless copper coated tube technology gives rise to several unique features and benefits including:



- improved wire feeding which eliminates 'bird nests' at the wire feeder
- Improved current transfer at the welding torch for smooth, consistent arc starting
- Very low AWS: H4 and AS: H5 diffusible hydrogen status for improved resistance to hydrogen induced cold cracking of the weld deposit.

Typical Weld Metal Mechanical Properties:

Actual weld metal mechanical properties achieved with Supre-Cor XP are influenced by many factors including, base metal analysis, welding parameters / heat input used, shielding gas selection, number of weld passes and run placement etc.

### Operating Data:

All welding conditions recommended below are for use with semi-automatic operation and DC electrode positive using Argon + 20-25% CO<sub>2</sub> shielding gas with a flow rate of 15-20 litres/min.

Wire Diameter (mm)	Current Range (amps)	Voltage Range (volts)	CTWD	Welding Positions
2.4	350-500	27-33	25-30	 Flat
2.4	350-500	27-33	25-30	 HV Fillet

These machine settings are a guide only. Actual voltage, welding current and CTWD used will depend on machine characteristics, plate thickness, run size, shielding gas and operator technique etc.

### APPROVALS\*:

Lloyds Register of Shipping	Grade 3S, 4YS H5
American Bureau of Shipping	Grade 4SA, 4YSA H5
Det Norske Veritas	IV YMS H5

\*with Argon + 20-25% CO<sub>2</sub> shielding gas combinations.

### TYPICAL ALL WELD METAL ANALYSIS:

Using Argon + 20-25% CO <sub>2</sub> :				
C: 0.06%	Mn: 1.5%	Si: 0.5%	P: 0.25%	S: 0.025%.
Using CO <sub>2</sub> :				
C: 0.06%	Mn: 1.2%	Si: 0.5%	P: 0.012%	S: 0.012%.

### TYPICAL DIFFUSIBLE HYDROGEN LEVELS TO AS3752:

<3 mls of hydrogen / 100gms of deposited weld metal for as manufactured product using Argon + 20-25% CO<sub>2</sub>.

### TYPICAL ALL WELD METAL MECHANICAL PROPERTIES:

Using Argon + 20-25% CO <sub>2</sub> :	CO <sub>2</sub> :
Yield Stress 440 MPa	430 MPa
Tensile Strength 550 MPa	540 MPa
Elongation 24%	25%
CVN Impact 100J av @ $-40^{\circ}\text{C}$	90J av @ $-40^{\circ}\text{C}$
Values	

### RECOMMENDED SHIELDING GASES:

- Argon + 20-25% CO<sub>2</sub> or equivalent ISO14175: M21, M24
- Welding Grade CO<sub>2</sub> ISO14175: C1

### Packaging Data:

Wire Diameter (mm)	Type	Pack Weight	Pack Part No.
2.4	Coil	25kg	720911

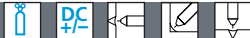

- ▲ Grade 3 Shipping Society Approvals.
- ▲ Low Slag, Metal Cored Wire.
- ▲ High Deposition Efficiency ~95%.
- ▲ High Deposition Rates.
- ▲ Precision Layer Wound.

### Classifications:

AS 2203.1:	ETD-GMn/p-W503A. CM1 H5. ETP*-GMn/p-W503A. CM1 H5. (* 1.2mm only)
AWS/ASME-SFA A5.18:	E70C-6M H4

### Description and Applications:

Now with Grade 3 Shipping Society approvals, Metal-Cor XP is a full iron powder cored wire recommended for a wide range of high speed fillet and butt welding applications in all downhand positions.

1.2mm Metal-Cor XP can also be used in "short arc" or pulsed transfer mode to facilitate welding in all positions. Combining the high deposition rates of a flux cored wire and the high efficiency of a solid wire, Metal-Cor XP is ideal for the high productivity fillet and butt welding of mild and medium strength carbon steels. Metal-Cor XP produces low fume levels. The smooth "spray arc transfer" gives very low spatter levels and excellent weld metal edge wetting for exceptional operator appeal.

For optimum impact properties, Metal-Cor XP is recommended for use with DC electrode negative polarity.

Metal-Cor XP is formulated for use with Argon + 20-25% CO<sub>2</sub> or equivalent shielding gas.

### APPROVALS\*:

Lloyds Register of Shipping	Grade 3S, 3YS
American Bureau of Shipping	Grade 3SA, 3YSA
Det Norske Veritas	III YMS

\*with Argon + 20-25% CO<sub>2</sub> shielding gas or equivalent.

### TYPICAL ALL WELD METAL ANALYSIS\*:

Using Argon + 20-25% CO <sub>2</sub> :		
C: 0.03%	Mn: 1.45%	Si: 0.6%

### TYPICAL ALL WELD METAL MECHANICAL PROPERTIES:

Using Argon + 20-25% CO <sub>2</sub> :	
Yield Stress.	530 MPa.
Tensile Strength	590 MPa.
Elongation	28%
CVN Impact Values	55J av @ -30°C.

### RECOMMENDED SHIELDING GASES:



- Argon + 20-25% CO<sub>2</sub> or equivalent ISO14175: M21, M24

### Packaging Data:

Wire Diameter (mm)	Type	Pack Weight	Pack Part No.
1.0	Spool	15kg	720960
1.2	Spool	15kg	720912
1.6	Spool	15kg	720913
1.6	Autopak	200kg	720913A

**Operating Data:**

All welding conditions recommended below are for use with semi-automatic operation, DC electrode negative using Argon + 20-25% CO<sub>2</sub> shielding gas with a flow rate of 15–20 litres/min.

Wire Diameter (mm)	Current Range (amps)	Voltage Range (volts)	CTWD	Welding Positions
1.0	200-260	27-30	20-25	 Flat
1.2	280-350	28-33	20-25	
1.6	350-450	29-33	25-30	
1.0	170-220	26-28	20-25	 HV Fillet
1.2	250-300	27-31	20-25	
1.6	300-380	27-31	25-30	
1.0	170-220	26-28	20-25	 Horizontal
1.2	250-300	27-31	20-25	
1.6	300-380	27-31	25-30	

These machine settings are a guide only. Actual voltage, welding current and CTWD used will depend on machine characteristics, plate thickness, run size, shielding gas and operator technique etc.



- ▲ High Efficiency Metal Cored Wire with Excellent Operator Appeal.
- ▲ Grade 4 Shipping Society Approvals.
- ▲ Very Low Slag Formation.
- ▲ Outstanding Low Temperature Impact Properties.
- ▲ High Deposition Efficiency.
- ▲ High Deposition Rates.
- ▲ Precision Layer Wound.

### Classifications:

AS 2203.1:	ETD-GMp-W505A. CM1 H5. ETP*-Gmp-W505A. CM1 H5. (*1.2mm only)
AWS/ASME-SFA A5.18:	E70C-6M H4

### Description and Applications:



Metal-Cor 5 is a next generation metal cored wire offering the operator appeal of a metal cored wire with deposition rates similar to that of solid wire and combining impressive low temperature impact values comparable to those of a Grade 5 wire. Metal-Cor 5 offers a wide range of operating parameters and is ideal for high productivity welding of mild and medium strength carbon steels. Metal-Cor 5 produces low fume levels, low spatter and excellent edge wetting for outstanding operator appeal.

For optimum performance Metal-Cor 5 is recommended for use on DC electrode positive polarity (DC EP). Metal-Cor 5 is formulated for use with Argon + 20-25% CO<sub>2</sub> or equivalent shielding gas

\*1.2mm Metal-Cor 5 can be used in short arc or pulsed transfer to facilitate welding in all positions.

### Operating Data:

All welding conditions recommended below are for use with semi-automatic operation, DC electrode positive using Argon + 20-25% CO<sub>2</sub> shielding gas with a flow rate of 15–20 litres/min.

Wire Diameter (mm)	Current Range (amps)	Voltage Range (volts)	CTWD	Welding Positions
1.2	280-350	28-33	20-25	 Flat
1.6	350-450	29-33	25-30	
1.2	250-300	27-31	20-25	 HV Fillet
1.6	300-380	27-31	25-30	
1.2	250-300	27-31	20-25	 Horizontal
1.6	300-380	27-31	25-30	

These machine settings are a guide only. Actual voltage, welding current and CTWD used will depend on machine characteristics, plate thickness, run size, shielding gas and operator technique etc.

### APPROVALS\*:

Lloyds Register of Shipping	Grade 3S, 4YS H5
American Bureau of Shipping	Grade 4SA, 4YSA H5
Det Norske Veritas	IV YMS H5

\*with Argon + 20-25% CO<sub>2</sub> shielding gas or equivalent.

### TYPICAL ALL WELD METAL ANALYSIS\*:

Using Argon + 20-25% CO<sub>2</sub>:

C: 0.07%	Mn: 0.9%	Si: 0.56%	S: 0.014%
P: 0.013%	Ni: 0.04%	Cr: 0.03%	

### TYPICAL DIFFUSIBLE HYDROGEN LEVELS TO AS3752:

<3.5 mls of hydrogen / 100gms of deposited weld metal.

### TYPICAL ALL WELD METAL MECHANICAL PROPERTIES:

Using Argon + 20-25% CO<sub>2</sub>:

Yield Stress.	460 MPa.
Tensile Strength	530 MPa.
Elongation	32%
CVN Impact Values	135J av @ -20°C. 135J av @ -40°C 80J av @ -60°C.

### RECOMMENDED SHIELDING GASES:

- Argon + 20-25% CO<sub>2</sub> or equivalent ISO14175: M21, M24

### Packaging Data:

Wire Diameter (mm)	Type	Pack Weight	Pack Part No.
1.2	Spool	15kg	720552
1.6	Spool	15kg	720553
1.2	Autopak	230kg	720552A
1.6	Autopak	230kg	720553A



## TENSI-COR 110TXP H4



- ▲ Seamless copper coated tubular fully basic high strength wire.
- ▲ Copper coating offers optimum feedability and conductivity.
- ▲ Formulated for Use with Argon + 20-25% CO<sub>2</sub> or CO<sub>2</sub> Shielding Gases.
- ▲ Excellent Bead Shape and Easy Slag Removal.
- ▲ Excellent Low Temperature mechanical properties to -51°C.

### Classifications:

AS 2203.1:	ETD-GCn/p-W769A. K4 H5.
	ETD-GMn/p-W769A. K4 H5.
AWS/ASME-SFA A5.29:	E11075 K4M H4; E11075 K4 H4.

### Description and Applications:

Tensi-Cor 110TXP H4 is a fully basic low alloy steel flux cored wire suitable for the flat, horizontal-vertical and vertical-up welding of high strength steels. The seamless copper coated tube of Tensi-Cor 110TXP H4 offers optimum feedability and conductivity while helping to achieve the very low AWS: H4 and AS: H5 diffusible hydrogen status.

The H4 hydrogen status greatly improves resistance to hydrogen induced cracking. Formulated for use with Argon + 20-25% CO<sub>2</sub> and welding grade CO<sub>2</sub> shielding gases, Tensi-Cor 110TXP H4 produces a low alloy (nominally 0.4% molybdenum, 2% nickel and 0.4% chromium) steel weld deposit of the 690 MPa class.

The premium quality weld metal and very low AWS: H4 and AS: H5 hydrogen status Tensi-Cor 110TXP H4 make it the ideal choice for the crack free full strength butt welding of Bisalloy 80 and similar quenched and tempered steels.

The advanced seamless copper coated tube technology gives rise to several unique features and benefits including:

- Improved wire feeding which eliminates "bird nests" at the wire feeder
- Improved current transfer at the welding torch for smooth, consistent arc starting
- "Very low AWS: H4 and AS: H5 diffusible hydrogen status for improved resistance to hydrogen induced cold cracking of the weld deposit.

### Typical Weld Metal Mechanical Properties:

Actual weld metal mechanical properties achieved with Tensi-Cor 110TXP are influenced by many factors including base metal analysis, welding parameters/heat input used, shielding gas selection, number of weld passes and run placement.

### TYPICAL ALL WELD METAL:

Using Argon + 20-25% CO<sub>2</sub>:

C: 0.06%	Mn: 1.34%	Si: 0.4%	P: 0.025%
S: 0.025%	Cr: 0.54%	Ni: 2.72%	Mo: 0.3%

Using CO<sub>2</sub>:

C: 0.06%	Mn: 1.22%	Si: 0.31%	Ni: 3.16%
Cr: 0.52%	Mo: 0.39%	P: 0.022%	S: 0.014%

### TYPICAL DIFFUSIBLE HYDROGEN LEVELS TO AS3752:

<3.5 mls of hydrogen / 100gms of deposited weld metal for as manufactured product using Argon + 20-25% CO<sub>2</sub>.

### TYPICAL ALL WELD METAL MECHANICAL PROPERTIES:

Using	Argon + 20-25% CO <sub>2</sub> :	CO <sub>2</sub> :
Yield Stress	720 MPa	700 MPa
Tensile Strength	800 MPa	800 MPa
Elongation	20%	20%
CVN Impact Values	>65J av @ -51°C	>55J av @ -51°C

### RECOMMENDED SHIELDING GASES:

- Argon + 20-25% CO<sub>2</sub> or equiv ISO14175: M21, M24
- Welding Grade CO<sub>2</sub> ISO14175: C1

### Packaging Data:

Wire Diameter (mm)	Type	Pack Weight	Pack Part No.
1.6	Spool	15kg	720387
2.4	Coil	25kg	720389

**Operating Data:**

All welding conditions recommended below are for use with semi-automatic operation, DC electrode positive using Argon + 20-25% CO<sub>2</sub> shielding gas with a flow rate of 15-20 litres/min

Wire Diameter (mm)	Current Range (amps)	Voltage Range (volts)	CTWD	Welding Positions	
1.6	300-350	28-32	25-30		Flat
2.4	400-450	28-32	25-35		
1.6	280-330	27-31	25-30		HV Fillet
2.4	380-430	27-31	25-30		
1.6	220-270	25-30	25-30		Vertical up
1.6	260-310	27-31	25-30		Horizontal
2.4	360-410	27-31	25-30		

These machine settings are a guide only. Actual voltage, welding current and CTWD used will depend on machine characteristics, plate thickness, run size, shielding gas and operator technique etc.

## NICORE® 55



- ▲ Composite Flux Cored Wire for the Joining and Repair of Cast Irons.
- ▲ Also Recommended for the Dissimilar Joining of Cast Iron to Steels.

**Classifications:**

Meets AWS/ASME-SFA A5.15:

ENiFe-CI (equivalent electrode classification).

**Description and Applications:**

Nicore 55 is a composite flux cored wire depositing an Iron / Nickel weld metal for the welding of cast irons.

Nicore 55 is also suitable for the fillet and butt welding of grey, malleable and SG irons to mild steel. The thin slag produced with Nicore 55 requires only wire brushing for complete removal to reveal a weld deposit with excellent appearance and minimal spatter.

Nicore 55 is ideal for use where an ENiFe-CI type manual arc electrode is recommended. Typical applications include the repair of cracked or damaged castings and the filling of foundry defects.

**Packaging and Operating Data:**

Wire Diameter (mm)	Current Range (amps)	Voltage Range (volts)	CTWD	Pack Type	Pack Weight	Part No
1.2	220-250	27-29	13mm	Handispool	6.8kg	724046

These machine settings are a guide only. Actual voltage, welding current and E.S.O. used will depend on machine characteristics, plate thickness, run size, shielding gas and operator technique etc.

NICORE 55 is a registered trademark of The Esab Group, Inc. Hanover, PA 17331, USA.

**TYPICAL ALL WELD METAL ANALYSIS - USING Argon + 1.5% O<sub>2</sub>:**

C: 1.10%	Mn: 0.40%	Si: 0.45%
Fe: 50.0%	Balance Ni	

**TYPICAL ALL WELD METAL MECHANICAL PROPERTIES - USING STAINSHIELD:**

Tensile Strength	500 MPa.
Elongation	12%.
Hardness	200 HV.

**COMPARABLE CIGWELD PRODUCTS:**

Castcraft 55 — AWS A5.15: ENiFe-CI

**RECOMMENDED SHIELDING GASES:**

- Argon + > 0-3% O<sub>2</sub> or equiv. ISO14175: M13
- Argon + > 0-3% O<sub>2</sub> + 1% H<sub>2</sub>

## SHIELD-COR 4XP

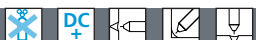

- ▲ **Self Shielded Flux Cored Wire Formulated for Fast Downhand Fillet & Butt Welding Jobs.**
- ▲ **Excellent Operator Appeal.**
- ▲ **Excellent Tolerance to Joint Misalignment or Poor Joint Fit-up.**
- ▲ **Low Spatter Levels / Easily Removed Slag.**

### Classifications:

AS 2203.1: ETD-GNp-W500A. CM2 H15.  
 AWS/ASME-SFA A5.20: E70T-4.

### Description and Applications:

Shield-Cor 4XP is a self shielded flux cored welding wire designed for the high deposition rate fillet and butt welding of mild and medium strength steels in all downhand ( primarily flat and horizontal-vertical ) welding positions.

It has excellent operator appeal and produces a soft, spray arc transfer with a full covering easily removed slag. The soft arc characteristics of Shield-Cor 4XP give it improved tolerance to joint misalignment or joints with poor fit-up.

Shield-Cor 4XP desulphurises the weld deposit thereby giving improved resistance to weld metal cracking.

Shield-Cor 4XP is designed to produce very high deposition rates when used with a long electrode stickout and DC electrode positive polarity only. It produces its own protective shielding gas and is therefore recommended for 'on-site' fabrication, structural or repair welding applications.

Typical applications include general fabrication and structural welding, field erection work and the outdoor repair of heavy machines and equipment.

### Operating Data:

All welding conditions recommended below are for use with semi-automatic operation, and DC electrode positive polarity.

Wire Diameter (mm)	Current Range (amps)	Voltage Range (volts)	CTWD	Welding Positions
2.4	300-400	27-30	60-70	 Flat
2.8	330-430	28-32	60-70	
2.4	280-380	27-30	60-70	 HV Fillet
2.8	320-420	28-32	60-70	
2.4	270-370	27-29	60-70	 Horizontal
2.8	300-400	28-30	60-70	

These machine settings are a guide only. Actual voltage, welding current and CTWD used will depend on machine characteristics, plate thickness, run size and operator technique etc.

### TYPICAL ALL WELD METAL ANALYSIS:

C: 0.30%      Mn: 0.55%      Si: 0.10%  
 Al: 1.50%      S: 0.008%      P: 0.013%

### TYPICAL DIFFUSIBLE HYDROGEN LEVELS TO AS3752:

10.0 - 12.0 mls of hydrogen / 100gms of deposited weld metal \*.

\* - for "as manufactured" product using the recommended E.S.O lengths.

### TYPICAL ALL WELD METAL MECHANICAL PROPERTIES:

Yield Stress                      430 MPa  
 Tensile Strength                590 MPa  
 Elongation                        25%  
 CVN Impact Values            50 J av @ +20°C  
     30 J av @ 0°C

Actual weld metal mechanical properties achieved with Shield-Cor 4XP are influenced by many factors including, base metal analysis, welding parameters / heat input used, number of weld passes and run placement etc. Please consult your nearest CIGWELD branch for welding procedure recommendations.

### RECOMMENDED SHIELDING GASES:

Not Required.

### Packaging Data:

Wire Diameter (mm)	Type	Pack Weight	Pack Part No.
2.4	Coil	27kg	720907
2.8	Coil	27kg	720908

## SHIELD-COR 8XP



- ▲ Superior, all-positional performance.
- ▲ Outstanding operator appeal.
- ▲ Vacuum packaged.
- ▲ Excellent slag lift.

## Classifications:

AS 2203.1: ETP-GNn-W503A. CM1.  
 AWS/ASME-SFA A5.20: E71T-8.

## Description and Applications:

Shield-Cor 8XP is a self-shielding rutile type flux cored welding wire for the joining of mild and medium strength plate and pipes in all positions.

The superior all positional performance of Shield-Cor 8XP make it the prime choice for structural steel work and tank building where wires requiring shielding gas cannot be used. Stringer bead or weave techniques are equally suitable for use with this wire. The outstanding operator appeal of Shield-Cor 8XP make it the optimum choice for operators of all skill levels and experience.

The user friendly nature of Shield-Cor 8XP is backed up by impressive all weld metal mechanical properties and superior deposition rates to that of comparable wires in this class.

## Operating Data:

All welding conditions recommended below are for use with semi-automatic operation, and DC electrode positive polarity.

Wire Diameter (mm)	Current Range (amps)	Voltage Range (volts)	CTWD	Welding Positions	
1.6	170-250	20-24	15-25		Flat
2.0	220-290	22-26	20-30		HV Fillet
1.6	170-260	20-24	15-25		Vertical Up
2.0	200-280	22-26	20-30		
1.6	150-220	20-24	15-25		Overhead
2.0	180-200	22-26	20-30		
1.6	150-220	21-25	12-20		Overhead
2.0	200-240	22-26	15-25		

These machine settings are a guide only. Actual voltage, welding current and CTWD used will depend on machine characteristics, plate thickness, run size and operator technique etc.

## TYPICAL ALL WELD METAL ANALYSIS:

C: 0.17%      Mn: 0.45%      Si: 0.12%      P: 0.01%  
 S: 0.003%      V: 0.01%      Cu: 0.01%      Al: 0.5%

## TYPICAL ALL WELD METAL MECHANICAL PROPERTIES:

Yield Stress                      460 MPa  
 Tensile Strength                560 MPa  
 Elongation                        24%  
 CVN Impact Values            55J av@-30°C

## TYPICAL DIFFUSIBLE HYDROGEN LEVELS TO AS3752:

7-8 mls per 100g

## RECOMMENDED SHIELDING GAS:

Not Required.

## Packaging Data:

Wire Diameter (mm)	Type	Pack Weight	Pack Part No.
1.6	Spool	12kg	721304
2.0	Spool	12kg	721305



- ▲ Superior, all-positional performance.
- ▲ Very good low temperature impact toughness.
- ▲ Vacuum packaged.
- ▲ Excellent tolerance to poor fit up.

### Classifications:

AS 2203.1: ETP-GNn-W503A. Ni1.  
AWS/ASME-SFA A5.20: E71T-8Ni1.

### Description and Applications:

Shield-Cor 8XP is a self-shielding rutile/basic type flux cored welding wire for the joining of mild and medium strength plate and pipes in all positions where low temperature toughness is important. The excellent all positional performance of Shield-Cor 8Ni make it the prime choice for structural steel work and tank building where wires requiring shielding gas cannot be used, such as the construction of off-shore structures and tanks.

The outstanding low temperature impact properties of Shield-Cor 8Ni make it the best choice for high productivity welding in areas where gas shielded wires cannot be used. The broad operating range of Shield-Cor 8Ni is supported by impressive all weld, metal mechanical properties.

### TYPICAL ALL WELD METAL ANALYSIS:

C: 0.06%	Mn: 0.93%	Si: 0.31%	P: 0.08%
S: 0.003%	Ni: 0.01%	Al: 0.5%	

### TYPICAL ALL WELD METAL MECHANICAL PROPERTIES:

Yield Stress	480 MPa
Tensile Strength	560 MPa
Elongation	26%
CVN Impact Values	75J av@-30°C

### TYPICAL DIFFUSIBLE HYDROGEN LEVELS TO AS3752:

7-8 mls per 100g

### RECOMMENDED SHIELDING GAS:





Not Required.

### Packaging Data:

Wire Diameter (mm)	Type	Pack Weight	Pack Part No.
1.6	Spool	12kg	721306
2.0	Spool	12kg	721307

### Operating Data:

All welding conditions recommended below are for use with semi-automatic operation, and DC electrode positive polarity.

Wire Diameter (mm)	Current Range (amps)	Voltage Range (volts)	CTWD	Welding Positions
1.6	170-250	20-24	15-25	 Flat
2.0	220-290	22-26	20-30	
1.6	170-260	20-24	15-25	 HV Fillet
2.0	200-280	22-26	20-30	
1.6	150-220	20-24	15-25	 Vertical Up
2.0	180-200	22-26	20-30	
1.6	150-220	21-25	12-20	 Overhead
2.0	200-240	22-26	15-25	

These machine settings are a guide only. Actual voltage, welding current and CTWD used will depend on machine characteristics, plate thickness, run size and operator technique etc.

## SHIELD-COR 11



- ▲ Self-shielded Flux Cored wire.
- ▲ Versatile, All Positional Capabilities.
- ▲ Excellent Operator Appeal.
- ▲ Excellent Tolerance to Joint Misalignment or Poor Joint Fit-up.
- ▲ Smooth Rippled Fillets with Good Edge Wetting.
- ▲ Ideal for Welding Thin Section Mild and Galvanised Steels.

## Classifications:

AS 2203.1: ETP-GNn-W500A. CM2.  
AWS/ASME-SFA A5.20: E71T-11.

## Description and Applications:

Shield-Cor 11 is an all positional self-shielded flux cored wire recommended for the general purpose single or multi-pass lap, fillet and butt welding of mild and galvanised steels.

Shield-Cor 11 meets the performance requirements of AWS A5.20: E71T-11 and when used with DC electrode negative polarity produces smooth arc characteristics with low spatter losses and an easy-to-remove full covering slag.

The soft arc transfer gives Shield-Cor 11 improved tolerance to joint misalignment or poor fit-up. Smooth stable arcing and excellent fillet shape and edge wetting are achieved when welding galvanised steel fixtures. When 'tuned in' to the optimum current and voltage settings 1.2mm Shield-Cor 11 can be easily used in all welding positions including vertical-up / down and overhead.

Applications include the general purpose fabrication or repair of mild and galvanised steel fixtures and structures including gates, fences, steel frames, galvanised tanks and ornamental iron work etc.

## TYPICAL ALL WELD METAL ANALYSIS:

C: 0.25%	Mn: 0.70%	Si: 0.40%
Al: 1.65%	S: 0.004%	P: 0.007%

## TYPICAL DIFFUSIBLE HYDROGEN LEVELS TO AS3752:

15.0 - 20.0 mls of hydrogen / 100gms of deposited weld metal \*.

\* - for "as manufactured" product using the recommended E.S.O. lengths.

## TYPICAL ALL WELD METAL MECHANICAL PROPERTIES:

Yield Stress	445 MPa
Tensile Strength	620 MPa
Elongation	22%

## RECOMMENDED SHIELDING GAS:

Not Required.

Actual weld metal mechanical properties achieved with Shield-Cor 11 are influenced by many factors including, base metal analysis, welding parameters / heat input used, number of weld passes and run placement etc. Please consult your nearest CIGWELD branch for welding procedure recommendations.

## Packaging Data:

Wire Diameter (mm)	Type	Pack Weight	Pack Part No.
1.2	Spool	15kg	720923
1.6	Spool	15kg	720925

**Operating Data:**

All welding conditions recommended below are for use with semi-automatic operation and DC electrode negative only.

Wire Diameter (mm)	Current Range (amps)	Voltage Range (volts)	CTWD	Welding Positions	
1.2	180-230	16-18	15-20		Flat
1.6	180-250	18-21	20-25		
1.2	150-200	16-18	15-20		HV Fillet
1.6	180-240	18-21	20-25		
1.2	130-180	16-18	15-20		Vertical up
1.6	160-210	18-21	20-25		
1.2	130-180	16-18	15-20		Overhead
1.6	160-200	18-21	20-25		

These machine settings are a guide only. Actual voltage, welding current and CTWD used will depend on machine characteristics, plate thickness, run size, shielding gas and operator technique etc.



## SHIELD-COR 15



- ▲ Self-shielded Flux Cored wire.
- ▲ For Single Pass applications Only.
- ▲ Versatile, All Positional Capabilities.
- ▲ Excellent Tolerance to Joint Misalignment or Poor Joint Fit-up.
- ▲ Smooth Rippled Fillets with Good Edge Wetting.
- ▲ Ideal for Welding Thin Section Mild and Galvanised Steels.

## Classifications:

AS 2203.1: ETPS-GNn-W500A. CM2.  
AWS/ASME-SFA A5.20: E71T-GS.

## Description and Applications:

Shield-Cor 15 is an all positional self-shielded flux cored wire recommended for single pass welding applications only. It is excellent for single-pass lap, fillet and butt welding of thin gauged galvanised and mild steels.

Shield-Cor 15 is used with DC electrode negative polarity which minimises the risk of burn through on thin plate. Travel speeds are high and deposition efficiencies are higher than that of general purpose rutile type electrodes.

Welding characteristics are superb with a smooth arc action, low spatter losses, and an easy-to-remove full covering light slag. The smooth arc transfer gives Shield-Cor 15 improved tolerance to joint misalignment or poor fit-up. Smooth stable arcing and excellent fillet shape and edge wetting are achieved when welding galvanised steel fixtures.

When 'tuned in' to the optimum current and voltage settings the wide range of wire sizes (0.8mm and 0.9mm) can easily be used in all welding positions, including vertical-up/down and overhead, on materials as thin as 1.0mm. Applications include the general purpose fabrication or repair of mild and galvanised steel fixtures and structures including gates, fences, steel frames, galvanised tanks and ornamental iron work etc.

## TYPICAL ALL WELD METAL ANALYSIS:

C: 0.25%	Mn: 0.70%	Si: 0.40%
Al: 2.10%	S: 0.004%	P: 0.007%

## TYPICAL DIFFUSIBLE HYDROGEN LEVELS TO AS3752:

15.0 - 20.0 mls of hydrogen / 100gms of deposited weld metal \*.  
\* - for "as manufactured" product using the recommended E.S.O. lengths.

## TYPICAL ALL WELD METAL MECHANICAL PROPERTIES:

Yield Stress	430 MPa
Tensile Strength	600 MPa
Elongation	21%

## RECOMMENDED SHIELDING GAS:

Not Required.





Actual weld metal mechanical properties achieved with Shield-Cor 15 are influenced by many factors including, base metal analysis, welding parameters / heat input used, number of weld passes and run placement etc. Please consult your nearest CIGWELD branch for welding procedure recommendations.

## Packaging Data:

Wire Diam. (mm)	Type	Pack Weight	Pack Part No.
0.8	100mm spool	0.45kg x (4/ctn)	721956
0.8	200mm Handispool	4.5kg	721923
0.9	100mm Minispool	0.45kg x (4/ctn)	721976
0.9	200mm Handispool	4.5kg	721924
1.2	200mm Handispool	4.5kg	720302

**Operating Data:**

All welding conditions recommended below are for use with semi-automatic operation and DC electrode negative only.

Wire Diameter (mm)	Current Range (amps)	Voltage Range (volts)	CTWD	Welding Positions
0.8	90-150	14-16	10-12	 Flat
0.9	110-180	15-17	12-15	
1.2	180-230	16-18	15-20	
0.8	80-140	14-16	10-12	 HV Fillet
0.9	100-175	15-17	12-15	
1.2	150-200	16-18	15-20	
0.8	60-120	14-16	10-12	 Vertical up
0.9	80-150	15-17	12-15	
1.2	130-180	16-18	15-20	
0.8	60-120	14-16	10-12	 Overhead
0.9	80-150	15-17	12-15	
1.2	130-180	16-18	15-20	

These machine settings are a guide only. Actual voltage, welding current and CTWD used will depend on machine characteristics, plate thickness, run size, shielding gas and operator technique etc.

## VERTI-COR 308LT



- ▲ **Verti-Cor Stainless Steel Flux Cored Wires;**
  - 308LT- All Positional Capabilities
- ▲ **Vacuum Sealed in Aluminised Plastic Packs.**
- ▲ **Formulated for CO<sub>2</sub> or Argon + 20-25% CO<sub>2</sub> Shielding gases.**
- ▲ **High Deposition Rate Welding of Stainless Steels.**

**Classifications:**

AWS/ASME-SFA A5.22:  
E308LT1-1 (CO<sub>2</sub>) / E308LT1-4 (Ar + 20-25%CO<sub>2</sub>).

**Description and Applications:**

Verti-Cor 308LT is a gas shielded stainless steel flux cored wire developed for positional welding applications on 19Cr/9Ni stainless steel grades including AISI types 301, 302, 304 and 304L etc.

Verti-Cor 308LT is a versatile, stainless steel flux cored wire recommended for all positional welding applications. The rutile type flux core gives smooth arc transfer characteristics and very low spatter levels with both CO<sub>2</sub> and Argon + 20-25% CO<sub>2</sub> shielding gases. The fast freezing slag gives excellent weld pool control resulting in smooth mitre to slightly convex fillet welds in the flat, horizontal-vertical, vertical-up and overhead welding positions.

**TYPICAL ALL WELD METAL ANALYSIS:**

Using Welding Grade CO<sub>2</sub>

C: 0.03%	Mn: 1.30%	Si: 0.70%
Cr: 19.5%	Ni: 9.9%	P: 0.020%
S: 0.003%		

**TYPICAL ALL WELD METAL MECHANICAL PROPERTIES:**

	Using CO <sub>2</sub> :	Argon + 20-25% CO <sub>2</sub> :
0.2% Proof Stress	390 MPa	400 MPa
Tensile Strength	550 MPa	580 MPa
Elongation	43%	40%

**COMPARABLE CIGWELD PRODUCTS:**

Autocraft 308LSi GMAW Wire  
AWS A5.9: ER308LSi  
Comweld 308L GAS/TIG rod  
AWS A5.9: ER308L  
Satinrome 308L-17 Electrode  
AWS A5.4: E308L-17

**RECOMMENDED SHIELDING GASES:**

- Argon + 20-25% CO<sub>2</sub> or equivalent ISO14175: M21
- Welding Grade CO<sub>2</sub> ISO14175: C1





Actual weld metal mechanical properties achieved with Verti-Cor wires are influenced by many factors including, base metal analysis, welding parameters / heat input used, shielding gas selection, number of weld passes and run placement etc. Please consult your nearest CIGWELD branch for welding procedure recommendations.

**Packaging Data:**

Wire Diameter (mm)	Type	Pack Weight	Pack Part No.
1.2	Spool	15kg	722889

**Operating Data:**

All welding conditions recommended below are for use with semi-automatic operation and DC electrode positive and welding grade CO<sub>2</sub> shielding gas with a flow rate of 15–20 litres/min.

Wire Diameter (mm)	Current Range (amps)	Voltage Range (volts)	CTWD	Welding Positions
1.2	150-250	23-28	15-20	 Flat
1.2	150-200	23-28	15-20	 HV Fillet
1.2	120-180	22-27	15-20	 Vertical up
1.2	140-180	22-27	15-20	 Overhead

These machine settings are a guide only. Actual voltage, welding current and CTWD used will depend on machine characteristics, plate thickness, run size, shielding gas and operator technique etc.

## VERTI-COR 309LT



- ▲ **Verti-Cor Stainless Steel Flux Cored Wires;**
  - **309LT- All Positional Capabilities**
- ▲ **Vacuum Sealed in Aluminised Plastic Packs.**
- ▲ **Formulated for CO<sub>2</sub> or Argon + 20-25% CO<sub>2</sub> Shielding gases.**
- ▲ **High Deposition Rate Welding of Stainless Steels.**

### Classifications:

AWS/ASME-SFA A5.22:  
E309LT1-1 (CO<sub>2</sub>) / E309LT1-4 (Ar + 20-25%CO<sub>2</sub>).

### Description and Applications:

Verti-Cor 309LT is a gas shielded stainless steel flux cored wire developed for a wide range of positional and downhand welding applications on matching 309 and 309L stainless steels.

Verti-Cor 309LT is suitable for the dissimilar welding of other "300 series" austenitic stainless steels to mild or low alloy steels and for the welding of selected "400 series" ferritic stainless steels, such as 3Cr12.

The rutile type flux core gives smooth arc transfer characteristics and very low spatter levels with both CO<sub>2</sub> and Argon + 20-25% CO<sub>2</sub> shielding gases. The fast freezing slag gives excellent weld pool control resulting in smooth mitre to slightly convex fillet welds in the flat, horizontal-vertical, vertical-up and overhead welding positions.

Actual weld metal mechanical properties achieved with Verti-Cor wires are influenced by many factors including base metal analysis/heat input used, shielding gas selection, number of weld passes and run placement etc. Please consult your Thermadyne Area Manager for welding procedure recommendation.

### TYPICAL ALL WELD METAL ANALYSIS:

Using Welding Grade CO<sub>2</sub>:

C: 0.03%	Mn: 1.12%	Si: 0.60%
Cr: 23.6%	Ni: 13.0%	P: 0.023%
S: 0.003%		

### TYPICAL ALL WELD METAL MECHANICAL PROPERTIES:

	Using CO <sub>2</sub> :	Argon + 20-25% CO <sub>2</sub> :
0.2% Proof Stress	410 MPa	430 MPa
Tensile Strength	550 MPa	580 MPa
Elongation	40 %	38 %

### COMPARABLE CIGWELD PRODUCTS:

Autocraft 309LSi GMAW Wire

AWS A5.9: ER309LSi

Comweld 309L GAS/TIG rod

AWS A5.9: ER309L

Satinrome 309Mo-17 Electrode

AWS A5.4: E309Mo-17

### RECOMMENDED SHIELDING GASES:

- Argon + 20-25% CO<sub>2</sub> or equivalent ISO14175: M21
- Welding Grade CO<sub>2</sub> ISO14175: C1









Actual weld metal mechanical properties achieved with Verti-Cor wires are influenced by many factors including, base metal analysis, welding parameters / heat input used, shielding gas selection, number of weld passes and run placement etc. Please consult your nearest CIGWELD branch for welding procedure recommendations

### Packaging Data:

Wire Diameter (mm)	Type	Pack Weight	Pack Part No.
1.2	Spool	15kg	722881
1.6	Spool	15kg	722882

**Operating Data:**

All welding conditions recommended below are for use with semi-automatic operation, DC electrode positive and welding grade CO<sub>2</sub> shielding gas with a flow rate of 15-20 litres/min.

Wire Diameter (mm)	Current Range (amps)	Voltage Range (volts)	CTWD	Welding Positions
1.2	150-250	23-28	15-20	 Flat
1.6	300-400	28-35	25-30	
1.2	150-200	23-28	15-20	 HV Fillet
1.6	250-350	28-35	25-30	
1.2	120-180	22-27	15-20	 Vertical up
1.6	200-250	23-27	20-25	
1.2	140-180	22-27	15-20	 Overhead
1.6	190-250	23-27	20-25	

These machine settings are a guide only. Actual voltage, welding current and CTWD used will depend on machine characteristics, plate thickness, run size, shielding gas and operator technique etc.

## VERTI-COR 316LT



- ▲ **Verti-Cor Stainless Steel Flux Cored Wires;**
  - **316LT- All Positional Capabilities**
- ▲ **Vacuum Sealed in Aluminised Plastic Packs.**
- ▲ **Formulated for CO<sub>2</sub> or Argon + 20-25% CO<sub>2</sub> Shielding gases.**
- ▲ **High Deposition Rate Welding of Stainless Steels.**

**Classifications:**

AWS/ASME-SFA A5.22:  
E316LT1-1 (CO<sub>2</sub>) / E316LT1-4 (Ar + 20-25%CO<sub>2</sub>).

**Description and Applications:**

Verti-Cor 316LT is a gas shielded stainless steel flux cored wire developed for positional welding applications on matching Molybdenum bearing 316 and 316L stainless steels. Verti-Cor 316LT is also suitable for the general purpose welding of other "300 series" austenitic stainless steels including including 301, 302, 304 and 304L types.

The rutile type flux core gives smooth arc transfer characteristics and very low spatter levels with both CO<sub>2</sub> and Argon + 20-25% CO<sub>2</sub> shielding gases. The fast freezing slag gives excellent weld pool control resulting in smooth mitre to slightly convex fillet welds in the flat, horizontal-vertical, vertical-up and overhead welding positions.

Actual weld metal mechanical properties achieved with Verti-Cor wires are influenced by many factors including base metal analysis/heat input used, shielding gas selection, number of weld passes and run placement etc. Please consult your Thermadyne Area Manager for welding procedure recommendation.

**TYPICAL ALL WELD METAL ANALYSIS:**

Using Welding Grade CO<sub>2</sub>:

C: 0.03%	Mn: 1.10%	Si: 0.60%
Cr: 18.8%	Ni: 12.0%	Mo: 2.5%
P: 0.024%	S: 0.002%	

**TYPICAL ALL WELD METAL MECHANICAL PROPERTIES:**

	Using CO <sub>2</sub> :	Using Argon +20-25%CO <sub>2</sub> :
0.2% Proof Stress	400 MPa	410 MPa
Tensile Strength	555 MPa	580 MPa
Elongation	42 %	39 %

**COMPARABLE CIGWELD PRODUCTS:**

Autocraft 316LSi GMAW Wire

AWS A5.9: ER316LSi

Comweld 316L GAS/TIG rod

AWS A5.9: ER316L

Satinchrome 316L -17 Electrode

AWS A5.4: E316L -17

**RECOMMENDED SHIELDING GASES:**

- Argon + 20-25% CO<sub>2</sub> or equivalent ISO14175: M21
- Welding Grade CO<sub>2</sub> ISO14175: C1





Actual weld metal mechanical properties achieved with Verti-Cor wires are influenced by many factors including, base metal analysis, welding parameters / heat input used, shielding gas selection, number of weld passes and run placement etc. Please consult your nearest CIGWELD branch for welding procedure recommendations.

**Packaging Data:**

Wire Diameter (mm)	Type	Pack Weight	Pack Part No.
1.2	Spool	15kg	722885

**Operating Data:**

All welding conditions recommended below are for use with semi-automatic operation, DC electrode positive and welding grade CO<sub>2</sub> shielding gas with a flow rate of 15-20 litres/min.

Wire Diameter (mm)	Current Range (amps)	Voltage Range (volts)	CTWD	Welding Positions
1.2	150-250	23-28	15-20	 Flat
1.2	150-200	23-28	15-20	 HV Fillet
1.2	120-180	22-27	15-20	 Vertical up
1.2	140-180	22-27	15-20	 Overhead

These machine settings are a guide only. Actual voltage, welding current and CTWD used will depend on machine characteristics, plate thickness, run size, shielding gas and operator technique etc.



## STOODY SOS 308L



(Replaces Shieldcrome 308LT-O)

- ▲ SHIELDCROME Stainless Steel Flux Cored Wires.
- ▲ Convenient Self Shielded (Open Arc) Operation For "In situ or Outdoor Applications.
- ▲ High Deposition Rate Downhand Welding.
- ▲ For downhand welding application on 19Cr/10Ni type stainless steels including type 301, 302, 304 and 304L.

**Classifications:**

AWS/ASME-SFA A5.22: E308LTO-3.  
 WTIA Tech Note 4/AS 2576: 1315-B7.  
 Ferrite Number: 8.0

**Description and Applications:**



Shieldcrome 308LT-O is a self shielded (or open arc) stainless steel flux cored wire developed for a wide range of "in situ" downhand welding applications on 19Cr/10Ni type stainless steels including type 201, 202, 301, 302, 304 and 304L. Shieldcrome 308LT-O is ideal for fast fillet and butt welding applications in the flat and horizontal-vertical positions.

**Typical All Weld Metal Mechanical Properties:**

Actual weld metal mechanical properties achieved with Shieldcrome wires are influenced by many factors including, base metal analysis, welding parameters / heat input used, number of weld passes and run placement etc. Please consult your nearest CIGWELD branch for welding procedure recommendations.

**Operating Data:**

All welding conditions recommended below are for use with semi-automatic self shielded operation and DC electrode positive.

Wire Diameter (mm)	Current Range (amps)	Voltage Range (volts)	CTWD	Welding Positions
2.4	300-350	28-30	20-25	 Flat
2.4	300-350	28-30	20-25	 HV Fillet

These machine settings are a guide only. Actual voltage, welding current and E.S.O. used will depend on machine characteristics, plate thickness, run size, shielding gas and operator technique etc.

**TYPICAL ALL WELD METAL ANALYSIS:**

C: 0.02% Mn: 1.20% Si: 0.50%  
 Cr: 20.80% Ni: 10.2%

**TYPICAL ALL WELD METAL MECHANICAL PROPERTIES:**

Tensile Strength 600 MPa  
 Elongation 43%

**COMPARABLE CIGWELD PRODUCTS:**

Shieldcrome 308LT all positional gas shielded FCAW wire  
 AWS A5.22: E308LT1-1 / E308LT1-4.  
 Shieldcrome 308LTD downhand gas shielded FCAW wire  
 AWS A5.22: E308LTO-1 / E308LTO-4.  
 Autocraft 308LSi GMAW wire  
 AWS A5.9: ER308LSi.  
 Comweld 308L Gas / TIG rod  
 AWS A5.9: ER308L.  
 Satinchrome 308L-17 electrode  
 AWS A5.4: E308L-17.

**RECOMMENDED SHIELDING GAS:**

Not required.

**Packaging Data:**

Wire Diameter (mm)	Wire Type	Pack Type	Pack Weight	Pack Part No.
2.4	308LT-O	Coil	22kg	11175400



(Replaces Shieldcrome 309LT-O)

- ▲ SHIELDCROME Stainless Steel Flux Cored Wires.
- ▲ Convenient Self Shielded (Open Arc) Operation For "In situ" or Outdoor Applications.
- ▲ For Joining Dissimilar Steels or as a Buffer Layer Prior to Hard Surfacing.
- ▲ High Deposition Rate Downhand Welding.

### Classifications:

AWS/ASME-SFA A5.22: E309LT0-3.

WTIA Tech Note 4/AS 2576: 1315-B7.

Ferrite Number 15.0

### Description and Applications:



Shieldcrome 309LT-O is a self shielded (or open arc) stainless steel flux cored wire developed for a wide range of "in situ" downhand welding applications on matching 309 and 309L stainless steels. Shieldcrome 309LT-O is also recommended for the dissimilar fillet and butt welding of other '300 series' austenitic stainless steels to mild or low alloy steels and for the "buttering" of steels prior to the application of hardfacing.

#### Typical Weld Metal Mechanical Properties:

Actual weld metal mechanical properties achieved with Shieldcrome wires are influenced by many factors including, base metal analysis, welding parameters / heat input used, number of weld passes and run placement etc. Please consult your nearest CIGWELD branch for welding procedure recommendations.

### Operating Data:

All welding conditions recommended below are for use with semi-automatic self shielded operation and DC electrode positive.

Wire Diameter (mm)	Current Range (amps)	Voltage Range (volts)	CTWD	Welding Positions
2.4	300-350	28-30	20-25	 Flat
2.4	300-350	28-30	20-25	 HV Fillet

These machine settings are a guide only. Actual voltage, welding current and CTWD used will depend on machine characteristics, plate thickness, run size, shielding gas and operator technique etc.

#### TYPICAL ALL WELD METAL ANALYSIS:

C: 0.02%	Mn: 1.20%	Si: 0.5%
Cr: 24.4%	Ni: 12.6%	

#### TYPICAL ALL WELD METAL MECHANICAL PROPERTIES:

Tensile Strength	610 MPa
Elongation	38%

#### COMPARABLE CIGWELD PRODUCTS:

Shieldcrome 309LT all positional gas shielded FCAW wire AWS A5.22: E309LT1-1 / E309LT1-4.

Shieldcrome 309LTD downhand gas shielded FCAW wire AWS A5.22: E309LT0-1 / E309LT0-4.

Autocraft 309LSi GMAW wire

AWS A5.9: ER309LSi.

Comweld 309L Gas / TIG rod

AWS A5.9: ER309L.

Satincrome 309Mo-17 electrode

AWS A5.4: E309Mo-17.

#### RECOMMENDED SHIELDING GAS:

Not required.

### Packaging Data:

Wire Diameter (mm)	Wire Type	Pack Type	Pack Weight	Pack Part No.
2.4	309LT-O	Coil	22kg	11231200



<b>Description</b>	<b>Page No</b>
Autocraft SA1	173
Autocraft SA2	174
Satinarc 4	175
Satinarc 15	176

## CONTACT TIP TO WORK DISTANCE (CTWD) EXPLAINED

**Contact Tip to Work Distance (CTWD)**, also sometimes referred to as electrode stick out (ESO), is defined as the distance between the end of the contact tip and the workpiece. A schematic diagram of CTWD is shown below. CTWD includes the wire length from the contact tip, to the point where it enters the welding arc, and the arc length.

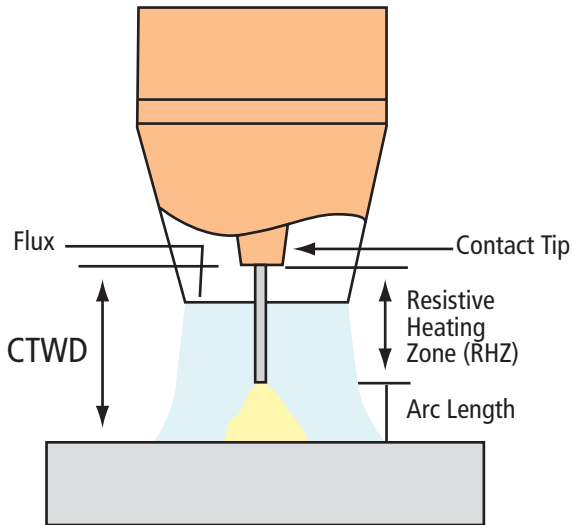



- ▲ **Copper Coated, Low Carbon Low Manganese Steel Submerged Arc Wire.**
- ▲ **Cost Effective General Purpose Welding with a 'Active' Fluxes including Satinarc 15.**

#### TYPICAL WIRE ANALYSIS:

C: 0.08%	Mn: 0.50%	Si: 0.01%
S: 0.017%	P: 0.010%	

### Classifications:

AS 1858.1: EL12.  
 AWS/ASME-SFA A5.17: EL12.

### Description and Applications:

Autocraft SA1 is a copper coated, low carbon steel wire for general purpose submerged arc welding applications. The very low deoxidant levels of Autocraft SA1 (nominally 0.5% Manganese, 0.01% Silicon) necessitates its use with 'active' or contributory fluxes such as Satinarc 15.

Autocraft SA1 / Satinarc 15 is a versatile, submerged arc welding combination suitable for a multitude of fast fillet and butt welding applications on rusty or mill scaled plate up to 25mm thick.

### Packaging and Operating Data\*:

Wire Diameter mm	Current Range (amps)	Voltage Range (volts)	CTWD (mm)	Pack Type	Pack Weight	Part No
2.0	200-550	24-32	20-25	Coil	30kg	720582
2.4	250-700	26-34	20-25	Coil	30kg	720583
3.2	300-900	28-34	25-30	Coil	30kg	720584
4.0	400-1000	30-38	20-25	Coil	30kg	720585

Parameters are for single wire automatic applications.

Other packaging options are available on indent, please contact your CIGWELD representative.

## AUTOCRAFT SA2



- ▲ Copper Coated, Low Carbon Steel Submerged Arc Wire.
- ▲ Cost Effective General Purpose and Higher Quality Welding with a 'Neutral' Flux such as Satinarc.

## TYPICAL WIRE ANALYSIS:

C: 0.10%	Mn: 1.0%	Si: 0.22%
S: 0.017%	P: 0.010%	

## Classifications:

AS 1858.1:	EM12K.
AWS/ASME-SFA A5.17:	EM12K.

## Description and Applications:

Autocraft SA2 is a copper coated - nominal 1.0% Manganese, 0.20% Silicon - steel submerged arc welding wire.

The chemical analysis of Autocraft SA2 makes it suitable for a wide range of general purpose and critical submerged arc welding applications with a 'neutral' flux such as Satinarc 4.

When used with this flux, Autocraft SA2 produces a high weld metal tensile strength.

## Packaging and Operating Data\*:

Wire Diameter mm	Current Range (amps)	Voltage Range (volts)	CTWD (mm)	Pack Type	Pack Weight	Part No
2.0	200-550	24-32	20-25	Coil	30kg	720662
2.4	250-700	26-34	20-25	Coil	30kg	720663
3.2	300-900	28-34	25-30	Coil	30kg	720664
4.0	400-1000	30-38	30-35	Coil	30kg	720665



- ▲ Semi-Basic Submerged Arc Flux.
- ▲ For Multi Pass Butt Welding Applications Requiring Low Temperature Impact Properties.
- ▲ Recommended for Use with Autocraft SA2.
- ▲ Excellent Slag Lift in Deep 'Vee' Joints.

### Classifications:

Autocraft SA1 & Satinarc 4

AWS A5.17: F6A2-EL12

AS 1858.1: EL12-FMM-W403A.

Autocraft SA2 & Satinarc 4

AWS A5.17: F7A4-EM12K.

AWS A5.17: F6P4-EM12K.

AS 1858.1: EM12K-FMM-W503A.

### Description and Applications:

Satinarc 4 is a semi-basic, agglomerated flux suitable for a wide range of fillet and butt welding applications.

It is recommended for heavier, multi-pass butt welding applications and produces excellent slag lift in narrow joint preparations.

The Autocraft SA2 / Satinarc 4 combination provides consistent 'as welded' and 'stress relieved' mechanical properties. Despite its basic slag system, Satinarc 4 produces good weld profiles, edge wetting and slag lift in single and multi-pass welding applications.

### Operating Capabilities:

Satinarc 4 flux produces smooth arc characteristics and excellent slag lift in deep 'vee' weld preparations.

Weld beads will exhibit a fine rippled surface appearance and smooth side wall wash.

Satinarc 4 operates well with AC or DC power and is tolerant to lightly rusted or scaled plate.

### Autocraft SA1 / Satinarc 4

#### APPROVALS:

Lloyds Register of Shipping - Grade DBF 2T, 3M 20

American Bureau of Shipping - Grade 2T, 3M

#### TYPICAL ALL WELD METAL ANALYSIS:

C: 0.05% Mn: 0.85% Si: 0.30%

S: 0.008% P: 0.022%

#### TYPICAL ALL WELD METAL MECHANICAL PROPERTIES (AS WELDED):

Yield Stress	380 MPa.
Tensile Stress	490 MPa
Elongation	32%
CVN Impact Values	90 J av @ -20°C.

### Autocraft SA2 / Satinarc 4

#### APPROVALS:

Lloyds Register of Shipping - Grade 3M 3YM

#### TYPICAL ALL WELD METAL ANALYSIS:

C: 0.09% Mn: 1.2% Si: 0.4%

S: 0.020% P: 0.030%

#### TYPICAL ALL WELD METAL MECHANICAL PROPERTIES (AS WELDED):

Yield Stress	425 MPa.
Tensile Stress	520 MPa
Elongation	29%
CVN Impact Values	100 J av @ -20°C. 140 J av @ 0°C.

### Flux Constituents:

(Basicity Index\* = 1.6)

SiO <sub>2</sub> + TiO <sub>2</sub>	CaO + MgO	Al <sub>2</sub> O <sub>3</sub> + MnO	CaF <sub>2</sub>
20%	25%	35%	15%

\* Basicity Index to Boniszewski.

### Packaging Data:

Pack Type	Pack Weight	Part No
4 Ply Paper Bag	25kg net	720412





- ▲ Active, General Purpose Submerged Arc Flux.
- ▲ For Fillet and Multi Pass Butt Welding Applications on plate less than 25mm thick.
- ▲ Cost Effective Welding with Autocraft SA1 and Autocraft SA2 wires.
- ▲ Good Tolerance to Rust and Mill Scale.
- ▲ High Current Carrying Capacity.

### Classifications:

Autocraft SA1/Satinarc 15:

AWS/ASME-SFA A5.17: F6A2-EL12  
AS1858.1: EL12-FGH-W403A

Autocraft SA2/Satinarc 15:

AWS/ASME-SFA A5.17: F7A2-EM12K  
AS1858.1: EM12K-FGH-W403A

### Description and Applications:

Satinarc 15 is a general purpose agglomerated flux from CIGWELD suitable for a multitude of fillet and butt welding applications on plate up to 25mm thick. It is recommended for high speed fillet welding applications where its tolerance to rust/mill scale, excellent blending at weld toes and resistance to pock marking can be used to advantage.

Satinarc 15 is also suitable for DC, AC or multi-wire welding applications up to 1200 amps on a single wire. Whilst the active (or acidic) nature of Satinarc 15 will give deposited welds good resistance to surface rust and Mill scale it prohibits the use of Satinarc 15 in the multi-pass butt welding of plate thicknesses greater than 25mm.

### Operating Capabilities:

Satinarc 15 flux produces smooth arc characteristics and excellent fillet shapes at high (up to 1.8m/min) travel speeds. It is a highly versatile flux and can be used at welding currents up to 1200 amps with DC, AC or multi-wire systems. The active or acidic nature of Satinarc 15 gives it good resistance to surface contamination but prohibits its use in heavy multi-pass butt welding applications due to excessive build up of Manganese and Silicon.

### Autocraft SA1 / Satinarc 15

#### APPROVALS:

Lloyds Register of Shipping - Grade DBF 2T, 3M 20  
American Bureau of Shipping - Grade 2T, 3M

#### TYPICAL ALL WELD METAL ANALYSIS:

C: 0.05%	Mn: 1.25%	Si: 0.55%
S: 0.011%	P: 0.016%	

#### TYPICAL ALL WELD METAL MECHANICAL PROPERTIES (AS WELDED):

Yield Stress	400 MPa.
Tensile Stress	500 MPa
Elongation	32%
CVN Impact Values	80 J av @ -20°C.

### Autocraft SA2 / Satinarc 15

#### APPROVALS:

Lloyds Register of Shipping - Grade DBF 2YT, 3YM 20  
American Bureau of Shipping - Grade 2YT, 3YM

#### TYPICAL ALL WELD METAL ANALYSIS:

C: 0.07%	Mn: 1.70%	Si: 0.85%
S: 0.014%	P: 0.020%	

#### TYPICAL ALL WELD METAL MECHANICAL PROPERTIES (AS WELDED):

Yield Stress	480 MPa.
Tensile Stress	590 MPa
Elongation	28%
CVN Impact Values	60 J av @ -20°C.

### Flux Constituents:

(Basicity Index\* = 0.8)

SiO <sub>2</sub> + TiO <sub>2</sub>	CaO + MgO	Al <sub>2</sub> O <sub>3</sub> + MnO	CaF <sub>2</sub>
43-48%	22-28%	15-21%	4-6%

\* Basicity Index to Boniszewski.

### Packaging Data:

Pack Type	Pack Weight	Part No
4 Ply Paper Bag	25kg net	720415



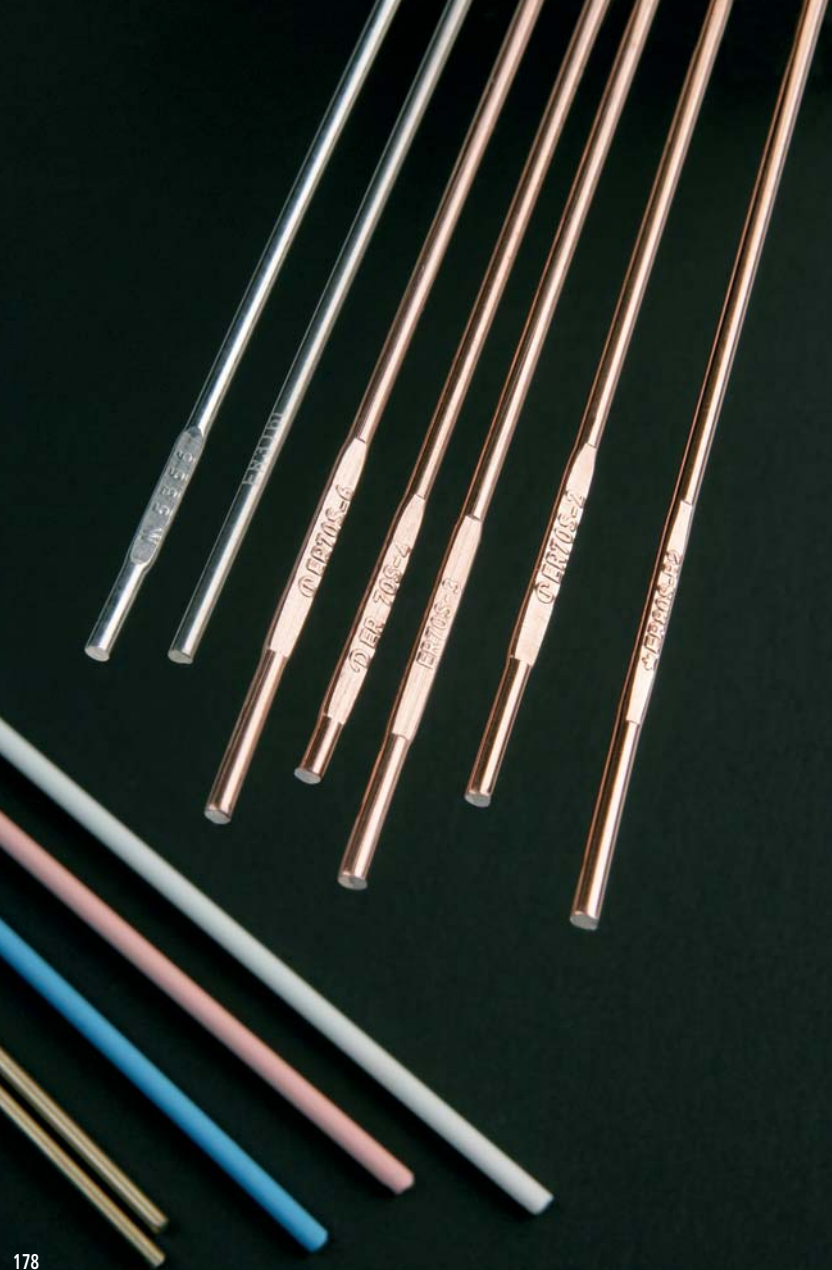

<b>Description</b>	<b>Page No</b>
How to Select the Best Comweld Rod	180
Flame Adjustment	181
Terms and Definitions	182
Comweld Mild Steel	184
Comweld High Test	185
Comweld LW1	186
Comweld LW1-3	187
Comweld LW1-6	188
Comweld Super Steel	189
Comweld CrMo1	190
Comweld CrMo2	191
Comweld 308L Stainless Steel	192
Comweld 309L Stainless Steel	193
Comweld 316L Stainless Steel	194
Comweld 2209 Duplex Stainless Steel	195
Comweld AL1100 (Pure)	196
Comweld AL4043 (5% Silicon)	197
Comweld AL4047 (10% Silicon)	198
Comweld AL5356 (5% Magnesium)	199
Comweld General Purpose, Cast Iron Rod	200
Comweld Galvanising Bar	201
Comweld Manganese Bronze Rod	202
Comweld Comcoat C	203
Comweld Tobin Bronze Rod	204
Comweld Comcoat T	205
Comweld Nickel Bronze Rod	206
Comweld Comcoat N	207
Comweld Silicon Bronze Rod(801)	208

## HOW TO SELECT THE BEST COMWELD ROD

To assist you in selecting the most suitable alloy and process for the particular application, we have recommended below the alloy and process that would be most suitable for your use. Once you have selected the best alloy, refer to contents for detailed information on its characteristics, technical specifications, applications and procedure.

Process	Comweld Alloy	Comweld Flux
	<b>Joining copper, brass, bronze, etc.</b>	
Braze Welding	Phos Copper	No flux
"	Comcoat T or *Tobin Bronze	*Copper & Brass
"	Comcoat N or *Nickel Bronze	*Copper & Brass
GTA Welding (TIG)	Comweld Aluminium Bronze	No flux
GTA Welding (TIG)	Comweld Silicon Bronze	No flux
Soldering	965 Silver Solder	965 Soldering Flux
	<b>Joining Steel.</b>	
Oxy Acetylene Fusion Welding	Mild Steel, High Test	No flux
GTA Welding (TIG)	Comweld LW1, Super Steel	No flux
Braze Welding	Comcoat C	No flux
Braze Welding	Manganese Bronze	Copper & Brass
Soldering	965 Silver Solder	965 Soldering Flux
	<b>Repairing Cast Iron.</b>	
Oxy Acetylene Fusion Welding	GP Super Silicon Cast Iron	No Flux
GTA Welding (TIG)	GP Super Silicon Cast Iron	No flux
Braze Welding	Comcoat C	No flux
"	Manganese Bronze	No Flux
"	Comcoat N	No flux
"	Nickel Bronze	No Flux
	<b>Joining Stainless Steel.</b>	
Oxy Acetylene Fusion Welding	Comweld 308L, 309L, 316L & 2209	No Flux
GTA Welding (TIG)	Comweld 308L, 309L, 316L & 2209	No flux
Soldering	965 Silver Solder	965 Soldering Flux
	<b>Joining Aluminium.</b>	
Oxy Acetylene Fusion Welding	AL1100, AL4043, AL4047 & AL5356	Aluminium Welding Flux
GTA Welding (TIG)	AL1100, AL4043 & AL5356	No flux
Braze Welding	AL4047	No Flux
Soldering	Aluminium Solder	No flux

## FLAME ADJUSTMENT

Correct flame adjustment is a most important factor in making a successful oxy-acetylene weld.

Careful consideration should be given to this, so that CIGWELD welding rods and fluxes are used to their best possible advantages.

There are basically three types of flame adjustments, ie. neutral, oxidising (excess oxygen) and reducing or carburising (excess acetylene). The neutral flame setting is used for the majority of welding and brazing requirements.

So that you can easily identify each type, a sketch of the different flame settings is shown below.

**Neutral Flame: For steel, stainless steel, cast iron, copper, aluminium, etc.**

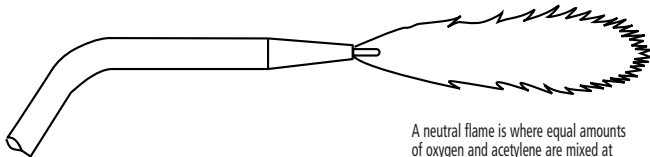

A neutral flame is where equal amounts of oxygen and acetylene are mixed at the same rate. The white inner cone is clearly defined and shows no haze.

**Oxidising Flame: An oxidising flame is necessary for welding brass.**

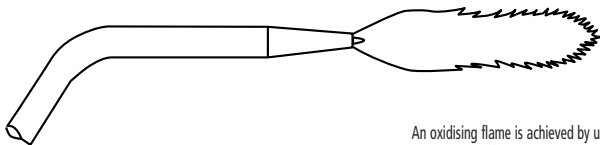

An oxidising flame is achieved by using excess oxygen (or reduced acetylene). The white inner cone is very pale and may cause the tip to "pop".

**Carburising or Reducing Flame: Excess acetylene is necessary for hard facing.**

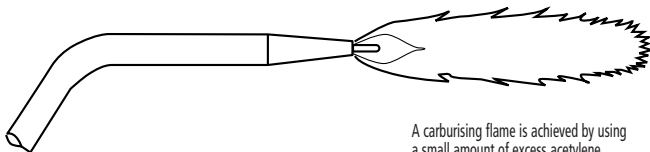

A carburising flame is achieved by using a small amount of excess acetylene. The white inner cone will show signs of a haze of "feather" at the end of the inner cone.

## TERMS AND DEFINITIONS

### Alloy:

A mixture of two or more entirely different metals united by melting together.

### Annealing:

Process of gradually cooling a metal part after welding or reheating it to make it soft for mechanical working. Annealing will also relieve any stresses that originally existed or that may be set up by the welding operation.

### Backhand Welding: (rightward, backward).

Welding with the blowpipe flame pointing in the direction opposite to that in which the weld progresses, that is, toward the finished portion of the weld. The opposite of forehand welding.

### Blowhole:

A cavity in weld metal caused by a bubble of gas becoming entrapped in the solidifying metal.

### Brazing:

A joining process in which the molten filler metal is drawn by capillary action between two closely adjacent surfaces to be joined. The filler metal is a non-ferrous metal or alloy with a melting point above 450°C, but lower than that of the metal being joined. It is a process more comparable to soldering than to welding.

### Braze Welding:

Unlike brazing does not depend on capillary attraction. The parent metal is not melted, but the joint design is similar to that which would be used if a fusion weld were made. The filler metal is generally a non-ferrous metal or alloy, with a melting point above 500°C.

### Bronze Welding:

A term which has been used to describe a braze-welding process in which a copper-rich filler materials is used. Can be applied to the fusion welding of bronze.

### Butt Weld: (groove weld).

A weld in which the two edges of metal to be united are abutted together.

### Cone:

The part of a flame that is conical in shape and located at the end of the welding tip, heating tip or cutting nozzle.

### Ductility:

The property which permits metal to be drawn, formed or shaped.

### Filler Rod:

A metal rod or wire which is melted and deposited in the weld and used to supply additional material.

### Fillet Weld:

A weld made in a corner, as in a lap or T-joint.

### Flame Brazing:

A brazing process in which the necessary heat is supplied by means of an oxy-fuel gas flame.

## TERMS AND DEFINITIONS CONT.

### Flux Inclusion:

A cavity in the weld metal containing flux caused by a quantity of flux becoming entrapped as the metal solidifies.

### Forehand Welding: (Leftward, forward).

Welding with the blowpipe flame pointing in the direction in which the weld progresses, that is, towards the unfinished seam. The opposite of Backhand Welding.

### Fusion Welding:

The type of welding in which the edges of the two pieces of metal being joined are melted and completely fused together without pressure and in which the filler rod, if used, is of similar composition to the parent metal.

### Handigas:

A liquefied petroleum fuel gas supplied by BOC Gases for cutting and heating.

### Hardfacing:

A process wherein metal harder than the parent metal is deposited on to a surface.

### Neutral Flame:

An oxy-fuel gas flame in which the inner cone, or that portion of the flame used, is neither oxidising nor carburising. It is characterised by an almost colourless outer envelope and a sharply defined inner cone without feather or secondary flame.

### Outer Envelope:

The secondary phase of combustion in any oxy-fuel gas flame which surrounds the innercone.

### Penetration:

The depth of fusion obtained in a welded joint.

### Silver Brazing: (Silver Soldering)

A low temperature brazing process in which a silver alloy is used as filler metal.

### Tinning:

The act of coating another metal with tin. The term is also applied in brazing and braze welding, where the spreading out of a thin layer of fluxed brazing metal ahead of the main deposit to form a "tinning" coat provides a strong bond between parent metal and deposit.



## COMWELD MILD STEEL



- ▲ Black Annealed, Low Carbon Steel Rod for Oxy-Acetylene Welding.
- ▲ Recommended for Gas Welding of Steels and Wrought Irons.
- ▲ Not Suitable for Gas Tungsten Arc Welding.

## Classifications:

AS 1167.2: RG.  
AWS/ASME-SFA A5.2: R45.

## Description and Applications:

As the name implies, Comweld Mild Steel is an uncoated mild steel filler rod suitable for the oxy-acetylene (fusion) fillet and butt welding of carbon steel and wrought iron.

Comweld Mild Steel produces a free flowing weld pool without the need for an externally applied flux. A neutral to slightly reducing flame setting is recommended for use with Comweld Mild Steel.

Resultant weld deposits are ductile and in the 350 - 400 MPa tensile class. The low deoxidant level of Comweld Mild Steel makes it unsuitable for Gas Tungsten Arc (TIG) welding applications.

## JOINING PROCESS:

Gas (Fusion) Welding only.

## TYPICAL WELD DEPOSIT PROPERTIES:

All Weld Metal Tensile Strength	370 MPa.
Elongation	30%
Approximate Melting Point	1490°C.
Weld Metal Density	7.85 gms / cm <sup>3</sup>

## TYPICAL ROD ANALYSIS:

C: 0.07%	Mn: 0.50%	Si: 0.008%
S: 0.008%	P: 0.011%	Fe: Balance

## Packaging Data:

Rod Size (mm)	Pack Weight/Type	Approximate Rods/kg	Part No
1.6 x 500	1kg Handipack	130	322045
1.6 x 1,000	5kg Pack	64	321334
2.4 x 750	5kg Pack	29	321337
3.2 x 750	5kg Pack	16	321339



## COMMWELD HIGH TEST

- ▲ Copper Coated, Steel Filler Rod for Gas and Gas Tungsten Arc (TIG) Welding.
- ▲ Higher Strength (400-450MPa) Oxy-Acetylene and TIG Welding of Steels.

### Classifications:

AS 1167.2: R1.  
AWS/ASME-SFA A5.2: R60.

### Description and Applications:

Comweld High Test is a copper coated steel filler rod suitable for the oxy-acetylene (fusion) welding and Gas Tungsten Arc (TIG) welding of carbon steels.

Comweld High Test produces a free flowing weld pool when gas welding, without the need for an externally applied flux. Resultant weld deposits are ductile and in the 400 - 450 MPa tensile class. A

neutral to slightly reducing flame setting is recommended for use with Comweld High Test which is used extensively for the gas welding of pressure pipelines where higher joint strengths are required.

The nominal 1.2% Manganese and 0.2% Silicon deoxidant levels of Comweld High Test make it suitable for Gas Tungsten Arc (TIG) welding applications.

### Procedure for Gas (Oxy-acetylene) Welding:

1. Thoroughly clean all areas to be welded.
2. Adjust flame to a neutral setting.
3. Preheat thicker joint sections.
4. Heat a small area of the joint until molten and progressively add Comweld High Test filler rod to the weld pool. Ensure the rod is melted by the molten weld pool and not the flame.
5. Allow completed joint to cool and remove residual scale by grinding, or wire brushing.

### Procedure for Gas Tungsten Arc (TIG) Welding:

1. Thoroughly clean all areas to be joined.
2. For the butt welding of thick plates, bevel edges to 60°-70° included angle.
3. Use a Thoriated or Ceriated tungsten electrode, ground to a sharp needle point making sure the grinding lines run with the length (longitudinally) of the electrode's axis. The length of the needle point should be approximately 2-3 x the diameter of the tungsten electrode.
4. Use Direct Current Electrode Negative (DC-) and Welding Grade Argon.
5. Preheat thick sections prior to welding. Heat a spot on the base metal until it shows signs of melting and progressively add the filler rod to the weld pool.

### JOINING PROCESS:

Gas (Fusion) and Gas Tungsten Arc (TIG) welding.

### TYPICAL WELD DEPOSIT PROPERTIES:

All Weld Metal Tensile Strength	425 MPa.
Elongation	28%
Approximate Melting Point	1490°C.
Weld Metal Density	7.85 gms / cm <sup>3</sup>

### TYPICAL ROD ANALYSIS:

C: 0.12%	Mn: 1.17%	Si: 0.25%
S: 0.009%	P: 0.015%	Fe: Balance

### Packaging Data:

Rod Size (mm)	Pack Weight/Type	Approximate Rods/kg	Part No
1.6 x 915	5kg Pack	84	321357
2.4 x 915	5kg Pack	34	321360
3.2 x 915	5kg Pack	21	321362

## COMWELD LW1



- ▲ **Copper Coated, Low Carbon Steel Rod for Gas Tungsten Arc Welding Applications.**
- ▲ **End-Stamped 'ER70S-4' for Instant I.D.**

## Classifications:

AS 1167.2: R4.  
AWS/ASME-SFA A5.18: ER70S-4.

## Description and Applications:

Comweld LW1 is a copper coated, double de-oxidised low carbon steel filler rod suitable for the oxy-acetylene (fusion) welding and Gas Tungsten Arc (TIG) welding of a wide range of mild and medium strength steels.

Comweld LW1 is recommended for the TIG welding of steel pipes, plates and castings with a tensile strength in the 500 MPa class. It is tolerant to surface rust and mill scale and is ideal for root pass welding applications where tough and ductile welds are produced.

When using Comweld LW1 for gas welding applications a neutral to slightly reducing flame setting is recommended.

## Procedure for Gas (Oxy-acetylene) Welding:

1. Thoroughly clean all areas to be welded.
2. Adjust flame to a neutral setting.
3. Preheat thicker joint sections.
4. Heat a small area of the joint until molten and progressively add Comweld LW1 filler rod to the weld pool. Ensure the rod is melted by the molten weld pool and not the flame.
5. Allow completed joint to cool and remove residual scale by grinding, or wire brushing.

## Procedure for Gas Tungsten Arc (TIG) Welding:

1. Thoroughly clean all areas to be joined.
2. For the butt welding of thick plates, bevel edges to 60°-70° included angle.
3. Use a Thoriated or Ceriated tungsten electrode, ground to a sharp needle point making sure the grinding lines run with the length (longitudinally) of the electrode's axis. The length of the needle point should be approximately 2-3 x the diameter of the tungsten electrode.
4. Use Direct Current Electrode Negative (DC-) and Welding Grade Argon.
5. Preheat thick sections prior to welding. Heat a spot on the base metal until it shows signs of melting and progressively add the filler rod to the weld pool.

## JOINING PROCESS:

Gas (Fusion) and Gas Tungsten Arc (TIG) welding.

## TYPICAL ALL WELD METAL MECHANICAL PROPERTIES:

Yield Stress	400 MPa.
Tensile Strength	500 MPa.
Elongation	29%
CVN Impact Values	100 J av @ -20°C

## TYPICAL ROD ANALYSIS:

C: 0.08%	Mn: 1.16%	Si: 0.75%
S: 0.010%	P: 0.015%	Fe: Balance

## COMPARABLE CIGWELD PRODUCTS:

Autocraft LW1 GMAW wire  
AWS A5.18: ER70S-4

## Packaging Data:

Rod Size (mm)	Pack Weight/Type	Approximate Rods/kg	Part No
1.6 x 915	5kg Pack	84	321411
2.4 x 915	5kg Pack	34	321412



- ▲ Copper Coated, Low Carbon Steel Rod for Gas TIG & Oxy Welding Applications.
- ▲ End stamped with "ER70S-3" for easy I.D.
- ▲ Resealable 5kg cardboard tube.

### Classifications:

AS 1167.2: R3.  
AWS/ASME-SFA A5.18: ER70S-3.

### Description and Applications:

Comweld LW1-3 is a copper coated, low carbon steel filler rod suitable for the oxy-acetylene (fusion) welding and Gas Tungsten Arc (TIG) welding of a wide range of mild and medium strength steels.

Comweld LW1-3 is recommended for the TIG welding of steel pipes, plates and castings with a tensile strength in the 500 MPa class. It is tolerant to surface rust and mill scale and is ideal for root pass welding applications where tough and ductile welds are produced.

When using Comweld LW1-3 for gas welding applications a neutral to slightly reducing flame setting is recommended.

#### Procedure for Gas (Oxy-acetylene) Welding:

1. Thoroughly clean all areas to be welded.
2. Adjust flame to a neutral setting.
3. Preheat thicker joint sections.
4. Heat a small area of the joint until molten and progressively add Comweld High Test filler rod to the weld pool. Ensure the rod is melted by the molten weld pool and not the flame.
5. Allow completed joint to cool and remove residual scale by grinding, or wire brushing.

#### Procedure for Gas Tungsten Arc (TIG) Welding:

1. Thoroughly clean all areas to be joined.
2. For the butt welding of thick plates, bevel edges to 60°-70° included angle.
3. Use a Thoriated or Ceriated tungsten electrode, ground to a sharp needle point making sure the grinding lines run with the length (longitudinally) of the electrode's axis. The length of the needle point should be approximately 2-3 x the diameter of the tungsten electrode.
4. Use Direct Current Electrode Negative (DC-) and Welding Grade Argon.
5. Preheat thick sections prior to welding. Heat a spot on the base metal until it shows signs of melting and progressively add the filler rod to the weld pool.

#### JOINING PROCESS:

Gas (Fusion) and Gas Tungsten Arc (TIG) welding.

#### TYPICAL ALL WELD METAL MECHANICAL PROPERTIES:

Yield Stress	400 MPa.
Tensile Strength	500 MPa.
Elongation	30%
CVN Impact Values	100 J av @ -20°C

#### TYPICAL ROD ANALYSIS:

C: 0.07%	Mn: 1.1%	Si: 0.5%
S: 0.012%	P: 0.015%	Fe: Balance

#### Packaging Data:

Rod Size (mm)	Pack Weight/Type	Approximate Rods/kg	Part No
1.6 x 1000	5kg Pack	64	321423
2.4 x 1000	5kg Pack	29	321424

## COMWELD LW1-6



- ▲ Copper Coated, Low Carbon Steel Rod for Gas TIG & Oxy Welding Applications.
- ▲ End stamped with "ER70S-6" for easy I.D.
- ▲ Resealable 5kg cardboard tube.

## Classifications:

AS 1167.2: R6.  
AWS/ASME-SFA A5.18: ER70S-6.

## Description and Applications:

Comweld LW1-6 is a copper coated, low carbon steel filler rod suitable for the oxy-acetylene (fusion) welding and Gas Tungsten Arc (TIG) welding of a wide range of mild and medium strength steels.

Comweld LW1-6 is recommended for the TIG welding of steel pipes, plates and castings with a tensile strength in the 500 MPa class. It is tolerant to surface rust and mill scale and is ideal for root pass welding applications where tough and ductile welds are produced.

When using Comweld LW1-6 for gas welding applications a neutral to slightly reducing flame setting is recommended.

## Procedure for Gas (Oxy-acetylene) Welding:

1. Thoroughly clean all areas to be welded.
2. Adjust flame to a neutral setting.
3. Preheat thicker joint sections.
4. Heat a small area of the joint until molten and progressively add Comweld High Test filler rod to the weld pool. Ensure the rod is melted by the molten weld pool and not the flame.
5. Allow completed joint to cool and remove residual scale by grinding, or wire brushing.

## Procedure for Gas Tungsten Arc (TIG) Welding:

1. Thoroughly clean all areas to be joined.
2. For the butt welding of thick plates, bevel edges to 60°-70° included angle.
3. Use a Thoriated or Ceriated tungsten electrode, ground to a sharp needle point making sure the grinding lines run with the length (longitudinally) of the electrode's axis. The length of the needle point should be approximately 2-3 x the diameter of the tungsten electrode.
4. Use Direct Current Electrode Negative (DC-) and Welding Grade Argon.
5. Preheat thick sections prior to welding. Heat a spot on the base metal until it shows signs of melting and progressively add the filler rod to the weld pool.

## JOINING PROCESS:

Gas (Fusion) and Gas Tungsten Arc (TIG) welding.

## TYPICAL ALL WELD METAL MECHANICAL PROPERTIES:

Yield Stress	400 MPa.
Tensile Strength	500 MPa.
Elongation	29%
CVN Impact Values	100 J av @ -20°C

## TYPICAL ROD ANALYSIS:

C: 0.07%	Mn: 1.55%	Si: 0.88%
S: 0.012%	P: 0.015%	Fe: Balance

## COMPARABLE CIGWELD PRODUCTS:

Autocraft LW1-6 GMAW wire  
AWS A5.18: ER70S-6

## Packaging Data:

Rod Size (mm)	Pack Weight/Type	Approximate Rods/kg	Part No
1.6 x 1000	5kg Pack	64	321417
2.4 x 1000	5kg Pack	29	321418

## COMWELD SUPER STEEL



- ▲ Low Carbon Steel Filler Rod for Gas Tungsten Arc (TIG) Welding.
- ▲ Triple Deoxidised for Superior Weld Deposit Quality and Resistance to Porosity.
- ▲ End Stamped with AWS Class "ER70S-2".
- ▲ Resealable 5 kg Cardboard Tube.

## Classifications:

AS 1167.2: R2.  
AWS/ASME-SFA A5.18: ER70S-2.

## Description and Applications:

Comweld Super Steel is a copper coated 'triple deoxidised' steel welding rod recommended for the high quality Gas Tungsten Arc (TIG) welding of carbon and carbon-Manganese steels.

Comweld Super Steel is deoxidised with Titanium, Aluminium and Zirconium in addition to Manganese and Silicon for improved weld deposit quality. It is the ideal choice for TIG welding rusty or mill scaled plates and pipes and the root pass welding of pipes, tanks and heavy walled joints where good root toughness and radiographic soundness are achieved under high dilution.

## Procedure for Gas (Oxy-acetylene) Welding:

1. Thoroughly clean all areas to be welded.
2. Adjust flame to a neutral setting.
3. Preheat thicker joint sections.
4. Heat a small area of the joint until molten and progressively add Comweld Super Steel filler rod to the weld pool. Ensure the rod is melted by the molten weld pool and not the flame.
5. Allow completed joint to cool and remove residual scale by grinding, or wire brushing.

## Procedure for Gas Tungsten Arc (TIG) Welding:

1. Thoroughly clean all areas to be joined.
2. For the butt welding of thick plates, bevel edges to 60°-70° included angle.
3. Use a Thoriated or Ceriated tungsten electrode, ground to a sharp needle point making sure the grinding lines run with the length (longitudinally) of the electrode's axis. The length of the needle point should be approximately 2-3 x the diameter of the tungsten electrode.
4. Use Direct Current Electrode Negative (DC-) and Welding Grade Argon.
5. Preheat thick sections prior to welding. Heat a spot on the base metal until it shows signs of melting and progressively add the filler rod to the weld pool.

## JOINING PROCESS:

Gas Tungsten Arc (TIG) welding.

## TYPICAL ALL WELD DEPOSIT MECHANICAL PROPERTIES:

Yield Stress	425 MPa.
Tensile Strength	520 MPa.
Elongation	34%
CVN Impact Values	150 J av @ -29°C

## TYPICAL ROD ANALYSIS:

C: 0.06%	Mn: 1.08%	Si: 0.52%
Ti: 0.08%	Zr: 0.07%	Al: 0.08%
S: 0.007%	P: 0.008%	Fe: Balance

## COMPARABLE CIGWELD PRODUCTS:

Autocraft Super Steel GMAW wire  
AWS A5.18: ER70S-2

## Packaging Data:

Rod Size (mm)	Pack Weight/Type	Approx. Rods/kg	Part No
1.6 x 915	5kg Tube*	70	321370
2.4 x 915	5kg Tube*	31	321373

\* Resealable

## COMWELD CrMo1



- ▲ Resealable 5kg Cardboard Tube.
- ▲ For the Gas Tungsten Arc (TIG) Welding of Cr - Mo Creep Resistant Steels for Elevated Temperature and Corrosive Service.
- ▲ End Stamped with AWS Class ER80S-B2 for Easy Identification.

## Classifications:

AS 1167.2: RB2.  
AWS/ASME-SFA A5.28: ER80S-B2.

## Description and Applications:

Comweld CrMo1 is a copper coated steel TIG welding rod alloyed with nominally 1.25% Chromium (Cr) and 0.50% Molybdenum (Mo). It is recommended for the TIG welding of 1/2Cr-1/2Mo, 1Cr-1/2Mo and 1 1/4Cr-1/2Mo steel pipes, plates and castings used at elevated service temperatures (up to 550°C) in the power and petrochemical industries etc.

Comweld CrMo1 is also suitable for the dissimilar TIG welding of Cr-Mo steel to carbon steel and for the welding of case hardenable steels or steels which can be subsequently heat treated.

## Procedure for Gas Tungsten Arc (TIG) Welding:

1. Thoroughly clean all areas to be joined.
2. For the butt welding of thicker plates, bevel edges to 60°-70° included angle.
3. Use a Thoriated or Ceriated tungsten electrode, ground to a sharp needle point making sure the grinding lines run with the length (longitudinally) of the electrode's axis. The length of the needle point should be approximately 2-3 x the diameter of the tungsten electrode.
4. Use Direct Current Electrode Negative (DC-) and Welding Grade Argon.
5. The control of preheat, interpass and post weld heat treatment temperatures is critical to avoiding weld cracking. Heat a spot on the base metal until it shows signs of melting and progressively add the filler rod to the weld pool.

## TYPICAL ALL WELD METAL MECHANICAL PROPERTIES:

Welding Grade Argon:	
0.2% Proof Stress	500 MPa.
Tensile Strength	600 MPa.
Elongation (in 2 inches)	20%
CVN Impact Values	60 J av @ +20°C
Post weld heat treated at 620°C as required by AWS A5.28.	

## TYPICAL ROD ANALYSIS:

C: 0.09%	Mn: 0.60%	Si: 0.60%
Cr: 1.30%	Mo: 0.50%	P: 0.015%
S: 0.010%	Fe: Balance	

## COMPARABLE CIGWELD PRODUCTS:

Alloycraft 80-B2 electrode  
AWS A5.5: E8018-B2  
Autocraft CrMo1 GMAW wire  
AWS A5.28: ER80S-B2

## Packaging Data:

Rod Size (mm)	Pack Weight/Type	Approx. Rods/kg	Part No
2.4 x 1000	5kg Tube*	29	321379

\* Resealable



- ▲ Resealable 5kg Cardboard Tube.
- ▲ For the Gas Tungsten Arc (TIG) Welding of Cr-Mo and Cr-Mo-V Creep Resistant Steels for Elevated Temperature and Corrosive Service.
- ▲ End Stamped with AWS Class 'ER90S-B3' for Easy Identification.

### Classifications:

AS 1167.2:	RB3.
AWS/ASME-SFA A5.28:	ER90S-B3.

### Description and Applications:

Comweld CrMo2 is a copper coated steel TIG welding rod alloyed with nominally 2.5% Chromium (Cr) and 1.0% Molybdenum (Mo). It is recommended for the TIG welding of 2 1/4Cr - 1 Mo and Cr-Mo-V steel pipes, plates and castings used at elevated service temperatures (up to 600°C) in the power and petrochemical industries etc.

Comweld CrMo2 is also suitable for the dissimilar TIG welding of selected Cr-Mo steels to carbon steel and for the TIG welding of heat treatable steels and case hardenable steels with up to 3% Chromium content.

### Procedure for Gas Tungsten Arc (TIG) Welding:

1. Thoroughly clean all areas to be joined.
2. For the butt welding of thicker plates, bevel edges to 60°-70° included angle.
3. Use a Thoriated or Ceriated tungsten electrode, ground to a sharp needle point making sure the grinding lines run with the length (longitudinally) of the electrode's axis. The length of the needle point should be approximately 2-3 x the diameter of the tungsten electrode.
4. Use Direct Current Electrode Negative (DC-) and Welding Grade Argon.
5. The control of preheat, interpass and post weld heat treatment temperatures is critical to avoiding weld cracking. Heat a spot on the base metal until it shows signs of melting and progressively add the filler rod to the weld pool.

### TYPICAL ALL WELD METAL MECHANICAL PROPERTIES:

Welding Grade Argon:	
0.2% Proof Stress	560 MPa.
Tensile Strength	670 MPa.
Elongation (in 2 inches)	18%
CVN Impact Values	60 J av @ +20°C
Post weld heat treated at 690°C as required by AWS A5.28.	

### TYPICAL ROD ANALYSIS:

C: 0.08%	Mn: 0.70%	Si: 0.60%
Cr: 2.50%	Mo: 1.00%	P: 0.015%
S: 0.010%	Fe: Balance	

### COMPARABLE CIGWELD PRODUCTS:

Alloycraft 90-B3 electrode  
AWS A5.5: E9018-B3

### Packaging Data:

Rod Size (mm)	Pack Weight/Type	Approx. Rods/kg	Part No
2.4 x 1,000	5kg Tube*	29	321383

\* Resealable



## COMWELD 308L



- ▲ Resealable 5kg Plastic Tube.
- ▲ Suitable for Gas and GTA (TIG) Welding.
- ▲ End Stamped with AS / AWS Class '308L'.
- ▲ DARK BLUE COLOUR CODED Pack Label for Instant I.D.

## Classifications:

AS 1167.2:	R308L.
AWS/ASME-SFA A5.9:	ER308L.

## Description and Applications:

Comweld 308L stainless steel is a high quality low carbon rod for the Gas or Gas Tungsten Arc (TIG) welding of a wide range of low carbon and stabilised 300 series stainless steels. It is recommended for the critical welding of 304 and 304L stainless steels in corrosion resistant and cryogenic applications.

## Procedure for Gas (Oxy-acetylene) Welding:

1. Thoroughly clean all areas to be welded.
2. Adjust flame to a neutral setting.
3. Apply a Stainless Steel flux to filler rod and joint areas.
4. Preheat thicker joint sections.
5. Heat a small area of the joint until molten and progressively add Comweld 308L filler rod to the weld pool. Ensure the rod is melted by the molten weld pool and not the flame.
6. Allow completed joint to cool and remove residual flux by grinding and wire brushing. For the best cleaning and finishing results use CIGWELD "ChromeBright" pickling paste (Part No. 321918).

## Procedure for Gas Tungsten Arc (TIG) Welding:

1. Thoroughly clean all areas to be joined.
2. For the butt welding of thick plates, bevel edges to 60°-70° included angle.
3. Use a Thoriated or Ceriated tungsten electrode, ground to a sharp needle point making sure the grinding lines run with the length (longitudinally) of the electrode's axis. The length of the needle point should be approximately 2-3 x the diameter of the tungsten electrode.
4. Use Direct Current Electrode Negative (DC-) and Welding Grade Argon.
5. Preheat surfaces to be welded. Heat a spot on the base metal until it shows signs of melting and progressively add the filler rod to the weld pool.
6. For the best cleaning and finishing results use CIGWELD "ChromeBright" pickling paste (Part No. 321918).

## WELD DEPOSIT PROPERTIES:

Typical Weld Metal 0.2% Proof Stress	450 MPa.
Typical Weld Metal Tensile Strength	600 MPa.
Approximate Melting Point	1400°C
Weld Metal Density	7.95 gms / cm <sup>3</sup>
All Weld Metal Microstructure	Austenite with 5 - 8 % ferrite

## TYPICAL ROD ANALYSIS:

C: 0.015%	Mn: 1.90%	Si: 0.50%
Cr: 19.90%	Ni: 9.75%	P: 0.020%
S: 0.005%	Fe: Balance	

## COMPARABLE CIGWELD PRODUCTS:

Satincrome 308L-17 electrode  
 AWS A5.4: E308L-17  
 Murex Speedex 308L  
 AWS A5.4: E308L-18  
 Autocraft 308LSi GMAW wire  
 AWS A5.9: ER308LSi  
 Shieldcrome 308LT FCAW wires  
 AWS A5.22: E308LT-1/14

## Packaging Data:

Rod Size (mm)	Pack Weight/Type	Approximate Rods/kg	Part No
1.6 x 914	5kg Tube*	69	321406
2.4 x 914	5kg Tube*	30	321407

\* Resealable



- ▲ Resealable 5kg Plastic Tube.
- ▲ Suitable for Gas and GTA (TIG) Welding.
- ▲ End Stamped with AS / AWS Class '309L'.
- ▲ RED COLOUR CODED Pack Label for Instant I.D.

### Classifications:

AS 1167.2:	R309L
AWS/ASME-SFA A5.9:	ER309L

### Description and Applications:

Comweld 309L stainless steel is a high quality low carbon rod for the Gas or Gas Tungsten Arc (TIG) welding of highly alloyed 309 or 309L type stainless steels. Comweld 309L is also suitable for the dissimilar joining of other 300 series austenitic stainless steels to ferritic steels.

#### Procedure for Gas (Oxy-acetylene) Welding:

1. Thoroughly clean all areas to be welded.
2. Adjust flame to a neutral setting.
3. Apply a Stainless Steel flux to filler rod and joint areas.
4. Preheat thicker joint sections.
5. Heat a small area of the joint until molten and progressively add Comweld 309L filler rod to the weld pool. Ensure the rod is melted by the molten weld pool and not the flame.
6. Allow completed joint to cool and remove residual flux by grinding and wire brushing. For the best cleaning and finishing results use CIGWELD "ChromeBright" pickling paste (Part No. 321918).

#### Procedure for Gas Tungsten Arc (TIG) Welding:

1. Thoroughly clean all areas to be joined.
2. For the butt welding of thick plate, bevel edges to 60°-70° included angle.
3. Use a Thoriated or Ceriated tungsten electrode, ground to a sharp needle point making sure the grinding lines run with the length (longitudinally) of the electrode's axis. The length of the needle point should be approximately 2-3 x the diameter of the tungsten electrode.
4. Use Direct Current Electrode Negative (DC-) and Welding Grade Argon.
5. Preheat surfaces to be welded. Heat a spot on the base metal until it shows signs of melting and progressively add the filler rod to the weld pool.
6. For the best cleaning and finishing results use CIGWELD "ChromeBright" pickling paste (Part No. 321918).

### WELD DEPOSIT PROPERTIES:

Typical Weld Metal	0.2%
Proof Stress	440 MPa.
Typical Weld Metal Tensile Strength	590 MPa.
Approximate Melting Point	1400°C
Weld Metal Density	7.95 gms / cm <sup>3</sup>
All Weld Metal Microstructure	Austenite with 15 – 20 % ferrite

### TYPICAL ROD ANALYSIS:

C: 0.015%	Mn: 1.90%	Si: 0.45%
Cr: 23.5%	Ni: 13.5%	P: 0.020%
S: 0.005%	Fe: Balance	

### COMPARABLE CIGWELD PRODUCTS:

Satinchrome 309Mo-17 electrode  
 AWS A5.4: E309Mo-17  
 Murex Speedex 309L  
 AWS A5. 4: E309L-16  
 Autocraft 309LSi GMAW wire  
 AWS A5.9: ER309LSi  
 Shieldchrome 309LT FCAW wires  
 AWS A5.22: E309LT1-1/4

### Packaging Data:

Rod Size (mm)	Pack Weight/Type	Approximate Rods/kg	Part No
1.6 x 914	5kg Tube*	69	321403
2.4 x 914	5kg Tube*	30	321404

\* Resealable

## COMWELD 316L



- ▲ Resealable 5kg Plastic Tube.
- ▲ Suitable for Gas and GTA (TIG) Welding.
- ▲ End Stamped with AS / AWS Class '316L'.
- ▲ GOLD COLOUR CODED Pack Label for Instant I.D.

## Classifications:

AS 1167.2: R316L.  
AWS/ASME-SFA A5.9: ER316L.

## Description and Applications:

Comweld 316L stainless steel is a high quality low carbon rod for the Gas or Gas Tungsten Arc (TIG) welding of Molybdenum bearing stainless steels; in particular matching 316 and 316L alloys. Comweld 316L is also suitable for the general welding of other 300 series stainless steels including 302 and 304; as well as ferritic stainless steels grades such as 409, 444 and 3Cr12.

## Procedure for Gas (Oxy-acetylene) Welding:

1. Thoroughly clean all areas to be welded.
2. Adjust flame to a neutral setting.
3. Apply a Stainless Steel flux to filler rod and joint areas.
4. Preheat thicker joint sections.
5. Heat a small area of the joint until molten and progressively add Comweld 316L filler rod to the weld pool. Ensure the rod is melted by the molten weld pool and not the flame.
6. Allow completed joint to cool and remove residual flux by grinding and wire brushing. For the best cleaning and finishing results use CIGWELD "ChromeBright" pickling paste (Part No. 321918).

## Procedure for Gas Tungsten Arc (TIG) Welding:

1. Thoroughly clean all areas to be joined.
2. For the butt welding of thick plates, bevel edges to 60°-70° included angle.
3. Use a Thoriated or Ceriated tungsten electrode, ground to a sharp needle point making sure the grinding lines run with the length (longitudinally) of the electrode's axis. The length of the needle point should be approximately 2-3 x the diameter of the tungsten electrode.
4. Use Direct Current Electrode Negative (DC-) and Welding Grade Argon.
5. Preheat surfaces to be welded. Heat a spot on the base metal until it shows signs of melting and progressively add the filler rod to the weld pool.
6. For the best cleaning and finishing results use CIGWELD "ChromeBright" pickling paste (Part No: 321918)

## WELD DEPOSIT PROPERTIES:

Typical Weld Metal	0.2%
Proof Stress	470 MPa.
Typical Weld Metal Tensile Strength	640 MPa.
Approximate Melting Point	1400°C
Weld Metal Density	7.95 gms / cm <sup>3</sup>
All Weld Metal Microstructure	Austenite with 7 – 10 % ferrite

## TYPICAL ROD ANALYSIS:

C: 0.012%	Mn: 1.57%	Si: 0.50%
Cr: 19.00%	Ni: 12.6%	Mo: 2.50%
P: 0.015%	S: 0.001%	Fe: Balance

## COMPARABLE CIGWELD PRODUCTS:

Satinchrome 316L-17 electrode  
AWS A5.4: E316L-17  
Murex Speedex 316L  
AWS A5.4: E316L-16  
Autocraft 316LSi GMAW wire  
AWS A5.9: ER316LSi  
Shieldchrome 316LT FCAW wires  
AWS A5.20: E316LT1-1/4

## Packaging Data:

Rod Size (mm)	Pack Weight/Type	Approximate Rods/kg	Part No
1.6 x 914	5kg Tube*	69	321400
	25 Rod Handipack	-	322054
2.4 x 914	5kg Tube*	30	321401

\* Resealable

## COMWELD 2209 STAINLESS STEEL TIG ROD



- ▲ For the GTA (TIG) welding of 22%Cr/5%Ni/3%Mo duplex type stainless steels.
- ▲ Resealable 5kg cardboard tube.
- ▲ Suitable for GTA (TIG) welding.
- ▲ End stamped with AWS Class 'ER2209' for easy identification.

## Classifications:

AWS/ASME-SFA A5.9: ER2209.  
Werkstoffe No: 1.4462

## Description and Applications:

Comweld 2209 is a stainless steel TIG welding rod suitable for the gas tungsten arc (TIG) welding of 22Cr/5Ni/3Mo type duplex stainless steels. Applications include the welding of duplex stainless steels as used where corrosion and pitting resistance is required.

Base metals welded with with Comweld 2209 include S39205 (2205 and Bohler A903) and S39230 (2304).

Comweld 2209 is recommended for the joining of duplex stainless steel pipes and tanks used in the chemical industry that require high resistance to stress and pitting corrosion in chloride and hydrogen sulphide media.

## Procedure for Gas Tungsten Arc (TIG) Welding:

1. Thoroughly clean all areas to be joined.
2. For the butt welding of thick plates, bevel edges to 60°-70° included angle.
3. Use a Thoriated or Ceriated tungsten electrode, ground to a sharp needle point making sure the grinding lines run with the length (longitudinally) of the electrode's axis. The length of the needle point should be approximately 2-3 x the diameter of the tungsten electrode.
4. Use Direct Current Electrode Negative (DC-) and Welding Grade Argon.
5. Preheat thick sections prior to welding. Heat a spot on the base metal until it shows signs of melting and progressively add the filler rod to the weld pool.
6. For the best cleaning and finishing results use CIGWELD ChromeBright pickling paste (Part No. 321918).

## JOINING PROCESS:

Gas Tungsten Arc (TIG) welding.

## TYPICAL ALL WELD DEPOSIT MECHANICAL PROPERTIES:

0.2% Proof Stress	600 MPa.
Tensile Strength	765 MPa.
Metal Density	7.95 gms / cm <sup>3</sup>
Microstructure	Austenite & ferrite (≈ 50:50)

## FERRITE NUMBER:

30-50 FN (Procedure dependent)

## TYPICAL ROD ANALYSIS:

C: 0.012%	Mn: 1.06%	Si: 0.44%
Cr: 22.80%	Ni: 8.63%	Mo: 3.10%
N: 0.14%	P: 0.018%	S: 0.007%
Cu: 0.06%	Fe: Balance	

## COMPARABLE CIGWELD PRODUCTS:

Autocraft 2209 GMAW wire  
AWS A5.9: E2209

## Packaging Data:

Rod Size (mm)	Pack Weight/Type	Approx. Rods/kg	Part No
1.6 x 1000	5kg Cardboard Tube*	69	321393
2.4 x 1000	5kg Cardboard Tube*	30	321394

\* Resealable

## COMWELD AL1100



- ▲ 99.88% Pure Aluminium Alloy Rod.
- ▲ Suitable for Gas Welding and Gas Tungsten Arc (GTAW / TIG) Welding Applications.
- ▲ Embossed with AS / AWS Class '1100.
- ▲ 2.5 kg Cardboard Pack / 15kg Carton.

## Classifications:

AS 1167.2:	R1100.
AWS/ASME-SFA A5.10:	R1100.

## Description and Applications:

Comweld AL1100 is a premium quality, pure (99.88% min) Aluminium alloy rod recommended for the Gas or Gas Tungsten Arc (TIG) welding of selected\* 1XXX series wrought Aluminium alloys. The lower weld deposit strength, excellent corrosion resistance and high thermal and electrical conductivity make Comweld AL1100 ideal for the joining of selected high purity 1XXX series Aluminium sheets and plates used extensively in the electrical and chemical industries. Comweld AL1100 produces a good colour match in anodised 1XXX series welded joints.

\*See CIGWELD Aluminium Alloy Selection Chart for detailed welding consumable selection criteria for a wide range of Aluminium alloy parent metals.

## Procedure for Gas Tungsten Arc (TIG) Welding:

1. Thoroughly clean all areas to be joined.
2. For the butt welding of thick plates, bevel edges to 65°-75° included angle.
3. Use a Zirconiated tungsten electrode, ground to a tapered blunt point (half the diameter of electrode) making sure the grinding lines run with the length (longitudinally) of the electrode's axis. The length of the point should be approximately 2-3 x the diameter of the tungsten electrode. For best results the tungsten electrode requires a radius or 'balled' end, this is done by heating the newly prepared tungsten at approximately 30 amps higher than the recommended welding current under the welding arc.
4. Use High Frequency stabilised Alternating Current (AC-HF) and Welding Grade Argon.
5. Preheat thick sections before welding. Heat a spot on the base metal until it shows signs of melting and progressively add the filler rod to the weld pool.

## Procedure for Gas (Fusion) Welding:

1. Thoroughly clean all areas to be welded either mechanically or chemically.
2. Adjust flame to a soft neutral setting, or one with a slight haze at the tip of the cone.
3. Apply Comweld Aluminium flux (Part Number: 321740) to filler rod and joint areas.
4. The edges of the joint should be heated to melting point and Comweld AL1100 filler rod added to the molten weld pool. Ensure the rod is melted by the molten weld pool and not the flame.
5. When welding in the downhand position, the blowpipe movement should be straight forward, with no sideways movement or weaving, to confine the heat in the weld area.
6. The blowpipe tip should be held at about 45° to the work piece and slightly decreased as the weld progresses. The filler rod is similarly inclined from 30° - 40°.
7. The flux must be removed on completion by washing in hot water or immersion (for approximately 10 minutes) in a dilute solution (5 - 10%) of nitric acid. The acid must be removed by washing with water after the flux has been removed.

## WELD DEPOSIT PROPERTIES:

Typical Weld Metal Tensile Strength	75 MPa.
Approximate Melting Point	660°C
Post Anodised colour tint	Clear

## ROD ANALYSIS LIMITS:

Single values are maximum allowable, unless otherwise stated.

Si: 0.06%	Fe: 0.06%	Cu: 0.005%
Mn: 0.01%	Mg: 0.01%	Zn: 0.03%
Ti: 0.01%	Others each: 0.01%	
Al: 99.88% min		

## COMPARABLE CIGWELD PRODUCTS:

Autocraft AL1100 GMAW wire  
AWS A5.10: ER1100

## Packaging Data:

Rod Size (mm)	Pack Weight/Type	Carton Size	Approx. Rods/kg	Part No
1.6 x 914	2.5kg Pack	15kg	30	322600
2.4 x 914	2.5kg Pack	15kg	30	322601



- ▲ Aluminium - 5% Silicon Alloy Rod.
- ▲ Suitable for Gas Welding and Gas Tungsten Arc (GTAW / TIG) Welding Applications.
- ▲ Embossed with AS / AWS Class '4043'.
- ▲ 2.5 kg Cardboard Pack / 15kg Carton.

### Classifications:

AS 1167.2: R4043.  
AWS/ASME-SFA A5.10: R4043.

### Description and Applications:

Comweld AL4043 is a premium quality Aluminium - nominal 5% Silicon alloy rod used extensively for the repair welding (fractures and blow holes etc) of selected\* aluminium alloy castings.

Its lower weld deposit strength and excellent crack resistance make it suitable for the Gas or Gas Tungsten Arc (GTAW / TIG) welding of cast (mainly 4XX & 6XX series) alloys and wrought (selected 1XXX, 5XXX & 6XXX series) aluminium alloys, except where an accurate colour match is required after anodising.

\*See CIGWELD Aluminium Alloy Selection Chart for detailed welding consumable selection criteria for a wide range of Aluminium alloy parent metals.

#### Procedure for Gas Tungsten Arc (TIG) Welding:

1. Thoroughly clean all areas to be joined.
2. For the butt welding of thick plates, bevel edges to 65°-75° included angle.
3. Use a Zirconiated tungsten electrode, ground to a tapered blunt point (half the diameter of electrode) making sure the grinding lines run with the length (longitudinally) of the electrode's axis. The length of the point should be approximately 2-3 x the diameter of the tungsten electrode. For best results the tungsten electrode requires a radius or 'balled' end, this is done by heating the newly prepared tungsten at approximately 30 amps higher than the recommended welding current under the welding arc.
4. Use High Frequency stabilised Alternating Current (AC-HF) and Welding Grade Argon.
5. Preheat thick sections before welding. Heat a spot on the base metal until it shows signs of melting and progressively add the filler rod to the weld pool.

#### Procedure for the Gas (Fusion) Welding of a Fractured Aluminium Casting:

1. Thoroughly clean all areas to be welded either mechanically or chemically.
2. Apply Comweld Aluminium flux (Part Number: 321740) to the areas to be joined.
3. Adjusting the flame to a soft neutral setting, or one with a slight haze at the tip of the cone, pre-heat the casting and tack weld the parts into position when the correct temperature is reached.
4. Begin at the centre of the fracture completing one side and then the other. Welding speed should be increased towards the ends of the fracture.
5. Allow the repaired casting to cool slowly.
6. The flux residue must be removed on completion by washing in hot water or immersion (for approximately 10 minutes) in a dilute solution (5 - 10%) of nitric acid. The acid must be removed by washing with water after the flux has been removed.

#### WELD DEPOSIT PROPERTIES:

Typical Weld Metal Tensile Strength	110 MPa.
Approximate Melting Point	630°C
Post Anodised colour tint	Grey

#### ROD ANALYSIS LIMITS:

Single values are maximum allowable, unless otherwise stated.

Si: 4.5-6.0%	Fe: 0.80%	Cu: 0.30%
Mn: 0.05%	Mg: 0.05%	Zn: 0.10%
Ti: 0.20%	Total others: 0.15%	
Al: Balance		

#### COMPARABLE CIGWELD PRODUCTS:

Autocraft AL4043 GMAW wire  
AWS A5.10: ER4043

### Packaging Data:

Rod Size (mm)	Pack Weight/Type	Carton Size	Approx. Rods/kg	Part No
1.6 x 914	2.5kg Pack	15kg	210	321610
2.4 x 914	2.5kg Pack	15kg	90	321611
3.2 x 914	2.5kg Pack	15kg	51	321612

## COMWELD AL4047



- ▲ Aluminium - 10% Silicon Alloy Rod.
- ▲ Suitable for Gas Welding and Gas Tungsten Arc (GTAW / TIG) Welding Applications.
- ▲ Embossed with AS / AWS Class '4047'.
- ▲ 2.5 kg Cardboard Pack / 15kg Carton.

## Classifications:

AS 1167.2:	R4047.
AWS/ASME-SFA A5.10:	R4047.
AWS/ASME-SFA A5.8:	BA5i-4.

## Description and Applications:

Comweld AL4047 is a premium quality Aluminium - nominal 10% Silicon alloy rod used extensively for the brazing of many types of Aluminium alloy sheets, extruded shapes and castings.

Used in combination with Comweld Aluminium Brazing Flux, the lower melting range and excellent flow characteristics make

Comweld AL4047 ideal for brazing or braze welding applications, producing sound weld deposits with low parent metal distortion.

## Procedure for Gas Tungsten Arc (TIG) Welding:

1. Thoroughly clean all areas to be joined.
2. For the butt welding of thick plates, bevel edges to 65°-75° included angle.
3. Use a Zirconiated tungsten electrode, ground to a tapered blunt point (half the diameter of electrode) making sure the grinding lines run with the length (longitudinally) of the electrode's axis. The length of the point should be approximately 2-3 x the diameter of the tungsten electrode. For best results the tungsten electrode requires a radius or 'balled' end, this is done by heating the newly prepared tungsten at approximately 30 amps higher than the recommended welding current under the welding arc.
4. Use High Frequency stabilised Alternating Current (AC-HF) and Welding Grade Argon.
5. Preheat thick sections before welding. Heat a spot on the base metal until it shows signs of melting and progressively add the filler rod to the weld pool.

## Procedure for Brazing:

1. Thoroughly clean all surfaces to be welded either mechanically or chemically.
2. Apply an Aluminium Brazing flux to areas to be joined.
3. Adjusting the flame to a soft neutral setting, or one with a slight haze at the tip of the cone.
4. Preheat the joint using the envelope of the flame, ensuring that the inner cone is well clear of the the parent metal.
5. The blow pipe and filler rod should be held at approximately the same angle as for fusion welding, 45° and 30° - 40° respectively.
6. At the correct temperature the flux will begin to flow smoothly. At this time, a small amount of Comweld AL4047 filler rod should be added and the rod withdrawn.
7. The flux residue must be removed on completion by washing in hot water or immersion (for approximately 10 minutes) in a dilute solution (5 - 10%) of nitric acid. The acid must be removed by washing with water after the flux has been removed.

## WELD DEPOSIT PROPERTIES:

Typical Weld Metal Tensile Strength	150 MPa.
Approximate Melting Range	577 - 582°C
Post Anodised colour tint	Grey - Black

## ROD ANALYSIS LIMITS:

Single values are maximum allowable, unless otherwise stated.

Si: 11.0-13.0%	Fe: 0.80%	Cu: 0.30%
Mn: 0.15%	Mg: 0.10%	Zn: 0.20%
Total others: 0.15%	Al: Balance	

## Packaging Data:

Rod Size (mm)	Pack Weight/Type	Carton Size	Approx. Rods/kg	Part No
1.6 x 914	2.5kg Pack	15kg	210	321620
	100 Rod Handipack	8 Pks	-	322070
2.4 x 914	2.5kg Pack	15kg	90	321621
	50 Rod Handipack	8 Pks	-	322071
3.2 x 914	2.5kg Pack	15kg	51	321622



- ▲ Aluminium - 5% Magnesium Alloy Rod.
- ▲ Suitable for Gas Welding and Gas Tungsten Arc (GTAW / TIG) Welding Applications.
- ▲ Embossed with AS / AWS Class '5356'.
- ▲ 2.5 kg Cardboard Pack / 15kg Carton.

### Classifications:

AS 1167.2: R5356.  
AWS/ASME-SFA A5.10: R5356.

### Description and Applications:

Comweld AL5356 is a high quality, Aluminium - nominal 5% Magnesium alloy rod suitable for the Gas or Gas Tungsten Arc (TIG) welding of a wide range of cast and wrought Aluminium alloys. It produces intermediate deposit strength and good ductility and corrosion resistance for the Gas or Gas Tungsten Arc Welding (GTAW / TIG) of a wide range of 3XXX, 5XXX, 6XXX and 5XX Aluminium alloys. See CIGWELD Aluminium Alloy Selection Chart for detailed welding consumable selection criteria for a wide range of Aluminium alloy parent metals.

### Procedure for Gas Tungsten Arc (TIG) Welding:

1. Thoroughly clean all areas to be joined.
2. For the butt welding of thick plates, bevel edges to 65°-75° included angle.
3. Use a Zirconiated tungsten electrode, ground to a tapered blunt point (half the diameter of electrode) making sure the grinding lines run with the length (longitudinally) of the electrode's axis. The length of the point should be approximately 2-3 x the diameter of the tungsten electrode. For best results the tungsten electrode requires a radius or 'balled' end, this is done by heating the newly prepared tungsten at approximately 30 amps higher than the recommended welding current under the welding arc.
4. Use High Frequency stabilised Alternating Current (AC-HF) and Welding Grade Argon.
5. Preheat thick sections before welding. Heat a spot on the base metal until it shows signs of melting and progressively add the filler rod to the weld pool.

### Procedure for Gas (Fusion) Welding:

1. Thoroughly clean all areas to be welded either mechanically or chemically.
2. Adjust flame to a soft neutral setting, or one with a slight haze at the tip of the cone.
3. Apply Comweld Aluminium flux (Part Number: 321740) to filler rod and joint areas.
4. The edges of the joint should be heated to melting point and Comweld AL5356 filler rod added to the molten weld pool. Ensure the rod is melted by the molten weld pool and not the flame.
5. When welding in the downhand position, the blowpipe movement should be straight forward, with no sideways movement or weaving, to confine the heat in the weld area.
6. The blowpipe tip should be held at about 45° to the work piece and slightly decreased as the weld progresses. The filler rod is similarly inclined from 30° - 40°.
7. The flux must be removed on completion by washing in hot water or immersion (for approximately 10 minutes) in a dilute solution (5 - 10%) of nitric acid. The acid must be removed by washing with water after the flux has been removed.

### WELD DEPOSIT PROPERTIES:

Typical Weld Metal Tensile Strength	270 MPa.
Approximate Melting Point	640°C
Post Anodised colour tint	White

### ROD ANALYSIS LIMITS:

Single values are maximum allowable, unless otherwise stated.

Si: 0.25%	Fe: 0.40%	Cu: 0.10%
Mn: 0.05-0.20%	Mg: 4.5-5.5%	Cr: 0.05-0.20%
Zn: 0.10%	Ti: 0.05-0.20%	
Total others: 0.15% Al: Balance		

### COMPARABLE CIGWELD PRODUCTS:

Autocraft AL5356 GMAW wire  
AWS A5.10: ER5356

### Packaging Data:

Rod Size (mm)	Pack Weight/Type	Carton Size	Approx. Rods/kg	Part No
1.6 x 914	2.5kg Pack	15kg	210	321640
2.4 x 914	2.5kg Pack	15kg	90	321641
	40 Rod Handipak	8 Pks	-	322078
3.2 x 914	2.5kg Pack	15kg	51	321642



## COMWELD GENERAL PURPOSE, CAST IRON ROD

**Classifications:**

AS 1167.2:

RC11.

**Description and Applications:**

A high strength, general purpose, machinable cast iron alloy for joining and building up grey cast iron castings. Applications include maintenance & repair by TIG or oxy-acetylene welding, of machine bases, motor and gear housings and specially cast components. Excellent for thin sections, filling in surface porosity and building up worn or missing sections. Molten cast iron is extremely fluid and welding should be carried out in the downhand position. Colour match of finished welds to that of the parent metal is excellent.

**Procedure for Gas (Oxy-acetylene) Welding:**

1. Chip file or grind all scale and oxide from areas to be joined.
2. Bevel all breaks and cracks to form a 75°-90° 'V' or groove.
3. Before commencing to weld preheat to a dull red heat = approximately 650°C.
4. Adjust flame to neutral setting.
5. Heat the end of the filler rod.
6. Dip end of heated rod into a Cast Iron and using a slight circular movement of the flame to the end of the rod and the bottom edges of the 'V', bring to melting point.  
When the material is ready to melt, it will become soft and have the appearance of being wet. At this point, lower the filler rod onto the base metal and allow about 5mm of the rod to melt in the puddle.
7. Continue this circular movement of the flame playing it on the weld metal and the base metal until they are thoroughly fused.
8. When welding is completed, reheat to a dull red and allow to cool slowly.
9. Remove flux residue by washing in hot water or immersing for 10 minutes in a dilute solution of nitric acid (5-10%). The acid must be rinsed off by washing in water after the flux has been removed.

**Procedure for Gas Tungsten Arc Welding (TIG):**

1. Chip file or grind all scale and oxide from areas to be joined.
2. Bevel all breaks and cracks to form a 75°-90° 'V' or groove.
3. Before commencing to weld preheat to a dull red heat = approximately 650°C.
4. Use a Thoriated or Ceriated tungsten electrode, ground to a sharp needle point making sure the grinding lines run with the length (longitudinally) of the electrode's axis. The length of the needle point should be approximately 2-3 x the diameter of the tungsten electrode.
5. Use Direct Current Electrode Negative (DC-) and Welding Grade Argon.
6. Apply to the weld pool by melting off small quantities from the end of the rod at a 45° angle (as you would melt a candle with a match).
7. When welding is completed, reheat to a dull red and allow to cool slowly.

**TIP COLOUR:**

Blue

**JOINING PROCESS:**

Gas (Fusion) and Gas Tungsten Arc Welding (TIG).

**TYPICAL PROPERTIES:**

All Weld Metal Tensile Strength	230 MPa.
Approximate Melting Point	1150°C.

**TYPICAL ROD ANALYSIS:**

C: 3.37%	Mn: 0.75%	Si: 3.25%
S: 0.008%	P: 0.011%	Fe: Balance

**Packaging Data:**

Rod Size (mm)	Pack Weight/Type	Approximate Rods/kg	Part No
5.0 x 700	2.5kg Pack	8	321420



## Description and Applications:

COMWELD Galvanising Bar is an alloy which when applied on a heated base metal, will melt and produce a strong corrosion-resistant alloy coating. This alloy can be used as a pre-treatment to protect base metals and forms a strong permanent bond to the surface. COMWELD Galvanising Bar can be used where any welding of galvanised parts is done. It can be used with gas or electric welding.

### Procedure:

1. Thoroughly clean all areas to be galvanised removing any rust, slag, flux residue and foreign material.
2. Preheat the base metal to a temperature of 300°C.
3. Rub the end of the bar on the area to be coated. If the base metal is not hot enough the bar will not melt off effectively. If the base metal is too hot the bar will run too freely and excessive coating will result.
4. Allow the molten alloy to cool slightly then wire brush or wipe the deposit to completely cover the weld area. This greatly strengthens and improves the finish.
5. Do not melt the alloy with a flame.

### TYPICAL PROPERTIES:

Approximate Melting Point 300°C.

### TYPICAL ROD ANALYSIS:

Pb: 57.50% (Lead)

Sn: 32.50% (Tin)

Zn: 10.00% (Zinc)

### Packaging Data:

Rod Size (mm)	Pack Weight/Type	Easyweld Handipack	Part No
6.3 x 500	2.5kg Pack		321695
6.3 x 500		2 Rod Handipack	322085

## COMWELD MANGANESE BRONZE ROD



- ▲ General Purpose Brazing Alloy.
- ▲ Recommended for Braze Welding of Steels and Cast and Malleable Irons.
- ▲ Not Suitable for Copper Pipes in Hot Water Systems.
- ▲ BLUE End Tip Colour for Instant I.D.

**JOINING PROCESS:**

Gas (Braze) Welding only.

**TYPICAL WELD DEPOSIT PROPERTIES:**

Weld Metal Tensile Strength	460 MPa
0.2% Proof Stress	165 MPa
Elongation	35%
Approximate Melting Point	890°C.
Weld Metal Density	8.39 gms / cm <sup>3</sup>

**TYPICAL ROD ANALYSIS:**

Zn: 40.5%	Mn: 0.10%	Si: 0.10%
Sn: 1.0%	Fe: 0.50%	Cu: Balance

**COMPARABLE CIGWELD PRODUCTS:**

Comcoat C Flux Coated Manganese Bronze  
AS 1167.1 & .2: R Cu Zn-C

**Classifications:**

AS 1167. Parts 1 & 2: R Cu Zn-C.  
AWS/ASME-SFA A5.8 / A5.27: RB Cu Zn-C.

**Description and Applications:**

Comweld Manganese Bronze is a low fuming, general purpose bronze filler rod. Because of its high bond (transverse tensile) strength, it is recommended for the braze welding of steel, cast iron and malleable iron.

Comweld Manganese Bronze is not recommended for the joining of copper pipes which carry hot water or sea water because of dezincification of the bronze causing failure of the joint. For these applications Comweld Tobin Bronze or Comcoat T should be used.

Comweld Manganese Bronze is the ideal maintenance rod for a wide range of braze welding applications including the joining of cast iron, malleable iron, steel, etc - it is a must for the workshop.

**Procedure for Braze Welding:**

1. Thoroughly clean all areas to be joined.
2. For best results on steel use Comweld Copper and Brass flux (Part Number: 321822) and for cast iron use a Bronze flux. Adjust flame to slightly oxidising.
3. Preheat the edges to be joined to a dull red colour. Dip the end of the heated rod into the flux and, at the same time, heat both edges of the job to an equal degree. Ensure that 'tinning' has taken place on the required joint surfaces.
4. Melting of the base material is not required in braze welding and care should be taken to control the heat in the joint.
5. Continue adding the rod to build up the braze to the desired size and shape.
6. Allow the joint to cool and remove the flux residue with a wire brush or by immersion in a dilute acid solution followed by a water rinse.

**Packaging Data:**

Rod Size (mm)	Pack Weight/Type	Approximate Rods/kg	Part No
1.6 x 750	5kg Pack	83	321195
2.4 x 750	5kg Pack	37	321199
3.2 x 750	5kg Pack	20	321202
5.0 x 750	5kg Pack	8	321203
6.3 x 750	5kg Pack	5	321204

- ▲ Flux Coated Manganese Bronze Rod.
- ▲ General Purpose Brazing Alloy.
- ▲ Recommended for Braze Welding of Steels and Cast and Malleable Irons.
- ▲ Not Suitable for Copper Pipes in Hot Water Systems.
- ▲ BLUE Flux Colour for Instant I.D.

### Classifications:

AS 1167. Parts 1 & 2: R Cu Zn-C.  
 AWS/ASME-SFA A5.8/A5.27: RB Cu Zn-C.

### Description and Applications:

Comweld Comcoat C a self fluxing, low fuming, Manganese Bronze filler rod. Because of its high bond (transverse tensile strength), it is recommended for the braze welding of steel, cast iron and malleable iron.

Comweld Comcoat C is not recommended for the joining of copper pipes which carry hot water or sea water because of dezincification of the bronze causing failure of the joint. For these applications Comweld Tobin Bronze or Comcoat T should be used.

Comweld Comcoat C Manganese Bronze is the ideal maintenance rod for a wide range of self fluxing braze welding applications including the joining of cast iron, malleable iron, steel, etc - it is a must for the workshop.

### Procedure for Braze Welding:

1. Thoroughly clean all areas to be joined.
2. Adjust flame to slightly oxidising.
3. Preheat the edges to be joined to a dull red colour. Melt the end of the flux coated rod and, at the same time, heat both edges of the job to an equal degree. Ensure that 'tinning' has taken place on the required joint surfaces.
4. Melting of the base material is not required in braze welding and care should be taken to control the heat in the joint.
5. Continue adding the rod to build up the joint to the desired size and shape.
6. Allow the joint to cool and remove the flux residue with a wire brush or by immersion in a dilute acid solution followed by a water rinse.

### Packaging Data:

Rod Size (mm)	Pack Weight/Type	Easyweld Handipack	Blister Pack	Approximate Rods/kg	Part No
2.4 x 500	2.5kg Pack			50	321191
		20 Rod Handipack		-	322020
			5 Rod Blister Pack	-	322206
3.2 x 750	5kg Pack			19	321186
		15 Rod Handipack		-	322021

### JOINING PROCESS:

Gas (Braze) Welding only.

### TYPICAL WELD DEPOSIT PROPERTIES:

Weld Metal Tensile Strength	460 MPa
0.2% Proof Stress	165 MPa
Elongation	35%
Approximate Melting Point	890°C.
Weld Metal Density	8.39 gms / cm <sup>3</sup>

### TYPICAL ROD ANALYSIS:

Zn: 40.5%	Mn: 0.10%	Si: 0.10%
Sn: 1.0%	Fe: 0.50%	Cu: Balance

### COMPARABLE CIGWELD PRODUCTS:

Comweld Manganese Bronze Bare Rod  
 AS 1167.1 & 2: R Cu Zn-C

## COMWELD TOBIN BRONZE ROD



- ▲ Low Strength Copper - Zinc Brazing Alloy.
- ▲ Recommended for the Fusion or Braze Welding of Selected Brasses and Bronzes.
- ▲ Suitable for Low Strength brazing of Steels.
- ▲ Not Suitable for Cast Irons.
- ▲ WHITE End Tip Colour for Instant I.D.

**JOINING PROCESS:**

Gas (Fusion and Braze) Welding only.

**TYPICAL WELD DEPOSIT PROPERTIES:**

Weld Metal Tensile Strength	400 MPa
0.2% Proof Stress	110 MPa
Elongation	45%
Approximate Melting Point	900°C.
Weld Metal Density	8.41 gms / cm <sup>3</sup>

**TYPICAL ROD ANALYSIS:**

Zn: 37.5%	Si: 0.30%	Sn: 0.50%
Cu: Balance		

**COMPARABLE CIGWELD PRODUCTS:**

Comcoat T flux coated Tobin Bronze  
AS1167.1 & 2: R Cu Zn-A

**Classifications:**

AS 1167. Parts 1 & 2:	R Cu Zn-A.
AWS/ASME-SFA A5.8/A5.27:	RB Cu Zn-A.

**Description and Applications:**

Comweld Tobin Bronze is a low fuming rod recommended for the fusion welding or braze welding of selected brass and bronze alloys. It is also suitable for the non-critical brazing of mild steel in low stress applications. Comweld Manganese Bronze is the preferred filler rod for the higher strength braze welding of ferrous metals.

Comweld Tobin Bronze is ideal for braze welding joints in brass and bronze and is also used for the braze welding of mild steel in low stress applications such as the 'filling' of car body panels.

**Procedure for Braze Welding:**

1. Thoroughly clean all areas to be joined.
2. For best results on Copper and Copper alloys use Comweld Copper and Brass flux (Part Number: 321822) and adjust the flame to contain a slight excess of oxygen.
3. Preheat the edges to be joined to a dull red colour. Dip the end of the heated rod into the flux and, at the same time, heat both edges of the job to an equal degree. Ensure that tinning has taken place on the required surfaces.
4. Continue adding the rod to build up the joint to the desired size and shape.
5. Allow the joint to cool and remove the flux residue with a wire brush or by immersion in a dilute acid solution followed by a water rinse.

**Packaging Data:**

Rod Size (mm)	Pack Weight/Type	Easyweld Handipack	Approximate Rods/kg	Part No
1.6 x 750	5kg Pack		83	321246
2.4 x 750	5kg Pack		37	321247
3.2 x 750	5kg Pack		20	321249
		15 Rod Handipack	—	322038
5.0 x 750	5kg Pack		8	321250



- ▲ Flux Coated Tobin Bronze Rod.
- ▲ Recommended for the 'Self Fluxing' Fusion Braze Welding of Selected Brasses & Bronzes.
- ▲ Suitable for Low Strength brazing of Steels.
- ▲ Not Suitable for Cast Irons.
- ▲ WHITE Flux Colour for Instant I.D.

**JOINING PROCESS:**

Gas (Fusion and Braze) Welding only.

**TYPICAL WELD DEPOSIT PROPERTIES:**

Weld Metal Tensile Strength	400 MPa
0.2% Proof Stress	110 MPa
Elongation	45%
Approximate Melting Point	900°C.
Weld Metal Density	8.41 gms / cm <sup>3</sup>

**TYPICAL ROD ANALYSIS:**

Zn: 37.5%	Si: 0.30%	Sn: 0.50%
Cu: Balance		

**COMPARABLE CIGWELD PRODUCTS:**

Comweld Tobin Bronze Bare Rod  
AS1167.1 & .2: R Cu Zn-A

**Classifications:**

AS 1167. Parts 1 & 2:	R Cu Zn-A.
AWS/ASME-SFA A5.8/A5.27:	RB Cu Zn-A.

**Description and Applications:**

Comweld Comcoat T is a low fuming Tobin Bronze filler rod recommended for the self fluxing fusion welding or braze welding of selected brass and bronze alloys. It is also suitable for the non-critical brazing of mild steel in low stress applications. Comweld Manganese Bronze or Comcoat C is the preferred filler rod for the higher strength braze welding of ferrous metals. Comweld Comcoat T Tobin Bronze is the ideal self fluxing filler rod for welding selected brass and bronze alloys and is also used for the braze welding of mild steel in low stress applications such as the 'filling' of car body panels.

**Procedure for Braze Welding:**

1. Thoroughly clean all areas to be joined.
2. Adjust the flame to slightly oxidising.
3. Preheat the edges to be joined to a dull red colour. Melt the end of the flux coated rod and, at the same time, heat both edges of the job to an equal degree. Ensure that tinning has taken place on the required surfaces.
4. Continue adding the rod to build up the joint to the desired size and shape.
5. Allow the joint to cool and remove the flux residue with a wire brush or by immersion in a dilute acid solution followed by a water rinse.

**Packaging Data:**

Rod Size (mm)	Pack Weight/Type	Easyweld Handpack	Blister Pack	Approximate Rods/kg	Part No
2.4 x 500			5 Rod Blister Pack	–	322207
3.2 x 750	5kg Pack			19	321236

## COMWELD NICKEL BRONZE ROD



- ▲ High Strength, Wear Resistant Brazing Alloy.
- ▲ High Strength Braze Welding of Steels and Cast or Malleable Irons.
- ▲ Fusion Welding of Copper Based Alloys of Similar Composition.
- ▲ CRIMSON End Tip Colour for Instant I.D.

## Classifications:

AS 1167. Parts 1 & 2: R Cu Zn-D.  
 AWS/ASME-SFA A5.8/A5.27: RB Cu Zn-D.

## Description and Applications:

Comweld Nickel Bronze (sometimes termed Nickel Silver) is a premium quality bronze filler rod recommended for the high strength braze welding of steel, cast and malleable irons.

It is also an excellent choice for the fusion welding of Copper based alloys of similar composition and for the brazing of Nickel based alloys where high temperatures are allowable.

Because of its high strength and excellent wear resistance, Comweld Nickel Bronze is regarded as the number one maintenance brazing alloy. It produces joints in mild steel which, when tested to destruction, fail in the parent metal. Its superior wear resistance makes it ideal for the build up of worn ferrous metal components including gear teeth, valve seats, bearings and shafts etc.

## Procedure for Braze Welding:

1. Thoroughly clean all areas to be joined.
2. For best results on steel use Comweld Copper and Brass flux (Part Number: 321822) and for cast iron use a Bronze flux. Adjust flame to slightly oxidising.
3. Preheat the edges to be joined to a dull red colour. Dip the end of the heated rod into the flux and, at the same time, heat both edges of the job to an equal degree. Ensure that 'tinning' has taken place on the required joint surfaces.
4. Continue adding the rod to build up the joint to the desired size and shape.
5. Allow the joint to cool and remove the flux residue with a wire brush or by immersion in a dilute acid solution followed by a water rinse.

## Packaging Data:

Rod Size (mm)	Pack Weight/Type	Approximate Rods/kg	Part No
2.4 x 750	5kg Pack	35	321224
3.2 x 750	5kg Pack	19	321225
5.0 x 750	5kg Pack	8	321226

## JOINING PROCESS:

Gas (Fusion and Braze) Welding only.

## TYPICAL WELD DEPOSIT PROPERTIES:

Weld Metal Tensile Strength	560 MPa
0.2% Proof Stress	250 MPa
Elongation	18%
Hardness	170 HV
Approximate Melting Point	910°C.
Weld Metal Density	8.39 gms / cm <sup>3</sup>

## TYPICAL ROD ANALYSIS:

Zn: 43.5%	Mn: 0.20%	Si: 0.20%
Ni: 10.0%	Cu: Balance	

## COMPARABLE CIGWELD PRODUCTS:

Comcoat N Flux Coated Nickel Bronze  
 AS 1167.1 & .2: R Cu Zn-D



- ▲ Flux Coated Nickel Bronze Rod.
- ▲ High Strength, Excellent Wear Resistance.
- ▲ High Strength Braze Welding of Steels and Cast or Malleable Irons.
- ▲ Fusion Welding of Copper Based Alloys of Similar Composition.
- ▲ PINK Flux Colour for Instant I.D.

**Classifications:**

AS 1167. Parts 1 & 2: R Cu Zn-D.  
AWS/ASME-SFA A5.8/A5.27: RB Cu Zn-D.

**Description and Applications:**

Comweld Comcoat N ( sometimes termed Nickel Silver) is a 'self fluxing' Nickel bronze filler rod recommended for the high strength braze welding of steel and cast or malleable irons.

It is also an excellent choice for the fusion welding of Copper based alloys of similar composition and for the brazing of Nickel based alloys where high temperatures are allowable.

Because of its high strength and excellent wear resistance, Comweld Comcoat N is regarded as the number one maintenance brazing alloy. It produces joints in mild steel which, when tested to destruction, fail in the parent metal. Its superior wear resistance makes it ideal for the build up of worn ferrous metal components including gear teeth, valve seats, bearings and shafts etc.

**Procedure for Braze Welding:**

1. Thoroughly clean all areas to be joined.
2. Adjust flame to slightly oxidising.
3. Preheat the edges to be joined to a dull red colour. Melt the end of the flux coated rod and, at the same time, heat both edges of the job to an equal degree. Ensure that 'tinning' has taken place on the required joint surfaces.
4. Continue adding the rod to build up the joint to the desired size and shape.
5. Allow the joint to cool and remove the flux residue with a wire brush or by immersion in a dilute acid solution followed by a water rinse.

**Packaging Data:**

Rod Size (mm)	Pack Weight/Type	Easyweld Handipack	Blister Pack	Approximate Rods/kg	Part No
2.4 x 500			3 Rod Pack	–	322208
		10 Rod Handipack		–	322029
3.2 x 750	2.5kg Pack			19	321215
		8 Rod Handipack		–	322030

**JOINING PROCESS:**

Gas (Fusion and Braze) Welding only.

**TYPICAL WELD DEPOSIT PROPERTIES:**

Weld Metal Tensile Strength	560 MPa
0.2% Proof Stress	250 MPa
Elongation	18%
Hardness	170 HV
Approximate Melting Point	910°C.
Weld Metal Density	8.39 gms / cm <sup>3</sup>

**TYPICAL ROD ANALYSIS:**

Zn: 43.5%	Mn: 0.20%	Si: 0.20%
Ni: 10.0%	Cu: Balance	

**COMPARABLE CIGWELD PRODUCTS:**

Comweld Nickel Bronze Bare Rod  
AS 1167.1 & .2: R Cu Zn-D



## COMWELD SILICON BRONZE ROD



- ▲ Premium Quality Deoxidised Silicon - Bronze alloy.
- ▲ Suitable for Welding Si-Bronze (Everdur and Cusilman).
- ▲ CANARY YELLOW End Tip Colour.

## Classifications:

AS 1167 Parts 1 & 2: R Cu Si-A.  
AWS/ASME-SFA A5.7: R Cu Si-A (UNS No. C65600).

## Description and Applications:

COMWELD Silicon Bronze is a premium quality, general purpose, silicon bronze filler rod producing excellent joints on copper, brass, copper-silicon and copper-zinc sheet, tube and extruded section base metals to themselves and also to steel.

## Outstanding features of this alloy are:

1. Low thermal conductivity (hence preheat is not necessary).
2. The deoxidising effect of the silicon and the glassy skin formed by its oxide.
3. A narrow hot-short range (800°C-950°C) just below solidus.

COMWELD Silicon Bronze is used extensively in applications where superior corrosion resistance and tensile strength is required such as marine engineering, repair and fabrication, including propellers, naval brass fittings, gear wheels, valves, shafts and pumps, and is also used on hot water system applications.

## Procedure for Braze Welding:

1. Thoroughly clean all areas to be joined or rebuilt of foreign material.
2. For best results use COMWELD Copper and Brass flux (321822).
3. Adjust the flame to neutral or slightly oxidising (excess oxygen).
4. For thick plate bevel edges 60°-90° included angle.
5. Generally preheat is not required because of the lower melting point and low thermal conductivity.
6. Dip the heated end of the rod into the flux.
7. Heat a spot on the base metal until it shows signs of melting and progressively add the filler rod to the weld pool. Ensure that the weld pool is as small as possible.
8. Allow to cool and remove flux residue with a wire brush.

## Procedure for Gas Tungsten Arc Welding (TIG):

1. Thoroughly clean all areas to be joined or rebuilt of foreign material.
2. For thick plate bevel edges 60°-70° included angle.
3. Use a Thoriated or Ceriated tungsten electrode, ground to a sharp needle point making sure the grinding lines run with the length (longitudinally) of the electrode's axis. The length of the needle point should be approximately 2-3 x the diameter of the tungsten electrode.
4. Use Direct Current Electrode Negative (DC-) and Welding Grade Argon.
5. Heat a spot on the base metal until it shows signs of melting and progressively add the filler rod to the weld pool. Ensure that the weld pool is as small as possible.

## JOINING PROCESS:

Gas (Fusion and Braze) and Gas Tungsten Arc Welding (TIG).

## TYPICAL WELD DEPOSIT PROPERTIES:

Weld Metal Tensile Strength	370 MPa.
Approximate Melting Range	970-1020°C
Weld Metal Density	8.85 gms / cm <sup>3</sup>
Hardness	90 HV (90HB)

## TYPICAL ROD ANALYSIS:

Fe: 0.25%	Mn: 1.00%	Pb: 0.02%
Si: 3.40%	Sn: 0.90%	Zn: 0.90%
Cu: Balance		

## Packaging Data:

Rod Size (mm)	Pack Weight/Type	Approx Rods/kg	Part No
3.2 x 750	5kg Pack	19	321295





**SOLDERS AND FLUXES**

<b>Description</b>	<b>Page No</b>
Comweld 40/60 Soft Solder	212
Comweld 50/50 Soft Solder	213
Comweld 965 Solder	214
Comweld Metal Mate Solder Kit	215
Comweld Aluminium Flux	216
Comweld Copper and Brass Flux	217
Comweld Silver Brazing Flux No. 2	218
Comweld G.P. Silver Brazing Flux	219
Comweld 965 Soldering Flux	220
Comweld VAPAFLUX	221

## COMWELD 40/60 SOFT SOLDER



- ▲ General Purpose Low Cost Solder.
- ▲ For Sheet Metal & Plumbing Applications.
- ▲ Wide Range of Packaging Options.

### Classifications:

AS 1834 Part 1      40Sn.

### Description and Applications:

COMWELD 40/60 Solder is a low cost general purpose solder for general sheet metal work, plumbing (not water pipes) such as gutters and flashings and automotive radiator repairs. Other general applications include the soldering of very light gauge tin coated plate (tin plate) the joining of lead based alloy pipe, the trophy & medallion industry and model making & hobby areas.

### Procedure for Soldering:

1. Thoroughly clean all areas to be joined of foreign material.
2. Apply COMWELD 965 Soldering Flux (321890) to the work area. If using flux cored solder this will be automatic at step four (4).
3. Heat the work surfaces directly by the use of a soldering iron or indirectly by the use of a soft gas flame, such as LPG. Do not overheat.
4. Apply solder to the work area. The molten solder should easily flow and be evenly dispersed in the joint area. Do not over fill with solder.
5. Remove heat source and allow to cool naturally until solder returns to a solid state.
6. Remove all flux residues with water.

### Acid Cored & Resin Cored! What are the Differences?

COMWELD 'RESIN-CORED' solder wire is suitable for safe use on electrical and electronic work such as computers, video recorders, televisions, telephone and telecommunications equipment and other consumer goods without the need to remove the flux residue. The RESIN residue remaining after soldering is non-corrosive and non-conductive and as such means that there cannot be any damage to delicate electrical wires and no new electrical paths can form to cause short-outs or electrical malfunction of the equipment.

The flux inside COMWELD 'ACID-CORED' wires does not actually contain acid, but the name is given to this flux because it has been formulated to provide a higher level of chemical cleaning action and fluxing activity needed to remove oxide and oxide skins from hard to solder metals such as heavily tarnished copper, copper alloys and difficult materials such as stainless steels that the relatively mild RESIN type flux could not cope with. The flux residues of the ACID-CORED wire are to some extent corrosive and, as such should not be used for electrical work. If possible we recommend that the residues be washed off with water (preferably warm) after soldering.

### COLOUR CODE & IDENTIFICATION:

Cored Wire Reels — Green label  
Sticks — marked 40/60  
Handipack (H/P) Coil, Yellow backing card and label.

### JOINING PROCESS:

Soldering only.  
SOLDERING IRON bit temperature: 294°C.

### TYPICAL ROD ANALYSIS:

Sn: 40% (Tin)      Pb: 60% (Lead)

### TYPICAL PROPERTIES:

Tensile Strength	42 MPa
Shear Strength	37 MPa
Approximate Melting Range	183–234°C
Electrical Conductivity	10.1% IACS

### Packaging Data:

Rod/Wire Size (mm)	Pack Weight/Type	Part No
12 x 6 x 400 (W x B x L)	250g Stick	322305
3.2	250g Acid core Wire	322313
3.2	500g Acid core Wire	322318
1.6	15g Resin core H/P	322220

## COMMWELD 50/50 SOFT SOLDER



- ▲ Higher Quality General Purpose Solder.
- ▲ For Electrical & Electronic Applications.
- ▲ Wide Range of Packaging Options.

### Classifications:

AS 1834 Part 1      50Sn.

### Description and Applications:

COMMWELD 50/50 Solder is a higher quality general purpose solder for general sheet metal work, and plumbing (not water pipes) applications where better free flowing characteristics are important.

The Resin Cored COMMWELD 50/50 solder is especially suited for electrical and electronic work where residues which remain after soldering are non-corrosive and non-conductive.

#### Procedure for Soldering:

1. Thoroughly clean all areas to be joined of foreign material.
2. Apply COMMWELD 965 Soldering Flux (321890) to the work area. If using flux cored solder this will be automatic at step four (4).
3. Heat the work surfaces directly by the use of a soldering iron or indirectly by the use of a soft gas flame, such as LPG. Do not overheat.
4. Apply solder to the work area. The molten solder should easily flow and be evenly dispersed in the joint area. Do not over fill with solder.
5. Remove heat source and allow to cool naturally until solder returns to a solid state.
6. Remove all flux residues with water.

#### COLOUR CODE & IDENTIFICATION:

Cored Wire Reels — Orange Label

Sticks — marked 50/50.

#### JOINING PROCESS:

Soldering only.

SOLDERING IRON bit temperature: 272°C.

#### TYPICAL ROD ANALYSIS:

Sn: 50% (Tin)      Pb: 50% (Lead)

#### TYPICAL PROPERTIES:

Tensile Strength	45 MPa
Shear Strength	40 MPa
Approximate Melting Range	183–212°C
Electrical Conductivity	10.9% IACS

#### Packaging Data:

Rod/Wire Size (mm)	Pack Weight/Type	Part No
12 x 6 x 400 (W x B x L)	250g Stick	322306
3.2	250g Solid Wire	322310
1.6	250g Acid Core Wire	322317
	250g Resin Core Wire	322319

### Acid Cored & Resin Cored! What are the Differences?

COMMWELD 'RESIN-CORED' solder wire is suitable for safe use on electrical and electronic work such as computers, video recorders, televisions, telephone and telecommunications equipment and other consumer goods without the need to remove the flux residue. The RESIN residue remaining after soldering is non-corrosive and non-conductive and as such means that there cannot be any damage to delicate electrical wires and no new electrical paths can form to cause short-outs or electrical malfunction of the equipment.

The flux inside COMMWELD 'ACID-CORED' wires does not actually contain acid, but the name is given to this flux because it has been formulated to provide a higher level of chemical cleaning action and fluxing activity needed to remove oxide and oxide skins from hard to solder metals such as heavily tarnished copper, copper alloys and difficult materials such as stainless steels that the relatively mild RESIN type flux could not cope with. The flux residues of the ACID-CORED wire are to some extent corrosive and, as such should not be used for electrical work. If possible we recommend that the residues be washed off with water (preferably warm) after soldering.

## COMWELD 965 SOLDER (SOFT SILVER SOLDER)



- ▲ Highest Strength Soft Solder.
- ▲ Lead, Zinc and Cadmium Free.
- ▲ Non Toxic Solder For Electrical, Surgical and Food Equipment Applications.
- ▲ Wide Range of Packaging Options.

## Classifications:

AS 1834 Part 1      96.5Sn / 3.5Ag.

## Description and Applications:

COMWELD 965 Solder is a tin / silver eutectic solder which has the highest strength of all soft solders. Due to its high strength, good electrical and thermal conductivity, non toxicity (lead, zinc and cadmium free) and also the fact that it remains bright and shiny, make COMWELD 965 Solder the most universal of soft solders.

Comweld 965 Solder is used for the joining and repair of copper, bronze, brass, nickel, monel, steel, stainless steel, pewter, chrome plate, metal sculpture, model making, costume jewellery and or a combination of metals with the exception of aluminium and magnesium. It is used in the manufacture and repair of refrigeration, air conditioning, heating, surgical and food equipment and for reliable electrical connections subject to high service stresses and temperatures.

Comweld 965 Solder is often preferable due to its much lower melting point than silver brazing alloys, which eliminates the need for excessive heating during joining. Non Toxic Solder.

## Procedure for Soldering:

1. Thoroughly clean all areas to be joined of foreign material.
2. Apply COMWELD 965 Soldering Flux (321890) to the work area. If using flux cored solder this will be automatic at step four (4).
3. Heat the work surfaces indirectly by the use of a soldering iron or by the use of a soft gas flame, such as LPG or Air-Acetylene.
4. Do not overheat.
5. Melt off small amount of alloy and play the flame onto the solder until it flows into the joint and bonds.
6. Continue until joint is complete.
7. Remove all flux residues with water.

## Acid Cored Wire! Does it contain Acid?

The flux inside COMWELD 'ACID-CORED' wires does not actually contain acid, but the name is given to this flux because it has been formulated to provide a higher level of chemical cleaning action and fluxing activity needed to remove oxide and oxide skins from hard to solder metals such as heavily tarnished copper, copper alloys and difficult materials such as stainless steels that the relatively mild RESIN type flux could not cope with. The flux residues of the ACID-CORED wire are to some extent corrosive and, as such should not be used for electrical work. If possible we recommend that the residues be washed off with water (preferably warm) after soldering.

## COLOUR CODE &amp; IDENTIFICATION:

Blue Labels and backing cards.

## JOINING PROCESS:

Soldering only.

SOLDERING IRON bit temperature: 281°C.

## TYPICAL ROD ANALYSIS:

Sn: 96.5% (Tin)      Ag: 3.5% (Silver)

## TYPICAL PROPERTIES:

Tensile Strength	60 MPa
Density	7.5g/cm <sup>3</sup>
Approximate Melting Point	221°C
Electrical Conductivity	17% IACS

## Packaging Data:

Rod/Wire Size (mm)	Pack Weight/Type	Part No
3.2	250g Solid Wire	322320
	500g Solid Wire	322321
1.6	250g Acid Core Wire	322324
	15g HandiPack Coil Acid Core Wire	322221



- ▲ Highest Strength Soft Solder.
- ▲ Lead, Zinc and Cadmium Free.
- ▲ Non Toxic Solder For Electrical, Surgical and Food Equipment Applications.

## Classifications:

AS 1834 Part 1      96.5Sn / 3.5Ag.

## Description and Applications:

COMWELD Metal Mate Solder Kit contains a 14 gram 965 solid solder coil complete with a 14 ml bottle of COMWELD 965 Soldering Flux which provides a very compact package suitable for all of the applications recommended for the standard Comweld 965 Soft Solder.

COMWELD 965 Solder is a tin / silver eutectic solder which has the highest strength of all soft solders. Due to its high strength, good electrical and thermal conductivity, non toxicity (lead, zinc and cadmium free) and also the fact that it remains bright and shiny, make COMWELD 965 Solder the most universal of soft solders.

Comweld 965 Solder is used for the joining and repair of copper, bronze, brass, nickel, monel, steel, stainless steel, pewter, chrome plate, metal sculpture, model making, costume jewellery and or a combination of metals with the exception of aluminium and magnesium.

It is used in the manufacture and repair of refrigeration, air conditioning, heating, surgical and food equipment and for reliable electrical connections subject to high service stresses and temperatures.

Comweld 965 Solder is often preferable due to its much lower melting point than silver brazing alloys, which eliminates the need for excessive heating during joining. Non Toxic Solder.

## Procedure for Soldering:

1. Thoroughly clean all areas to be joined of foreign material.
2. Apply COMWELD 965 Soldering Flux to the work area.
3. Heat the work surfaces indirectly by the use of a soldering iron or by the use of a soft gas flame, such as LPG or Air-Acetylene.
4. Do not overheat.
5. Melt off small amount of alloy and play the flame onto the solder until it flows into the joint and bonds.
6. Continue until joint is complete.
7. Remove all flux residues immediately after soldering by washing with plenty of cold water. It is advisable to protect your skin from contacting this flux. If contact is made with the skin, wash under cold water as soon as possible.

## IDENTIFICATION:

Clear Plastic Jar, White Lid & White Label with Blue Print.

## JOINING PROCESS:

Soldering only.

SOLDERING IRON bit temperature: 281°C.

## TYPICAL ROD ANALYSIS:

Sn: 96.5% (Tin)      Ag: 3.5% (Silver)

## TYPICAL PROPERTIES:

Tensile Strength	60 MPa
Density	7.5g/cm <sup>3</sup>
Approximate Melting Point	221°C
Electrical Conductivity	17% IACS

## Packaging Data:

Rod/Wire Size (mm)	Pack Weight/Type	Part No
1.6	1.6mm x 14g Solid Wire coiled around a 14ml bottle of 965 Soldering Flux	321690



## COMWELD ALUMINIUM FLUX



- ▲ For Fusion Welding Aluminium Alloys.
- ▲ Useable in either Powder or Paste Form.

MELTING POINT:	545°C
----------------	-------

Packaging Data:	
-----------------	--

Pack Weight/Type	Part No
250 gram Black Plastic Jar	321740

### Identification:

White Powder in a Black Plastic Jar.

### Description and Applications:

COMWELD Aluminium Flux is an all purpose flux for fusion welding sheet and cast aluminium. It eliminates the need for a number of different types of aluminium welding fluxes being stocked to handle different types of aluminium welding alloys. COMWELD Aluminium Flux is recommended for use with the following COMWELD Aluminium welding rods, AL1188 (Pure), AL4043 (5% Silicon) and AL5356 (5% Magnesium).

#### Procedure:

Apply flux sparingly to the cleaned surface of the joint in paste form, or by picking up a small quantity on the end of the heated filler rod. Never sprinkle flux over the job. The flux can be mixed with methylated spirits, water or alcohol to form a thin paste which can be applied to the rod or working area by means of a paint brush.

#### Flux Removal:

Dilute nitric acid dip followed by cold water rinse, then a hot water rinse or wire brush with hot water or steam.

- ▲ For Universal Braze Welding Applications.
- ▲ Useable in either Powder or Paste Form.

MELTING POINT:	645°C
----------------	-------

#### Packaging Data:

Pack Weight/Type	Part No
250 gram Black Jar	321822

#### Identification:

Pink Powder in Black Plastic Jars or Drums.

#### Description and Applications:

COMWELD Copper and Brass Flux is specially developed for the braze welding of copper, brass and bronze and the brazing of copper, steel, etc. COMWELD Copper and Brass Flux is particularly suitable for use with COMWELD Manganese Bronze, Tobin Bronze, Nickel Bronze and Silicon Bronze rods.

#### Procedure:

The parts to be brazed must be clean with all traces of paint, oil and grease removed. Dip the heated end of the filler rod into flux as required. Flux may be mixed with water into a creamy paste and applied to rod and work before commencing. Wait until both edges of the joint begin to melt then apply the fluxed rod. Continue by melting each edge of the joint and the rod simultaneously.

#### Flux Removal:

Wire brush cup wheel (on an angle grinder) or wire brush with hot water, or dilute hydrochloric acid or nitric acid dip, followed by a water rinse.

## COMWELD SILVER BRAZING FLUX No.2



- ▲ For Silver Brazing of Carbon Steel, Stainless Steels & Dissimilar Metals.
- ▲ Used in a Paste Form.

MELTING POINT:	450°C
----------------	-------

#### Packaging Data:

Pack Weight/Type	Part No
200 gram Black Jar	321840
500 gram Black Jar	321841
3.5kg White Plastic Jar	321843

#### Identification:

White Paste in either a Black / White Plastic Jar.

#### Description and Applications:

COMWELD Silver Brazing Flux No. 2 and Silver Brazing Alloys with a high silver content (42-50%) produce excellent joints on carbon steel, stainless steel, nickel alloys and copper and brass.

Dissimilar metals in the above groups can be easily brazed.

The flux is a good temperature indicator and will melt at the proper brazing temperature.

#### Procedure:

The parts to be brazed must be thoroughly clean with all traces of oil and grease removed. Apply to work and rod with a paint brush before commencing to braze. Adequate flux is essential for proper action.

#### Flux Removal:

Hot diluted caustic soda dip or wire brush with hot water or steam.



- ▲ For Silver Brazing of Steel, Nickel, Brass, Bronze, Copper, and Stainless Steels.
- ▲ Used in a Paste Form.

MELTING POINT: 485°C

### Packaging Data:

Pack Weight/Type	Part No
200 gram Black Jar	321850
500 gram Black Jar	321851
3.5kg White Plastic Jar	321853

### Identification:

White Paste in either a Black / White Plastic Jar.

### Description and Applications:

COMWELD General Purpose Silver Brazing Flux is recommended for use with Cadmium bearing and Cadmium free silver brazing alloys with a low to medium silver content (2-40%). It is an excellent flux for medium to high temperature brazing and has been specially formulated to be used for induction brazing. COMWELD General Purpose Silver Brazing Flux and the above mentioned silver brazing alloys produce excellent joints on carbon steel, stainless steel, nickel alloys and copper and brass. The flux is a good temperature indicator and will melt at the proper brazing temperature.

#### Procedure:

The parts to be brazed must be thoroughly clean with all traces of oil and grease removed. Apply to work and rod with a paint brush before commencing to braze. Adequate flux is essential for proper action.

#### Flux Removal:

Hot diluted caustic soda dip or wire brush with hot water or steam.

## COMWELD 965 SOLDERING FLUX

- ▲ For Use with all Comweld Soft Solders.
- ▲ Highest Quality Australian Made Flux.
- ▲ Used in a Liquid Form Only.

## Packaging Data:

Pack Weight/Type	Part No
125 ml Bottle	321890
1 litre Bottle	321894

## Identification:

Pink Liquid in Black Plastic Bottles and Drums.

## Description and Applications:

COMWELD 965 Soldering Flux, when used in conjunction with COMWELD Soft Solders, enables excellent joints to be made on almost all metals and combinations of metals.

It is a very active flux and therefore, if used on copper, brass, bronze, etc. may be diluted if required in the ratio 1 part flux to 4 parts water.

**Procedure:**

COMWELD 965 is sold in handy squeeze-type bottles which enables the right amount of flux to be deposited when and where required.

**Flux Removal:**

Remove all flux residues immediately after soldering by washing with plenty of cold water. It is advisable to protect your skin from contacting this flux. If contact is made with the skin, wash under cold water as soon as possible.

## COMWELD VAPAFLUX

- ▲ For Braze Welding of Steel.
- ▲ Used with Comweld Manganese & Nickel Bronze Rods.
- ▲ Used in a Liquid Form Only.

FLASH POINT (TRUE CLOSED CUP):	17°C
-----------------------------------	------

### Packaging Data:

Pack Volume/Type	Part No
19 litre Tin Plate Can	321885

### Identification:

Clear Liquid in a Tin Plate Can.

### Description and Applications:

COMWELD Vapaflex provides an effective and time saving method of applying flux when braze welding steel. It is intended to be applied as vapour in the flame itself (the flux in the flame) and will impart a high fluidity to the bronze when deposited. This method prevents loss of time in removing the rod from the work to dip for the flux, and saves the fuel gas and oxygen consumed while dipping for flux. It is particularly effective for production brazing and will cut production time and defects. One of the major advantages is the elimination of the costly after-cleaning which is usually necessary with ordinary powder flux use. It is recommended for use with COMWELD Manganese Bronze and COMWELD Nickel Bronze rods.

#### Procedure:

COMWELD Vapaflex has been specially formulated for best results when used with the COMWELD Vapaflex Dispenser which delivers the correct quantity from the blowpipe to the flame. It is not suitable for direct application.

#### Flux Removal:

Where the welds are to be chrome plated or coated with synthetic enamels, the flux residue should be removed prior to treatment. Quench the joint in water containing 5% phosphoric acid. This will prevent rusting. The usual method of wire brushing with warm water may be employed to clean the joint surface.

LIGWELD

# CHROME BRIGHT

UN 2922 CORROSIVE LIQUID, TOXIC, N.O.S.

**THICKENED PICKLING PASTE FOR STAINLESS STEEL**  
CONTAINS: Hydrofluoric Acid 50/gL Nitric Acid 300g/L  
Manufacturing purposes. ChromeBright is used to remove the black oxide  
welding of stainless steel.

brush. B. Appl  
A.

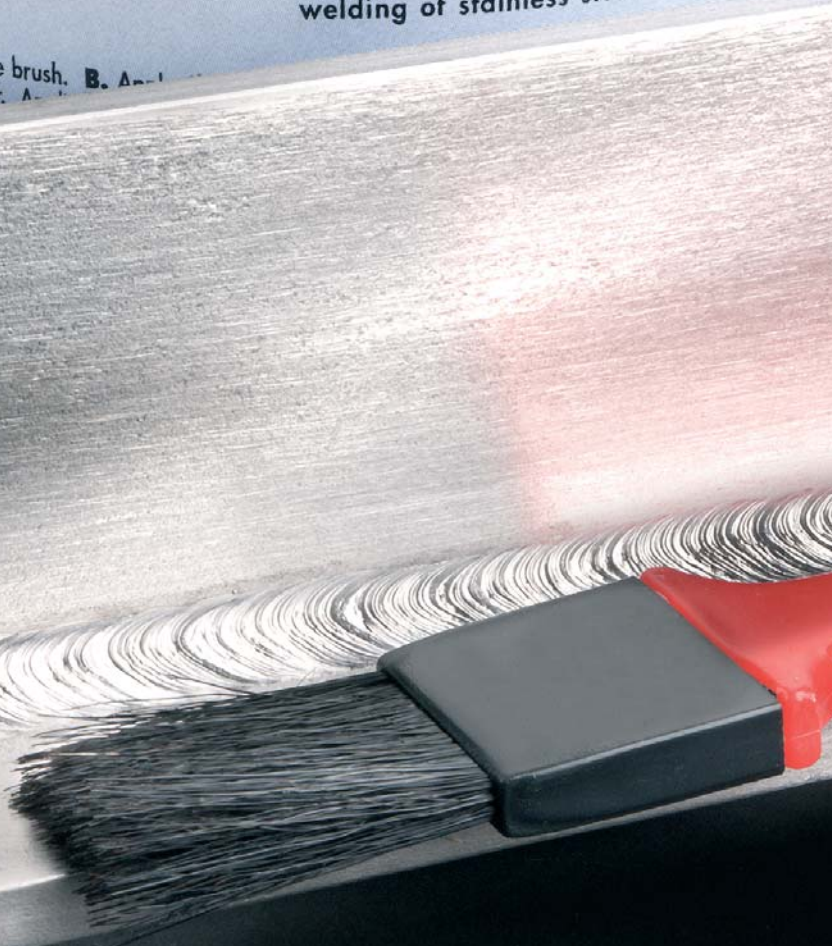

Description	Page No
ChromeBright (Pickling Paste)	224



## CHROMEBRIGHT (PICKLING PASTE)

- ▲ For Removal of Weld Scale on Stainless Steel.
- ▲ Easy to Use One Step Treatment, Brush on then Rinse with Water 15-90 minutes Later.
- ▲ Thickened Paste Allows For Vertical Use.
- ▲ PALE Purple Coloured Paste for Easy I.D.

### QUALITY STANDARDS:

Made in Australia under an approved Quality Assurance Management System to ISO 9002.

### TYPICAL CHEMICAL ANALYSIS:

HF:  $\leq$  50g/L      HNO<sub>3</sub>:  $\leq$  300g/L

CH<sub>3</sub>COOH:  $\leq$  30g/L

H<sub>2</sub>O and Others (dye, thickener etc): Remainder

### Identification:

ChromeBright is supplied in a white plastic bottle, with a blue coloured label and lid. The 2.5kg plastic bottle is packed inside a blue and white printed cardboard carton which contains a quality acid resistant application brush.

### Packaging Data:

Pack Weight/Type	Part No
2.5kg White Plastic Bottle	321918

### Description and Applications:

All stainless steel welding processes usually give rise to a brown or black oxide film adjacent to the weld. The discolouration must be removed to restore the attractive appearance of the steel and a convenient method of doing this is to use ChromeBright Pickling Paste.

ChromeBright is a thickened pickling paste, pale purple in colour for use with all grades of stainless steel. ChromeBright is used to remove the black oxide marks or weld scale created during the welding and brazing of stainless steel.

ChromeBright is also used to clean rust stains, various oxide films and the discolouration of weathered stainless steels to ensure the steel maintains its bright appearance. When used correctly ChromeBright applied to the weld or surrounding area will produce a uniform and pleasing matt surface appearance.

### Safety Precautions:

The pickling operation must take place outdoors or in a well ventilated area because during the pickling operation, there is a risk of gas emission (mainly nitrous gas) which is dangerous to inhale.

**When working with ChromeBright pickling paste, individuals should be equipped with chemical resistant rubber gloves, rubber boots, rubber apron and a full face covering chemical resistant faceshield.**

In cases where a closed vessel has to be pickled on the inside, it is essential that good ventilation be provided, and that operators wear respirators equipped with an ABE-AUS filter of the "acid gases" type. Neoprene and Natural Rubber gloves and aprons offer the best protection.

Bottles containing ChromeBright must be stored in an upright position and must always be carefully closed. The paste should be kept beyond the reach of children.

ChromeBright is very aggressive and must be handled with great caution. If an accident does occur and paste splashes onto the skin or into the eyes, the affected area must be immediately and continuously rinsed with large volumes of running water. Use Calcium Gluconate gel and/or tablets as required. Seek immediate medical attention. Inform the doctor or medical attendant that the paste contains nitric and hydrofluoric acids.

### Recommendations for Neutralising ChromeBright Residues:

As the active pickling paste components are nitric acid and hydrofluoric acid, the best neutralising agents are limestone or hydrated lime. While hydrated lime is the more efficient agent, it has the disadvantage of tending to block drains and pipes. The active acids combine with limestone to form nitrate of lime and calcium fluoride. Neutralising 1 kilogram of pickling paste requires approximately 0.5 kilogram of limestone.

## CHROMEBRIGHT (PICKLING PASTE) CONT.

### Procedure for Pickling:

1) Using a stainless steel wire brush, thoroughly clean the work piece of loose weld scale, welding slag and other foreign material.



2) Before opening the plastic bottle, shake for approximately 20 seconds to form a consistent gel paste.



3) Do not apply ChromeBright to the work piece until the surface is cool.

4) Using the brush provided, apply a thin layer of ChromeBright to the work piece and all other areas to be cleaned.



5) The paste should be applied for between 15 – 90\* minutes before removal.

6) Wearing protective clothing, rinse the pickled surface carefully with water, whilst using a hard nylon bristle brush, stainless steel wool or Scotch-Brite pads to remove all traces of weld scale.



#### WARNING:

Local liquid trade waste requirements may require the pickling paste residue to be neutralised before disposal. See CIGWELD's recommendation for neutralising Chrome Bright residues.

### Application Times:

Application time will depend upon the welding process and thickness of plate being welded. e.g.: Gas Tungsten Arc (GTAW, TIG) and Gas Metal Arc (GMAW, MIG) will require less time than Manual Metal Arc (MMAW, Stick) welding. Likewise 10mm plate will require more time than 1.6mm plate. A bottle (2.5kg) of ChromeBright will pickle approximately 100 metres of weld depending on the thickness of the layer applied. For pickling sheets of stainless steel, using a thinner layer, approximately 15 square metres can be treated with one bottle of ChromeBright.



## TECHNICAL AND TRADE INFORMATION

Technical and Trade Information...	228
12.1 Terms & Definitions...	229
12.2 Basic types of welded joints...	233
12.3 Welding Positions & Symbols...	237
12.4 Defects in welding...	243
12.5 Distortion, causes & control...	249
12.6 Safety in Welding...	254
12.7 Consumables Classification Tables...	258
12.8 Shielding Gas Information...	276
12.9 Welding Guide...	286
12.9.1 Welding of Steel...	286
12.9.2 Welding of Stainless Steel...	310
12.9.3 Welding of Aluminium...	320
12.9.4 Welding of Cast Iron...	348
12.9.5 Welding of Copper & Copper Alloys...	357
12.9.6 Welding of Dissimilar Metals...	368
12.10 Hardfacing Information...	370
12.11 Deposition Data...	392
12.12 Technical Facts & Figures...	399

**Notice about the Technical Information and Copyright in this section.**

CIGWELD Pty. Ltd. A.B.N. 56 007 226 815 authorise the use of the following CIGWELD printed material to be used as an aid in educational training and teaching.

This authority recognises that this printed material may be reproduced by printing or other means, electronic or otherwise in whole or in part for educational purposes only.

When reproduced material is printed or copied in whole or in part CIGWELD require that the original document from which this material was reproduced to be named in credits or references.

Where material is reproduced in part every effort shall be made to ensure that the extract is not misleading and that all associated safety information is included.

CIGWELD does not authorise the reproduction of this material, electronic or otherwise, for sale or commercial use by competitors or other like companies.

The use of CIGWELD printed material, reproduced in print or other forms for commercial use, may be subject to the payment of a royalty.

## EXPLANATION OF TERMS RELATING TO . . .

## MECHANICAL PROPERTIES OF WELD METAL

The mechanical properties of a metal describe its suitability for any given application and provide a performance forecast. Mechanical properties are of the utmost concern in welding consumable qualification since weld deposits must often provide service characteristics equal to or better than those of the base metal. The properties considered most often (and those that are frequently cited in Welding Consumable Specification requirements) are **Strength, Hardness, Ductility and Impact Resistance**.

### 1. Strength:

A metal's "strength" is its capacity to withstand external forces without breaking. In a tension test, under stretch loading, a specimen reveals several features - including elastic limit, elongation, yield point, yield strength, tensile strength and reduction in area. During the test, load is increased gradually and the specimen stretches in direct proportion to the load until it reaches its **Yield Point**. At any point up to the yield point, if the load is relaxed, the specimen will return to its original dimensions. Beyond the yield point, the specimen continues to elongate without an increase in load. An increase in load after the yield point brings the specimen to another critical point - **Tensile Strength**, or **Ultimate Tensile Strength** - at which the specimen breaks. Yield point and tensile strength values (in psi or MPa) are obtained by dividing the load at these points by the original cross-sectional area of the specimen.

### 2. Hardness:

A metal's hardness is its capacity to resist surface indentation by a contacting medium. Measuring the indent size of a hardened steel ball or a diamond upon the surface of a specimen assigns value to a metal's hardness. Indent size is translated to a hardness value. Typical units of measure being **Rockwell Hardness** ( $HR_A$ ,  $HR_B$  &  $HR_C$  Scales), **Vickers Hardness** ( $HV_{20}$  &  $HV_{30}$  Scales) and **Brinell Hardness**.

### 3. Ductility:

Ductility is the characteristic of metal that allows it to withstand stretching and other deformation without breaking and to hold a new shape after external forces have been removed. Determined in a tensile test, **Percent of Elongation** is the measure of ductility. Gauge marks are made 50 mm (2 inches) apart, bounding the point at which fracture will occur, on a test specimen. The increase in gauge length, divided by the original length, x 100, equals the elongation percentage. Ductility can also be measured in a bend test.

### 4. Impact Resistance

This property is assessed in terms of **Impact Strength** or **Impact Toughness**, determined most often in a **Charpy Vee Notch (CVN)** or **Charpy Test**. The specimen, a beam with a notch at its centre ("V-notch" preparation is most common), is supported at both ends and struck with a pendulum on the side opposite the notch. Measuring the energy absorbed during the test, (weight of pendulum x height of pendulum upon release x height to which pendulum swings after striking specimen) gives an impact-strength value in **joules** or **foot-pounds**. Since steels often become more brittle (less able to absorb energy) at lower temperatures, impact tests are often carried out at a range of low temperatures.

## TERMS AND DEFINITIONS IN WELDING

- A.
- ▲ Arc Blow      The deflection of an arc from its normal path because of magnetic forces. Normally occurs on DC current when welding carbon steel.
  - ▲ Arc Voltage      The voltage across the welding arc.
  - ▲ Arc Length      The distance from the tip of the welding electrode to the adjacent surface of the weld pool. Also known as "Arc Gap".
  - ▲ Arc Time      The time during which an arc is maintained in making an arc weld.
  - ▲ As-welded      Pertaining to the condition of weld metal, welded joints and weldments after welding, but prior to any subsequent thermal, mechanical or chemical treatments.
  - ▲ Autogeneous Weld      A fusion weld made without filler metal.
- B.
- ▲ Back bead      A weld resulting from a back weld pass. Also known as "Back Filling" or "Backing Pass"
  - ▲ Backgouging      The removal of weld metal and base metal from the weld root side of a welded joint to allow complete fusion and complete joint penetration upon subsequent welding from that side.
  - ▲ Backing Strip      A material (metal, carbon, ceramic etc.) for backing up a joint during welding to help obtain a sound weld.
  - ▲ Backing Ring      As above, but in the form of a ring, generally used in pipe welding.
  - ▲ Backstep Sequence      Weld passes are made in the opposite direction to the progress of welding.
  - ▲ Base Metal      The metal alloy that is being welded. Also known as "Base Material" or "Work Piece".
  - ▲ Bevel Angle      The angle formed between the prepared edges of two plates.
  - ▲ Build up      Layers of weld metal deposited when surfacing material to achieve a required dimension. Also known as "Buttering" and "Cladding".
  - ▲ Buffer Layer      Layers of weld metal on components which prevent crack formation or dilution effects in subsequent weld layers. See also "build up".
- C.
- ▲ Consumable insert      Preplaced filler metal that is completely fused into the root of a joint and becomes part of the finished weld.

## TERMS AND DEFINITIONS IN WELDING CONT.

- |    |                                     |   |
|----|-------------------------------------|---|
|    | ▲ Crater                            | A depression at the termination of the weld bead.   |
| D. | ▲ Deposition Efficiency             | The ratio of the weight of filler metal deposited in the weld metal to the weight of filler metal melted, expressed in percent.   |
|    | ▲ Deposition Rate                   | The weight of material deposited in a unit of time.   |
|    | ▲ Depth of Fusion                   | Distance that fusion extends into the base metal from the surface being welded.   |
|    | ▲ Dilution                          | A chemical composition change of the deposited weld metal due to admixture of the filler metal and base metal.  |
|    | ▲ Direct Current Electrode Negative | The electrode lead and welding electrode are connected to the negative pole on the welding machine. Also known as DC - or DCEN and DC straight polarity (Negative = 1/3 Heat) |
|    | ▲ Direct Current Electrode Positive | The electrode lead and welding electrode are connected to the positive pole on the welding machine. Also known as DC+ or DCEP and DC reverse polarity. (Positive = 2/3 Heat)  |
| E. | ▲ Edge Preparation                  | The surface prepared on the edge of a joint for welding.  |
|    | ▲ Electrode Lead                    | Conductor between source of current and electrode holder.   |
| F. | ▲ Flux                              | Fusible material for removal of oxides impurities and to create gas for shielding and slag for shape and contour.   |
|    | ▲ Fusion                            | The melting together of filler metal and base metal or a base metal only to produce a weld.   |
| G. | ▲ Ground Lead                       | The electrical conductor between the arc welding current source and work piece connection. Also known as "Work Lead".   |
| H. | ▲ Hardfacing                        | The process of covering a surface with wear-resistant metal by welding to reduce wear.  |
|    | ▲ Heat affected Zone                | The region beneath or around the weld bead which has not melted, but whose mechanical properties or microstructure has been altered by the heat of welding.                   |
| I. | ▲ Infra-Red Radiation               | Electromagnetic energy with wavelengths from 770 to 12,000 nanometers.  |
|    | ▲ Intermittent Welding              | Is welding wherein continuity is broken by recurring unwelded spaces.   |

## TERMS AND DEFINITIONS IN WELDING CONT.

	▲ Interpass Temperature	In a multiple run weld, the lowest temperature of deposited metal before the next pass is started. Normally measured 25mm from the weld metal centre line.
L.	▲ Liquidus	The lowest temperature at which a metal or an alloy is completely liquid.
	▲ Longitudinal Sequence	The order in which weld passes of a continuous weld are made along its length.
M.	▲ Melt-Through	Is the visible root re-reinforcement obtained in a one sided weld joint.
O.	▲ Open Circuit Voltage	The voltage between terminals of a power source when no current is flowing.
P.	▲ Parent Metal	Same as "Base Metal".
	▲ Peening	The mechanical working of metals by light hammering.
	▲ Penetration	The depth a weld extends into a joint from the metal surface
	▲ Post-heating	Application of heat to the weldment after welding is completed.
	▲ Preheating	Application of heat to the base metal before welding commences.
	▲ Procedure Qualification	To establish that welds made by a defined method can meet prescribed standards.
R.	▲ Residual Stress	Stress that is present in a joint member or material that is free of external forces.
	▲ Root Bead	A weld which is part or all of the root joint.
	▲ Root Bend Test	A test in which the root surface is bent around a specified radius.
	▲ Runoff / Runon Weld Tab	Is additional plate that extends beyond the end of the weld joint on which the weld is finished or started. (Also known as an End Tab)
S.	▲ Seal Weld	A weld made primarily to seal a joint for tightness against leakage.
	▲ Short Arc (short circuiting) transfer	Is metal transfer where molten metal from an electrode is deposited during repeated short circuits.
	▲ Sidewall	The surface of a joint wall included inside the preparation of a butt weld.
	▲ Side Bend Test	A test in which the side of a transverse section of the weld is bent around a specified radius.



## TERMS AND DEFINITIONS IN WELDING CONT.

- ▲ Slag Inclusion      Non-metallic solid material trapped in weld metal or between weld and base metal.
- ▲ Spatter      Metal particles expelled during welding which do not form part of the weld.
- ▲ Spray Transfer      Metal transfer where molten metal from an electrode is propelled across the arc in small droplets.
- ▲ Stringer Bead      A weld bead made without weaving.
- ▲ Suck-Back      A concave root surface.
- T. ▲ Tack Weld      A small weld made to hold parts in proper alignment until final welds are made.
- U. ▲ Underbead Crack      A crack in the heat affected zone which may or may not extend to the surface of the base metal.
- ▲ Underfill      A depression on the weld face dropping below the surface of the base metal.
- V. ▲ Vertical-down      Welding in a downhill direction.
- ▲ Vertical-up      Welding in an uphill direction.
- W. ▲ Weave Bead      A weld bead made with slow oscillation motion of the electrode, best limited in width to 2-3 times the diameter of the electrode.
- ▲ Welder Certification      Written verification that a welder has produced welds meeting a prescribed standard of weld performance.
- ▲ Welding Arc      A controlled electrical discharge between the electrode and the work piece that is formed and sustained by the establishment of a gaseous conductive medium, called an arc plasma.
- ▲ Welding Procedure Qualification Record (WPQR)      A record of welding variables used to produce an acceptable test weld and the results of the tests conducted on that weld which qualify a welding procedure specification.
- ▲ Welding Procedure Specification (WPS)      A document providing the detailed variables for a specific welding application to ensure reproduction by trained welders.
- ▲ Work Lead      The conductor between source of current and the work piece or work table.
- ▲ Work Piece      The job, part or component being welded.

**BASIC TYPES OF WELDED JOINTS**

**BASIC TYPES OF WELDED JOINTS:**

A) FILLET WELD

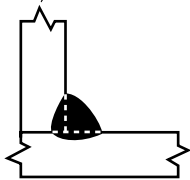

B) CORNER WELD

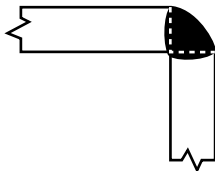

C) BUTT WELD



D) EDGE WELD

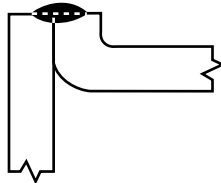

E) LAP WELD

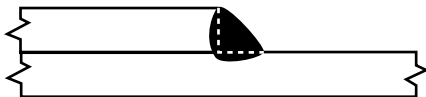

**TERMINOLOGY OF WELD JOINTS:**

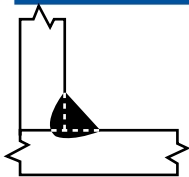

TRUE MITRE

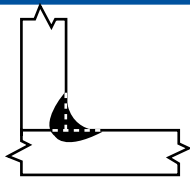

CONCAVE

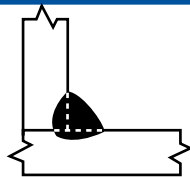

CONVEX

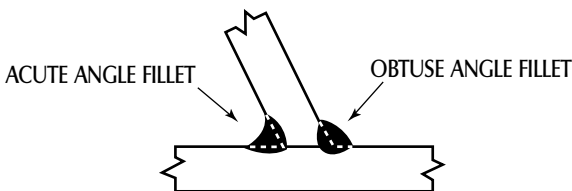

**BASIC TYPES OF WELDED JOINTS CONT.**

**FILLET WELD DEFINITIONS:**

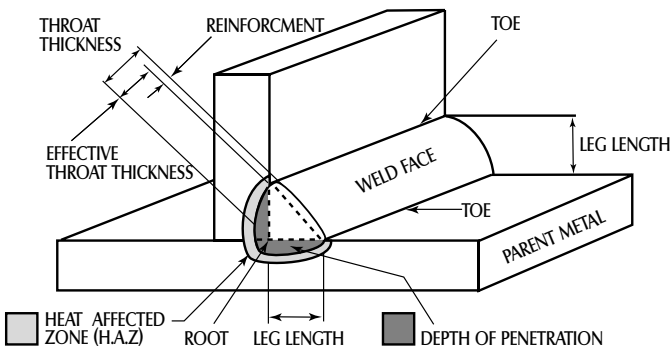

**BUTT WELD - PREPARATIONS:**

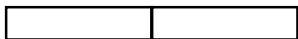

**CLOSED SQUARE BUTT**  
Suitable for plate up to 5mm in thickness



**OPEN SQUARE BUTT**  
>3mm ≤8mm

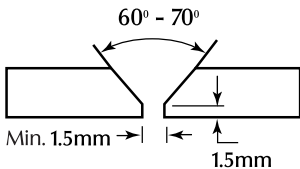

**SINGLE VEE BUTT**  
>6mm ≤16mm

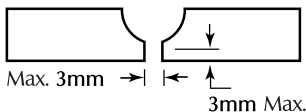

**SINGLE U BUTT**  
>8mm <25mm

**BASIC TYPES OF WELDED JOINTS CONT.**

**BUTT WELD - PREPARATIONS cont.:**

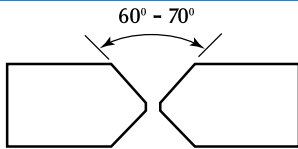

**DOUBLE VEE BUTT**  
 $>16\text{mm} \leq 40\text{mm}$



**DOUBLE U BUTT**  
 Used on plate over  
 25mm thick

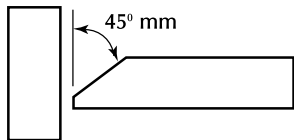

**SINGLE BEVEL BUTT WELD**  
 $>6\text{mm} \leq 25\text{mm}$

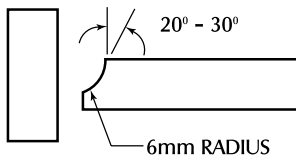

**SINGLE J BEVEL BUTT WELD**  
 $>8\text{mm} \leq 25\text{mm}$

**(i) BUTT WELD DEFINITIONS:**

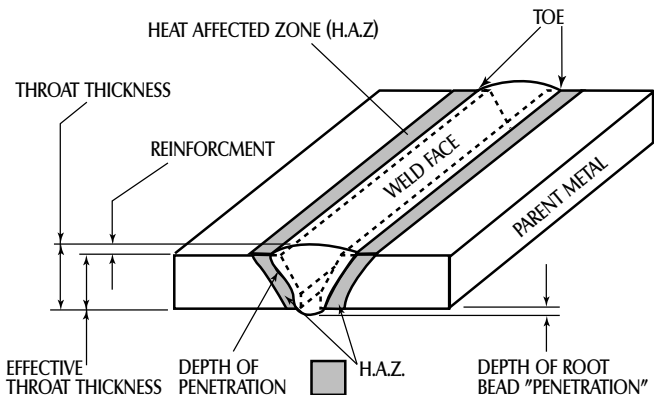

## BASIC TYPES OF WELDED JOINTS CONT.

## OTHER WELDS:

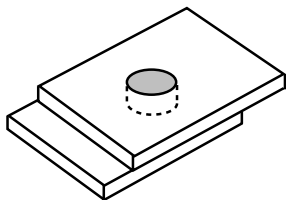

PLUG WELDS

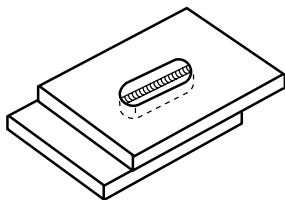

SLOT WELDS

## WELDING POSITIONS AND SYMBOLS

### PLATE AND PIPE POSITIONS TO ISO AND AS/AWS STANDARDS:

- ▲ ISO STANDARD 6947
- ▲ AUSTRALIAN STANDARD AS 3545
- ▲ AMERICAN WELDING SOCIETY AWS A3.0

### PLATE AND PIPE WELDING POSITIONS TO ISO:

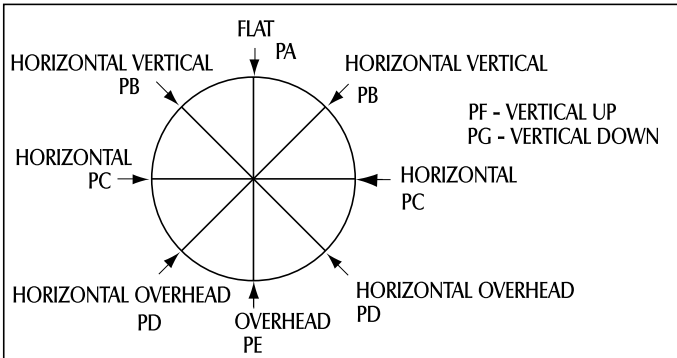



### PLATE POSITIONS:

WELD	FLAT	HORIZONTAL	VERTICAL	OVERHEAD
BUTT	 1G / PA	 2G / PC	 3G / PF PG	 4G / PE
FILLET	 1F / PA	 2F / PB	 3F / PF PG	 4F / PE

WELDING POSITIONS AND SYMBOLS CONT.

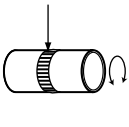
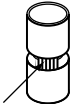
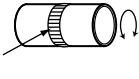
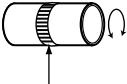
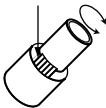
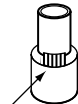
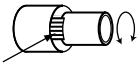
PIPE POSITIONS - ROTATED OR ROLLED:

	FLAT	HORIZONTAL	VERTICAL	OVERHEAD
BUTT	 <p>1G / PA</p>	 <p>2G / PC</p>	 <p>3G / PF</p>	 <p>4G / PE</p>
FILLET	 <p>1F / PA</p>	 <p>2F / PC</p>	 <p>*3F/PF (AWS 2F,R)</p>	 <p>*4F/PE (AWS 4F,F)</p>

\* ONLY APPLIES TO AS 3545 and ISO 6947

PIPE POSITIONS - FIXED POSITION:

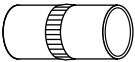
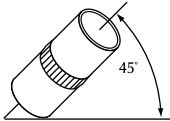
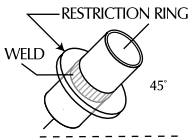
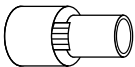
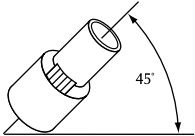
BUTT	 <p>5G / PF PG</p>	 <p>6G / H -L045</p>	 <p>RESTRICTION RING WELD 45°</p> <p>6GR</p>
FILLET	 <p>5F / PF PG</p>	 <p>45°</p> <p>* 6F / L45 PA</p>	

\* NOTE: ONLY APPLIES TO AS 3545 and ISO 6947

WELDING POSITIONS AND SYMBOLS CONT.

WELDING DIRECTIONS OR POSITIONS:

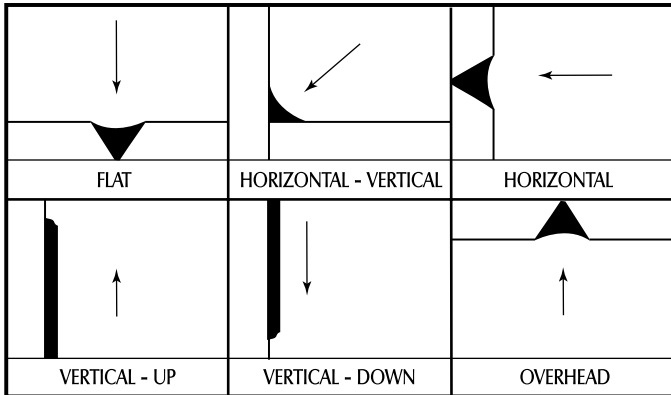

COMPARISON OF BASIC DRAWING (PRINTS) WELDING SYMBOLS:

(i) AS 1101.3 /AWS A2.4

AS 1101.3 BUTT WELD / AWS A2.4 GROOVE WELD

BUTT WELD							
SQUARE	SCARF	V	BEVEL	U	J	FLARE-V	FLARE BEVEL

(ii) AS 1101.3

FILLET WELD	PLUG WELD OR SLOT WELD	SPOT WELD OR PROJECTION WELD	SEAM WELD	BACKING RUN OR BACKING WELD	SURFACING	FLANGE WELD	
						EDGE	CORNER



WELDING POSITIONS AND SYMBOLS CONT.

COMPARISON OF BASIC DRAWING (PRINTS) WELDING SYMBOLS cont.:

AWS A2.4

FILLET	PLUG OR SLOT	STUD	SPOT OR PROJECTION	SEAM	BACK OR BACKING	SURFACING	FLANGE	
							EDGE	CORNER

AS 1101.3











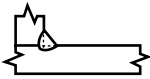

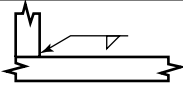
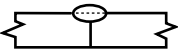



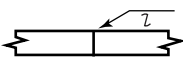

WELD ALL AROUND	SITE WELD	COMPLETE PENETRATION FROM ONE SIDE	BACKING OR SPACER MATERIAL	CONTOUR		
				FLUSH	CONVEX	CONCAVE

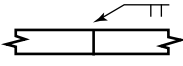
AWS A2.4

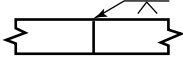
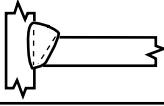
WELD ALL AROUND	SITE WELD	MELT THROUGH	CONSUM. INSERT (SQUARE)	BACKING OR SPACER (RECTANGLE)	CONTOUR		
					FLUSH OR FLAT	CONVEX	CONCAVE

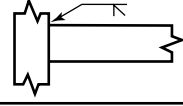

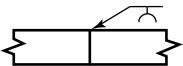
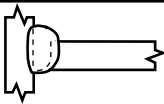

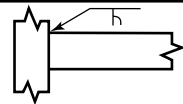

WELDING POSITIONS AND SYMBOLS CONT.

HOW WELDING SYMBOLS ARE USED:

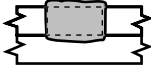

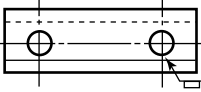

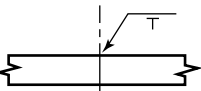
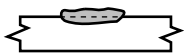
TYPE OF WELD	SKETCH OF WELD	SYMBOL	INDICATION OF DRAWING
FILLET WELD			
BEAD			EDGE WELD  SEAL WELD  BACKING RUN 
BUTT WELDS			
GENERAL BUTT	FULL PENETRATION BUTT WELD BY A WELDING PROCEDURE TO BE AGREED		
SQUARE BUTT			
SINGLE V BUTT			
SINGLE BEVEL BUTT			
SINGLE U BUTT			
SINGLE J BUTT			

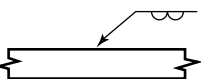
WELDING POSITIONS AND SYMBOLS CONT.

HOW WELDING SYMBOLS ARE USED cont.:

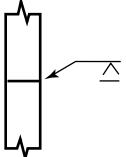
TYPE OF WELD	SKETCH OF WELD	SYMBOL	INDICATION OF DRAWING
PLUG OR SLOT			
STUD			
SURFACING			

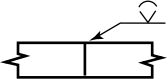
WELD FINISH

TYPE OF WELD	SYMBOL	INDICATION OF DRAWING	SKETCH OF WELD
FLUSH FINISH			
CONVEX FINISH			

CRANKED ARROW

A. A CRANKED ARROW IS USED WITH A BEVEL OR 'J' WELD SYMBOL POINTING TOWARD THE PLATE WHICH IS PREPARED. SEE 1

B. IF PLATE TO BE PREPARED IS OBVIOUS THE CRANK IS OMITTED. SEE 2

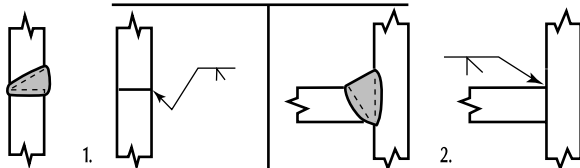

## DEFECTS IN WELDING

### Types of Defects:

- ▲ **EXTERNAL DEFECTS:** Can be identified by a visual inspection method eg: Dye Penetrant and Magnetic Particle testing.
- ▲ **INTERNAL DEFECTS:** Require a Non-Destructive testing (NDT) method eg: X-Ray or Ultrasonic testing.

(i) Main Causes :

- ▲ Welding operators carelessness or lack of skill.
- ▲ Adverse working conditions (Hot - Cold).
- ▲ Poor Design or lack of preparation.

(ii) Main Defects:

- ▲ Undercut.
- ▲ Slag inclusions.
- ▲ Porosity.
- ▲ Overlap or over-roll.
- ▲ Lack of fusion.
- ▲ Incomplete penetration.
- ▲ Weld cracking.
- ▲ Joint Misalignment.

### Undercut:

- ▲ **Definition:** A groove at the toe or root of a weld either on the weld face or in previously deposited weld metal.

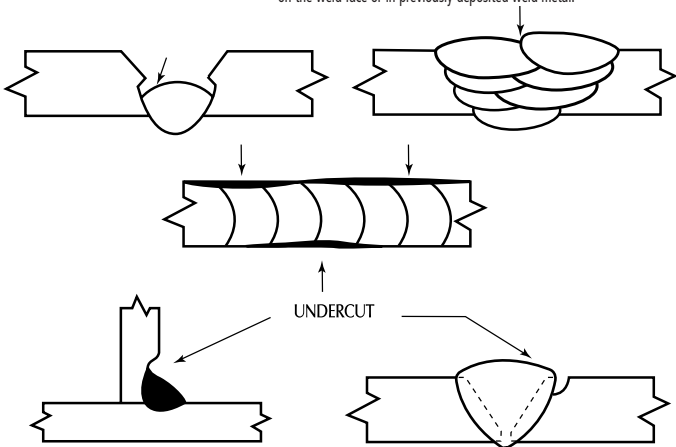

- Causes:**
- Excessive amperage.
  - Too long an arc length .
  - Excessive weaving of the electrode.
  - Too fast a rate of travel.
  - Angle of electrode too inclined to the joint face.

**Result:** A stress concentration site and a potential site for fatigue

## DEFECTS IN WELDING CONT.

## Overlap or over-roll:

## ▲ Definition:

An imperfection at the toe or root of a weld caused by metal flowing onto the surface of the parent metal without fusing to it.

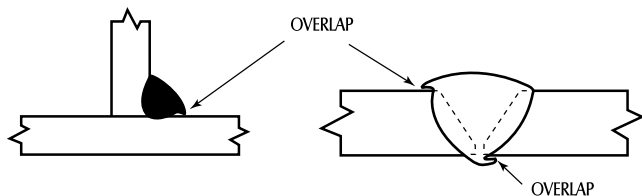

- Causes:
- Incorrect rate of travel.
  - Incorrect "angle of approach".
  - Too large an electrode size.
  - Too low an amperage.

Result: Has a similar effect as undercut and produces a stress concentration site due to the unfused weld metal.

## Slag Inclusions:

## ▲ Definition:

Refers to any non-metallic material in a completed weld joint. These inclusions can create a weak point in the weld deposit.

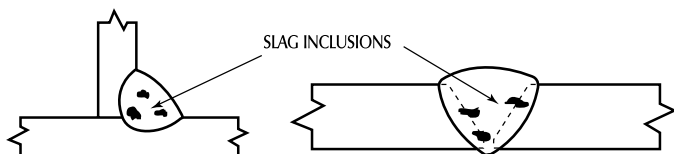

- Causes:
- Failure to remove slag from previous runs.
  - Insufficient amperage.
  - Incorrect electrode angle or size.
  - Faulty preparation.

Result: Slag inclusions reduce the cross sectional area strength of the weld and serve as a potential site for cracking.

**DEFECTS IN WELDING CONT.**

**Porosity:**

▲ Definition:

A hole or cavity found internally or externally in the weld. Porosity can originate from wet electrodes, electrode flux breaking down or from impurities on the surface of the parent metal.

Also known as "Piping", "Blow or Worm Holes"

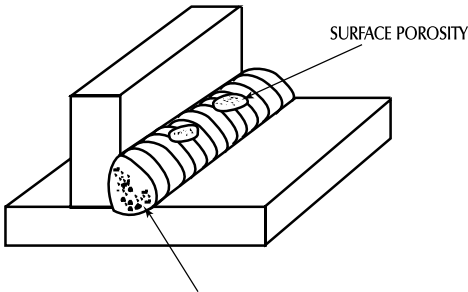

INTERNAL POROSITY AND START-OF-RUN POROSITY ARE VERY COMMON

Other Causes: - Unclean parent metal surface ie. oil, dust, dirt or rust contamination.

- Incorrect electrode for parent metal.
- Inadequate gas shielding of the arc.
- Parent metals with a high percentage of sulphur and phosphorus.

Result:

Severely reduces the strength of the welded joint. Surface porosity can allow a corrosive atmosphere to attack the weld metal which may cause failure.

**Lack of Fusion:**

▲ Definition:

A lack of bonding between the weld metal and the parent metal or between weld metal passes.

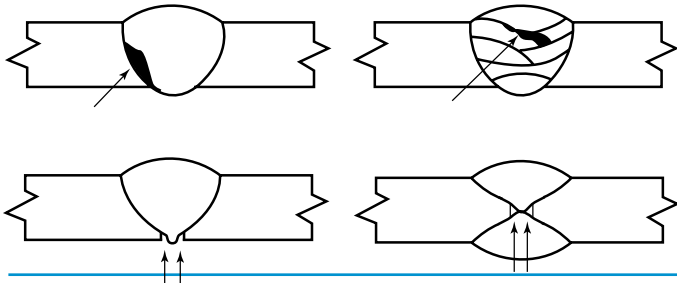

## DEFECTS IN WELDING CONT.

### Lack of Fusion cont.:

- Causes:**
- Small electrodes used on cold and thick steel.
  - Insufficient amperage.
  - Incorrect electrode angle and manipulation.
  - Rate of travel too fast, not allowing proper fusion.
  - Unclean surface (mill scale, dirt, grease etc.).
- Result:** Weakens the welded joint and becomes a potential fatigue initiation site.

### Incomplete Penetration:

▲ Definition:

A failure of the weld metal to penetrate into the root of the joint.

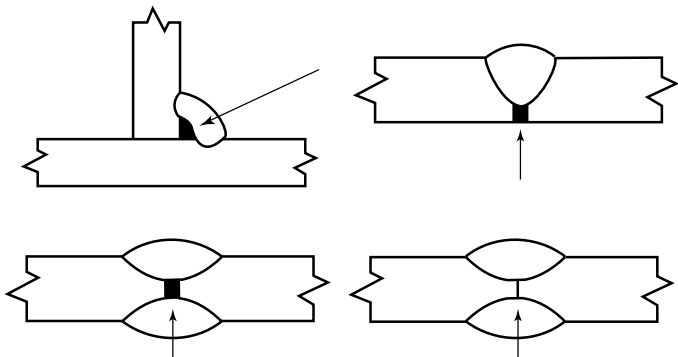

- Causes:**
- Current too low.
  - Insufficient root gap.
  - Too large an electrode size.

**Result:** Weakens the welded joint and becomes a potential fatigue initiation site.

### Weld cracking:

▲ Definition:

Planar (Two Dimensional) discontinuities produced by the tearing of parent or weld metal. Weld metal cracking can occur in either the plastic condition (hot shortness) or by fracturing when cold (cold shortness). There are many types of cracks that can occur in the base

## DEFECTS IN WELDING CONT.

### Weld cracking cont.:

Some common types of cracking include:

- Crater Cracking:** Hot cracking mainly caused by a failure to fill up the crater depression at the end of a weld pass. Shrinkage stresses and inadequate weld metal in the crater causes crater cracking.
- Underbead Cracks:** Cold cracking that is usually in the Heat-affected zone (HAZ) of the parent metal.
- Longitudinal Crack:** Usually a hot cracking phenomenon. Cracking runs along the length of the weld.

- Main Causes: - Incorrect welding procedures and techniques.  
 (eg. Wrong consumable or welding current, inadequate preheat etc.)
- Weld size may be too small for the parts being welded.
  - Base metal may contain a high carbon content (over 0.45%).
  - Metals which contain high percentages of sulphur or phosphorus tend to crack easily, so Hydrogen controlled electrodes are recommended.
  - Electrodes may be wet or damp.

#### CRACK TYPES:

1. CRATER CRACK
2. FACE CRACK
3. HEAT-AFFECTED ZONE CRACK
4. LAMELLAR TEAR
5. LONGITUDINAL CRACK
6. ROOT CRACK
7. ROOT SURFACE CRACK
8. THROAT CRACK
9. TOE CRACK
10. TRANSVERSE CRACK
11. UNDERBEAD CRACK
12. WELD INTERFACE CRACK
13. WELD METAL CRACK

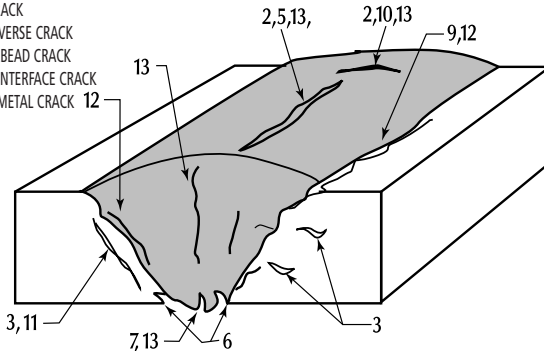
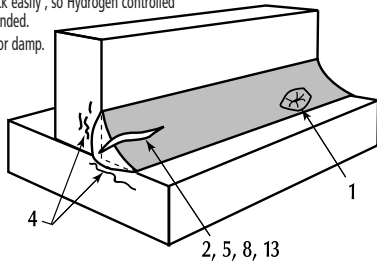



## DEFECTS IN WELDING CONT.

## Misalignment:

- ▲ Definition: Normally defined as an unnecessary or unintentional variation in the alignment of the parts being welded.

Misalignment is a common fault in prepared butt welds, and is produced when the root faces of the parent plate (or joint) are not placed in their correct position for welding.

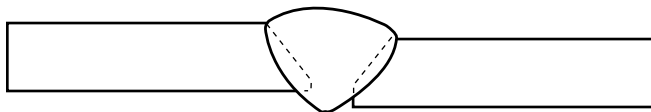

- Causes:
- Poor assembly of the parts to be welded.
  - Inadequate tack welds that break or insufficient clamping that results in movement.
- Result:
- Misalignment is a serious defect since failure to melt both edges of the root will result in stress concentration sites which in service may lead to premature fatigue failure of the joint.

## DISTORTION, CAUSES AND CONTROL

### Distortion:

Distortion to some degree is present in all forms of welding. In many cases it is so small that it is barely noticeable, but in other cases allowance has to be made before welding commences for the distortion that will subsequently occur.

The study of distortion is very complex and the following is a brief outline of the subject.

- A) The cause of distortion - when under load metals strain or move and change shape.
- ▲ Under light loading metals remain elastic (they return to their original shape or form after the load has been removed). This is known as the "elastic range".
  - ▲ Under very high load, metals may be stressed to the point where they will not return to their original shape or form and this point is known as the "yield point". (YIELD STRESS)
  - ▲ As metals are heated they expand and when cooled they contract. During welding, heating and cooling of metals occurs unevenly resulting in high stresses and the metal distorts.

If these high stresses pass the elastic range and go over the yield point, some permanent distortion of the metals will occur. A metals yield stress is reduced at high temperatures.

\*Distortion is the result of uneven expansion and contraction of heated metals.

Distortion Types - the three main types of distortion are:-

- ▲ Angular
- ▲ Longitudinal
- ▲ Transverse

(i) ANGULAR DISTORTION

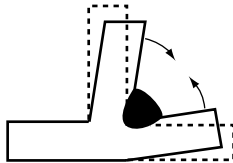
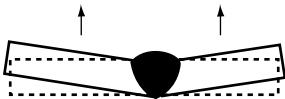

## DISTORTION, CAUSE AND CONTROL CONT.

## Distortion:

## (ii) LONGITUDINAL DISTORTION

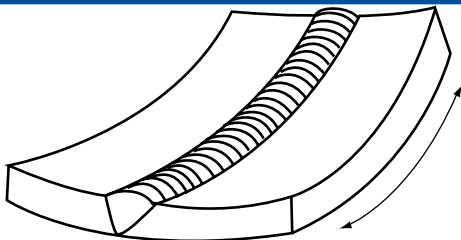

## (iii) TRANSVERSE DISTORTION

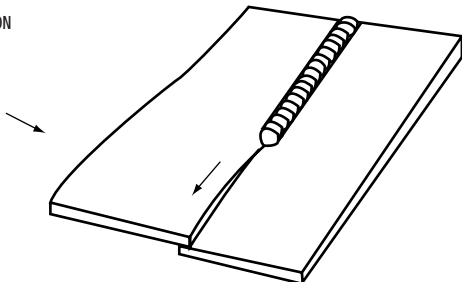

B) The **Control of distortion** can be broken up into three areas:-

- (i) Before welding
- (ii) During welding
- (iii) After welding

(i) The control of distortion **before** welding can be facilitated by:

- ▲ Tack Welding
- ▲ Jigs, clamps and fixtures
- ▲ Uniform pre-heating
- ▲ Pre-setting

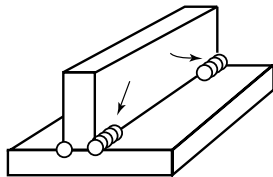

TACK WELDS

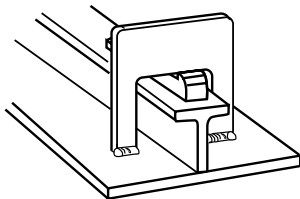

JIGS &amp; FIXTURES

**DISTORTION, CAUSES AND CONTROL CONT.**

**Distortion cont.:**

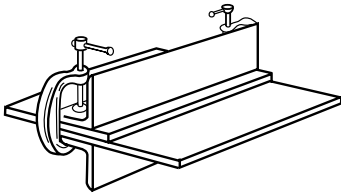

CLAMPS

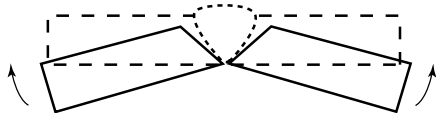

PRE-SETTING

(ii) The Control of distortion **during** welding can be facilitated by:

- ▲ Backstep welding
- ▲ Intermittent "Chain" welding
- ▲ Intermittent "Staggered" welding
- ▲ Balanced sequence welding
- ▲ A correct welding procedure to reduce the size of the weld beads

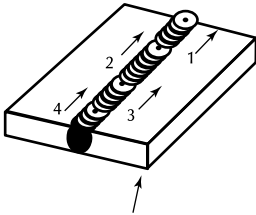

BACKSTEP WELDING

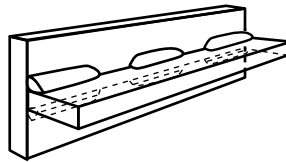

INTERMITTENT CHAIN WELDING

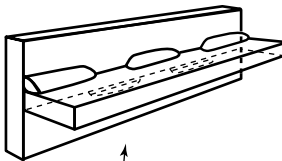

INTERMITTENT STAGGERED WELDING

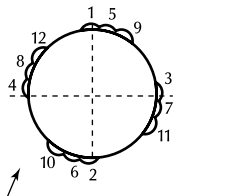

BALANCED SEQUENCE WELDING

## DISTORTION, CAUSES AND CONTROL CONT.

### Distortion cont.:

The correct welding procedure uses a greater number of weld runs positioned to refine the grain size of the weld metal in the previous layer.

A small number of heavy runs will cause more distortion due to the greater heat input, and the contraction stresses set up by the cooling of the larger deposit of weld metal.

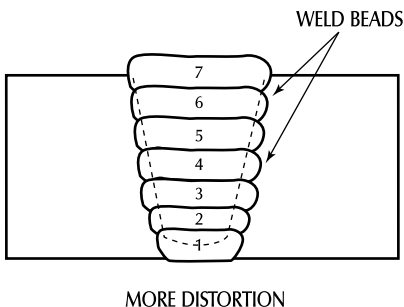
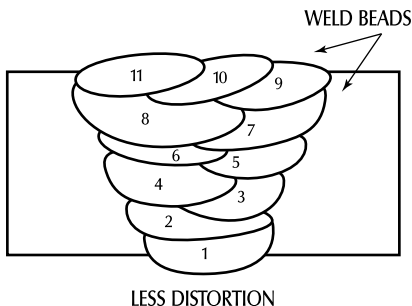

(iii) The control of distortion **after** welding can be facilitated by:

- ▲ Slow Cooling
- ▲ Flame straightening (also known as contra-heating)
- ▲ Annealing
- ▲ Stress Relieving
- ▲ Normalising
- ▲ Mechanical straightening

## DISTORTION, CAUSES AND CONTROL.

### Distortion cont.:

Annealing - is a heat treatment process designed to soften metals for cold working or machining purposes. The job or finished work is normally heated in a furnace so as the metal reaches its critical range (for .025% carbon steel @ 723-820°C) and then the work is very slowly cooled.

Stress Relieving - is the uniform heating of welded parts to a temperature below the critical range, followed by slow cooling. This process allows the yield point of the metal to be lowered allowing it to stretch or yield, so reducing the residual stresses in the work.

Normalising - is a process used to refine the grain structure of the metal so it improves its resistance to shock and fatigue.

In normalising the welded parts are heated just above the critical point (820°C for .025% carbon steel) for approximately 1 hour per 25mm thickness and then allowed to cool in still air.

Mechanical Straightening includes:

- Bend Pressing
- Hammering
- Rolling

## SAFETY IN WELDING

### A) ARC RADIATION:

Arc radiation is a result of **ULTRA-VIOLET (UV)** and **INFRA-RED (IR) RAYS** and exposure can cause the following:-

- ▲ Skin Cancer
- ▲ Thermal Skin Burns (severe sun burn)
- ▲ ARC FLASH (Welders Flash) or EYE BURN which can result in inflammation of the cornea, cataracts or blindness.

#### (i) PROTECTION REQUIRED INCLUDES:

- ▲ An approved welding helmet with the correct filter and shade number.
- ▲ Safety glasses which will help to refract (bend away) the UV and IR rays away reducing the chances of Arc Flash.
- ▲ Always wear protective full covering clothing to shield your body from potential burns eg.
  - Overalls/flame resistant wool or cotton.
  - Leather apron and jackets.
  - Always wear leather gloves.
  - Skull cap (for overhead welding).
  - Screen the welding zone when welding in open spaces.

**N.B.** A welding flash can occur by indirectly viewing the arc even for a relatively short time eg.

- Unconsciously looking out the corner of the eye
- Looking away from the arc (close eyes then turn away).
- Reflections of the arc from shiny surfaces in the welding area.

### B) ELECTRIC SHOCK - "PREVENTION":

- ▲ Never touch live metal parts with bare skin or wet clothing.  
Repair any damaged or loose connections, especially bare cables, before welding.
- ▲ Keep gloves and protective clothing dry and free of oil and grease.
- ▲ Never coil or loop welding cables around your body.
- ▲ Don't weld while standing on a wet surface or while standing in water.

## SAFETY IN WELDING CONT.

## C) FUMES &amp; GASES:

Caused by the melting, vapourisation and other reactions of the consumables, base metals and gases (where applicable) involved in the welding arc.

Some common contaminants:

Contaminant	Source
Iron fume	Vaporisation of iron from base metal and electrode coatings.
Chromium	Stainless steel, electrode coatings, platings.
Nickel	Stainless steel, nickel-clad steel.
Zinc fume	Vaporisation of zinc alloys, electrode coatings galvanised steel, zinc-primed steel.
Copper fume	Vaporisation of coatings on electrode wires, sheaths on air carbon arc gouging electrodes, copper alloys.
Vanadium, Manganese, Molybdenum	Welding rods, alloying elements in steels.
Tin	Tin-coated steel, some nonferrous alloys.
Cadmium	Plating
Lead	Fluxes, coatings on electrodes, flux in wires
Carbon Monoxide	Combustion products of gas metal arc welding, air carbon arc gouging, oxyfuel flames; exhaust from car engines.
Ozone	Gas metal arc welding, air carbon arc gouging; titanium and aluminium welding in inert gas atmospheres
Nitrogen dioxide	Gas metal arc welding; oxyfuel flame processes.
Phosgene	Welding of metal covered with chlorinated hydrocarbon solvents.

Exposure to fumes and gases can damage the lungs and respiratory system or cause asphyxiation.



## SAFETY IN WELDING CONT.

## Fumes and Gases:

## (i) PROTECTION REQUIRED FROM FUMES AND GASES:-

- ▲ Adequate ventilation.
- ▲ Keep your head out and away from the fumes.
- ▲ Use a welding fume respirator, or an air supplied respirator (especially in confined space).
- ▲ Use a fume extraction unit/or gun.

**N.B.** Welding fume fever caused by breathing fumes formed by the welding of various metals can occur a few hours after exposure and can last several days.

## SYMPTOMS INCLUDE:-

- |            |                           |
|------------|---------------------------|
| ▲ Nausea   | ▲ Fatigue                 |
| ▲ Fever    | ▲ Dry nose and throat     |
| ▲ Chills   | ▲ Metallic taste in mouth |
| ▲ Weakness | ▲ Joint and muscle pain   |

**Note:** If any of these symptoms are observed please seek professional medical attention.

## D) HEAT, FIRE &amp; SPARKS:

- ▲ Are caused by welding and related processes, operators are at continual risk of burns by hot and molten metal, sparks and heat radiated from the arc.
- ▲ Welding sparks can travel long distances and have been known to reach up to 15 metres away from the source of welding on the ground and even further when working in elevated positions.
- ▲ These sparks can reach combustible materials and start fires, as well as burning unprotected skin.
- ▲ Burns can result from handling hot just welded work (the most common of welding burns) and molten weld metal (spatter) falling or spitting onto exposed skin.

## (i) PROTECTION REQUIRED FROM HEAT, FIRE AND SPARKS:

- ▲ Always wear protective clothing.
- ▲ Keep safety glasses on your head where they belong.
- ▲ Always mark just welded work with the word "HOT".
- ▲ Know where the nearest fire extinguisher or fire hose is and how to use them.
- ▲ Remove combustible materials away from the welding area. (at least 15 metres or 50 feet away).
- ▲ If in an elevated position, post a person on the ground as a fire-watcher.
- ▲ Never connect the earth lead to electrical circuits of pipes containing gases or flammable liquids.

SAFETY IN WELDING CONT.

Repair or replace defective cables immediately.



Keep fire extinguishing equipment at a handy location near the job.



Never watch the arc except through filters of the correct shade.



Conduct engine exhaust to outside atmosphere.



In confined spaces, adequate ventilation and constant observation are essential.

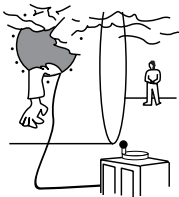

Keep primary terminals and live parts effectively covered.



Leads and cables should be kept clear of passageways.

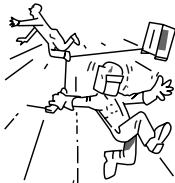

Never strike an electrode on any gas cylinder.



Never use oxygen for venting containers.



## CONSUMABLES CLASSIFICATION TABLES

### AS/NZS 1553 Part 1-1995 Covered Electrodes for Welding Low Carbon Steel

AS/NZS 1553.1 classifies Manual Metal Arc Welding (MMAW / Stick) electrodes by using a series of letters and digits broken into two alpha numeric groups separated by a hyphen. eg: E4818-4H5R. NB. The second group separated by the hyphen as shown is optional. ie. 4H5R is optional.

The following layout outlines this classification system in part only. For full details CIGWELD recommend you refer to the current published version of AS/NZS 1553 Part 1. obtainable from the Standards Association of Australia or Standards New Zealand.

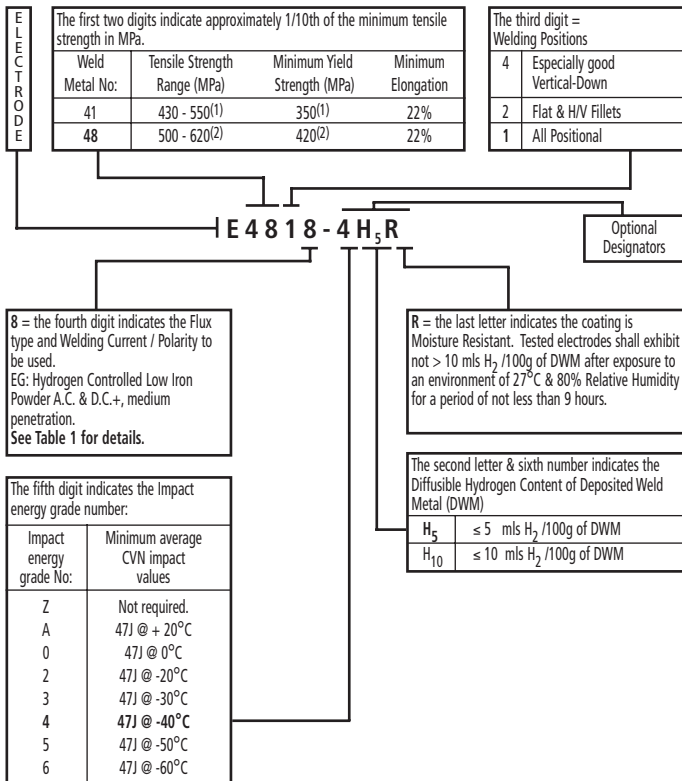

## CONSUMABLES CLASSIFICATION TABLES

AS/NZS 1553 Part 1-1995 Covered Electrodes for Welding Low Carbon Steel cont.

AS/NZS 1553.1 Electrode Classification Summary - Table 1

Electrode Classification	Welding Positions	Type of Current and Polarity	Type of Flux Covering and Slag Type	Penetration
EXX10	F, V, OH, H	D.C. + Fluid Slag	High Cellulose	Deep
EXX11	F, V, OH, H	A.C. & D.C. + Fluid Slag	High Cellulose	Deep
EXX12	F, V, OH, H	A.C. & D.C. + or - (Viscous)	High Titania, Stiff Slag	Medium
EXX13	F, V, OH, H	A.C. & D.C. + or -	High Titania, Fluid Slag	Medium
EXX14	F, V, OH, H	A.C. & D.C. + or - Stiff Slag (Viscous)	Low Iron Powder, Titania	Low
EXX15	F, V, OH, H	D.C. + Hydrogen Controlled	Basic,	Medium
EXX16	F, V, OH, H	A.C. & D.C. + Hydrogen Controlled	Basic,	Medium
EXX18	F, V, OH, H	A.C. & D.C. + Low Iron Powder	Basic Hydrogen Controlled,	Medium
EXX19	F, V, OH, H	A.C. & D.C. + or - Potassium	Iron Oxide Titania	Medium
EXX20	F & H/V-FILLET	A.C. & D.C. + or -	High Iron Oxide	Deep
EXX24	F & H/V-FILLET	A.C. & D.C. + or - Titania	High Iron Powder,	Low
EXX27	F & H/V-FILLET	A.C. & D.C. + or - Iron Oxide	High Iron Powder & Iron Oxide	Deep
EXX28	F & H/V-FILLET	A.C. & D.C. + High Iron Powder	Basic Hydrogen Controlled,	Medium
EXX46	F, V, OH, H V-DOWN	A.C. & D.C. +	Basic, Hydrogen Controlled	Medium
EXX48	F, V, OH, H V-DOWN	A.C. & D.C. +	Basic Hydrogen Controlled, Low Iron Powder	Medium
EXX99	As Specified by the Manufacturer	As Specified by the Manufacturer	As Described by the Manufacturer	As Specified

\* Legend to Abbreviations:

F = Flat

V = Vertical

H = Horizontal

OH = Overhead

H/V-FILLET = Horizontal-Vertical Fillet

V-DOWN = Vertical-Down

## CONSUMABLES CLASSIFICATION TABLES

### AS/NZS 1553 Part 2-1995 Covered Electrodes for Welding Low Carbon Steel

AS/NZS 1553.2 classifies Manual Metal Arc Welding (MMAW / Stick) electrodes by using a series of letters and digits broken into two alpha numeric groups separated by a hyphen. eg: E4818-4H5R. NB. The second group separated by the hyphen as shown is optional. ie. 4H5R is optional.

The following layout outlines this classification system in part only. For full details CIGWELD recommend you refer to the current published version of AS/NZS 1553 Part 2, obtainable from the Standards Association of Australia or Standards New Zealand.

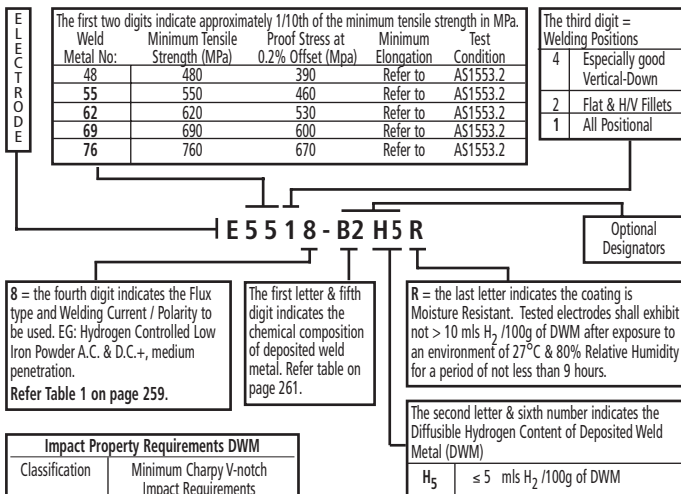

\*Stress relieved impact properties

## CONSUMABLES CLASSIFICATION TABLES

### Chemical Composition Requirements of Deposited Weld Metal – AS1553.2

Classification	C	S	Chemical Composition Mass %					Cr	Mo	V	Cu
			P	Mn	Si	Ni					
<b>CARBON - MOLYBDENUM STEEL ELECTRODES</b>											
E4810-A1				0.6							
E4811-A1				0.6							
E4815-A1				0.6							
E4816-A1				0.9							
E4818-A1	0.12	0.04		0.03		0.8		0.4-0.65			
E4820-A1				0.6							
E4827-A1				1							
E4828-A1				0.9							
E4845-A1				0.9							
E4846-A1				0.9							
E4848-A1				0.9							
<b>CHROMIUM - MOLYBDENUM STEEL ELECTRODES</b>											
E5515-B1				0.6							
E5516-B1	0.05-0.12	0.04		0.03		0.6		0.4-0.65	0.4-0.65		
E5518-B1				0.8							
E5515-B2				0.6							
E5516-B2	0.05-0.12	0.04		0.03		0.6		1.0-1.5	0.4-0.65		
E5518-B2				0.8							
E5515-B2L				1							
E5516-B2L	0.05	0.04		0.03		0.6		1.0-1.5	0.4-0.65		
E5518-B2L				0.8							
E6215-B3				0.6							
E6216-B3	0.05-0.12	0.04		0.03		0.6		2.0-2.5	0.90-1.20		
E6218-B3				0.8							
E6215-B3L				1							
E6216-B3L	0.05	0.04		0.03		0.6		2.0-2.5	0.90-1.20		
E6218-B3L				0.8							
E5515-B4L	0.05	0.04		0.03		0.9		1.75-2.25	0.4-0.65		
E5516-B5	0.07-0.15	0.04		0.03		0.4-0.7	0.3-0.6	0.4-0.6	1.0-1.25	0.05	
E4115-5Cr				1		0.9		0.4	4.0-6.0	0.45-0.65	0.75
E4116-5Cr	0.1	0.03		0.04		1	0.9	0.4	4.0-6.0	0.45-0.65	0.75
E4118-5Cr				0.8							
E4115-7Cr				1		0.9		0.4	6.0-8.0	0.45-0.65	0.75
E4116-7Cr	0.1	0.03		0.04		1	0.9	0.4	6.0-8.0	0.45-0.65	0.75
E4118-7Cr				0.8							
E4115-9Cr				1		0.9		0.4	8.0-10.5	0.85-1.2	0.75
E4116-9Cr	0.1	0.03		0.04		1	0.9	0.4	8.0-10.5	0.85-1.2	0.75
E4118-9Cr				0.8							
<b>NICKEL STEEL ELECTRODES</b>											
E5516-C1	0.12	0.04		0.03		0.6		2.0-2.75			
E5518-C1				1.25		0.8					
E4815-C1L				1.25		0.5		2.0-2.75			
E4816-C1L	0.05	0.04		0.03		1.25		2.0-2.75			
E4818-C1L				0.8							
E5516-C2	0.12	0.04		0.03		0.6		3.0-3.75			
E5518-C2				1.25		0.8					
E4815-C2L				1.25		0.5		3.0-3.75			
E4816-C2L	0.05	0.04		0.03		1.25		3.0-3.75			
E4818-C2L				0.8							
E5516-C3	0.12	0.03		0.03		0.40-1.25	0.8	0.80-1.10	0.15	0.35	0.05
E5518-C3				0.8							
<b>NICKEL MOLYBDENUM STEEL ELECTRODES</b>											
E5516-NM	0.1	0.03		0.02		0.80-1.25	0.6	0.80-1.10	0.05	0.40-0.65	0.02
E5518-NM				0.8							0.1
<b>MANGANESE MOLYBDENUM STEEL ELECTRODES</b>											
E6215-D1				0.6							
E6216-D1	0.12	0.04		0.03		1.25-1.75	0.6		0.25-0.45		
E6218-D1				0.8							
E6915-D2				0.6							
E6916-D2	0.15	0.04		0.03		1.65-2.0	0.6		0.25-0.45		
E6918-D2				0.8							
E5515-D3				0.6							
E5516-D3	0.12	0.4		0.03		1.0-1.75	0.6		0.40-0.65		
E5518-D3				0.8							
<b>OTHER LOW-ALLOY STEEL ELECTRODES</b>											
EXXXX-G				1.00 Min		0.80 Min	0.50 Min	0.30 Min	0.20 Min	0.10 Min	
E6216-M	0.1	0.03		0.03		0.60-1.25	0.8	1.40-1.80	0.15	0.35	0.05
E6218-M				0.8							
E6916-M	0.1	0.03		0.03		0.75-1.70	0.6	1.40-2.10	0.35	0.25-0.50	0.05
E6918-M				0.8							
E7616-M	0.1	0.03		0.03		1.3-1.8	0.6	1.25-2.5	0.4	0.25-0.5	0.05
E7618-M				0.8							
E8316-M	0.1	0.03		0.03		1.3-2.25	0.6	1.75-2.5	0.3-1.5	0.3-0.55	0.05
E8318-M				0.8							
E8316-M1	0.1	0.012		0.015		0.8-1.6	0.65	3.0-3.8	0.65	0.2-0.3	0.05
E8318-M1				0.8							
E4816-W	0.12	0.025		0.025		0.4-0.7	0.4-0.7	0.2-0.4	0.15-0.3	0.08	0.3-0.60
E4818-W				0.8							
E5516-W	0.12	0.04		0.03		0.5-1.3	0.35-0.8	0.4-0.8	0.45-0.7		0.3-0.75
E5518-W				0.8							

Single values are maximums.

## CONSUMABLES CLASSIFICATION TABLES

### AWS A5.1-91 Carbon Steel Electrodes for Shielded Metal Arc Welding

AWS A5.1-91 classifies Shielded Metal Arc Welding (SMAW / MMAW) electrodes by using a series of letters and digits broken into two alpha numeric groups separated by a hyphen.

eg: E7018 H4R. NB. The alpha numeric group after the four digit number (or five in the case of E7018-1) is optional. ie. H4R is optional.

The following layout outlines this classification system in part only. For full details CIGWELD recommend you refer to the current published version of AWS A5.1 obtainable from the American Welding Society, 550 N.W. LeJeune Road, Miami, Florida 33126, USA.

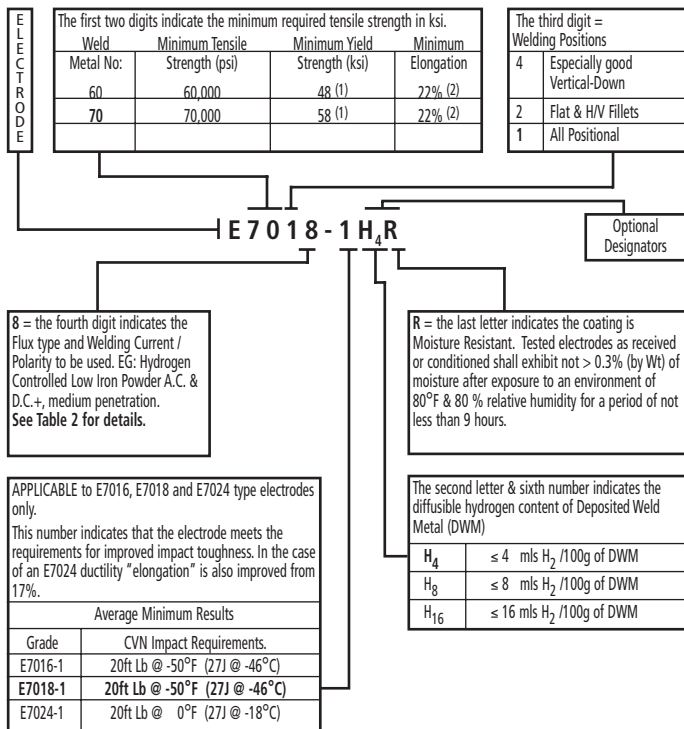

(1) Yield on E6022 electrodes is not specified and E7018M may have a range of 53-72 ksi for all diameters other than 3/32 (2.4mm) which is 53-77 ksi. (2) Minimum elongation for E6012, E6013, E7014 and E7024 types is 17%. Elongation on E6022 electrodes is not specified, and E7018M types are required to meet 24%.

## CONSUMABLES CLASSIFICATION TABLES

## AWS A5.1-91 Carbon Steel Electrodes for Shielded Metal Arc Welding cont.

AWS A5.1 Electrode Classification Summary - Table 2

Electrode Classification	Welding Positions	Type of Current and Polarity	Type of Flux Covering and Slag Type or "Use"	Penetration
E6010	F, V, OH, H	D.C. +	High Cellulose Sodium Thin Friable Slag	Deep
E6011	F, V, OH, H	A.C. & D.C. +	High Cellulose Potassium Thin Friable Slag	Deep
E6012	F, V, OH, H	A.C. & D.C. + or -	High Titania Sodium, Dense Slag	Medium
E6013	F, V, OH, H	A.C. & D.C. + or -	High Titania Potassium, Dense-Fluid Slag	Medium
E7014	F, V, OH, H	A.C. & D.C. + or -	Low Iron Powder, Titania Self Removing Slag	Low
E7015	F, V, OH, H	D.C. +	Low Hydrogen Sodium Basic Slag Heavy & Friable	Medium
E7016	F, V, OH, H	A.C. & D.C. +	Low Hydrogen Potassium Basic Slag Heavy & Friable	Medium
E7018	F, V, OH, H	A.C. & D.C. +	Low Hydrogen Potassium Iron Powder	Medium
E7018M	F, V, OH, H	D.C. +	Low Hydrogen Iron Powder "Military Hydrogen Controlled"	Medium
E6019	F, V, OH, H	A.C. & D.C. + or -	Iron Oxide Titania Potassium Fluid Slag	Medium
E6020	F & H/V-FILLET	A.C. & D.C. + or -	High Iron Oxide Easily Removable Slag	Medium to Deep
E6022	F & H/V-FILLET	A.C. & D.C. -	High Iron Oxide "Single-Pass Welds Only"	Deep
E7024	F & H/V-FILLET	A.C. & D.C. + or -	Iron Powder, Titania "High Deposition Efficiency"	Low
E6027	F & H/V-FILLET	A.C. & D.C. + or -	High Iron Oxide Iron Powder Heavy Honeycombed Slag	Medium
E7027	F & H/V-FILLET	A.C. & D.C. + or -	High Iron Oxide Iron Powder Heavy Honeycombed Slag	Medium
E7028	F & H/V-FILLET	A.C. & D.C. +	Low Hydrogen Potassium, Iron Powder	Medium
E7048	F, V, OH, H V-DOWN	A.C. & D.C. +	Low Hydrogen Potassium, Iron Powder	Medium

\* Legend to Abbreviations: F = Flat      OH = Overhead      V = Vertical  
H = Horizontal      V-DOWN = Vertical-Down      H/V-FILLET = Horizontal-Vertical Fillet

E7018M type electrodes are intended to meet most military requirements and have greater toughness, lower coating moisture content, both as-received and after exposure, and also conform to mandatory diffusible hydrogen limits for deposited weld metal.



# CONSUMABLES CLASSIFICATION TABLES

## AWS A5.5-96 Low Alloy Steel Covered Arc Welding Electrodes

AWS A5.5-96 classifies Shielded Metal Arc Welding (SMAW / MMAW) electrodes by using a series of letters and digits broken into two alpha numeric groups separated by a hyphen. eg: E7010-A1 or E8010-P1. NB. The alpha numeric group after the four digit number indicates chemical analysis requirements. The following layout outlines this classification system in part only. For full details CIGWELD recommend you refer to the current published version of AWS A5.5 obtainable from the American Welding Society, 550 N.W. LeJeune Road, Miami, Florida 33126, USA.

Weld Metal No:	Min. Tensile Strength (psi)	Yield Strength <sup>(1)</sup> (ksi)	Weld Metal No:	Min. Tensile Strength (psi)	Yield Strength (ksi)
7010-P1	70,000	60	100	100,000	87
70	70,000	57	10018-M	100,000	88-100
70xx-B2L	75,000	57	110	110,000	97
80	80,000	67	11018M	110,000	98-110
80xx-C3	80,000	68-80	120	120,000	107
90	90,000	77	12018M	120,000	108-120
9018M	90,000	78-90	12018M1	120,000	108-120

80 = the first two digits indicate the minimum required tensile strength in ksi.

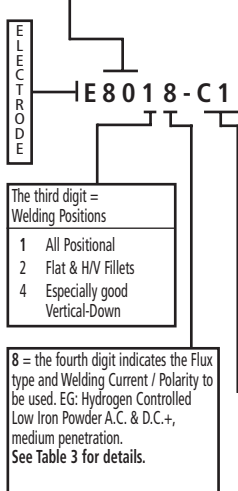

Classification Suffixes by Major Chemical Analysis (%)						
Type	C	Mn	Ni	Cr	Mo	V
Carbon-Molybdenum Steel Electrodes						
A1	0.12	0.60-1.00	---	---	0.40-0.65	---
Chromium-Molybdenum Steel Electrodes						
B1	0.05-0.12	0.90	---	0.40-0.65	0.40-0.65	---
B2	0.05-0.12	0.90	---	1.00-1.50	0.40-0.65	---
B2L	0.05	0.90	---	1.00-1.50	0.40-0.65	---
B3	0.05-0.12	0.90	---	2.00-2.50	0.90-1.20	---
B3L	0.05	0.90	---	2.00-2.50	0.90-1.20	---
B4L	0.05	0.90	---	1.75-2.25	0.40-0.65	---
B5	0.07-0.15	0.40-0.70	---	0.40-0.60	1.00-1.25	0.05
B6	0.05-0.10	1.00	---	4.00-6.00	0.45-0.65	---
B6L	0.05	1.00	---	4.00-6.00	0.45-0.65	---
B7	0.05-0.10	1.00	---	6.00-8.00	0.45-0.65	---
B7L	0.05	1.00	---	6.00-8.00	0.45-0.65	---
B8	0.05-0.10	1.00	---	8.00-10.50	0.85-1.20	---
B8L	0.05	1.00	---	8.00-10.50	0.85-1.20	0.05
B9	0.08-0.13	1.25	---	8.00-10.50	0.85-1.20	0.15-0.30
Nickel Steel Electrodes						
C1	0.12	1.25	2.00-2.75	---	---	---
C1L	0.05	1.25	2.00-2.75	---	---	---
C2	0.12	1.25	3.00-3.75	---	---	---
C2L	0.05	1.25	3.00-3.75	---	---	---
C3	0.12	0.40-1.25	0.80-1.10	0.15	0.35	0.05
C3L	0.08	0.40-1.40	0.80-1.10	0.15	0.35	0.05
C4	0.10	1.25	1.10-2.00	---	---	---
CSL	0.05	0.40-1.00	6.00-7.25	---	---	---
Nickel-Molybdenum Steel Electrodes						
NM	0.10	0.80-1.25	0.80-1.10	0.10	0.40-0.65	0.02
Manganese-Molybdenum Steel Electrodes						
D1	0.12	1.00-1.75	0.90	---	0.25-0.45	---
D2	0.15	1.65-2.00	0.90	---	0.25-0.45	---
D3	0.12	1.00-1.80	0.90	---	0.40-0.65	---
Pipeline Electrodes						
P1	0.20	1.20	1.00	0.30	0.50	0.10
G = General and M = Military						
G*	---	1.00 min	0.50 min	0.30 min	0.20 min	0.10 min
M#	0.10	0.60-2.25	1.25-2.50	0.15-1.50	0.25-0.55	0.05
M1	0.10	0.80-1.60	3.00-3.80	0.65	0.20-0.30	0.05

**Notes:**

- (1) Yield on E7010-P1 and E7018-W1 is required to be 60 ksi (415MPa).
- (2) \* G classifications require the weld deposit to exhibit only a minimum of one (1) element listed.
- (3) # M classification chemical limits can vary widely in the case of Mn, Ni, Cr and Mo, refer to page 5 of AWS A5.5-96 for details. EX018-M electrodes are intended to meet most military requirements and have greater toughness, lower coating moisture content, both as-received and after exposure, and also conform to mandatory diffusible hydrogen limits for deposited weld metal.

## CONSUMABLES CLASSIFICATION TABLES

## AWS A5.5-96 Low Alloy Steel Covered Arc Welding Electrodes cont.

AWS A5.5 Electrode Classification Summary - Table 3

Electrode Classification	Welding Positions	Type of Current and Polarity	Type of Flux Covering and Slag Type or "Use"	Penetration
E70 Series, 70,000 psi (480 MPa)				
E7010-X	F, V, OH, H	D.C. +	High Cellulose Sodium	Deep
E7011-X	F, V, OH, H	A.C. & D.C. +	High Cellulose Potassium	Deep
E7015-X	F, V, OH, H	D.C. +	Low Hydrogen Sodium	Medium
E7016-X	F, V, OH, H	A.C. & D.C. +	Low Hydrogen Potassium	Medium
E7018-X	F, V, OH, H	A.C. & D.C. +	Iron Powder, Low Hydrogen	Medium
E7020-X	F & H/V-FILLET	A.C. & D.C. + or -	High Iron Oxide	Medium to Deep
E7027-X	F & H/V-FILLET	A.C. & D.C. + or -	High Iron Oxide, Iron Powder	Medium
E80 Series, 80,000 psi (550 MPa)				
E8010-X	F, V, OH, H	D.C. +	High Cellulose Sodium	Deep
E8011-G	F, V, OH, H	A.C. & D.C. +	High Cellulose Potassium	Deep
E8013-G	F, V, OH, H	A.C. & D.C. + or -	High Titania Potassium,	Medium
E8015-X	F, V, OH, H	D.C. +	Low Hydrogen Sodium	Medium
E8016-X	F, V, OH, H	A.C. & D.C. +	Low Hydrogen Potassium	Medium
E8018-X	F, V, OH, H	A.C. & D.C. +	Low Hydrogen, Iron Powder	Medium
E90 Series, 90,000 psi (620 MPa)				
E9010-G	F, V, OH, H	D.C. +	High Cellulose Sodium	Deep
E9011-G	F, V, OH, H	A.C. & D.C. +	High Cellulose Potassium	Deep
E9013-G	F, V, OH, H	A.C. & D.C. + or -	High Titania Potassium,	Medium
E9015-X	F, V, OH, H	D.C. +	Low Hydrogen Sodium	Medium
E9016-X	F, V, OH, H	A.C. & D.C. +	Low Hydrogen Potassium	Medium
E9018-X	F, V, OH, H	A.C. & D.C. +	Low Hydrogen, Iron Powder	Medium
E9018M	F, V, OH, H	D.C. +	Low Hydrogen, Iron Powder	Medium
E100 Series, 100,000 psi (690 MPa)				
E10010-G	F, V, OH, H	D.C. +	High Cellulose Sodium	Deep
E10011-G	F, V, OH, H	A.C. & D.C. +	High Cellulose Potassium	Deep
E10013-G	F, V, OH, H	A.C. & D.C. + or -	High Titania Potassium,	Medium
E10015-X	F, V, OH, H	D.C. +	Low Hydrogen Sodium	Medium
E10016-X	F, V, OH, H	A.C. & D.C. +	Low Hydrogen Potassium	Medium
E10018-X	F, V, OH, H	A.C. & D.C. +	Low Hydrogen, Iron Powder	Medium
E10018M	F, V, OH, H	D.C. +	Low Hydrogen, Iron Powder	Medium
E110 Series, 110,000 psi (760 MPa) and E120 Series, 120,000 psi (830 MPa)				
E11010-G	F, V, OH, H	D.C. +	High Cellulose Sodium	Deep
E11011-G	F, V, OH, H	A.C. & D.C. +	High Cellulose Potassium	Deep
E11013-G	F, V, OH, H	A.C. & D.C. + or -	High Titania Potassium,	Medium
E11015-G	F, V, OH, H	D.C. +	Low Hydrogen Sodium	Medium
E11016-G	F, V, OH, H	A.C. & D.C. +	Low Hydrogen Potassium	Medium
E11018-G	F, V, OH, H	A.C. & D.C. +	Low Hydrogen, Iron Powder	Medium
E11018M	F, V, OH, H	D.C. +	Low Hydrogen, Iron Powder	Medium
E12010-G	F, V, OH, H	D.C. +	High Cellulose Sodium	Deep
E12011-G	F, V, OH, H	A.C. & D.C. +	High Cellulose Potassium	Deep
E12013-G	F, V, OH, H	A.C. & D.C. + or -	High Titania Potassium,	Medium
E12015-G	F, V, OH, H	D.C. +	Low Hydrogen Sodium	Medium
E12016-G	F, V, OH, H	A.C. & D.C. +	Low Hydrogen Potassium	Medium
E12018-G	F, V, OH, H	A.C. & D.C. +	Low Hydrogen, Iron Powder	Medium
E12016M	F, V, OH, H	A.C. & D.C. +	Low Hydrogen Potassium	Medium
E12018M1	F, V, OH, H	A.C. & D.C. +	Low Hydrogen, Iron Powder	Medium

Legend to Abbreviations: F = Flat, V = Vertical, H = Horizontal, OH = Overhead, H/V-FILLET = Horizontal-Vertical Fillet

# CONSUMABLES CLASSIFICATION TABLES

## AS/NZS 2717 Part 1-1996 Ferritic Steel Electrodes For Gas Metal Arc Welding

AS/NZS 2717.1 classifies Gas Metal Arc Welding (GMAW / MIG) wires by using a series of letters and digits broken into three (3) alpha numeric groups separated by hyphens. e.g.: E54-GM-W503AH. The following table outlines this classification system in part only. For full details CIGWELD recommends that you refer to the current published version of AS/NZS 2717 Part 1, obtainable from the Standards Association of Australia or Standards New Zealand.

Weld metal properties.			
The first two digits indicate approximately 1/10th the tensile strength of the weld metal in MPa.			
Weld Metal Classification	Minimum Tensile	Minimum Yield	Minimum Elongation
W41	420 MPa	not applicable	20%
<b>W50</b>	<b>500 MPa</b>	<b>360 MPa</b>	<b>22%</b>
W55	550 MPa	470 MPa	19%
W62	620 MPa	540 MPa	17%
W69	690 MPa	610-700 MPa	16%
W76	760 MPa	660-740 MPa	15%
W83	830 MPa	730-840 MPa	14%

The third digit indicates Impact energy grade No:	
Impact energy grade No:	Min. average CVN impacts
Z	Not required.
A	47J @ + 20°C
0	47J @ 0°C
2	47J @ -20°C
3	47J @ -30°C
4	47J @ -40°C
5	47J @ -50°C
6	47J @ -60°C
W559XH-Ni1	27J @ -45°C
W559XH-Ni2	27J @ -60°C
W559XH-Ni3	27J @ -73°C
W559XH-D2	27J @ -30°C
W699XH-M2	68J @ -50°C
W769XH-M3	68J @ -50°C
W839XH-M4	68J @ -50°C
W699XH-M5	68J @ -50°C

**E 5 6 - G C / M - W 5 0 3 A H**

Type of external shielding.

**G** = Gas followed by either of these listed:

**C** = Carbon dioxide.

**M** = Mixed shielding gas eg: Argoshield 51.

**I** = Inert shielding gas.

Indicating the applicable heat treatment condition.

**A** = as-welded condition.

**P** = postwelded heat treatment.

**H** = hydrogen controlled weld metal. ≤ 15 ml of H<sub>2</sub> / 100gms of deposited weld metal.

**E** = Electrode, **S** = Solid Wire followed by a number or letter which defines the chemical composition of the wire.

Wire Classification	Carbon (C)	Manganese (Mn)	Silicon (Si)	Other Elements Nominal Range %
ES2	0.07	0.90-1.40	0.40-0.70	0.25Cu / 0.10Ti / 0.07Zr / 0.10Al
ES3	0.06-0.15	0.90-1.40	0.45-0.75	0.25Cu
ES4	0.07-0.15	1.00-1.50	0.60-0.85	0.25Cu
ES5	0.07-0.19	0.90-1.40	0.30-0.60	0.70Al
<b>ES6</b>	<b>0.06-0.15</b>	<b>1.40-1.85</b>	<b>0.80-1.15</b>	<b>0.25Cu</b>
ES7	0.07-0.15	1.50-2.00	0.50-0.80	0.25Cu
ESB2	0.07-0.12	0.40-1.2	0.40-0.70	1.25Cr / 0.50Mo / 0.17Cu
ESB2L	0.05	0.40-1.2	0.40-0.70	1.25Cr / 0.50Mo / 0.17Cu
ESB3	0.07-0.12	0.40-1.2	0.40-0.70	2.50Cr / 1.05Mo / 0.17Cu
ESB3L	0.05	0.40-1.2	0.40-0.70	2.50Cr / 1.05Mo / 0.17Cu
ES5Cr	0.10	1.00	0.90	0.20Ni / 5.25Cr / 0.55Mo / 0.37Cu
ES7Cr	0.10	1.00	0.90	0.20Ni / 7.00Cr / 0.55Mo / 0.37Cu
ES9Cr	0.10	1.00	0.90	0.20Ni / 9.25Cr / 1.02Mo / 0.37Cu
ESNi1	0.12	1.25	0.40-0.80	0.95Ni / 0.07Cr / 0.17Mo / 0.02V / 0.12Cu / 0.05ea, Ti / Zr / Al
ESNi2	0.12	1.25	0.40-0.80	2.37Ni / 0.17Cu
ESNi3	0.12	1.25	0.40-0.80	3.37Ni / 0.17Cu
ESD2	0.07-0.12	1.60-2.10	0.50-0.80	0.07Ni / 0.50Mo / 0.25Cu
ESM2	0.08	1.25-1.80	0.20-0.50	1.75Ni / 0.15Cr / 0.40Mo / 0.02V / 0.12Cu / 0.05ea, Ti / Zr / Al
ESM3	0.09	1.25-1.80	0.20-0.55	2.25Ni / 0.25Cr / 0.20Mo / 0.02V / 0.12Cu / 0.05ea, Ti / Zr / Al
ESM4	0.10	1.25-1.80	0.20-2.60	4.80Ni / 0.30Cr / 0.95Mo / 0.01V / 0.12Cu / 0.05ea, Ti / Zr / Al
ESM5	0.12	1.25-1.80	0.20-2.60	4.80Ni / 0.30Cr / 0.95Mo / 0.01V / 0.12Cu / 0.05ea, Ti / Zr / Al

ESMG = General, composition is agreed between the supplier & customer

## CONSUMABLES CLASSIFICATION TABLES

### AWS A5.18-1993 Carbon Steel Electrodes and Rods for Gas Shielded Arc Welding

AWS A5.18-93 classifies Gas Metal Arc Welding (GMAW / MIG) wires by using a series of letters and digits broken into two (2) alpha numeric groups separated by a hyphen. e.g.: ER70S-6 and E70C-6M

The following layout outlines this classification system in part only. For full details CIGWELD recommend you refer to the current published version of AWS A5.18 obtainable from the American Welding Society, 550 N.W. LeJeune Road, Miami, Florida 33126, USA.

As Welded Mechanical Properties (Minimum)						
AWS Class.	Tensile Strength		Yield Strength		% Elong.	Charpy-V-Notch (CVN) Impact Requirements
	psi	MPa	psi	MPa		
ER70S-2	70,000	480	58,000	400	22	20ft Lb @ -20°F (27J @ -29°C)
ER70S-3	70,000	480	58,000	400	22	20ft Lb @ 0°F (27J @ -18°C)
ER70S-4	70,000	480	58,000	400	22	Not Required
ER70S-5	70,000	480	58,000	400	22	Not Required
<b>ER70S-6</b>	<b>70,000</b>	<b>480</b>	<b>58,000</b>	<b>400</b>	<b>22</b>	<b>20ft Lb @ -20°F (27J @ -29°C)</b>
ER70S-7	70,000	480	58,000	400	22	20ft Lb @ -20°F (27J @ -29°C)
ER70S-G	70,000	480	58,000	400	22	As agreed between supplier & purchaser
E70C-3X	70,000	480	58,000	400	22	20ft Lb @ 0°F (27J @ -18°C)
E70C-6X	70,000	480	58,000	400	22	20ft Lb @ -20°F (27J @ -29°C)
E70C-G(X)	70,000	480	58,000	400	22	As agreed between supplier & purchaser
E70C-GS(X)	70,000	480	Not Specified			Not Required

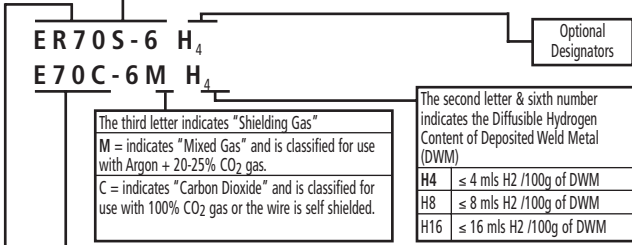

**E** = Electrode, **R** = Rod, **S** = Solid Wire, **C** = Composite Metal Cored Wire, followed by a hyphen then a number or letter which defines the chemical composition of the wire.

Wire Classification	Carbon (C)	Manganese (Mn)	Silicon (Si)	Other Elements Allowable % Range
ER70S-2	0.07	0.90-1.40	0.40-0.70	0.05-0.15Ti / 0.02-0.12Zr / 0.05-0.15Al
ER70S-3	0.06-0.15	0.90-1.40	0.45-0.75	0.50Cu
ER70S-4	0.07-0.15	1.00-1.50	0.60-0.85	0.50Cu
ER70S-5	0.07-0.19	0.90-1.40	0.30-0.60	0.50Cu / 0.50-0.90 Al
<b>ER70S-6</b>	<b>0.06-0.15</b>	<b>1.40-1.85</b>	<b>0.80-1.15</b>	<b>0.50Cu</b>
ER70S-7	0.07-0.15	1.50-2.00	0.50-0.80	0.50Cu
ER70S-G	G = General, composition is not specified and is agreed between the supplier and the customer.			
ER70C-3X	0.12	1.75	0.90	0.50Cu
<b>ER70C-6X</b>	<b>0.12</b>	<b>1.75</b>	<b>0.90</b>	<b>0.50Cu</b>
ER70C-G(X)	G = General, composition is not specified and is agreed between the supplier and the customer.			
ER70C-GS(X)	G = General, Single Pass Only, composition is agreed between the supplier and the customer.			

Single values are maximum. X represents shielding gas indicators e.g. "C" indicates CO<sub>2</sub> shielding gas and "M" indicates mixed shielding gases in the Argon + 20-25% CO<sub>2</sub>. (X) is optional for these classifications.

## CONSUMABLES CLASSIFICATION TABLES

### AS 2203 Part 1-1990 Cored Electrodes for Arc Welding Ferritic Steel Electrodes

AS 2203.1 classifies Flux Cored Arc Welding (FCAW / cored) wires by using a series of letters and digits broken into four alpha numeric groups separated by hyphens and the last group separated by a full stop.  
e.g. ETP-GCp-W504A.CM1 H<sub>10</sub>.

The following layout outlines this classification system in part only. For full details CIGWELD recommend you refer to the current published version of AS 2203 Part 1, obtainable from the Standards Association of Australia.

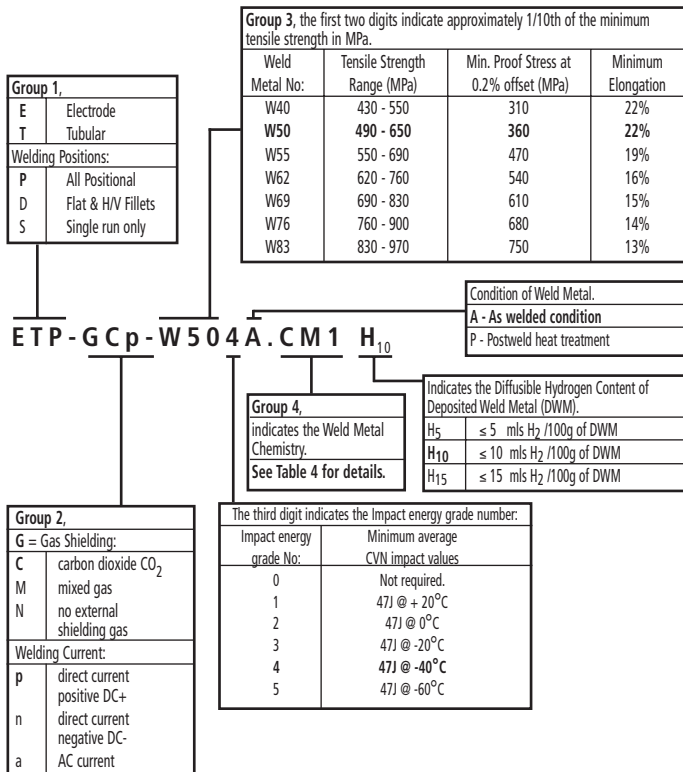

## CONSUMABLES CLASSIFICATION TABLES

AS 2203 Part 1-1990 Cored Electrodes for Arc Welding Ferritic Steel Electrodes cont.

AS 2203.1 Weld Metal Chemistry Wt% Summary - Table 4

Weld Metal No:	Carbon (C)	Manganese (Mn)	Silicon (Si)	Nickel (Ni)	Chromium (Cr)	Molybdenum (Mo)	Other Elements
Carbon Steel Cored Wires							
CM1	0.20	1.75	0.90	0.50	0.20	0.30	0.08V / 1.8Al
CM2	> 0.20	1.75	0.90	0.50	0.20	0.30	0.08V / 1.8Al
Carbon-Molybdenum Steel Cored Wires							
A1	0.12	1.25	0.80			0.40-0.65	
Chromium-Molybdenum Steel Cored Wires							
B1	0.12	1.25	0.80		0.40-0.65	0.40-0.65	
B2L	0.05	1.25	0.80		1.00-1.50	0.40-0.65	
B2	0.12	1.25	0.80		1.00-1.50	0.40-0.65	
B2C	0.10-0.15	1.25	0.80		1.00-1.50	0.40-0.65	
B3L	0.05	1.25	0.80		2.00-2.50	0.90-1.20	
B3	0.12	1.25	0.80		2.00-2.50	0.90-1.20	
B3C	0.10-0.15	1.25	0.80		2.00-2.50	0.90-1.20	
5Cr	0.10	1.50	1.00	0.40	4.00-6.00	0.45-0.65	0.50Cu
7Cr	0.10	1.50	1.00	0.40	6.00-8.00	0.45-0.65	0.50Cu
9Cr	0.10	1.50	1.00	0.40	8.00-10.50	0.85-1.20	0.50Cu
Nickel Steel Cored Wires							
Ni1	0.12	1.50	0.08	0.80-1.10	0.15	0.35	0.05V / 1.8Al
Ni2	0.12	1.50	0.08	1.75-2.75			0.05V / 1.8Al
Ni3	0.12	1.50	0.08	2.75-3.75			
Manganese-Molybdenum Steel Cored Wires							
9X.D1	0.12	1.25-2.00	0.80			0.25-0.55	
9X.D2	0.15	1.65-2.25	0.80			0.25-0.55	
9X.D3	0.12	1.00-1.75	0.80			0.40-0.65	
Other Low Alloy Steel Cored Wires							
9X.K1	0.15	0.80-1.40	0.80	0.80-1.10	0.15	0.20-0.65	0.05V
9X.K2	0.15	0.50-1.75	0.80	1.00-2.00	0.15	0.35	0.05V / 1.8Al
9X.K3	0.15	0.75-2.25	0.80	1.25-2.60	0.15	0.25-0.65	0.05V
9X.K4	0.15	1.20-2.25	0.80	1.75-2.60	0.20-0.60	0.30-0.65	0.05V
9X.K5	0.10-0.25	0.60-1.60	0.80	0.75-2.00	0.20-0.70	0.15-0.55	0.05V
9X.K6	0.15	0.50-1.50	0.80	0.40-1.10	0.15	0.15	0.05V / 1.8Al
9X.K7	0.15	1.00-1.75	0.08	2.00-2.75			
G		1.00 min.	0.80 min.	0.50 min.	0.30 min.	0.20 min.	0.10 min. / 1.8Al
9X.W	0.12	0.50-1.30	0.35-0.80	0.40-0.80	0.45-0.70		0.30-0.75Cu

Single values shown are maximum.

# CONSUMABLES CLASSIFICATION TABLES

## AWS A5.20-95 Carbon Steel Electrodes for Flux Cored Arc Welding

AWS A5.20-95 classifies Flux Cored Arc Welding (FCAW / cored) wires by using a series of letters and digits broken into two alpha numeric groups separated by a hyphen. eg: E70T-1 or E71T-1M JH<sub>4</sub>.

The following layout outlines this classification system in part only. For full details CIGWELD recommend you refer to the current published version of AWS A5.20 obtainable from the American Welding Society, 550 N.W. Leleune Road, Miami, Florida 33126, USA.

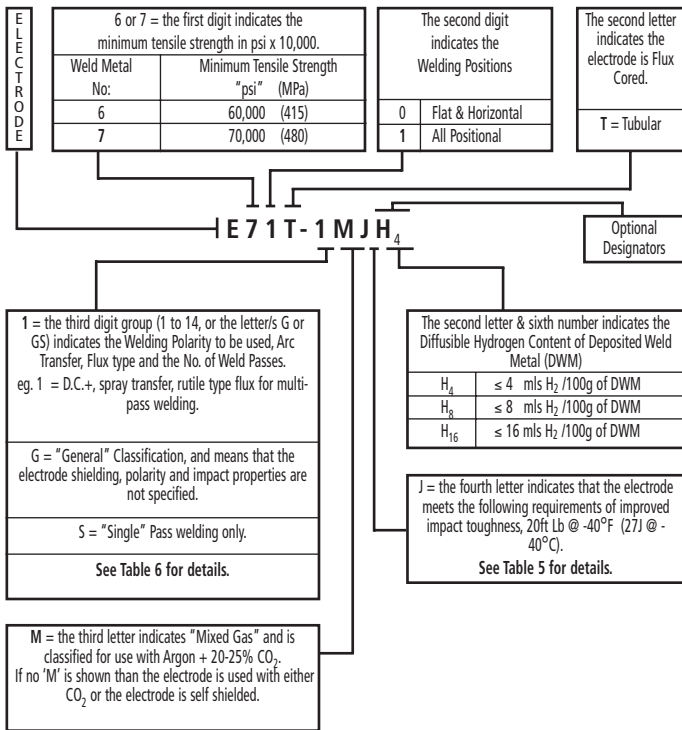

## CONSUMABLES CLASSIFICATION TABLES

### AWS A5.20-95 Carbon Steel Electrodes for Flux Cored Arc Welding cont.

#### Shielding Gas Types

**E7XT-1** These electrodes are designed primarily for use with CO<sub>2</sub> shielding gas. Argon based gases may be used to improve out-of-position characteristics.

**Warning:** By using Argon based gas mixtures with these electrode types the following problems may occur;

- 1) deoxidiser levels in weld deposits may increase,
- 2) weld deposit hardness levels may increase,
- 3) weld deposit manganese and silicon levels may increase which will raise yield and tensile strength, and may degrade impact properties.

**E7XT-1M** These electrodes are designed primarily for use with Argon + 20-25% CO<sub>2</sub> shielding gases.

**Warning:** Higher levels of CO<sub>2</sub> above those recommended, in Ar / CO<sub>2</sub> gases or the use of 100% CO<sub>2</sub> gas with these types of electrodes may result in the following;

- 1) deterioration of arc and out-of-position characteristics,
- 2) resultant weld deposits may show decreased levels of manganese and silicon which will reduce yield and tensile strength and may degrade impact properties.

**As Welded Mechanical Properties - Table 5**

AWS Class.	Tensile Strength		Yield Strength		% Elong.	Charpy-V-Notch (CVN) Impact Requirements
	ksi	MPa	ksi	MPa		
T-1/1M	70	480	58	400	22	20ft Lb @ 0°F (27J @ -18°C)
T-2/2M	70	480	n.s.	n.s.	n.s.	not specified
T-3*	70	480	n.s.	n.s.	n.s.	not specified
T-4*	70	480	58	400	22	not specified
T-5/5M	70	480	58	400	22	20ft Lb @ -20°F (27J @ -29°C)
T-6*	70	480	58	400	22	20ft Lb @ -20°F (27J @ -29°C)
T-7*	70	480	58	400	22	not specified
T-8*	70	480	58	400	22	20ft Lb @ -20°F (27J @ -29°C)
T-9/9M	70	480	58	400	22	20ft Lb @ -20°F (27J @ -29°C)
T-10*	70	480	n.s.	n.s.	n.s.	not specified
T-11*	70	480	58	400	20	not specified
T-12/12M	70-90	480-620	58	400	22	20ft Lb @ -20°F (27J @ -29°C)
T-13*	60	415	n.s.	n.s.	n.s.	not specified
T-13*	70	480	n.s.	n.s.	n.s.	not specified
T-14*	70	480	n.s.	n.s.	n.s.	not specified
T-G	60	415	48	330	22	not specified
T-G	70	480	58	400	22	not specified
T-GS	60	415	n.s.	n.s.	n.s.	not specified
T-GS	70	480	n.s.	n.s.	n.s.	not specified

The above designations may be classified with the 'J' indicator provided the lower CVN Impact requirements of 20ft Lb @ -40°F (27J @ -40°C), are met for T-1/1M, T-5/5M, T-6, T-8, T-9/M and T-12/12M types.

\* Self Shielded wire types.



## CONSUMABLES CLASSIFICATION TABLES

## AWS A5.20-95 Carbon Steel Electrodes for Flux Cored Arc Welding cont.

AWS A5.20 Electrode Classification Summary - Table 6

AWS A5.20 Class.	Polarity	Arc Transfer Type	Slag Base	No. of Weld Passes	Discernible Features and Applications
T-1 and T-1M	DC +	Spray	Rutile	Multiple	Larger diameters (2mm [5/64"] & larger) are used for flat & H/V welding only. Very smooth / quiet arc with low spatter loss, flat to slightly convex weld bead contour, full covering easy removed slag, and high deposition rates.
T-2 and T-2M	DC +	Spray	Rutile	Single	Essentially the same as T-1 / T-1M types, but with higher manganese or silicon or both. Higher levels of deoxidisers allow welding of heavily oxidised steels such as, rimmed, rusty and mill scaled steels. SINGLE pass only.
T-3*	DC +	Spray	Rutile Fluoride	Single	# High speed gasless welding in flat & H/V and 20° down inclined positions on sheet metal. Limited mech. props.
T-4*	DC +	Globular	Alumina Fluoride	Multiple	Very low Sulphur weld deposits (resistant to hot cracking) & very high deposition rates. Bridging of poor fit-up joints.
T-5 and T-5M	DC + / -	Globular	Basic	Multiple	Larger diameters (>2mm) are used for flat & H/V welding. Good mechanical properties (eg. impacts 27J @ -29°C / 20ft Lb @ -20°F) Slightly convex weld bead contour, easy removed thin slag, resistant to hot & cold cracking.
T-6*	DC +	Spray	Rutile Basic	Multiple	Good low temperature impact properties (eg. 27J @ -29°C / 20ft Lb @ -20°F). Excellent slag removal in deep groove joints. Good root run penetration. Flat & H/V only.
T-7*	DC -	Spray	Alumina Fluoride	Multiple	Dia. (>2mm) used for flat & H/V welding. High deposition rates and very low sulphur weld metal resistant to cracking.
T-8*	DC -	Spray	Alumina Fluoride	Multiple	Very good low temperature strength, notch toughness and crack resistance (eg. 27J @ -29°C / 20ft Lb @ -20°F).
T-9 and T-9M	DC +	Spray	Rutile	Multiple	Essentially the same as T-1 / T-1M types, but deposit weld metal with improved impact properties (eg. 27J @ -29°C / 20ft Lb @ -20°F). To obtain X-Ray quality, joints are to be relatively clean and free of oil, excessive oxide & mil-scale.
T-10*	DC -	small droplet Globular	---	Single	High speed gasless welding in flat & H/V and 20° vertical inclined positions on larger thickness than the T-3 class.
T-11*	DC -	Spray	---	Multiple	General purpose wire for use on material less than 20mm (3/4) unless preheat & interpass temp's are maintained.
T-12 and T-12M	DC +	Spray	Rutile	Multiple	Essentially the same as T-1 / T-1M types, but modified to increase impact properties and to meet lower manganese requirements of the ASME Boiler and Pressure Vessel code section IX, A-1 analysis group of 1.6% Mn.
T-13*	DC -	Short arc	---	Single	Root pass welding only on circumferential pipe welds.
T-14*	DC -	Spray	---	Single	# High speed all positional welding of sheet metal such as, galvanised, zinc and other coated steels ≤ 6mm (1/4).
T-G	DC + / -	not specified	N.S.	Multiple	For electrodes not covered by any present classification. The wire must meet the chemical requirements to ensure a carbon steel deposit and the specified tensile strength.
T-GS	DC + / -	not specified	N.S.	Single	For single pass electrodes not covered by any present classification. The wire must meet the specified tensile strength requirements. No other requirements are specified.

\* Self shielded wire types. # Suitable only for material thickness below 6mm (1/4")

CONSUMABLES CLASSIFICATION TABLES

AWS ASME SFA A5.17 Standard for Submerged Arc Wires & Fluxes

7 Represents the minimum tensile strength of the Weld Metal in Psi x 10,000  
 6 = 60,000 Psi  
 7 = 70,000 Psi

Indicates the condition of heat treatment in which tests were conducted.  
**A** = As Welded Condition  
**P** = Post Weld Heat Treated  
 Refer to AWS A5.17 Table 8.4 for PWHT requirements.

Indicates the lowest temperature, at which the Impact Strength of the Weld Metal exceeds 27 joules of energy. Refer to AWS A5.17 Table 6 for specific requirements.  
**4** = -40° C

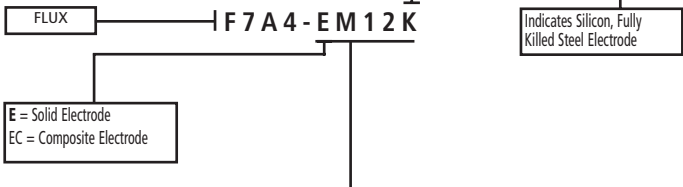

**Table 1**  
 Chemical Composition Requirements for Solid Electrodes

Electrode Classification	C	Mn	Si	S	P	Cu
<b>Low Manganese Electrodes</b>						
EL8	0.10	0.25-0.60	0.07	0.03	0.03	0.35
EL8K	0.10	0.25-0.60	0.1-0.25	0.03	0.03	0.35
EL12	0.04-0.14	0.26-0.60	0.10	0.03	0.03	0.35
<b>Medium Manganese Electrodes</b>						
EM12	0.06-0.15	0.8-1.25	0.1	0.03	0.03	0.35
<b>EM12K</b>	<b>0.05-0.15</b>	<b>0.8-1.25</b>	<b>0.1-0.35</b>	<b>0.03</b>	<b>0.03</b>	<b>0.35</b>
EM13K	0.06-0.16	0.9-1.4	0.35-0.75	0.03	0.03	0.35
EM14K	0.06-0.19	0.9-1.4	0.35-0.75	0.025	0.025	0.35
(Ti 0.03-0.17%)						
<b>High Manganese Electrodes</b>						
EH11K	0.07-0.15	1.4-1.85	0.8-1.15	0.03	0.03	0.35
EH12K	0.06-0.15	1.5-2.00	0.25-0.65	0.025	0.025	0.35
EH14	0.10-0.20	1.70-2.20	0.1	0.03	0.03	0.35

**Table 6**  
 Impact Test Requirements

Digit	Test Temp C	Minimum Average Energy Level (Joules)
Z	No Impact Requirements	
0	-18	27
2	-29	27
<b>4</b>	-40	27
5	-46	27
6	-51	27
8	-62	27

## CONSUMABLES CLASSIFICATION TABLES

AS/NZS 2576. 1996 - Classifies Welding Consumables as used for Build-up and wear resistance. The following layout outlines this classification, however for the complete classification CIGWELD recommends that users refer to the current version of the standard. The publication is available from the Standards Association of Australia or Standards New Zealand.

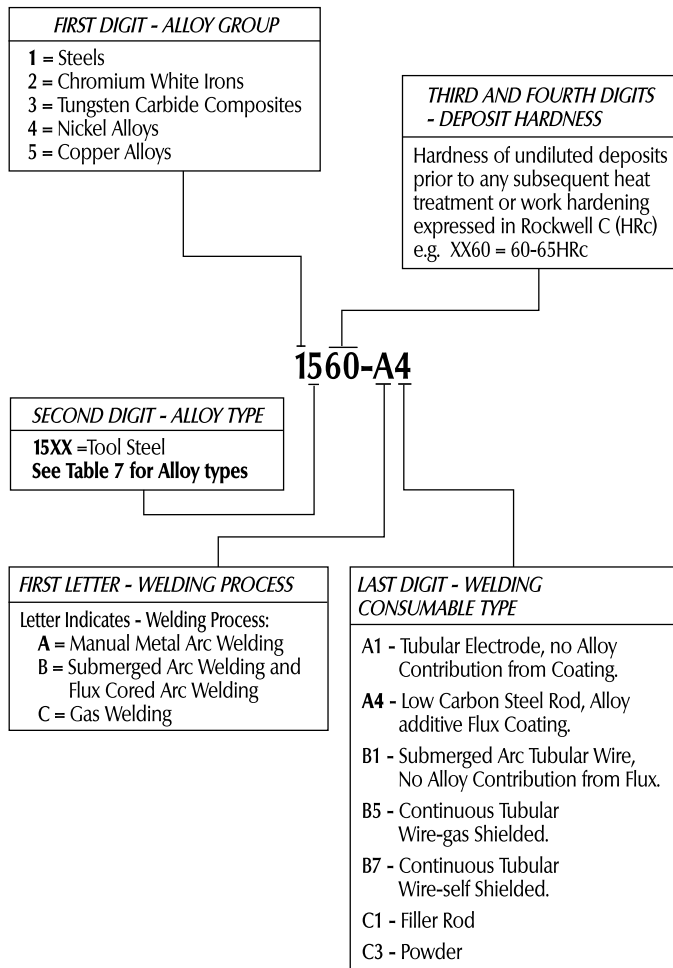

## CONSUMABLES CLASSIFICATION TABLES (TABLE 7)

Group 1 - Steels	Alloy Type	AS/NZS class.
Stoody 104	Pearlitic Steel	1125-B1
Stoody Build Up-O		1125-B7
Cobalarc Mangcraft	Austenitic Manganese Steel	1215 A4
Stoody Dynamang		1215 B7
Cobalarc Austex	Austenitic Stainless Steel	1315-A4
Verti-Cor 309LT		1315-B5
Stoody S05 309L		1315-B7
Cobalarc 350	Low Carbon Martensitic Steel	1435-A4
Stoody Super Build Up G/O		1435-B5 / B7
Stoody 107		1440-B1
Stoody 105		1445-B1
Cobalarc Toolcraft	Tool Steel	1560-A4
Stoody 110 MC		1715-B7
Cobalarc 650	High Carbon Martensitic Steel	1855-A4
Cobalarc 750		1860-A4
Stoody 965 G/O		1855-B5 / B7
Stoody 850-O		1865-B7
Stoody 600	High Carbon Martensitic Steel with Titanium Carbides	1955-B7

Group 2 - Cr White Irons	Alloy Type	AS/NZS Class.
Cobalarc CR70	Austenitic Chromium Carbide Iron	2355-A4
Stoody 101 HC G/O		2360-B5 / B7
Stoody 100 HC		2360-B7
Cobalarc 1e		2360-A4
Cobalarc 9e	Complex Chromium Carbide Iron	2460-A4
Stoody 143-O		2460-B7
Cobalarc Borochrome	Martensitic Chromium Carbide Iron	2560-A4
Stoody Fineclad-O		2565-B7

Group 3 - Tungsten Carbide Comp.	Alloy Type	
Stoody Tube Borium AC/DC	Tungsten Carbide granules in an iron rich matrix	3460-A1

Group 4 - Copper Alloys	Alloy Type	
Bronzecraft AC-DC	Phosphor Bronze	6200-A2
Comweld Manganese Bronze	High Tensile Brass	6300-C1
Comcoat C		6300-C1
Comweld Nickel Bronze	Nickel Bronze (9-13%Ni)	6400-C1
Comcoat N		6400-C1

## BOC SHIELDING GAS INFORMATION

### Shielding Gases and Their Properties

Shielding gases are those gases used in arc welding and cutting processes to generate the arc and shield the molten metal from contamination. These functions are affected by such factors as:

- ▲ material to be welded
- ▲ weld position
- ▲ process chosen
- ▲ weld economics
- ▲ material thickness
- ▲ type of wire
- ▲ metal transfer mode
- ▲ finish required.

The main gases used in the formulation of a shielding gas are:

- ▲ Argon
- ▲ Carbon Dioxide
- ▲ Oxygen
- ▲ Helium
- ▲ Hydrogen.

These gases form the basis of the mixtures used in the BOC Argoshield®, Stainshield®, Alushield®, Argoplas®, and Specshield® range designed to best meet the needs of the welding industry. While carbon dioxide and argon can be used in their pure form as shielding gases in most applications, a specific mixture of gases will offer improvements in welding productivity and help to reduce the total weld cost.

### Argon

Argon is a chemically inert gas, heavier than air, with an ionisation potential of 15.7 eV giving easy arc starts and a stable welding arc. Argon produces a constricted arc column and has a low thermal conductivity which facilitates easy arc initiation.

The result is a relatively narrow weld bead with deep central penetration of the weld deposit into the base metal giving the 'finger' or 'wine glass' penetration profile. In GMA welding (spray or pulse transfer mode), the main force in the arc is axial to the filler wire and accelerates the molten droplet smoothly across the arc. This allows for virtually spatter-free welding in spray transfer mode.

Argon is used as a GMA welding shielding gas for many non-ferrous metals. It does not, however, provide suitable metal transfer characteristics for steel. There is a marked tendency for the filler metal not to flow out to the toes of the weld causing a very uneven weld shape. This poor weld bead shape is due to low arc energy, low heat input and rapid cooling rate and the high surface tension of liquid iron in argon atmospheres.

Argon is one of the gases available in the BOC product range and is a standard GTA welding shielding gas. Argon forms 0.9% of air by volume and is produced in the air separation process in addition to oxygen and nitrogen.



GMAW Argon arc column



Penetration profile of Argon shielded GMA weld on Carbon steel

The information on this page is reprinted with the permission of BOC Ltd.

The stripe symbol and the words Argoshield, Stainshield, Alushield, Argoplas and Specshield are BOC Group trademarks.



## BOC SHIELDING GAS INFORMATION

### Carbon Dioxide

Carbon dioxide, or  $\text{CO}_2$ , as it is commonly known, is not chemically inert. When energised and subjected to arc temperatures above  $6000^\circ\text{C}$ , its molecules dissociate at the top of the arc to form excited species of oxygen and carbon monoxide:

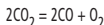

These molecules recombine at the bottom of the arc and in so doing, release a disruptive force upward into the arc causing a stuttering, unstable arc and welding spatter. The oxygen superheats the transferring molten filler metal creating a deep penetrating, fluid weld pool and promoting the deposition of convex weld beads.



Carbon Dioxide arc column

Because the  $\text{CO}_2$  shielded arc is highly oxidising, it is useful for coping with surface contaminants such as rust, paint and primers. Carbon dioxide can be used for mild and carbon manganese steel welding, where it gives a narrow, peaked weld bead with deep penetration. The normal spray transfer of fine metal droplets does not occur in the  $\text{CO}_2$  arc. Globular and dip transfer arc modes only are used with  $\text{CO}_2$ .

Because it is oxidising and not inert,  $\text{CO}_2$  cannot be used to weld readily oxidisable metals such as aluminium, copper, magnesium or nickel, or for GTA welding. It is not suitable for stainless steels because of carbon pick-up which can give a 200-300% increase in carbon content in the weld metal.



Penetration profile of Carbon Dioxide on Carbon steel

In addition, because of the oxidising characteristics of  $\text{CO}_2$  in GMA welding of steel, it is recommended that filler wires with a high manganese and silicon level or triple de-oxidised wires are used.

### Oxygen

Although oxygen itself is not used as a shielding gas, it is a vital component in shielding gas mixtures. When used as a low percentage (i.e. 1-7%) additive to argon or argon/  $\text{CO}_2$  mixtures, oxygen can be very beneficial in improving arc characteristics and reducing the surface tension of the weld metal. It is an active gas which dissociates in the arc intensifying the arc plasma, thereby increasing the heat input and travel speed, and improving weld penetration and edge wetting. It promotes the spray transfer mode in GMA welding of steels to give a virtually spatter-free, high productivity process.

### Helium

Helium is also inert but has a higher ionisation potential than argon, of 24.5 eV. As a result, helium arcs have a higher arc voltage than argon for a given arc length, translating into higher heat input and weld travel speeds.

The high thermal conductivity of helium produces a wide, low weld bead with good fusion and penetration. High flow rates are necessary to maintain a helium shield because the gas is lighter than air.



GMAW Helium arc column

The information on this page is reprinted with the permission of BOC Ltd.

The stripe symbol and the words Argoshield, Stainshield, Alushield, Argoplas and Specsshield are BOC Group trademarks.



## BOC SHIELDING GAS INFORMATION

### Helium cont.

It is typical for both GMA and GTA welding to combine Helium with Argon and possibly other gases to further enhance its operating characteristics. The constituents are also influenced by the material to be welded. BOC's Alushield® range of mixtures have been specifically developed for high oxidising materials such as aluminium. BOC's Stainshield® Heavy and BOC's Stainshield® 69 have been developed for use on stainless steel and nickel alloys, which can tolerate small quantities of oxidising gases such as oxygen and carbon dioxide.



Penetration profile of Helium shielded GMA weld on Carbon steel

Helium is a rare gas found in association with certain natural gas streams in low concentrations. It is costly to produce, store and transport as a liquid, because its boiling point is very low - 269°C.

### Hydrogen

Hydrogen has a relatively low ionisation potential (13.5 eV), but a high thermal conductivity. This produces a higher arc energy for deeper penetration and weld pool fluidity. Because hydrogen is a reducing agent, its action helps to remove oxide films on the weld pool surface resulting in a cleaner weld bead.

### Argon Based Mixtures

The characteristics of each gas used in a shielding gas mixture affect the way the gas will perform, including the shielding efficiency, arc stability and the shape and strength of the weld. Depending on the application, the right balance of gases in a mixture will produce a shielding gas with the optimum properties for the application and greater tolerance to voltage and current settings.

Argon is an excellent base for GMA welding shielding gas mixtures because it permits the use of spray transfer with all the commonly welded metals. However, when depositing flat or horizontal welds on steel or stainless steel, the quick freeze characteristics of an argon weld does not permit the molten metal to wet out the toes of the weld, causing undercutting at the edges of the weld bead. It is therefore necessary to add active gases to argon, such as oxygen or carbon dioxide, to increase the heat input for GMA welding of steels and stabilise the droplet size.

#### Argon + Oxygen Mixtures

Oxygen is added to argon to stabilise the arc, improve the weld bead profile and edge wetting and minimise the tendency to undercut ferrous welds. Discrete percentages of oxygen (i.e. 1-7%) prevent excessive losses of manganese and silicon, as well as increase the temperature of the molten metal transferred across the arc. The molten weld pool has a lower surface tension than with argon, wetting the parent metal to flatten the weld bead profile.

For stainless steels and other corrosion resistant steels (e.g. 3CR12) a mixture of 1-2% oxygen, as found in BOC's Stainshield®, is recommended.

Above 5% oxygen, the surface of the weld bead becomes increasingly oxidised with consequent losses of manganese, silicon and chromium. Argon/oxygen welds have a flatter bead than argon or CO<sub>2</sub> and give a wine glass penetration pattern. BOC's Argoshield® 40 is such an argon/oxygen mixture offering virtually spatter-free beads on sheet steel in spray mode.



Penetration profile of Argon + Oxygen shielded GMA weld on Carbon steel

The information on this page is reprinted with the permission of BOC Ltd.  
The stripe symbol and the words Argoshield, Stainshield, Alushield, Argoplas and Speshield are BOC Group trademarks.



## BOC SHIELDING GAS INFORMATION

### Argon Based Mixtures

#### Argon + Carbon Dioxide Mixtures

For mild and carbon manganese steels, argon/carbon dioxide mixtures can be used with the CO<sub>2</sub> conventionally ranging from 2-30% by volume. Ideally 25% CO<sub>2</sub> should not be exceeded for best results. With increasing CO<sub>2</sub> content to provide more heat and broader and deeper penetration, the spray transfer mode deteriorates. Argoshield® 52 is a high CO<sub>2</sub> mixture offering excellent penetration. Argon/CO<sub>2</sub> mixtures are successfully used with flux-cored and metal-cored wires.



Penetration profile of Argon + Carbon Dioxide shielded GMA weld on Carbon steel

An argon/CO<sub>2</sub> weld shows deeper and fuller penetration than argon/carbon dioxide shielded and an argon/oxygen weld.

#### Argon + Oxygen + Carbon Dioxide mixtures

The further addition of Oxygen to an argon/CO<sub>2</sub> mixture flattens the weld bead and improves spray transfer characteristics, total heat input, weld bead profile and penetration.

Argon/oxygen/carbon dioxide mixtures allow the fullest flexibility in producing shielding gases best suited to different steel applications. The oxygen and CO<sub>2</sub> mixtures, such as BOC's Argoshield® Light, are well suited to dip transfer welding of lighter section metal. In the spray transfer mode, they give an excellent arc with greater welder appeal and minimum spatter that is suitable for welding light and medium section steels.

Low oxygen/high CO<sub>2</sub> mixtures, such as BOC's Argoshield® Universal, are best suited to dip and spray transfer welding and display excellent weld bead profiles and penetration. They perform particularly well in all position welding typically in the 4-12mm thickness range. High CO<sub>2</sub> mixtures give spatter levels which are much lower than with carbon dioxide, but with comparable penetration and fusion performance. The addition of the oxygen reduces the droplet diameter and improves the stability of the transfer.



Penetration profile of Argon + Oxygen + Carbon Dioxide

#### Argon + Helium Mixtures

Argon/helium mixtures are usually used to obtain the most favourable characteristics of both gases in terms of heat input, weld speed, weld bead profile and penetration. The mixtures are normally used for heavier sections of non-ferrous metals such as aluminium, copper, magnesium and nickel. The heavier the metal thickness and the more heat conductive the metal, the greater the percentage of helium required in the mixture. Typical mixtures contain between 25% and 75% helium. BOC's Alushield® Light and Alushield® Heavy are argon/helium mixtures.



Penetration profile of Argon + Helium shielded weld on Carbon steel

#### Argon + Helium + Hydrogen

A mixture of argon/helium/hydrogen, as found in BOC's Specshield® 90T and Specshield® 71T, produces a very hot arc making this mixture ideal for GTA welding of stainless and nickel steels. The relatively small amount of hydrogen does not cause damage to the tungsten electrode but is desirable to increase the speed of welding while offering cleaner weld beads by the reducing action of the hydrogen on the weld pool surface oxides. Hydrogen is also known to improve the weld tolerance of variations in austenitic stainless steel castings.

The information on this page is reprinted with the permission of BOC Ltd.

The stripe symbol and the words Argoshield, Stainshield, Alushield, Argoplas and Specshield are BOC Group trademarks.





## SHIELDING GAS INFORMATION

### Shielding Gases for Welding (AS4882-2003)

The objective of the Standard is to specify a classification system for shielding gases for welding.

#### DESIGNATION SYSTEM

Gases are identified as follows:

Designator	Gas
A	Argon
C	Carbon Dioxide
He	Helium
H	Hydrogen
N	Nitrogen
O	Oxygen

The designation system shall be based on volumetric percentages.

The shielding gas shall be composed of the following designator and number arrangement:

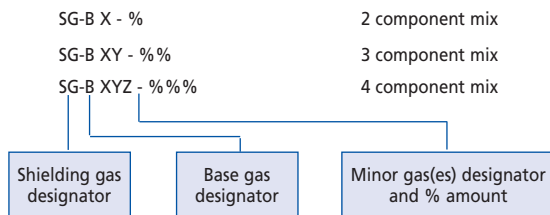

- SG** identifies the product as a shielding gas
- SG-B** indicates the singular or major gas in the shielding gas or mixture
- SG-B XYZ** indicates the minor individual gas indicators in decreasing order of %
- SG-B XYZ-%%%** a slash shall be used to separate the individual minor components percentages for two or more component mixtures

Group	Symbol*	Identification	Components % VV					Typical Applications		Remarks			
			CO <sub>2</sub>	Oxidising	O <sub>2</sub>	Ar	Inert	He	Reducing H <sub>2</sub>		Unreactive N <sub>2</sub>		
R		1				Balance <sup>#</sup>	Balance <sup>#</sup>	100	100	> 0 to 15 > 15 to 35	TIG, plasma arc welding plasma arc cutting, back shielding	Reducing	
		2				Balance <sup>#</sup>							
I		1				100						MIG, TIG, plasma arc welding, back shielding	Inert
		2											
		3					Balance						
M1		1	> 0 to 5			Balance <sup>#</sup>							Slightly oxidising
		2	> 0 to 5			Balance <sup>#</sup>							
		3		> 0 to 3		Balance <sup>#</sup>							
		4		> 0 to 5		Balance <sup>#</sup>							
M2		1	> 5 to 25			Balance <sup>#</sup>							
		2		> 3 to 10		Balance <sup>#</sup>							
		3		> 3 to 10		Balance <sup>#</sup>							
		4		> 5 to 25		Balance <sup>#</sup>							
M3		1	> 25 to 50			Balance <sup>#</sup>					MAG	More pronounced oxidation	
		2		> 10 to 15		Balance <sup>#</sup>							
		3		> 5 to 50		Balance <sup>#</sup>							
C		1	100										
		2											
F		1	Balance								100	Plasma arc cutting, back shielding	Unreactive
		2									Balance		Reducing

\*Where components not listed are added to one of the groups in this table the gas mixture is designated as a special gas mixture and carries the prefix S.  
 #Argon may be replaced by up to 95% helium. The helium content is designated by an additional identification number. Refer to Clause 4 of the ISO Standard for further details on both the these notes.

### IDENTIFICATION NUMBERS FOR GASES IN GROUPS R AND M CONTAINING HELIUM

Identification	Helium content % VV
(1)	> 0 to 33
(2)	> 33 to 66
(3)	> 66 to 95

## SHIELDING GAS INFORMATION

### BOC AUSTRALIA - SHIELDING GASES CLASSIFICATION TABLE

AS 4882-2003: Shielding gases for welding

ISO 14175-1997: Welding Consumables - Shielding gases for arc welding and cutting

Product Code	Product Name	Principle Benefits	AS4882 2003	ISO 14175 1997
<b>GMAW Low and Alloy Steels</b>				
060	Argoshield® Light	Low distortion; minimal spatter	SG-ACO-5/3.1	M23
065	Argoshield® Universal	Fast, clean appearance	SG-ACO-16/2.75	M24
064	Argoshield® Heavy	Good appearance Low defect levels on thick material	SG-ACO-18/2	M24
068	Argoshield® 40	Low profile bead shape Fluid weld pool, excellent fusion	SG-AO-5	M22
070	Argoshield® 52	Ideal for flux cored welding Good penetration	SG-AC-25	M21
071	Argoshield® 54	Excellent finish with minimal clean-up	SG-ACO-7/1.5	M24
095	Argoshield® 100	High weld appeal; Wide operating range	SG-AHeC-25/10	M21(1)
081	Industrial Carbon Dioxide	Good penetration; Ideal for flux cored	SG-C	C1
<b>FCAW Low and Alloy Steels</b>				
070	Argoshield 52	Good weld appearance Deep penetration, fast welding speed	SG-AC-25	M21
081	Industrial Carbon Dioxide	Some wires designed for use under CO <sub>2</sub> only	SG-C	C1
<b>GMAW Stainless Steels</b>				
075	Stainshield®	Clean, fast	SG-AO-1.5	M13
092	Stainshield® Heavy	Low defect levels on thick material Excellent arc stability, fast speed	SG-AHeC-35/2.8	M12(2)
093	Stainshield® 66	Minimal spatter levels and surface oxidation with optimal contour	SG-ACH-2.8/1	M11
094	Stainshield® 69	Ideally suited to applications where maximum corrosion resistance is important	SG-AHeO-35/0.9	M13(2)
<b>GMAW Aluminium and Alloys</b>				
079	Alushield® Light	Minimal spatter, good appearance, fast weld speed	SGAHe-27	I3(1)
069	Alushield® Heavy	Fast, good penetration on thicker material, wide bead shape	SG-HeA-25	I3(3)
061	Welding Argon	Versatile	SG-A	I1
<b>GMAW Copper and Alloys</b>				
077	Specshield® Copper	Versatile, fast	SG-AO-0.7	M13
<b>PAC/PAW Stainless Steels</b>				
143	Argoplas® 5	Ideally suited to plasma welding and plasma cutting of stainless steels	SG-AH-5	R1
144	Argoplas® 20	Ideally suited to plasma cutting of stainless steels	SG-AH-20	R2
145	Argoplas® 35	Ideally suited to plasma cutting of stainless steels and aluminium	SG-AH-35	R2

The information on this page is reprinted with the permission of BOC Ltd.

The stripe symbol and the words Argoshield, Stainshield, Alushield, Argoplas and Specshield are BOC Group trademarks.



## SHIELDING GAS INFORMATION

## Mild and Medium Tensile Steels - Gas Metal Arc and Flux Cored Arc Welding

Argoshield 40	Autocraft LW1	Autocraft LW1-6	Clean, smooth finish	Metal-Cor XP*	
Argoshield Light	Autocraft LW1	Autocraft LW1-6	Clean, dip & spray transfer	Metal-Cor XP* Metal-Cor 5*	
Argoshield Universal	Autocraft LW1	Autocraft LW1-6	Higher penetration	Metal-Cor XP Metal-Cor 5	Optimum shielding for penetration and travel speeds
				Satin-Cor XP (1.6mm) Verti-Cor XP Verti-Cor 3XP Verti-Cor 3XP H4 Supre-Cor 5 Supre-Cor XP Tensi-Cor 110TXP H4	Smooth even transfer spatter and fine levels. Adequate penetration.
Argoshield 52	Autocraft LW1	Autocraft LW1-6	Higher CO <sub>2</sub> level, excellent dip and spray	Satin-Cor XP (1.6mm) Verti-Cor XP Verti-Cor 3XP Verti-Cor 3XP H4 Supre-Cor 5 Supre-Cor XP Tensi-Cor 110TXP H4	Optimum shielding giving excellent edge fusion and penetration, low spatter and fume levels.
				Metal-Cor XP Metal-Cor 5	Higher CO <sub>2</sub> content with slightly increased spatter levels.
Argoshield 54	Autocraft LW1	Autocraft LW1-6	High quality, triple mixture	Metal-Cor XP* Verti-Cor XP*	
Argoshield 100	Autocraft LW1	Autocraft LW1-6	Helium addition for higher travel speeds	Supre-Cor 5	Improved arc transfer, better fillet shapes & lower spatter levels
Welding CO <sub>2</sub>	Autocraft LW1	Autocraft LW1-6	High penetration, low cost	Satin-Cor XP Verti-Cor XP Verti-Cor ULTRA Supre-Cor 5 Supre-Cor XP Tensi-Cor 110TXP H4	Optimum shielding for economy and weld metal quality. Low cost shielding giving deep penetration characteristics.

\* These shielding gases are not normally recommended due to higher Mn and Si recovery in the weld metal. For single pass fillet welds the results may be acceptable.

**SHIELDING GAS INFORMATION**
**Alloy Steels - Gas Metal Arc and Flux Cored Arc Welding**

Shielding Gas	Filler Metals GMAW	Comments	Filler Metals FCAW	Comments
Argoshield 52	Autocraft Super Steel Autocraft Mn-Mo Autocraft CrMo1 Autocraft NiCrMo	Excellent penetration and usability for dip and spray transfer. Most suitable for dip transfer.	Supre-Cor 5 Supre-Cor XP H4	For alloy steels where full joint efficiency is not required
			Verti-Cor 81Ni 1 Verti-Cor 81Ni 1 H4 Verti-Cor 91 K2 Verti-Cor 91 K2 H4 Verti-Cor 111 K3 Tensi-Cor 110 TXP H4	For alloy steels where higher joint strength is required
Stainshield	Autocraft Super Steel Autocraft Mn-Mo Autocraft CrMo1 Autocraft NiCrMo	Optimum choice for smooth transfer in spray mode, higher alloy recovery	N.R.	
Argoshield 100	Autocraft Super Steel Autocraft Mn-Mo Autocraft CrMo1 Autocraft NiCrMo	Helium addition for high travel speeds	Supre-Cor 5 Supre-Cor XP H4	Improved arc transfer, better fillet shapes & lower spatter levels. For alloy steels where full joint efficiency is not required

**Stainless Steels - Gas Metal Arc and Gas Tungsten Arc Welding**

Shielding Gas	Filler Metals GMAW	Comments	Filler Wires GTAW	Comments
Stainshield	Autocraft 307Si Autocraft 308LSi Autocraft 309LSi Autocraft 316LSi Autocraft 2209	Smooth, even transfer, excellent fillet shape, ideal for spray transfer	N.R.	
Stainshield Heavy	Autocraft 307Si Autocraft 308LSi Autocraft 309LSi Autocraft 316LSi Autocraft 2209	Excellent dip transfer, can also be used for spray For welding heavier section (>9mm) stainless steels.	N.R.	
Welding Argon	N.R.		Comweld 308L Comweld 309L Comweld 316L Comweld 2209	Low cost shielding for all general purpose applications. Also used as purge gas on pipe welding.

## SHIELDING GAS INFORMATION

## Aluminium Alloys - Gas Metal Arc and Gas Tungsten Arc Welding

Shielding Gas	Filler Metals GMAW	Comments	Filler Wires GTAW	Comments
Welding Argon	Autocraft AL1188 Autocraft AL4043 Autocraft AL5356	Excellent shielding for general purpose applications	Comweld AL1188 Comweld AL4043 Comweld AL4047 Comweld AL5356	Excellent shielding for manual applications
Alushield Light	Autocraft AL1188 Autocraft AL4043 Autocraft AL5356	Hotter arc to give broader & deeper penetration.	Comweld AL1188 Comweld AL4043 Comweld AL4047 Comweld AL5356	Hotter arc where more penetration is required.
Alushield Heavy	Autocraft AL1188 Autocraft AL4043 Autocraft AL5356	Hottest arc, high speed broadest, deepest penetration for heavy sections.	Comweld AL1188 Comweld AL4043 Comweld AL4047 Comweld AL5356	Hottest arc for heavier sections (>6mm) and mechanised applications.

## Copper Alloys - Gas Metal Arc and Gas Tungsten Arc Welding

Shielding Gas	Filler Metals GMAW	Comments	Filler Wires GTAW	Comments
Welding Argon	Autocraft Deox. Copper Autocraft Silicon Bronze	For general purpose applications	Comweld Si. Bronze	For general purpose applications
Specshield Copper	Autocraft Deox. Copper Autocraft Silicon Bronze	For improved characteristics	N.R.	
Alushield Copper Alushield Heavy	Autocraft Deox. Copper Autocraft Silicon Bronze	Hotter arc, reduces preheat temp. requirements. Higher travel speeds.	Comweld Si. Bronze	Hotter arc for mechanised applications. Higher travel speeds.

## WELDING OF STEEL

The following information is for guidance in determining the weldability of various grades of steel which have been listed under the appropriate steel standard specification or proprietary trade names. For a comprehensive treatment of the "weldability of steels" please refer to the Welding Technology Institute of Australia (WTIA) Technical Note 1.

Factors influencing weldability:

### 1) The effect of Carbon on Steel:

Carbon is a major alloying element in the various grades of steel; increasing the carbon content of a particular steel results in a corresponding increase in hardenability when the material is subject to thermal treatment.

From a welding point of view, the best practice is to adopt a welding procedure which minimises the risk of high hardness in the Heat Affected Zone (HAZ) of the base metal and the weld deposit.

#### Determination of carbon equivalent and group number of the steel:

In determining the weldability of a particular grade of steel, consideration must be given to the combined effect of alloying elements, in particular carbon and manganese. The following formula for Carbon equivalent (CE) takes account of the important alloying elements in calculating a number which grades the steel in terms of its relative weldability. Refer to the Carbon Equivalent (CE) table and respective weldability reference numbers detailed in Table 1.

$$CE = C + \frac{Mn}{6} + \frac{Cr + Mo + V}{5} + \frac{Ni + Cu}{15}$$

### 2) Determination of Combined Joint Thickness:

The concept of combined joint thickness (CJT) is required to address the expected cooling rate of adjoining sections - calculations for determining combined thickness are based on the following formula. Please refer to Diagram 1 for CJT's for a range of joint configurations.

$$T_{CJT} = t_1 + t_2 + t_3 + t_4$$

### 3) Welding Energy or Heat Input:

Welding energy or heat input calculations are dependent upon the practical welding variables used, in particular welding current, arc voltage and welding speed for the specific arc welding processes adopted including manual metal arc, semi-automatic and automatic welding.

Welding energy input is based on the following formula:

$$Q = \frac{I \times E \times 60}{V \times 1000}$$

where

- Q = Welding energy or heat input ( Kilojoules per millimetre, KJ/mm)
- E = Arc voltage (volts)
- I = Welding current (Amperes)
- V = Welding speed or travel rate (mm/min)

## WELDING OF STEEL

### 4) Hydrogen Controlled Consumables and Welding Process Selection:

When determining the weldability of steel, careful consideration must be given to welding consumable selection.

For the purpose of preheat determination, the welding consumable/process combination used can be broadly grouped into two major types. Those which are hydrogen controlled and those which are not hydrogen controlled:

#### ▲ Non-hydrogen controlled welding consumables:

This group includes cellulose, mild steel and iron powder type electrodes to Australian Standard AS/NZS 1553.1 classifications EXX10, EXX11, EXX12, EXX13, EXX14 and EXX24. For these non-hydrogen controlled electrodes care should be taken to avoid moisture pick-up from exposure to adverse atmospheric conditions (ie excessive heat, humidity etc)

#### ▲ Hydrogen controlled welding consumables:

Hydrogen controlled types are defined as those consumable/process combinations which produce less than 15 mls of diffusible hydrogen per 100 gms of deposited weld metal. These include hydrogen controlled manual arc electrodes of the EXX16, EXX18, EXX28 and EXX48 types to AS/NZS 1553 Parts 1 and 2. Many gas shielded metal-cored and flux-cored welding wires to AS 2203.1 and all steel gas metal-arc welding wires to AS/NZS 2717.1 satisfy the hydrogen controlled requirement provided they are used with the correct shielding gas.

For all hydrogen controlled welding consumables, precautions must be taken in storage and handling to ensure the hydrogen status is not compromised.

For further information on the correct storage and handling of CIGWELD welding consumables, please refer to this handbook or WTIA publication Tech Note 3 "Care and Conditioning of Welding Consumables".

### General Procedure in Determining Weldability and Preheat Requirements.

1. Select the corresponding weldability reference number for the particular grade of steel.

Where a particular grade of steel is not listed, calculate the CE from the formulae given in section 1. Using Table 1 cross reference the CE calculation to determine the appropriate weldability reference number.

2. Using Diagram 1 as a guide, determine the combined joint thickness (CJT) for the specific joint being welded.
3. Using Figure 1, determine the joint weldability index from the intersection point of the two numbers from 1 & 2 above (ie the weldability reference number and the CJT number).
4. Cross reference the joint weldability index, with the expected welding energy input (in KJ/mm) on Figure 2\* or 3\* to calculate the appropriate preheat temperature.

\*Note: if a **hydrogen controlled welding consumable** is to be used, refer to Figure 2; if a **non-hydrogen controlled welding consumable** is to be used, refer to Figure 3.



## WELDING OF STEEL

### The Need for Preheating of the Steel Joint:

The beneficial effects of preheating in improving the weldability of the steel joint are:

1. Preheating retards the cooling rate in the joint and is beneficial in preventing undesirable metallurgical microstructures from occurring in the heat affected zone (HAZ) of the base metal and in the weld metal of high alloy steel deposits.
2. Preheating is used to offset the thermal conductivity of the steel sections and is beneficial in reducing the level of residual stress in the joint after welding.
3. Preheat temperatures should be determined in accordance with the requirements of Figure 2 or 3 with the preheat temperature being maintained between subsequent weld passes.
4. Preheating assists in the removal of diffusible hydrogen from the weld zone ie. the weld bead and HAZ.

#### Tack Welding Procedure:

Best practice requires that the specified preheat is used prior to any tack welding operation regardless of the fact that tack welds will become part of the weldment.

### Weldability Reference Numbers:

The Weldability Reference Numbers used in this guide relate to the carbon equivalent (CE) ranges shown in Table 1 below:

Carbon Equivalent (CE)	Weldability Reference Number	Carbon Equivalent (CE)	Weldability Reference Number
below 0.30	1	0.55 to below 0.60	7
≤ 0.30 to below 0.35	2	0.60 to below 0.65	8
0.35 to below 0.40	3	0.65 to below 0.70	9
0.40 to below 0.45	4	0.70 to below 0.75	10
0.45 to below 0.50	5	0.75 to below 0.80	11
0.50 to below 0.55	6	0.80 and above	12

**Table 1**

Note: Weldability Reference Numbers above 12 (ie. 12A, 12B, 12C & 13) are not related to CE.

WELDING OF STEEL

Preheat Determination:

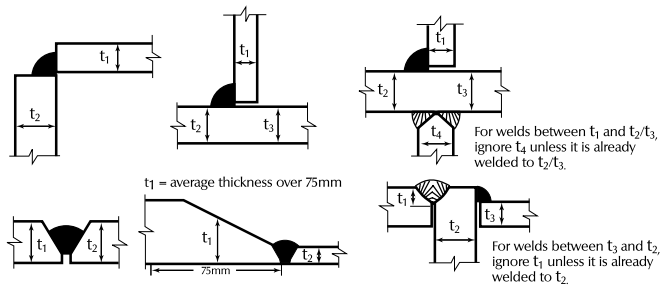

Diagram 1 - Combined Joint Thickness (CJT) calculations for welds shown in black.

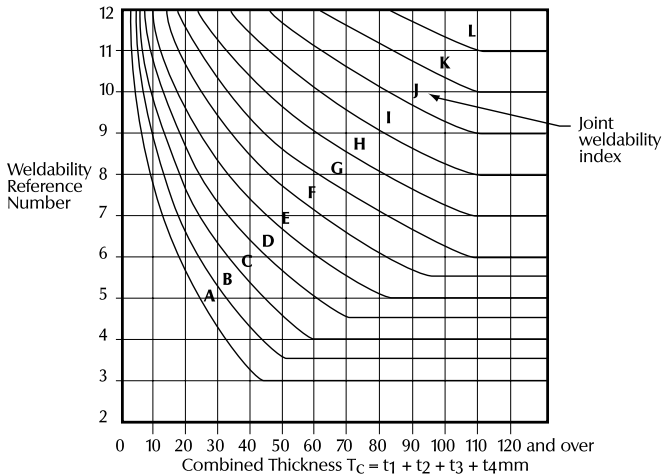

Figure 1 - Determination of joint weldability index using combined joint thickness and weldability reference number.

WELDING OF STEEL

Preheat Determination:

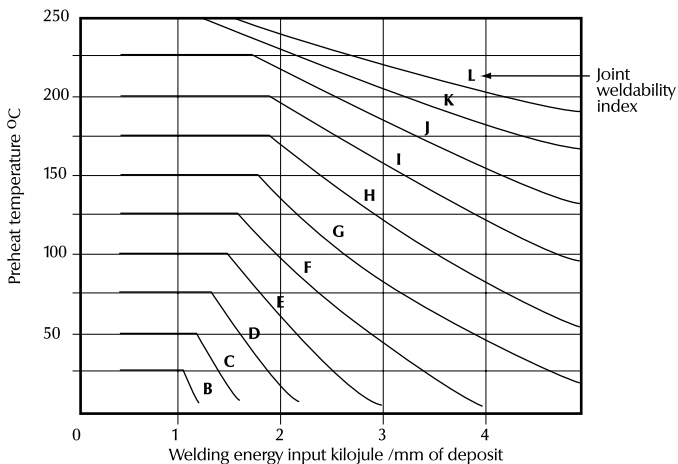

Figure 2 - Determination of preheat requirements for hydrogen controlled electrodes (EXX16, EXX18, EXX28 & EXX48) semi-automatic and automatic welding process.

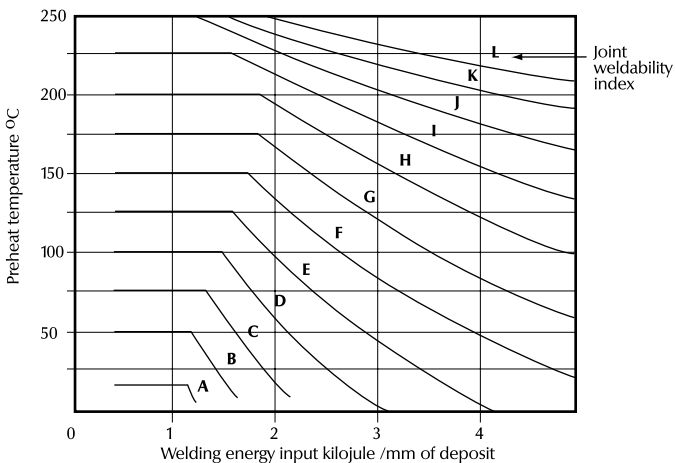

Figure 3 - Determination of preheat requirements for Manual metal-Arc Welding with other than hydrogen controlled consumables.

The information on this page is reprinted with the kind permission of The Welding Technology Institute of Australia (WTIA).

## WELDING OF STEEL

### Steel Specifications:

AS 1442 (1992) Hot Rolled Bar and Semi Finished Product.  
 AS 1443 (1993) Cold Finished Bars Carbon Steel.

Steel Designation	Chemical Analysis %			Weldability Reference Number
	C	Mn	Si	
1006	0.08	0.25/0.50	0.10/0.35	1
1010	0.08/0.13	0.30/0.60	0.10/0.35	1
1020	0.18/0.23	0.30/0.60	0.10/0.35	2
1030	0.28/0.34	0.60/0.90	0.10/0.35	5
1040	0.37/0.44	0.60/0.90	0.10/0.35	8
1050	0.48/0.55	0.60/0.90	0.10/0.35	10
1060	0.55/0.65	0.60/0.90	0.10/0.35	11
1070	0.65/0.75	0.60/0.90	0.10/0.35	12

### Free Machine Steels.

Steel Designation	Chemical Analysis %				Weldability Reference Number
	C	Mn	S	Pb	
X1112	0.08/0.15	1.10/1.40	0.20-0.30		2A
1144	0.40/0.48	1.35/0.65	0.08-0.13		11A
X1147	0.40/0.47	0.60/1.90	0.10-0.35		11A
1214	0.15 Max	0.80/1.20	0.25-0.35		3A
12L14	0.15 Max	0.80/1.20	0.25-0.35	0.15-0.35	3A

### AS 1447 (1991) Hot Rolled Spring Steels.

Steel Designation	Chemical Analysis %				Weldability Reference Number
	C	Mn	Si	Cr	
K1070S	0.65-0.75	0.60-0.90	0.10-0.35		12A
XK5155S	0.50-0.60	0.70-1.0	0.10-0.35	0.70-0.90	12A
XK5160S	0.55-0.65	0.70-1.0	0.10-0.35	0.70-0.90	12A
XK9261S	0.55-0.65	0.70-1.0	1.8-2.20		12A

### AS 1663 (1991) Structural Steel Hollow Sections.

Steel Designation	Chemical Analysis %			Weldability Reference Number
	C	Mn	Si	
C250-C250LO*	0.12	0.50	0.05	1
C350-C350LO*	0.20	1.60	0.05	3
C450-C450LO*	0.20	1.60	0.35	3

\* Nb + V + Ti = 0.15

**WELDING OF STEEL**
**Steel Specifications:**
**Carbon Manganese Steels.**

Steel Designation	Chemical Analysis %		Weldability Reference Number
	C	Mn	
X1315	0.12-0.18	1.40-1.70	5
X1320	0.18-0.23	1.40-1.70	5
X1325	0.23-0.28	1.40-1.70	6
X1340	0.38-0.43	1.40-1.70	10
X1345	0.43-0.48	1.40-1.70	11

**AS 1444 (1986) Fully Killed Alloy Steels.**
**AS 2506 (1990) Wrought Alloy Steels.**

Steel Designation	Chemical Analysis %						Weldability Reference Number
	C	Mn	Si	Ni	Cr	Mo	
XK3312(EN36A)	0.10-0.16	0.35-0.60	0.10-0.35	3.0-3.75	0.70-1.0		6
4130	0.28-0.33	0.40-0.60			0.80-1.10	0.15-0.25	9
4140	0.30-0.43	0.75-1.0			0.80-1.10	0.15-0.25	12
XK4150	0.47-0.55	1.0-1.40	0.10-0.40		0.40-0.80	0.10-0.20	12
XK4340	0.37-0.44	0.55-0.90	0.10-0.35	1.55-2.0	0.65-0.95	0.20-0.35	12
4620	0.17-0.23	0.45-0.65	0.10-0.35	1.65-2.0		0.20-0.30	6
5140	0.38-0.43	0.70-0.90			0.70-0.90		11
8620	0.18-0.23	0.70-0.90	0.10-0.35	0.40-0.70	0.40-0.60	0.15-0.25	6
9050	0.45-0.55	0.90-1.20	0.60-0.90				11
XK9315	0.12-0.18	0.25-0.50	1.10-0.35	3.90-4.30	1.0-1.40	0.15-0.30	10
XK9931	0.27-0.35	0.45-0.70	0.10-0.35	2.30-2.80	0.50-0.80	0.45-0.65	12
XK9940	0.36-0.44	0.45-0.70	0.10-0.35	2.3-2.80	0.50-0.80	0.45-0.65	12

**WELDING OF STEEL**
**Steel Specifications:**
**BS STEEL SPECIFICATION.**

Steel Designation	Chemical Analysis %								Weldability Reference Number
	C	Mn	Si	Cr	Ni	Mo	S	P	
<b>BS 1501 (1980) Steels for Fired and Unfired Pressure Vessels</b>									
Grade 360	0.17	0.40 - 1.20							3
Grade 400	0.22	0.50 - 1.30							4
Grade 430	0.25	0.60 - 1.40							5
<b>BS EN 10028-2 (1993) Steels for Pressure Purposes, Non-alloy and Alloy Steels with Elevated Temperature Properties</b>									
Grade P235GH	0.16	0.40 - 1.20							3
Grade P265GH	0.20	0.50 - 1.40							4
Grade P295GH	0.08 - 0.20	0.90 - 1.50							5
Grade P355GH	0.10 - 0.22	1.00 - 1.70							5
<b>BS EN 10025 (1980) Hot Rolled Products of Non Alloy Structural Steels</b>									
Grade Fe 360									3
Grade Fe 430									4
Grade Fe 430		1.60							5
<b>BS970/PD970 Specification Steels</b>									
En 25	0.27-0.35	0.10-0.35	0.50-0.70	2.30-2.50	0.50-0.80	0.40-0.70	0.050	0.050	12
En 26	0.36-0.44	0.10-0.35	0.50-0.70	2.30-2.80	0.50-0.80	0.40-0.70	0.050	0.050	12
En 36A	0.15	0.10-0.35	0.30-0.60	3.00-3.75	0.60-1.10		0.050	0.050	6
En 39B	0.12-0.18	0.10-0.35	0.50	3.80-4.50	1.00-1.40	0.15-0.35	0.050	0.050	10
En 40A	0.10-0.20	0.10-0.35	0.40-0.65	0.40	2.90-3.50	0.40-0.70	0.050	0.050	10
En 40B	0.20-0.30	0.10-0.35	0.40-0.65	0.40	2.90-3.50	0.40-0.70	0.050	0.050	12

**Ferritic Creep Resistant Steels**

Steel Designation	Chemical Analysis %				Weldability Reference Number
	C	Mn	Si	Pb	
Mn-Mo	0.20	1.40	-	0.45	7B
1/2Cr-1/2Mo	0.15	0.50	0.50	0.50	7B
1Cr-1/2Mo	0.12	0.50	1.10	0.50	7B
2 1/4Cr-1Mo	0.12	0.50	2.30	1.00	12B
5Cr-1/2Mo	0.12	0.50	5.00	0.60	12B

**WELDING OF STEEL**
**Steel Specifications:**

Steel Designation	Chemical Analysis %								Weldability Reference Number
	C	Mn	Si	Cr	Ni	Mo	S	Other	
<b>Plastic Mould Steels</b>									
<b>ASSAB</b>									
Calmax	0.6	0.8	0.35	4.5		0.5		V 02	12C
<b>BOHLER STEEL</b>									
M200	0.40	1.50	0.40	1.90		0.20	0.070		12C
M238	0.38	1.50	0.30	2.0	1.10	0.20			12C
M310	0.43			13.5					12C
<b>COMMONWEALTH STEEL</b>									
P20	0.30	0.75	0.60	1.70		0.40			12C
Maxel Holder Block	0.50	1.30	0.30	0.65		0.18			12C
<b>STEELMARK EAGLE &amp; GLOBE</b>									
CSM20.30	0.80	0.50	1.65		0.40			12C	
Maxel HB	0.50	0.30	0.08	0.65		0.18			12C
420 MFQ	0.35	0.1	1.0	13.0					12C
<b>Hot Work Tool Steel</b>									
<b>ASSAB</b>									
8407	0.39	0.40	1.0	5.3		1.3		V0.9	12C
8407 Supreme	0.39	0.40	1.0	5.2		1.40		V0.9	12C
QRO 90 Supreme	0.38	0.75	1.0	.6		2.25		V0.9	12C
<b>BOHLER STEEL</b>									
W302	0.39	0.40	1.10	5.20		1.40		V0.95	12C
W321	0.39	0.35	0.30	2.90		2.8		V0.50 Co2.90	12C
W500	0.55	0.75	0.25	1.1	1.7	0.55		V0.10	12C
<b>COMMONWEALTH STEEL</b>									
R15	0.55	0.70	0.30	0.65	1.40	0.35			12C
H13	0.40	0.40	1.0	5.0		1.30		V1.10	12C
<b>STEELMARK EAGLE &amp; GLOBE</b>									
ADIC	0.39		1.0	5.2		1.40		V0.35	12C
NCM5	0.55	0.85		1.2	1.65	0.35		V0.15	12C

**WELDING OF STEEL**
**Steel Specifications:**

Steel Designation	Chemical Analysis %								Weldability Reference Number
	C	Mn	Si	Cr	Ni	Mo	S	Other	
<b>Cold Work Tool Steel</b>									
<b>ASSAB</b>									
XW10	1.0	0.60	0.30	5.3		1.1		V0.20	12C
XW5	2.05	0.80	0.30	12.5				W1.3	12C
XW41	1.55	0.4	0.3	11.8		0.8		V0.8	12C
DF2	0.95	1.1		0.6				W0.6 V0.1	12C
<b>BOHLER STEEL</b>									
K190	2.3	0.40	0.40	12.50		1.10		V4.0	12C
K600	0.45	0.40	0.25	1.30	4.0	0.25			12C
K660	0.70	2.0	0.30	1.0		1.35	0.15		12C
<b>STEELMARK EAGLE &amp; GLOBE</b>									
SC23	2.0	0.20	0.30	12.0					12C
SC25	1.50	0.45	0.25	18.0		1.0		V0.35	12C
NSS6	0.70	1.90	0.30	1.0		1.35			12C
SRS	0.60	0.80	1.60	0.35		0.40		V0.15	12C

**AS1302 (1991) Steel Reinforcing Bars For Concrete**

Steel Designation	Chemical Analysis %			Weldability Reference Number
	C	Mn	Si	
Grade 250R Plain Bars*	0.25			4
Grade 250S Deformed Bars*	0.25			4
Grade 400Y Deformed Bars*	0.22			3

\*Grain refining and micro alloying elements = 0.15%

**AS1085.1 Rail Steels**

Steel Designation	Chemical Analysis %			Weldability Reference Number
	C	Mn	Si	
Grade Grade 31kg or 41kg	0.53-0.69	0.60-0.95	0.15-0.35	12
Grade 50kg or 60kg	0.66-0.82	0.70-1.00	0.15-0.50	12



## WELDING OF STEEL

### Steel Specifications:

AS3678 (1990)

Structural Steels Hot Rolled Plates, Floor Plates and Slabs

Steel Designation	Chemical Analysis %						Weldability Reference Number
	C	Mn	Si	Ni	Cr	Mo	
Grade 200	0.15	0.60	0.25	-	-	-	1
Grade 250, 300	0.22	1.70	0.55	-	-	-	1
Grade 250L15, 350L15	0.22	1.70	0.55	-	-	-	3
Grade 350, 400	0.22	1.70	0.55	-	-	-	4
Grade 350L15, 400L15	0.22	1.70	0.55	-	-	-	6
Grade WR350 L0	0.14	1.70		0.55	0.35-1.05	0.15-0.50	5A

### Steels to Shipping Classification Society Rules

Steel Designation	Chemical Analysis %		Weldability Reference Number
	C	Mn	
Grade A	0.23	-	3A
Grade B	0.21	0.80 min.	3A
Grade D	0.21	0.60 min.	4A
Grade E	0.18	0.70 min.	4A
<b>American Bureau of Shipping</b>			
Class A	0.23	-	3A
Class B	0.21	0.80-1.10	4A
Class CS	0.16	1.00-1.35	3A
Class DS	0.16	1.00-1.35	3A
Class D	0.21	0.70-1.35	4A
Class E	0.18	0.70-1.35	4A
<b>Det Norske Veritas</b>			
Grade NVA	0.23	-	3A
Grade NVD	0.21	0.60 min.	4A
Grade NVE	0.18	0.70 min.	4A
<b>Bureau Veritas</b>			
Grade A	-	-	3A
Grade B	0.21	0.80-1.40	4A
Grade D	0.21	0.60-1.40	4A
Grade E	0.18	0.70-1.50	4A

## WELDING OF STEEL

### Steel Specifications:

**AS 1548 (1989)      Steel Plates for Boilers and Pressure Vessels**

Steel Designation	Chemical Analysis %							Weldability Reference Number
	C	Mn	Si	Ni	Cr	Mo	Cu	
7-430 R,N,A,T	0.20	0.50-1.60	.50	.30*	.25*	.10*	.20*	5
7-460 R,N,A,T	0.20	0.90-1.70	.60	.30*	.25*	.10*	.30*	5
5-490 N or A	0.24	0.90-1.70	.60	.30*	.25*	.10*	.20*	5
7-490 R,N,A,T	0.24	0.90-1.70	.60	.30*	.25*	.10*	.30*	6

\*Total Ni + Cr + Mo + Cu = .70% max.

### PIPE LINE STEELS

**API 5L (1992)      Specification for Seamless Line Pipe**

Steel Designation	Chemical Analysis %		Weldability Reference Number
	C	Mn	
Grade A25 Cl I, Cl II	0.21	0.30 - 0.60	2
Grade A	0.22	0.90	3
Grade B	0.27	1.15	5
Grade X42	0.29	1.25	5
Cold-expanded -Grades X46, X52	0.29	1.25	5
Non-expanded -Grades X46, X52	0.31	1.35	5
Grades X56, X60	0.26	1.35	5

**API 5L (1992)      Specification for Welded Line Pipe**

Steel Designation	Chemical Analysis %		Weldability Reference Number
	C	Mn	
Grade A25 Cl I, Cl II	0.21	0.30 - 0.60	2
Grade A	0.21	0.90	3
Grade B	0.26	1.15	4
Grade X42	0.28	1.25	5
Cold-expanded -Grades X46, X52	0.28	1.25	5
Non-expanded -Grades X46, X52	0.30	1.35	5
Grades X56, X60	0.26	1.35	5
Grade X65	0.26	1.40	5
Grade X70	0.23	1.60	5
Grade X80	0.18	1.80	5

**WELDING OF STEEL**
**Steel Specifications:**
**ASTM SPECIFICATION STEELS**

Steel Designation	Chemical Analysis %		Weldability Reference Number
	C	Mn	
<b>ASTM A36M (1991) Structural Steel Plates</b>			
To 20mm including	0.25		4
Over 20 to 40mm including	0.25	0.80 - 1.20	4
Over 40 to 65mm including	0.26	0.80 - 1.20	4
Over 65 to 100mm including	0.27	0.85 - 1.20	5
Over 100mm	0.29	0.85 - 1.20	5
<b>ASTM 242M (1991) High Strength Low Alloy Structural Steel</b>			
Type 1	0.15	1.00	5
<b>ASTM 283M (1992) Low and Intermediate Tensile Strength Carbon Steel Plates</b>			
Grade A	0.14	0.90	2
Grade B	0.17	0.90	3
Grade C	0.24	0.90	4
Grade D	0.27	0.90	4
<b>ASTM 284M (1990) Low and Intermediate Tensile Strength Carbon - Silicon Steel Plates</b>			
<b>Grade C:</b>			
25mm and under	0.24	0.90	3
Over 25 to 50 mm, including	0.27	0.90	4
Over 50 to 100mm, including	0.29	0.90	4
Over 100 to 200mm, including	0.33	0.90	5
Over 200 to 300mm, including	0.36	0.90	6
<b>Grade D:</b>			
25mm and under	0.24	0.90	3
Over 25 to 50 mm, including	0.27	0.90	4
Over 50 to 100mm, including	0.29	0.90	4
Over 100 to 200mm, including	0.33	0.90	5
<b>ASTM 285M (1990) Pressure Vessel Plates, Carbon Steel</b>			
Grade A	0.17	0.90	2
Grade B	0.22	0.90	3
Grade C	0.28	0.90	4

## WELDING OF STEEL

## Steel Specifications:

## ASTM SPECIFICATION STEELS.

Steel Designation	Chemical Analysis %		Weldability Reference Number
	C	Mn	
<b>ASTM A516M (1990) Pressure Vessel Plates, Carbon Steel</b>			
<b>Grade 415</b>			
12.5mm and under	0.21	0.60 - 0.90	3
Over 12.5 to 50mm including	0.23	0.85 - 1.20	4
Over 50 to 100mm including	0.25	0.85 - 1.20	5
Over 100 to 200mm including	0.27	0.85 - 1.20	5
Over 200	0.27	0.85 - 1.20	5
<b>Grade 450</b>			
12.5mm and under	0.24	0.85 - 1.20	4
Over 12.5 to 50mm including	0.26	0.85 - 1.20	5
Over 50 to 100mm including	0.28	0.85 - 1.20	5
Over 100 to 200mm including	0.29	0.85 - 1.20	5
Over 200	0.29	0.85 - 1.20	5
<b>Grade 485</b>			
12.5mm and under	0.27	0.85 - 1.20	5
Over 12.5 to 50mm including	0.28	0.85 - 1.20	5
Over 50 to 100mm including	0.30	0.85 - 1.20	6
Over 100 to 200mm including	0.31	0.85 - 1.20	6
Over 200mm	0.31	0.85 - 1.20	6
<b>ASTM A537M (1991) Pressure Vessel Plates, Heat Treated, Carbon-Manganese-Silicon Steel</b>			
40mm and under	0.24	0.70 - 1.35	5
Over 40mm	0.24	1.00 - 1.60	6
<b>ASTM A569M (1991) Carbon Steel (0.15% max) Hot-Rolled Sheet and Strip</b>			
Commercial quality	0.15	0.60	1
<b>ASTM A572M (1992) High Strength Low Alloy Niobium Vanadium Steels</b>			
Grade 290	0.21	1.35	5
Grade 345	0.23	1.35	5
Grade 415	0.26	1.35	6
<b>Grade 450:</b>			
13mm and under	0.26	1.35	6
over 13mm to 32mm	0.23	1.65	6

## WELDING OF STEEL

### Steel Specifications:

#### ASTM SPECIFICATION STEELS.

Steel Designation	Chemical Analysis %		Weldability Reference Number
	C	Mn	
<b>ASTM A607 (1992) Steel Sheet and Strip, High Strength, Low Alloy, Hot Rolled and Cold Rolled</b>			
<b>Grade 415:</b>			
Class 1, Grade 45	0.22	1.35	4
Class 1, Grade 50	0.23	1.35	5
Class 1, Grade 55	0.25	1.35	5
Class 1, Grade 60	0.26	1.50	6
Class 1, Grade 65	0.26	1.50	6
Class 1, Grade 70	0.26	1.65	6
Class 2, Grades 50,55	0.15	1.35	3
Class 2, Grades 60, 65	0.15	1.50	4
Class 2, Grade 70	0.15	1.65	4
<b>ASTM A662M (1990) Pressure Vessel Plates, Carbon Manganese Steel for Moderate and Lower Temperature Service</b>			
Grade A	0.14	0.90 - 1.35	3
Grade B	0.19	0.85 - 1.50	4
Grade C	0.20	1.00 - 1.60	5
<b>ASTM A737M (1987) Pressure Vessel Plates, High Strength Low Alloy Steels</b>			
Grade B	0.20	1.15 - 1.50	5
Grade C	0.22	1.15 - 1.50	5

## WELDING OF STEEL

### Steel Specifications:

#### QUENCHED AND TEMPERED STEELS.

#### Structural and Abrasion Resistant Grades.

Properties	Steel Designation	Typical Chemical Analysis* (%)								Weldability Reference Number
		C	Mn	Si	Cr	Ni	Mo	S	Other	
<b>BISALLOY Q &amp; T STEELS (Australia).</b>										
<b>Yield Stress:</b>										
500MPa 600MPa 620-690MPa	Bisalloy 60 Bisalloy 70 Bisalloy 80/80PV	0.16-0.18	1.10-1.40	0.20	0.20-0.90	---	0.20	0.003	B: 0.001 Ti: 0.02	13
<b>Hardness:</b>										
320-360HB 360-400HB 400-460HB	Bisplate 320 Bisplate 360 Bisplate 400	0.18 0.28	1.15 0.50	0.40 0.35	0.85 0.96	---	0.20 0.15	---	B: 0.002 Ti: 0.03 B: 0.002 Ti: 0.04	13 13
<b>IMPORTED Q &amp; T STEELS (JAPAN &amp; USA).</b>										
<b>Yield Stress:</b>										
550MPa 690MPa 690MPa 690MPa 450MPa 690MPa 690MPa	HY80 HY100 USST1 USST1 Type A Welten 60 Welten 80C Welten 80E	0.14 0.16 0.18 0.11 0.10 0.18	0.30 0.85 0.90 1.22 0.85 0.90	0.25 0.30 0.30 0.45 0.22 0.23	1.60 0.57 0.55 0.17 0.80 0.40	2.8 0.90 0.20	0.40 0.50 0.20 0.45		B: 0.004 V: 0.04 Cu: 0.30 B: 0.001 V: 0.04 V: 0.04 B: 0.001 V: 0.04 Cu: 0.28 B: 0.001 V: 0.03 Cu: 0.25	13 13 13 13 13 13
<b>Hardness:</b>										
320HB min 360HB min 477HB min	Welten AR 320 Welten AR 360C Welten AR 500	0.18 0.18 0.30	1.10 1.10 1.20	0.25 0.25 0.40	0.70 0.90 0.60		0.35 0.35 0.10		B: 0.002 V: 0.04 Cu: 0.35 B: 0.002 V: 0.04 Cu: 0.35 B: 0.003 Cu: 0.28	13 13 13

\* Dependent on plate thickness.

## WELDING OF STEEL

### Quenched & Tempered Steels:

Preheat recommendations for Q & T Steels - Table 2.

Q & T Steel Grade	< 13mm	> 13mm < 25mm	> 25mm < 50mm	> 50mm
<b>MINIMUM PREHEAT TEMPERATURE (°C)</b> (assuming high joint restraint)				
<b>High Strength Structural Grades.</b>				
450 MPa minimum Yield Stress	10	25	75	100
620 MPa minimum Yield Stress	50	100	125	150
680 MPa minimum Yield Stress	50	100	125	150
<b>Abrasion Resistant Grades.</b>				
320 HB	50	100	125	100
360 HB	50	100	125	150
500 HB	100	150	150	---
<b>MAXIMUM INTERPASS TEMPERATURE (°C)</b>				
All Grades	150	175	200	220
<b>MAXIMUM ARC HEAT INPUT (Kj / mm)</b>				
All Grades	2.5	3.5	4.5	5.0

Filler Metal Selection Guide for Bisalloy Q & T Steels - Table 3.

Steel Designation	Weld Strength Category*	Manual Metal Arc Welding (MMAW)	Gas Metal Arc Welding # (GMAW)	Flux Cored Arc Welding # (FCAW)
Bisalloy 60	MS	Alloycraft 90	Autocraft Mn-Mo	Verti-Cor 91 K2 H4
	LS	Ferrocrafft 61/ 7016	Autocraft LW1-6	Supre-Cor 5 / Verti-Cor 81Ni 1
	M H	NR	NR	NR
Bisalloy 70	MS	Alloycraft 110	Autocraft NiCrMo	Tensi-Cor 110TXP H4
	LS	Ferrocrafft 61/ 7016	Autocraft Mn-Mo / Autocraft LW1-6	Supre-Cor 5 / Verti-Cor 81Ni 1
	M H	NR	NR	NR
Bisalloy 80	MS	Alloycraft 110	Autocraft NiCrMo	Tensi-Cor 110TXP H4
	LS	Ferrocrafft 61/ 7016	Autocraft LW1-6 / Autocraft Mn-Mo	Verti-Cor 111 K3 H4 Supre-Cor 5 / Verti-Cor 81Ni 1
	M H	NR	NR	NR
Bisplate 320, 360, 400, 500	MS	NR	NR	NR
	LS	Ferrocrafft 61/ 7016	Autocraft LW1-6	Supre-Cor 5 / Verti-Cor 81Ni 1
	M H	Cobalarc 350, 650	-	Stoody Super Build-up, Stoody 965 G10

\* Weld Strength Category Definitions:

MS - Matching Strength  
M H - Matching Hardness

LS - Lower Strength  
NR - Not Recommended

# Use only recommended shielding gases, please refer to product data in this handbook.

## WELDING OF STEEL

## Welding Recommendations:

Weldability Reference No:

- 1 & 2 Readily weldable with mild steel electrodes of the AS/NZS 1553.1: E41XX or E48XX, or AWS A5.1: E60XX or 70XX classifications (such as Satinraft 13, Ferrocraft 12XP, Ferrocraft 21 or Weldcraft). Gas Metal Arc (GMAW or MIG/MAG) welding or Flux Cored Arc welding (FCAW) with an appropriate CIGWELD welding consumable such as Autocraft LW1-6 or Verti-Cor 'series' wires can be carried out with out any precautions. No preheat is normally required.
- 2A\* The welding of these steels is normally not recommended because the high sulphur or lead content can often lead to hot shortness during welding. For non critical applications, best results are achieved using basic coated electrodes such as Ferrocraft 7016, Ferrocraft 61 or Ferrocraft 16TXP
- 3 & 4 Readily welded using mild steel electrodes as per recommendation 1 & 2. GMAW or FCAW processes can be used depending on specific welding details including equipment availability, welding location, material thickness and positional welding requirements etc. Refer to GMAW product data for Autocraft LW1-6 and FCAW product data for Verti-Cor XP / Ultra / Ultra 3 and 3XP in the front of this handbook.  
For Combined Joint Thicknesses (CJT, refer Diagram 1) of  $\geq 50\text{mm}$ , the best practice is to select a hydrogen controlled welding process / consumable combination and a correspondingly lower preheat temperature.
- 3A\* & 4A\* Check specific Shipping Society approval requirements of the consumable.  
This group of steels are readily welded using mild steel electrodes of the AS/NZS 1553.1: E41XX-2 or E48XX-2 classifications. Also readily weldable with the GMAW process and Autocraft LW1-6 welding wire or other "W503" GMAW welding wires. The FCAW process can also be used with Verti-Cor Ultra 3 / 3XP or other "W503" FCAW wires.
- 5 & 6 For intermediate strength and low alloy high strength steel, select a welding consumable producing near matching weld deposit analysis and/or mechanical properties. The best practice is to select a hydrogen controlled electrode or welding wire of a comparable strength grade to that of the steel being welded and use the recommended preheat.
- 5A\* To achieve matching 'weathering' of the parent steel, a welding consumable containing Nickel and Copper alloy additions must be used. If colour match is not an issue refer to 5.
- 7, 8 & 9 Follow the recommendations prescribed in 5 & 6. The use a hydrogen controlled welding process / consumable combinations is considered more important as the carbon equivalent and hardenability of the steel increases. The weld deposit strength level should at least equal that of the grade of steel being welded. These steels are hardenable and the use of correct preheat and interpass temperatures and slow cooling after welding are important for success.  
To avoid hydrogen cracking, the welding consumable should be used, stored and reconditioned in accordance with the manufacturer's recommendations. For CIGWELD welding consumables please refer to Recommended Storage, Care and Conditioning of CIGWELD Electrodes, Welding Wires and Rods in **this handbook**.
- 7B\* These Chromium-Molybdenum and Molybdenum type steels are usually welded with near matching welding consumables such as Alloycraft 80-B2 electrodes, Autocraft Mn-Mo / CrMo1 GMAW welding wires or Comweld CrMo1 GTAW rods etc. This is carried out to achieve comparable creep strength and corrosion resistance to the parent steel. Low hydrogen welding conditions are essential as are the correct preheat and interpass temperatures, retarded cooling and a post weld heat treatment.

\*Note A, B &amp; C suffixes indicate constraints or conditions not adequately covered by the CE formula (eg high S, Pb etc)



## WELDING OF STEEL

### Welding Recommendations:

Weldability Reference No:

- 10 & 11 Use hydrogen controlled welding process / consumable combinations which best match the chemical composition and/or strength level of the parent steel. To avoid hydrogen cracking, the welding consumable should be used, stored and reconditioned in accordance with the manufacturer's recommendations. For CIGWELD welding consumables please refer to Recommended Storage, Care and Conditioning of CIGWELD Electrodes, Welding Wires and Rods **in this handbook**. Preheat temperature should be determined using the procedure described on page 289 of this guide. The use of 'dry' welding consumables is essential for the successful welding of these steels, as is slow cooling after welding. Post Weld Heat Treatment (PWHT) is also considered good welding practice.
- 11A Following on from recommendation 2A the welding of high carbon, sulphur bearing steel is not recommended except for non critical applications. Use hydrogen controlled process / consumable combinations. Welding consumables must be dry immediately prior to use, please refer to Recommended Storage, Care and Conditioning of CIGWELD Electrodes, Welding Wires and Rods **in this handbook**.
- 12 Use hydrogen controlled welding process / consumable combinations, including such consumables as Ferrocraft 61 and Ferrocraft 7016 electrodes or Suprecor 5 flux cored wire for lower strength welding and Alloycraft 110 electrode or Tensi-Cor 110 TXP flux cored wire for higher strength joints. The choice of higher or lower consumable strength levels will depend on the specifics of the application. These steels are normally supplied in the hardened and tempered condition which requires strict control of preheat, interpass temperature, post weld cooling and PWHT. To achieve optimum results please refer to the steel supplier for specific technical information, in particular heat treatment recommendations.
- 12A\* For the welding of high alloy spring steels in the hardened and tempered condition: Use hydrogen controlled process / consumable combinations including such consumables as Ferrocraft 61, Ferrocraft 7016 or Supre-Cor 5 in a thoroughly dry condition. Preheat steel sections to be joined to 250-300°C and maintain an interpass temperature of 250-300°C throughout welding. After welding slowly cool the joint in lime or wrap in a thermal blanket. Alternatively where preheat must be reduced to the minimum, use Weldall electrodes with approximately 100°C less preheat and interpass temperature (ie 150 - 200°C) and slowly cool as previously described.
- 12B\* These Chromium-Molybdenum type steels are usually welded with near matching welding consumables such as Alloycraft 90-B3 electrodes, Autocraft CrMo2 GMAW welding wire or Comweld CrMo2 GTAW rods etc. This is done to achieve comparable creep strength and corrosion resistance to the parent steel. Low hydrogen welding conditions are essential as are the correct preheat and interpass temperatures, retarded cooling and a post weld heat treatment.
- 12C\* The welding of tool steels in the heat treated (hardened and tempered) condition should be avoided where possible. Comprehensive repair and maintenance applications using ferritic steel, low hydrogen consumables such as Ferrocraft 18-Ni electrodes or Supre-Cor 5 flux cored wire should only be attempted on mould and tool steels in the annealed condition. Minor repair work on heat treated tool steels can be carried out using "reconditioned" Weldall electrodes and appropriate preheat and interpass temperatures, retarded cooling and a post weld heat treatment (PWHT) to reduce residual stresses. Please refer to the steel manufacturer for specific welding recommendations.

\*Note A, B & C suffixes indicate constraints or conditions not adequately covered by the CE formula (eg high S, Pb etc)

## WELDING OF STEEL

### Welding Recommendations:

Weldability Reference No:

13

#### Welding Quenched and Tempered ( Q & T ) steels:

1. Use only hydrogen controlled welding process / consumable combination, where the welding consumable has been used, stored and re-conditioned in accordance with the manufacturer's instructions. Refer to Recommended Storage, Care and Conditioning of CIGWELD Electrodes, Welding Wires and Rods in **this handbook**.
2. Welding consumable selection is dependant on the particular grade of steel being welded and the specific service requirements of the weldment.
3. For full strength weld joints select a welding consumable of matching ( or near matching) weld metal mechanical properties. See Table 3 on Page 302 for CIGWELD welding consumable recommendations.
4. For lower strength welds select hydrogen controlled welding consumables having lower weld metal tensile properties and alloy content. See Table 3 on Page 302 for CIGWELD welding consumable recommendations.
5. Recommended preheat and interpass temperatures and maximum heat input data for structural and abrasion resistant Q & T steel grades are detailed in Table 2 on Page 302. If they are not adhered to closely the strength or integrity of the joint may be compromised.
6. Lower strength welding consumables are invariably used to join abrasion resistant Q & T steels because of their very high tensile properties. For butt welds subject to surface abrasion, a capping pass deposited with a welding consumable of matching hardness to the base steel is sometimes used.

**WELDING OF STEEL**
**Consumables Prequalified to AS/NZS 1554.1: 1995**

Manual Metal Arc Welding Consumables:	AS/NZS Standard	LRS/DNV Approval	Applicable Steel Types*
GP6012	E4112-0	2	1 & 2
Ferrocrafter 12XP	E4112-0	2Y	"
Satincrafter 13	E4113-0	2	"
Ferrocrafter 11	E4111-2	3	3, 4, 5 & 6
PipeArc 6010P	E4110-2	3	"
Weldcrafter	E4113-2	3	"
Ferrocrafter 21	E4814-2	3	3, 4, 5, 6, 7A & 7B
Ferrocrafter 22	E4824-0	2Y	"
Ferrocrafter 16TXP	E4816-2 H <sub>10</sub>	3YH	"
Ferrocrafter 55U	E4816-2 H <sub>10</sub>	3YH	"
Ferrocrafter 61	E4818-3 H <sub>10</sub>	3YH	"
Ferrocrafter 7016	E4816-3 H <sub>10</sub>	3YH	"
Gas Metal & Flux Cored ARC Welding Consumables:	AS/NZS Standard	LRS/DNV Approval	Applicable Steel Types*
Autocrafter LW1	E54-GC/M-W503AH	3YMS	All Types
Autocrafter LWI-6	E56-GC/M-W503AH	3YS	"
Verti-Cor Ultra	ETP-GCp-W502A. CM1 H <sub>10</sub>	2YSH	1, 2 & 4
Verti-Cor Ultra H4	ETP-GCp-W502A. CM1 H <sub>5</sub>	2YSH	1, 2 & 4
Satin-Cor XP	ETD-GCp-W502A. CM1 H <sub>10</sub>	2YSH	"
Verti-Cor XP	ETD-GMp-W502A. CM1 H <sub>10</sub>	2YSH	"
Metal-Cor XP	ETD-GMn/p-W503A. CM1 H <sub>5</sub>	3YSH	All Types
Verti-Cor 3XP	ETP-GMp-W503A. CM1 H <sub>10</sub>	3YSH	"
Verti-Cor 3XP H4	ETP-GMp-W503A. CM2 H <sub>5</sub>	3YSH	"
Supre-Cor 5	ETP-GMn-W505A. CM1 H <sub>5</sub>	3YSH	"

\* See applicable steel types on next page.

## APPLICABLE STEEL TYPES - PREQUALIFIED TO AS/NZS 1554.1: 1995

Steel type	AS 1163	AS 1397	AS 1450	AS 1548	AS 1594	AS 1595	AS 2074	AS 3678/ AS 3679.2	AS 3679.1	NZS 3415
1	C250	G250 G300	C200 H200 C250 H250	7-430 7-460	Hd1 Hd2 Hd3 Hd4 Hd200 Hd250 Hd300 Hd300/1 A1006 A1010 A1016	All grades	C2 C3 C7A-1	200 250 300 A1006 XK1016	250 300	Fe 430A
2	C250 L0			7-430L0 7-460L0					250 L0 300 L0	Fe 430C
3				7-430L20 7-430L40 7-430L50 7-460L20 7-460L40 7-460L50				250 L15 300 L15	250 L15 300 L15	Fe 430D
4	C350	G350	C350 H350	5-490 7-490	Hd350 Hd400 HW350		C1 C4-1 C4-2 C7A-2	350 WR350/1 400	WR350/1 WR350/2 350	Fe 510A Fe 510B
5	C350 L0			7-490L0	XF300 XF400			WR350/1 L0	WR350/1 L0 WR350/2 L0 350 L0	Fe 510C
6				5-490L20 5-490L40 5-490L50 7-490L20 7-490L40 7-490L50				350 L15 400 L15	WR350/2 L15 350 L15	Fe 510D
7A	C450	G450	C450							
7B	C450L0									

**WELDING OF STEEL**
**Consumables for Welding Structural, Stainless and Engineering Steels:**

Applicable Steel Grades	Manual Metal Arc	Gas Metal Arc	Gas Tungsten Arc	Flux Cored Arc
AS3678 (AS 1204) Grades 200, 250, 300 and LO & L15 Grades  AS 1548 Grad 7-430R	Ferrocrafft 11 (P) Weldcraft (P)	Autocrafft LW1 (P)  Autocrafft LW1-6 (P)	Comweld High Test (P)	Verti-Cor XP (P) Satin-Cor XP (P) Metal-Cor XP (P) Verti-Cor Ultra (P) Satin-Cor HD70
AS3678 (AS 1204) Grades 350, 400 and LO & L 15 Grades  AS 1548 Grades 7-460R, 5-490 and L20 Grades	Ferrocrafft 21 (P) Ferrocrafft 22 (P) Ferrocrafft 61 (P)	Autocrafft LW1 (P) Autocrafft LW1-6 (P)	Comweld Super steel  Supre-Cor XP (P)	Vert-Cor XP(P) Verti-Cor 3 XP (P) Metal-Cor XP (P) M-Cor 5 (P) Verti-Cor (P)
AS2074 Grades C4, C5, C6, C7, L1A, L1B  ASTM A106 All Grades	Ferrocrafft 61  Ferrocrafft 7016	Autocrafft LW1  Autocrafft LW1-6	  Comweld Super steel	Supre-Cor 5
AS1548 L40  ASTM A333 Grades 3 & 7				Supre-Cor 5 Verti-Cor 81 Ni1 Verti-Cor 81Ni1 H4
AS1442 S5, K5, K9 AS2074 Grade L3A AS2056 EN33 ASTM Grades: A148 80-40, 80-50 A302B, C & D A420 WPL9 A437 Class 2	Alloycraft 80-C1	Autocrafft Mn-Mo		Verti-Cor 81Ni 1 Verti-Cor 81Ni1 H4
ASTM A2170-WC6 ASTM A335-P11 ASTM A387-G11, 12 AS2074 Grades L5B, L5D, L5F	Alloycraft 80-B2	Autocrafft CrMo1	Comweld CrMo1	
ASTM A217-WC9 ASTM A335-P22 ASTM A387-G22 AS2074 Grades L5C, L5D, L5F	Alloycraft 90-B3		Comweld CrMo2	
AS3597 - 500 ASTM A537 C1.2 ASTM A572 Grades 60, 65 ASTM A852 eg. Bisalloy 60 AS2074 Grade L6	Alloycraft 90			Verti-Cor 91 K2 H4

(P) These products are prequalified to AS/NZS 1554.1 for welding the steels listed.

## WELDING OF STEEL

## Consumables for Welding Structural, Stainless and Engineering Steels cont.

Applicable Steel Grades	Manual Metal Arc	Gas Metal Arc	Gas Tungsten Arc	Flux Cored Arc
AS 3597-600 & 700 ASTM A533 Type A ASTM A514 A517 eg. Bisalloy, Welten 70 & 80 AS2074 Grade L6A	Alloycraft 110	Autocraft NiCrMo		Tensi-Cor 110T XP H4 Verti-Cor 111K-3 H4
AS2074 Grades H1A, H1B (Hadfield Manganese) (Austenitic Manganese) ASTM A128 All Grades	Cobalarc Mangcraft (build up)	Autocraft 309LSi	Comweld 309L	Verti-Cor 309LT
AISI Grades 201, 202 301, 301, 304, 304L, 305 AS2074 Grade H5A	Satinchrome 308L-17	Autocraft 308LSi	Comweld 308L	Verti-Cor 308LT
AISI Grades 316L, 316, 316TI AS2074 Grades H6B, H6C	Satinchrome 316L-17 Satinchrome 318-17	Autocraft 316LSi	Comweld 316L	Verti-Cor 316LT
AISI Grade 309 AS2074 Grades H8A, H8B	Satinchrome 309Mo-17	Autocraft 309LSi	Comweld 309L	Verti-Cor 309LT
Joining 3CR12 & 5CR12. Joining dissimilar steels eg. stainless steel to structural steel	Satinchrome 309Mo-17  Cobalarc Austex	Autocraft 309LSi	Comweld 309L	Verti-Cor 309LT
ASTM A288 Grade 5 ASTM A434 Grades BB, BC ASTM A513 Grades 4130, 8630 Hardened to 230-270 HB	Alloycraft 110	Autocraft NiCrMo		Tensi-Cor 110T XP H4 Verti-Cor 111K-3 H4
AS1444 Grade XK4140 ASTM A288 Grades 6, 7, 8 ASTM A434 Grades BB, BC, BD ASTM A513 Grades 4130, 8630 Hardened to 330-370HB AS2074 Grade L6C	Cobalarc 350			Stoody Super Build Up

## WELDING OF STAINLESS STEEL

### Introduction.

This section is designed to provide the reader with a technical overview for welding the major types of stainless steels available today.

### Types of Stainless Steels:

Stainless steels are an important grade of structural material used worldwide for a multitude of applications based on their corrosion resistance, heat resistance, aesthetic appeal, low temperature properties, high strength and/or ease of cleaning and sterilising.

The main types of weldable stainless steels available include:

- ▲ Austenitic stainless steels (AISI 200 and 300 series / UNS S20000 and S30000 series) which are easy to weld and by far the most popular type - accounting for over 70% of the stainless steel sold around the world.
- ▲ Ferritic stainless steels (AISI 400 series / UNS S40000 series) which are weldable particularly in thin sections and commonly used for elevated temperature applications.
- ▲ Martensitic stainless steels (AISI 400 series / UNS S40000 series) which are difficult to weld and commonly used for wear resistant applications.
- ▲ Duplex stainless steels (UNS S30000 series) which are weldable with precautions and used for corrosion resistant applications as an alternative to 300 series austenitic stainless steels.

### WELDING TECHNIQUE

The technique of welding stainless steels does not differ greatly from that of the welding of mild steel, but as the material being handled is very expensive, and exacting conditions of service are usually involved, extra precautions and attention to detail at all stages of fabrication is desirable. In principle, all stainless steel for high-class work should be welded with a short arc.

Any techniques which aim at increasing the penetration, speed of travel or the use of wide weaving techniques are to be discouraged. Usually the lowest convenient current should be used. Weaving should be not wider than twice the diameter of the electrode for base material and electrodes of like composition, and even less for plate of dissimilar composition.

The edges of the preparation should be free from scale. Clamps and jigs are advisable when welding sheets thinner than 3 mm (1/8 in) while cooling blocks are helpful with sheets 1.6mm to 2.5 mm (1/16 in to 3/32 in) thick. Tack welds, particularly on thin sheets, should be placed much closer together than is the usual practice for mild steel. This procedure is necessary as the thermal conductivity of these alloy steels is less and the coefficient of expansion is considerably greater than that of mild steel.

#### NOTES ON TECHNIQUE:

1. Ensure that the surface of the material in the weld area is clean and free from foreign matter.
2. Use the edge preparation shown in Table 1 over the page.
3. Tack at regular intervals, at about half the pitch used for mild steel.
4. Maintain a short arc during welding, to avoid loss of alloying materials during transfer across the arc.

## WELDING OF STAINLESS STEEL

### NOTES ON TECHNIQUE cont.:

5. Use stringer passes rather than wide weaves.
6. To minimise distortion, employ back step or block sequences when welding.
7. Thoroughly remove slag from welds between passes.
8. When welding double V or U joints, balance the welding on each side, to minimise distortion.
9. Never use emery wheels or buffs for grinding or polishing stainless if they have previously been used for mild steel.
10. Do not use excessive welding current. Because of the high electrical resistance and low thermal conductivity, the currents used with stainless steel electrodes are somewhat lower than those used for mild steel.

TABLE 1. EDGE PREPARATION FOR MANUAL METAL ARC WELDING:

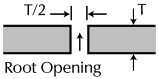
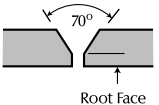
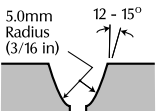
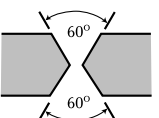
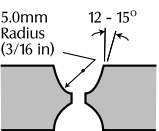
Thickness (mm)	Edge Preparation	Notes
Up to 1.5 (1/16")		Square butt joint - not gap.
1.5 - 5.0 (1/16" - 3/16")		Square butt joint - gap equal to half thickness.
5.0 - 13.0 (3/16" - 1/2")		Single V preparation - 1.5 mm (1/16") landing, 1.5 mm (1/16") gap.
13.0 - 20.0 (1/2" - 3/4")		Single U preparation - 3 mm (1/8") landing, 3 mm (1/8") gap.
Over 20 (3/4")		Double V preparation - 1.5mm (1/16") max. landing, 1.5 mm (1/16") gap.
		Double U preparation - 3 mm (1/8") landing, 1.5 mm (1/16") to 3mm (1/8") gap.



## WELDING OF STAINLESS STEEL

### Austenitic Stainless Steels

Austenitic stainless steels are easily welded with all standard arc welding processes, without preheat and using matching or near matching welding consumables. Because of their high thermal expansion and low thermal conductivity compared to carbon steel they will distort more during and after welding. This can be minimised by more frequent tacking prior to welding, balanced and back step welding methods and the use of lower welding current and heat input parameters. Low carbon austenitic stainless steels are commonly used because they are less susceptible to sensitisation (or carbide precipitation) during welding or high temperature service which can result in intergranular corrosion in a caustic environment. Matching low carbon welding consumables (designated with an "L") are also commonly used to desensitise the weld deposit, in the same way as the parent metal, and eliminate the risk of intergranular corrosion of the welded joint.

The common welding consumable types used for welding the many austenitic stainless steel grades are shown in the following table.

### Austenitic Stainless Steel Grades - Welding Consumable Selection Guide.

Stainless Steel Grade			Welding consumable type		
AISI No:	UNS No:	Werkstoffe No:	1st Choice	2nd Choice	3rd Choice
201	S20100	---	308 / 308L	316L	347
202	S20200	1.4371	308 / 308L	316L	347
205	S20500	---	308 / 308L	316L	347
209	S20910	1.4565	308 / 308L	316L	347
301	S30100	1.4310	308 / 308L	316L	347
302	S30200	---	308 / 308L	316L	347
303	S30300	1.4305	312 (Weldall)	309L / 309Mo	308 / 308L
303Se	S30323	---	312 (Weldall)	309L / 309Mo	308 / 308L
304	S30400	1.4301	308 / 308L	316L	347
304L	S30403	1.4306	308 / 308L	316L	347
304H	S30409	1.4948	308H	308L	316L
304N	S30451	---	308L / 308	316L	347
304LN	S30453	1.4311	308L / 308	316L	347
305	S30500	1.4303	308 / 308L	316L	347
308	S30800	---	308 / 308L	316L	347
309	S30900	1.4828	309 / 309L / 309Mo	312 (Weldall)	---
309S	S30908	1.4833	309L / 309Mo	312 (Weldall)	---
310	S31000	1.4841	310	---	---
310S	S31008	1.4845	310	---	---
314	S31400	---	310	318	309L / 309Mo
316	S31600	1.4401	316 / 316L	318	309L / 309Mo
316L	S31603	1.4404	316L / 316	318L	309L / 309Mo
316H	S31609	1.4919	316H	316L / 318	309L / 309Mo
316N	S31651	---	316L / 316	318	309L / 309Mo
316LN	S31653	1.4406	316L / 316	318	309L / 309Mo
317	S31700	1.4429	317 / 317L	318	316L
317L	S31703	1.4438	317L	318	316L
321	S32100	1.4541	347	318	308 / 308L
321H	S32109	1.4941	347	318	308 / 308L
347	S34700	1.4550	347	318	308 / 308L
347H	S34709	---	347	318	308 / 308L
348	S34800	---	347	318	308 / 308L
384	S38400	---	309L / 309Mo	312 (Weldall)	---

## WELDING OF STAINLESS STEEL

### Ferritic Stainless Steels:

Ferritic stainless steels can be welded under strict precautions using all standard arc welding processes. They can be joined with welding consumables which match or near match the base metal or with austenitic welding consumables, for example Satincrome 308L-17 & 316L-17 electrodes or Autocraft 308LSi & 316LSi GMAW wires. During welding, ferritic stainless steel grades can suffer a loss of ductility due to grain growth, martensite formation and carbide precipitation. To achieve good welds, in thicker sections, it is often necessary to preheat the work to  $\approx 100-120^{\circ}\text{C}$  and minimise the heat input during welding. To dissolve or modify carbides in the Heat Affected Zone (HAZ) and reduce welding stresses, post-weld heat treatment to  $750-850^{\circ}\text{C}$  for 30-60 minutes is necessary. This heat treatment will improve the ductility, toughness and corrosion resistance of the Heat Affected Zone.

### Ferritic Stainless Steel Grades - Welding Consumable Selection Guide.

Stainless Steel Grade			Welding consumable type		
AISI No:	UNS No:	Werkstoffe No:	1st Choice	2nd Choice	3rd Choice
405	S40500	1.4002	430	309L / 309Mo	308
409	S40900	1.4512	309L / 309Mo	312 (Weldall)	---
429	S42900	1.4001	430	308 / 308L	309L / 309Mo
430	S43000	1.4016	430	308 / 308L	309L / 309Mo
430F	S43020	1.4104	430	308 / 308L	309L / 309Mo
430FSe	S43023	---	430	308 / 308L	309L / 309Mo
434	S43400	1.4113	430	308 / 308L	309L / 309Mo
436	S43500	---	430	308 / 308L	309L / 309Mo
442	S44200	---	316L	318	309L / 309Mo
444	S44400	1.4521	316L	318	309L / 309Mo
446	S44600	1.4762	308 / 308L	309L / 309Mo	310
3Cr12	---	---	309L / 309Mo	316L	308L

### Martensitic Stainless Steels:

Martensitic stainless steels are difficult to weld successfully due to the formation of hard and brittle martensite in the Heat Affected Zone (HAZ) of the joint. To reduce the affects of martensite formation, adequate control over pre-heat, interpass temperatures and heat input are essential. Depending on the carbon content of the particular martensitic steel, preheat temperatures of between  $100-300^{\circ}\text{C}$  are commonly recommended to avoid cracking. Interpass temperature also plays an important role in reducing the risk of cracking. In multipass welding, an interpass temperature between the martensite start and finish temperatures ( $M_s$  and  $M_f$ ) will minimise crack sensitivity by allowing each subsequent weld pass to be tempered. Post Weld-Heat Treatment (PWHT) is also carried out to improve mechanical properties and reduce welding stresses. For complicated joint configurations PWHT is commenced once the fully welded joint has cooled to just under the martensite start temperature ( $\approx 130-150^{\circ}\text{C}$ ). This is done to ensure the complete transformation of austenite to martensite before PWHT.

## WELDING OF STAINLESS STEEL

## Martensitic Stainless Steel Grades - Welding Consumable Selection Guide.

Stainless Steel Grade			Welding consumable type		
AISI No:	UNS No:	Werkstoffe No:	1st Choice	2nd Choice	3rd Choice
403	S40300	1.4000	410	309L / 309Mo	310
410	S41000	1.4006	410	309L / 309Mo	310
414	S41400	---	410	309L / 309Mo	310
415	S41500	1.4313	410	309L / 309Mo	310
416	S41600	---	410	309L / 309Mo	310
416Se	S41623	---	410	309L / 309Mo	310
420	S42000	---	410	309L / 309Mo	310
431	S43100	1.4057	430	308L / 308	309
440A	S44002	---	312 (Weldall)	309L / 309Mo	---
440B	S44003	---	312 (Weldall)	309L / 309Mo	---
440C	S44004	---	312 (Weldall)	309L / 309Mo	---

## Duplex Stainless Steels:

Duplex stainless steels consist of two microstructure phases, ferrite and austenite and are also referred to as Ferritic-Austenitic stainless steels. A typical duplex microstructure consists of approximately 50% ferrite and 50% austenite.

Duplex stainless steels are readily welded with precautions using all common arc welding processes. Careful attention must be given to heat input and consumable selection to prevent the formation of excessive ferrite levels in both the base metal and weld metal, which can reduce joint toughness and corrosion resistance.

The main grades of duplex stainless steels used in industry today are listed below. These alloys can be classified into two (2) main groups:

Duplex Stainless Steels = S32900 (329), S39205 (2205) and S39230 (2304)

Super Duplex Stainless Steels = S39553, S39275 (2507) and S39276 (Zeron 100).

Welding Consumables for duplex stainless steels contain Nitrogen (a strong austenite stabiliser) as an alloying element, which helps to achieve the correct balance of austenite and ferrite in the weld deposit microstructure. In addition to welding consumable selection, careful attention must also be given to heat input and interpass temperature to promote the desired balance of ferrite and austenite in the weld and surrounding heat affected zone (HAZ) of the base material.

If the base metal and weld metal ferrite levels are controlled to 25-50% (FN 30-70) then a good combination of strength, toughness and corrosion resistance will be achieved in the welded joint.

## Heat Input:

When the weld pool solidifies, the weld metal consists of 100% ferrite which begins to transform to austenite upon cooling. If the correct heat input is used the resultant cooling rate will promote the formation of an even distribution of the ferrite and austenite (=50:50) in the weld deposit and Heat Affected Zone (HAZ).

## WELDING OF STAINLESS STEEL

### Duplex Stainless Steels cont.:

Generally heat input should be limited to between 0.6 - 2.6 kJ/mm. When a welding process with less than 0.6kJ/mm heat input is used (as in automatic GMAW), preheating up to 150°C maximum may be required to reduce the cooling rate and increase austenite in the weld and the HAZ.

$$\text{Heat Input ( kJ/mm )} = \frac{\text{Volts x Amps x 60}}{\text{Travel Speed (mm/min) x 1000}}$$

### Interpass Temperature Control:

Interpass temperature should be limited to between 75-150°C.

### Preheat:

On thicknesses below 6mm no preheat is required. For heavier sections or for welds under high restraint preheat may be used to minimise the risk of weld cracking. When a welding process with less than 0.6kJ/mm heat input is used, preheating to between 50-200°C is helpful in reducing the cooling rate and increasing austenite in the weld and the HAZ. If the air temperature is below 15°C preheat of ≈ 50°C should be used.

### Correct Welding Consumables and Shielding Gas:

Always use the correct welding electrode, wire or rod (refer to the welding consumable selection guide shown below). For GTAW (TIG) welding do not weld without a filler rod unless using the correct nitrogen content shielding gas. Always use an inert (nitrogen containing) backing gas when completing root runs. Consult your local gas supplier for detailed information.

### Duplex Stainless Steel Grades - Welding Consumable Selection Guide.

Duplex stainless steel grade				Welding Consumable Type
Name or No:	UNS No:	Werkstoffe No:	ASTM Specification No:	
329	S32900	1.4460	A240, A789, A790	329
2RE60	S31500	1.4841	A789, A790, A815	2209
2205 Bohler A903	S31803* <b>S39205</b>	1.4462	A182, A240, A276, A789, A790, A815	2209
2304	S32304* <b>S39230</b>	1.4362	A789, A790	2209
Ferrallium# 255	S32550* <b>S39553</b>	1.4507	A240, A789, A790	2507
2507	S32750* <b>S39275</b>	1.4410	A789, A790	2507
Zeron# 100	S32760* <b>S39276</b>	1.4501	A182, A276, A790, A815	2507

\* - old UNS number, replaced by the number beneath in bold.

# - Ferrallium is a trademark of Langley Alloys Ltd. Zeron is a trademark of Weir Material Services Ltd.

## WELDING OF STAINLESS STEEL

### Duplex Stainless Steels cont.:

ASTM Specification No:	Description of Product Types:
A182	Fittings, Valves, Flanges and other items for high temperature service
A240	Plate, strip and sheet for pressure vessels and pressure equipment
A276	Bars and extruded shapes
A789	Tubing, welded and seamless for general work
A790	Pipe, welded and seamless
A815	Pipe fittings, welded and seamless

### Schaeffler and De Long Diagrams:

The alloying elements used in stainless steel base metals and welding consumables have a significant influence on the resultant microstructure. Anton Schaeffler was the first person to carry out a detailed study of the relationship between the composition and microstructure of stainless steel weld metals. The results of this research are summarised in the Schaeffler diagram shown in Diagram 1 which predicts the microstructure of freely cooled All Weld Metal (AWM) stainless steel deposits as a function of Chromium and Nickel Equivalents.

Chromium and Nickel Equivalents for the Schaeffler diagram are calculated as follows:

- Chromium Equivalent = %Cr + %Mo + 1.5 x %Si + 0.5 x %Nb

- Nickel Equivalent = %Ni + 30 x %C + 0.5 x %Mn

Once the Chromium and Nickel equivalent have been calculated the Schaeffler diagram can be used to estimate the microstructural phases present. It should be noted that the Schaeffler diagram is not applicable to the Heat affected Zone (HAZ) of the welded joint nor is it usable for weld deposits which have been heat treated after welding.

The De Long Diagram shown in Diagram 2 is a later development of the central part of the Schaeffler diagram. The De Long diagram works in a similar way to the Schaeffler diagram, however it incorporates nitrogen in the calculation of the Nickel Equivalent which is particularly important for the gas shielded welding processes such as Gas Metal Arc and Gas Tungsten Arc Welding where gas shielding can significantly influence nitrogen pickup in the weld deposit. The De Long diagram also classifies ferrite content as a Ferrite Number (FN) rather than as a percentage.

Once the Chromium and Nickel Equivalents are calculated they can be plotted on the Schaeffler or De Long diagrams to determine the microstructural phases present in the weld deposit. The crack free, austenite - ferrite microstructure of CIGWELD Satincrome 309Mo-17 manual arc electrode is shown as Point D in Diagram 1, calculated from typical AWM chemical analysis. In predicting the microstructural phases present in the weld deposit the Schaeffler diagram is also a guide to potential joint problems such as hot cracking, sigma phase embrittlement, martensitic cracking and brittle grain coarsening. See the shaded regions on the Schaeffler diagram for details.

The Schaeffler diagram is commonly used to predict weld deposit microstructures for the joining of dissimilar metals, given the chemical analyses of both base metals and the welding consumable AWM deposit. For example, the resultant weld deposit microstructure from joining mild steel to 316 austenitic stainless steel using Satincrome 309Mo-17 is shown in Diagram 1.

By explanation:

- Point A on the Schaeffler diagram = microstructure of mild steel base metal.
- Point B on the Schaeffler diagram = microstructure of 316 stainless steel base metal.
- Point C on the Schaeffler diagram = weld deposit microstructure for joining mild steel to 316 stainless steel without a filler metal.
- Point D on Schaeffler diagram = microstructure of AWM deposit with Satincrome 309Mo-17.
- Point E on Schaeffler diagram = microstructure of weld deposit assuming 30% dilution using the manual metal arc welding process.

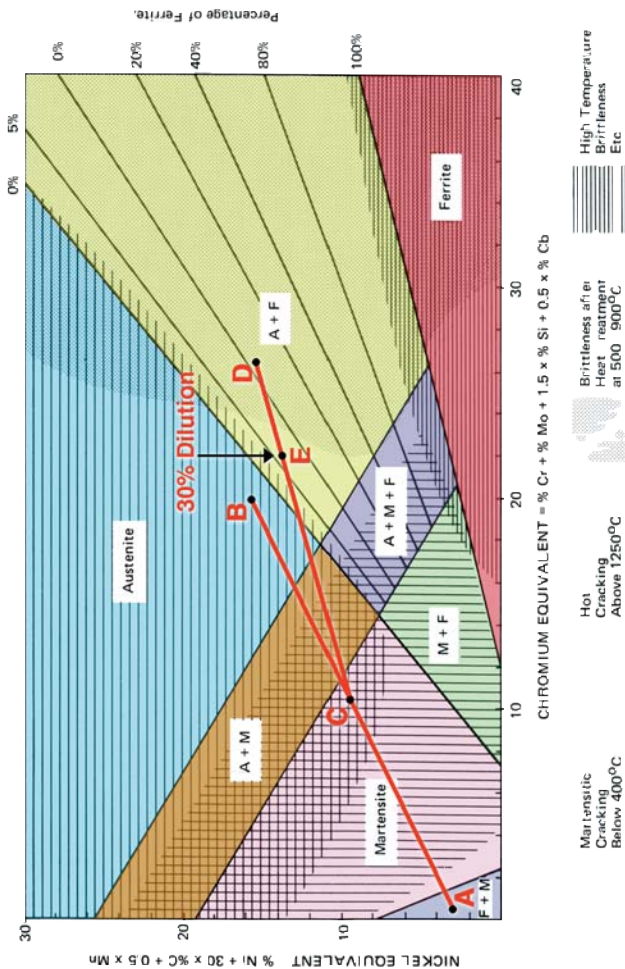

Diagram 1. Schaeffler Diagram. Showing approximate regions of potential weld problems depending on composition and phase balance.

WELDING OF STAINLESS STEEL

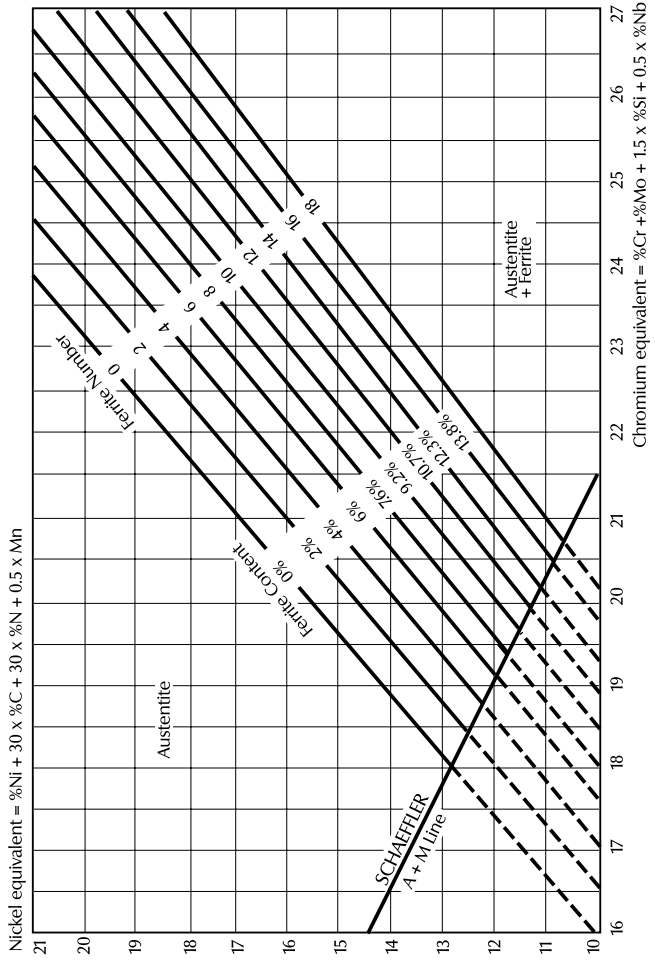

Diagram 2. De Long Diagram.

## WELDING OF STAINLESS STEEL

### Definition of Dilution:

Dilution is the degree to which the base metal(s) contributes to the resultant weld deposit. It is normally expressed as the percentage of melted parent metal in the total weld metal.

i.e. 30% dilution = 30 parts of base material per 100 parts of weld deposit.

The dilution for any given process will always be the same irrespective of the parent metals involved but may be influenced by preheating. It is often assumed that the parent metals each contribute equal parts in the resultant weld.

i.e. 30% dilution = 15% contribution from parent metal 1, + 15% contribution from parent metal 2, see Figure 1 below.

Dilution can be approximately calculated using a geometric approach involving the cross-section of the weld.

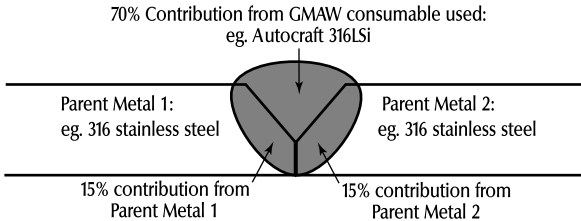

Figure 1. Example of 30% dilution in a stainless steel butt weld using the GMAW process with Autocraft 316LSi welding wire.

### Calculating Dilution:

Dilution can be calculated using the following formula. For the purpose of this example Nickel content will be used since the transfer of nickel from the filler metal to the weld metal is virtually 100%.

$$x = \frac{F - W}{F - P} \times 100$$

x = Percentage Dilution (%)

F = Percentage nickel in the filler metal

W = Percentage nickel in the weld metal

P = Percentage nickel in the parent metal

Therefore, if for example F = 13%, W = 12.7% and P = 12%

$$x = \frac{13 - 12.7}{13 - 12} \times 100 = 0.3 \times 100 = 30\% \text{ dilution}$$

The following values are a guide to typical dilution levels expected in a butt weld:

Welding Process Used	Dilution %
Manual metal arc welding	20-30
Gas Metal Arc Welding & Gas Tungsten Arc Welding	20-40
Submerged-arc welding	30-40



## WELDING OF ALUMINIUM

### 1) "Atmospheric Conditions" Affect on Weld Quality:

Many fabricators experience welding problems at different times of the year. Moisture ( $H_2O$ ) is a prime source of hydrogen. At arc temperatures, water breaks down releasing hydrogen atoms that cause porosity in weldmetal. Shielding gas supplies are controlled to very low moisture content ( $-57^{\circ}C$  dew point or lower). Likewise, the atmospheric conditions in a fabricating facility need to be controlled to prevent moisture condensation from forming on the aluminium welding wire or base metal.

Aluminium which is allowed to repeatedly come into contact with water will eventually form a hydrated oxide (AlOH) coating. Moisture from condensation present on either the welding wire or the base metal can cause two problems during welding:

- ▲ Porosity caused by hydrogen generated from the breakdown of water or from the breakdown of hydrated oxide (AlOH) present on the metal surfaces.
- ▲ Entrapment of the actual oxide (AlOH), present on the metal surfaces, in the weld metal.

#### Terms:

##### Relative Humidity -

The ratio of the quantity of water vapour present in the atmosphere to the quantity which would saturate the air at the existing temperature. Relative humidity is expressed as a percentage number and needs to be monitored in the welding area. Dip tanks, cleaning stations, etc. affect relative humidity.

##### Dew Point -

The temperature at which condensation of water vapour in the air takes place. Moisture will condense on metal surfaces when their temperature is equal to or below the dew point. For each relative humidity percentage, there is a corresponding dew point.

##### Air Temperature -

The temperature of the air in the welding area at any given time.

##### Base Metal or Aluminium Welding Wire Temperature -

The temperature of the welding wire or base metal at any given time.

#### General:

In an aluminium welding shop, the uniformity of air and metal temperatures is important especially when the relative humidity is high. Aluminium welding wires and the base metal should be allowed to stabilise to the weld area temperature. The aluminium welding wire should not be opened in the welding area for 24 hours after entry from a cooler storage area. The base metal should be cleaned and brushed with a clean stainless steel brush prior to welding. CIGWELD recommends mild alkaline solutions and commercial degreasers that do not evolve toxic fumes during welding. Welders should wipe joint edges with a clean cloth dipped in a volatile petroleum based solvent. All surfaces must be thoroughly dried after cleaning.

## WELDING OF ALUMINIUM

### Dew Point Conditions Versus Relative Humidity (RH):

$(T_{air} - T_{metal})^{\circ}$  - Temperature of the air minus the temperature of the metal shown in  $^{\circ}\text{C}$  and  $^{\circ}\text{F}$ .

The chart below shows the relative humidity at which detrimental water condensation will form for a number of given differential temperatures.

\* **Example** - If the relative humidity in the weld area is 70%, the base metal and aluminium welding wire must be no colder than  $5^{\circ}\text{C}$  below the air temperature to prevent moisture condensation.

$(T_{air} - T_{metal})^{\circ}$		RH	$(T_{air} - T_{metal})^{\circ}$		RH
$^{\circ}\text{C}$	$(^{\circ}\text{F})$	%	$^{\circ}\text{C}$	$(^{\circ}\text{F})$	%
0	(0)	100	12	(21.6)	44
1	(1.8)	93	13	(23.4)	41
2	(3.6)	87	14	(25.2)	38
3	(5.4)	81	15	(27.0)	36
4	(7.2)	75	16	(28.8)	34
5*	(9.0*)	70*	18	(32.4)	30
6	(10.8)	66	20	(36.0)	26
7	(12.6)	61	22	(39.6)	23
8	(14.4)	57	24	(43.2)	21
9	(16.2)	53	26	(46.8)	18
10	(18.0)	50	28	(50.4)	16
11	(19.8)	48	30	(54.0)	14

### 2) Aluminium Storage & Preparation for Welding:

One of the most frequently asked questions in the process of welding aluminium is "Should the base metal be cleaned before welding?" To answer this question correctly, one must first determine the finished welded product requirements. If consistent, porosity free, high strength, high quality welds are desired, then the base metal must be thoroughly cleaned using a properly designed and executed procedure. Welding wire quality is a subject of constant concern among designers, engineers, and welders, however, base metal preparation and cleanliness if of equal or even greater importance and is often ignored.

Producers of aluminium sheet, plate, rod, bar, and other fabricated shapes generally ship their products with a protective coating of oil or other hydrocarbon to protect the surface. Depending on storage conditions and storage time, aluminium products are covered with oil, ink, grease, dirt, moisture, and a variable layer of hydrated oxide. These contaminants contain hydrogen and are broken down by the arc during welding, releasing atomic hydrogen which is absorbed by the molten aluminium in the weld puddle. During solidification, this hydrogen comes out of solution and coalesces into bubbles in the aluminium which we see as porosity.

The general melting temperature of aluminium alloys is around  $650^{\circ}\text{C}$  ( $1200^{\circ}\text{F}$ ) while the melting temperature of aluminium oxides is  $2040^{\circ}\text{C}$  ( $3700^{\circ}\text{F}$ ). Aluminium oxide is not melted during the welding process and if it is present to an excessive degree, it can easily cause lack of fusion and oxide inclusion type defects.

## WELDING OF ALUMINIUM

With this in mind, CIGWELD suggest the following guidelines for the proper storage, joint preparation, cleaning, and welding of aluminium be adhered to:

### Storage and Handling:

#### Base Metal:

- ▲ Position base metal vertically and space apart to provide for air circulation and minimise condensation contact points.
- ▲ Store inside, preferably in a heated room with as constant a temperature as possible. Humidity control is also desirable, if it can be achieved.

#### Aluminium Welding Wires:

- ▲ Store in a heated room with uniform temperature control and, if possible, with humidity control as well.
- ▲ Hold the Aluminium Welding Wire in the welding area for 24 hours before unpacking to allow its temperature to equalise with that of the surrounding area.
- ▲ Store unpacked material in a heated cabinet.
- ▲ Use dust covers on all welding equipment.

### Joint Preparation:

#### Oxy-fuel Gas Cutting:

- ▲ Not recommended for aluminium because it leaves a large heat affected zone with harmful eutectic melting and heavy oxide films.

#### Carbon Arc Cutting, Bevelling, and Gouging:

- ▲ Not widely recommended or used for the same reasons as gas cutting. If it is used, it requires heavy mechanical surface removal before welding.

#### Plasma Arc Cutting, Bevelling, and Gouging:

- ▲ This process is commercially used but has some limitations and must be carefully controlled. If it is used, it requires the power source to be set on DCEN along with the use of a small orifice to gain high velocity and concentrated heat. Heat affected zones will be crack prone particularly for 2XXX, 6XXX, and 7XXX series alloys and will require 3mm or more of mechanical surface removal before welding. Series 1XXX, 3XXX, and 5XXX alloys are not as crack prone and can generally be welded as cut by this process.

#### Mechanical Machining:

- ▲ Drilling, gouging, filing, milling, or router-type cutting produce the best surface for welding. Lubricants or coolants must not be used and tools should be sharp to avoid metal smearing.

## WELDING OF ALUMINIUM

### Joint Preparation cont.:

#### Sawing:

- ▲ Blade speed:
  - Circular high-speed steel (8,000 fpm)
  - Circular carbide (12,000 fpm)
  - Band saw (5,000 fpm)
- ▲ Tooth shape and spacing:
  - Circular (std. Spacing, high rake angle)
  - Band (3 to 4 teeth per inch)
- ▲ Lubricants or coolants must not be used and band saw surfaces should be removed by filing prior to welding.

#### Grinding:

- ▲ Wheel grinding is not recommended since it smears the surface of aluminium and can deposit organic binders from the wheel during grinding.
- ▲ Disc grinding can be used with grit size, 30 to 50 preferred, and speeds of 4,000 to 6,000 fpm. Only flexible discs should be used and grinding pressures should be moderate to prevent surface heating or smearing of the aluminium. Lubricants or coolants must not be used.

### Base Metal Cleaning:

#### Moisture:

- ▲ Minute traces of moisture on aluminium can produce severe weld porosity. Both the welding wire and the base metal should be brought into the welding area 24 hours in advance to allow all material temperatures to equalise. A dew point test should be done prior to welding. If pre-heating must be used, heat no higher than 65°C (150°F) and remember that oxy-fuel flames produce water as a by-product of combustion.

#### Lubricants:

- ▲ Before oxides can be removed from aluminium, the base metal must be degreased. This is best done with a solvent. Toluene is the best general solvent for this purpose. Acetone is a poor solvent for oils and greases and is less effective than toluene. Chlorinated solvents are also good degreasers but are not recommended for this application because they present environmental problems and their vapours can decompose into toxic or poisonous gases in the presence of heat. Weld joints should be washed with solvent prior to assembly and wiped dry using clean cloth such as cheese cloth. Shop rags should not be used since they contain soaps and other organic compounds from the washing and conditioning processes used to treat them. Do not use compressed air to blow off or dry solvent cleaned areas since it often contains moisture and oil.

## WELDING OF ALUMINIUM

## Base Metal Cleaning cont.:

Oxides:

## ▲ Wire Brushing:

Oxide removal must be done after degreasing and is best done with a stainless steel wire brush. Wire brushes must be frequently cleaned with the same solvent as the base metal. Wire brushing can be done by hand or with a power brush. If power is used, keep rpm's and pressures low to avoid heating and smearing the surface metal. Compressed air power brushes should exhaust their air to the rear, not forward towards the brush where the compressed air can contaminate the base metal.

## ▲ Chemical Cleaning:

Chemical cleaning deoxidises and etches the aluminium. These cleaners contain acids and can present problems in handling and disposal. If they are used, the base metal must be thoroughly rinsed and dried and should be milled or wire brushed prior to welding.

## ▲ Etch Cleaning:

This process uses a hot sodium hydroxide etch and nitric acid rinse. It effectively removes heavy oxides, rough machined, sawn or smeared surfaces and hydrocarbons. However, the process leaves a porous surface containing hydrated oxides that absorb moisture during storage faster than an as-fabricated mill surface. This surface should be milled or wire brushed prior to welding.

## 3) Feedability of Aluminium Welding Wire:

Performance of GMAW equipment used for welding aluminium significantly affects welding wire feedability. Arcing or burn-backs are often the result of deficiencies in accessory equipment. Such deficiencies can be attributed to improper combinations of accessories, poor care or lack of preventive maintenance. Correcting these deficiencies often improves welding wire feedability markedly. Shown below are important accessory components, each of which is CIGWELD'S' recommended equipment for aluminium GMA Welding.

Hints on Feedability:

- a) always use the correct size contact tip, or for heavy current work use a tip size 10-15% larger. eg. diameter of the wire 1.2mm = 1.3mm tip. Where possible use longer contact tips for better current pickup.

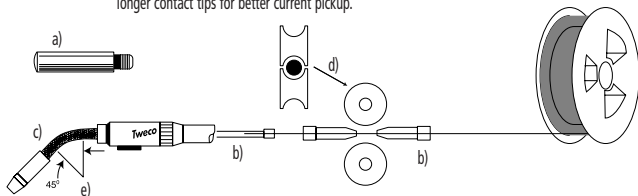

- b) always use where possible, nylon, conduits and inlet and outlet guides. Clean brass inlet and outlet guides are 2nd choice.

## WELDING OF ALUMINIUM

### 3) Feedability of Aluminium Welding Wire cont.:

- Hints on Feedability:**
- use a copper jump liner in the conductor tube (goose neck).
  - always use U-Groove drive rolls.
  - where possible use 45° or straight barrelled conductor tube.
  - keep MIG guns as short as possible (3 metre) when using push type wire feeders.
  - use push pull MIG guns & equipment when welding over longer distances.

**Drive Rolls:**

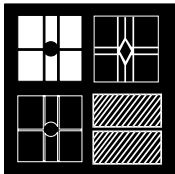

Always use U-Groove drive rolls. Other types distort or shave wire causing more burn backs. Ensure that the U-groove drive roll edges are chamfered, not sharp...The white coloured picture shows the correct drive roll type.

**Dust Covers and Wire Storage:**

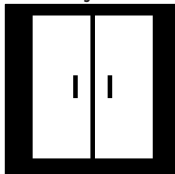

Using dust covers and periodically cleaning the dust and dirt from the liner increases service life. Proper storage is also important in reducing contamination. CIGWELD recommends that aluminium welding wires be stored in a controlled atmosphere below thirty percent relative humidity (30%RH), preferably a temperature and humidity controlled cabinet. Packages containing aluminium welding wire should never be in unheated buildings. Aluminium welding wire should never be left on equipment overnight unless protective means are added to the welding machine, such as fully enclosed temperature controlled wire feeders (resistance heater inside the feeder), temperature and humidity controlled workshops, etc.

**Proper Alignment of Drive Rolls:**

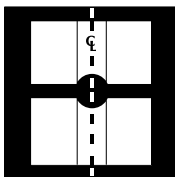

Centre line, misaligned drive rolls will distort the welding wire and cause serious feedability problems. Check your wire feeder for drive roll alignment after each size change of feed rolls. CIGWELD can supply U-groove rollers for most of the TRANSMIG range.

**Drive Roll Pressure:**

In addition to proper U-type drive roll contours, correct drive roll pressure must be maintained. Excessive drive roll pressure distorts the welding wire increasing frictional drag through the liner and contact tip.

The correct drive pressure can normally be obtained by following these steps;

- lower the pressure roller down onto the aluminium wire, making sure that all pressure has been backed off.
- pull the trigger of the MIG gun and slowly wind the pressure roller down until the welding wire starts to feed through the entire length of the MIG gun.
- once the welding wire has passed through the contact tip, wind the pressure roller down another 1 - 2 turns.

## WELDING OF ALUMINIUM

### 3) Feedability of Aluminium Welding Wire cont.:

#### Contact Tips:

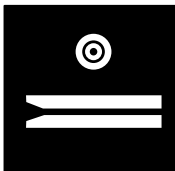

Correct I.D. of the contact tip is of paramount importance. If there is too much clearance between the welding wire and the contact tip, arcing will occur. Continuous arcing causes a build up of particles on the I.D. surface of the tip which increases drag forces and produces burn-backs due to unsteady feed. ▲ Changing contact tips when unsteady feeding is noted eg. pulsing or spiralling of the welding wire, also improves overall performance. ▲ Always use the correct size contact tip, or for heavy current work use a tip size 10-15% larger. eg. diameter of the wire 1.2mm = 1.3mm. Where possible use longer contact tips for better current pickup. ▲ Do not use bent, damaged or crimped contact tips. ▲ Never redrill the I.D. of a genuine Tweco tip as this will soften the tip and cause poor current pick up and severely reduce the tips working life.

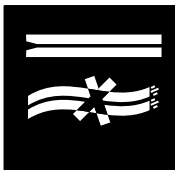

#### Inlet and outlet guides:

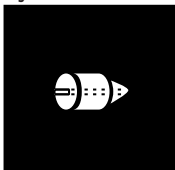

Where possible use, nylon inlet and outlet guides. New, clean brass inlet and outlet guides may be used on aluminium wires but are 2nd choice.

#### Proper nozzle & contact tip relationship:

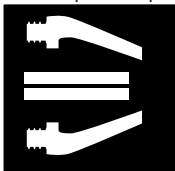

The contact tip should be recessed from the edge of the gas shielding nozzle by approximately 1.6mm for lower amperage and voltage settings and up to 5mm for higher settings.

#### Conduits (liners):



Properly sized flexible conduits with nylon, or plastic liners improves the feeding of aluminium welding wire through long distances by avoiding abrasion of the welding wire. Smooth feeding is also assured by non-metallic connection fittings. Clear total length of the conduit after a burn back.

## WELDING OF ALUMINIUM

### 3) Feedability of Aluminium Welding Wire cont.:

#### Conductor Tubes:

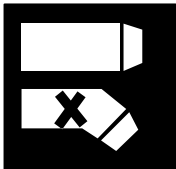

Conductor Tubes (goose necks) are a critical component for successful aluminium welding. CIGWELD recommends the use of either 45° or Straight barrelled conductor tubes. The straighter the tube the better the wire feed. 60° conductor tubes are not recommended. It is advisable to use a copper jump liner throughout the length of the conductor tube, which will aid in current pick up. The copper jump liner replaces the nylon liner between the end of the handle and the gas diffuser.

#### Water and Inert Gas Leaks:



Check for water and inert gas leaks as these can be a major cause of porosity. Do not interchange water and inert gas lines. Never use old oxy / acetylene hoses for inlet gas lines.

#### Achieving High Quality Welds:

Although welding equipment is sturdy, the abuses of day-to-day work makes regular maintenance a necessity. Faulty or improperly maintained welding equipment can result in poor welding work. Nevertheless, with proper selection of welding parameters, correct equipment and accessories, an effective program of preventive maintenance and the purchase of CIGWELD aluminium welding wires, high quality welds are attainable.

### 4) Smoke Testing Aluminium Welding Wire for Surface Contamination:

#### What Contributes to Weld Porosity?

Weld porosity results from the entrapment of hydrogen gas. This gas entrapment results in lower weld strength and ductility by reducing the cross sectional area of sound metal and by acting as stress risers which cause premature failure. Several variables can produce gas porosity, one of which is the surface condition of the aluminium filler wire. The qualities relating to the surface characteristics of the filler wire include:

1. The removal of surface oxides (hydrated oxides).
2. The absence of any water or water vapour.
3. The removal of hydrogen-containing compounds (hydrocarbons).

Of these three surface conditions, the most common cause of weld porosity is the presence of hydrocarbons. Examples of these compounds include residual wire drawing lubricants, mill dirt or even fingerprints. One relatively quick and inexpensive method of testing aluminium welding wire for freedom from residual hydrocarbons is by means of a "Smoke Test".

#### What is a Smoke Test?

The "Smoke Test" is a qualitative test performed by heating a sample of wire using an electrical resistance heating machine. While conducting the test, the wire is visually examined for the presence of smoke, caused by the burning of any surface contamination. Minute amounts of contamination, even a fingerprint, will result in smoke.



## WELDING OF ALUMINIUM

The schematic shows a typical smoke tester machine. Just about any commercial welding power source will suffice. The weld cables are connected to two hobby vices. The wire sample completes the circuit. A light with a dark viewing background is recommended to aid in observing any smoke as the test is performed. Care must be taken in selecting and placing the sample in the vice grips so that the wire does not come in contact with any contamination, including human hands.

### 4) Smoke Testing Aluminium Welding Wire for Surface Contamination:

**CAUTION: Do not touch the wire after testing since it becomes extremely hot.**

Typical amperages settings based upon the alloy and diameter of the sample to be tested are listed below. The amperage is chosen to control the melt rate of the sample and allow adequate time to detect the presence of any smoke. The amperage should be sufficient to melt the sample in 3 to 5 seconds.

Smoke Testing Apparatus:

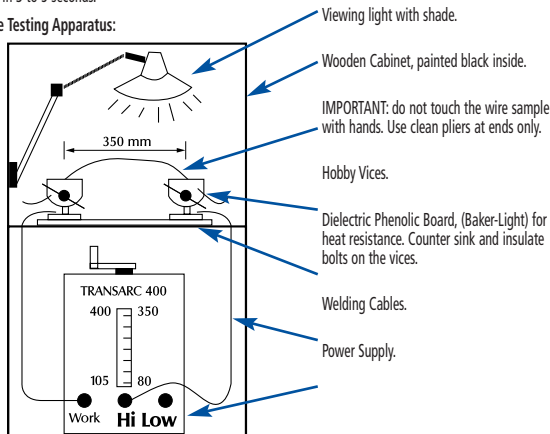

Suggested Amperage Settings By Alloy Series

Sizes (mm)	1XXX 2319	4XXX, C355 A356 & A357	5XXX
0.8	45	40	40
0.9	50	50	50
1.0	60	60	60
1.2	90	90	70
1.6	140	120	120
2.4	225	225	225

**What Can I Interpret From the Smoke Test?**

A direct correlation exists between smoke test results and weld porosity. Zero smoke should indicate minimal weld porosity. A small amount of smoke will indicate some evidence of weld porosity generated by contamination. A large amount of smoke will indicate severe contamination and the filler wire should be further examined before continuing production welding.

## WELDING OF ALUMINIUM

### 5) Arc Length & Heat (volts x amps) the Affect on Weld Bead Characteristics:

The visual characteristics and mechanical properties of aluminium welds are controlled by weld bead penetration and shape. A number of variables affect the end properties of the weld bead and they can be controlled by the welder. Presented here is a description of those variables and how they can be used to achieve the desired end results.

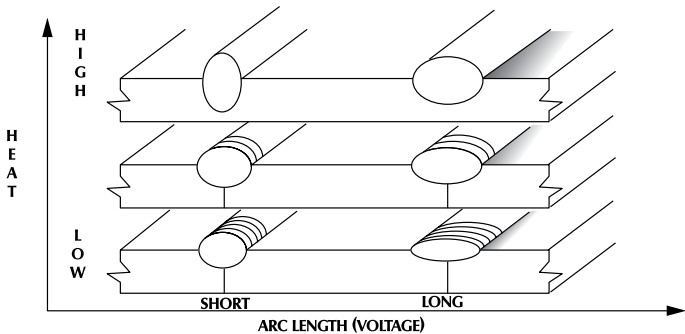

Note: Because 5XXX series alloys conduct heat significantly less than 4XXX series alloys, shorter arc lengths are required for desired penetration.

Characteristics	Short Arc	Long Arc
Penetration	Deep	Shallow
Weld Width	Narrow	Wide
Weld Height	High	Flatter
Molten Pool Surface	Depressed	Flat
Spatter	Less	More
Arc Noise	Crackling	Humming
Porosity - Surface	More	Less
Characteristics	High Heat	Low Heat
Penetration	Deep	Shallow
Surface	Smooth	Rippled
Smut (soot)	More	Less
Porosity - Root	Less	More
Recommendations		
Root Pass	Shorter Arc	-
Finish Pass	-	Longer Arc
5XXX Alloys	Shorter Arc Lower Arc Voltage Higher Amperage	- - -
4XXX Alloys	-	Longer Arc Higher Arc Voltage Lower Amperage

## WELDING OF ALUMINIUM

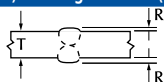

## 5) Arc Length &amp; Heat (volts x amps) the Affect on Weld Bead Characteristics cont.

 CONVEXITY CONTROL  
 SPECIFICATION (USA only)

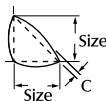
T	R (max)
up to 10mm	2.4mm
10mm to 20mm	3.2mm
20mm +	5.0mm

 CONVEXITY CONTROL  
 SPECIFICATION (USA only)

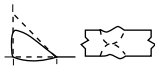
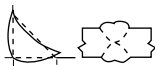
 C (max)  
 .07 x face width, plus 1.5mm

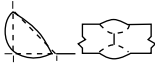
	Problem	Solution
	<b>Excessive Convexity</b> Reduced fatigue strength	Increase arc length <sup>1</sup> Increase torch angle
	<b>Insufficient Throat or Leg</b> Reduced mechanical properties	Change torch angle Change torch position <sup>2</sup> Decrease arc length <sup>1</sup>
	<b>Insufficient Throat</b> Reduced mechanical properties	Reduce cooling rate Increase wire feed speed Decrease travel speed Decrease arc length <sup>1</sup>
	<b>Undercut</b> Reduced mechanical properties	Change torch position to compensate for: - Dissimilar section sizes - Dissimilar thermal conductivity
	<b>Overlap</b> Severe reduction in fatigue strength	Increase welding heat Decrease traverse speed
	<b>Incomplete penetration</b> Reduced weld strength and increased sensitivity to crack propagation	Increase heat Decrease arc length <sup>1</sup> Decrease traverse speed Decrease torch forehead angle

- Notes:
- Remember, when changing arc length, arc voltage is changed which also requires a change in arc amperage if constant heat is to be maintained. Watts (heat) = volts x amps
  - For example, the thermal conductivity of 5083 is 32% less than 6061 because of higher magnesium content. This requires more heat input into the 6061 alloy.

## WELDING OF ALUMINIUM

## 6) Aluminium Welding Problems, Causes and Corrections:

Problem	Causes	Corrections
Porosity	Turbulence of weld pool	Increase welding current to stabilise transfer of metal droplets.
	Hydrogen from hydrated oxide film or oil on wire, base metal, drive rolls & liner.	Keep wire covered. Store wire in a low humidity chamber at a constant temperature. Clean base metal of oil and oxide immediately prior to welding.
	Wet or contaminated shielding gas or inadequate flow. Fast cooling rate of weld pool.	Reject bottles above -57°C dew point. Increase flow rate. Shield from air currents. Use higher welding current and/or a slower speed. Preheat base metal.
Weld Cracking	Improper choice of aluminium welding wire or rod.	Select welding wires with lower melting and solidification temperatures, refer to "W" category of the "Aluminium Alloy Selection Chart".
	Critical chemistry range.	Avoid weld pool chemistry of 0.5 to 2.0% silicon and 1.0 to 3.0% magnesium. Avoid MgSi eutectic problems (5xxx welded with 4xxx).
	Inadequate edge preparation or spacing.	Reduce base metal dilution of weld through increased bevel angle and spacing.
	Incorrect weld technique.	Clamp to minimise stress. Narrow heat zone by increased traverse speed. Produce Convex rather than Concave bead. Minimise super heated molten metal, to control grain size. Proper weld size - not too small. Preheat base metal.
Burn-back or irregular wire feed	Fast run-in wire feed.	Slow run-in wire feed for CV power supply to reduce current surge and arcing in contact tip.
	Insufficient wire feed.	Increase wire feed for CC dropper power supply and reduce arc voltage on CV power supply.
	Electrode too soft, kinked or not level layer wound.	Talk to your local CIGWELD or THERMADYNE Branch Office.
	Flexible conduit too long or kinked.	Cut down or Replace.
	Worn or dirty liner or conduit.	Replace.
	Spatter on end of or eroded interior of the Gas Nozzle.	Replace gas nozzle.
	Aluminium fillings in liner or conductor tube and contact tip, resulting in arcing	Align drive rolls, align the centerline of the drive rolls with the outlet guide, use "U" grooved feed rollers, use only enough feed pressure to prevent slippage.
	Arcing in the Contact Tip	Match contact tip size to wire (or 10-15% above).

## WELDING OF ALUMINIUM

## 6) Aluminium Welding Problems, Causes and Corrections:

Problem	Causes	Corrections
Poor arc starting	Improper grounding.	Reconnect ground (earth).
	Anodic coating.	Remove anodic coating.
	No shielding gas.	Pre-purge gas shield.
	Wrong polarity.	Change polarity.
Dirty welds	Inadequate gas coverage.	Increase gas flow. Shield arc from drafts. Hold gas nozzle closer to work. Replace damaged gas nozzle. Centre contact tip in gas nozzle. Decrease gun angle. Check gun and leads for air or water leaks.
	Dirty filler wire.	Keep aluminium wire covered when spool is mounted on machine.
	Dirty parent material.	Degrease with toluene, varsol or mineral spirits, etc. to remove oil or grease from joint area. Stainless steel brush to remove other foreign matter from joint area.
	Heavy oxide film or water stain on parent material.	Clean joint area with disc sander, heavy stainless steel brushing or etch.
Unstable arc	Poor electrical connections.	Check electrical connections.
	Dirt in joint area.	Remove all oil, grease, cutting compounds, paints and caulking from joint areas.
	Arc blow.	Do not weld in area of strong magnetic field. Arrange ground clamp to neutralise magnetic field.

## WELDING OF ALUMINIUM

## 6) Aluminium Welding Problems, Causes and Corrections: Cont.

Weld bead excessively wide	Welding current too high. Arc travel speed too low. Too long an arc.	Change welding parameters.
Inadequate penetration and incomplete fusion in welds	Insufficient welding current.	Increase weld current.
	Arc travel speed too high.	Reduce arc travel speed.
	Too long an arc.	Decrease arc length through increased wire feed speed.
	Dirty parent metal.	Degrease with toluene, varsol or mineral spirits, etc to remove oil or grease from joint area. Stainless steel brush to remove other foreign matter from joint area.
	Inadequate joint spacing or edge preparation.	Redesign joint.
	Oxide on base metal.	Clean joint area with disc sander, heavy stainless steel brushing or etch.
	Insufficient depth or improper shape of the back-gouge.	Increase depth of back gouge, U-type preferred over V-type.
Mismatch of colour after anodising	Fillet or vee grooves - torch oscillation with CV power supply.	Weld with straight stringer passes without torch manipulation. Switch to CC dropper power supply.
	Improper alloy selection.	Match colour selection in "Aluminium Alloy Selection Chart".  Avoid 4xxx and 6xxx match; use 5xxx filler wire with 5xxx and 6xxx base alloys.

## ALUMINIUM ALLOY SELECTION CHART

Base Alloys	1070, 1080, 1060, 1350	1100	2014, 2036	2219	3303, ALCLAD 3003	3004	ALCLAD 3004	5005, 5050	5052, 5652
Characteristics	WSDCTM	WSDCTM	WSDCTM	WSDCTM	WSDCTM	WSDCTM	WSDCTM	WSDCTM	WSDCTM
Filler Alloys									
319.0, 333.0, 354.0, 355.0, C355.0, 380.0	2319 4043 4145	- BAAAA ABAAAA	- BAAAA ABAAAA	BAAAA CBCAA ABCBA	BAAAA CCBCAA ABCBA	BAAAA ABAAA	BAAAA ABAAA	BAAAA ABAAA	BAAAA ABAAA
413.0, 443.0, 444.0, 356.0, A356.0, A357.0, A359.0	4043 4145 A356.0 A357.0 5356	AAAAA ABBA -	AAAAA ABBA -	BAAAA ABAA -	BAAAA ABAA -	AAAAA ABBA -	AAAAA ABBA -	AAAAA ABBA -	ABAAAA -
7005, 7021, 7039, 7046, 7146, 710.0, 7110.0	4043 4145 5183 5356 5554 5556 5654	AACAA BABA-A BAAA-A -	AACAA BABA-A BAAA-A -	BBAAA ABAA -	BBAAA ABAA -	ABCAA BABA-A BAAA-A -	ADCBA BABA-A BAAA-A CCAAA BABA-A CCAA-B	ADCBA BABA-A BAAA-A CCAAA BABA-A CCAA-B	ABCA BABA-A BAAA-A CAAAA BABA-A CAAA-A
6061, 6070	4043 4145 4643* 5183 5356 5554 5556 5654	AACAA AADBA -	-ACAA AADBA -	BBAAA AABAA -	BBAAA AABAA -	ABCAA AADBA -	ADCBA BCDBA -	ADCBA BCDBA -	ABCAA ABDBA -
6005, 6063,	4043 4145 4643* 5183 5356 5554 5556 5654	AACAA AADBA -	AACAA AADBA -	BBAAA AABAA -	BBAAA AABAA -	ABCAA AADBA -	ADCBA BCDBA -	ADCBA BCDBA -	ABCAA ABDBA -
6101, 6151, 6201, 6351, 6951	4043 4145 5183 5356 5554 5556 5654	BAB-A BAA-A -	BAB-A BAA-A -	- -	- -	BAB-A BAA-A -	BAB-A BBA-A -	BAB-A BBA-A -	BAB-A BAA-A -
5454	4043 5183 5356 5554 5556 5654	ABCCA BABB-A BAAB-A CAAAAA BABB-A	ABCCA BABB-A BAAB-A CAAAAA BABB-A	- -	AAAA -	ABCCA BABB-A BAAB-A CAAAAA BABB-A	ADCCA BABB-A BBAB-A CCAAA BABB-A	ADCCA BABB-A BBAB-A CCAAA BABB-A	ABCCA BABB-A BAAB-A CAAAAA BABB-A
511.0, 512.0, 513.0, 514.0, 535.0, 5154, 5254	4043 5183 5356 5554 5556 5654	ABCC BABB-A BAAB-A CAAA-A BABB-A CAAB-B	ABCC BABB-A BAAB-A CAAA-A BABB-A CAAB-B	- -	AAAA -	ABCC BABB-A BAAB-A CAAA-A BABB-A CAAB-B	ADCC BABB-A BBAB-A CCAA-B CCAA-B	ADCC BABB-A BBAB-A CCAA-B CCAA-B	ABCC BABB-A BAAB-A CAAA-A BABB-A CAAB-B
5086, 5056	4043 5183 5356 5554 5556 5654	ABCB AABA-A AAAA-A -	ABCB AABA-A AAAA-A -	- -	AAAA -	ABCB AABA-A AAAA-A -	ACCB AABA-A AAAA-A -	ACCB AABA-A AAAA-A -	ABCB AABA-A AAAA-A CAAA-A AABA-A BCAA-B
5083, 5456	4043 5183 5356 5554 5556 5654	ABCB AABA-A AAAA-A -	ABCB AABA-A AAAA-A -	- -	AAAA -	ABCB AABA-A AAAA-A -	ACCB AABA-A AAAA-A -	ACCB AABA-A AAAA-A -	ABCB AABA-A AAAA-A CAAA-A AABA-A BCAA-B
5052, 5652	4043 5183 5356 5554 5556 5654	ABCAA BAB-A BAA-A -	ABCAA BAA-A BAA-A -	AAAAA -	AAAAA -	ABCAA BAB-A BAA-A -	ABCAA BAB-A BAA-A -	ACCAA BAB-A BBA-A -	ABCAA BAB-A BAA-A -
5005, 5050	1100 4043 4145 5183 5356 5556	CBAAAA AACAA BADBA CAB-B CAB-B CAB-B	CBAAAA AACAA BADBA CAB-B CAB-B CAB-B	BBAAA AABAA -	BBAAA AABAA -	CCAAAA ABCAA BBDBA CBBCA CABC-B CABC-B	ABCAA BBAAB BAB-A BAA-A BAB-A	ABCAA BBAAB BAB-A BAA-A BAB-A	B-AAAA ABDAA -
ALCLAD 3004	1100 4043 4145 5183 5356 5554 5556	DBAAAA AACAA BADBA CAB-B CAB-B CAB-B	DBAAAA AACAA BADBA CAB-B CAB-B CAB-B	BBAAA AADAA -	BBAAA AADAA -	CCAAAA ABCAA BBDBA CBBCA CABC-A CABC-A	ADDA BACC-A BBBC-A CCABAA BACC-A	ADDA BACC-A BBBC-A CCABAA BACC-A	- -
3004	1100 4043 4145 5183 5356 5554 5556	DBAAAA AACAA BADBA CAB-B CAB-B CAB-B	DBAAAA AACAA BADBA CAB-B CAB-B CAB-B	BBAAA AABAA -	BBAAA AABAA -	CCAAAA ABCAA BBDBA C-BC-A CABC-A C-BC-A	ABDAA BACC-A BBBC-A CCABAA BACC-A	- -	- -
3003 ALCLAD 3003	1100 4043 4145	BBAAAA ABAAA AACBA	BBAAAA ABAAA AACBA	BAAAA AABAA	BAAAA AABAA	BBAAAA AABAA AACBA	- -	- -	- -
2219	2319 4043 4145	BAAAA ABAAA	BAAAA ABAAA	BAAAA BCBCA ABCBA	BAAAA BCBCA ABCBA	BAAAA AABAAA ABCBA	- -	- -	- -
2214, 2036	2319 4043 4145	BAAAA ABAAA	BAAAA ABAAA	CAAAAA BCBCA ABCBA	- -	- -	- -	- -	- -
1100	1100 4043 5356	BBAAAA ABAAA	BBAAAA ABAAA	- -	- -	- -	- -	- -	- -
1060, 1350, 1070, 1080	1100 1188 4043	BBAAB CCAAAA ABAAA	- -	- -	- -	- -	- -	- -	- -







## WELDING OF ALUMINIUM

### 1) Aluminium Base Metals

Aluminium Alloys can be broken up in to the following groups:

Group A - Cast Alloys

Group B - Wrought Alloys

#### Group A - Cast Alloy System

SERIES No.	MAJOR ALLOY ELEMENTS
100	99% Pure
*200	Copper
*300	Copper & Silicon
400	Silicon
500	Magnesium
*600	Magnesium & Silicon
*700	Zinc
800	Tin

#### Group B - Wrought Alloy System

SERIES No.	MAJOR ALLOY ELEMENTS
1000	99% Pure
*2000	Copper
3000	Manganese
4000	Silicon
5000	Magnesium
*6000	Magnesium & Silicon
*7000	Zinc

\* NB: These alloys are heat-treatable.

Cast aluminium alloys generally contain a higher percentage of alloying elements than wrought alloys.

The higher additions of alloys greatly improve casting qualities, but make machining and working more difficult.

### The Different Groups (Features)

- ▲ 100/1000 Series: contain 99% AL or greater (iron and silicon are the major impurities).
  - excellent surface finish, high thermal and electrical conductivity and excellent corrosion resistance.
  - excellent weldability.
  - uses: electrical conductors, architectural items and containers.
- ▲ 200/2000 Series: contain copper as a major alloying element.
  - limited corrosion resistance, a high strength to weight ratio and superior machinability.
  - very poor weldability.
  - uses: forgings, heavy duty structural work.
- ▲ 300 Series: containing copper and silicon have almost replaced the original 200/2000 series due to better casting characteristics, the other features are the same.
- ▲ 3000 Series contains manganese which provides approximately 20% more strength than the 100/1000 series. This series has good ductility and retains workability.
  - good weldability.
  - uses: cooking utensils, sheets and panels which are used on storage tanks.

## WELDING OF ALUMINIUM

### The Different Groups (Features) cont.

- ▲ 400/4000 Series: contains silicon as the major alloying element which aids in the metals fluidity and improves strength and machinability. The silicon lowers the melting point and makes the 400 alloys one of the best for casting.
  - good to excellent weldability.
  - uses: welding wires, castings, decorative gate castings and sheet.
  
- ▲ 500/5000 Series: contains magnesium as the major alloying element. The alloys in the group are widely used due to their excellent mechanical properties, high corrosion resistance and excellent anodising characteristics.
  - 500 series are difficult to cast.
  - good to excellent weldability.
  - uses: sheet, plate, angles etc, widely used in the shipping and marine industries, and also in general fabrication.
  
- ▲ 600/6000 Series: contain silicon and magnesium making these alloys heat treatable, which allows the mechanical properties to be improved considerably by heat treatment after forming.
  - high resistance to corrosion and ease of machining, plus high strength.
  - good weldability.
  - uses: transportation equipment, engineering structures, bridges etc.
  
- ▲ 700/7000 Series: contains zinc which helps to give these alloys very good impact resistance, high strength and excellent ductility.
  - not recommended for welding.
  - uses: aircraft structures and mobile equipment.
  
- ▲ 800 Series: tin is the principal alloy in the group, its chief purpose being to improve anti-friction characteristics in bearing alloys. These alloys have a high resistance to corrosion by engine oils.
  - poor weldability.

### GTAW Welding Consumables for Aluminium and Aluminium Alloys:

The CIGWELD/Comweld range

- \* Comweld AL1100
- \* Comweld AL4043
- \* Comweld AL4047
- \* Comweld AL5356

- see product information in the front of this Pocket Guide or the CIGWELD Welding Consumables Technical Reference Manual.

## WELDING OF ALUMINIUM

## Filler Metals to AS 1167.2/AWS A5.10

ALUMINIUM ALLOYS		CONSUMABLE (Filler Rod) TYPE		
CAST	WROUGHT	AS1167.2	AWSA5.10	CIGWELD PRODUCT
AP150	1100	R1100	R1100	Comweld AL1100 (Pure Aluminium)
AP170	1200	R1100	R1100	Comweld AL1100 (Pure Aluminium)
AP185	3003	R1100	R1100	Comweld AL1100 (Pure Aluminium)
	3203	R1100	R1100	Comweld AL1100 (Pure Aluminium)
AP403	3004	R4043	R4043	Comweld AL4043 (Aluminium 5% Silicon)
AP601	5005	R4043	R4043	Comweld AL4043 (Aluminium 5% Silicon)
BP601	5050A	R4043	R4043	Comweld AL4043 (Aluminium 5% Silicon)
CP601	6061	R4043	R4043	Comweld AL4043 (Aluminium 5% Silicon)
AS601	6063	R4043	R4043	Comweld AL4043 (Aluminium 5% Silicon)
AP603	6351	R4043	R4043	Comweld AL4043 (Aluminium 5% Silicon)
AP501	5052	R5356	R5356	Comweld AL5356 (Aluminium 5% Magnesium)
AP701	5083	R5356	R5356	Comweld AL5356 (Aluminium 5% Magnesium)
AP703	5086	R5356	R5356	Comweld AL5356 (Aluminium 5% Magnesium)
	5154A	R5356	R5356	Comweld AL5356 (Aluminium 5% Magnesium)
	5251	R5356	R5356	Comweld AL5356 (Aluminium 5% Magnesium)
	5454	R5356	R5356	Comweld AL5356 (Aluminium 5% Magnesium)
	7005	R5356	R5356	Comweld AL5356 (Aluminium 5% Magnesium)
BP401		R4047	R4047	Comweld AL4047 (Aluminium 10% Silicon)
CP401		R4047	R4047	Comweld AL4047 (Aluminium 10% Silicon)
AP303		R4047	R4047	Comweld AL4047 (Aluminium 10% Silicon)
AS303		R4047	R4047	Comweld AL4047 (Aluminium 10% Silicon)
AP309		R4047	R4047	Comweld AL4047 (Aluminium 10% Silicon)

AWS A5.10-92 Specification for Bare Aluminium and Aluminium Welding Electrodes and Rods.

## 2) Tungsten Electrodes

Pure, Zirconiated, and Ceriated are the recommended tungsten welding electrodes for use in A.C. welding. Thoriated welding electrodes are generally reserved for D.C. welding of products such as low alloy steels and stainless steels. Thoriated tungsten will handle a higher current than pure tungsten, although it does not retain the balled shape required for A.C. welding of aluminium.

Pure Tungsten Electrodes:

Pure Tungsten welding electrodes are not often recommended or used for A.C. welding on aluminium and magnesium alloys as Zirconiated, and Ceriated electrodes have gained popularity in recent years. Pure Tungsten electrodes contain a minimum of 99.5% tungsten, with no alloying elements intentionally added. By using high purity tungsten, current carrying capability is diminished, although it maintains a clean, balled end which provides good arc stability.

## WELDING OF ALUMINIUM

### 2) Tungsten Electrodes cont.

Zirconiated Tungsten Electrodes:

Zirconiated tungsten welding electrodes have arc stability characteristics that are similar to pure tungsten besides the higher current carrying capability found in the thoriated tungsten. This welding electrode provides a good balance of properties. It is more resistant to contamination than pure tungsten and better for radiographic-quality welding applications than thoriated tungstens.

These electrodes have been designed primarily for use with High Frequency stabilised Alternating Current (AC-HF) and are alloyed with varying percentages of zirconium.

Zirconiated electrodes must be pre-ground to form a tapered tip with a radius end before use.

When current flows through a Zirconiated electrode the end tip which has been prepared with the radius end heats up and becomes slightly molten forming a balled end. This balled end is very important in AC-HF welding as it allows the AC current to obtain arc stability and its arc directional capabilities.

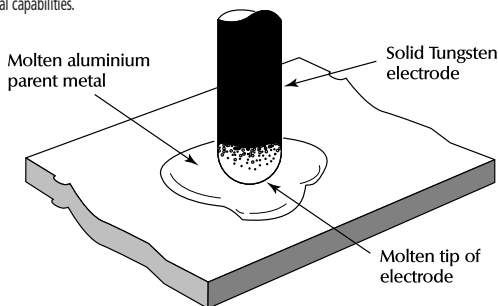

Uses: designed for high quality clean welding of Aluminium and Magnesium alloys.

Advantages:

- ▲ high current carrying capacity.
- ▲ high resistance to contamination from aluminium oxides (self cleaning action).
- ▲ resultant weld metal quality is of high radiographic standard.

Ceriated Tungsten Electrodes:

"The best of both worlds". These electrodes contain varying percentages of cerium and have been designed to function on both AC and DC currents.

Ceriated tungsten welding electrodes have an addition of approximately 2% cerium oxide ( $\text{CeO}_2$ ) which helps to reduce welding electrode burn-off. In performance, the ceriated welding electrode will react much like pure tungsten by providing a stable arc and reducing the amount of tungsten "spitting". These characteristics allow this welding electrode to perform well on aluminium in balanced wave machines (A.C.) and on steel in the D.C. mode.

This electrode can replace both Thoriated and Zirconiated electrodes in most instances.

## WELDING OF ALUMINIUM

### 2) Tungsten Electrodes cont.

Preparation before welding is dependent upon the current used.

Uses: designed for quality and general purpose work on most metals.

Advantages:

- ▲ reduces the number and types of electrodes required to complete different jobs.
- ▲ higher resistance to contamination than the thoriated and zirconiated types.
- ▲ higher current carrying capacity.
- ▲ a longer electrode tip life.
- ▲ non-radioactive material.

### 3) Preparing Tungsten Electrodes:

Tungsten electrodes are pre-ground before commencement of welding to allow efficient performance during welding.

Preparation is dependent upon two factors:

- ▲ Welding polarity being used (AC-HF or DC)
- ▲ The type of Parent Metal being welded.

The Correct Grinding Technique:

- ▲ When grinding Tungsten electrodes, it is very important to make sure the grinding lines run longitudinally to the electrodes axis.
- ▲ If the grinding lines run around the circumference of the electrode, they may cause the following problems:
  - ridges will be formed around the circumference which can cause tungsten particles to drop off the tip during welding. This will result in tungsten inclusions, a weld defect.
  - these ridges will reduce the stability of the arc and cause "arc wander".

Grinding lines will run with the length of the electrode

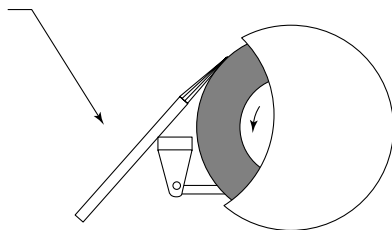

## WELDING OF ALUMINIUM

### Preparing Zirconiased & Ceriated Tungstens for AC-HF Welding:

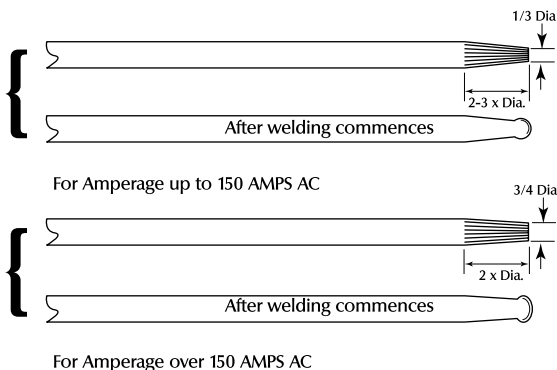

Current Carrying Capacities of Tungsten Electrodes:

ELECTRODE DIAMETER	THORIATED	ZIRCONIATED	CERIATED
0.5mm	5-50	5-35	5-60
1.0mm	10-90	15-55	7-95
1.6mm	20-120	35-75	20-130
2.4mm	50-190	45-160	60-230
3.2mm	80-250	50-225	80-320
4.0mm	120-370	90-300	130-450
5.0mm	200-500	150-400	210-600

### 4) Gas Tungsten Arc Welding - "Process Explanation" and "Power Source Terminology"

The Gas Tungsten Arc Welding (GTAW) process utilises heat generated by an electric arc maintained between the workpiece and a non consumable tungsten welding electrode. The arc is enveloped by a stream of inert gas. GTAW weld quality is primarily controlled by workpiece, filler wire, and tungsten electrode quality, type of power source, and welder technique. Discussed below are several important items that must be addressed in order to produce high quality welds.

High Frequency (HF):

The high frequency mode will initiate and maintain the arc during the zero crossing of the A.C. sine wave. Three positions exist on most GTAW machines eg. TRANSTIG 200 AC/DC:

1. Start - This mode helps arc initiation without making actual contact to the work with the tungsten welding electrode. The "Start" mode is most often used in D.C. welding.
2. Continuous - this also helps initiate the arc and continues throughout the process to maintain the arc during periods when current (amperage) is at the zero crossing point of the sine wave. This mode is most often used in A.C. welding. This type of mode is often a built in feature on most CIGWELD GTAW machines, and occurs automatically when AC current for GTA welding is selected.

## WELDING OF ALUMINIUM

### 4) Gas Tungsten Arc Welding - "Process Explanation" and "Power Source Terminology" cont.

3. Off - The high frequency system does not engage during any part of the process in this mode. Contact between the tungsten electrode and work surface must occur before the arc can be initiated. A "Touch Start or Scratch Start Practice" to initiate the arc can cause contamination of the tungsten electrode in the GTAW process. The "Off" mode is often used for DC-TIG or stick welding (MMAW) where scratch starting will initiate the arc.



## WELDING OF ALUMINIUM

### 4) Gas Tungsten Arc Welding - "Process Explanation" and "Power Source Terminology" cont.

Pulsed GTAW (TIG) Welding:

In Pulsed Gas Tungsten Arc Welding the current consists of two parts, "see below"

- 1) the high pulse which melts the metal,
  - 2) the low background current which maintains the arc and allows the weld to cool.
- The rate of pulse current is usually in the range of 1-10 pulses per second. Pulsed TIG welding offers the following advantages;
- a) reduced distortion,
  - b) reduced heat build up,
  - c) improved tolerance to joint fit up, and
  - d) user friendly operation.

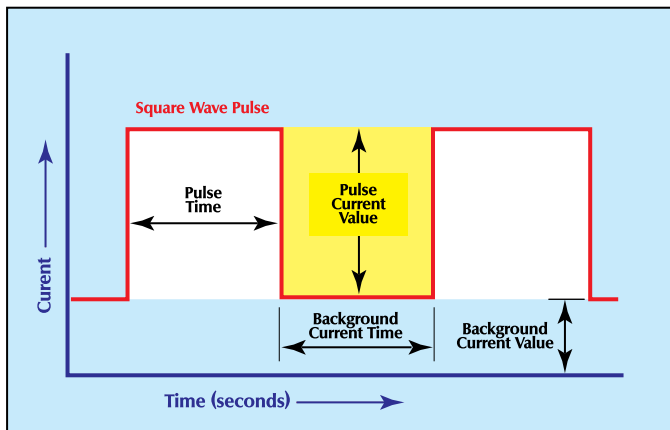

### 5) GTAW (TIG) Techniques

Starting the Arc:

After gas flow is established and providing HF is used, the electrode does not have to touch the workpiece or starting block to effect arc ignition. The superimposed high frequency current bridges the gap between the electrode and the workpiece or starting block and thus establishes a path for the welding current to follow.

For power sources that do not have a button or foot control start such as the TRANSTIG 150 the following steps are recommended;

- a) the torch should first be positioned in a near horizontal position about 50mm above the workpiece or starting block (a piece of copper is recommended for a starting block as it provides less risk of contamination).

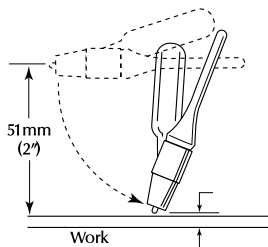

## WELDING OF ALUMINIUM

## 5) GTAW (TIG) Techniques cont.

- b) the torch is then moved quickly downwards until the electrode is within approx 3mm of the workpiece or starting block as shown on the previous page. The arc will then be initiated.
- c) to stop an arc, the torch should be returned to the horizontal position in a rather rapid manner so that the arc will not mark or damage the weld surface or workpiece. Some care will be necessary, particularly with high quality work and in pipe preparation when breaking the arc. In some instances it is advisable to run off, on to a tab or up the side of the pipe preparation when completing a pass.

## Torch Angles:

The proper manipulation of the welding torch is very important in making a good weld. When welding in the flat position,

- The hand should be placed lightly on a surface, so that the hand can move across the joint evenly. Movement of the torch by the fingers alone, usually results in incorrect torch angles and a poor weld.
- When adding filler wire, the wire should be gripped in the fingers. The hand should be as close as possible to the arc to hold the wire steady. The wire should move in conjunction with the torch movement. When adding wire, move the wire with the thumb through the fingers. The end of the wire should extend 150mm to 200mm from the hand. Too much extension of the filler wire results in a wobbly wire end making the puddle uneven and allowing the filler wire to become contaminated. Adding wire to the puddle requires steadiness and concentration to place the right amount of material at the right place, at exactly the right time.
- Torch angles vary only slightly depending on the welding position. The torch is usually pointed in the direction of travel with a 45-90° angle from the horizontal position. The filler rod is added ahead of the weld pool 10 to 25 degrees from the plane of the weld bead. The filler rod or wire should always be placed within the inert gas shield and at the leading edge of the weld pool. Too large a rod or wire disturbs and often freezes the pool, while a rod too small in size forces the welder to feed too fast for steady operation.

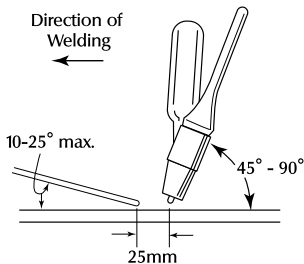

WELDING OF ALUMINIUM

5) GTAW (TIG) Techniques cont.

Torch Angles, for Different Welding Positions:

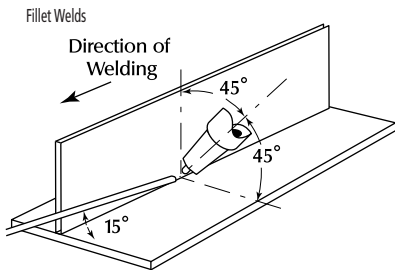

Corner to Corner Weld (Outside Corner)

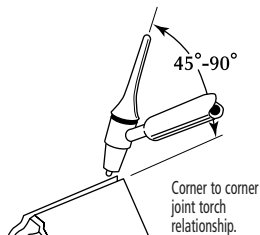

Vertical Welds

Vertical joint torch and filler rod relationship.

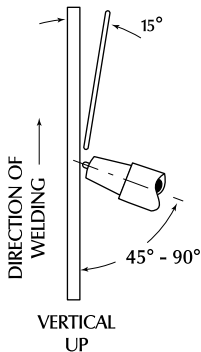
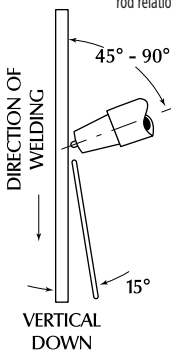

Overhead Welding

Overhead joint torch and filler rod relationship.

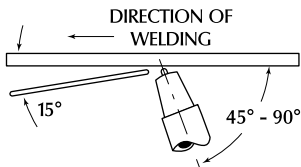

## WELDING OF ALUMINIUM

### 6) Joint Types and Parameters in GTAW

Joints types applicable to the following parameter table: Parameter Table for GTAW (TIG) Welding of Aluminium:

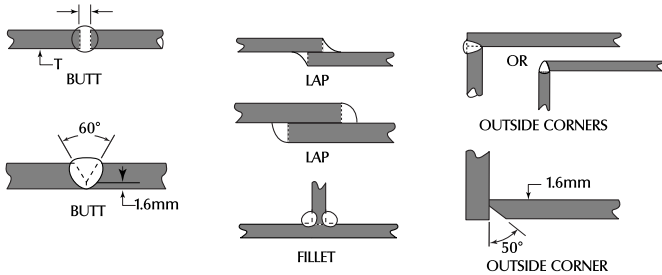

Aluminium GTAW (TIG) Welding - Alternating Current - High Frequency (AC-HF)						
Metal Thickness	Joint Type	Tungsten Electrode Diameter	Filler Rod Diameter (if required)	Amperage	Gas	
					Type	Flow L/min*
1.0mm	Butt/Corner Lap/Fillet	1.0mm	1.6mm	30-45 35-50	Argon	5-7
1.2mm	Butt/Corner Lap/Fillet	1.0mm	1.6mm	40-60 45-70	Argon	5-7
1.6mm	Butt/Corner Lap/Fillet	1.6mm	1.6mm	60-85 70-95	Argon	7
3.2mm	Butt/Corner Lap/Fillet	2.4mm 3.2mm	2.4mm	125-150 130-160	Argon	10
5.0mm	Butt/Corner Lap/Fillet	3.2mm 4.0mm	3.2mm	180-225 190-240	Argon	10
6.0mm	Butt/Corner Lap/Fillet	4.8mm 4.0mm	4.8mm	240-280 250-320	Argon	13

\*Flow rates are for argon only, see manufacturers' recommendations for mixtures. Size and shape of gas nozzle has an effect on the flow required for an effective gas cover.

## WELDING OF CAST IRON

### Introduction

This guide is not an exhaustive reference. Nonetheless, it provides the reader with a thorough technical guide to the welding of a number of different types of cast iron.

### Types of Cast Iron

Cast irons can generally be divided into the following groups:

1. Grey Cast Irons

Nominally contain 2.5-4.0% carbon and high silicon. Used for many applications, including those under conditions of static compressive load, lightly stressed process equipment and where severe thermal and mechanical shock would not normally be expected.

Due to the presence of graphite in its structure, grey cast iron is easily machined, helps in the lubrication of sliding surfaces and is therefore good for bearings and for damping mechanical vibration. Grey cast iron is however quite brittle and has low tensile strength. It has uses in the machinery and automotive industries, including brake drums, clutch plates and cam shafts. Furnace parts, ingot and glass moulds and melting pots that operate at elevated temperatures are made of grey cast iron, as are various types of pipes, valves, flanges and fittings for both pressure and non-pressure applications.

2. SG-Spheroidal Graphite Cast Irons (Nodular Cast Iron, Ductile Cast Iron)

SG cast irons have mechanical properties similar to those of mild steel and far greater than grey cast iron, in many cases replacing steel castings and forgings as well as grey cast iron in many applications. SG cast irons contain graphite making them machinable.

Applications include culverts, sewers, pressure pipes as well as fittings, valves and pumps. The advantages of these products are their relatively good toughness and weldability when compared to grey cast iron

3. Austenitic Cast Irons

Austenitic cast irons are nickel alloys of grey, SG and white cast irons.

Due to the nickel addition, austenitic cast irons exhibit corrosion resistance, erosion resistance, cavitation resistance and exhibit resistance to high temperature service. Austenitic cast irons are stronger and tougher than grey cast iron, producing good wear and galling resistance as well as good machinability.

Austenitic (SG) cast iron is approximately twice as strong as austenitic (grey) cast iron.

Austenitic white cast irons containing nickel, chromium and molybdenum make up the range of Ni-Hard, Ni-Resist and Nicrosilal grades. Ni-Hard is used for abrasion resistance, Ni-Resist for corrosion resistance and Nicrosilal for heat resistance.

4. White Cast Irons ("Chilled" Iron)

Unlike the grey and SG cast irons, white cast irons are virtually free of graphite. They are quite unmachinable and very brittle with high hardness and low tensile strength. They are often used in the manufacture of crushing rolls.

"Meehanite"\* is a high tensile white cast iron made by adding calcium silicide to white cast iron. The silicide addition gives uniform hardness as well as physical properties superior to that of grey cast iron.

\* (registered trademark of International Meehanite Metal Co. Ltd.)

## WELDING OF CAST IRON

### 5. Malleable Cast Irons

Malleable cast irons, which include the white heart and black heart irons, are formed by heating white iron for a set period of time. Malleable cast irons have a higher tensile strength and better ductility than grey cast iron and will bend or deform before breaking as well as standing shock better than grey cast iron.

Applications include flanges, pipe fittings and valve parts. Automotive parts include steering components, compressor crank shafts and hubs, transmission and differential parts, connecting rods and universal joints.

## Identifying the type of cast iron:

There are a number of ways of identifying the type of cast iron that is to be welded.

### 1. Visual observation

Grey and SG cast iron have a dirty, dark grey appearance due to the presence of graphite in the structure. White cast irons will have a whitish colour in a fracture in the casting. Malleable and austenitic cast irons have a cleaner appearance than grey or nodular.

### 2. Source of supply

If possible, check with the supplier of the cast iron. Quite often the item will be an old item in need of repair, so its origins may be difficult to discern.

### 3. Mechanical tests

These are the best tests for identification.

#### a) Spark test

An easy and useful method is the spark test. The metal is touched against a high speed emery wheel and the sparks are observed against a black background. The sparks should then be compared against the chart below. SG cast irons can be identified in the same manner as malleable cast irons. Meehanite cast irons can be identified in the same manner as grey cast irons.

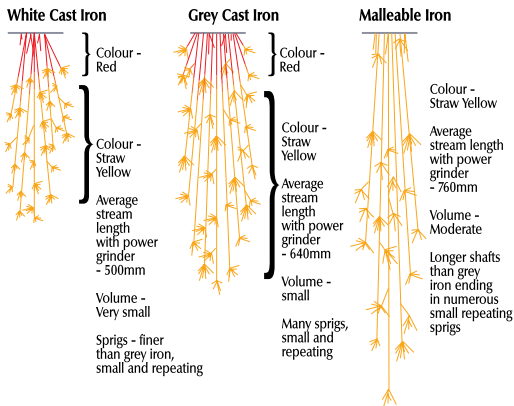

## WELDING OF CAST IRON

- b) Chisel test  
Can be used for the separation of grey cast iron and malleable iron. Grey cast iron chips break easily, whereas chips from malleable cast iron will curl from the corner of the piece.
- c) Spectrographic analysis  
This test is the most accurate of all. However it needs to be undertaken by a qualified laboratory to ensure accurate results.

### Welding Cast Irons

In general cast irons can be welded using the MMAW, FCAW, Gas and Braze Welding, Brazing, Powder Spraying and Soldering processes. The table below is a process selection guide listing the relevant CIGWELD consumable.

Process Cast Iron	MMAW	FCAW	Gas Welding	Braze Welding	Brazing	Soldering
Grey	1	2	3,5	4,5	4,5	7
SG (Nodular/ Ductile)	1	2		4,5	4,5	
Austenitic	1					
White	Considered unweldable					
Ni-Hard	Considered unweldable					
Ni-Resist	1					
Nicrosilal	Considered unweldable					
Malleable	1	2		4,5	4,5	
Meehanite	1					

1=Castcraft 55, Castcraft 100

2=Nicore 55

3=Comweld General Purpose Cast Iron

4=Comweld Comcoat C, Comweld Manganese Bronze

5=Comcoat N, Comcoat Nickel Bronze

6=Comweld 965 Silver Solder

### Preparation prior to welding

#### General

Cast iron is considered weldable, although to a far lesser degree than carbon steel. There have been many successful cast iron repair welds performed in maintenance and casting reclamation applications. The degree of brittleness and likelihood of cracking of the welded material will depend on the type of casting the heat treatment and the welding procedure. For example SG cast iron is more likely to absorb welding stresses than grey cast iron.

#### Preparation

The most important aspect of welding cast iron is to have the surface clean and free of defects prior to welding.

## WELDING OF CAST IRON

### Grinding & machining

All sand, slag and scale must be removed from the area of the casting to be welded by mechanical means such as grinding, machining, chipping or rotary burrs. Physical defects such as blowholes, sand inclusions, sponginess and shrinkage cracks need to be removed. Cracks should be excavated to their full length and depth. Excavate spongy areas and pinholes. Quite often a pinhole will open up to expose a large cavity hidden underneath. During preparation grinding wheels can become impregnated with carbon which can be smeared on the finished surface making joining difficult because of the high carbon content of the surface. Because of this the final 1-2mm should be prepared by chipping, rotary burrs or a coarse file to clean the surface.

### Oxy-acetylene

An oxidising oxy-acetylene flame can be used to burn off any surface graphite. This also provides a light preheat which is advantageous.

### Arc-air gouging

Arc-air gouging is not usually recommended. However, it can be used to remove the bulk of metal providing the last 1-2mm is removed by grinding.

### Oil soaked castings

Often castings are soaked in oil due to their environment eg. gear boxes. They may appear clean after mechanical cleaning, however oil will still be present in the pores of the casting. The elimination of the residual can be achieved by heating the casting to 200-300°C for 2-3 hours followed by wire brushing. This will help overcome porosity and poor welds. "Gassy" castings can be treated by heating the weld area to a dull red for a short time before welding. For small components, treatment in a furnace at 650°C for 15 minutes will give fairly complete degasification. On heavier castings the relevant face is welded and the resultant porous metal is removed and the surface rewelded until a clean surface is obtained. Castings high in phosphorous are difficult to weld and can be identified by a glassy and shiny appearance. Often brazing is the best way to repair these castings.

To repair cracked castings, drill a hole at each end of the crack to prevent it spreading further and grind out to the bottom. Begin welding at the drilled end of the crack, where restraint is greatest and move towards the free end.

Castings which have to transmit fairly heavy working loads often have the weld joint assisted by mechanical means, such as bolted straps, or hoops which are shrunk on. Broken teeth of large cast iron gears are sometimes repaired by studding. Holes are drilled and tapped in the face of the fracture and mild steel studs screwed in. These are then covered with weld metal and built up to the required dimensions. They are machined afterwards or ground to shape.

## Precautions when welding cast irons

Factors to consider are the same whatever the type of cast iron.

1. Low ductility with a danger of cracking due to stresses set up by welding. (This is not so important when welding SG iron due to its good ductility)
2. Formation of a hard brittle zone in the weld area. This is caused by rapid cooling of molten metal to form a white cast iron structure in the weld area and makes the weld unsuitable for service where fairly high stresses are met.
3. Formation of a hard, brittle weld bead due to pick-up of carbon from the base metal. This does not occur with weld metals which do not form hard carbides such as Monel and high nickel alloys. These are used where machinable welds are desired.



## WELDING OF CAST IRON

### Preheating

Although a large amount of satisfactory welding is done without preheating, cracking due to the rigidity or lack of ductility of castings, especially complicated shapes, may be minimised by suitable preheating.

In general all cast irons need to be preheated when oxy-acetylene welding to reduce the heat input requirements. High preheat is needed when using a cast iron consumable because the weld metal has low ductility near room temperature. A consumable that deposits relatively low strength, such as Castcraft 100, can be used with the base metal at or slightly above room temperature. The weld can readily yield during cooling and relieve welding stresses that might otherwise cause cracking in the weld.

1. Local preheating occurs where parts not held in restraint may be preheated to about 500°C in the area of the weld, with slow cooling after welding is completed. Cracking from unequal expansion can take place during the preheating of complex castings or when the preheating is confined to a small area of a large casting which is why local preheating should always be gradual.
2. Indirect preheating involves a preheat of 200°C for other critical parts of the job in addition to local preheating. This is done so that they will contract with the weld and minimise contraction stresses. Such a technique is suitable for open frames, spokes etc.
3. Complete preheating is used for intricate castings, especially those varying in section thicknesses such as cylinder blocks. It involves complete preheating to 500°C followed by slow cooling after welding. The preheating temperature should be maintained during welding. A simple preheating furnace may be made of bricks into which gas jets project. Another may be filled with charcoal which burns slowly and preheats the job evenly.

### Postweld Heating

After any welding on cast iron, especially welds intended for use in severe service or subject to close machining tolerances, the slowest cooling rate possible should be allowed, the part either remaining in the preheating furnace or cooling under a blanket of insulating powder or sand. It is sometimes the practice to post-heat welded joints to relieve stresses and soften hard areas. In this case it is normal to heat the casting to a temperature of 595-620°C. The casting should be held at this temperature for one hour per 25mm of thickness. The cooling rate should not exceed 10°C per hour until the casting has cooled to about 370°C. (For maximum softening and stress relief, heat at 900°C followed by slow cooling to 540°C or lower.) To obtain optimum ductility, the above heat treatment should be carried out immediately following welding.

For the best results with SG cast iron, the casting should be placed in a furnace (595-650°C) and the temperature raised to 900°C. The casting should be held at temperature for 2-4 hours. It is then cooled to 705°C, held there for 5 hours, then cooled to 590°C in the furnace and finally to room temperature. Malleable cast iron may be reheat-treated after welding.

### Peening

Satisfactory welds may be made on cast iron without preheating by using electrodes depositing soft metal and peening the weld with a blunt tool (such as a ball hammer) immediately after welding. This spreads the weld metal and counteracts the effect of contraction.

Good practice is to deposit short weld runs (50mm at a time) and then peen before too much cooling takes place. (Castcraft 100 is soft and allows peening).

# WELDING OF CAST IRON

## Joint Design

In general, joint design used for carbon steels are applicable for cast irons. Below are some suggested single-vee and double-vee preparations.

Welds should be as narrow as is practical for access - particularly for grey iron, as wide welds build up more stress than narrow ones. A double vee uses only half the weld metal of a single vee. For thick materials that are not accessible from both sides, a U-preparation is a good compromise.

See diagrams below for various joints designs:

Longer joints can be welded using the backstep, block, cascade, chain intermittent and staggered intermittent methods

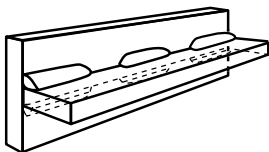
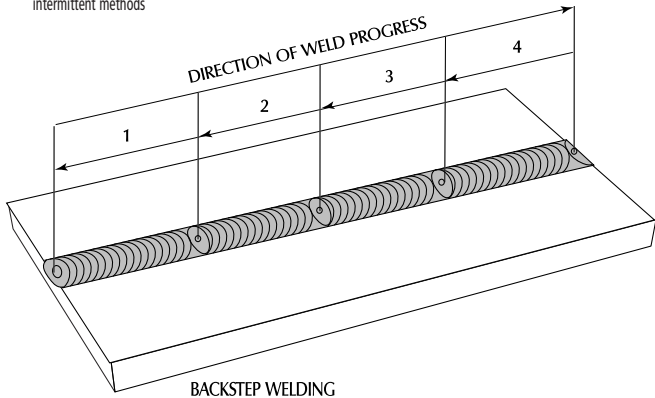

INTERMITTENT CHAIN WELDING

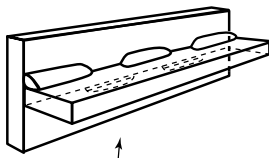

INTERMITTENT STAGGERED WELDING

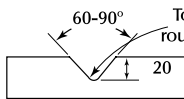

V-groove for narrow defects,

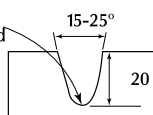

U-grooves for deep defects

## WELDING OF CAST IRON

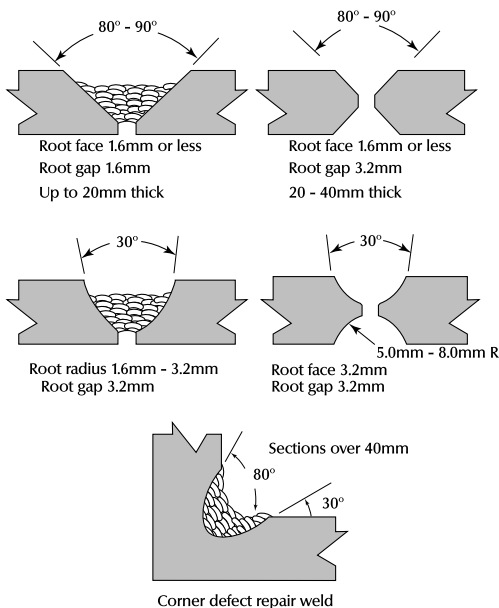

## MMAW welding of cast irons

The most suitable electrodes for MMAW of cast irons are pure nickel (AWS A5.15 ENi-CI, Castcraft 100) and 55% nickel / 45% iron (AWS A5.15 ENiFe-CI, Castcraft 55).

## Grey Cast Iron

Castcraft 100 is more suitable for single layers and for filling small defects as the deposit remains highly machinable. Single-layered welds of Castcraft 55 are not as machinable as Castcraft 100, however they do have increased strength and ductility. Castcraft 55 welds are more tolerant towards contaminants such as sulphur and phosphorous and are superior to Castcraft 100 electrodes when welding castings high in phosphorous.

Peening is a must for grey cast irons.

Joining of cast iron to steel can be performed with either Castcraft 55 or 100, but Castcraft 55 is preferred. Ferrous based electrodes, including hydrogen controlled types are generally not recommended for welding cast iron. Brackets, lugs and even wear plates can be attached to castings using the correct parameters and Castcraft 55.

## WELDING OF CAST IRON

### SG Cast Iron

Grey iron can be repaired with either Castcraft 55 or 100 whereas SG cast iron can only really be repaired using Castcraft 55 due to its higher tensile strength and better ductility. When welding SG cast irons, penetration should be low and wide joints or cavities should be built up from the sides towards the centre. Stringer beads or narrow weaves should be used. Deposit short beads and allow to cool to preheat temperature. Peening is advisable but not as critical as when welding grey cast iron.

### Austenitic cast irons

These are usually welded with Castcraft 55. Although Austenitic castings can be welded with Castcraft 55 the weld may be unsuitable for applications where corrosion/heat resistance qualities do not match the parent metal.

### GMAW welding of cast irons

Cast irons are generally considered unweldable using the GMAW process.

### FCAW welding of cast irons

Flux cored welding of cast irons is carried out using higher current than that for MMAW. This is offset by faster travel speeds as for normal FCAW welding. Both grey, SG and malleable cast irons can be welded using the FCAW process. Preparation and heat treatment are much the same as for MMAW.

The most suitable consumable that can be used is an AWS ENiFe-CI equivalent like Nicore 55.

### Oxy-acetylene welding of cast irons

For successful oxy fusion welding, it is essential that the part be preheated to a dull, red heat (approximately 650°C). A neutral or slightly reducing flame should be used with welding tips of medium or high flame velocity. The temperature should be maintained during welding. As with MMAW preparation it is necessary to use a furnace to ensure even heating of large castings. It is important that the casting be protected from draughts during welding and provision should be made to ensure that the required preheat is maintained. It is important to avoid sudden chilling of the casting otherwise white cast iron may be produced which is very hard and brittle. This may cause cracking or make subsequent machining impossible.

Oxy welding is suitable for grey cast irons with an AWS A5.15 RCI (Comweld General Purpose Cast Iron - Super Silicon), RCI-A type electrode and should be used with a suitable flux such as Comweld Cast Iron Flux.

An AWS RBCuZn-D (Comweld Nickel Bronze & Comweld Comcoat N) type can also be used with Comweld Bronze Flux.

SG cast irons can only be oxy welded with an AWS RCI-B type consumable.

### Braze Welding of cast irons

Braze welding should only be used to repair old castings because of the poor colour match achieved with newer castings. Braze welding is suitable for grey, SG and malleable cast irons, however joint strength equivalent to fusion welds are only possible with grey cast iron. A neutral or slightly oxidising flame should be used.

## WELDING OF CAST IRON

Braze welding has advantages over oxy welding in that the consumable melts at a lower temperature than the cast iron. This allows lower preheat (320-400°C). As with other forms of welding the surface must be properly cleaned so that carbon doesn't contaminate the weld deposit.

The applicable consumables to use are AWS RBCuZn-C (Comweld Manganese Bronze & Comweld Comcoat C) types and AWS RBCuZn-D (Comweld Nickel Bronze & Comweld Comcoat N) types.

## Brazing of cast irons

Any brazing processes suitable for steel are applicable to cast irons. Pre- and post- braze operations should be similar to that of standard brazing processes.

Consumables suitable for brazing carbon steel can be used for cast irons.

## Powder Spraying of cast irons

Powder spraying is particularly suited to edges, corners, shallow cavities and thin sections as there are usually no undercut marks. Porous metals can be surfaced before arc welding.

As with other welding processes, the base metal must be extremely clean and free from contaminants. Cavities and porous areas must be ground out to a saucer or cup shape with no overhanging edges. Sharp corners, edges and protruding points must be removed or radiused as they may go into solution in the molten metal causing hardspots.

Spraying and fusing should be as per the normal powder spraying process.

Poor quality or difficult irons can be joined by coating both parts separately with 1-2 mm of spray-fused alloy and then joining the coatings together with a suitable nickel MMAW electrode.

Consumables are based on a nickel-silicon-boron mixture.

## Soldering of cast irons

Soldering of cast irons is usually limited to the repair of small surface defects, often sealing areas from leakage of liquids or gases. The casting must be thoroughly cleaned.

A suitable consumable is Comweld 965 Solder.

## WELDING OF COPPER AND COPPER ALLOYS

### Introduction:

Copper and Copper alloys remain to this day among the most important engineering materials due to their good electrical and thermal conductivity, corrosion resistance, metal-to-metal wear resistance and distinctive aesthetic appearance. Copper and most copper alloys can be joined by welding, brazing and soldering. The major markets for copper and its alloys include the building industry, electrical and electronic products, industrial machinery and equipment and transportation.

This section outlines the different types of copper alloys and gives guidance on processes and techniques to be used in fabricating copper alloy components without impairing their corrosion or mechanical properties or introducing weld defects.

### 1) Types of Copper Alloys:

The eight major groups of copper and copper alloys are:

- i) Copper - 99.3% minimum Copper content.
- ii) High copper alloys - up to 5% alloying elements.
- iii) Copper-Zinc alloys (Brass).
- iv) Copper-Tin alloys (Phosphor Bronze).
- v) Copper-Aluminium alloys (Aluminium Bronze).
- vi) Copper-Silicon alloys (silicon bronze).
- vii) Copper-Nickel alloys.
- viii) Copper-Nickel-Zinc alloys (Nickel silver).

i) Pure Copper: 99.3% minimum Copper content- Copper is normally supplied in one of three forms:

- (a) Oxygen free copper.
- (b) Oxygen-bearing copper (tough pitch and fire-refined grades) - the impurities and residual oxygen content of oxygen-bearing copper may cause porosity and other discontinuities when these coppers are welded or brazed.
- (c) Phosphorous deoxidised copper.

ii) High Copper Alloys:

- (a) Free machining copper - Low alloying additions of sulphur or tellurium can be made to improve machining. These grades are considered to be unweldable due to a very high susceptibility to cracking. Free machining coppers are joined by brazing and soldering.
- (b) Precipitation - hardenable copper alloys - Small additions of beryllium, chromium or zirconium can be added to copper and then given a precipitation hardening heat treatment to increase mechanical properties. Welding or brazing of these alloys will over-age the exposed area resulting in degradation of mechanical properties.

iii) Copper-Zinc Alloys (Brass):

Copper alloys in which zinc is the major alloying element are generally called brasses. Brass is available in wrought and cast form, with the cast product generally not as homogeneous as the wrought products. Additions of zinc to copper decreases the melting temperature, the density, the electrical and thermal conductivity and the modulus of elasticity. The additions of zinc will increase the strength, hardness, ductility and coefficient of thermal expansion. Brasses can be separated into two weldable groups, low zinc (up to 20% zinc) and high zinc (30-40% zinc). The main problems encountered with brass is due to zinc volatilisation which results in white -

## WELDING OF COPPER AND COPPER ALLOYS

### 1) Types of Copper Alloys cont.:

fumes of zinc oxide and weld metal porosity. The lower zinc alloys are used for jewellery and coinage applications and as a base for gold plate and enamel. The higher zinc alloys are used in applications where higher strength is important. Applications include automotive radiator cores and tanks, lamp fixtures, locks, plumbing fittings and pump cylinders.

#### iv) Copper-tin Alloys (Phosphor Bronze):

Copper alloys which contain between 1 percent and 10 percent tin. These alloys are available in the wrought and cast forms. These alloys are susceptible to hot cracking in the stressed condition. The use of high preheat temperatures, high heat input, and slow cooling rates should be avoided. Examples of specific applications include bridge bearings and expansion plates and fittings, fasteners, chemical hardware and textile machinery components.

#### v) Copper-Aluminium Alloys (Aluminium Bronze):

Contain from 3-15 percent aluminium with substantial additions of iron, nickel and manganese. Common applications for Aluminium Bronze alloys include pumps, valves, other water fittings and bearings for use in marine and other aggressive environments.

#### vi) Copper-Silicon Alloys (Silicon Bronzes):

Available in both wrought and cast forms. Silicon Bronzes are industrially important due to their high strength, excellent corrosion resistance, and good weldability. The addition of silicon to copper increases tensile strength, hardness and work hardening rates.

Low silicon bronze (1.5% Si) is used for hydraulic pressure lines, heat exchanger tubes, marine and industrial hardware and fasteners. The high silicon Bronze (3% Si) is used for similar applications as well as for chemical process equipment and marine propeller shafts.

#### vii) Copper Nickel Alloys:

The cupronickel alloys containing 10-30% Ni have moderate strength provided by the nickel which also improves the oxidation and corrosion resistance of copper. These alloys have good hot and cold formability and are produced as flat products, pipe, rod, tube and forgings. Common applications include plates and tubes for evaporators, condensers and heat exchangers.

#### viii) Copper Nickel Zinc Alloys (Nickel Silvers):

Contain zinc in the range 17-27% along with 8-18% Nickel. The addition of nickel makes these alloys silver in appearance and also increases their strength and corrosion resistance, although some are subject to dezincification and they can be susceptible to stress corrosion cracking.

Specific applications include hardware, fasteners, optical and camera parts, etching stock and hollowware.

## WELDING OF COPPER AND COPPER ALLOYS

### 2) Weldability of Copper and Copper Alloys:

Welding processes such as Gas Metal Arc Welding and Gas Tungsten Arc Welding are commonly used for welding copper and its alloys, since high localised heat input is important when welding materials with high thermal conductivity. Manual Metal Arc Welding of Copper and Copper alloys may be used although the quality is not as good as that obtained with the gas shielded welding processes. The weldability of copper varies among the pure copper grades (a) (b) and (c). The high oxygen content in tough pitch copper can lead to embrittlement in the heat affected zone and weld metal porosity. Phosphorus deoxidised copper is more weldable, with porosity being avoided by using filler wires containing deoxidants (Al, Mn, Si, P and Ti). Thin sections can be welded without preheat although thicker sections require preheats up to 60°C. Copper alloys, in contrast to copper, seldom require pre-heating before welding. The weldability varies considerably amongst the different copper alloys and care must be taken to ensure the correct welding procedures are carried out for each particular alloy to reduce the risks of welding defects.

#### 2.1 Weld joint designs for Joining Copper and Copper alloys:

The recommended joint designs for welding copper and copper alloys are shown in Figures 1 & 2. Due to the high thermal conductivity of copper, the joint designs are wider than those used for steel to allow adequate fusion and penetration.

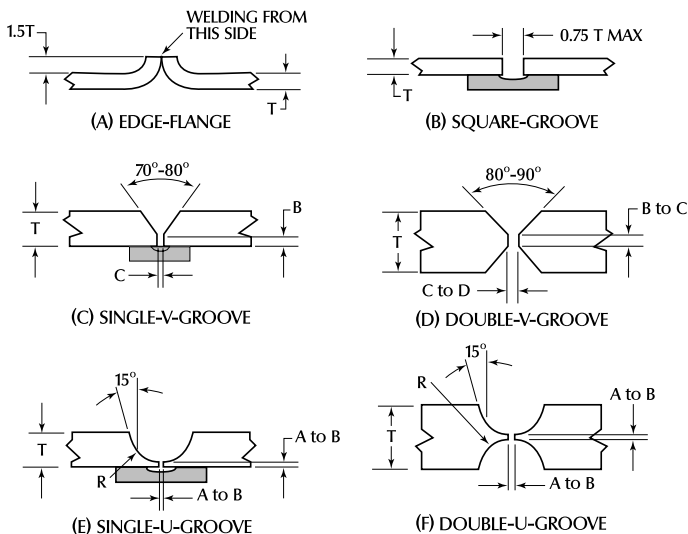

NOTE: A = 1.6mm, B = 2.4mm, C = 3.2mm, D = 4.0mm, R = 3.2mm, T = thickness

Figure 1. - Joint designs for Gas Tungsten Arc Welding and Manual Metal Arc welding of Copper and Copper Alloys.



## WELDING OF COPPER AND COPPER ALLOYS

## 2) Weldability of Copper and Copper Alloys cont.:

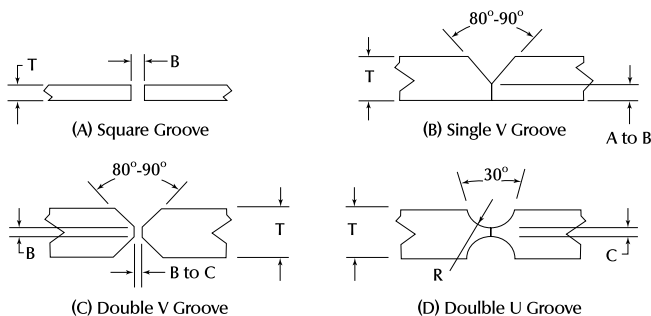

NOTE: A = 1.6mm, B = 2.4mm, C = 3.2mm, D = 4.0mm, R = 6.0mm, T = thickness

Figure 2. - Joint Designs for Gas Metal Arc Welding of Copper.

## 2.2 Surface Preparation:

The weld area should be clean and free of oil, grease, dirt, paint and oxides prior to welding. Wire brushing with a bronze wire brush followed by degreasing with a suitable cleaning agent. The oxide film formed during welding should also be removed with a wire brush after each weld run is deposited.

## 2.3 Pre-heating:

The welding of thick copper sections requires a high preheat due to the rapid conduction of heat from the weld joint into the surrounding base metal. Most copper alloys, even in thick sections, do not require pre-heating because the thermal diffusivity is much lower than for copper. To select the correct preheat for a given application, consideration must be given to the welding process, the alloy being welded, the base metal thickness and to some extent the overall mass of the weldment. Aluminium bronze and copper nickel alloys should not be preheated. It is desirable to limit the heat to as localised an area as possible to avoid bringing too much of the material into a temperature range that will cause a loss in ductility. It is also important to ensure the preheat temperature is maintained until welding of the joint is completed.

## 3) Gas Metal Arc Welding (GMAW) of Copper and Copper alloys:

## 3.1 GMAW of Copper:

ERCu copper electrodes are recommended for GMAW of copper. CIGWELD's Autocraft Deoxidised Copper is a versatile 98% pure copper alloy for the GMAW of copper. The gas mixture required will be largely determined by the thickness of the copper section to be welded. Argon is generally used for 6mm and under.

## WELDING OF COPPER AND COPPER ALLOYS

### 3) Gas Metal Arc Welding (GMAW) of Copper and Copper alloys cont.:

The helium-argon mixtures (Alushield Heavy) are used for welding of thicker sections.

The filler metal should be deposited with stringer beads or narrow weave beads using spray transfer. Table 1 below gives general guidance on procedures for GMAW of Copper.

\*Refer to Figure 2

Metal Thickness	Joint Design*	Electrode Diameter	Preheat <sup>#</sup> Temperature	Welding Current	Voltage Range	Gas Flow Rate (l/min)	Travel Speed
1.6mm	A	0.9mm	75°C	150-200	21-26	10-15	500 mm/min
3.0mm	A	1.2mm	75°C	150-220	22-28	10-15	450 mm/min
6.0mm	B	1.2mm	75°C	180-250	22-28	10-15	400 mm/min
6.0mm	B	1.6mm	100°C	160-280	28-30	10-15	350 mm/min
10mm	B	1.6mm	250°C	250-320	28-30	15-20	300 mm/min
12mm	C	1.6mm	250°C	290-350	29-32	15-20	300 mm/min
16mm +	C, D	1.6mm	250°C	320-380	29-32	15-25	250 mm/min

Table 1. - Typical Conditions for GMAW of Copper<sup>#</sup> and Copper Alloys.

Recommended Shielding Gases for the GMA welding of Copper and Copper Alloys:

- Welding Grade Argon.
- Ar + >0-3% O<sub>2</sub> or equivalent shielding gases.
- Ar + 25% He or equivalent shielding gases.
- He + 25% Ar or equivalent shielding gases.

#### 3.2 GMAW of Copper Silicon Alloys:

ERCuSi-A type welding consumables plus argon shielding and relatively high travel speeds are used with this process. Autocraft Silicon Bronze is a copper based wire recommended for GMAW of Copper Silicon Alloys. It is important to ensure the oxide layer is removed by wire brushing between passes. Preheat is unnecessary and interpass temperature should not exceed 100°C.

#### 3.3 GMAW of Copper Tin Alloys (Phosphor Bronze):

These alloys have a wide solidification range which gives a coarse dendritic grain structure, therefore care must be taken during welding to prevent cracking of the weld metal. Hot peening of the weld metal will reduce the stresses developed during welding and the likelihood of cracking. The weld pool should be kept small using stringer beads at high travel speed.

## 4) Gas Tungsten Arc Welding (GTAW) of Copper and Copper Alloys:

### 4.1 Gas Tungsten Arc Welding of Copper:

Copper sections up to 16.0mm in thickness can be successfully welded using the Gas Tungsten Arc Welding process. Typical joint designs are shown in Figure 1. The recommended filler wire is a filler metal whose composition is similar to that of

## WELDING OF COPPER AND COPPER ALLOYS

### 4) Gas Tungsten Arc Welding (GTAW) of Copper and Copper Alloys cont.:

the base metal. For sections up to 1.6mm thick Argon shielding gas is preferred and helium mixes is preferred for welding sections over 1.6mm thick. In comparison to argon, argon/helium mixes permit deeper penetration and higher travel speeds at the same welding current.

A 75% Helium-25% Argon mixture is commonly used to give the good penetration characteristics of helium combined with the easy arc starting and improved arc stability properties of Argon.

Forehand welding is preferred for Gas Tungsten Arc Welding of Copper with stringer beads or narrow weave beads. Typical conditions for manual GTAW of copper is shown in Table 2 below.

\*Refer to Figure 1

Metal Thickness (mm)	Joint Design*	Shielding Gas	Tungsten Type & Welding Current	Welding Rod Diameter	Preheat# Temperature	Welding Current
0.3-0.8	A	Argon	Thoriated/DC-	---	---	15-60
1.0-2.0	B	Argon	Thoriated/DC-	1.6 mm	---	40-170
2.0-5.0	C	Argon	Thoriated/DC-	2.4 - 3.2 mm	50°C	100-300
6.0	C	Argon	Thoriated/DC-	3.2 mm	100°C	250-375
10.0	E	Argon	Thoriated/DC-	3.2 mm	250°C	300-375
12.0	D	Argon	Thoriated/DC-	3.2 mm	250°C	350-420
16.0	F	Argon	Thoriated/DC-	3.2 mm	250°C	400-475

Table 2. - Typical conditions for Gas Tungsten Arc Welding of Copper# and Copper Alloys.

#### 4.2 Gas Tungsten Arc Welding of Copper-Aluminium alloys:

The ERCuAl-A2 filler rod can be used for GTAW of Aluminium Bronze Alloys. Alternating Current (AC) current with argon shielding can be used to provide an arc cleaning action to assist in removing the oxide layer during welding. Direct Current (DC-) electrode negative with Welding Grade Argon or Argon-Helium mixes can be used in applications requiring deeper penetration and faster travel speed. Preheat is only required on thicker sections.

#### 4.3 Gas Tungsten Arc Welding of Silicon-Bronze:

Comweld Silicon Bronze Rod (ERCuSi-A) can be used to weld Silicon Bronze in all positions. The Aluminium Bronze welding rod ERCuAl-A2 may also be used. Welding can be performed with DC- using argon or argon/helium shielding or AC using argon shielding gas.

### 5) Manual Metal Arc Welding (MMAW) of Copper & Copper Alloys:

#### 5.1 Manual Metal Arc Welding of Copper:

MMAW is normally used for the maintenance and repair welding of copper, copper alloys and bronzes. Bronzecraft AC-DC electrode (ECuSn-C) can be used for the following:

- ▲ Minor repair of relatively thin sections.
- ▲ Fillet welded joints with limited access.
- ▲ Welding copper to other metals.

## WELDING OF COPPER AND COPPER ALLOYS

### 5) Manual Metal Arc Welding (MMAW) of Copper & Copper Alloys:

Joint designs should be similar to that shown in Figure 1. Direct Current electrode positive (DC+) should be used with a stringer bead technique. Sections over 3.0mm require a preheat of 250°C or greater.

#### 5.2 Manual Metal Arc Welding of Copper Alloys:

Bronzecraft AC-DC (ECuSn-C) can be used to weld Copper-Tin and Copper-Zinc alloys. Large butt angles are required and the weld metal should be deposited using the stringer bead technique.

Copper Alloy	Recommended AWS Electrode Code	CIGWELD Welding Electrode	Electrode Polarity	Joint Design
Brasses	ECuSn-A or ECuSn-C	Bronzecraft AC-DC	DC+	C in Figure 1
Phosphor Bronze	ECuSn-A or ECuSn-C	Bronzecraft AC-DC	DC+	C in Figure 1

Table 3 - Recommendations for MMAW of Brasses and Phosphor Bronzes.

### 6) Brazing of Copper and Copper Alloys:

The principle of brazing is to join two metals by fusing with a filler metal. The filler metal must have a lower melting point than the base metals but greater than 450°C (use of a filler metal with a melting point less than 450°C is soldering). The filler metal is usually required to flow into a narrow gap between the part by capillary action.

Brazing is used widely for the joining of copper and copper alloys, with the exception of Aluminium bronzes containing greater than 10 percent aluminium and alloys containing greater than 3 percent lead. Brazing of copper is used extensively in the electrical manufacturing industry, and in the building mechanical services, heating, ventilation and air-conditioning fields.

To achieve an adequate bond during brazing, the following points should be considered:

1. The joint surfaces are clean and free of oxides etc.
2. The provision of the correct joint gap for the particular brazing filler metal.
3. The establishment of the correct heating pattern so that the filler metal flows up the thermal gradient into the joint.

#### 6.1 Surface Preparation:

Standard solvent or alkaline degreasing procedures are suitable for cleaning copper base metals. Care must be taken if mechanical methods are used to remove surface oxides. To chemically remove surface oxides, an appropriate pickling solution such as ChromeBright, should be used.

#### 6.2 Joint Design Considerations:

1. The distance between the joints to be joined must be controlled to within certain tolerances which depend upon the brazing alloy and the parent metal used. The optimum joint gap typically lies between 0.04 and 0.20mm.

## WELDING OF COPPER AND COPPER ALLOYS

### 6) Brazing of Copper and Copper Alloys:

- Generally a joint overlap of three or four times the thickness of the thinnest member to be joined is sufficient. The aim is to use as little material as possible to achieve the desired strength.

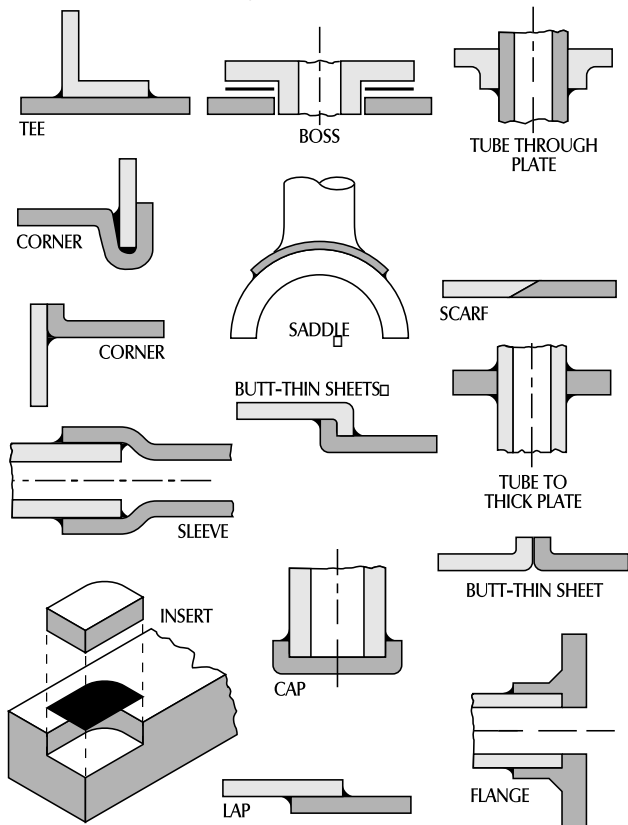

Figure 3 - Common Joint designs for Brazing.

#### 6.3 Flame adjustment:

Use a neutral flame. A neutral flame is where equal amounts of oxygen and acetylene are mixed at the same rate. The white inner cone is clearly defined and shows no haze.

## WELDING OF COPPER AND COPPER ALLOYS

### 6) Brazing of Copper and Copper Alloys cont.:

#### 6.4 Flux Removal:

If flux has been used, the residue must be removed by one of the following methods:

- ▲ Dilution in hot caustic soda dip.
- ▲ Wire brushing and rinsing with hot water.
- ▲ Wire brushing and steam.

Incomplete flux removal may cause weakness and failure of the joint.

### 7) Braze Welding of Copper:

Braze welding is a technique similar to fusion welding except with a filler metal of lower melting point than the parent metal. The Braze welding process derives its strength from the tensile strength of the filler metal deposited as well as the actual bond strength developed between the filler metal and parent metal. Oxy-acetylene is usually preferred because of its easier flame setting and rapid heat input.

#### 7.1 Choice of alloy:

The alloy most suited to the job requirement depends on the strength required in the joint, resistance to corrosion, operating temperature and economics.

Alloys commonly used are:

- ▲ COMWELD Tobin Bronze 211 (Braze Welding).
- ▲ COMWELD Comcoat T Flux Coated.

#### 7.2 Joint Preparation:

Typical joint designs are shown in Figure 4 over the page.

WELDING OF COPPER AND COPPER ALLOYS

7) Braze Welding of Copper cont.:

7.2 Joint Preparation:

Typical joint designs are shown in figure 4 below.

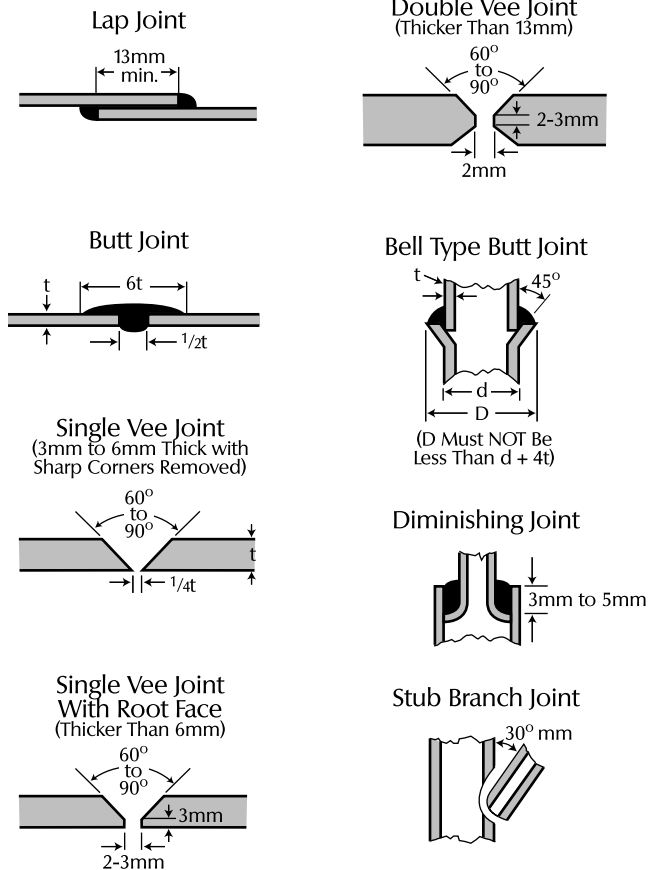

Figure 4 - Typical joint designs for Braze welding of copper.

## WELDING OF COPPER AND COPPER ALLOYS

### 7) Braze Welding of Copper cont.:

#### 7.3 Flame adjustment:

Use slightly oxidising flame.

#### 7.4 Flux:

Use COMWELD Copper and Brass Flux, mix to a paste with water and apply to both sides of joint. Rod can be coated with paste or heated and dipped in dry flux.

#### 7.5 Preheating:

Preheating is recommended for heavy sections only.

#### 7.6 Blowpipe and rod angles:

Blowpipe tip to metal surface  $40^{\circ}$  to  $50^{\circ}$ . Distance of inner cone from metal surface 3.25mm to 5.00mm. Filler rod to metal surface  $40^{\circ}$  to  $50^{\circ}$ .

Plate Thickness(mm)	Filler Rod(mm)	Blowpipe Acetylene Consumption (Cu. L/Min)	Tip Size
0.8	1.6	2.0	12
1.6	1.6	3.75	15
2.4	1.6	4.25	15
3.2	2.4	7.0	20
4.0	2.4	8.5	20
5.0	3.2	10.0	26
6.0	5.0	13.5	26

Table 5 Data for the Braze welding of Copper

#### 7.7 Welding Technique:

After preheating or after the joint is raised to a temperature sufficient to permit alloying of the filler rod and copper, melt a globule of metal from the end of the rod and deposit it into the joint, wetting or tinning the surface. When tinning occurs, begin welding using forehand technique. Do not drop filler metal on untinned surfaces. See figure 5.

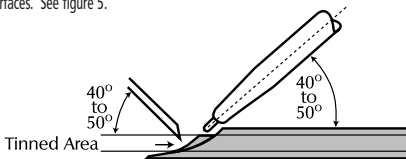

Figure 5 - Braze welding forehand technique.

#### 7.8 Flux Removal:

Any of the following methods may be used to remove flux residue:

- ▲ Grinding wheel or wire brush and water.
- ▲ Sand blasting
- ▲ Dilute caustic soda dip.



## WELDING OF DISSIMILAR METALS

At times, due to engineering design, it will be required that two, or in some cases more, dissimilar materials are to be joined by welding.

It is essential that the two materials be identified and wherever possible the design criteria be obtained, eg. elevated temperatures, chemical environment or wear by abrasion, etc.

Often it is not possible to obtain the base material analysis as in the case of maintenance or repair and it is left to the welding operator to select a consumable and a procedure purely based on his or her previous experience.

### Welding Recommendations (refer to Table 1. on the next page)

- A. One common combination of materials is stainless steel to mild steel and this combination can be successfully welded with a 309 type consumable. Both manual metal arc electrodes and gas metal arc wires are available.
- B. Should the stainless steel be of a heat resisting type, such as the 310 variety, then a 310 consumable is recommended. These 310 materials resist oxidation up to 1,200° C, making them ideal for furnace applications associated with the oil, metal and ceramic refining industries. The decision to use these materials is usually specified by the welding engineer.
- C. When welding cast iron to mild steel and possibly stainless steel, a nickel-iron consumable such as Castcraft 55 electrode or Nicore 55® flux core wire is often recommended.
- D. When welding steel to copper/brass select a consumable that is most compatible with the grade of copper/brass. Autocraft Silicon Bronze gas metal arc welding wire is commonly used with many copper alloy grades.
- E. For cast iron to copper/brass, select a consumable most suited to the copper alloy rather than the cast iron. A procedure commonly used is to butter the surface of the cast iron with Castcraft 55/Nicore 55®, then use either Bronzecraft AC/DC or Autocraft Silicon Bronze to complete the joint.
- F. A material that is not commonly used, but is chosen in high chemical attack applications, is Monel. This material can be welded to mild steel by using a E NiCu-B electrode. It may be necessary to butter the mating surface of the mild steel with a E NiCu-B electrode prior to the joining of the two materials.

Refer to Table 1 on the next page for details regarding various welding consumables to join dissimilar metals.

Table 1. Welding Consumables for Joining Dissimilar Metals

Material 1	Material 2	Welding Recommendations*	MMAW	GMAW	FCAW	Gas & TIG Welding
Mild Steel	Stainless Steel	A	Satinrome 309Mo-17 Weldall	Autocraft 309LSi	Veri-Cor 309LT	Not recommended
Mild Steel	Cast Iron	C	Castcraft 55	N/A	Nicore 55®	Comweld Mang. Bronze or Comweld Nickel Bronze
Mild Steel	Copper	D	Bronzecraft AC/DC	Autocraft Silicon Bronze	N/A	Comweld Mang. Bronze or Comweld Nickel Bronze
Cast Iron	Copper/Brass	E	* Bronzecraft AC/DC * Castcraft 55	* Autocraft Silicon Bronze * Nicore 55®	N/A	Comweld Mang. Bronze or Comweld Nickel Bronze
Mild Steel	Austenitic Manganese	-	Austex	Autocraft 309LSi	Veri-Cor 309LT	Not recommended
Mild Steel	Monel	F		N/A	N/A	N/A

\* See welding recommendations A, B, C, etc. on the previous page.

## HARDFACING INFORMATION

### What is Hardfacing and where is it used?

'Hardfacing is the process of depositing, by one of various welding techniques, a layer or layers of metal of specific properties on certain areas of metal parts that are exposed to wear'.

By expanding this definition a little further, it can be seen that hardfacing has more to offer than most other wear prevention treatments:

1. It is performed by welding. Thus it is part of a well established practice with which people are familiar. There are very few new skills to be learned and in the vast majority of cases, existing equipment can be employed.
2. A layer or layers of metal can be deposited. This means that hardfacing provides protection in depth. It can be applied in a thickness required to give long lasting protection.
3. Metal of specific properties is deposited. There are a wide variety of deposit types available, each specifically designed to withstand certain forms of wear and service conditions.
4. Hardfacing is applied only to specific areas of metal parts that are exposed to wear. There is often no need to protect the entire surface of a component from wear. Hardfacing can be applied selectively and in different thicknesses to suit the exact requirements of a piece of equipment, thereby proving a most economical way of combating wear.

According to the American Welding Society, 'hard surfacing' or hardfacing is defined as; 'The deposition of filler metal on a metal surface to obtain the desired properties and/or dimensions', the desired properties being those that will resist abrasion, heat and corrosion.

A further definition of hardfacing is: "The application of hard, wear-resistant material to the surface component by welding, spraying or allied welding process for the main purpose of reducing wear or loss of metal by abrasion, impact, erosion, galling and cavitation". It also applies where corrosion and elevated temperatures are present with one or more of the above service conditions.

Hardfacing is a particular form of surfacing that excludes the application of materials primarily for corrosion prevention or resistance to high temperature scaling or the application of low hardness, friction over-lays to prevent galling - eg. bronze surfacing. It also excludes the hardening of surfaces solely by heat treatments such as flame hardening, or nitriding.

A wide range of Cobalarc electrode and Stoodly wire products are available for the three main types of hardfacing applications carried out in industry;

1. **Build-up or re-building applications.**
2. **Hard surfacing or overlay applications.**
3. **Both build-up and overlay applications.**

## HARDFACING INFORMATION

### What is Hardfacing and where is it used?

#### 1. Build-up or re-building applications

- Used to return the part or component to its original dimensions.  
eg. Mangcraft, Ferrocraft 61etc.

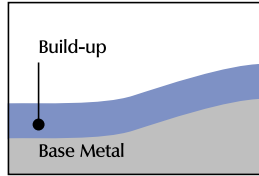

#### 2. Hard Surfacing or overlay applications.

- Used by itself to give a component added resistance to wear.  
eg. Cobalarc 650 and Stoodly 101HC.

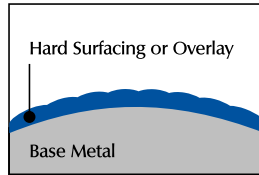

#### 3. Build-up and overlay applications.

Build-up and overlay can be used together to re-build a part to its original size and protect the contact surface from further wear. Some alloys can serve as both a build-up and overlay deposit, such as Cobalarc Mang Nickel-O wire which is recommended for heavy build up. During service the final layers of Mang Nickel-O can work harden under heavy impact to form a wear resistant overlay.

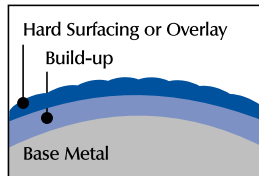

"Buttering layers" or "buffer layers" are a form of build-up or intermediate layer, deposited prior to the application of an overlay or hard surfacing deposit. See the "Use of buffer layers" for further details.

Hardfacing (or build-up and or overlay ) is therefore used in two main areas:

1. **For the build-up or rebuilding** of worn components to their original size and shape using suitable build-up or build-up and overlay alloys as described above.
2. **The overlay or hard surfacing** of new, or as new, components to protect them from wear during service. High alloy welding consumables are available for overlay applications which offer far better wear resistance than the original component material. Despite the higher price of these welding consumables the working life of the component can be extended by over twice that of the original component. Further more, if overlays are used as part of a preventative maintenance program the original component can be manufactured from a less expensive base material.

## HARDFACING INFORMATION

### Why should Hardfacing be carried out?

1. **Hardfacing extends the life of worn components and equipment:**
  - Build-up or hard surfacing can extend the life of a component by as much as 250% compared to that of a new or non hardfaced component.
2. **Hardfacing increases the operating efficiency of equipment by reducing downtime:**
  - Hardfaced components last longer, cause fewer shutdowns or stoppages and therefore increase the operating efficiency of the equipment.
3. **Hardfacing reduces overall costs:**
  - The cost of refurbishing a worn component is typically 50 - 75% of the cost of a new component.
4. **Hardfaced parts can be manufactured from cheaper base metals:**
  - A part which is hard surfaced before use can often be manufactured from a cheaper base metal than one which is not designed to be hard surfaced before use.
5. **Hardfacing minimise the inventory of spare parts:**
  - If worn parts are usually refurbished there is no need to keep high stock holdings.

### How to choose the right hardfacing consumable

Hardfacing alloy selection and correct welding procedures are best determined by answering the following four questions:

1. What is the base metal of the component?
2. What welding process is to be used?
3. What type of wear is being experienced?
4. What finish is required?

#### 1. What is the base metal of the component?

Knowing the base metal composition of the component is important in deciding what welding consumable to use and what welding procedure to adopt.

The most common ferrous base metals used fall into two broad classifications:

- ▲ Carbon and low alloy steels.
- ▲ Austenitic Manganese steels.

**Carbon and low alloy steels.** Carbon and low alloy steels are strongly magnetic and can easily be distinguished from austenitic manganese steels which are non-magnetic. There are many types of carbon and low alloy steels used in equipment manufacture. They are not easy to distinguish from one another but must be identified in order to establish accurate preheat, interpass, welding consumable, cooling rate and stress relief requirements.

## HARDFACING INFORMATION

### How to choose the right hardfacing consumable

Generally speaking as alloy content increases base metals become more difficult to weld and the use of correct preheat and interpass temperatures and slow cooling become more critical. Please refer to the **Welding of Steels** in this handbook.

**Austenitic manganese steels.** These high manganese (typically 14%) steels are strong and tough and as such are often used in the manufacture of components subject to both abrasion and extreme impact. Unique to manganese steels, they can be work hardened during high impact service to yield a component which is hard and abrasion resistant on the surface and yet tough, strong and ductile underneath. Unlike carbon and low alloy steels, manganese steels are rarely preheated; in fact base metal temperature during welding must be kept below approximately 300°C to avoid embrittlement. Welding practices such as step welding, water spraying or "welding in water" are often carried out to avoid base metal embrittlement. Manganese steels are an excellent base for the application of chromium white iron hard surfacing deposits such as Stoddy 101HC.

## 2. What welding process is to be used?

The welding processes most commonly used today for hardfacing are:

1. Manual Metal Arc Welding
2. Flux Cored Arc Welding
3. Submerged Arc Welding

Other processes such as oxy-acetylene welding and gas tungsten arc (GTA or TIG) welding are more often used for specialist hardfacing applications because of their low deposition rates.

Factors to be considered when selecting a suitable welding process / consumable include:

- ▲ Welding equipment available.
- ▲ Operator skills available.
- ▲ Welding location - indoors or outdoors.
- ▲ Size and shape of component and area to be hardfaced.
- ▲ Welding position - can component be moved to allow downhand welding?
- ▲ Availability of hardfacing consumables.

### 1. Manual Metal Arc Welding.

The most common type of welding process used with a wide range of extruded and tubular welding electrodes available for build-up and hard surfacing applications as well as for joining applications.

The most common types of manual electrodes are those designated as A4 and A1 types in Australian/New Zealand Standard AS/NZS 2576 - Welding Consumables for Build-up and wear resistance.

**A1 type = Tubular electrodes with no alloy contribution from the flux coating, eg. Stoddy Tube Borium.**

**A4 type = Low carbon steel rod with an alloy additive flux coating, eg. Cobalarc 350.**

Note: See Consumables Classification Charts in this Pocket Guide for an explanation of AS/NZS 2576.

## HARDFACING INFORMATION

### How to choose the right hardfacing consumable

#### 2. Flux Cored Arc Welding.

A semi-automatic process which is a variant of the gas metal arc welding process, where a continuous tubular electrode (instead of a solid wire) is used to provide the build-up or hard surfacing deposit.

The most common types of tubular wires are those designated as B5 and B7 types in AS/NZS 2576.

**B5 type = Tubular wires which are used with an external gas shielding, eg. Stoodly 101HC-G.**

**B7 type = Tubular wires which are self shielding or require no external shielding gas, eg. Stoodly 100HC-O.**

Because of the high level of build-up and hard surfacing carried out "on site" or out-of-doors self shielded (B7 type) wires are the most popular. Self shielded wires are also called open arc wires because the welding arc is visible during welding.

The flux cored arc welding process has become increasingly popular for build-up and hardfacing applications because of the flexibility in alloy selection and wire size and the high deposition rates achievable in practice.

#### 3. Submerged Arc Welding.

Commonly used in the automatic mode, with either:

- An alloy additive tubular wire/strip and neutral flux (B1 type in AS/NZS 2576),
- An alloy additive solid wire/strip and neutral flux (B2 type in AS/NZS 2576),
- An alloy additive solid wire/strip with an alloy additive flux (B3 type in AS/NZS 2576) or,
- A low carbon steel wire/strip with an alloy additive flux (B4 type in AS/NZS 2576)

The submerged arc welding process is commonly used to build-up or hard surface large components automatically. The B1 type wire / flux combination is the most popular option used because of the flexibility in alloy types available in a tubular wire.

### 3. What type of wear is being experienced

In selecting a build-up or hard surfacing alloy the aim is to provide the best solution to the specific wear problem at hand. This solution is usually arrived at by considering a combination of factors including; past experience, a knowledge of the wear types experienced, a knowledge of welding alloy wear performance and verification through practical tests. It would be easier to select a welding consumable for a particular application if the component was always subjected to the one set of wear conditions. Unfortunately this is never the case, with wear modes differing from one component to another and from one application to another.

Experience has shown that there are three major types of wear:

- ▲ Metal-to-metal wear,
- ▲ Abrasive wear,
- ▲ Environmental wear.

A detailed treatment of these wear types is beyond the scope of this handbook, please refer to Australian/New Zealand Standard AS/NZS 2576.

## HARDFACING INFORMATION

### How to choose the right hardfacing consumable

#### 3. What type of wear is being experienced cont.

The three major types of wear can be further sub-divided into;

##### ▲ Metal-to-metal wear:

###### 1. Adhesive or sliding wear:

In sliding wear, friction occurs between two surfaces which are in intimate contact.

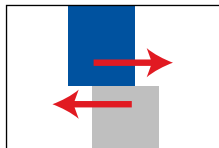

###### 2. Rolling wear:

In rolling wear, contact stresses are often high and wear occurs by a fatigue mechanism.

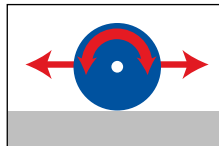

###### 3. Impact wear:

In impact wear, parts encounter repeated impact which can cause brittle fracture or gross plastic deformation.

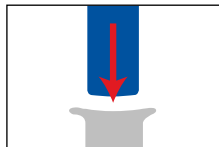

##### ▲ Abrasive wear:

###### 1. Erosion:

In erosive wear, parts encounter high velocity fluids (liquids or gaseous) with or without solid particles. The two major types of erosion experienced are:

###### 1A. Solid particle erosion:

Wear of a part by the action of solid particles impinging on the surface.

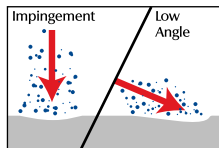

###### 1B. Liquid droplet and cavitation erosion:

Wear of a part by the action of liquid droplets or bubbles on the surface.

###### 2. Low stress (scratching) abrasion:

In low stress abrasion, the abrasive particles, which are usually small and unconstrained, scratch the surface continuously to cause wear. The particles are not fractured or ground up during service.

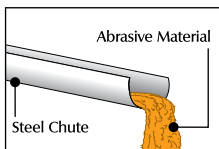



## HARDFACING INFORMATION

### How to choose the right hardfacing consumable

What type of wear is being experienced cont.

#### ▲ Abrasive wear:

##### 3. High stress (grinding) abrasion:

In high stress abrasion, the abrasive particles, which are initially small (rocks < 50mm in diameter), are fractured or ground-up during service.

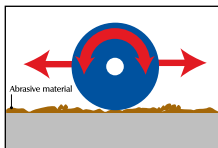

##### 4. Gouging abrasion:

In gouging abrasion, the abrasive particles, which are usually large (rocks > 50mm in diameter), gouge or groove the surface during service.

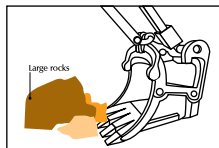

#### ▲ Environmental wear:

Corrosion and elevated temperatures can combine with the abrasive wear mechanisms detailed above to exacerbate the wear of a component. A detailed treatment of environmental wear mechanisms is beyond the scope of this handbook, please refer to AS/NZS 2576.

### Limiting Service Conditions

Table 1. is a guide to selecting the appropriate Cobalarc hardfacing product based on the wear types identified from a specific application. The severity of loading, impact and temperature on a component must be considered along with the main wear mechanisms identified in order to select an appropriate Cobalarc hardfacing product.

In Table 1. the service conditions of load, impact and temperature are graded as follows:

#### Loading:

- ● ● = **HIGH loading** where there is gross deformation of the wear surface,
- ● = **MODERATE loading** where there is some local deformation of the wear surface,
- = **LOW loading** where there is no local deformation of the wear surface.

#### Impact:

- HIGH** = **HIGH impact** causing fracture or plastic deformation of the wear surface,
- LOW** = **LOW impact** causing no fracture or plastic deformation of the wear surface.

#### Temperature:

- < 200°C - Service temperatures from ambient to 200°C,
- > 200°C < 500°C - Service temperatures greater than 200°C and less than 500°C,
- > 500°C - Service temperatures greater than 500°C.

# HARDFACING INFORMATION

## Cobalarc Product Selection by Wear Type - Table 1:

Cobalarc product	Limiting service conditions*		WEAR TYPE									
			Metal-to-metal					Abrasive wear				
			Sliding	Rolling	Impact	Solid particle erosion	Liquid droplet erosion	Low stress abrasion	High stress abrasion (Grinding)	Gouging abrasion		
Cobalarc Mangcraft, Stoodly Dynamang-O	●●●	HIGH	<200°C	---	---	R	---	---	---	---	R	R
Cobalarc Austex,	●●●	HIGH	<500°C	---	R	R	---	---	---	---	---	---
Cobalarc 350, Stoodly Super Build Up-G,	●●●	HIGH & LOW	<200°C	R	R	R	---	---	---	---	---	---
Cobalarc Toolcraft	●●●	LOW	<500°C	R	R	R	---	---	---	---	R	---
Cobalarc 650, 750 Stoodly 965-G, -O Stoodly 850-O <sup>†</sup>	●●●	HIGH	<200°C	---	---	---	R	---	---	R	R	R

\* See previous page for limiting service condition definitions.

<sup>†</sup> Stoodly 850-O is not recommended for high impact applications

R = Recommended.

HR = Highly Recommended.

**HARDFACING INFORMATION**

**Cobalarc Product Selection by Wear Type - Table 1:**

Cobalarc product	Limiting service conditions*		WEAR TYPE								
	Loading	Impact	Temp.	Metal-to-metal			Abrasive wear				
				Sliding	Rolling	Impact	Solid particle erosion	Liquid droplet erosion	Low stress abrasion	High stress abrasion (Grinding)	Gouging abrasion
Cobalarc CR70, Stoody 101 HC-G-0	●●	HIGH	<500°C	---	---	---	R	R	HR	HR	HR
Cobalarc 9e, Cobalarc Borochrome Stoody Fineclad-0	●●	HIGH	<500°C	---	---	---	R	R	HR	HR	HR
Stoody Tube Borium, Bronzcraft AC-DC	●●	LOW	<500°C	---	---	---	R	HR	HR	HR	R
Comweld Manganese Bronze and Comweld Comcoat C	●●	LOW	<200°C	---	---	---	HR	R	HR	R	R
Comweld Nickel Bronze and Comweld Comcoat N	●●●	HIGH	<200°C	R	R	R	---	---	---	---	---

\* See previous page for limiting service condition definitions. R = Recommended. HR = Highly Recommended.

## HARDFACING INFORMATION

## Cobalarc Applications by Industry Sector

## AGRICULTURAL EQUIPMENT

APPLICATION	Cobalarc electrode	Stoody wire
▲ Slasher Blades	Toolcraft	Stoody 965 G-0
▲ Tools and Drill Bits	Toolcraft	-
▲ Scarifier Points	Cobalarc 750, Cobalarc 9e	Stoody 850-0
▲ Plough Shares	Cobalarc CR70	Stoody 101 HC G-0
▲ Ammonia Injector Knives	Cobalarc 9e, Stoody Tube Borium	
▲ Subsoiler teeth	Cobalarc CR70, Stoody Tube Borium	Stoody 101 HC G-0
▲ Ripper Shanks	Cobalarc 9e	
▲ Furrow Shovels	Cobalarc 9e	
▲ Post Hole Augers	Cobalarc 9e	
▲ Pilot bit	Cobalarc Toolcraft	
▲ Rollers and Tractor Machine Parts	Cobalarc 350	Stoody Super Buildup G-0
▲ Root Cutters	Cobalarc CR70, Cobalarc 9e	Stoody 101 HC G-0

**HARDFACING INFORMATION**
**Cobalarc Applications by Industry Sector**
**EARTHMOVING, MINING, CRUSHING & QUARRYING**

APPLICATION	Cobalarc electrode		Stoody wire	
	Build-up	Hard Surfacing	Build-up	Hard Surfacing
▲ Track Pads	Cobalarc 350		Stoody Super Buildup	
▲ Rippers	---	Cobalarc 9e	---	Stoody 101 HC, 100 HC
▲ Grouser Bars	Cobalarc 350	Cobalarc 650	Stoody Super Buildup	Stoody 965
▲ Loader Buckets	---	Cobalarc 9e	---	Stoody 101 HC, 100 HC
▲ Idlers and Idler Rolls	Cobalarc 350	-	Stoody Super Buildup	-
▲ Teeth and Points	---		---	Stoody 101 HC, 100 HC
▲ Drilling Augers	---	Cobalarc 9e Cobalarc CR70, Cobalarc 9e	---	Stoody 101 HC, 100 HC
▲ Crusher Jaws*, Crusher Cones*, Crusher Roll Shells*, Gyratory Crusher Mantle*	Cobalarc Mangcraft,	Cobalarc CR70, Cobalarc 9e	Stoody Dynamang	Stoody 101 HC, 100 HC
▲ Hammer Mill Hammers*	Cobalarc Mangcraft,	Cobalarc CR70, Cobalarc 9 e	Stoody Dynamang	Stoody 101 HC, 100 HC
▲ Impact Breaker Bars*	Cobalarc Mangcraft,	Cobalarc CR70, Cobalarc 9e	Stoody Dynamang	Stoody 101 HC, 100 HC
▲ Fan Blades	---	Cobalarc 9e, Cobalarc Borochrome	---	Stoody Fineclad
▲ Pug Mill Paddles	---	Cobalarc 9e, Stoody Tube Borium	---	
▲ Sizing Screens		Cobalarc CR70, Cobalarc Borochrome		Stoody 101 HC, 100 HC Stoody Fineclad
▲ Chutes	---	Cobalarc Borochrome	---	Stoody Fineclad
▲ Kiln Trunnions	Cobalarc 350	Cobalarc 650	Stoody Super Buildup	Stoody 965

\* Manufactured from austenitic manganese steel

**HARDFACING INFORMATION**
**Cobalarc Applications by Industry Sector**
**SUGAR INDUSTRY**

APPLICATION	Cobalarc electrode		Stoody wire	
	Build-up	Hard Surfacing	Build-up	Hard Surfacing
▲ Cane Crushing Rolls	---	Cobalarc CR70, Cobalarc BoroChrome	---	Stoody Fineclad
▲ Preliminary Cane Leveller or Kicker Blades	---	Cobalarc 9e, Cobalarc BoroChrome	---	Stoody Fineclad
▲ Cane Shredder Hammer	Ferrocrafter 7016, Ferrocrafter 61		Supre-Cor 5	
▲ Scraper, Trash and Return Plates	Cobalarc Austex	Cobalarc CR70, Cobalarc 9e, Cobalarc BoroChrome	Autocraft 309LSi	Stoody 101 HC, 100 HC Stoody Fineclad
▲ Shredder Grid Bars	Cobalarc Austex	Cobalarc CR70, Cobalarc 9e	Autocraft 309LSi	Stoody 101 HC, 100 HC
▲ Cane Preparation Knives	---	Cobalarc 9e, Cobalarc Toolcraft	---	Stoody 101 HC, 100 HC
▲ Spiky Feed Rolls	Cobalarc Austex	Cobalarc CR70, Cobalarc 9e	Autocraft 309LSi	Stoody 101 HC, 100 HC
▲ Cane Harvester Base Cutters and Elevator Rolls	---	Cobalarc 9e	---	Stoody 101 HC, 100 HC

**HARDFACING INFORMATION**
**Cobalarc Applications by Industry Sector**
**DREDGING INDUSTRY**

APPLICATION	Cobalarc electrode		Stoody wire	
	Build-up	Hard Surfacing	Build-up	Hard Surfacing
▲ Carbon Steel Pump Casings	Cobalarc 350	Cobalarc CR70, Cobalarc Borochrome	Stoody Super Buildup	Stoody 101 HC, 100 HC Stoody Fineclad
▲ Manganese Steel Pump Casings	Cobalarc Mangcraft,	Cobalarc CR70, Cobalarc Borochrome	Stoody Dynamang	Stoody 101 HC, 100 HC Stoody Fineclad
▲ Dredge Pump Impellers	---	Cobalarc Borochrome, Cobalarc CR70	---	Stoody Fineclad, Stoody 101 HC, 100 HC
▲ Dredge Pump Side Plates	---	Cobalarc Borochrome, Cobalarc 9e	---	Stoody Fineclad
▲ Manganese Steel Dredge Cutter Heads and Teeth	---	Cobalarc Borochrome, Cobalarc 9e	---	Stoody Fineclad
▲ Dredge Bucket Lips	---	Cobalarc Borochrome, Cobalarc 9e	---	Stoody Fineclad
▲ Pipeline Ball Joints	---	Cobalarc Borochrome, Cobalarc 9e	---	Stoody Fineclad
▲ Ladder Roll Bearing Box	Cobalarc 350	---	Stoody Super Buildup	
▲ Dredge Ladder Rolls	Cobalarc 350	Cobalarc 650	Stoody Super Buildup	Stoody 965
▲ Dredge Pump Inlet Nozzle	---	Cobalarc Borochrome, Cobalarc CR70	---	Stoody Fineclad, Stoody 101 HC, 100 HC
▲ Bucket Pins	---	Cobalarc 650	---	Stoody 965
▲ Carbon Steel Lower Tumblers	---	Cobalarc 650	---	Stoody 965
▲ Manganese Steel Lower Tumblers	Cobalarc Mangcraft,	Cobalarc Mangcraft,	Stoody Dynamang	Stoody Dynamang

## HARDFACING INFORMATION

### Cobalarc Applications by Industry Sector

#### CEMENT, BRICK & CLAY INDUSTRIES

APPLICATION	Cobalarc electrode		Stoody wire	
	Build-up	Hard Surfacing	Build-up	Hard Surfacing
▲ Kiln Trunnions	Cobalarc 350		Stoody Super Buildup	---
▲ Screw Flight Shaft Bearings, Hangers and Pins	---	Cobalarc CR70	---	Stoody 101 HC, 100 HC Stoody Fineclad
▲ Drag Chain Links	---	Cobalarc CR70	---	Stoody 101 HC, 100 HC Stoody Fineclad
▲ Cage Bars	Cobalarc Austex	Cobalarc 9e		Stoody Fineclad
▲ Manganese Steel Mill Hammers	Cobalarc Austex, Cobalarc Mangcraft	Cobalarc 9e	Stoody Dynamang	Stoody 101 HC, 100 HC
▲ Bag Packer Screws	---	Cobalarc Borochrome	---	Stoody Fineclad
▲ Slurry Tank Agitator Shaft	---	Cobalarc Borochrome	---	Stoody Fineclad
▲ Muller Tyres	Cobalarc Austex, Weldall	Cobalarc CR70 Cobalarc 9e		Stoody 101 HC, 100 HC
▲ Pug Mill Auger Flights	---	Cobalarc Borochrome Cobalarc 9e Stoody Tube Borium	---	Stoody Fineclad
▲ Pug Mill Knives	---	Stoody Tube Borium	---	
▲ Feeder Blades	---	Stoody Tube Borium	---	
▲ Shredder Cones	---	Cobalarc 9e Cobalarc Borochrome	---	Stoody Fineclad
▲ Shredder Knives	---	Cobalarc Borochrome	---	Stoody Fineclad
▲ Brick Pin Assembly	---	Cobalarc Borochrome	---	Stoody Fineclad
▲ Roll Crusher Teeth	---	Cobalarc 9e	---	Stoody 101 HC, 100 HC



**HARDFACING INFORMATION**
**Cobalarc Applications by Industry Sector**
**IRON AND STEEL INDUSTRY**

APPLICATION	Cobalarc electrode		Stoody wire	
	Build-up	Hard Surfacing	Build-up	Hard Surfacing
▲ Blast Furnace Bells	---	---	---	Stoody 101 HC, 100 HC (burden area)
▲ Coke Chutes	---	Cobalarc 9e, Cobalarc BoroChrome	---	Stoody Fineclad
▲ Coke Oven Pusher Shoes	---	Cobalarc 9e, Cobalarc BoroChrome	---	Stoody Fineclad
▲ Coupling Boxes	Cobalarc 350	Cobalarc 650, Cobalarc 750	Stoody Super Buildup	Stoody 965
▲ Screw Conveyors	---	Cobalarc CR70, Cobalarc 9e	---	Stoody 101 HC, 100 HC
▲ Grizzly Bars and Fingers	---	Cobalarc CR70, Cobalarc 9e	---	Stoody 101 HC, 100 HC
▲ Pig Iron Casting Machine Rails	---	Cobalarc 650, Cobalarc Toolcraft	Stoody Super Buildup	Stoody 965 Stoody 850
▲ Wobblers	Cobalarc 350	Cobalarc 650, Cobalarc 750	---	Stoody 965
▲ Ingot Buggy Wheels and Tracks	---	---	Stoody Super Buildup	Stoody 965
▲ Sand Slinger Cups Inlet Nozzle	---	Cobalarc BoroChrome, Cobalarc CR70	---	Stoody 101 HC, 100 HC Stoody Fineclad

## HARDFACING INFORMATION

### USE OF BUFFER LAYERS

The term buffer layer is used to describe the presence of an intermediate deposit between the base material and the actual hardfacing deposit and in a number of cases is both desirable and necessary.

#### 1. Hardfacing on a soft material for high load service.

When a hardfacing deposit is placed on a softer base materials there is a tendency for it to "sink in" under high loading. To overcome this a strong, tough layer is deposited onto the base materials prior to hardfacing.

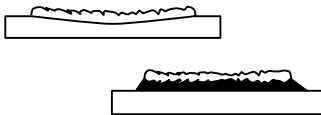

#### 2. Hardfacing on components subject to heavy Impact/Flexing.

When a component is subjected to heavy impact and/or flexing there is the possibility that relief checks which are common in the higher hardness range of hardfacing products will act as stress concentrators and propagate through to the base materials, particularly where the base material is a high strength steel. The use of a suitable buffer layer between the base and hardfacing deposit will overcome this problem.



#### 3. Hardfacing over Partly Worn Components.

In many instances components which have been hardfaced and put into service wear unevenly and when presented for hardfacing again there are areas of the original hardfacing deposit still existing. For the softer, multilayer deposits and/or deposits which have not fractured under impact, hardfacing can be re-applied directly. However for fractured and very hard deposits it is necessary they be removed by grinding, gouging etc. prior to re-hardfacing. If this is not possible the use of buffer layer will secure the existing hardfacing and provide a tough base for subsequent hardfacing layers.

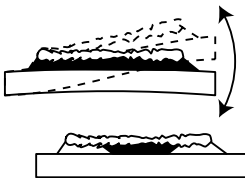

NOTE: When applying buffer layers, particularly on 11-14% manganese steel or the higher strength base materials ensure that the buffer layer extends beyond the hardfacing deposit. This will overcome the possible propagation of relief checks or cracks occurring along the edge of the hardface deposit.

## HARDFACING INFORMATION

### HARDFACING DEPOSIT PATTERNS

The amount of hard surfacing and the pattern of coverage will be determined by a number of factors including the function of the component, service conditions and the state of repair. The three main patterns used are:-

#### 1. Continuous Coverage.

Is used for re-building and hardfacing parts that have a critical size or shape, such as rolls, shafts, tracks, crusher jaws and cones. It is also required on parts subject to a high degree of fine abrasion or erosion. Typical examples would be pump and fan impellers, sand chutes, valve seats, mixer paddles and dredge bucket lips. Sufficient over-lapping of each bead is necessary to ensure adequate coverage.



CORRECT



INCORRECT

#### 2. Stringer Beads.

Other than complete coverage, stringer beads are widely used for many applications including, ripper teeth, buckets/bucket teeth, rock chutes, sheep foot tempers etc.

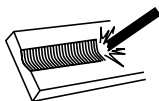

For teeth working in coarse rocky conditions the bead is deposited in the direction of the material travel, allowing the large lumps of rock etc. to slide along the top of the hardfacing bead.



In fine sandy conditions the stringer beads should be transverse (across) the path of material travel, this allows the fine materials to compact between the beads and so give self protection.



For conditions where there is a combination of coarse and fine material the "checker" or "waffle" pattern is generally used.

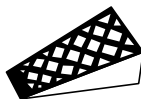

#### 3. Dot Pattern.

For less critical areas such as the sides/ends of buckets, shovels etc. the dot pattern is used. It is useful in keeping the heat input down, particularly for the 11%-14% austenitic manganese steels. The dot size is generally 15-20mm diameter by 8mm high and placed at about 50mm centres.

## HARDFACING INFORMATION

## Cobalarc Product Selection by Alloy Type and Application

Group 1. Steel Products	Alloy Type	AS/NZS class	Description & Applications
Cobalarc Mangcraft, Stoody Dynamang-O	Austenitic manganese steels.	1215-A4 1215-B7	Tough, work hardens on impact. Crusher jaws, rolls, mantles, ball mill liners.
Cobalarc Austex,	Austenitic stainless steels.	1315-A4	Tough, corrosion and heat resistant. Forms strong welds between dissimilar irons / steels. Tramway rails, crossings, bearings at medium temperatures, tractor track grousers, anvils, pneumatic tools, shredder bars.
Cobalarc 350, Stoody Super Buildup-G	Low carbon martensitic steels.	1435-A4 1435-B5/7	Excellent compressive strength and metal-to-metal wear resistance. Re-building and surfacing of clutch parts, railway points and crossings, track components.
Cobalarc Toolcraft	Tool steels.	1560-A4	Strong, secondary hardening characteristics. Machine tools, lathe tools, shears, drills, guillotine blades, cutting knives, punches, dies, metal forming tools.
Cobalarc 650, Cobalarc 750, Stoody 965-G-O Stoody 850-O	High carbon martensitic steels.	1855-A4 1860-A4 1855-B5/B7 1865-B7	Hard, relatively in-expensive, good general abrasion resistance. Surfacing of post-hole augers, earth scoops, conveyor screws, drag line buckets, pump housings, subsoiler teeth, scarifier points, plough shears.

## HARDFACING INFORMATION

### Cobalarc Product Selection by Alloy Type and Application

Group 2. Chromium White Irons	Alloy Type	AS/NZS class	Description & Applications
Cobalarc CR70, Stoody 101 HC-G-O	Austenitic chromium carbide irons.	2355-A4  2360-B5/B7	Strong, high level of chromium carbides for excellent abrasion resistance. Ideal for gouging (coarse) abrasion conditions. Crusher cones and mantles, swing hammers, grizzly bars, scarifier points, shovel teeth, earthmoving buckets and sugar harvesting and milling equipment.
Cobalarc 9e,	Complex chromium carbide irons.	2460-A1	Strong, high level of complex carbides for excellent abrasion resistance. Ideal for wide range of abrasion conditions with relatively high impact loading. Sizing screens, ball mill liner plates, dredge pump impellers, crusher jaws, pug mill paddles, agricultural implements, scrapers, fan blades, bucket lips and side plates.
Cobalarc BoroChrome, Stoody Fineclad-O	Martensitic chromium carbide irons.	2560-A4  2565-B7	Strong, high level of chromium carbides for excellent abrasion resistance. Ideal for low stress scratching (wet or dry) abrasion conditions with relatively low impact loading. Wet applications in mining and crushing industries, agricultural implements, sand slingers, cement chutes, fan blades and slurry pump components.

Group 3. Tungsten Carbide Composites	Alloy Type	AS/NZS class	Description & Applications
Stoody Tube Borium,	Tungsten carbide granules in an iron rich matrix.	3460-A1	Hard, tungsten carbide (WC) iron deposit resistant to severe abrasion and low impact loading. Ideal for earth cutting and boring applications. Rock drills, ditcher teeth, ripper points, oil drill collars auger blades and teeth, oil well drills, bulldozer end bits.

## HARDFACING INFORMATION

### Cobalarc Product Selection by Alloy Type and Application

Group 4. Copper Alloys	Alloy Type	AS/NZS class	Description & Applications
Bronzecraft AC-DC,	Phosphor bronze	6200-A2	Good bearing properties, wear & corrosion resistant. Medium load bearings, crankpress, transmission housings, pump rotors.
Comweld Manganese Bronze, Comweld Comcoat C	High tensile brass.	6300-C1  6300-C1	Low friction bearing characteristics, wear and corrosion resistant. Light load bearings, Hydraulic rams and pistons.
Comweld Nickel Bronze, Comweld Comcoat N	Nickel bronze (9-13% Ni).	6400-C1  6400-C1	Low friction bearing characteristics, work hardenable, corrosion resistant. Gear teeth, cams, bearings, percussion heads, slides, service where work hardening is required.

## HARDFACING INFORMATION

### Costing Information:

Based on the fact that the decision to hardface is an economic one, that is, to extend the working life of a component (ie. rebuild rather than replace), then the calculation of the true cost of hardfacing the component is important.

Points to consider in calculation of an estimated cost include:-

1. Volume of build-up of hardsurfacing deposit required.
2. Cost of welding consumables.
3. Preparation prior to welding (including grinding, preheat etc.).
4. Post weld requirements (heat treatment, grinding, machining etc.).
5. Power, labour and overhead costs.

Other important factors relating to the selection of the welding process/consumable are:-

1. Deposition rate (kg of weld metal / hr).
2. Deposition efficiency (%).
3. Operating factor or Duty cycle (%).

### Cost Calculations:

WELDING ELECTRODE OR WIRE COST ; A (\$ per kg of weld metal deposited):

$$\frac{\text{Electrode or Wire Price (\$/kg)}}{\text{Deposition Efficiency * (\%)}} = A (\$/\text{kg})$$

FLUX COST ; B (\$AW only) (\$ per kg of weld metal deposited):

$$\frac{\text{Flux Price (\$/kg) x Consumption Rate (kg/hr)}}{\text{Deposition Rate (kg/hr)}} = B (\$/\text{kg})$$

POWER COST ; C (\$ per kg of weld metal deposited):

$$\frac{\text{Cost of power (\$/kWhr) x Volts x Amps}}{\text{Deposition Rate (kg/hr)}} = C (\$/\text{kg})$$

## HARDFACING INFORMATION

### COSTING INFORMATION:

LABOUR COST; D (\$ per kg of weld metal deposited):

$$\frac{\text{Labour Cost (\$/hr)} \times \text{Deposition Rate (kg/hr)}}{\text{Operating Factor* (\%)}} = D (\$/\text{kg})$$

OVERHEAD COST; E (\$ per kg of weld metal deposited):

$$\frac{\text{Overhead cost (\$/hr)} \times \text{Deposition Rate (kg/hr)}}{\text{Operating Factor* (\%)}} = E (\$/\text{kg})$$

Total cost; F (\$ per kg of weld metal deposited):

$$F (\$/\text{kg}) = A + B + C + D + E$$

Total cost (TC) of hardfacing the steel component:

$$TC (\$) = \text{Volume of Build-up or hard surfacing deposit (cm}^3\text{)} \times F \times 0.008$$

#### \*Deposition Efficiencies and Operating Factors for Hardfacing Cost Calculations:

Process	Deposit Efficiency (%)	Typical Operating Factor (%)
MMAW	60 - 75	15 - 20
FCAW <sup>†</sup>	80 - 90	25 - 30
SAW	90 - 95 <sup>#</sup>	35 - 40

<sup>†</sup> Semi-automatic operation.

<sup>#</sup> SAW wire only.



## DEPOSITION DATA

## Deposition Rates, Electrode Efficiency, and Electrode Weld Metal Recovery!

## What are the differences?

## Deposition Rates

The deposition rate of a welding consumable (electrode, wire or rod) is the rate at which weld metal is deposited (melted) onto a metal surface. Deposition rate is expressed in kilograms per hour (kg/hr).

Deposition rate is based on continuous operation, not allowing for stops and starts such as, electrode change overs, chipping slag, cleaning spatter, machine adjustments or other reasons.

When welding current is increased so does the deposition rate. When electrical stick out is increased in the case of GMAW and FCAW the deposition rate will also increase.

Deposition rates are calculated by doing actual welding tests, and the following shows the formula for measuring deposition rates.

Deposition Rate = Weight of test plate before welding – Weight of test plate after welding ÷ Measured period of time (normally 60 seconds).

e.g. Plate before welding: 2kg - 2.95kg Plate after welding = 95grams, welded in 60 seconds.  
95grams x 60/1000 = 5.7kg/hr.

## Electrode Efficiency (Deposition Efficiency)

Technically to ISO 2401-1972 electrode efficiency (AS/NZS 1553.1:1995 deposition efficiency) is the difference between the weight of the weld metal deposited and the weight of the filler metal consumed (not including flux and stub ends) in making the weld. The efficiency of an electrode is calculated by using the following formula;

Electrode Efficiency % to ISO 2401 and AS/NZS 1553.1 =

$$\frac{\text{Weight of test plate including weld metal} - \text{Weight of test plate before welding}}{\text{Mass of the Core Wire of 5 electrodes} - \text{Weight of core wire of the 5 stub ends}} \times 100$$

e.g. Satincraft 13 Ø4mm x 380mm.

Plate before welding: 2kg - 2.15kg Plate after welding = 150grams,

weight of five (5) electrode core wires, Ø4mm x 380mm long before welding = 188grams,

weight of five (5) electrode stub ends, Ø4mm x 50mm long after welding = 24.7grams,

150grams ÷ 163.3grams x 100 = 91.85% Electrode Efficiency (Deposition Efficiency).

e.g. Ferrocrafter 22 Ø3.2mm x 380mm.

Plate before welding: 2kg - 2.167kg Plate after welding = 167grams,

weight of five (5) electrode core wires, Ø3.2mm x 380mm long before welding = 124grams,

weight of five (5) electrode stub ends, Ø3.2mm x 50mm long after welding = 16.3grams,

167grams ÷ 107.7grams x 100 = 155.06% Electrode Efficiency (Deposition Efficiency).

## DEPOSITION DATA

### Electrode Weld Metal Recovery (Process Efficiency)

Electrode weld metal recovery to ISO 2401-1972 allows us to calculate the amount of welding consumable which will actually be deposited into the finished weld metal less any waste such as stub ends, slag and spatter not adhered to the test plate.

An example is when 100kgs of electrodes are used with a quoted efficiency of 60%, the net result is that only 60kg of the weight of that electrode will actually end up in the deposited weld metal. The remaining 40% (40kg) of the electrode is waste.

To achieve weld metal recovery rates practical tests are carried out by weighing the test plate before and after welding, weighing the consumables before welding and then using the following formula allowing for 50mm stub ends. If the welder discards more than 50mm stub ends than the recovery rate (process efficiency) will be lower.

Weld Metal Recovery % to ISO 2401 =

$$\frac{\text{Weight of test plate before welding} - \text{Weight of test plate after welding}}{\text{Weight of the Consumable}} \times 100$$

e.g. Satinraft 13 Ø4mm x 380mm.

Plate before welding: 2kg - 2.15kg Plate after welding = 150grams,  
weight of five (5) electrodes, Ø4mm x 380mm long before welding = 261.20grams,  
150grams ÷ 261.20grams x 100 = 57.43% Weld Metal Recovery (Process Efficiency).

e.g. Ferrocraft 22 Ø3.2mm x 380mm.

Plate before welding: 2kg - 2.167kg Plate after welding = 167grams,  
weight of five (5) electrodes, Ø3.2mm x 380mm long before welding = 281.50grams,  
167grams ÷ 281.50grams x 100 = 59.33% Weld Metal Recovery (Process Efficiency).

### General Process Efficiencies

Generally process efficiencies can be stated as averages for costing purposes. The following table outlines CIGWELD's suggested process efficiency percentages.

If the welding application calls for the Oxy-Acetylene or GTAW welding processes to be employed, then it is prudent to use all of the consumable by joining stub ends to ensure that 100% of the filler metal is utilised.

Welding Process	Average Efficiency	
Gas Tungsten Arc Welding (GTAW) & Oxy-Acetylene Welding (OAW)	100%	
Manual Metal Arc Welding (MMAW)	60%	
Gas Metal Arc Welding (GMAW) Short Arc,	Ar + 25% CO <sub>2</sub>	92%
Gas Metal Arc Welding (GMAW) Spray Arc,	Ar + 25% CO <sub>2</sub>	95%
Gas Metal Arc Welding (GMAW) Pulse Arc,	Ar + 25% CO <sub>2</sub>	98%
Flux Cored Arc Welding (FCAW) E70T-4 types,	self shielded	82%
Flux Cored Arc Welding (FCAW) E71T-1 types,	Ar + 25% CO <sub>2</sub>	85%
Flux Cored Arc Welding (FCAW) E70T-5 types,	Ar + 25% CO <sub>2</sub>	88%
Flux Cored Arc Welding (FCAW) E70C-6M types,	Ar + 25% CO <sub>2</sub>	92%
Stoody Flux Cored Hardfacing Wires	Gas shielded	80%

GMAW and FCAW average efficiencies can vary in result depending upon the shielding gases used, machine settings, stick out, spatter losses, wire sniped off before starts etc.

**DEPOSITION DATA**
**CIGWELD Electrodes, Deposition Rates, Electrode Efficiencies, and  
Electrode Weld Metal Recovery Rates**

The following Table lists some popular CIGWELD consumables and their Deposition Rates, Electrode Efficiencies and Weld Metal Recovery Rates:

CIGWELD Product	Size (mm)	Amps	Deposition Rate kg/hr	Electrode Efficiency	Weld Metal Recovery
Ferrocrafter 12XP	3.2	110	0.90	109%	66%
Ferrocrafter 12XP	4.0	150	1.20	111%	69%
Satinerafter 13	3.2	115	0.92	91%	56%
Satinerafter 13	4.0	160	1.30	92%	58%
Ferrocrafter 11	3.2	110	1.00	90%	64%
Ferrocrafter 11	4.0	145	1.30	90%	66%
Ferrocrafter 21	3.2	120	1.20	113%	63%
Ferrocrafter 21	4.0	170	1.70	112%	62%
Ferrocrafter 22	3.2	150	2.00	155%	59%
Ferrocrafter 22	4.0	210	2.80	157%	61%
Ferrocrafter 16TXP	3.2	120	1.20	95%	58%
Ferrocrafter 16TXP	4.0	165	1.60	90%	56%
Ferrocrafter 7016	3.2	120	1.10	101%	63%
Ferrocrafter 7016	4.0	170	1.50	97%	60%
Ferrocrafter 61	3.2	125	1.30	110%	57%
Ferrocrafter 61	4.0	180	1.80	113%	59%
Alloyerafter 90	3.2	125	1.30	111%	60%
Alloyerafter 90	4.0	180	1.80	114%	62%
Satinerome 316L-17	3.2	95	0.90	105%	55%
Satinerome 316L-17	4.0	130	1.10	108%	54%
Casterafter 55	3.2	100	0.95	116%	69%
Casterafter 55	4.0	125	1.15	115%	70%
Cobalarc 750	3.2	115	1.00	109%	62%
Cobalarc 750	4.0	145	1.30	112%	64%
Cobalarc CR70	3.2	115	1.20	191%	69%
Cobalarc CR70	4.0	165	1.70	206%	71%

The information provided in this table is a guide only, actual on the job figures may vary. Results are influenced by many factors including, welding parameters, arc length, travel speed and machine characteristics.

DEPOSITION DATA

CIGWELD Solid and Flux Cored Wires, Deposition and

Weld Metal Recovery Rates

The following Table lists some popular CIGWELD consumables and their Deposition and Weld Metal Recovery Rates:

CIGWELD Product	Size (mm)	Volts	Amps	WFS m/min	Deposition Rate kg/hr	Weld Metal Recovery
Autocraft LW1-6	0.8	20	150	12.0	2.5	96%
Autocraft LW1-6	0.9	26	180	12.0	3.1	96%
Autocraft LW1-6	1.0	28	240	13.5	4.8	95%
Autocraft LW1-6	1.2	32	300	10.8	5.6	97%
Autocraft Silicon Bronze	0.9	24	180	13.2	3.2	95%
Autocraft 316LSi	0.9	22	180	10.0	2.8	97%
Autocraft 316LSi	1.2	26	250	8.5	4.4	98%
Autocraft ALS356	1.0	22	180	16.3	1.5	90%
Autocraft ALS356	1.2	24	220	14.0	2.5	92%
Satin-Cor XP	1.6	28	300	5.5	4.3	86%
Satin-Cor XP	1.6	29	350	6.5	5.4	87%
Satin-Cor XP	1.6	30	400	7.0	6.0	89%
Satin-Cor XP	2.4	30	400	4.2	5.7	85%
Satin-Cor XP	2.4	31	450	5.0	6.8	86%
Satin-Cor XP	2.4	32	500	6.0	8.2	90%
Verti-Cor 3XP	1.2	25	200	6.7	2.7	86%
Verti-Cor 3XP	1.2	26	250	9.9	3.8	84%
Verti-Cor 3XP	1.2	28	320	15.0	5.9	88%
Verti-Cor 3XP	1.6	27	300	6.2	4.1	86%
Verti-Cor 3XP	1.6	28	350	9.5	6.4	81%
Verti-Cor 3XP	1.6	29	400	12.0	8.1	88%
Metal-Cor XP	1.2	26	250	10.0	5.0	92%
Metal-Cor XP	1.6	28	350	6.6	5.6	94%
Supre-Cor 5	1.2	22	170	7.8	2.3	86%
Supre-Cor 5	1.6	26	320	5.9	3.3	89%
Tensi-Cor 110TXP	1.6	28	280	5.0	3.0	88%
Tensi-Cor 110TXP	2.4	29	400	3.8	5.8	90%
Verti-Cor 309LT	1.2	26	190	11.4	3.7	84%
Shield-Cor 4XP	2.4	29	375	5.4	7.0	84%
Shield-Cor 4XP	2.8	30	450	3.5	6.4	86%
Shield-Cor 15	0.9	17	120	3.9	0.7	75%
Shield-Cor 11	1.2	17	150	3.0	1.0	80%

The information provided in this table is based on welding with constant voltage (C.V.) GMA Welding machines. Results may vary and are influenced on the job by shielding gases used, machine settings, stick out, spatter losses, wire sniped off before starts etc.

## DEPOSITION DATA

### Manual Arc Electrode Consumption Calculator Guide

#### Instructions for Use of this Data

The following tables provide data on the approximate mass in kilograms required of the different types of electrodes for welding the various weld joints used throughout industry today. This data will aid in estimating material requirements and costs. The basis for the following tabulations is given below. Where variations from the given conditions or joint preparations are encountered, adjustments in the tabulated values must be made to compensate for such differences.

#### Basis of Calculations

Electrode requirements have been calculated as follows:

Where  $M$  = Mass of electrodes required  
 $D$  = Mass of weld metal to be deposited  
 $E$  = Proportion of electrode lost  
 $M = \frac{D}{1 - E}$

To arrive at the mass of weld metal to be deposited it is necessary to calculate first the volume of metal to be added (area of the cross section of the weld multiplied by the length). This volumetric value is converted to mass by multiplying by the factor 0.0079 kilograms per cubic centimetre for steel.

#### Square Butt Joints, Welded both sides

Joint Dimensions		kg of electrodes per linear metre of weld* (Approx.)	kg of weldmetal deposited per liner metre of weld (Approx.)
Plate Thickness	Root Gap (R)	With Reinforcement**	With Reinforcement**
3mm	0	0.23	0.14
	1mm	0.26	0.16
5mm	1mm	0.38	0.23
	1.6mm	0.41	0.25
6mm	1.6mm	0.48	0.29
	2.5mm	0.56	0.34

\* Includes spatter losses and 50mm stub end loss.

\*\* Height of Reinforcement = 2mm.

## DEPOSITION DATA

### Horizontal-Vertical (HV) Fillet welds

Fillet Weld leg length Dimensions	kg of electrodes per linear metre of weld* (Approx.)	kg of weldmetal deposited per liner metre of weld (Approx.)
3mm	0.06	0.04
5mm	0.16	0.10
6mm	0.24	0.14
8mm	0.42	0.25
10mm	0.65	0.39
12mm	0.95	0.57
16mm	1.68	1.01
20mm	2.62	1.57
25mm	4.10	2.46

\* Fillet weld figures are calculated based on true mitre fillets. Convex or overlapped fillets can increase these figures by 33% or more.

### Single Vee Butt Joints, (single groove butts)

Joint Dimensions			kg of electrodes per linear metre of weld* (Approx.)	kg of weldmetal deposited per liner metre of weld (Approx.)
Plate Thickness	Root Face (F)	Root Gap (R)	With Reinforcement**	With Reinforcement**
6mm	1.6mm	1.6mm	0.39	0.23
8mm	1.6mm	1.6mm	0.63	0.38
10mm	1.6mm	1.6mm	0.87	0.52
12mm	3mm	3mm	1.33	0.80
16mm	3mm	3mm	2.22	1.33
20mm	3mm	3mm	3.37	2.02
25mm	3mm	3mm	5.14	3.08

\* Includes spatter, 50mm stub ends and back gouging losses.

\*\* Height of Reinforcement = 2mm.

### Double Vee Butt Joints, Welded both sides (double groove butts)

Joint Dimensions			kg of electrodes per linear metre of weld* (Approx.)	kg of weldmetal deposited per liner metre of weld (Approx.)
Plate Thickness	Root Face (F)	Root Gap (R)	With Reinforcement**	With Reinforcement**
12mm	1.6mm	1.6mm	0.92	0.55
16mm	1.6mm	1.6mm	1.46	0.88
20mm	1.6mm	1.6mm	2.12	1.27
25mm	3mm	3mm	3.33	2.00

\* Includes spatter, 50mm stub ends and back gouging losses.

\*\* Height of Reinforcement = 2mm.

## DEPOSITION DATA

### Consumable Weights & Lengths Tables:

#### 1. Gas Metal Arc Welding (GMAW - MIG) Wires for Mild and Low Alloy Steels

WIRE SIZE (mm)	0.6	0.8	0.9	1.2	1.6
gms of wire per metre	2.2	4	4.85	8.5	15.7
metres of wire per kg	450	254	200	113	63

#### 2. Flux Cored Arc Welding (FCAW) Wires for Mild and Low Alloy Steels

WIRE SIZE (mm)	1.2	1.6	2.0	2.4
gms of wire per metre	7.5	13	21	28.5
metres of wire per kg	132	77	50	36

#### 3. Submerged Arc Welding (SAW) Wires for Mild and Low Alloy Steels

WIRE SIZE (mm)	2.0	2.4	3.2	4.0
gms of wire per metre	24.6	35.5	63	99
metres of wire per kg	41	28	16	10

#### 4. Stainless Steel Gas Metal Arc Welding (GMAW - MIG) Wires

WIRE SIZE (mm)	0.9	1.2
gms of wire per metre	5.1	9
metres of wire per kg	198	111

#### 5. Aluminium Gas Metal Arc Welding (GMAW - MIG) Wires

WIRE SIZE (mm)	0.9	1.2	1.6
gms of wire per metre	1.7	3.1	5.4
metres of wire per kg	582	327.5	184

#### 6. Autopak Gas Metal Arc Welding (GMAW - MIG) Wires

WIRE SIZE (mm)	0.9	1.0	1.2	1.6
gms of wire per metre	4.85	6.1	8.5	15.7
km of wire /250kg Pack	52	41	29	22 (350kg Pack)

TECHNICAL FACTS AND FIGURES

Mathematical Symbols

- + Plus or Positive
- Minus or Negative
- ± Plus or Minus  
Positive or Negative
- × Multiply By
- ÷ Divided By
- = Equal To
- ≠ Not Equal To
- ≈ Approximatley Equal To
- ~ Of the Order Of or  
Similar To
- > Greater Than
- < Less Than
- ⋈ Not Greater Than
- ⋡ Not Less Than
- ≥ Greater Than or Equal To
- ≤ Less Than or Equal To
- √ Square Root Of
- ∞ Infinity
- ∝ Proportional To
- ∑ Sum Of
- ∏ Product Of
- △ Difference
- ∴ Therefore
- π Pi
- ∥ Parllel To
- ⊥ Perpendicular To
- ∴ Is To (Ratio)

Frustum of a Right Cone

Apex Height = H,  $H = \frac{D \times h}{D - d}$

Side Height = SH,

$SH = \sqrt{R^2 + h^2}$

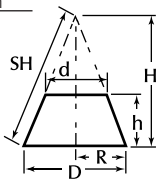

Pythagoras Theorem

$a = \sqrt{c^2 - b^2}$

$b = \sqrt{c^2 - a^2}$

$c = \sqrt{a^2 + b^2}$

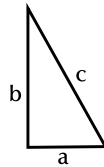

Frustum of an Oblique Cone

Apex Height = H,

$H = \frac{D \times h}{D - d}$

Horizontal  
Distance = Y,

$Y = \frac{D \times S}{D - d}$

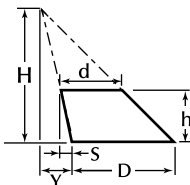

Square Plate from  
Circular Plate  
For the area of the  
largest square plate  
that can be cut  
from a circular plate

$A = \frac{D^2}{2}$

Length of side of largest square plate.



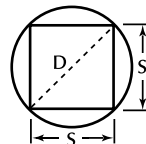

$S = 0.7071 \times D, D = 1.4142 \times S$





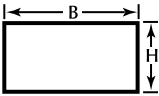
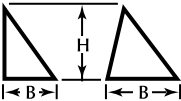
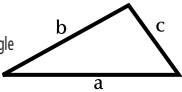

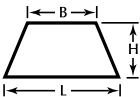
## TECHNICAL FACTS AND FIGURES

## Geometric Shapes - Perimeters and Areas

	Perimeter = P	Area = A
Square 	$P = 4 \times S$	$A = S \times S$ or $A = S^2$
Rectangle 	$P = 2 (B + H)$	$A = B \times H$
Triangle 	$P = \text{Sum of 3 sides}$	$A = \frac{B \times H}{2}$
Scalene Triangle 	$P = a + b + c$	$A = \sqrt{S(S-a)(S-b)(S-c)}$ $S = a + b + c$
Equilateral Triangle 	$P = 3 \times S$	$A = \frac{0.433 \times S^2}{2}$
Circle 	$P = \pi \times D$ $D = \frac{P}{\pi}$	$A = \frac{\pi \times D^2}{4}$ or $A = \pi R^2$
Trapezium 	$P = \text{Sum of 4 Sides}$	$A = \frac{H \times (L + B)}{2}$
Hexagon 	$P = 6 \times S$	$A = 0.866 \times B^2$
Octagon 	$P = 8 \times S$	$A = 0.828 \times L^2$

**TECHNICAL FACTS AND FIGURES**

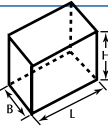
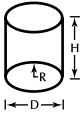
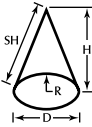
**Geometric Shapes - Surface Area, Length of Welding and Volumes**

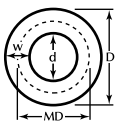
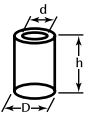
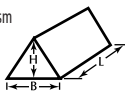
	Surface Area = SA Length of Welding = LW	Volume = V
Rectangular & Square Tanks 	$SA = 2(L \times B) + 2(L \times H) + 2(B \times H)$ $LW = 4L + 4B + 4H$	$V = L \times B \times H$
Cylinder 	$SA = \pi \times D \times H + 2 \times \frac{\pi \times D^2}{4}$ $LW = 2 \times \pi \times D + H$	$V = \pi \times R^2 \times H$ or $V = 0.7854 \times D^2 \times H$
Cone 	$SA = \frac{\pi \times D \times SH}{2} + \frac{\pi \times D^2}{4}$ $SH = \sqrt{H^2 + R^2}$ $LW = \pi \times D = SH$	$V = \frac{\pi \times R^2 \times H}{3}$ or $V = 0.2618 \times D^2 \times H$
Sphere 	$SA = \pi \times D^2$	$V = \frac{\pi \times D^3}{6}$ or $V = 0.5236 \times D^3$
Annulus 	$SA = \pi \times MD \times W$ or $SA = \frac{\pi}{4}(D^2 - d^2)$ or $SA = 0.7854(D^2 - d^2)$	
Hollow Cylinder 		$V = \pi \times H(D^2 - d^2)$ or $V = 0.7854 \times H(D^2 - d^2)$
Triangular Prism 		$V = \frac{H \times B \times L}{2}$

1 m<sup>3</sup> contains 1000 litres.  
 1 litre of water has a mass of 1kg.  
 1 m<sup>3</sup> of water has a mass of 1000 kg

N.B.  $\pi = 3.1416$

## TECHNICAL FACTS AND FIGURES

### Common Welding Conversion Data

Electrode Sizes		Pack Weights		Pack Weights		Lengths	
Imperial Unit	Metric Unit	Imperial Unit	Metric Unit	Metric Unit	Imperial Unit	Imperial Unit	Metric Unit
.025"	0.6mm	1lb	.45kg	1kg	2.20lb	2"	50.8mm
.030"	0.8mm	2lb	.91kg	2.5kg	5.50lb	4"	101.6mm
.035"	0.9mm	5lb	2.27kg	5kg	11.02lb	6"	152.4mm
.040"	1.0mm	10lb	4.54kg	10kg	22.05lb	8"	203.4mm
.045"	1.2mm	16lb	7.26kg	15kg	33.07lb	10"	254mm
.052"	1.3mm	20lb	9.07kg	17kg	37.48lb	12"	304.8mm
1/16"	1.6mm	25lb	11.34kg	25kg	55.11lb	14"	355.6mm
5/64"	2.0mm	30lb	13.61kg	30kg	66.14lb	15"	381mm
3/32"	2.4mm	33lb	14.97kg	50kg	110.23lb	16"	406.4mm
7/64"	2.8mm	40lb	18.14kg	60kg	132.27lb	17"	431.8mm
.120"	3.0mm	45lb	21.77kg	70kg	154.32lb	18"	457.2mm
1/8"	3.2mm	50lb	22.68kg	100kg	220.46lb	20"	508mm
5/32"	4.0mm	250lb	113.40kg	250kg	551.15lb	22"	558.8mm
3/16"	4.8mm	400lb	181.44kg	300kg	661.37lb	26"	660.4mm
7/32"	5.6mm	500lb	226.80kg	500kg	1102.29lb	30"	762mm
1/4"	6.4mm	600lb	272.16kg	810kg	1785.71lb	36"	914.4mm
5/16"	8.0mm	700lb	317.52kg	918kg	2023.81lb	39"	990.6mm
3/8"	9.5mm	1000lb	453.60kg	1000kg	2204.58lb	40"	1016mm

### Conversion Data

Imperial to Metric		Metric to Imperial		Imperial to Metric		Metric to Imperial	
Length				Weight & Gas Flow			
inch x 25.4 = mm	mm x 0.0394 = inch	oz x 28.349 = grams	grams x 0.035 = oz	inch x 2.54 = cm	cm x 0.394 = inch	stones x 6.350 = kg	kg x 0.157 = stones
feet x 0.3048 = metre	metre x 3.281 = feet	lb x 0.4536 = kg	kg x 2.2045 = lb	mile x 1.609 = km	km x 0.621 = miles	cft/hr x 0.4719 = L/min	L/min x 2.119 = cft/hr
Energy & Speed				Pressure & Stress			
ft.lb x 1.35582 = joules	joules x 0.73756 = ft.lb	psi x 6.895 = kPa	kPa x 0.14504 = psi	ft/min x 0.305 = m/min	m/min x 3.281 = ft/min	psi x 0.006895 = MPa	MPa x 145.04 = psi
in/sec x 2.54 = cm/sec	cm/sec x 0.394 = in/sec	psi x 0.006895 = N/mm <sup>2</sup>	N/mm <sup>2</sup> x 145.04 = psi	in/min x 0.423 = mm/sec	mm/sec x 0.394 = in/min	psi x 0.0703 = kg/cm <sup>2</sup>	kg/cm <sup>2</sup> x 14.223 = psi
in/min x 0.0254 = m/min	m/min x 393.78 = in/min	ksi x 6.895 = MPa	MPa x 0.14504 = ksi	Deposition Rate			
lb/hr x 0.4536 = kg/hr	kg/hr x 2.2045 = lb/hr	Heat Input = Joules (Volts x Amps x 60 ÷ WFS)		J/inch x 39.37 = J/metre	J/metre x .0254 = J/inch		

## TECHNICAL FACTS AND FIGURES

### Inch to Millimetre Conversion

INCHES	mm	INCHES
1/64	.0156	.40
	.0197	.5
1/32	.0313	.79
	.0394	1
3/64	.0469	1.19
	.0591	1.5
1/16	.0625	1.59
5/64	.0781	1.98
	.0787	2
3/32	.0938	2.38
	.0984	2.5
7/64	.1094	2.78
	.1181	3
1/8	.1250	3.18
	.1378	3.5
9/64	.1406	3.57
5/32	.1563	3.97
	.1575	4
11/64	.1719	4.37
	.1772	4.5
3/16	.1875	4.76
	.1969	5
13/64	.1969	5.16
	.2031	5.5
7/32	.2188	5.56
15/64	.2344	5.95
	.2362	6
1/4	.2500	6.35
	.2559	6.5
17/64	.2656	6.75
	.2756	7
9/32	.2813	7.14
	.2953	7.5
19/64	.2969	7.54
5/16	.3125	7.94
	.3150	8
21/64	.3281	8.33
	.3346	8.5
11/32	.3438	8.73
	.3543	9
23/64	.3594	9.13
	.3740	9.5
3/8	.3750	9.53
25/64	.3906	9.92
	.3937	10
13/32	.4063	10.32
	.4134	10.5
27/64	.4219	10.72
	.4331	11
7/16	.4375	11.11
	.4528	11.5
29/64	.4531	11.51
15/32	.4688	11.91
	.4724	12
31/64	.4844	12.30
	.4921	12.5
1/2	.5000	12.7

mm		
	.5118	13
33/64	.5156	13.10
17/32	.5313	13.49
	.5315	13.5
35/64	.5469	13.89
	.5512	14
9/16	.5625	14.29
	.5709	14.5
37/64	.5781	14.68
	.5906	15
19/32	.5938	15.08
39/64	.6094	15.48
	.6102	15.5
5/8	.6250	15.88
	.6299	16
41/64	.6406	16.27
	.6496	16.5
21/32	.6563	16.67
	.6693	17
43/64	.6719	17.07
11/16	.6875	17.46
	.6890	17.5
45/64	.7031	17.86
	.7087	18
23/32	.7188	18.26
	.7283	18.5
47/64	.7344	18.65
	.7480	19
3/4	.7500	19.05
49/64	.7656	19.45
	.7677	19.5
25/32	.7813	19.84
	.7874	20
51/64	.7969	20.24
	.8071	20.5
13/16	.8125	20.64
	.8268	21
53/64	.8281	21.03
27/32	.8438	21.43
	.8465	21.5
55/64	.8594	21.83
	.8661	22
7/8	.8750	22.23
	.8858	22.5
57/64	.8906	22.62
	.9055	23
29/32	.9063	23.02
59/64	.9219	23.42
	.9252	23.5
15/16	.9375	23.81
	.9449	24
61/64	.9531	24.21
	.9646	24.5
31/32	.9688	24.61
	.9843	25
63/64	.9844	25
	1.0000	25.4

## TECHNICAL FACTS AND FIGURES

### Conversion Tables - Travel and Wire Feed Speeds

Inches per min	Feet per hour	mm per min	cm per min	Metres per min	Metres per hour
3	15	75	7.5	.075	4.5
4	20	100	10.0	.100	6.0
5	25	125	12.5	.125	7.5
6	30	150	15.0	.150	9.0
8	40	205	20.5	.205	12.3
10	50	255	25.5	.255	15.3
12	60	305	30.5	.305	18.3
14	70	355	35.5	.355	21.3
16	80	405	40.5	.405	24.3
18	90	455	45.5	.455	27.3
20	100	510	51.0	.510	30.6
22	110	560	56.0	.560	33.6
24	120	610	61.0	.610	36.6
26	130	660	66.0	.660	39.6
28	140	710	71.0	.710	42.6
30	150	760	76.0	.760	45.6
32	160	810	81.0	.810	48.6
34	170	865	86.5	.865	51.9
36	180	915	91.5	.915	54.9
38	190	965	96.5	.965	57.9
40	200	1015	101.5	1.015	60.9
45	225	1150	115.0	1.150	69.0
50	250	1275	127.5	1.275	76.5
55	276	1400	140.0	1.400	84.0
60	300	1525	152.5	1.525	91.5
65	325	1650	165.0	1.650	99.0
70	350	1775	177.5	1.775	107.0
75	375	1900	190.0	1.900	114.0
80	400	2030	203.0	2.03	122.0
85	425	2160	216.0	2.16	129.5
90	450	2285	228.5	2.29	137.5
95	475	2410	241.0	2.41	144.5
100	500	2540	254.0	2.54	152.5

Inches/ min.	Metres/ min.	Inches/ min.	Metres/ min.	Inches/ min.	Metres/ min.
110	2.80	200	5.10	425	10.80
120	3.05	225	5.70	450	11.45
130	3.30	250	6.35	475	12.10
140	3.55	275	7.00	500	12.70
150	3.80	300	7.60	525	13.30
160	4.05	325	8.25	550	13.95
170	4.30	350	8.90	575	14.60
180	4.55	375	9.50	600	15.25
190	4.90	400	10.15	625	15.90

Some of the above figures are "rounded".

Conversion: Inches/min. x 5 = Feet/Hour

mm/min. x .6 = Metres/Hour

Inches/min. x 25.4 = mm/min.

## TECHNICAL FACTS AND FIGURES

### Metric Multiplying Factors

Name Prefix	Symbol	Value
Mega	M	$\times 10^6$
Kilo	k	$\times 10^3$
Hecto	h	$\times 10^2$
Deca	da	$\times 10$
deci	d	$\times 10^{-1}$
centi	c	$\times 10^{-2}$
milli	m	$\times 10^{-3}$
micro	$\mu$	$\times 10^{-6}$

### Symbols for Elements

Ac Actinium	Ge Germanium	Pr Praseodymium
Ag Silver	H Hydrogen	Pt Platinum
Al Aluminium	He Helium	Pu Plutonium
Am Americium	Hf Hafnium	Ra Radium
Ar Argon	Hg Mercury	Rb Rubidium
As Arsenic	Ho Holmium	Re Rhenium
At Astatine	I Iodine	Rh Rhodium
Au Gold	In Indium	Rn Radon
B Boron	Ir Iridium	Ru Ruthenium
Ba Barium	K Potassium	S Sulphur
Be Beryllium	Kr Krypton	Sb Antimony
Bi Bismuth	La Lanthanum	Sc Scandium
Bk Berkelium	Li Lithium	Se Selenium
Br Bromine	Lr Lawrencium	Si Silicon
C Carbon	Lu Lutetium	Sm Samarium
Ca Calcium	Md Mendelevium	Sn Tin
Cd Cadmium	Mg Magnesium	Sr Strontium
Ce Cerium	Mn Manganese	Ta Tantalum
Cf Californium	Mo Molybdenum	Tb Terbium
Cl Chlorine	N Nitrogen	Tc Technetium
Cm Curium	Na Sodium	Te Tellurium
Co Cobalt	Nb Niobium	Th Thorium
Cr Chromium	Nd Neodymium	Ti Titanium
Cs Caesium	Ne Neon	Tl Thallium
Cu Copper	Ni Nickel	Tm Thulium
Dy Dysprosium	No Nobelium	U Uranium
Er Erbium	Np Neptunium	V Vanadium
Es Einsteinium	O Oxygen	W Tungsten
Eu Europium	Os Osmium	Xe Xenon
F Fluorine	Ph Phosphorus	Y Yttrium
Fe Iron	Pa Protactinium	Yb Ytterbium
Fm Fermium	Pb Lead	Zn Zinc
Fr Francium	Pd Palladium	Zr Zirconium
Ga Gallium	Pm Promethium	
Gd Gadolinium	Po Polonium	

## TECHNICAL FACTS AND FIGURES

## Comweld Rods per kg.

Diameter mm	Steel (750 mm)	Copper and Bronze (750 mm)	Aluminium (1 metre)	Cast Iron (700 mm)
1.6	84	68	185	-
2.4	37	34	82	-
3.2	21	19	46	-
5.0	9	8	19	8
6.3	5.5	5	12	4.3

Chart shows approximate number of COMWELD welding rods per kg.

## Physical Properties of Metals

Element and Symbol	Atomic Weight	Melting Point °C	*Specific Heat	Density gms/cm <sup>3</sup>
Aluminium (Al)	26.97	660	0.211	2.78
Antimony (Sb)	121.76	630	0.050	6.68
Barium (Ba)	137.36	704	0.068	3.75
Bismuth (Bi)	209.00	271	0.030	9.80
Cadmium (Cd)	112.41	321	0.056	8.64
Caesium (Cs)	132.91	30	0.054	1.87
Calcium (Ca)	40.08	850	0.158	1.55
Cerium (Ce)	140.13	804	0.045	6.92
Chromium (Cr)	52.01	1800	0.111	7.1
Cobalt (Co)	58.94	1492	0.103	8.6
Copper (Cu)	63.54	1083	0.093	8.93
Gold (Au)	197.0	1063	0.031	19.32
Iridium (Ir)	192.2	2443	0.031	22.65
Iron, Wrought (Fe)	55.85	1535	0.109	7.87
Lead (Pb)	207.21	327	0.031	11.37
Magnesium (Mg)	24.32	650	0.245	1.74
Manganese (Mn)	54.94	1240	0.107	7.44
Mercury (Hg)	200.61	-39	0.033	13.56
Molybdenum (Mo)	95.95	2625	0.065	10.0
Nickel (Ni)	58.69	1453	0.109	8.9
Platinum (Pt)	195.09	1769	0.032	21.45
Potassium (K)	39.1	63	0.177	0.862
Rhodium (Rh)	102.91	1960	0.058	12.41
Silver (Ag)	107.88	961	0.056	10.5
Sodium (Na)	22.991	98	0.296	0.971
Strontium (Sr)	87.63	770	-	2.6
Tellurium (Te)	127.61	452	0.048	6.24
Tin (Sn)	118.70	232	0.056	7.29
Titanium (Ti)	47.90	1660	0.126	4.5
Tungsten (W)	183.92	3380	0.034	19.3
Uranium (U)	238.07	1132	0.028	18.7
Vanadium (V)	50.95	1730	0.115	6.0
Zinc (Zn)	65.38	419	0.094	7.1

\*In cal / gm / °C

TECHNICAL FACTS AND FIGURES

Comparison of Hardness Scales

Vickers hardness (diamond pyramid) H.V. 30 kg load	Brinell (steel ball HB) 3000 kg load	Rockwell hardness (direct reading test) HRC	Approx. Tensile Strength MPa
100	95	-	327
120	115	-	393
140	135	-	455
160	150	-	527
180	170	-	598
200	190	-	658
220	210	-	723
240	230	20	780
260	250	24	850
280	265	27	923
300	285	30	972
320	305	32	1041
340	320	34	1102
360	340	37	1166
380	360	39	1231
400	380	41	1290
420	395	43	1355
440	415	45	1417
460	435	46	1481
480	450	48	1546
500	470	49	1610
520	485	51	1674
540	505	52	1739
560	520	53	1802
580	535	54	1868
600	520	55	1922
620	535	56	1984
640	550	57	2015
660	565	58	2069
680	580	59	2108
700	590	60	2150
725	605	61	-
750	615	62	-
800	625	64	-
850	640	66	-
900	-	67	-
950	-	68	-
1000	-	69	-
1100	-	71	-
1200	-	72	-

NOTE: Figures quoted are only approximate.



## TECHNICAL FACTS AND FIGURES

## MASSES OF COMMON METALS

	Specific Gravity	kg / m <sup>3</sup>	gms / cm <sup>3</sup>
Cast Iron	7.68	7688	7.67
Steel	7.85	7849	7.85
Copper	8.94	8938	8.91
Tin Bronze	8.89	8899	8.9
Brass	8.41	8441	8.44
Zinc	7.14	6887	6.86
Aluminium	2.69	2691	2.7
Lead	11.34	11373	11.37
Magnesium	1.74	1746	1.74
Titanium	4.51	4517	4.51
Tin	7.30	7304	7.30
Stainless Steel (18/8)	7.93	7929	7.93
Stainless Steel (16%Cr)	7.75	7720	7.72
Stainless Steel (27%Cr)	7.61	7576	7.58
Aluminium bronze	8.15	8089	8.11
Phosphor bronze	8.85	8842	8.82
Manganese bronze	8.35	8329	8.30
Cupro-nickel	8.95	8970	8.94
Nickel Silver	8.75	8730	8.71
Everdur	8.55	8521	8.52
Cusilman	8.55	8521	8.52
Nickel	8.91	8858	8.85
Monel	8.85	8810	8.80
Inconel	8.55	8521	8.52

TECHNICAL FACTS AND FIGURES

TEMPERATURE CONVERSIONS

To find a temperature conversion, read the centre column (the **bold** numbers) and read to the left side for degrees Celsius (°C) or the right side for degrees Fahrenheit (°F). eg. 10°F, reading the **bold** number, equals -12.2°C in the left column, or 10°C reading the **bold** number, equals 50°F in the right column.

°C	↔	°F	↔	°C	↔	°F
-101		<b>-150</b>		<b>-238</b>		
-95.6		<b>-140</b>		<b>-220</b>		
-90.0		<b>-130</b>		<b>-202</b>		
-84.4		<b>-120</b>		<b>-184</b>		
-78.9		<b>-110</b>		<b>-166</b>		
-73.3		<b>-100</b>		<b>-148</b>		
-67.8		<b>-90</b>		<b>-130</b>		
-62.2		<b>-80</b>		<b>-112</b>		
-56.7		<b>-70</b>		<b>-94</b>		
-51.1		<b>-60</b>		<b>-76</b>		
-45.6		<b>-50</b>		<b>-58</b>		
-40.0		<b>-40</b>		<b>-40</b>		
-34.4		<b>-30</b>		<b>-22</b>		
-28.9		<b>-20</b>		<b>-4</b>		
-23.3		<b>-10</b>		<b>14</b>		
-17.8		<b>0</b>		<b>32</b>		
-17.2		<b>1</b>		<b>33.8</b>		
-16.7		<b>2</b>		<b>35.6</b>		
-16.1		<b>3</b>		<b>37.4</b>		
-15.6		<b>4</b>		<b>39.2</b>		
-15.0		<b>5</b>		<b>41.0</b>		
-14.4		<b>6</b>		<b>42.8</b>		
-13.9		<b>7</b>		<b>44.6</b>		
-13.3		<b>8</b>		<b>46.4</b>		
-12.8		<b>9</b>		<b>48.2</b>		
-12.2		<b>10</b>		<b>50</b>		
-11.7		<b>11</b>		<b>51.8</b>		
-11.1		<b>12</b>		<b>53.6</b>		
-10.6		<b>13</b>		<b>55.4</b>		
-10.0		<b>14</b>		<b>57.2</b>		
-9.44		<b>15</b>		<b>59.0</b>		
-8.89		<b>16</b>		<b>60.8</b>		
-8.33		<b>17</b>		<b>62.6</b>		
-7.78		<b>18</b>		<b>64.4</b>		
-7.22		<b>19</b>		<b>66.2</b>		
-6.67		<b>20</b>		<b>68.0</b>		
-6.11		<b>21</b>		<b>69.8</b>		
-5.56		<b>22</b>		<b>71.6</b>		
-5.00		<b>23</b>		<b>73.4</b>		
-4.44		<b>24</b>		<b>75.2</b>		
-3.89		<b>25</b>		<b>77.0</b>		
-3.33		<b>26</b>		<b>78.8</b>		
-2.78		<b>27</b>		<b>80.6</b>		
-2.22		<b>28</b>		<b>82.4</b>		
-1.67		<b>29</b>		<b>84.2</b>		
-1.11		<b>30</b>		<b>86.0</b>		
-0.56		<b>31</b>		<b>87.8</b>		
0		<b>32</b>		<b>89.6</b>		
0.56		<b>33</b>		<b>91.4</b>		
1.11		<b>34</b>		<b>93.2</b>		
1.67		<b>35</b>		<b>95.0</b>		
2.22		<b>36</b>		<b>96.8</b>		
2.78		<b>37</b>		<b>98.6</b>		
3.33		<b>38</b>		<b>100.4</b>		
3.89		<b>39</b>		<b>102.2</b>		
4.44		<b>40</b>		<b>104.0</b>		

°C	↔	°F	↔	°C	↔	°F
5.00		<b>41</b>		<b>105.8</b>		
5.56		<b>42</b>		<b>107.6</b>		
6.11		<b>43</b>		<b>109.4</b>		
6.67		<b>44</b>		<b>111.2</b>		
7.22		<b>45</b>		<b>113.0</b>		
7.78		<b>46</b>		<b>114.8</b>		
8.33		<b>47</b>		<b>116.6</b>		
8.89		<b>48</b>		<b>118.4</b>		
9.44		<b>49</b>		<b>120.2</b>		
10.0		<b>50</b>		<b>122.0</b>		
10.6		<b>51</b>		<b>123.8</b>		
11.1		<b>52</b>		<b>125.6</b>		
11.7		<b>53</b>		<b>127.4</b>		
12.2		<b>54</b>		<b>129.2</b>		
12.8		<b>55</b>		<b>131.0</b>		
13.3		<b>56</b>		<b>132.8</b>		
13.9		<b>57</b>		<b>134.6</b>		
14.4		<b>58</b>		<b>136.4</b>		
15.0		<b>59</b>		<b>138.2</b>		
15.6		<b>60</b>		<b>140.0</b>		
16.1		<b>61</b>		<b>141.8</b>		
16.7		<b>62</b>		<b>143.6</b>		
17.2		<b>63</b>		<b>145.4</b>		
17.8		<b>64</b>		<b>147.2</b>		
18.3		<b>65</b>		<b>149.0</b>		
18.9		<b>66</b>		<b>150.8</b>		
19.4		<b>67</b>		<b>152.6</b>		
20.0		<b>68</b>		<b>154.4</b>		
20.6		<b>69</b>		<b>156.2</b>		
21.1		<b>70</b>		<b>158.0</b>		
21.7		<b>71</b>		<b>159.8</b>		
22.2		<b>72</b>		<b>161.6</b>		
22.8		<b>73</b>		<b>163.4</b>		
23.3		<b>74</b>		<b>165.2</b>		
23.9		<b>75</b>		<b>167.0</b>		
24.4		<b>76</b>		<b>168.8</b>		
25.0		<b>77</b>		<b>170.6</b>		
25.6		<b>78</b>		<b>172.4</b>		
26.1		<b>79</b>		<b>174.2</b>		
26.7		<b>80</b>		<b>176.0</b>		
27.2		<b>81</b>		<b>177.8</b>		
27.8		<b>82</b>		<b>179.6</b>		
28.3		<b>83</b>		<b>181.4</b>		
28.9		<b>84</b>		<b>183.2</b>		
29.4		<b>85</b>		<b>185.0</b>		
30.0		<b>86</b>		<b>186.8</b>		
30.6		<b>87</b>		<b>188.6</b>		
31.1		<b>88</b>		<b>190.4</b>		
31.7		<b>89</b>		<b>192.2</b>		
32.2		<b>90</b>		<b>194.0</b>		
32.8		<b>91</b>		<b>195.8</b>		
33.3		<b>92</b>		<b>197.6</b>		
33.9		<b>93</b>		<b>199.4</b>		
34.4		<b>94</b>		<b>201.2</b>		
35.0		<b>95</b>		<b>203.0</b>		
35.6		<b>96</b>		<b>204.8</b>		

TEMPERATURE CONVERSION FORMULA:  $^{\circ}\text{C} = \frac{5}{9} \times (^{\circ}\text{F} - 32)$   $^{\circ}\text{F} = (\frac{9}{5} \times ^{\circ}\text{C}) + 32$

TECHNICAL FACTS AND FIGURES

TEMPERATURE CONVERSIONS

To find a temperature conversion, read the centre column (the **bold** numbers) and read to the left side for degrees Celsius (°C) or the right side for degrees Fahrenheit (°F). eg. 250°F, reading the **bold** number, equals 121°C in the left column, or 10°C reading the **bold** number, equals 482°F in the right column.

°C	↔	°F	↔	°F
°C		°C		°F
36.1		<b>97</b>		206.6
36.7		<b>98</b>		208.4
<b>37.2</b>		<b>99</b>		210.2
38		<b>100</b>		212
43		<b>110</b>		230
49		<b>120</b>		248
54		<b>130</b>		266
60		<b>140</b>		284
66		<b>150</b>		302
71		<b>160</b>		320
77		<b>170</b>		338
82		<b>180</b>		356
88		<b>190</b>		374
93		<b>200</b>		392
99		<b>210</b>		410
100		<b>212</b>		413
104		<b>220</b>		428
110		<b>230</b>		446
116		<b>240</b>		464
121		<b>250</b>		482
127		<b>260</b>		500
132		<b>270</b>		518
138		<b>280</b>		536
143		<b>290</b>		554
149		<b>300</b>		572
154		<b>310</b>		590
160		<b>320</b>		608
166		<b>330</b>		626
171		<b>340</b>		644
177		<b>350</b>		662
182		<b>360</b>		680
188		<b>370</b>		698
193		<b>380</b>		716
199		<b>390</b>		734
204		<b>400</b>		752
210		<b>410</b>		770
216		<b>420</b>		788
221		<b>430</b>		806
227		<b>440</b>		824
232		<b>450</b>		842
238		<b>460</b>		860
243		<b>470</b>		878
249		<b>480</b>		896
254		<b>490</b>		914
260		<b>500</b>		932
266		<b>510</b>		950
271		<b>520</b>		968

°C	↔	°F	↔	°F
°C		°C		°F
277		<b>530</b>		986
282		<b>540</b>		1004
288		<b>550</b>		1022
293		<b>560</b>		1040
299		<b>570</b>		1058
304		<b>580</b>		1076
310		<b>590</b>		1094
316		<b>600</b>		1112
321		<b>610</b>		1130
327		<b>620</b>		1148
332		<b>630</b>		1166
338		<b>640</b>		1184
343		<b>650</b>		1202
349		<b>660</b>		1220
354		<b>670</b>		1238
360		<b>680</b>		1256
366		<b>690</b>		1274
371		<b>700</b>		1292
377		<b>710</b>		1310
382		<b>720</b>		1328
388		<b>730</b>		1346
393		<b>740</b>		1364
399		<b>750</b>		1382
404		<b>760</b>		1400
410		<b>770</b>		1418
416		<b>780</b>		1436
421		<b>790</b>		1454
427		<b>800</b>		1472
432		<b>810</b>		1490
438		<b>820</b>		1508
443		<b>830</b>		1526
449		<b>840</b>		1544
454		<b>850</b>		1562
460		<b>860</b>		1580
466		<b>870</b>		1598
471		<b>880</b>		1616
477		<b>890</b>		1634
482		<b>900</b>		1652
488		<b>910</b>		1670
493		<b>920</b>		1688
499		<b>930</b>		1706
504		<b>940</b>		1724
510		<b>950</b>		1742
516		<b>960</b>		1760
521		<b>970</b>		1778
527		<b>980</b>		1796
532		<b>990</b>		1814
538		<b>1000</b>		1832

TEMPERATURE CONVERSION FORMULA: °C =  $\frac{5}{9} \times (°F - 32)$  °F =  $(\frac{9}{5} \times °C) + 32$

# TECHNICAL FACTS AND FIGURES

## STRENGTH AND IMPACT ENERGY DATA - CONVERSIONS

### STRENGTH CONVERSIONS

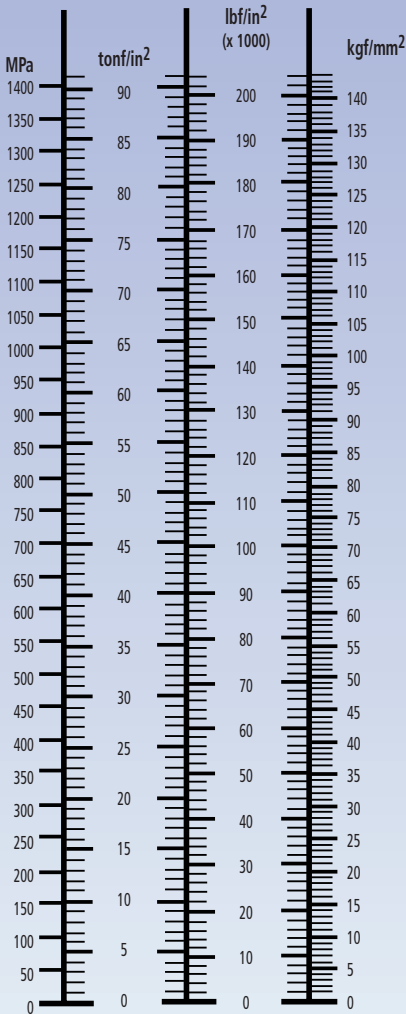

### IMPACT ENERGY CONVERSIONS

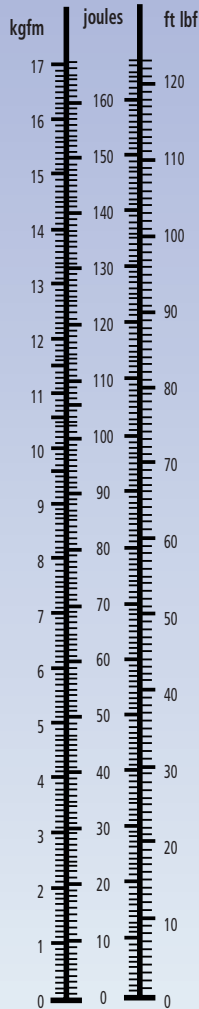

## TECHNICAL FACTS AND FIGURES

### Gas Pressures - Gas Welding and Cutting

#### Gas Welding:

Acetylene Pressure	100 kPa	(15 psi)
Oxygen Pressure	100 kPa	(15 psi)

#### Gas Cutting: (Manual)

Acetylene Pressure	100 kPa	(15 psi)
Oxygen Pressure	200 kPa	(30 psi)

#### Oxygen Cylinder:

Pressure when full	13700 kPa	(Approx. 2000 psi)
--------------------	-----------	--------------------

#### Acetylene cylinder:

Pressure when full	1550 kPa	(Approx. 200 psi)
--------------------	----------	-------------------

Note: 15 psi = 100 kPa

### TEMPERATURE INDICATION

Where preheating is required, the use of temperature-indicating crayons is strongly recommended as combining reasonable accuracy with convenience. Where these are not available, however, an approximate idea of temperature may be obtained by the use of temper colours. These are colours produced on a clean surface of the material due to extremely thin oxide films, and vary in colour with temperature. It should be noted that various alloying additions can have a marked effect on oxidation, and the colours and temperatures indicated below apply only to plain carbon or low alloy steels. In order to obtain a reasonable result the surface should be freshly ground, and care should be taken to avoid applying heat directly to the ground surface.

#### TEMPER COLOURS

Pale Straw	200°C
Straw	220°C
Dark Straw	230°C
Brownish Red	250°C
Violet	280°C
Dark Blue	290°C
Cornflour Blue	300°C
Pale Blue	320°C
Greyish Blue	340°C

These colours are as seen by daylight and apply to plain carbon steels. They also apply only when the steel has been at temperature for a limited period, prolonged periods producing a colour indicative of a higher temperature.

## TECHNICAL FACTS AND FIGURES

## CHEMICAL NAMES AND FORMULA OF COMMON NAMES

COMMON NAME	CHEMICAL NAME	FORMULA	DESCRIPTION
Muriatic Acid or, Spirits of Salts	Hydrochloric Acid	HCl	Strongly fuming colourless liquid
Oil of Vitriol	Sulphuric Acid	H <sub>2</sub> SO <sub>4</sub>	Heavy, colourless, viscous liquid
Baking soda	Sodium Bicarbonate	NaHCO <sub>3</sub>	White powder
Black lead	Carbon or Graphite	C	Black powder
Bleaching powder	Calcium chloro-hypo chlorite	CaOCl <sub>2</sub>	White powder smelling of chlorine
Bluestone (Blue Vitriol)	Copper Sulphate	CuSO <sub>4</sub> 5H <sub>2</sub> O	Large blue crystals
Caustic Potash	Potassium Hydroxide	KOH	White Deliquescent powder
Caustic Soda	Sodium Hydroxide	NaOH	White Deliquescent powder
Chalk, Limestone, Marble	Calcium Carbonate (more or less)	CaCO <sub>3</sub>	White powder; Marble-crystalline form
Epsom Salts	Magnesium Sulphate	MgSO <sub>4</sub> 7H <sub>2</sub> O	Small colourless crystals
Coke, Charcoal	Carbon (impure)	C	Brittle black solid
Chile Saltpeter	Sodium Nitrate	NaNO <sub>3</sub>	White crystalline subst.
Condies Crystals	Potassium Permanganate	KMnO <sub>4</sub>	Small purple crystals
Glauber Salts	Sodium Sulphate	Na <sub>2</sub> SO <sub>4</sub> 10H <sub>2</sub> O	Large, colourless crystals
Green Vitriol	Iron sulphate	FeSO <sub>4</sub> 7H <sub>2</sub> O	Green crystals
Laughing Gas	Nitrous Oxide	N <sub>2</sub> O	Colourless gas
Lime (quicklime)	Calcium Oxide	CaO	White powder
Limewater	Solution of Calcium Hydroxide	Ca(OH) <sub>2</sub>	Clear, bitter liquid
Liquid Ammonia	Ammonium Hydroxide	NH <sub>4</sub> OH	Strongly fuming liquid
Litharge	Lead Monoxide	PbO	Orange powder
Red lead	Triplumbic Tetroxide	Pb <sub>3</sub> O <sub>4</sub>	Fine, heavy red powder
Sal Ammoniac	Ammonium Chloride	NH <sub>4</sub> Cl	White crystalline solid
Saltpeter (Nitre)	Potassium Nitrate	KNO <sub>3</sub>	Colourless crystals
Slaked Lime	Calcium Hydroxide	Ca(OH) <sub>2</sub>	White powder
Washing Soda	Sodium Carbonate	Na <sub>2</sub> CO <sub>3</sub> 10H <sub>2</sub> O	Large white crystals
Vinegar	Acetic Acid (weak)	CH <sub>3</sub> COOH	Brown liquid







