



**3M** Science.  
Applied to Life.™



3M Precision Grinding & Finishing  
**3M™ Conventional  
Grinding Wheels**

# Your partner with a century of grinding experience

3M Precision Grinding & Finishing bundles the know-how and experience of the Winterthur, Slip-Naxos and WENDT brands under the umbrella brand 3M. As a part of the 3M Abrasive Systems Division, 3M Precision Grinding & Finishing is your committed and competent supplier for abrasives, tools, service and support.

<b>CONVENTIONAL GRINDING</b>	<b>4</b>
<b>QUALITIES &amp; GRAIN SIZES</b>	<b>6</b>
<b>HARDNESS &amp; STRUCTURE</b>	<b>8</b>
<b>BONDS &amp; SHAPES</b>	<b>10</b>
<b>SPECIFICATIONS</b>	<b>16</b>
<b>SAFETY INFORMATION</b>	<b>18</b>
<b>RESPONSIBILITIES &amp; TASKS</b>	<b>22</b>
<b>MODERN PRODUCTION &amp; COMPREHENSIVE SERVICES</b>	<b>24</b>
<b>PROCESS OPTIMIZATION</b>	<b>26</b>
<b>QUALITY CONTROL</b>	<b>27</b>
<b>3M™ GRINDING WHEELS</b>	<b>28</b>
<b>3M™ CUBITRON™ II VITRIFIED WHEELS</b>	<b>30</b>
<b>3M™ VITRIFIED GRINDING WHEELS 22VD</b>	<b>32</b>
<b>3M™ VITRIFIED GRINDING WHEELS 33VB</b>	<b>33</b>
<b>3M™ V450-BOND</b>	<b>34</b>
<b>3M™ GRINDING WHEELS AND DRESSING TOOLS</b>	<b>35</b>

# Conventional grinding

For a good reason with 3M

## The definition of grinding

Grinding is an abrasive, path-based manufacturing process for manual or automatic machining of surfaces or for cutting off parts of using minerals and bonded abrasive grit. According to DIN 8580, it belongs to the cutting group and to the subgroup of machining with a geometrically undefined cutting edge.

## Why grinding?

To manufacture precise products with corresponding shape or positional tolerances or after heat treating a material, it is essential to fine grind a workpiece in order to obtain the required surface finish quality while staying within the correspondingly low shape, positional, and dimensional tolerances. The benefits of the grinding over other types of machining include the ability to machine harder materials well, the high dimensional and geometrical precision, and the low waviness and roughness of the ground surfaces ( $R_z = 0.5$  to  $10 \mu\text{m}$ ). Due to the large number of cutting edges compared to other hard fine machining processes, the highest process reliability is guaranteed.

## Conventional grinding

In conventional grinding, aluminum oxide ( $\text{Al}_2\text{O}_3$ ) and silicon carbide ( $\text{SiC}$ ) are used as the minerals. Aluminum oxide is extremely reasonably priced, very versatile, and can be used for almost every grinding application. The slightly more expensive and slightly harder silicon carbide grinds with ease due to the needle-shaped abrasive grit and is primarily used to grind high alloy steels, cast iron, non-ferrous metals, and for fine-grain grinding wheels. The most important applications are found in the automobile, machine tools, tool and die, glass, and steel industries.

## Conventional grinding with 3M

As a full scale provider of machines and accessories, we at 3M are one of the top companies for modern grinding technology. Throughout the entire grinding process on the way to perfect surfaces, we represent the peak of technology in grinding wheels, dressing tools, and machines. In addition to the optimization of processes and working speeds, the ability to react quickly to new materials is the primary motivation for most innovations.



# Qualities and grain sizes

New 3M abrasive names	3M abrasives	Grain type
11A	A	Regular aluminum oxide
33A	3A	Semi-friable aluminum oxide
	28A	Monocrystalline aluminum oxide mixture
	29A	Monocrystalline aluminum oxide
	31A	Mix of regular, semi-friable, and high-grade white aluminum oxide
	35A	Semi-friable aluminum oxide mixture
40A	42A	High-grade white aluminum oxide
40A	49A	High-grade white aluminum oxide with a blue bond
40A	53A	High-grade white aluminum oxide with a brown bond
	54A	High-grade white aluminum oxide with a green bond
55NA	55N	Special aluminum oxide mixture (NanoWin)
	57A	High-grade pink aluminum oxide
	64A	Monocrystalline aluminum oxide and high-grade pink aluminum oxide
	68A	High-grade red aluminum oxide
	77A	Special aluminum oxide
	79A	Sintered aluminum oxide mixture
	81A	Sintered aluminum oxide mixture
93NA	93N	Special aluminum oxide mixture (NanoWin)
	93A	Sintered aluminum oxide mixture
	93DA	Cubitron II with 3M Precision-Shaped Grain
	99DA	Cubitron II with 3M Precision-Shaped Grain
13C	C	Black silicon carbide
15C	11C	Green silicon carbide

A = Aluminum oxide  
 C = Silicon carbide  
 NA = Special grains  
 DA = 3M Precision-Shaped Grain



3M Precision-Shaped Grain (Sintered corundum)

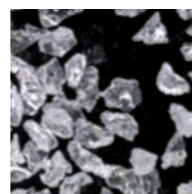

Aluminum oxide white

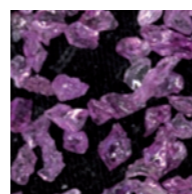

Aluminum oxide pink



Aluminum oxide regular

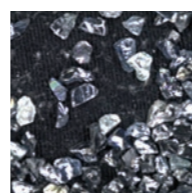

Black SIC

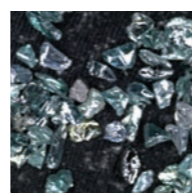

Green SIC

The assignments of the grain numbers to certain particle size distributions are specified according to an internationally valid grain size standard (see the table). Very fine grains (micrograins starting at about grain no. 230) are obtained from slurries.

The surface finish roughness produced during grinding not only depends on the abrasive grit size, but also on the grinding and dressing method. Coarsely dressed grinding wheels yield higher performance, but also produce a rougher surface. When grinding profiles or

small radii, the particle size has a direct influence on the selection of the specification. The dressing process must be taken into account in this case. The diameter of the abrasive grain should fit 2–3 times inside the smallest concave radius of the workpiece.

Grain No.	Dimensions (Mm)		Grain size
	from	to	
8	2.83	2.00	Very coarse
10	2.38	1.68	
12	2.00	1.41	
14	1.68	1.19	
16	1.41	1.00	Coarse
20	1.19	0.84	
24	0.84	0.60	
30	0.71	0.50	
36	0.60	0.42	Medium
46	0.42	0.30	
54	0.35	0.25	
60	0.30	0.21	
70	0.25	0.18	Fine
80	0.21	0.15	
90	0.18	0.13	
100	0.15	0.11	
120	0.13	0.09	Very fine
150	0.11	0.06	
180	0.09	0.05	
220	0.075	0.045	
240	0.047	0.043	
280	0.038	0.035	
320	0.031	0.028	
400	0.018	0.016	
500	0.014	0.012	
600	0.010	0.008	
800	0.008	0.006	
1000	0.005	0.004	
1200	0.004	0.003	

Grinding performance		Edge retention/surface finish quality	
Coarse	Medium	Fine	Very fine
20-36	46-80	90-220	240-600
Grinding performance			
Edge retention/surface finish quality			

# Hardness & structure

For your individual requirements

## Hardness

The hardness is determined by the following factors:

- Abrasive grit size
- Bond ratio
- Bond type
- Porosity
- Grinding wheel structure

The term "grinding wheel hardness" does not refer to the hardness of the abrasive grit, but to the ability of the bond to resist breaking off of the abrasive grit. The softer the wheel, the easier it is for the abrasive grit to break off. Letter codes A (soft) – Z (hard) refer to the hardness grade (see the table).

The wheel hardness also depends on the grain size and porosity. In a given wheel hardness range (for example hardness F), a grinding wheel with small grains and fine pores appears "harder" during the grinding process than a wheel with large grains and coarse pores.

Letter Code	Hardness Grade
A / B / C / D /	Extremely soft
E / F	Very soft
G / H	Soft
J / K / L	Medium
M / N / O / P	Hard
Q / R / S / T	Very hard
U / V / W / X / Y / Z	Extremely hard

The hardness scale defines the proportion of binder. The further down the specification of the hardness is in the alphabet, the more binder the grinding wheel contains.

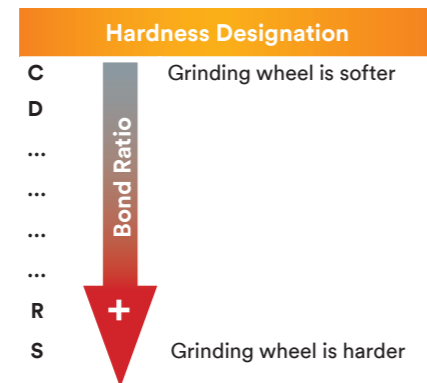

The higher the bond ratio, the harder the grinding wheel!

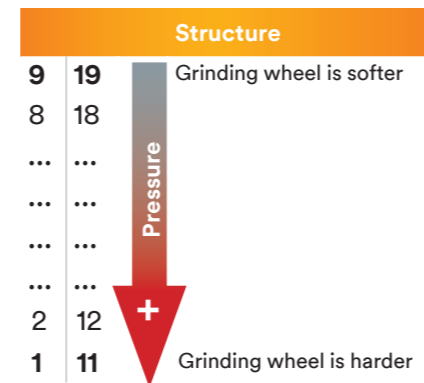

The numbers on the left describe the hardness of the grinding wheel.

## Structure

Every grinding wheel has a natural porosity. At 3M, the porosity is expressed in structure numbers ranging from 1 to 9, which are referred to as normal structures. The higher the structure number, the more porous the grinding wheel. The natural porosity of a grinding wheel can be increased by adding a special pore formation agent that creates additional pore space. This increased porosity is expressed using the structure numbers 11–19, which are referred to as porous structures. During the manufacture of grinding wheels, the numbers 1 and 11 stand for the highest pressure while 9 and 19 stand for the lowest pressures.

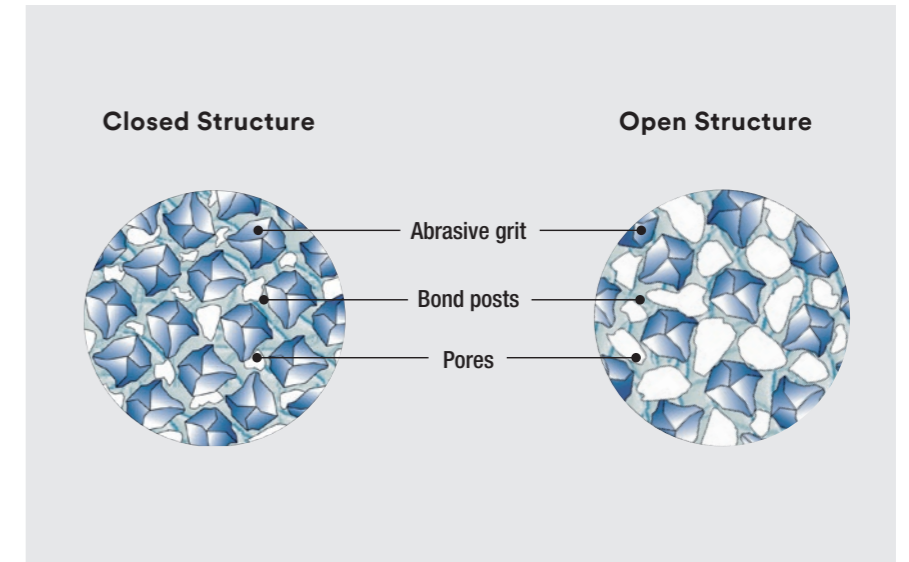

Natural Porosity	Artificial Porosity
Normal Structure	Porous Structure
1 2 3 4 5 6 7 8 9	11 12 13 14 15 16 17 18 19

The higher the structure number, the more open the grain.

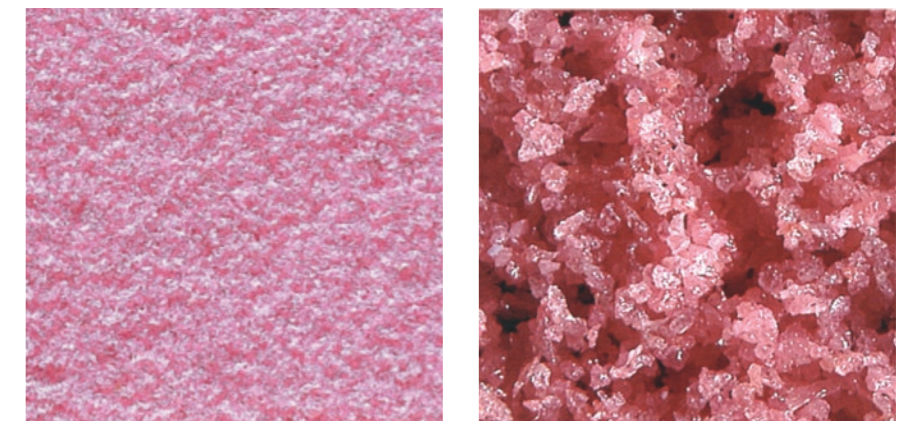

Comparison of the grinding wheel porosity

# Bonds & shapes

We manufacture your grinding wheel

## Bond

The bond does not have any grinding action. Its most important task is to provide the grinding wheel with stability. The bond ratio determines the hardness and influences the free-cutting ability of the grinding wheel.

We manufacture vitrified bonded and synthetic resin bonded grinding wheels for the most demanding applications. The strength, hardness, and cutting ability of a grinding wheel depends on the type of bond used and its percentage of the total volume.

## Synthetic resin bond (letter code B)

Synthetic resin bonds consist of phenolic resins and various fillers that have a decisive influence on the bonding properties. Synthetic resin bonded grinding wheels are hardened at a temperature of about 180°C. They are less sensitive to sudden temperature changes, shock, and impact than vitrified bonded grinding wheels. However, exposure to chemicals and long storage periods should be avoided.

## Vitrified bond

(Letter code V with bond number, for example 300W)

Our vitrified bonds are manufactured primarily of synthetic, technical glasses referred to as low temperature bonds and are fired at approx. 900°C. They can be manufactured identically again and again. They are insensitive to chemicals and can be stored for indefinitely, but abrupt temperature changes, shock, and impact are to be avoided, though. The bond hardness is specified by the bond number (for example 300W or 600W).

## Fiberglass-reinforced synthetic resin bond (letter code BF)

Synthetic resin bonded, fiberglass-reinforced roughing and cut-off grinding wheels are equipped with fiberglass mesh and thus exhibit higher strength.

## STANDARD SHAPES 1, 5, 7

T1 - D x T x H

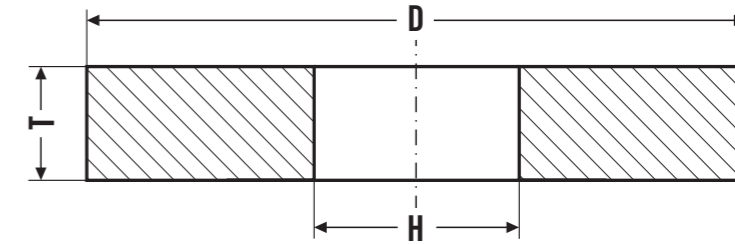

T5 - D x T x H - 1 - P x F

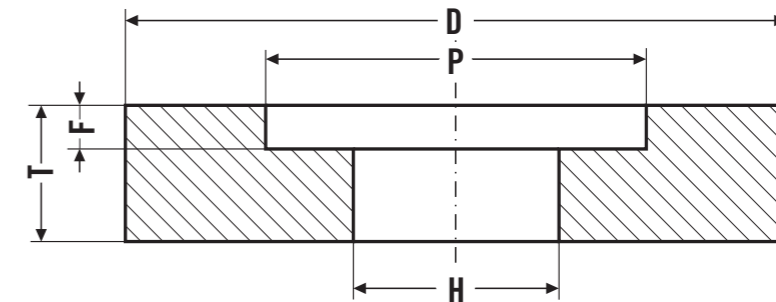

T7 - D x T x H - 2 - P x F

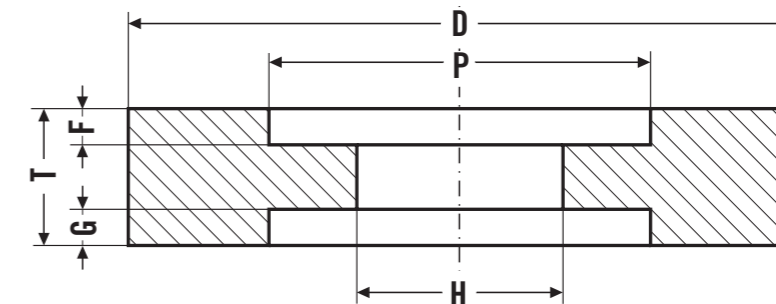

Caution: The grinding wheel may only be weakened to one half the thickness of the wheel by gouges.

## EDGE SHAPES (FOR SHAPES 1, 5, 7)

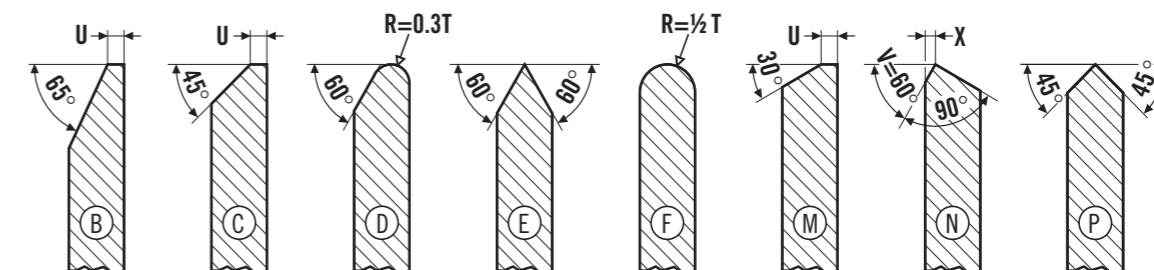

STANDARD SHAPES 6, 11, 12, 3, 4, 2

T6 - D x T x H - W - E

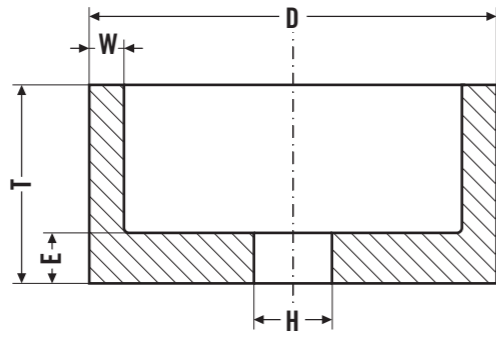

T11 - D/J x T x H - W - E - K

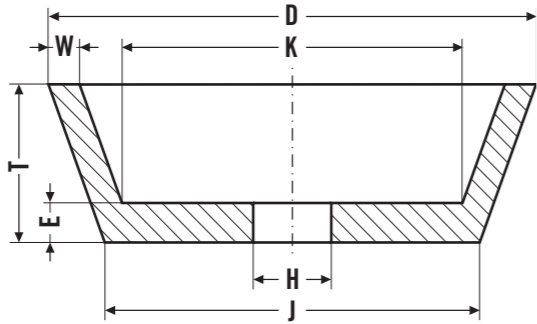

T12 - D/J x T/E/U x H

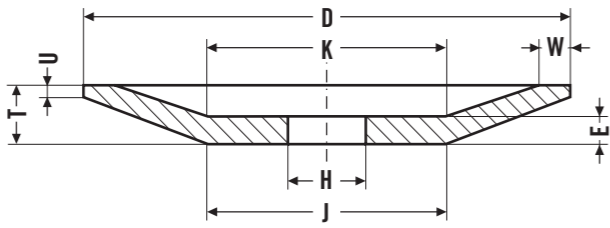

T3 - D/J x T/U x H

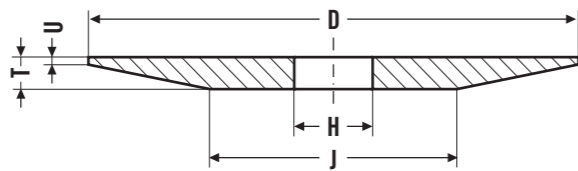

T4 - D/J x T/U x H

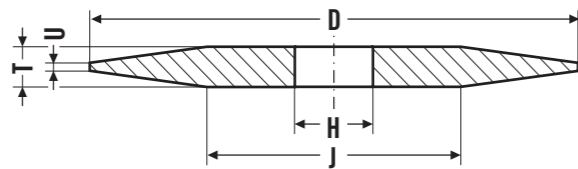

T2 - D x T - W

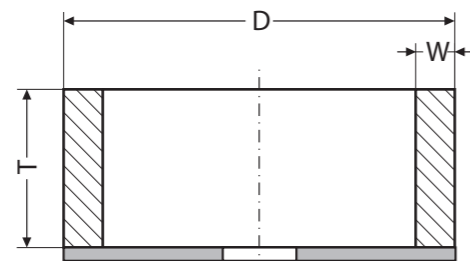

STANDARD SHAPES 20 TO 26

T20 - D/K x T/N x H

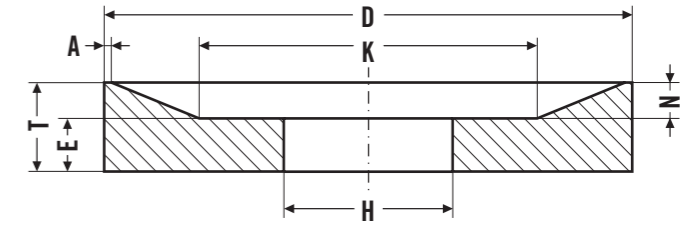

T21 - D/K x T/N x H

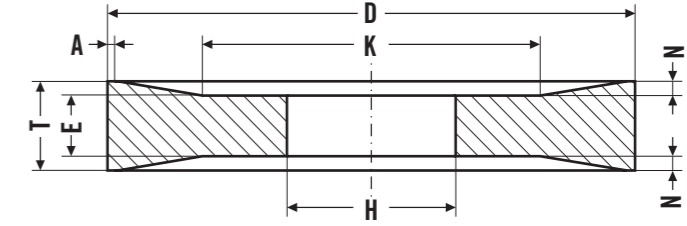

T22 - D/K x T/N x H - P x F

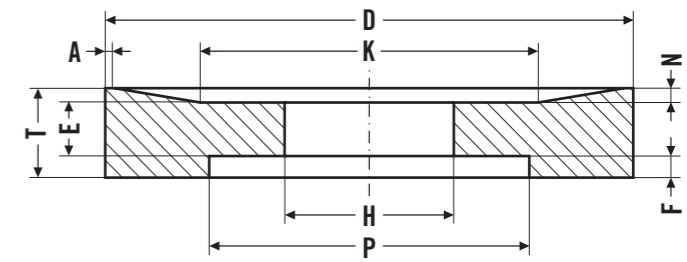

T23 - D x T/N x H - 1 - P x F

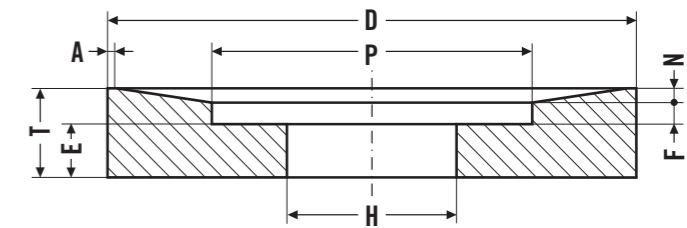

T24 - D x T/N x H - 2 - P x F/G

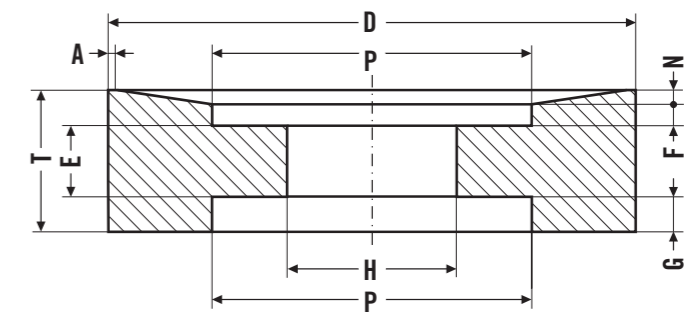

A = 2 mm standard width

**Generative gear grinding**

**T1 (without profile)**

**T1SP - D x T x H**  
(pre-profiled)  
Specify the module,  
pressure angle,  
number of starts,  
and direction  
of lead

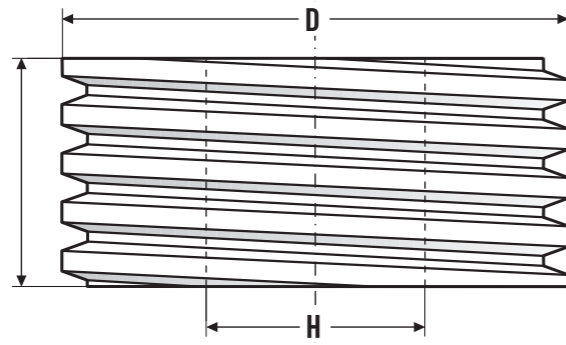

**Thread and profile grinding**

**T1E - D x T x H - V°**

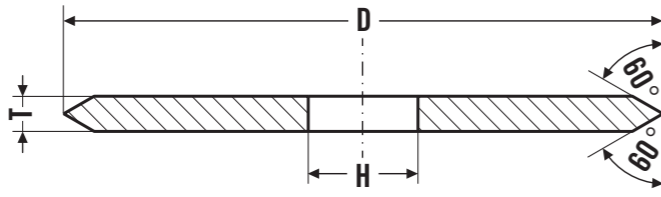

**T1ESP - D x T x H - V° - U**

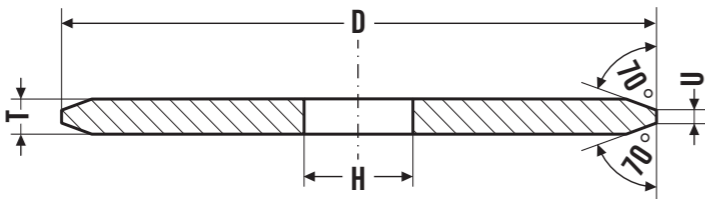

**T39ESP - D/J x T/U x H - V°**

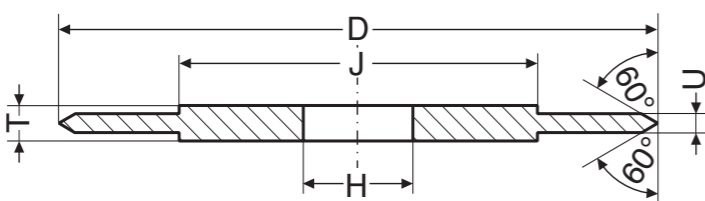

**GRINDING SEGMENTS**

**T3101 - B x C x L**

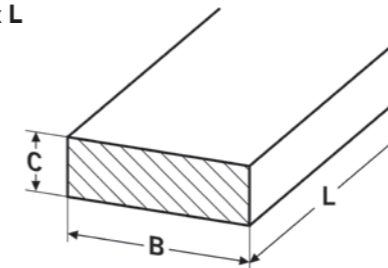

**T3105 - B/A x C x L - R**

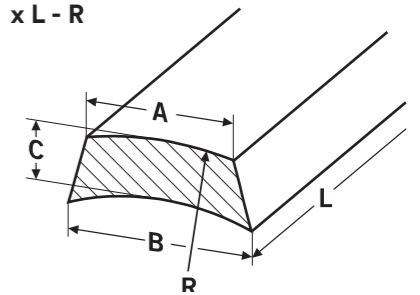

**T3102 - B/A x C x L - R**

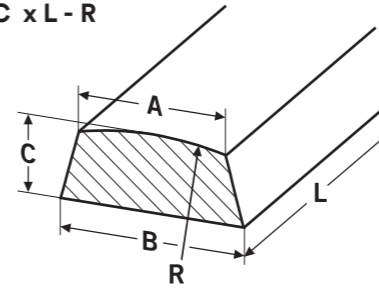

**T3108 - B x C x L - R**

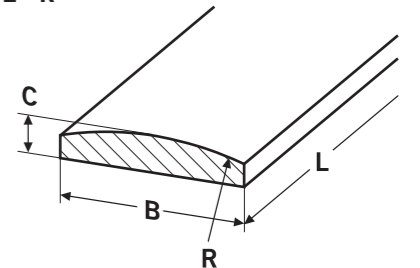

**T3104 - B/A x C x L - R**

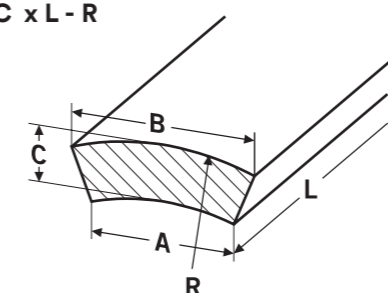

**T3109 - B/A x C x L**

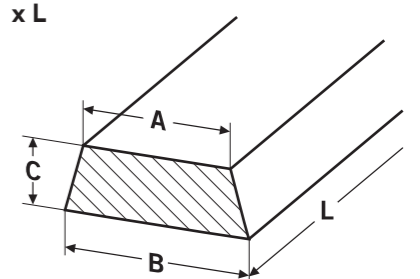



# Specifications

For conventional grinding wheels

Mineral	Grain Size	Hardness	Structure	Bond	Special Codes	Bond Number
Vitrified bond	Very coarse	Extremely soft	Normal structure			
A	12	C	1	V = Vitrified bond	P = Porous structure	300 W
33A	14	D	2		L = Low porosity	301 W
28A	Coarse	Very soft	3	B = Synthetic resin bond	M = Medium porosity	302 W
29A	16	E	4		H = High porosity	304 W
31A	24	F	5	BF = Fiberglass-reinforced synthetic resin bond	HH = Very high porosity	450 W
35A	36	Soft	6		G = Large pores	470 W
42A	Medium	G	7		GG = Very large pores	600 W
49A	46	H	8		F = Fine pores	601 W
40A	54	J	9		FF = Very fine pores	602 W
54A	60	Medium hard			SR = Special recipe	604 W
55NA	70	K	Porous structure			900 W
93NA	180	Q	17			
57A	80	L	11			901 W
64A	fine	M	12			902 W
68A	90	Hard	13			904 W
77A	100	N	14			
79A	120	O	15			
81A	150	P	16			
93A	220	Very hard	18			
93DA	Very fine	R	19			
99DA	240	S				
13C	280	T				
15C	320					
	400					
	500					
	600					
	800					

**Example: 64A60 H15VP300W**

- Abrasive 64A
- Medium grain 60
- Very soft hardness grade H
- Structure 15
- Vitrified bond
- Porous structure

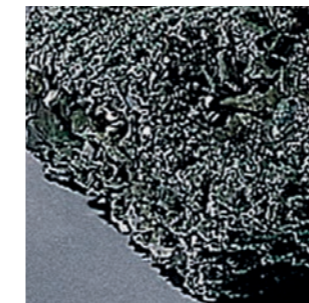

Green silicon carbide

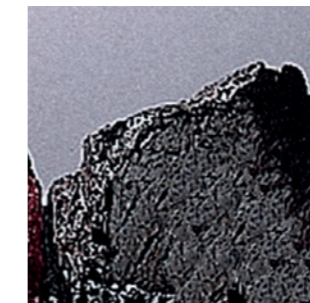

Regular aluminum oxide

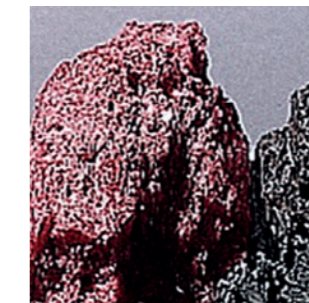

High-grade pink aluminum oxide



Sintered aluminum oxide



Black silicon carbide



High-grade red aluminum oxide

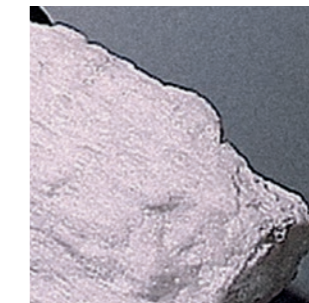

High-grade white aluminum oxide



3M Precision-Shaped Grain

Grain price/removal performance

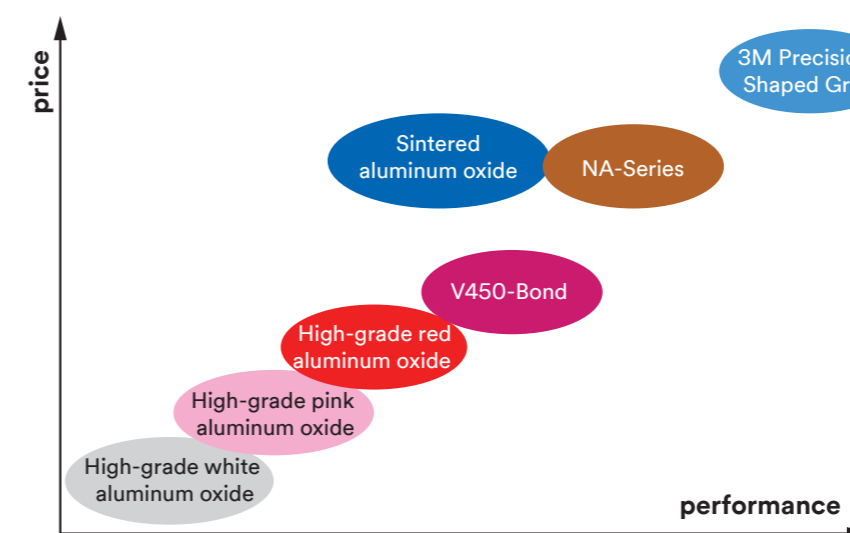

# Safety Information\*

## For the use of grinding wheels

### Safety when grinding

We have summarized the most important safety measures for you in the following recommendations. Please note that you as a user are required to be familiar with the regulations applicable in your country.

### Guidelines for Europe

The applicable safety codes are available in your local language from the FEPA (Federation of the European Producers of Abrasives). We recommend you visit the FEPA home page to become more familiar with the safety code. You will find an excellent collection of the relevant regulations there. Every grinding wheel delivery sent by us includes a copy of the guideline "SAFETY RECOMMENDATIONS FOR THE USE OF ABRASIVE PRODUCTS". We would be happy at any time to send you additional copies of this guideline and other binding recommendations published by FEPA.

### FEPA

20, Avenue Reille  
75014 Paris, France  
Tel.: +33 (0)1 45 81 25 90  
Fax: +33 (0)1 45 81 62 94  
fepa@fepa-abrasives.org  
www.fepa-abrasives.org

\* The following pages are a summary, by no means complete, of the most common general safety rules

### The sound check

A sound check must be conducted immediately before mounting a new or used vitrified grinding wheel. To conduct the sound check, lightly tap the grinding wheel to the right and left of the centerline using a non-metallic hammer. Place lighter wheels on your finger or an awl for the sound check. Heavy wheels are placed upright on the floor. A crack-free wheel makes a clear sound while a cracked wheel makes a dull thudding sound. Synthetic resin bonded wheels do not make the same clear sound as vitrified wheels.

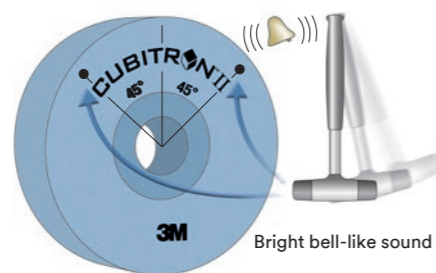

**Essential:**  
The sound check before mounting

### Properly mounting on the flange

You must first check if the wheel is imbalanced and balance the wheel if necessary. The machine speed should not be set higher than the permissible rotational speed (for new wheels) or circumferential speed. According to the applicable safety regulations (ISO, DIN, FEPA) and safety recommendations, the new wheel must be subjected to a test run (without a load) after mounting at a speed no higher than the max. operating speed. The hazardous area must be secured accordingly. Caution: Our grinding wheels must never be operated at speeds higher than the specified maximum operating speed or rotational speed (for new wheels).

Tighten the mounting bolts uniformly in a crosswise pattern using a torque wrench.

### Order

1/2/3/4/5/6	1/2/3/4/5/6/7/8
-------------	-----------------

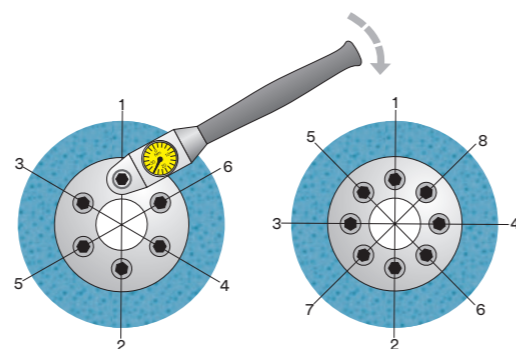

### Recommendations and prohibitions

#### The proper use of grinding wheels

##### Always:

Read the safety regulation of your country!

Inspect the wheel upon delivery and before mounting for damage during transport!

Store the wheels properly in the racks specified for this purpose!

Check if the wheel is suitable and authorized for use at the circumferential speed of the machine!

Use a paper or plastic blotter as a middle layer! Make sure to wet the paper flange with cooling lubricant!

Use a torque wrench to tighten the flange nuts!

Check to make sure all safety devices are functioning properly!

Wear protective goggles!

Start the machine and let it idle for a minute before you actually start grinding!

Only start operation of the machine when operation is in accordance with the rules for use of the machine and grinding wheel!

##### Never:

Never exceed the maximum working speed specified by the manufacturer!

Never mount a ceramic grinding wheel without conducting a sound check! Do not use the wheel if it makes a dull thudding sound!

Never force the wheels onto an arbor (flange)!

Never remove or bypass the safety devices on the machine!

**If you are unsure of anything, please contact our service technicians!**

### Balancing

Any imbalances in the rotating parts will have a negative impact on the surface finish quality of the workpieces, the service life of the grinding wheel, and the results produced on the machine. Only a properly balanced grinding wheel will achieve an optimal surface finish quality. In general, static balancing of the grinding wheel is sufficient if it has already been mounted on a flange.

To statically balance a grinding wheel, mount it on a polished shaft and place it on the balancing unit. Depending on how worn the grinding wheel is, it may be necessary to repeat the balancing procedure.

3M grinding wheels are subjected to a strict balancing test in the factory and are rejected if damaged. Our internal imbalance tolerances are much lower than the corresponding DIN or ISO standards.

Imbalances can also arise when mounting the grinding wheel on a flange and are eliminated by shifting the balancing weights accordingly.

The wheels can be balanced dynamically and continuously provided that the grinding machine is equipped with an automatic balancing system. Modern quality requirements for ground workpieces and increased circumferential speeds often require use of continuous dynamic balancing. This is especially true when the wheel thickness is greater than 1/6 of the diameter of the wheel.

In accordance with DIN, ISO, FEPA, and ANSI standards, every grinding wheel must idle for at least one minute before grinding, and the circumferential speed during this time must never exceed the recommendations of the wheel manufacturer. During the idle phase, the operator should pay special attention to the wheel.

### International Standard Dimensions

D Diameter (mm)	T Thickness (mm)	H Bore <sup>1)</sup> (mm)
3	0.5	1,6
6	0.8	2,5
8	1	4
10	1.25	6
13	1.6	9,53 <sup>3)</sup>
16	2	10
20	2.5	13
25	3.2	16
32	4	20
40	6	22,23 <sup>3)</sup>
50	8	25
63	10	32
80	13	40
100	16	50,8
115 <sup>2)</sup>	20	76,2
125 <sup>2)</sup>	25	127
150	32	203.2
180 <sup>2)</sup>	40	304,8
200	50	406,4
225	63	
230 <sup>2)</sup>	80	
250	100	
300	125	
350	160	
400	200	
450	250	
500	315	
600	400	
750	500	
800		
900		
1000		
1060		

#### 1) Bore tolerances:

- H7 CBN/diamond wheels and special applications
- H12 Bore diameters up to 50.8 mm
- H11 Bore diameters of 76.2 mm or larger
- H13 For roughing grinding wheels

#### 2) For fiberglass-reinforced cut-off or roughing grinding wheels on portable grinders

#### 3) For grinding wheels listed under 2: But also for the types 6 and 11 when used on portable grinding machines

Minimum thickness for vitrified bonded grinding wheels = 2% of the outer diameter.

#### Required labels on our grinding wheels

In accordance with ISO, DIN, and CEN standards as well as with FEPA regulations, our grinding wheels are marked with the following information and specifications:

- Manufacturer; trade mark
- Max. permissible rotational speed (rpm)
- Max. operating speed (m/s)
- Serial number and article number
- Type
- Dimensions
- Composition

#### Wheel labels and markings

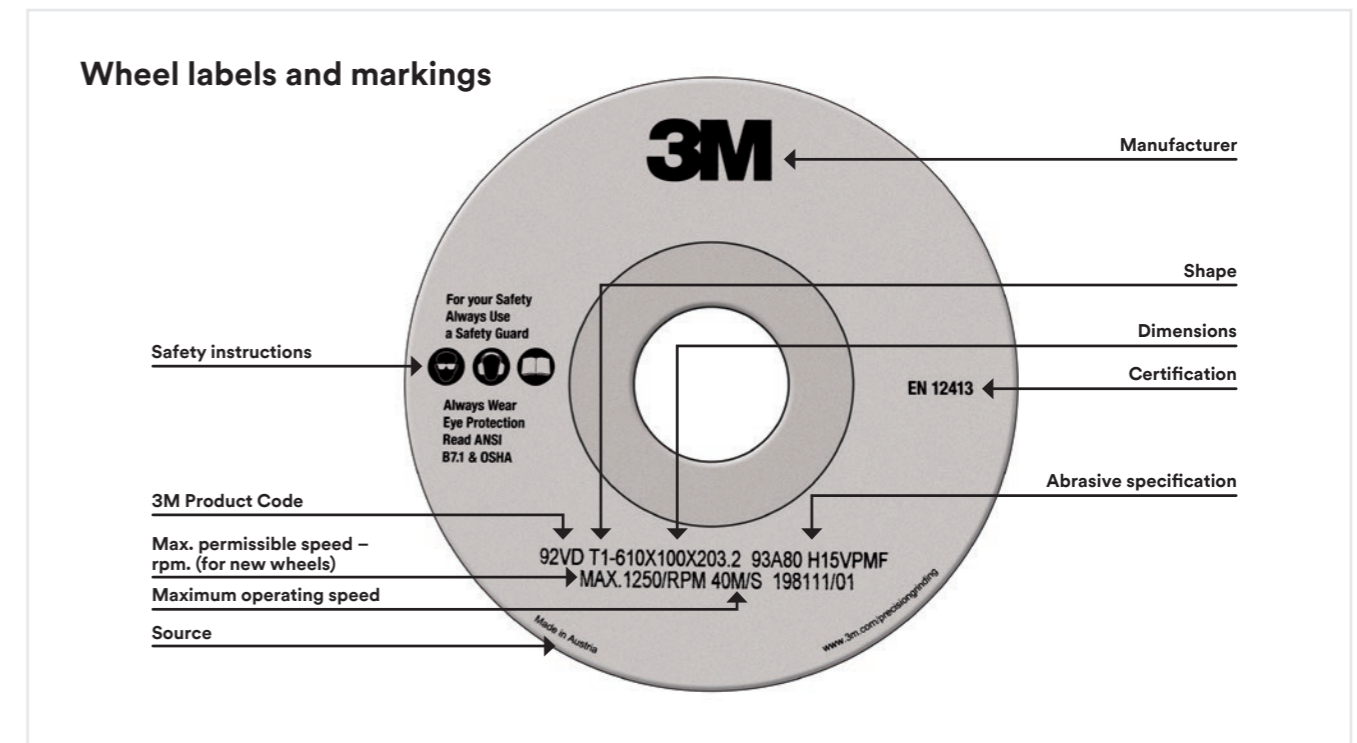

# Responsibilities & tasks

## Everything runs smoothly

### Who is responsible for what?

#### Grinding wheels manufacturer

- Guarantee multiple levels of safety of the grinding wheel against breakage. The corresponding safety factors vary depending on the working method and design of the grinding machine
- Test run conducted in the factory at high circumferential speed
- Breakage tests in the factory
- Labeling of the grinding body with specification of the permissible rotational speed (for new wheels)

#### Grinding machine manufacturer

- Easy adjustment of the workpiece support and safety covers that adjust as the diameter of the wheel decreases
- Forced locking of the speed levels
- Securing continuously variable speed regulators
- Suitable safety cover made of a rugged material that will retain the pieces of the grinding wheel in case of breakage
- Proper design of the grinding wheel flange

#### User, operator

- Sound check and inspection for external damage during transport before mounting the grinding wheel
- Starting a grinding wheel
- Flanging and mounting
- Checking for imbalances and balancing the grinding wheel when necessary
- Checking the permissible speed (for new wheels)
- Readjusting the workpiece support and safety covers
- Idling the newly mounted grinding wheel while operating at full speed
- It is prohibited to carve the grinding wheel

The responsibility extends to include proper packaging for shipment, but not for damage occurring during transport or through improper storage.

### What is a closed working area?

Grinding tools requiring authorization for use are now subject to certain usage restrictions. These usage restrictions are written by 3M in the factory either directly on the grinding tool, its flange, or on an enclosed label. The following restriction, for example, always leads to calls to our technicians:



#### VE 4: Only authorized for use in closed working areas

In a closed working area, the grinding wheel is enclosed on all sides by machine components to ensure broken pieces are completely retained inside the machine in case of wheel breakage.

When grinding bodies are labeled with this usage restriction, then they may only be used on stationary grinding machines on which the retaining safety devices are approved as a "closed working area" and correspondingly marked with the symbol shown together with the specification of the maximum circumferential speed.



#### Standard or normal operating speeds

The maximum operating speed for each wheel must be established by the wheel manufacturer:

General International Regulations	
Vitrified bonded wheels	40 m/s
Resinoid bonded wheels	45 m/s
Cutting-off wheels on fixed machines	80 m/s

#### Storage of grinding wheels

Grinding bodies require carefully handling and proper storage.

Every delivery you receive should be checked upon receipt for damage during transport (sound check).

Grinding bodies must be stored so that they will not be damaged. The storage room must be dry, frost-free, and protected against excess heating and vibration.

Vitrified bonded grinding wheels can be stored indefinitely.

Synthetic resin bonded grinding wheels should not be stored for more than 3 years because otherwise the strength of the wheel could drop due to embrittlement.

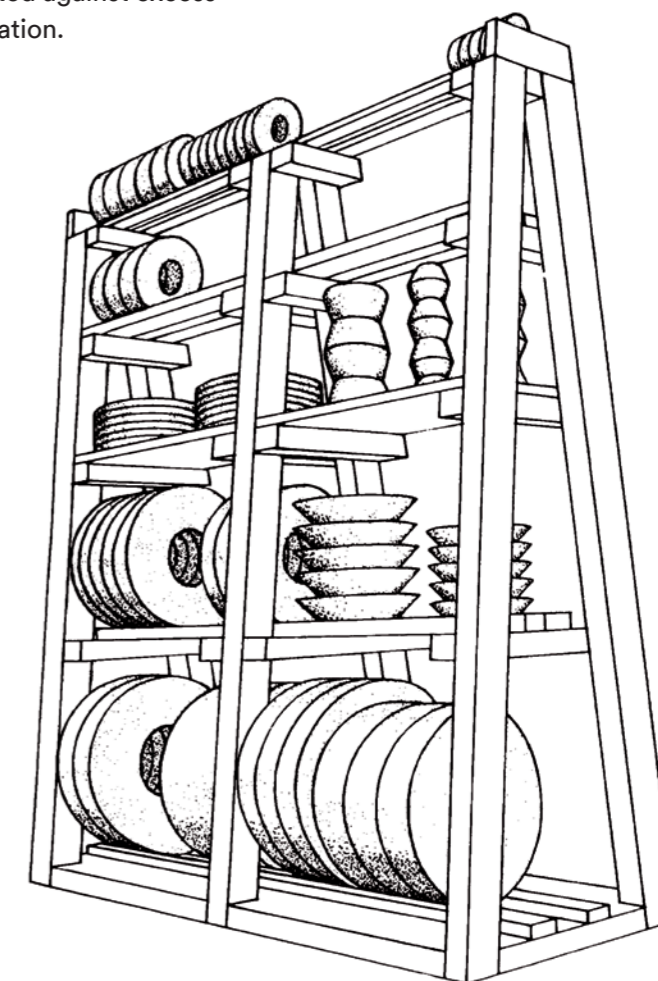

# Modern production & comprehensive services

## Quality requires commitment

To manufacture our grinding wheels in outstanding quality, we only use the highest quality raw materials and work with the most modern machines and systems. We meet the expectations of our demanding customers every day to manufacture premium quality grinding wheels using state-of-the-art manufacturing technology.



CNC-controlled presses to ensure the homogeneous wheel structure is reproducibly maintained.



Kilns with electronic control of the temperature curve for reproducible and documented quality.



CNC-controlled precision lathes to ensure precise finishing.



Computer-controlled test machines to test for imbalances and conduct high speed test runs.

## High availability, shortest delivery times

Through our inventory management, we can guarantee high availability of blank grinding wheels, which we then use to quickly manufacture a custom grinding wheel for you. They can be equipped with edge profiles, the hole widened to depth, or formed along the diameter or along the side.

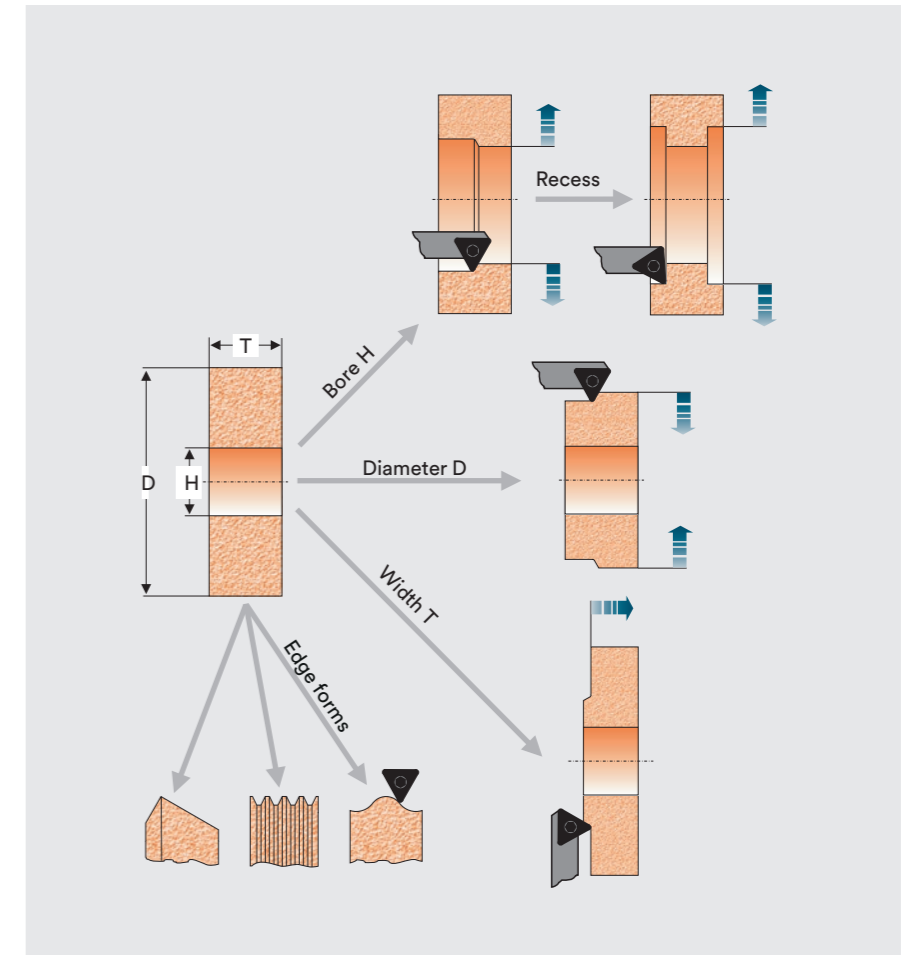

# Process optimization

## Grinding process optimization with 3M OPTIMA software

Today there are highly developed machines and tools available even for the most demanding processes in grinding technology. In the framework of conducting scientific research into the grinding process, more than one hundred different factors with an influence on the grinding time were identified (VDI Guideline 03398).

With our OPTIMA software, you can optimize the grinding process as a user by adjusting individual parameters. Thirteen evaluation criteria are determined automatically from seven easy-to-specify parameters. Through limited simulation of the grinding process on the screen, the number of practical tests required is reduced to a minimum, and the key data for an optimized process are calculated according to the target parameters specified.

Our innovative 3M process optimization software supplies you with process parameters for many relevant grinding processes:

- OD and ID grinding
- Deep grinding (creep-feed grinding)
- Gear grinding (generative and profile grinding)
- Centerless grinding

Also for in-process measures such as:

- Dressing with stationary and rotary diamond dressing tools
- Cooling lubricant flow rate, nozzle design, and cooling lubricant system capacity

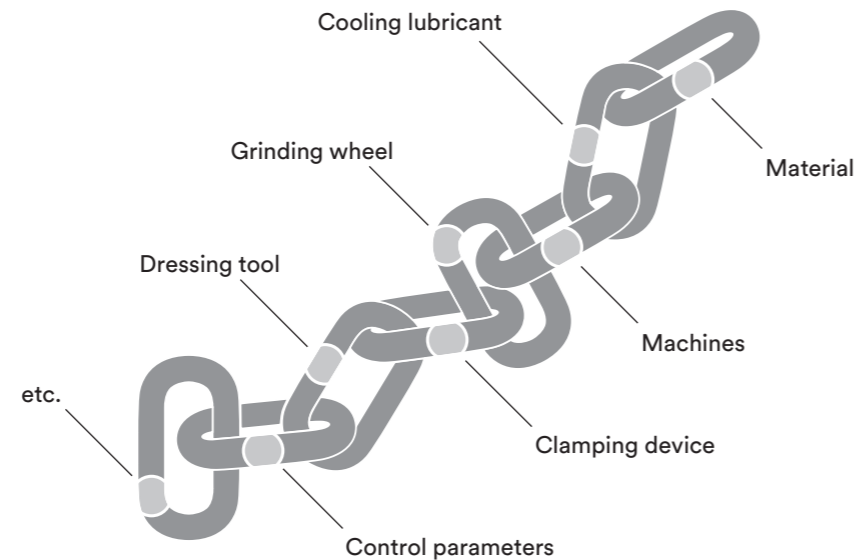

For further information, contact our application technicians!

# Quality control according to ISO 9001 & ISO 14001

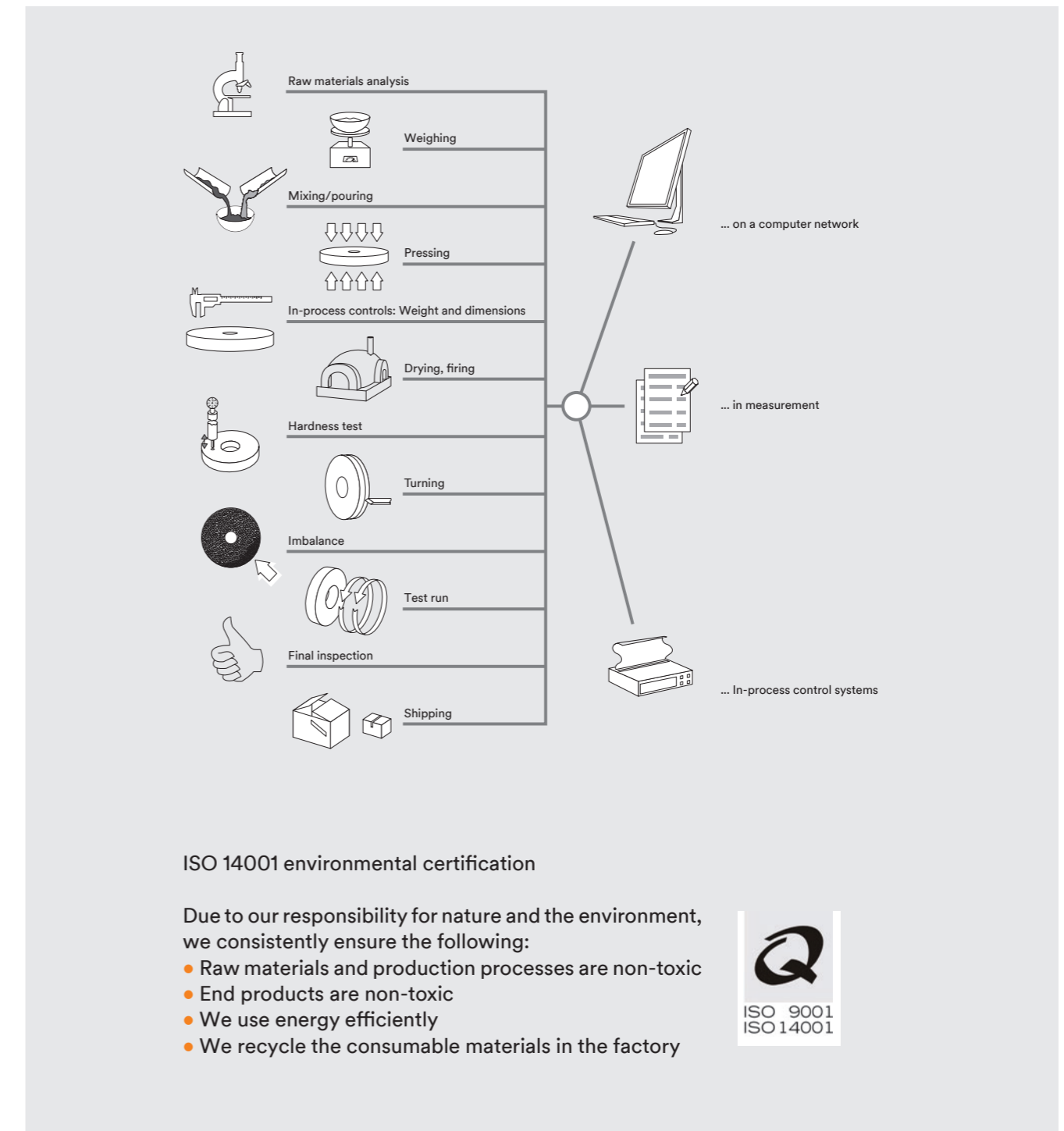

# 3M™ Grinding wheels

## Highly porous for the best results

### High porosity grinding wheels

The porosity of a grinding wheel is created artificially using pore formation agents in the bond/grain mixture since high porosity grinding wheels enable improved cooling lubricant supply and chip removal.

In particular, though, highly porous structures optimize the self-sharpening process in order to prevent and protect against grinding burn.

During deep grinding and the higher feed increments associated with it, there are larger contact surfaces ( $A_k$ ) between the grinding wheel and workpiece, which in turn generally leads to lower grinding forces (normal force  $F^n$ ) on the abrasive grit.

The diagram below shows how the grains on high porosity grinding wheels are separated from each other in order to use fewer grains per  $\text{mm}^2$  on a given contact surface. These grains are thus easier to splitter when subjected to a perpendicular force, enabling the wheel to self-sharpen.

To obtain a self-sharpening effect, the abrasive grit must splitter in every grinding process.

Due to its numerous advantages, we use naphthalene as pore formation agent:

- No chemical traces in the finished grinding wheel.
- No expansion during firing (no stresses).
- Good mixability with the abrasive grit and binder (no imbalances).
- Consistent porosity (connected pores for high levels of coolant transport).

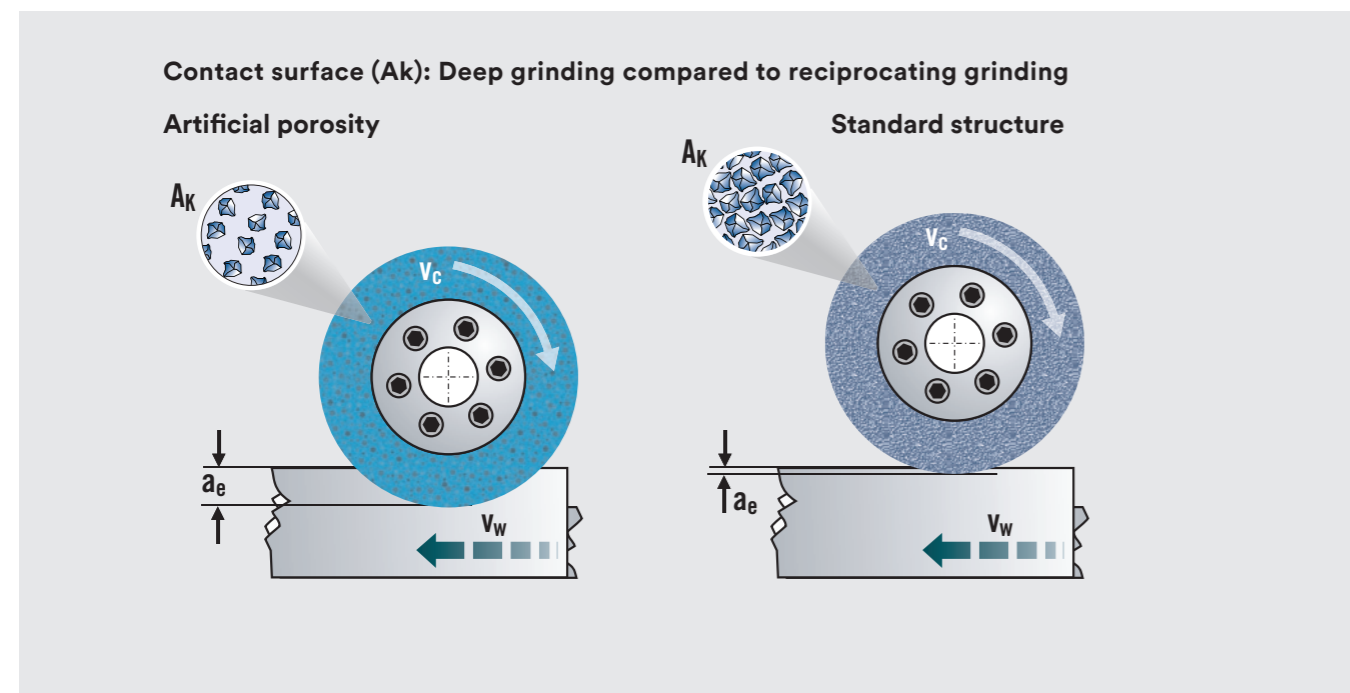

### Compound wheel with artificial porosity

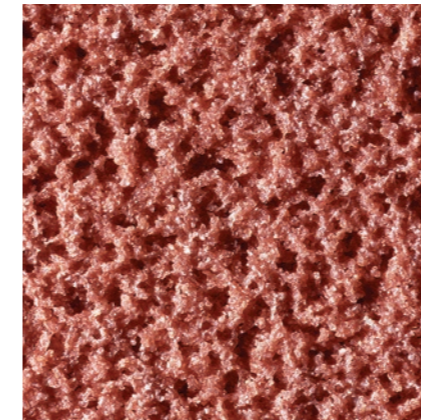

40A120 L15VPMF302W  
Medium-fine porosity for OD grinding

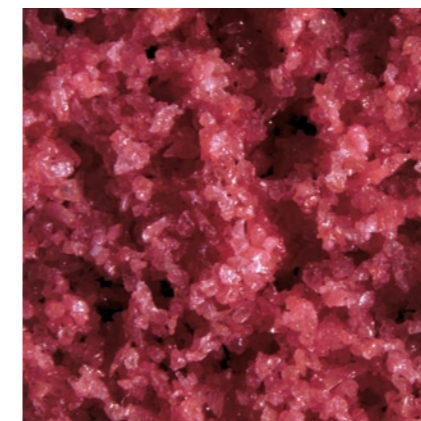

57A46 H18VPHHG900W  
Highly porous structure with large pores for the highest material removal rates; mainly for hard-to-grind parts from aerospace industry

### Microcrystalline sintered aluminum oxide (81A, 93A, among others)

The enormous performance of sintered aluminum oxide as a mineral when compared to conventional aluminum oxides is due to its unique microstructure. Using a special manufacturing process, we are able to obtain crystals smaller than  $1\ \mu\text{m}$  in size. The pressure resulting during grinding leads to microsplitting, which continuously produces new, sharp cutting edges. To fully utilize the performance potential of this grain, we have developed a bonding system that fully exploits these self-sharpening properties.

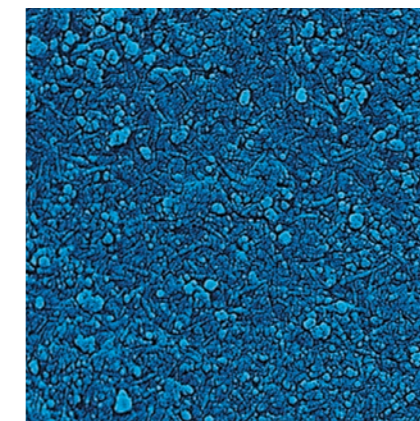

Scanning electron microscope image; magnified 10,000x

### Features

- High removal rates; and therefore shorter cycle times
- Longer service life of the wheel; fewer wheel changes
- Constant grinding performance and grinding forces
- Low shape deviation, and therefore consistent quality
- Longer intervals between dressing operations due to the longer service life

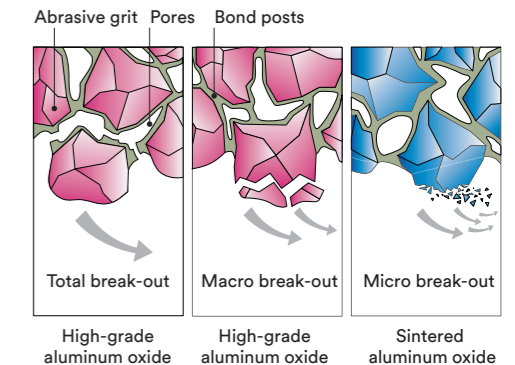

### Benefits

- Improved process capability
- Improved price/performance ratio

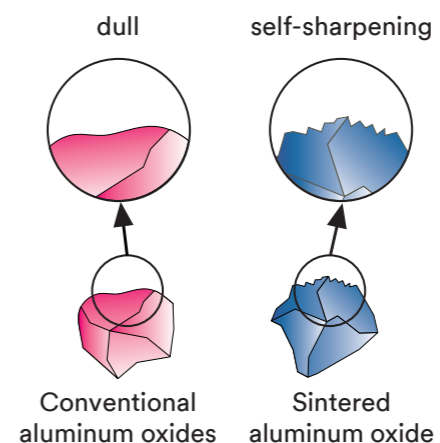

# 3M™ Cubitron™ II Vitrified wheels

We redefine the grinding process

With the invention of the 3M Cubitron II vitrified wheel, 3M has completely redefined the grinding process. Due to the new generation of 3M Precision-Shaped Grain, we have brought high-performance ceramic grain into a defined, geometric form.

## A stroke of genius: 3M™ Precision-Shaped Grain

The individual precision abrasive grains of the Cubitron II ceramic vitrified wheels are identical in size and precise formed triangles made of sintered aluminum oxide. These self-sharpening triangular cutters cut like a knife through the workpiece. The heat generated is extracted directly in the chips, which greatly minimizes the risk of overheating. The very sharp grinding surface will convince you with never before seen material removal rates and service lives.

## Precision-formed abrasive grain for excellent results

The tips of the triangular grains break off during the grinding process, creating new, sharp edges. The surface of the material is processed cleanly by new cutting edges. The result is fast, cool grinding and a longer mineral lifespan. This technology sets new standards, which is why this grain is not specified according to FEPA (e.g. P60), but by a “plus” sign (e.g. 60+). This “plus” stands for grinding like with standard grinding wheels, but with a significantly higher removal rate. Every single abrasive grain is shaped identically to generate a precisely defined grinding pattern.

## Revolutionary advantages:

- Risk of overheating is almost nil
- Up to 50% shorter grinding times due to significantly higher material removal rates
- Perfect form and surface finish quality inspite of extreme material removal
- Highly reduced dressing requirements
- Wheel (worm) lifespans of up to twice as long
- Continuously constant grinding performance
- Significantly reduced cost per workpiece

**The result: higher productivity and lower part costs!**



# CUBITRON™ II

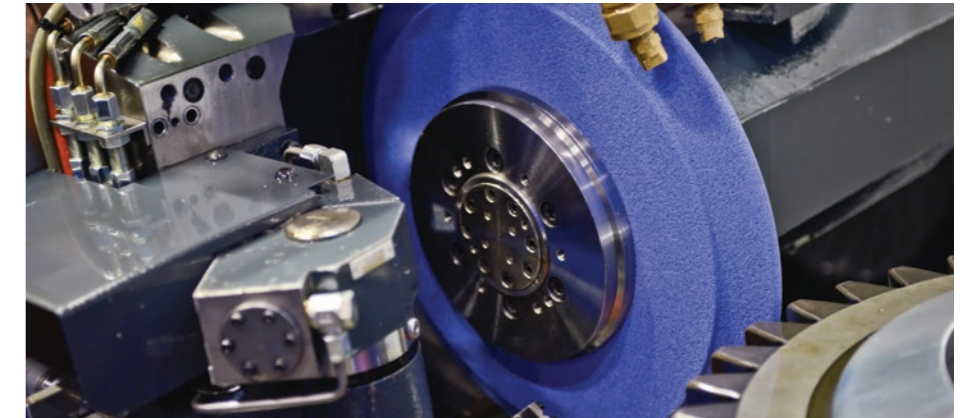
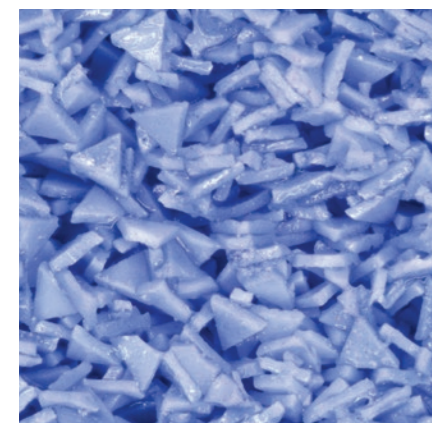

## Dressing Cubitron II Vitrified wheels

The precision-shaped abrasive grains of the Cubitron II also demonstrate their clear advantages when dressing since much less force is needed when dressing PSG abrasive grit. The dressing roller contacts the triangular grain and the predetermined breaking point integrated into the grain allows a segment of the grain to break off. This creates a new cutting edge while significantly reducing the load on the dressing roller. This permits a significantly longer lifespan of the dressing roller. Cubitron II is a real all-rounder amongst grinding wheels. Volumetric removal rates  $Q'_w$  of over

30 mm<sup>3</sup>/mm/s are achieved when roughing, and surface roughnesses of Ra < 0.3 are achieved when finishing. Due to the new grain geometry, wear on the dressing tools is reduced to a minimum. Maximum performance with a perfect geometry and surface.

**Perfect dressing  
in half the  
production time!**



Dressing behavior of standard sintered aluminum oxide

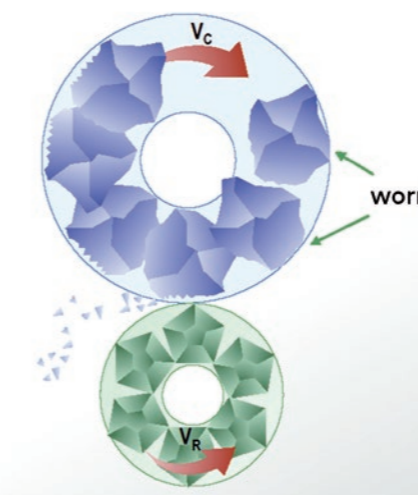

Dressing behavior with 3M Precision-Shaped Grain

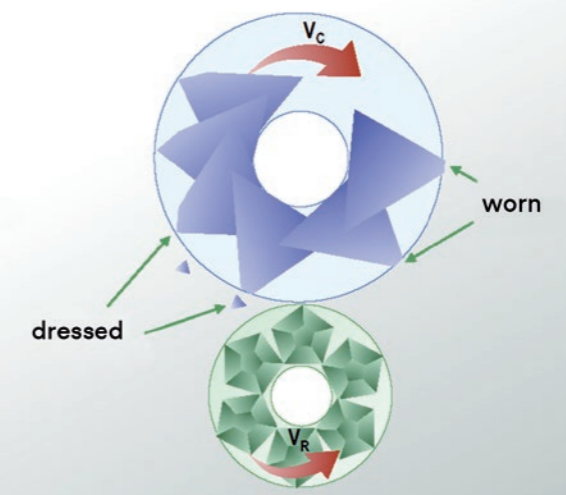



# 3M™ Vitrified grinding wheels 22VD

## 93NA & 55NA-series grinding wheels

On 3M 22VD grinding wheels, the surface of the grain/bond compound is improved using self-organizing nano surface structures that practically eliminates cold bonding of the chips and other types of clogging. As a result, the grinding wheel retains its free-cutting ability during the processes, requires less drive power from the machine, and achieves consistent surface structures on the workpieces without creating grinding burn. 3M 22VD contains aluminum oxide nitride abrasive grains.

## More economical grinding with 3M 22VD

In comparison to standard aluminum oxide grinding wheels ( $Al_2O_3$ ), 3M 22VD grinding wheels have higher specific volumetric removal rates ( $Q'_w$ ) with a lower risk of grinding burn and lower rejection rates.

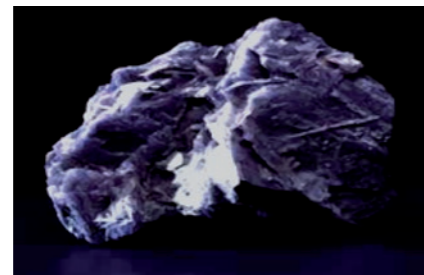

NA-Series Grain

The advantages at a glance:

- Minimal risk of grinding burn
- High thermal stability and wear resistance
- Low wettability, and thus significantly fewer built-up edges
- Higher removal performance
- Constant surface finish qualities
- Less mechanical deformation of workpieces
- More tightly controlled process conditions
- Cost savings

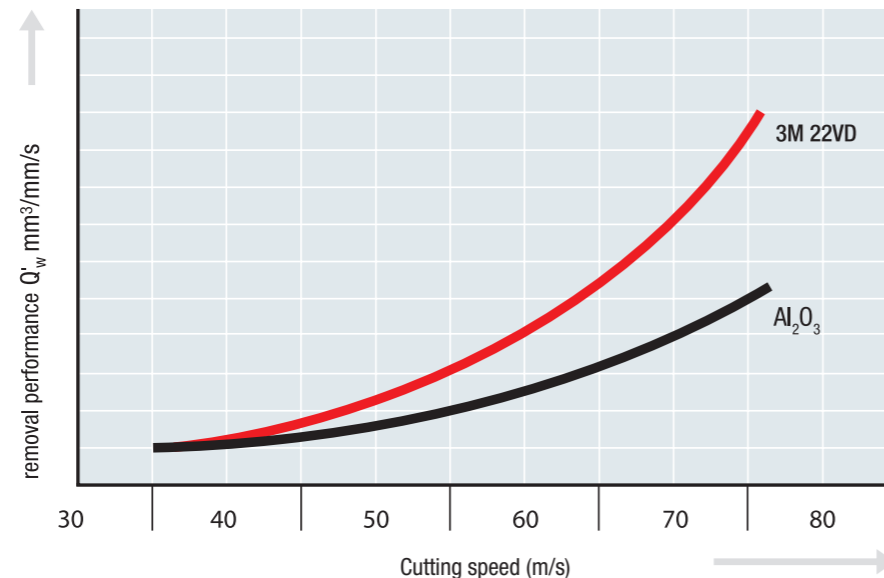

Summary: The grinding process is less expensive while producing higher quality workpieces. The higher removal performance is especially advantageous when the cutting speed can be increased accordingly.



# 3M™ Vitrified grinding wheels 33VB

## 3M Vitrified grinding wheels 33VB – 54A-series

consist of high-grade white aluminum oxide abrasive grit with a green V604, V904, or V304 vitrified bond and are available with various specifications for various applications. As a synthetic optimization of conventional standard bonds, the low temperature bond used in the PolarWin series allows for energy-saving firing at 900°C and 100% reproducibility.

Application examples:

- Outside diameter (OD) grinding
- Internal diameter (ID) grinding
- Surface grinding
- Profile grinding
- Deep grinding



# 3M™ V450-Bond

Lower grinding costs – increased process reliability

In comparison to conventional bonds on wheels with high-grade aluminum oxide, the 3M V450 bonding system guarantees higher removal rates in combination with a lower risk of grinding burn. This means improved profile retention and lower rejection rates, enabling the highest possible efficiency and reliable processes.

#### Properties:

- Innovative glass/ceramic bond as a further development of ceramic low temperature bonds
- Higher percentage of grain for longer service lives and better profile retention
- Higher density of pores for easier grinding and better removal of chips
- Frame-like crystals that provide stability and act as reinforcement

#### Advantages:

- Greater hardness in spite of less bonding material
- Cooler grinding
- Less wear on the dressing tools
- Greater edge stability
- The reinforcing properties result in improved damping behavior when grinding

#### Application examples:

- Gear tooth grinding
- Deep grinding
- OD grinding

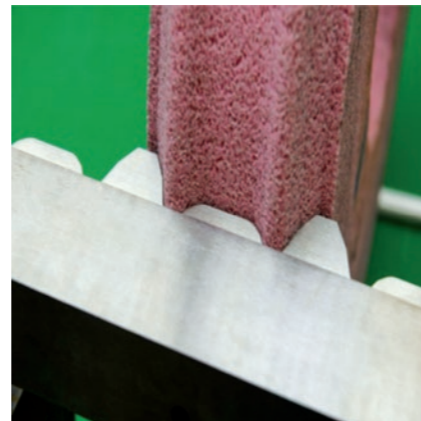

Standard bond

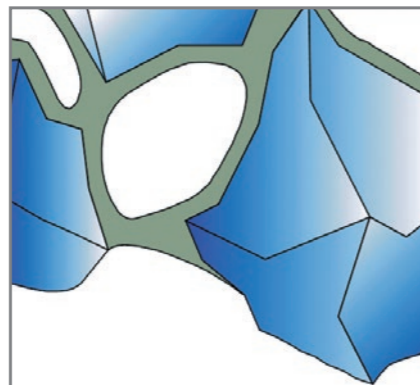

Made of clay, kaolin, and feldspar

Partially crystallized bond

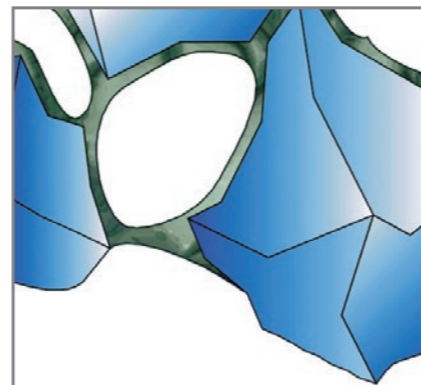

# 3M Grinding wheels and dressing tools

As you can see, we have a lot to offer

We have the innovative and technically demanding solution to every problem and requirement for modern precision grinding technology used in industrial settings. 3M is the only manufacturer that offers you precision grinding machines with the WENDT brand name and grinding tools as system solutions from a single company.

With our unique expertise in the manufacture of ultra-modern grinding machines and bonded minerals, we are in the position to optimize the operating and economic efficiency of your individual production processes and increase the value added to your products.

Our solutions are used in numerous branches of industry such as the following:

- Automobile industry
- Aviation industry
- Wind power industry
- Gear-cutting industry
- Machine tool industry
- Tool and die industry
- Glass industry
- Steel industry





**Wendt GmbH**  
3M Abrasives  
Fritz-Wendt-Str. 1  
40670 Meerbusch  
Germany  
Tel.: +49 2159 671-0