

Arts  
& Lifestyle

# Quilting Project

Reference Book



Saskatchewan

## 4-H Motto

Learn to do by doing.

## 4-H Pledge

I pledge

My HEAD to clearer thinking,

My HEART to greater loyalty,

My HANDS to larger service,

My HEALTH to better living,

For my club, my community and my country.



## 4-H Grace

*(Tune of Auld Lang Syne)*

We thank thee, Lord, for blessings great

On this, our own fair land.

Teach us to serve thee joyfully,

With head, heart, health and hand.

This project was developed through funds provided by the Canadian Agricultural Adaptation Program (CAAP). No portion of this manual may be reproduced without written permission from the Saskatchewan 4-H Council, phone 306-933-7727, email: [info@4-H.sk.ca](mailto:info@4-H.sk.ca). Developed July 2013.

**Writer: Elya Lam**



Agriculture and  
Agri-Food Canada

Agriculture et  
Agroalimentaire Canada



AGRICULTURE COUNCIL  
OF SASKATCHEWAN INC.

# Table of Contents

---

Unit 1: The History of Quilting	
What is Quilting? .....	1
Types of Quilts .....	1
Quilting and Communities .....	4
Unit 2: Quilting Basics	
Parts of a Quilt .....	6
Quilting Patterns .....	6
Fabric and Fabric Care .....	8
Colour Theory .....	9
Estimating Yardage .....	12
Equipment and Tools .....	12
Sewing Machines .....	15
Methods of Quilting .....	16
Unit 3: How to Quilt	
Choosing a Pattern .....	19
Choosing Fabric .....	19
Choosing Batting .....	20
Preparation of Fabric .....	20
Cutting .....	20
Piecing .....	21
Pressing and Ironing .....	21
Making the Sandwich .....	22
Quilting .....	22
Binding .....	22
Embellishments and Special Effects .....	23
Quilt Care .....	25
Unit 4: Quilting and Your Community .....	26
Unit 5: Quilting Projects .....	27
Glossary .....	
References .....	



# Unit 1: The History of Quilting

---

*This project requires a basic knowledge of sewing and how to use a sewing machine. If you have no sewing experience, please take the 4-H project Clothing/Sewing.*

## What is quilting?

**Quilting** is a type of sewing which involves attaching two or more layered pieces of fabric together. Traditionally, quilting was done to make **quilts** – heavy, warm bedspreads or blankets.

The earliest intact piece of quilted **fabric**, a linen carpet found in a tomb in Mongolia, was believed to have been created in 100 BCE. Throughout time, quilts and quilted objects were made by people and cultures all around the world – from quilted wall hangings in India to quilted armour in Asia. Quilts and quilted objects were a way for people to demonstrate craftsmanship, tell stories through the use of pictures, and even pass along messages through the use of symbols. However, fabric is very fragile – few of these early quilted pieces have survived the test of time.

In North America, the first quilts were created for survival purposes. European settlers who had just arrived needed warm blankets to make it through cold winters, and creating layers of fabric was an easy way to add warmth. Quilts were made by hand with a needle and thread, and were used to teach young girls the basics of sewing – measuring, cutting, and stitching. For those families that achieved wealth in North America, quilting became less about function and more about creating beautiful works of art. During periods of economic struggle, such as the late 1920s to early 1940s fabric and clothing that had been worn out or outgrown were recycled into quilts.

Today, quilting has grown into a type of textile art created by both men and women. The variety of quilting styles and projects are limited only by the quilter's imagination. Start with simple projects to learn the basic quilting skills, and you will soon be able to create intricate and detailed quilts and quilting projects!

## Types of Quilts

There are three basic types of quilts:

**Pieced Quilts** – Pieced quilts are the most easily recognized type of quilt. Ask someone what a quilt looks like, and they'll probably describe a pieced quilt. Pieced quilts are made by sewing

small pieces of fabric together into different patterns and shapes. These pieces are sewn together to create a larger piece of finished fabric which forms the top or front of a quilt. Simple pieced quilts that use only squares or rectangles are called **patchwork**.



Vintage Patchwork Pieced Quilt  
made by Elizabeth Thiessen



Appliquéd Baby Quilt  
made by Elizabeth Thiessen

**Appliqué Quilts** – The process of **appliqué** involves cutting shapes or letters out of fabric, and attaching them to another piece of fabric by sewing. Appliqué quilts are covered with pieces of appliqué, often cut into the shape of flowers or objects, which have been attached by sewing around the outside of the shape. Sometimes, these pieces of appliqué are first attached to the fabric using fabric glue or an iron-on fusible interfacing.



**Whole-cloth Quilts** – Whole-cloth quilts are somewhat of a lost art – very few people still make them. Whole-cloth quilts have a top made from a single piece of fabric. Designs are created by sewing intricate images and shapes onto the fabric, often with a matching colour of thread to make the design more subtle.



Whole-Cloth Quilts  
made by Elizabeth Thiessen

Sometimes, all three quilting styles are used in a single quilted piece.



Whole-Cloth Baby Quilt  
with Patchwork Border  
and Appliquéd "B"  
made by Elya Lam

## Quilting & Communities

Quilting in Canada was, historically, a community event. Young women learned to sew and quilt from their sisters, mothers, aunts and grandmothers. Quilting bees, or day-long quilting events, were regularly held and involved all the members of a town or village. Quilters shared patterns, techniques, and passed along valuable quilting skills and knowledge. By the end of a day, several quilts would have been made from start to finish. Because of the many cultural backgrounds of Canadian citizens, no distinctly Canadian quilting style ever emerged.

Throughout the rest of the world (and throughout various time periods), quilting remained a community event. Amongst these community and cultural groups, different styles of quilting emerged.

**Amish Quilts:** Amish quilts are among the most famous style of community quilts. The Amish people, who live in North America, follow a denomination of Christianity. As part of their religious beliefs, they live a simple life without modern conveniences (such as electricity) and unnecessary “worldly” elements in their dress and home decor. In the Amish community, every aspect of life is communal (or shared) – everything from cooking and eating, to quilting is done as a group. Amish quilts reflect the simplicity of their lifestyle, and are characterized by bright colours and simple patchwork pieces using squares, rectangles, and triangles. They are often made by hand, or with a foot-powered or treadle sewing machine. What sets Amish quilts apart are their intricate and tiny quilting patterns.

**First Nations Quilts:** Although the First Nations people of Canada and the United States had no known quilting traditions, they learned the patchwork style of quilting when it was introduced to them by European settlers. They quickly developed their own style of quilting influenced by their culture and traditional art forms. Stars, bison, and cultural icons are all popular First Nations quilt pattern themes. Today, many First Nations quilts are used for ceremonial purposes, often as gifts to important leaders and guests at pow-wows. Star blankets, one of the most famous styles of First Nations quilts are traditionally used as ceremonial gifts. Star blankets are also used in wedding ceremonies, as they hold great meaning to the First Nations women who make them. By offering the groom a place under the star blanket wrapped around her shoulders, the bride symbolizes making room for the groom in her life and home.

**African American Quilts:** African American quilts are commonly separated into two categories – quilts made before the Civil War (also known as slave quilts), and quilts made after the Civil War. Slave quilts were made by African American slaves. Rumor has it that these quilts were often used to send secret signals about the Underground Railroad (a series of homes and people who



would help slaves escape to freedom). However, there is no reliable source to prove that quilts were used in this way. The few pre-civil war quilts that still exist were made by slaves for their masters. After the Civil War, African-American people became famous for Biblical story quilts, appliquéd with images of famous Bible stories.

**Hawaiian Quilts:** Traditional patchwork quilting was introduced to the people of Hawaii in the early 1800's by European missionaries. However, Hawaiians very quickly developed their own style of appliqué which used a folding technique to create images of plants and fruit (the same way you may have made paper snowflakes in elementary school!). A single appliqué design covers the entire quilt top. The bedspreads are quilted using an echo technique, as the quilting stitches follow the outline of the appliquéd shape.

**Japanese Quilts:** Various styles of quilting have been popular in Japan since the 1500's, when armour was made from quilted fabric. Many traditional Japanese garments were made with patchwork or appliqué style quilting. As Japan began trading freely with Europe and North America in the 19<sup>th</sup> century, quilting large bedspreads for daily use or for art became more popular. Japanese quilting is characterized by using recycled fabric scraps rather than new material.

**Italian Quilts:** The Italian style of “trapunto” quilting is often confused with other styles of whole-cloth quilting. Trapunto quilts were developed in Italy in the 13<sup>th</sup> century, and was developed to add more dimension to traditional whole-cloth quilts. Trapunto involves cutting small slits in the shapes created on a whole-cloth quilt, and filling them with stuffing to create a 3-D effect.

Though quilting is no longer done simply to keep people warm at night or to pass along secret messages, it remains a community and relationship building activity. Most modern quilters regularly get together (whether formally or informally) to discuss patterns, fabric, and view each other's work. Many have formed quilting guilds. A **guild** was traditionally a medieval group of employed craftsman (such as carpenters or blacksmiths) who would get together to control and enforce the accurate continuation of their craft. Members of quilting guilds today strive to ensure that old patterns and techniques are not forgotten, while also providing a support system and community for other quilters.

# Unit 2: Quilting Basics

---

## Parts of a Quilt

Most quilts are made using the “sandwich method”, meaning that they have at least three layers.

**Top** – The topmost (or front) layer of a quilt. This is usually the part of the quilt that is decorated with intricate patchwork patterns or appliqué.

**Batting** – A layer of padding to add weight and warmth to a blanket.

**Back** – The bottom layer of a quilt. This is usually a whole piece of fabric.

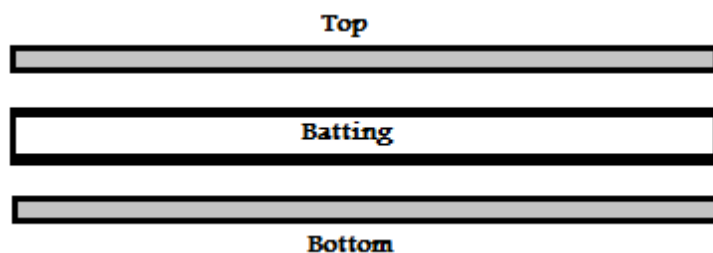

## Quilting Patterns

A quilting **pattern** is often used to help quilters determine what their finished product will look like. Many quilting patterns are centuries old, having been passed down from generation to generation. There are also new quilting patterns being created every day.

There are hundreds of thousands of pieced patterns to choose from. Most pieced patterns are for the creation of a single quilt block, or square which are sewn together to create a quilt top. These are the most common block patterns:

**Nine-Square** – A simple block made of nine identical square pieces in contrasting colours.

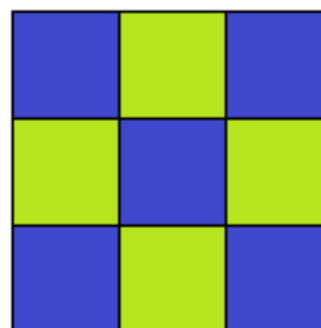

**Log Cabin** – A block made of 16 rectangles. Half of the block is made with light colours, while the other half is made with dark. By arranging the blocks in different ways, a variety of patterns can be made on the quilt top.

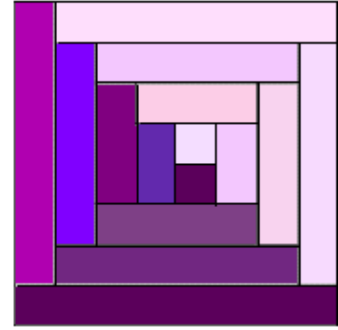

**Evening Star** – A block made of 17 triangular and square pieces. When assembled, the centre image resembles a star.

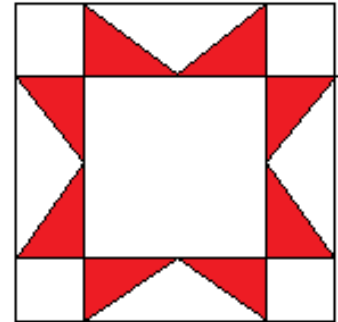

**Windmill** – A simple block made of eight identical triangle pieces in contrasting colours.

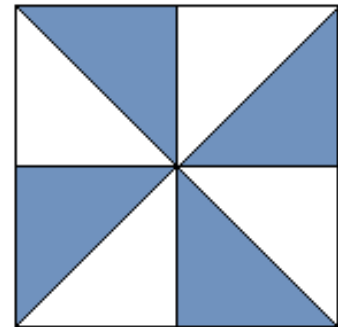

Appliqué is rarely done using a pattern. Instead, the quilter is encouraged to use his or her imagination to draw a simple shape or outline of an image that would be suitable to use. Images of flowers, leaves, or simple animals are common appliqué themes.



Heart Appliqué

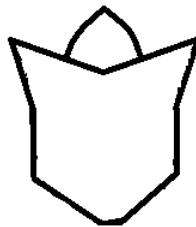

Tulip Appliqué

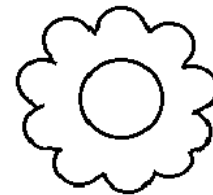

Flower Appliqué

Whole-Cloth quilts are created by embroidering repeating patterns (called medallions) all over a solid coloured piece of fabric. These medallions usually follow traditional designs, and are as varied as they are intricate.

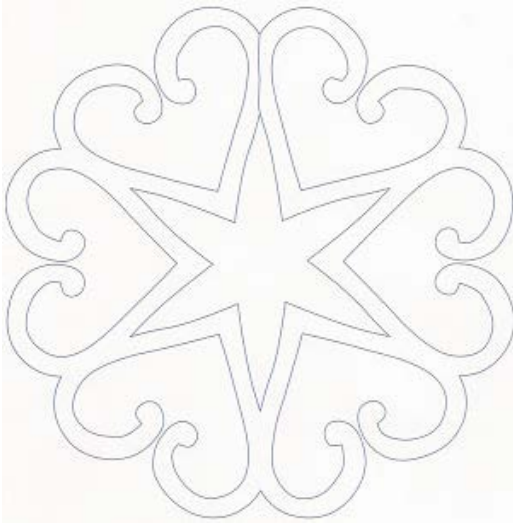

Simple Heart Medallion  
from Sunrise Quilt Studio

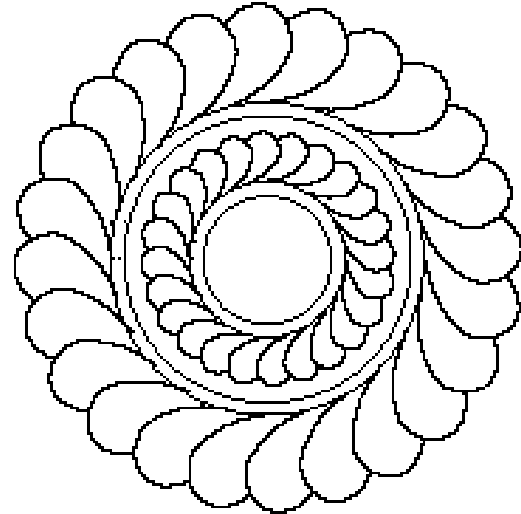

Double Feathered Wreath Medallion  
from Forest Quilting

## Fabric and Fabric Care

The type of fabric that you choose to quilt will have a great impact on your finished product. If you cheap, low-quality fabric, the quilting project that you spent so long on will not last! Most quilts are made with 100% cotton fabric. It is lightweight, easy to sew, and will last for a long time. However, cotton will shrink in hot water, so it is important to wash, dry and iron your fabric before you begin any cutting.

Whether you are sewing or quilting, it is important to be able to identify the different parts of a piece of fabric.

**Selvage** is the factory finished edge of a fabric. It should be a perfectly straight line.

The **lengthwise grain** of the fabric runs parallel to the selvage edge, and has very little stretch. Also called the warp.

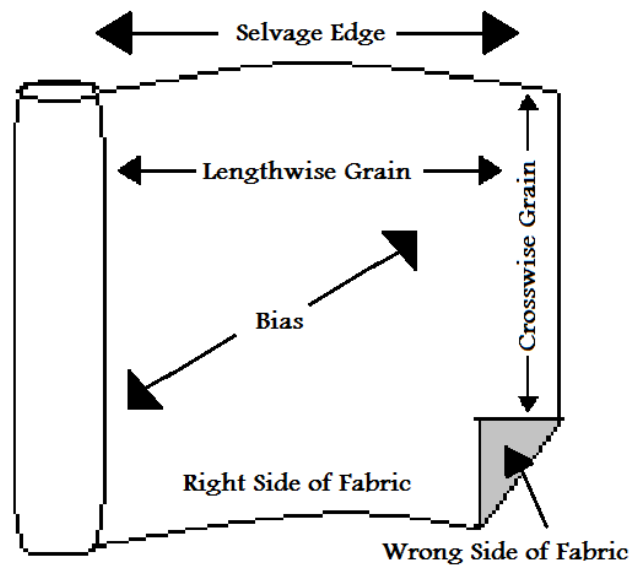

The **crosswise grain** of the fabric runs perpendicular to the selvage edge, and has some stretch. Also called the weft or straight of grain.

The **bias** runs at a 45 angle to the selvage edge, and has the most amount of stretch.

**Weave** refers to how tightly the threads that make up the fabric are held together. Check the density of a fabric's weave by holding it up to the light. You should select fabric with a medium density weave, as it will hold your padding in place while still being easy to sew. When you hold medium density weave fabric up to a light, you should be able to see light, but not shapes through the fabric.

## Colour Theory

Colour theory (or the method of choosing colours to use) will be a great help to you as you plan your quilting projects. When discussing colour theory, colours are often referred to as hues. Colours are usually shown in a circular shape, called a **colour wheel**. The colours on a colour wheel are: red, red-orange, orange, yellow-orange, yellow, yellow-green, green, blue-green, blue, blue-purple, purple and red-purple.



**Value** is the lightness or darkness of a colour. In quilting, value is almost more important than colour, as you can create many different effects by using a combination of dark and light colours. Values can appear to change depending on the colours that surround them. A **tint** is a very light value, while a **shade** is a very dark value.



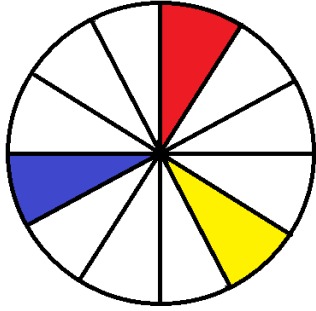

There are three **primary colours:** red, yellow and blue.

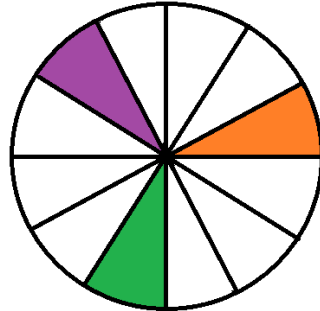

When these primary colours are combined, they create **secondary colours:** orange, green and purple.

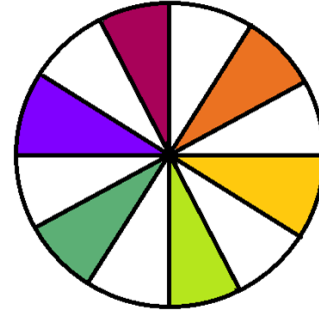

Mixing secondary colours together forms **tertiary colours:** red-orange, yellow-orange, yellow-green, blue-green, blue-purple and red-purple. The various colours are often shown in a circular shape, called a colour wheel.

**Colour schemes** are combinations of colours that look good together. The most common colour schemes in quilting are:

**Monochromatic:** Various tints and hues of a single colour.



**Complementary:** Uses two contrasting colours that are directly across from each other on a colour wheel.

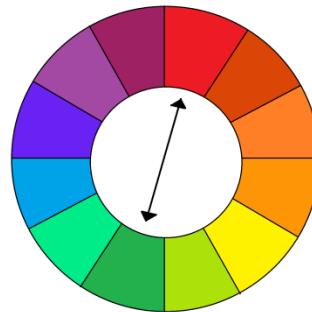

**Analogous:** Uses three colours that are side by side on a colour wheel.

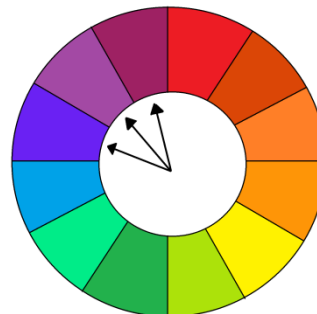

**Triadic:** Uses three colours that form a triangle shape on a colour wheel.

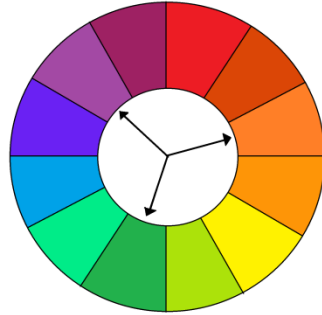

When choosing fabric for a quilt, colour and **print** (patterned fabric) are equally important.

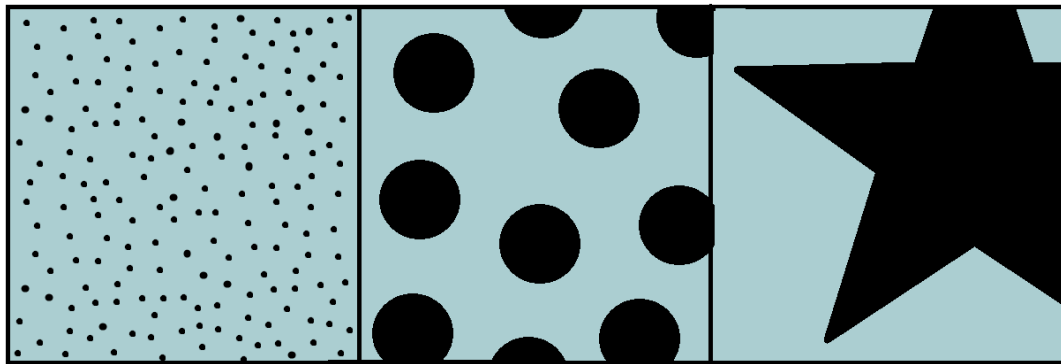

Small-scale print

Medium-scale print

Large-scale print

**Small-scale prints** have a pattern that is tiny in relation to the size of the fabric. From a distance, the fabric may appear solid in colour, but adds visual interest when viewed closely.

**Medium-scale** prints are the most common patterned fabric used for quilting. Using too many styles of prints in your projects will make them appear busy and boring.

**Large-scale** prints are not usually suitable for quilting projects, as the pattern extends far beyond the size of a single quilt block. However, you can use large-scale prints for appliqués or for contrast with smaller prints.

The fabric prints and colours that you choose for your quilting project will have a huge impact on the appearance of your quilt. Choosing two or more fabrics that contrast well with each other will create visual interest. **Contrast** can occur with colour (red and green), scale of print (small-scale and large-scale), or even shape of print (geometric shapes and swirls).

## Estimating Yardage

The amount of fabric that you will need depends on the pattern that you are following. Whether you purchase a pattern from a sewing store or find a pattern online, it should contain information on how much fabric and batting is required, as well as any notions that you may need, such as buttons or specialty thread.

If you are making your own pattern, here are some general sizes to help you determine how much fabric you will need:

- Baby Quilts – 36" x 54"
- Lap Size Quilts – 54" x 72"
- Twin Size Quilts – 54" x 90"
- Double Size Quilts – 72" x 90"
- Queen Size Quilts – 90" x 108"
- King Size Quilts – 108" x 108"

When buying backing fabric, add 6" to the size of your quilt. To determine the amount of batting you will need, add 4" to the size of your quilt.

When purchasing binding tape (or fabric for binding), determine the circumference (outside measurement) of your quilt, and add 6".

## Equipment & Tools

The following equipment and tools will help you get started on your quilting journey:

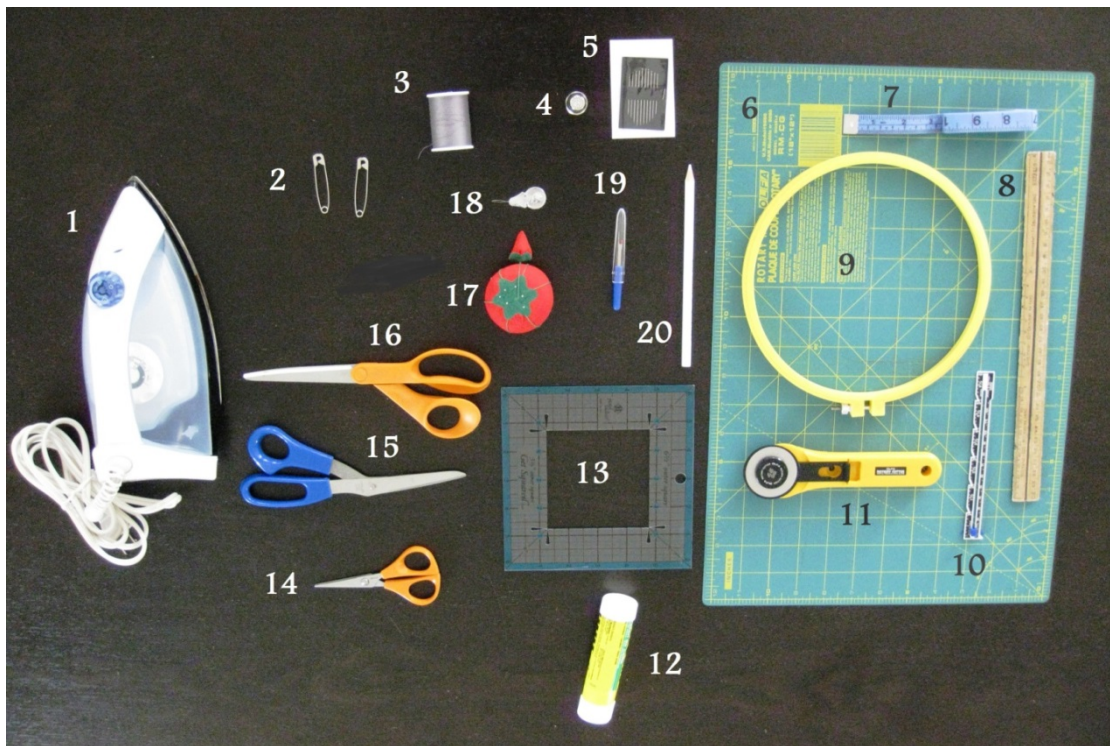





### Quilting Tools Image Reference Chart

1. Iron An iron uses very high temperatures (and sometimes steam) to press fabrics flat and remove wrinkles.
  
2. Quilting Safety Pins Quilting safety pins are larger and more curved than regular safety pins. They are used to hold the layers of a quilt together while they are being quilted.
  
3. Thread Thread is essential for all types of quilting.
  
4. Thimble Thimbles are used for any type of hand sewing or quilting to protect your fingers as you push through thick layers of fabric.
  
5. Hand Sewing Needles Hand sewing needles come in many different lengths and thicknesses. The size you use will depend on your project and preferences.
  
6. Cutting Mat Cutting mats are used with rotary cutters. They are self-healing, meaning that they will not be damaged if they are pierced by the rotary cutter.
  
7. Tape Measure Use your tape measure to measure lengths of fabric, binding tape or batting.
  
8. Ruler A ruler is often easier to use than a measuring tape for small measurements. It also can help you draw a straight line if needed.

9. Quilting Hoop A quilting hoop is used to hold small sections of fabric tight when you are embroidering or hand sewing.
10. Sliding Gauge Sliding gauges are used to accurately mark seam widths, or other short measurements.
11. Rotary Cutter Rotary cutters are a quick and efficient way of cutting small pieces of fabric. A very sharp circular blade rolls over the fabric, cutting as it moves. Make sure you use a cutting mat underneath so you don't damage your table or your cutter.
12. Fabric Glue Stick Fabric glue can come in a stick or spray foam. It is used to lightly hold pieces of fabric together, and depending on the type of glue may wash off. It is used in quilting to help hold layers of fabric together, or to attach pieces to be appliquéd.
13. Rotary Ruler A rotary ruler (or square ruler) is used to help you cut in a straight line when using your rotary cutter. Keep the edge of your cutter pressed firmly against the ruler as you cut.
14. Embroidery Scissors Embroidery scissors are handy to have close by when sewing. Their small size makes it easy to trim loose threads.
15. Paper Scissors Paper scissors should only be used for cutting paper (such as patterns). They are usually too dull to cut fabric.
16. Fabric Shears Fabric shears are used to cut fabric ONLY. Using them to cut paper will dull them and make them unusable.
17. Straight Pins in Pin Cushion Straight pins are used to hold two or more pieces of fabric together as you sew. Many quilters find it easier to keep their pins in a pin cushion, rather than a box, as they can be grabbed quickly and easily.
18. Needle Threader A needle threader can help you put thread through the eye of a hand sewing or machine needle.
19. Seam Ripper A seam ripper is every sewer's best friend! It is used to carefully take out stitching errors.

20. Fabric Marking Pencil

Fabric marking pencils are made of a special lead that will disappear after being washed.

21. Quilting Frame

Quilting frames hold the layers of a large quilting project together so that it can be quilted by hand.

## Sewing Machines

Every brand and style of sewing machine is different – the only way to truly get to know your personal machine is to read the instruction manual. However, each sewing machine has similar components (although they may be in different locations on each machine). These are the basic parts of a sewing machine that you will need to know as you begin quilting.

1. Thread Take-up Lever
2. Thread Direction Pin
3. Bobbin Winding Spool
4. Tension and Stitch Length Dials
5. Reverse Stitch Control
6. Thread Guide
7. Take-up Lever
8. Throat Plate
9. Stitch Guidelines
10. Needle Screw
11. Needle
12. Feed Dogs
13. Presser Foot
14. Presser Foot Screw
15. Hand Wheel
16. Foot Pedal

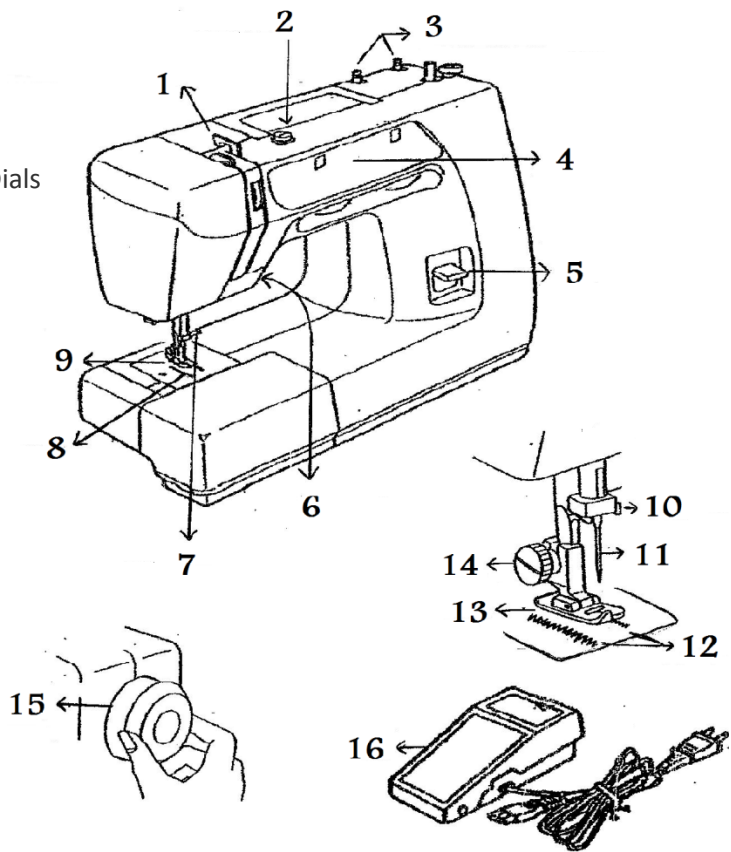

When piecing quilts together, you should use a regular presser foot on your sewing machine.



When quilting on your sewing machine, a walking presser foot can make the job much easier. It has extra teeth to help the feed dogs move thick layers of fabric through the machine.



When quilting, you will need to use the stitch guidelines (located on the throat plate) to help you sew in a straight line. Most sewing projects follow the 5/8" stitch guideline. However, refer to the pattern that you are using to determine which stitch guideline to follow.

If you are hoping to do free-motion quilting (you can find more information about this method of quilting in the next section), you will need a long-arm quilting machine. These sewing machines are specifically designed for the bulk of large quilts; a long arm allows you to freely move the quilt fabric as you sew.



A Husqvarna  
Platinum-3000  
Quilting Machine

## Methods of Quilting

There are three basic methods of quilting: **hand quilting**, **machine quilting**, and **hand tying**. Hand quilting and machine quilting achieve the same results, but using different equipment. The layers of a quilt are sewn together (usually in a pattern) using a needle and thread or a sewing machine. Hand quilting is very time consuming, and requires great skill with a needle and thread. Machine quilting is much quicker, and allows you to sew through thicker layers of fabric with ease. Hand tying attaches the layers of a quilt together by knotting small pieces of yarn through all three pieces of fabric.

Whether you are quilting by hand or by machine, there are a variety of techniques that you can use. Each is equally effective, but will give a different look to your quilt.

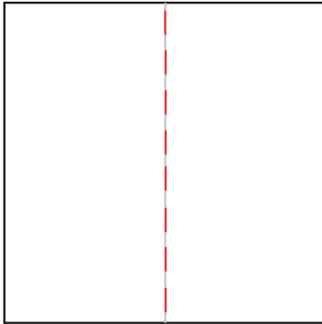

**Stitch-in-the-Ditch:** A method of quilting used for pieced quilts, it involves sewing along each of the pieced seams. Stitch-in-the-ditch quilting is understated and easy to do, and adds some puffiness to the quilt.

**Outline:** A method of quilting used for pieced or appliquéd quilts. Outline quilting involves sewing along the outline of each piece or image. Depending on the contrast of thread used, outline quilting can be subtle or bold. Some quilting fabric is pre-stamped with a quilting pattern that can simply be sewn over.

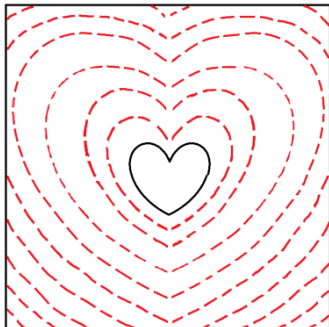
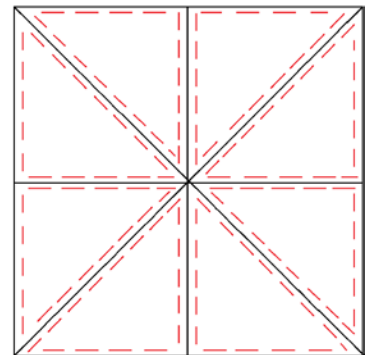

**Echo:** A method of quilting that works best on appliquéd quilts, but can be used on pieced quilts. Echo quilting begins in much the same way as outline quilting, sewing around a piece or image usually at the centre of a quilt. This outlining is continued, gradually increasing in size until the whole quilt is covered. Echo quilting is somewhat difficult, but creates a beautiful end result.

**Selective:** A method of quilting used for pieced or appliquéd quilts. Selective quilting allows the quilter some creative freedom: you can quilt any part of the quilt that you'd like, using any of the above techniques. Selective quilting, when done improperly or without careful planning, can look messy and incomplete.

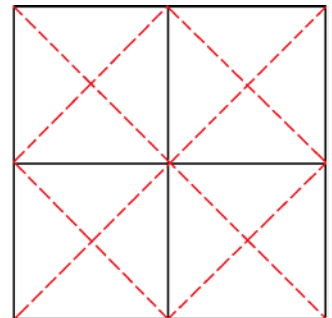

**Free Motion:** Free motion is a quilting technique that is most commonly completed using a sewing machine with lowered feed dogs and a free-motion/darning foot. It is called free-motion because the quilter controls the speed and movement of the fabric as the machine sews. Free-motion quilting is nearly impossible to do on a regular sewing machine – most experienced quilters who practice free-motion quilting own a quilting machine. Most free-motion quilting covers the entire quilt surface, and is done in one of three styles:

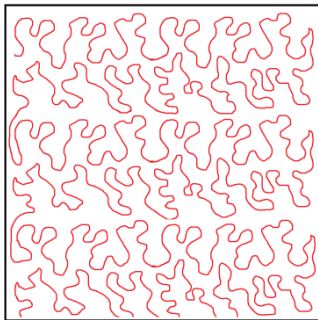

Meandering

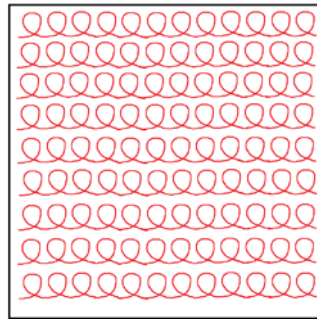

Loop-de-Loop

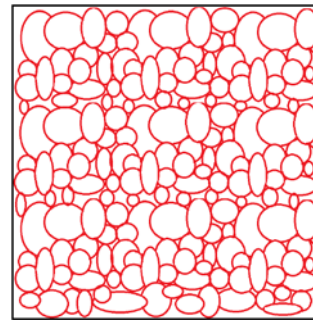

Pebble

- Meandering: a curved and abstract free-motion pattern. No lines ever touch or cross.
- Loop-de-loop: A series of identical loops that cover an entire quilt surface.
- Pebble: A series of rounded shapes, similar in size, that cover an entire quilt surface.

# Unit 3: How to Quilt

---

## Choosing a Pattern

The pattern that you choose for your quilt will influence the fabric and colours, method of quilting, and even the size of your finished product.

Before you begin a project, take some time to look at patterns in a sewing store, or at patterns that a friend or family member owns. Ask questions about the difficulty level, materials, and estimated cost. Each of these could influence your decision.

## Choosing Fabric

The type of fabric that you choose will be determined by the pattern that you are using. You may need to discuss your pattern with a sewing store employee, or an experienced quilter to ensure that you purchase the correct amount and type of fabric. Remember, most quilts are made with 100% cotton fabric.

Once you know how much and what type of fabric to buy, it is time to decide on colours and patterns. As you browse through the available fabrics, ask yourself the following questions?

- **Who am I making this project for?** Your teenage brother might love a bold and graphic yellow and black coloured quilt, but it might not be suitable for your friend's new baby girl.
- **Does this quilt have a theme?** Many quilts and quilting projects incorporate a theme, from *John Deere* to dinosaurs. Most fabric stores have a wide variety of themed fabrics to choose from. If using a theme for a quilting project, it's best to choose one feature fabric, and choose additional fabrics that coordinate with it.
- **Is there a patterned fabric I'd like to feature?** If you fall in love with a green, yellow and white polka-dot fabric, you probably want to choose colours and patterns that will match and allow the featured fabric to stand out. In this case, you might choose your coordinating fabrics in various solid values of green.
- **Is there contrast?** Do the fabrics you chose have a mix of light and dark colours, as well as small, medium, and large scale prints?

## Choosing Batting

The batting that you choose for your quilting project will affect the weight and warmth of your finished project. There are two factors to keep in mind when choosing batting:

- **Loft** refers to how thick or thin your batting is. Low-loft batting is thin, while high-loft batting is thick. Low-loft batting will not be as warm, but is easier to machine quilt. High-loft batting is very warm, but is best suited for quilts that are hand-tied.
- **Fibre** refers to what material the batting is made of. You will likely have three fibre options: polyester (less expensive but tends to shift inside the quilt), cotton (more expensive and can withstand many washes), and cotton/poly-blend (similar to cotton in feel but less expensive).

Remember to purchase a piece of batting that is slightly larger than your quilt top!

## Preparation of Fabric

Once you have purchased your fabric, you will need to prepare it before you begin any cutting.

1. Prewash your fabric using hot water, using a small amount of mild detergent. Remember to separate your dark, medium, and light colours into separate loads.
2. Dry your fabric in the dryer on medium heat.
3. Iron your fabric (using steam) to remove any wrinkles.

## Cutting

Cutting your fabric must be done carefully and exactly, especially when making a pieced quilting project. Cutting pieces can be done using two different methods:

- **Rotary Cutter** – Using a rotary cutter is the fastest and easiest way to cut pieces of fabric. When using a rotary cutter, you must always place a self-healing mat underneath your fabric. Rotary cutters are very sharp, and could easily cut into your table (or through your finger!) if you are not careful. Cutting with a rotary cutter is very quick, but there is a greater chance of making mistakes.
- **Scissors** – Fabric shears or scissors are the traditional way of cutting fabric. A good quality pair of shears will make cutting much easier. NEVER cut paper with your fabric shears, as it will quickly dull them. Cutting with shears takes more time than using a rotary cutter, but is safer.



When cutting multiple pieces of the same size and shape, it makes sense to cut more than one piece at a time. Lay the fabric pieces on top of one another (or fold), and hold carefully in place using pressure from your hand while cutting.

## Piecing

How you piece together your cut fabric to make a quilt will depend on the pattern that you are using. However, there are some basic steps to follow when piecing that are the same for all quilts:

- Always put your fabric pieces right sides-together. This will ensure that your seams are on the back side of your quilt.
- Use straight pins to help hold your pieces together before and during sewing. Place your pins through both layers of fabric, running perpendicular to the edge you will be sewing – imagine your presser foot is a train and the pins are the tracks it will travel over. Perpendicular pins are completely safe to sew over – but parallel pins can break and cause damage to your machine or injury to you!
- Remember to backstitch at the beginning and end of each seam that you sew. This will tie a knot and prevent the stitches from unravelling.

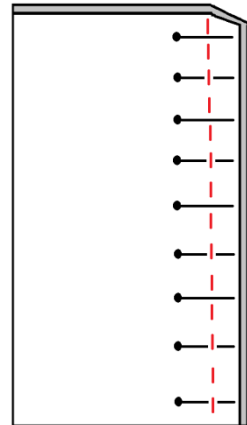

## Pressing and Ironing

Ironing and pressing are two very different things. Ironing involves moving a hot iron over a piece of fabric to remove wrinkles and puckers. You will need to **iron** each piece of fabric that you purchase after it has been washed and dried. To **press** fabric, lift the iron and set it down in the appropriate position – do not slide it! Pressing is done after each seam in a quilt block to ensure that seams lay flat.

After each seam that you sew, you will need to press the seams of your fabric pieces to one side. This will help keep your next seam straight and keep the bulky layers of your quilt top to a minimum. The iron temperature you use will depend on your fabric, but most quilting cotton requires medium-high heat, with some steam. Lay your pieced fabric on an ironing board with the wrong sides facing up. Fold each seam to the side and press flat. Where several seams meet up, ensure that seams are pressed in opposite directions.

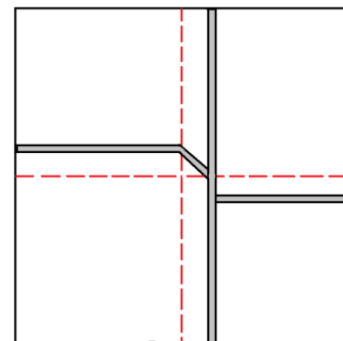

When your quilt top is completed, iron it once more to ensure it does not have any wrinkles.

## Making the Sandwich

Once you have created your entire quilt top, you can begin to make your quilt “sandwich”. Find a large flat hard surface (such as a table or floor) and lay out your ironed quilt back (wrong side facing up). Use a measuring tape to find and mark the centre of the fabric along all four sides. Pull the fabric tight and tape down the edges using masking tape. Lay your quilt batting on top of the quilt back and smooth flat. Finish by laying your quilt top on top of the batting – use your centre line marks to help keep it straight.

Beginning in the centre of the quilt, use quilting pins to hold all three layers together. Smooth the fabric as you pin towards the edges. It’s best to have at least one pin for every six square inches of quilt.

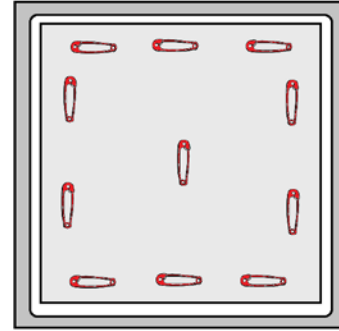

## Quilting

The method and technique of quilting you use will dictate how you go about quilting. Remember though – if you choose to use machine quilting, you cannot sew over quilting pins in the same way that you can straight pins. You must remove each quilting pin as you come to it! Keep a small basket or bowl beside you to place pins into as you sew.

If you are hand tying, leave all of your quilting pins in until you have finished tying your quilt. Once you are done tying, you can remove all of the pins.

After quilting is completed, you can use your fabric shears to cut all three layers to the same size. If you are doing a rolled-edge binding, make sure your quilt back is larger than your top and batting!

## Binding

Binding is the process of creating a finished edge on your quilt. There are two methods of binding:

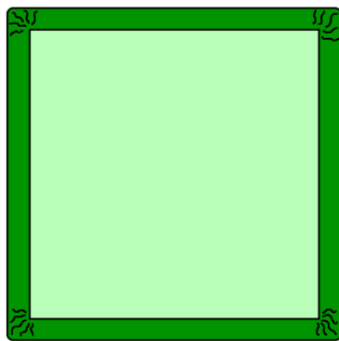

**Rolled-Edge Binding:** Rolled-edge binding uses the quilt back to create a finished edge on a quilt. It creates a more casual style of quilt. To make a rolled-edge binding, the quilt back is cut slightly larger than the top. The greater the size difference between the quilt back and the top/batting, the larger the binding will be. Press a small fold around the outside of your quilt back (towards the wrong side), approximately 1-2 cm wide. Fold the quilt back until it overlaps the quilt top and pin. Sew as close to the edge of

the binding as you can, all the way around your quilt.

**Binding Tape:** Binding the edges of a quilt with binding tape creates a polished, formal look but requires the purchase of binding tape. Binding tape is a folded and ironed strip of fabric that is pinned and sewn around the edges of a quilt. Binding tape can be purchased in a variety of colours, fabrics and widths.

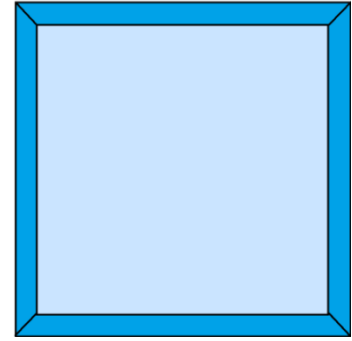

## Embellishments and Special Effects

There are many ways to embellish your quilt to add interest.

- **Embroidery:** Many quilters choose to embroider images or patterns onto their quilts or quilt blocks.



Pieced quilt with embroidery made by Elsie Thiessen



- **Pockets:** For more casual quilts (especially denim or jean quilts), pockets can be added to create interest, texture and a handy storage space!
- **Drawings:** You can use special fabric markers (or even permanent markers) to draw images on a quilt top. This is a great way to involve a large group of people, such as a family or class in the creation of a quilt.



Patchwork hand-tied denim quilt with marker drawings and pockets made by the Grade 4 class of Vanguard School, 1991

- **Photos:** You can purchase special printer transfer paper that will allow you to print any image or photo from your computer and iron it on to your fabric. This transfer paper is often quite delicate and shouldn't be used on quilts that will be frequently washed.
- **Buttons, Tassels and Add-ons:** The sky is the limit when it comes to decorating your quilt with buttons, tassels or other add-ons (such as iron-on patches). However, keep in mind that any embellishments that could be pulled off are not suitable for quilts that will be used by small children.



Appliqué hand-quilted wall hanging with buttons made by Naomi Gitzel

## Quilt Care

Handmade quilting projects must be carefully cared for in order to preserve the integrity of the fabric and stitching.

- **Laundering:** The less you wash your quilt, the better. Before you wash a quilt, test the fabric for colour-fastness. Wet a piece of white cloth with water and gently rub it over each type of fabric on the quilt. If any colour rubs off onto the white fabric, the quilt should not be washed. If your quilt is colour-fast, wash with cold water and gentle detergent either by hand or on the gentle cycle in a washing machine.
- **Drying:** Proper drying is important to keep the seams in your quilt from breaking. Quilts should be laid flat to dry. Never put your quilt in the dryer, or hang it from a clothesline!
- **Storage:** The best place to store a quilt or quilting project is lying flat (such as on a bed or wall) and out of direct sunlight. If you must put your quilt in storage, ensure it is completely dry. Gently fold the quilt around pieces of acid-free tissue paper (to prevent sharp creases), and place in a cotton bag or acid free box. Store in a dry location where the temperature does not fluctuate.

# Unit 4: Quilting and Your Community

---

In the past quilting was a community activity – and it can be just as effective at bringing a community together today! Consider the following ways to use quilts to bring people together:

- Join a quilting guild, or get to know an experienced quilter. They can teach you valuable quilting skills and knowledge that will help you get started on your quilting journey. And you just might form a new friendship!
- Make a patchwork quilt with your family, classmates, 4-H club members, teammates, or a group of friends! Give each person a square of fabric and allow them to decorate it using fabric paint, markers, photo transfer paper or other methods of embellishment. Consider giving the quilt as a gift to a coach or a leader!
- Make and donate quilts! The options for donating quilts are almost endless. Baby quilts can be given to a local women’s shelter for newborns. Full-size quilts can be given to homeless shelters, medical assistance groups such as the *Ronald McDonald House*, or sent overseas to soldiers. You’ll get to improve your quilting skills, and make a child’s life better!
- Hold a quilt auction or raffle to raise money for a cause. Once you have completed a quilt (either by yourself or with a group), people can buy tickets or place a bid to win it. Make sure you display your quilt somewhere it will be noticed, such as in the main office at your school.
- Hold a quilting bee and quilt show. Invite the whole community to come together to learn how to quilt, and display finished quilts. Experienced quilters can teach novice quilters – and even non-quilters can come and enjoy looking at the all of the beautiful handiwork.

# Unit 5: Quilting Projects

---

Quilting does not just mean making bedspreads – there are countless other projects that use quilting techniques. The following are just a few ideas:



Watermelon quilted table runner made by Karen Hanel



Reverse appliqué wall hanging made by Naomi Gitzel



Pieced baby quilt with ruffled binding and heart embroidery made by Elya Lam



Pieced headboard made by Elsie Thiessen





Pieced pillow, baby blanket  
and banner made by Dana Hupe



Pieced baby blanket  
made by Tammy Walerius

Pieced baby blanket  
made by Tammy Walerius



Pieced baby blanket  
made by Tammy Walerius





Rag baby blankets made by Cara Cuch

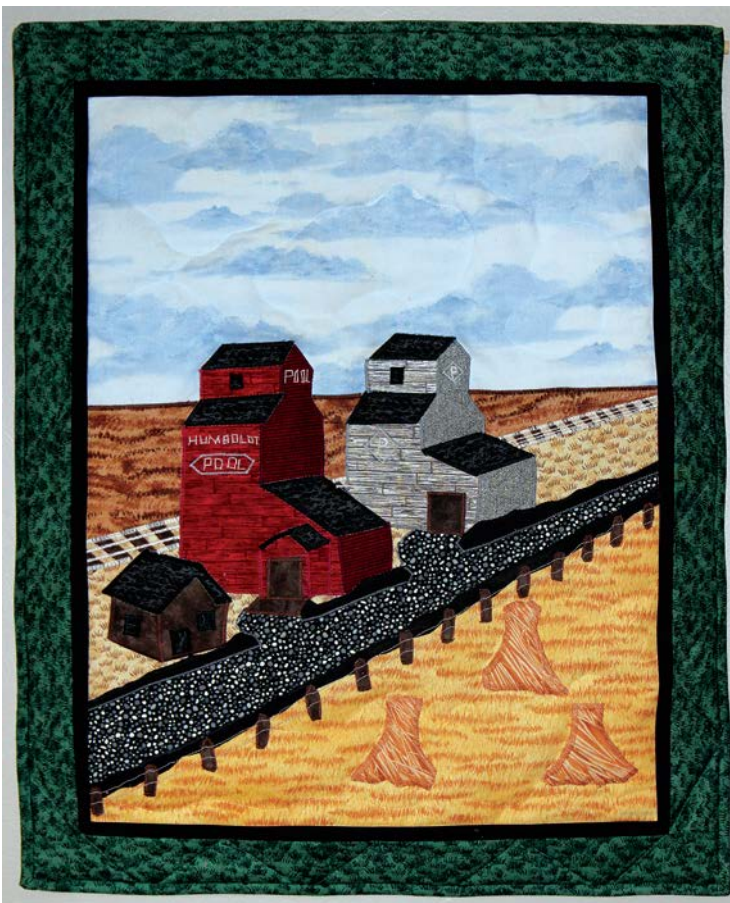

Quilted Wall Hanging  
made by Gladys Ewanick

# Glossary

---

**Analogous** – A colour scheme which uses three colours that are side by side on a colour wheel.

**Appliqué** – Involves cutting shapes or letters out of fabric, and attaching them to another piece of fabric by sewing.

**Appliqué Quilts** – Quilts covered in appliqué.

**Back** – The bottom layer of a quilt. This is usually a whole piece of cloth.

**Batting** – A layer of padding to add weight and warmth to a blanket.

**Bias** – The direction of a fabric which runs at a 45 angle to the selvage edge and has the most amount of stretch.

**Colour schemes** – Combinations of colours that look good together.

**Complementary** – A colour scheme which uses two contrasting colours that are directly across from each other on a colour wheel.

**Contrast** – The state of being very different. On a quilt, contrast can occur with colour (red and green), scale of print (small- and large-scale), or even shape of print (geometric and swirls).

**Crosswise grain** – The direction of a fabric which runs perpendicular to the selvage edge and has some stretch.

**Fabric** – A cloth made by weaving, knitting, or felting fibres.

**Feed-Dogs** – Angled “teeth” on the bottom of a sewing machine that pulls fabric forwards as you sew. When doing free-motion quilting, feed-dogs must be lowered so that you manually control the movement of the fabric.

**Guild** – Traditionally, a medieval group of employed craftsman (such as carpenters or blacksmiths) who would get together to control and enforce the accurate continuation of their craft. Members of quilting guilds today strive to ensure that old patterns and techniques are not forgotten, while also providing a support system and community for other quilters.

**Hand-Quilting** – Quilting layers of fabric together by hand, using a needle and thread.

**Hand-Tying** – Tying and knotting pieces of thread to quilt layers of fabric together by hand.

**Hand-Wheel** – A large dial on a sewing machine that allows you to move the needle up and down by hand.

**Hue** – A very dark value.

**Iron** – Moving a hot iron over pieces of fabric to remove wrinkles and puckers.

**Large-scale prints** – Not usually suitable for quilting projects, as the pattern extends far beyond the size of a single quilt block. However, you can use large-scale prints for appliqués or for contrast with smaller prints.

**Lengthwise grain** – The direction of a fabric which runs parallel to the selvage edge, and has very little stretch.

**Loft** – How thick or thin your batting is. Low-loft batting is thin, while high-loft batting is thick.

**Machine-Quilting** – Quilting layers of fabric together using a sewing machine.

**Medium-scale prints** – Have a pattern that is medium in relation to the size of the fabric. The most common size of print used when quilting.

**Monochromatic** – A colour scheme which uses tints and hues of a single colour.

**Patchwork** – Simple pieced quilts that use only squares or rectangles.

**Pieced Quilts** – Made by sewing small pieces of fabric together into different patterns and shapes.

**Press** – Lifting and setting an iron down on a piece of fabric to help seams hold their place.

**Presser Foot** – A metal plate on a sewing machine that lowers onto fabric to hold it in place as you sew.

**Primary colours** – Colours that cannot be made by mixing other colours: red, yellow and blue.

**Print** – Patterns printed on a piece of fabric.

**Quilting** – A type of sewing which involves attaching two or more layered pieces of fabric together.

**Quilts** – Heavy, warm bedspreads or blankets, usually made of at least three layers of fabric.

**Reverse Stitch Control** – A button or dial that allows you to sew in reverse on a sewing machine.

**Secondary colours** – Colours made by mixing primary colours: orange, green and purple

**Selvage** – The factory finished edge of a fabric. It should be a perfectly straight line.

**Small-scale prints** – They have a pattern that is tiny in relation to the size of the fabric. From a distance, the fabric may appear solid in colour, but adds visual interest when viewed closely.

**Tertiary colours** – Colours made by mixing primary and secondary colours: red-orange, yellow-orange, yellow-green, blue-green, red-purple and blue-purple.

**Tint** – A very light value.

**Top** – The topmost (or front) layer of a quilt. This is usually the part of the quilt that is decorated with intricate patchwork patterns or appliqué.

**Triadic** – A colour scheme which uses three colours that form a triangle shape on a colour wheel.

**Value** – The lightness or darkness of a colour.

**Walking Presser Foot** – A presser foot specifically designed for quilting. It has extra teeth that work with the feed dogs to move thick layers of fabric through the sewing machine.

**Weave** – How tightly the threads that make up the fabric are held together.

**Whole-cloth Quilts** – Have a top made from a single piece of fabric.

# References

---

- "1/4" Quilting Foot, Low Shank #P60801." Sewing Parts Online. N.p., n.d. Web. 11 June 2013. <<http://www.sewingpartsonline.com/1-4-inch-foot-low-p60801.aspx>>.
- "American Quilter's Society." American Quilter's Society. Schroeder Publishing, n.d. Web. 11 June 2013. <<http://www.americanquilter.com/>>.
- "Batting and Backing 101." *Diary of a Quilter*. Amy Smart, n.d. Web. 09 July 2013. <<http://www.diaryofaquilter.com/2010/10/little-bit-batty.html>>.
- "fabric." Dictionary.com Unabridged. Random House, Inc. 16 May. 2013. <<http://dictionary.reference.com/browse/fabric>>.
- "FREE Quilting Motifs." Forest Quilting. Forest Quilting, n.d. Web. 11 June 2013. <[http://www.forestquilting.com/motifs\\_free\\_pg2.html](http://www.forestquilting.com/motifs_free_pg2.html)>.
- "Quilting Frame." The Grace Company. The Grace Company, n.d. Web. 08 July 2013. <<https://store.graceframe.com/cart/hand-quilting-frames/z44.html>>
- "Simple Heart Medallion." Sunrise Quilt Studio. Sunrise Quilt Studio, n.d. Web. 11 June 2013. <<http://sunrisequiltstudio.blogspot.ca/2010/11/simple-heart-medallion.html>>.
- "Trapunto Quilting." *Wikipedia*. Wikimedia Foundation, 04 Feb. 2013. Web. 08 July 2013. <[http://en.wikipedia.org/wiki/Trapunto\\_quilting](http://en.wikipedia.org/wiki/Trapunto_quilting)>.
- "Walking Foot, Singer #76837." Sewing Parts Online. N.p., n.d. Web. 11 June 2013. <<http://www.sewingpartsonline.com/walking-foot-singer-76837.aspx>>.
- Dean, Connie. "Quilt Size Reference Chart." Flying Geese Quilt Guild. Flying Geese Quilt Guild Inc., n.d. Web. 11 June 2013. <<http://fgqg.com/Quiltsizes.htm>>.
- Gillespie, Spike. *Quilts around the World: The Story of Quilting from Alabama to Zimbabwe*. Minneapolis: Voyageur, 2010. Print.
- Holstein, Jonathan. *The Pieced Quilt; an American Design Tradition*. Greenwich, CT: New York Graphic Society, 1973. Print.

Houck, Carter. *The Quilt Encyclopedia Illustrated*. New York: Harry N. Abrams, 1991. Print.  
<http://new.husqvarnaviking.com/en-US/Machines/PLATINUM-3000>

Kiracfe, Roderick. *The American Quilt*. New York: Clarkson Potter, 1993. Print.

Leverette, Mary. "How to Care for Handmade Quilts." *About.com Laundry*. About.com, n.d.  
Web. 09 July 2013. <<http://laundry.about.com/od/laundrybasics/a/carenewquilts.htm>>.

Prichard, Sue. *Quilts, 1700-2010: Hidden Histories, Untold Stories*. London: V&A Pub., 2010.

Roberts, Elise Schebler., and Jennifer Chiaverini. *The Quilt: A History and Celebration of an American Art Form*. St. Paul, MN: Voyageur, 2007. Print.

Seward, Linda. *Successful Quilting: A Step-by-step Guide to Mastering the Techniques of Piecing, Appliqué & Quilting*. Emmaus, PA: Rodale, 1991. Print.







Saskatchewan

3830 Thatcher Avenue  
Saskatoon, Saskatchewan S7R 1A5  
306-933-7727 • 306-933-7730 (fax)  
[www.4-h.sk.ca](http://www.4-h.sk.ca) • [info@4-h.sk.ca](mailto:info@4-h.sk.ca)