

# TABLE OF CONTENTS

SECTION		PAGE
1	INTRODUCTION .....	3
2	THINGS TO KNOW BEFORE STARTING YOUR VEHICLE .....	7
3	UNDERSTANDING THE FEATURES OF YOUR VEHICLE .....	51
4	UNDERSTANDING YOUR INSTRUMENT PANEL .....	101
5	STARTING AND OPERATING .....	149
6	WHAT TO DO IN EMERGENCIES .....	175
7	MAINTAINING YOUR VEHICLE .....	187
8	MAINTENANCE SCHEDULES .....	235
9	IF YOU NEED CONSUMER ASSISTANCE .....	251
10	INDEX .....	261



---

# INTRODUCTION

## CONTENTS

---

■ Introduction . . . . .	4	■ Warnings And Cautions . . . . .	6
■ How To Use This Manual . . . . .	4	■ Vehicle Identification Number . . . . .	6

### INTRODUCTION

This manual has been prepared with the assistance of service and engineering specialists to acquaint you with the operation and maintenance of your new vehicle. It is supplemented by a Warranty Information Booklet and various customer oriented documents. You are urged to read these publications carefully. Following the instructions and recommendations in this manual will help assure safe and enjoyable operation of your vehicle.

**NOTE:** After you read the manual, it should be stored in the vehicle for convenient reference and remain with the vehicle when sold.

When it comes to service, remember that your manufacturer's dealer knows your vehicle best, has the factory-trained technicians and genuine Mopar® parts, and is interested in your satisfaction.

### WARNING!

**Engine exhaust, some of its constituents, and certain vehicle components contain or emit chemicals known to the State of California to cause cancer and birth defects or other reproductive harm.**

### HOW TO USE THIS MANUAL

Consult the table of contents to determine which section contains the information you desire.

The detailed index, at the rear of this manual, contains a complete listing of all subjects.

Consult the following table for a description of the symbols that may be used on your vehicle or throughout this owner's manual:

 TURN SIGNALS	 REAR WINDOW WIPER	 WINDSHIELD WIPER INTERMITTENT	 BRAKE BRAKE SYSTEM WARNING PARKING BRAKE	 HIGH BEAM	 HORN	 UPPER AIR OUTLET	 HEATED SEAT LOW	 DOOR LOCK	 ADJUSTABLE PEDALS
 FUEL	 REAR WINDOW INTERMITTENT WIPER	 WINDSHIELD WASHER	 FAILURE OF ANTI-LOCK BRAKING SYSTEM	 LOW BEAM	 KEY ACTIVATE (POWER OUTLET)	 UPPER AND LOWER AIR OUTLET	 HEATED SEAT HIGH	 WINDOW LIFT	 TIRE PRESSURE MONITOR
 FUEL FILL SIDE	 REAR WINDOW WASHER	 WINDSHIELD WASHER FLUID LEVEL	 SEAT BELT	 FRONT FOG LIGHT	 HOOD RELEASE	 LOWER AIR OUTLET	 RECIRCULATION	 CONVERTIBLE 4 WINDOW DOWN	 VOICE RECOGNITION BUTTON
 ENGINE OIL	 REAR WINDOW DEFROST	 WINDSHIELD, ELECTRICALLY HEATED	 AIRBAG	 EXTERIOR BULB FAILURE	 LIFTGATE RELEASE AND LIFTGATE OPEN	 DEFROST AND LOWER AIR OUTLET	 VENTILATING FAN	 POWER STEERING FLUID	 UCONNECT™ BUTTON
 BATTERY CHARGING	 HEATED MIRROR	 WINDSHIELD DEFROST	 SIDE AIRBAG	 DOME LIGHT	 SLIDING DOOR	 TRUNK / DECK RELEASE	 AIR CONDITIONING	 SEE OWNER'S MANUAL	 TRACTION CONTROL
 ENGINE COOLANT TEMPERATURE	 CHILD SEAT TETHER ANCHOR	 WINDSHIELD WIPER AND WASHER	 HAZARD	 PARK LIGHTS	 SLIDING DOOR	 CONVERTIBLE TOP UP	 EMERGENCY RELEASE HANDLE	 INSTRUMENT PANEL ILLUMINATION	 WARNING
 ENGINE	 LOWER ANCHORS AND TETHER FOR CHILDREN (LATCH)	 SRS AIRBAG SUPPLEMENTAL RESTRAINT SYSTEM	 WINDOW LOCK	 LIGHTER	 DOOR AJAR	 CONVERTIBLE TOP DOWN	 PASSENGER AIRBAG OFF	 MASTER LIGHTING SWITCH	

81077be5

### WARNINGS AND CAUTIONS

This manual contains **WARNINGS** against operating procedures which could result in an accident or bodily injury. It also contains **CAUTIONS** against procedures which could result in damage to your vehicle. If you do not read this entire manual you may miss important information. Observe all Warnings and Cautions.

### VEHICLE IDENTIFICATION NUMBER

The vehicle identification number (VIN) is on a stamped plate at the left front corner of the instrument panel, visible through the windshield. This number also appears on the Automobile Information Disclosure Label affixed to a window on your vehicle. Save this label as a convenient record of your vehicle identification number and optional equipment.

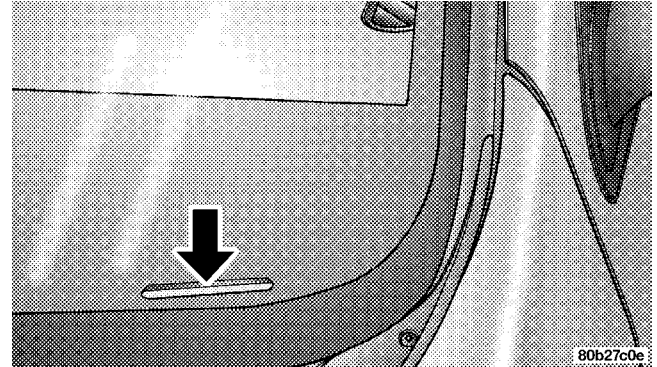

# THINGS TO KNOW BEFORE STARTING YOUR VEHICLE

## CONTENTS

■ A Word About Your Keys . . . . .	9	□ Automatic (Rolling) Door Locks . . . . .	16
□ Sentry Key Engine Immobilizer — If Equipped . . . . .	9	□ Automatic Unlock On Exit (Only Available If Automatic Door Locks Enabled) . . . . .	18
□ Ignition Key Removal . . . . .	12	■ Remote Keyless Entry . . . . .	18
□ Key-In-Ignition Reminder . . . . .	12	□ To Unlock The Doors . . . . .	18
□ Floor Shift Ignition Interlock System . . . . .	13	□ Enable/Disable Lamp Flash . . . . .	19
■ Glove Compartment Lock . . . . .	13	□ To Lock The Doors . . . . .	19
■ Illuminated Entry System . . . . .	14	□ Enable/Disable Horn Chirp . . . . .	19
■ Door Locks . . . . .	14	□ To Unlock The Trunk . . . . .	19
□ Power Door Locks . . . . .	14	□ Enable/Disable Trunk Press And Hold . . . . .	19
□ Central Locking Feature — If Equipped . . . . .	15	□ Panic Alarm . . . . .	20
□ “Child-Protection” Lock System (Rear Doors) . . . . .	15	□ To Use The Panic Alarm . . . . .	20

## 8 THINGS TO KNOW BEFORE STARTING YOUR VEHICLE

□ To Program Additional Transmitters . . . . .	.20	□ Lap/Shoulder Belts . . . . .	.28
□ Transmitter Linked To Memory Programming . . . . .	.21	□ Seat Belts And Pregnant Women . . . . .	.32
□ General Information . . . . .	.22	□ Seat Belt Extender . . . . .	.32
□ Transmitter Battery Service . . . . .	.22	□ Driver And Right Front Passenger Supplemental Restraint System (SRS) - Airbag . . . . .	.33
■ Security Alarm System . . . . .	.23	□ Child Restraint . . . . .	.41
□ To Set The Alarm . . . . .	.23	■ Engine Break-In Recommendations . . . . .	.48
□ To Disarm The System . . . . .	.24	■ Safety Tips . . . . .	.49
□ Security System Manual Override . . . . .	.24	□ Exhaust Gas . . . . .	.49
■ Power Windows . . . . .	.25	□ Safety Checks You Should Make Inside The Vehicle . . . . .	.49
■ Remote Trunk Lid Release . . . . .	.25	□ Periodic Safety Checks You Should Make Outside The Vehicle . . . . .	.50
■ Trunk Safety Warning . . . . .	.26		
□ Trunk Emergency Release . . . . .	.26		
■ Occupant Restraints . . . . .	.27		



## A WORD ABOUT YOUR KEYS

You can insert the double sided keys into the locks with either side up.

The dealer that sold you your new vehicle has the key code numbers for your vehicle locks. These numbers can be used to order duplicate keys only from your dealer. Ask your dealer for these numbers and keep them in a safe place.

### CAUTION!

**An unlocked car is an invitation to thieves. Always remove the key from the ignition and lock all the doors when leaving the vehicle unattended.**

## Sentry Key Engine Immobilizer — If Equipped

The Sentry Key Immobilizer System prevents unauthorized operation of the vehicle by disabling the engine. The system will shut the engine down after 2 seconds of running if an invalid key is used to start the vehicle. This system utilizes ignition keys which have an electronic chip (transponder) embedded into them. Only keys that

have been programmed to the vehicle can be used to start and operate the vehicle for more than the two second validation time period.

The Sentry Key Immobilizer System does not need to be armed or activated. Operation of the system is automatic regardless of whether or not the vehicle is locked or unlocked. During normal operation, the Sentry Key Indicator light, located on the instrument panel upper cover, will come on for 3 seconds immediately after the ignition is turned on for a bulb check. Afterwards, if the bulb remains on solid, this indicates a problem with the electronics. If the bulb begins to flash after the bulb check, this indicates that an invalid key has been used to start the vehicle or there is a communication failure between the transponder and the Sentry Key Immobilizer module. Both of these conditions will result in the engine being shut down after 2 seconds of running. Keep in mind that a key which has not been programmed is also considered an invalid key even if it is cut to fit the ignition for that vehicle. All of the keys provided with your new vehicle have been programmed to the vehicle electronics.

## 10 THINGS TO KNOW BEFORE STARTING YOUR VEHICLE

If the Sentry Key Immobilizer System indicator light comes on during normal vehicle operation (it has been running for longer than 10 seconds) a fault has been detected in the electronics and the vehicle should be serviced as soon as possible.

### NOTE:

- The Sentry Immobilizer System is not compatible with remote starting systems. Use of these systems may result in vehicle starting problems and loss of security protection.
- Mobil SpeedPass, additional sentry keys, or any other transponder equipped components on the same key-chain will **not** cause a key-related (transponder) fault unless the additional part is **physically held against the ignition key** being used when starting the vehicle. Cell phones, pagers, or other RF Electronics will also not cause interference with this system.

The Theft Alarm Light, located on top of the instrument panel, will illuminate for about 3 seconds when the ignition switch is first turned to the On position. If the vehicle electronics do not receive a valid signal from the

ignition key, the theft alarm light will flash continuously to signal that the vehicle has been immobilized. If the Theft Alarm Light remains On during vehicle operation, it indicates a fault in the system electronics.

All of the keys provided with your new vehicle have been programmed to the vehicle electronics.

### Important Note about Service

A four digit PIN is needed to service the Sentry Key Immobilizer System. This number can be obtained by the dealership. However, this number can also be found on your customer invoice that you were given upon receipt of your vehicle. **YOU MUST BRING ALL SENTRY KEYS** that are programmed to your vehicle with you when bringing your vehicle in for service.

### Replacement Keys

**NOTE:** Only keys that have been programmed to the vehicle electronics can be used to start the vehicle. Once a Sentry Key has been programmed to a vehicle, it can not be programmed to any other vehicle.

At the time of purchase, the original owner is provided with a four digit PIN number. This number is required

for dealer replacement of keys. Duplication of keys may be performed at an authorized dealer or by using the Customer Key Programming procedure. This procedure consists of programming a blank key to the vehicle electronics. A blank key is one which has never been programmed.

**NOTE: When having the Sentry Key System serviced, bring all vehicle keys to the dealer.**

### Customer Key Programming

You can program new keys to the system if you have two valid keys by doing the following:

1. Insert the first valid key into the ignition and turn the ignition On for at least 3 seconds but no longer than 15 seconds.

Turn the ignition Off and remove the first key.

2. Insert the second valid key and switch the ignition On within 15 seconds. After ten seconds a chime will sound and the Theft Alarm Light will begin to flash.

Turn the ignition Off and remove the second key.

3. Insert a blank Sentry Key into the ignition and switch the ignition On within 60 seconds. After 10 seconds a single chime will sound. The Theft Alarm Light will stop flashing, and turn On for 3 seconds; then turn Off.

The new Sentry Key has been programmed. Repeat this process to program up to a total of 8 keys.

### CAUTION!

**An unlocked car is an invitation to thieves. Always remove the key from the ignition, lock the doors, close the windows, and raise the top when leaving the vehicle unattended.**

### General Information

The Sentry Key system complies with FCC rules part 15 and with RS-210 of Industry Canada. Operation is subject to the following two conditions:

1. this device may not cause harmful interference

## 12 THINGS TO KNOW BEFORE STARTING YOUR VEHICLE

2. this device must accept any interference that may be received, including interference that may cause undesired operation

### Ignition Key Removal

Place the shift lever in Park and make sure that the shift knob push-button (vehicles with floor shift) is in the out position.

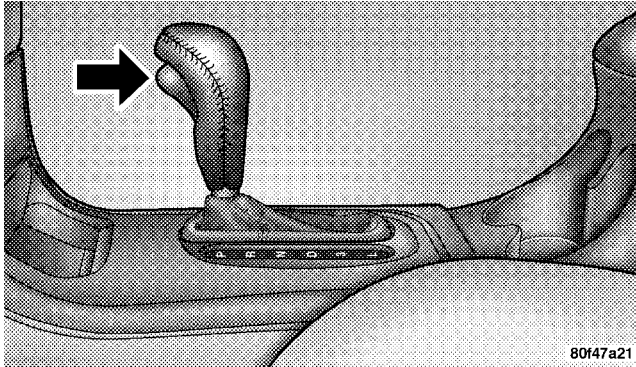

Turn the key to the Lock position and remove the key.

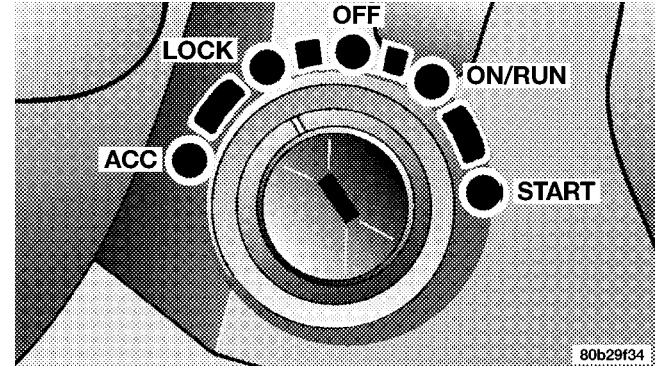

**NOTE:** If you try to remove the key before you place the lever in Park, the key may become trapped temporarily in the key cylinder. If this occurs, turn the key clockwise slightly, then remove the key as described.

### Key-In-Ignition Reminder

Opening the driver's door when the key is in the ignition and is in the OFF, LOCK, or ACC position, sounds a signal to remind you to remove the key.

### Floor Shift Ignition Interlock System

This system prevents the key from being removed unless the shift lever is in PARK and the shift knob push button is out. It also prevents shifting out of PARK unless the key is in the OFF or RUN positions.

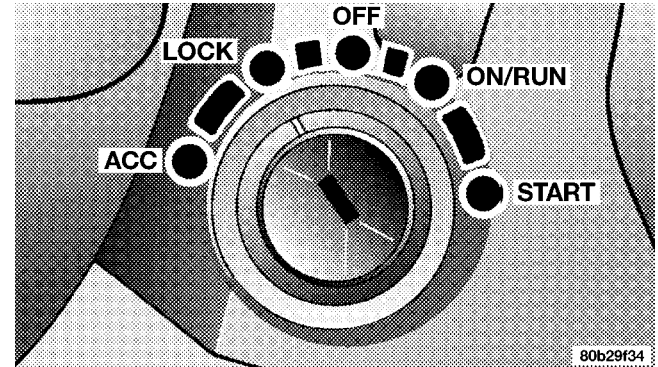
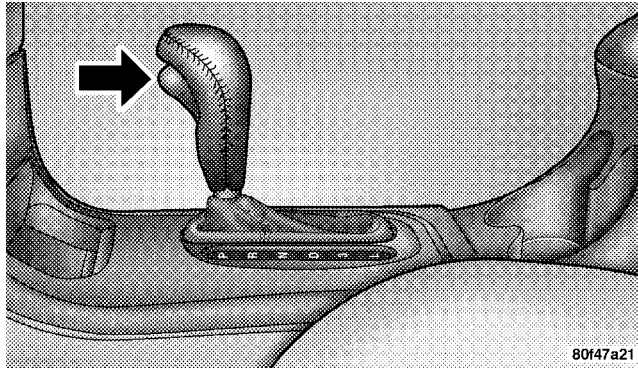

2

### GLOVE COMPARTMENT LOCK

The glove box lock has been designed so that the key can be inserted only about half way. Do not force the key past this point.

### ILLUMINATED ENTRY SYSTEM

The interior lights will come on when you unlock the vehicle with the remote keyless entry or central unlock. They will remain on for about 30 seconds after all doors are closed then fade to off.

The lights also will fade to off if you turn on the ignition after you close all the doors.

### DOOR LOCKS

#### Power Door Locks

There is a door lock switch on each front door trim panel. Press this switch to lock or unlock the four doors.

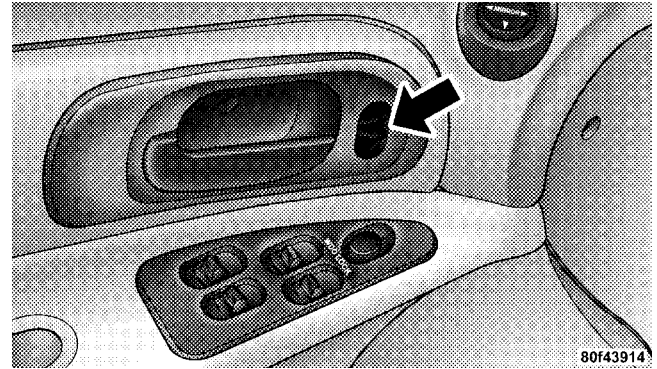

If you press the door lock switch while the keys are in the ignition switch, with the ignition switch in the ACC, LOCK, or OFF position, and the driver's door is open, the doors will not lock. A chime will sound as a reminder to remove the keys.

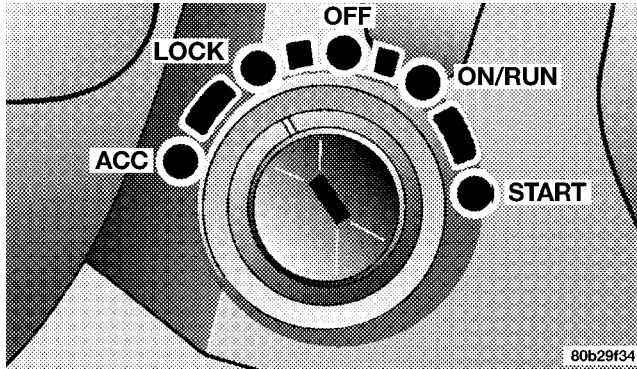

### WARNING!

For personal security and safety in the event of an accident, lock the vehicle doors as you drive and when you park and leave the vehicle.

2

The rear doors cannot be opened from inside the vehicle until you pull up the lock plungers.

#### Central Locking Feature — If Equipped

Turning the key in the driver's door to the unlock position once will unlock only the driver's door. Turning the driver's door lock to the unlock position twice within five seconds, will unlock all doors.

Locking either front door with the key will lock all doors.

#### "Child-Protection" Lock System (Rear Doors)

To provide a safer environment for small children riding in the rear seat, the rear doors of your vehicle have the "child-protection" door lock system.

## 16 THINGS TO KNOW BEFORE STARTING YOUR VEHICLE

To use the system, open each rear door and use a key to move the control near the door latch UP to the “Engage” position as shown on the door label. When the system on a door is engaged, that door can be opened only by using the outside door handle. This will occur only if the inside door lock is in the unlocked (up) position.

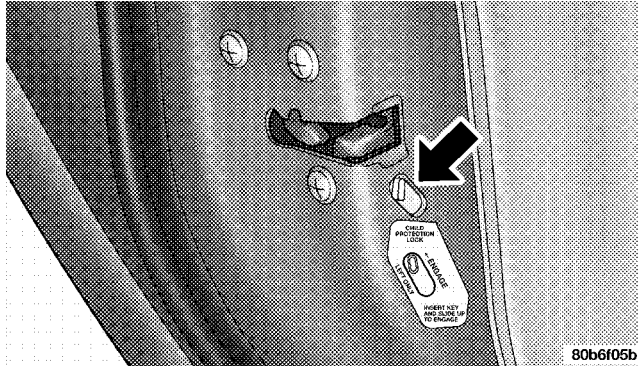

**NOTE:** For emergency exit with the system engaged, move the lock plunger up (unlocked position), lower the window and open the door with the outside door handle.

### WARNING!

**Avoid trapping anyone in the vehicle in a collision. Remember that the rear doors can only be opened from the outside when the child protection locks are engaged.**

### Automatic (Rolling) Door Locks

On vehicles equipped with an EVIC (Electronic Vehicle Information Center), these functions can be selected at the EVIC using the Customer Programmable Features. Refer to the EVIC-Customer Programmable Features for details.

The doors will lock automatically, as delivered from the factory, if:

1. The transaxle is in gear,
2. all doors are closed,
3. vehicle speed is above 15 m.p.h. (24 km/h),
4. the accelerator pedal is depressed.



The Automatic Door Locks can be disabled or re-enabled by performing the same following procedure:

1. Close all doors and place the key in the ignition.
2. Cycle the ignition switch between OFF and ON/RUN and back to OFF 4 times ending up in the OFF position.

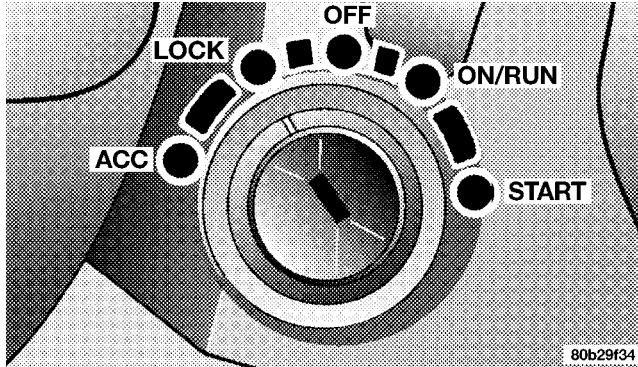

3. **Depress** the power door lock switch to lock the doors.

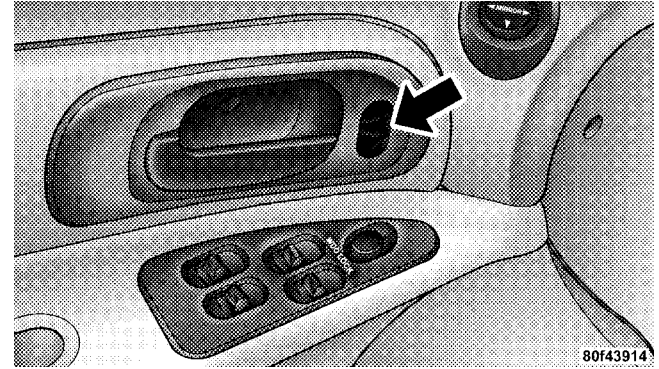

2

4. A single chime will indicate the completion of the programming.

### Automatic Unlock on Exit (Only Available if Automatic Door Locks Enabled)

This feature will unlock all the doors when the driver's door is opened and the ignition switch is in the LOCK position. This function is disabled as delivered from the factory. Automatic Unlock on Exit can be enabled or disabled by performing the following procedure:

1. Close all doors and place the key in the ignition.
2. Cycle the ignition switch between ON/RUN and OFF 4 times ending up in the OFF position.

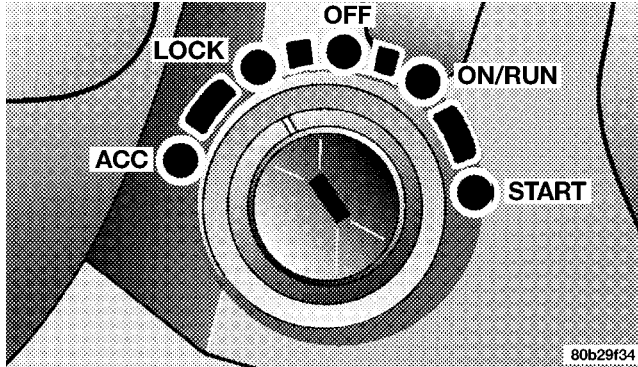

3. Press **upward** on the power door unlock switch to unlock the doors.
4. A single chime will indicate the completion of the programming.

### REMOTE KEYLESS ENTRY

This system allows you to lock or unlock the doors and unlock the trunk from distances up to 40 feet (12 meters) using a transmitter. You don't have to point the transmitter at the vehicle to activate the system.

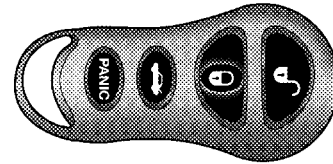

80b31f52

### To unlock the doors:

Press and release the unlock button on the transmitter.

**NOTE:** The system may be programmed to unlock all the doors upon the first press of the Unlock button. To toggle between the first press unlock of driver's door to unlock of all doors, perform the following procedure:

1. Press and hold the Unlock button on the transmitter.
2. Continue to hold the Unlock button, wait at least 4 but no longer than 10 seconds, then press the Lock button.
3. Release both buttons.

**Enable/Disable Lamp Flash:**

The Lamp Flash can be enabled or disabled by performing the following procedure:

1. Press and hold the Lock button on the transmitter.
2. Continue to hold the Lock button, wait at least 4 but no longer than 10 seconds, then press the Trunk button.
3. Release both buttons.

**To lock the doors:**

Press and release the LOCK button to lock all doors.

**Enable/Disable Horn chirp:**

The horn chirp feature can be enabled or disabled by performing the following procedure:

1. Press and hold the Lock button on the transmitter.

2. Continue to hold the Lock button, wait at least 4 but no longer than 10 seconds, then press the Unlock button.
3. Release both buttons.

**NOTE:** To enable/disable the Lamp Flash, see procedure described above.

**To unlock the trunk:**

Press and hold the trunk button on the transmitter to unlatch the trunk.

**Enable/Disable Trunk Press and Hold:**

The transmitter can be programmed to unlatch the trunk immediately upon activation of the Trunk button (without pressing and holding) by performing the following procedure:

1. Press and hold the Unlock button on the transmitter.
2. Continue to hold the Unlock button, wait at least 4 but no longer than 10 seconds, then press the Trunk button.
3. Release both buttons.

### Panic Alarm

The panic alarm unlocks the driver's door, turns on the interior lights, flashes the headlights and sounds the horn for about 3 minutes or until the alarm is turned off. The vehicle can be driven while in the Panic mode.

#### To Use The Panic Alarm:

Press and hold the Panic button to activate the alarm. Press and hold the Panic button or unlock the door with the key to deactivate the alarm. The alarm will also shut itself off after 3 minutes or when vehicle speed reaches 15 m.p.h. (24 km/h).

#### To Program Additional Transmitters:

Up to 4 transmitters can be programmed to your vehicle. To program a transmitter, perform the following procedure.

On vehicles equipped with an EVIC (Electronic Vehicle Information Center), these functions can be selected at the EVIC using the Customer Programmable Features. Refer to EVIC— Customer Programmable Features for details.

**NOTE:** When entering program mode, all previously programmed transmitters are erased from memory, therefore you must reprogram ALL the transmitters when you enter program mode.

1. With the vehicle in Park, turn the Ignition switch to the ON position.

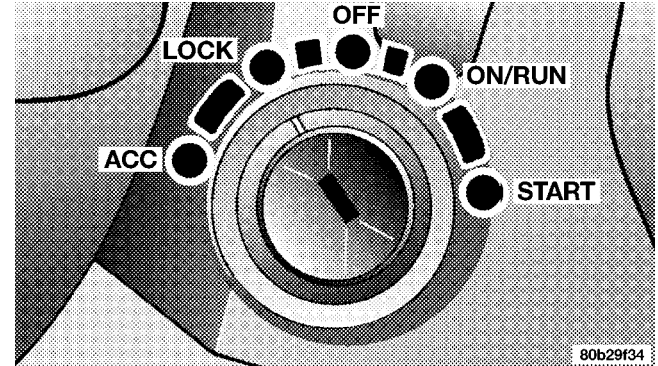

2. Using a previously programmed transmitter, press the Unlock button on the transmitter. Continue to hold the Unlock button, wait at least 4 but no longer than 10 seconds, then press and hold the Panic button for at least

one second. Release both buttons simultaneously. You will hear a chime to signal that you can proceed with programming the new transmitter.

3. One by one with each transmitter (includes previously programmed as well as the new transmitter), press and release the lock and unlock buttons simultaneously. You will hear a chime after each transmitter has been successfully programmed. You will have 30 seconds to finish programming all new transmitters. A chime will sound when the 30 seconds is over or the ignition switch is turned to the Lock position.

### Transmitter Linked to Memory Programming

Your remote transmitters can be programmed to return the driver's seat, mirrors, and radio presets to the saved position when the Unlock button is pressed and released.

**NOTE:** When newly purchased (or replacement) transmitters are programmed into the vehicle, the first transmitter programmed will be associated with memory setting 1, and the second transmitter programmed will be associated with memory setting 2. Additional transmitters will not be associated with a memory setting.

To program your transmitters, perform the following:

1. Insert key into the ignition and turn the key to the On/Run position.
2. Adjust the seat and side view mirrors to the desired position. Program the radio preset buttons to the desired stations.
3. Press and release the Set (S) button on the memory seat switch, then press and release memory button 1 or 2.
4. Press and release the Lock button on the transmitter. This will link the transmitter to the desired memory setting.
5. Do not press any buttons for 10 seconds.

**NOTE:** Your transmitters may be unlinked from your memory settings by following the procedure above except pressing the Unlock button on the transmitter in step 4 above. On vehicles equipped with an EVIC (Electronic Vehicle Information Center), these functions can be selected at the EVIC using the Customer Programmable Features. Refer to EVIC-Customer Programmable Features for details. When newly purchased (or replacement)

## 22 THINGS TO KNOW BEFORE STARTING YOUR VEHICLE

transmitters are programmed into the vehicle, the first transmitter trained will be associated with memory setting 1, and the second transmitter trained will be associated with memory setting 2. Additional transmitters will not be associated with a memory setting.

### General Information

This transmitter complies with FCC rules part 15 and with RS-210 of Industry Canada. Operation is subject to the following two conditions: (1) this device may not cause harmful interference and (2) This device must accept any interference that may be received, including interference that may cause undesired operation.

If your Remote Lock Control fails to operate from a normal distance, check for these two conditions:

1. Weak batteries in transmitter. The expected life of batteries is from one to two years.
2. Closeness to a radio transmitter such as a radio station tower, airport transmitter, and some mobile or CB radios.

### Transmitter Battery Service

The recommended replacement battery is DL 2016 or its equivalent.

- Pry the transmitter halves apart with a dime or similar object. Make sure not to damage the rubber gasket during removal.

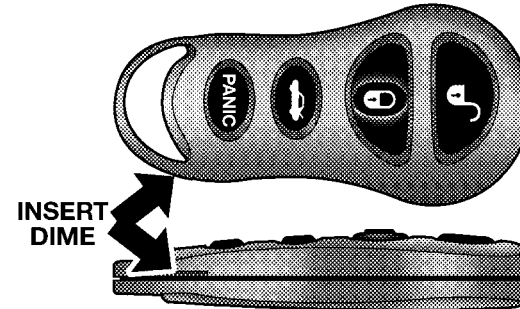

80b31f53

- Remove and replace the batteries. Avoid touching the new batteries with your fingers. Skin oils may cause battery deterioration. If you touch a battery, clean it with rubbing alcohol.

- Reassemble the transmitter case. Snap the halves together and test transmitter operation.

### SECURITY ALARM SYSTEM

The system monitors the doors, trunk key cylinder, and ignition for unauthorized operation.

If something triggers the alarm, the system will signal for up to 18 minutes. For the first 3 minutes the horn will sound and the headlights, park and tail lights and the SET light will flash. The horn will stop and if the source of the trigger is still present, the lights will continue to flash for another 15 minutes.

**NOTE:** The engine will not start until you disarm the system.

### To set the alarm:

1. Remove the keys from the ignition switch and get out of the vehicle.
2. Lock the door using either the door key, power door lock switch, or the Keyless Entry Transmitter and close all doors.

2

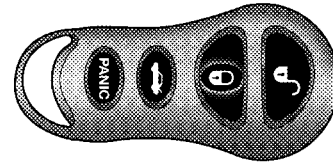

80b31f52

## 24 THINGS TO KNOW BEFORE STARTING YOUR VEHICLE

3. The SET light on the top of the instrument panel will flash rapidly for 16 seconds. This shows that the system is arming. If the light comes on but does not flash, the system is still armed, but there is a problem in the trunk circuit. After 16 seconds the SET light will continue to flash slowly. This shows that the system is fully armed.

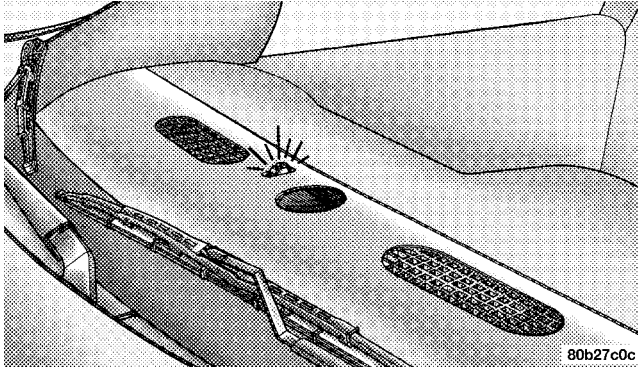

### To disarm the system:

Unlock a front door using either the key or the Keyless Entry Transmitter.

### Tamper Alert

If the horn sounds 3 times when you unlock a front door using either a key or the Keyless Entry Transmitter, the alarm had been triggered. Check the vehicle for tampering.

### Security System Manual Override

The system will not arm if you lock the doors using the manual lock control.

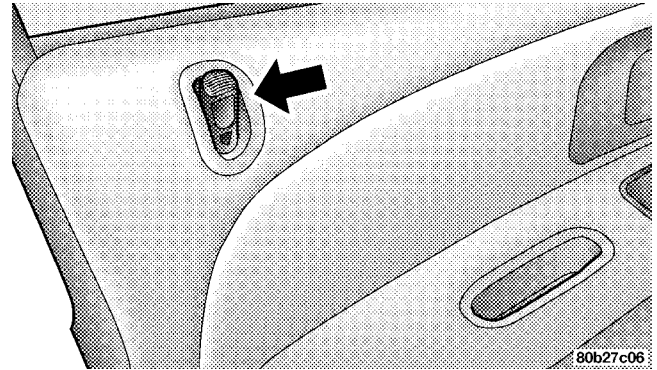



## POWER WINDOWS

Window controls on the driver's door control all door windows.

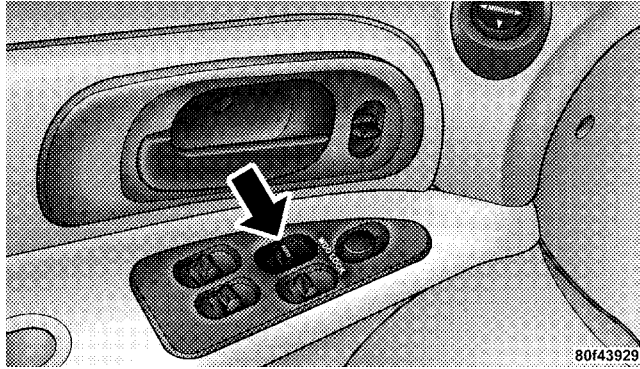

The driver's window switch has an Auto Down feature. Press the window switch past the detent, release, and the window will go down automatically. Press the switch a second time in either direction to stop the window.

To open the window part way, press the window switch to the detent and release it when you want the window to stop.

The window lock switch on the driver's door allows you to disable the window control on the other doors.

## REMOTE TRUNK LID RELEASE

You can open the trunk lid from inside the vehicle by pressing the switch on the left side of the instrument panel. The transmission must be in Park before the switch will operate.

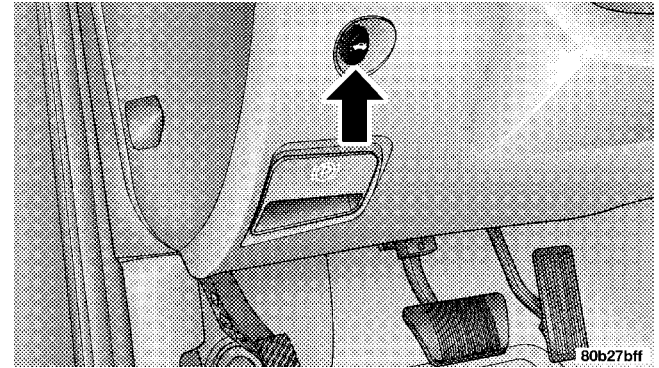

## TRUNK SAFETY WARNING

### WARNING!

Do not allow children to have access to the trunk, either by climbing into the trunk from outside, or through the inside of the vehicle. Always close the trunk lid when your vehicle is unattended. Once in the trunk, young children may not be able to escape, even if they entered through the rear seat. If trapped in the trunk, children can die from suffocation or heat stroke.

## Trunk Emergency Release

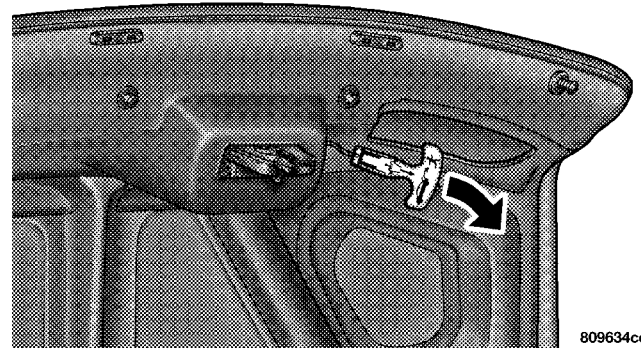

809634cd

The trunk of your vehicle is equipped with an emergency release handle. It is located on the inside of the trunk lid, near the latch, and is coated so that it glows in a darkened trunk. Pull on the handle to open the trunk.

## OCCUPANT RESTRAINTS

Some of the most important safety features in your vehicle are the restraint systems. These include the front and rear seat belts for the driver and all passengers, front airbags for both the driver and front passenger and side airbags, if equipped, for both the driver and right front passenger. If you will be carrying children too small for adult-size belts, your seat belts also can be used to hold infant and child restraint systems.

Please pay close attention to the information in this section. It tells you how to use your restraint system properly to keep you and your passengers as safe as possible.

### WARNING!

**In a collision, you and your passengers can suffer much greater injuries if you are not properly buckled up. You can strike the interior of your vehicle or other passengers, or you can be thrown out of the vehicle. Always be sure you and others in your vehicle are buckled up properly.**

2

Buckle up even though you are an excellent driver, even on short trips. Someone on the road may be a poor driver and cause a collision which includes you. This can happen far away from home or on your own street.

Research has shown that seat belts save lives. And they can reduce the seriousness of injuries in a collision. Some of the worst injuries happen when people are thrown from the vehicle. Seat belts provide protection from that, and they reduce the risk of injury caused by striking the inside of the vehicle. **Everyone** in a motor vehicle needs to be buckled up all the time.

### Lap/Shoulder Belts

All seating positions in your vehicle are equipped with Lap/Shoulder Belts.

The belt webbing retractor will lock only during very sudden stops or collisions. This feature allows the shoulder part of the belt to move freely with you under normal conditions. But in a collision, the belt will lock and reduce your risk of striking the inside of the vehicle or being thrown out.

#### WARNING!

- Wearing a seat belt incorrectly is dangerous. Seat belts are designed to go around the large bones of your body. These are the strongest parts of your body and can take the forces of a collision the best. Wearing your belt in the wrong place could make your injuries in a collision much worse. You might suffer internal injuries, or you could even slide out of part of the belt. Follow these instructions to wear your seat belt safely and to keep your passengers safe, too.
- Two people should never be belted into a single seat belt. People belted together can crash into one another in an accident, hurting one another badly. Never use a lap/shoulder belt or a lap belt for more than one person, no matter what their size.

### Lap/Shoulder Belt Operating Instructions

1. Enter the vehicle and close the door. Sit back and adjust the front seat.

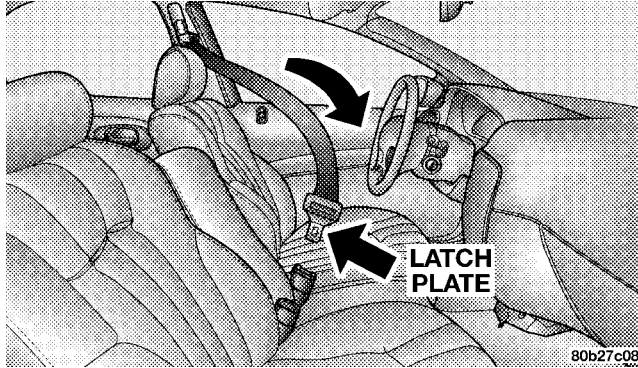

Center Console removed from following illustrations

2. The seat belt latch plate is above the back of your seat. Grasp the latch plate and pull out the belt. Slide the latch plate up the webbing as far as necessary to allow the belt go around your lap.

2

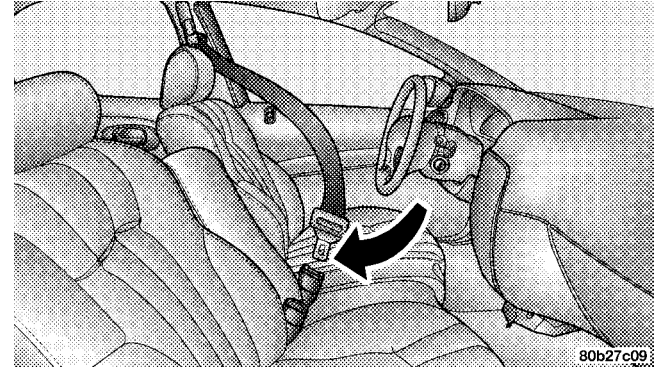

3. When the belt is long enough to fit, insert the latch plate into the buckle until you hear a "click."

**WARNING!**

- A belt that is buckled into the wrong buckle will not protect you properly. The lap portion could ride too high on your body, possibly causing internal injuries. Always buckle your belt into the buckle nearest you.
- A belt that is too loose will not protect you as well. In a sudden stop you could move too far forward, increasing the possibility of injury. Wear your seat belt snugly.
- A belt that is worn under your arm is very dangerous. Your body could strike the inside surfaces of the vehicle in a collision, increasing head and neck injury. A belt worn under the arm can cause internal injuries. Ribs aren't as strong as shoulder bones. Wear the belt over your shoulder so that your strongest bones will take the force in a collision.
- A shoulder belt placed behind you will not protect you from injury during a collision. You are more likely to hit your head in a collision if you do not wear your shoulder belt. The lap and shoulder belt are meant to be used together.

4. Position the lap belt across your thighs, below your abdomen. To remove slack in the lap belt portion, pull up a bit on the shoulder belt, as shown. To loosen the lap belt if it is too tight, tilt the latch plate and pull on the lap belt. A snug belt reduces the risk of sliding under the belt in a collision.

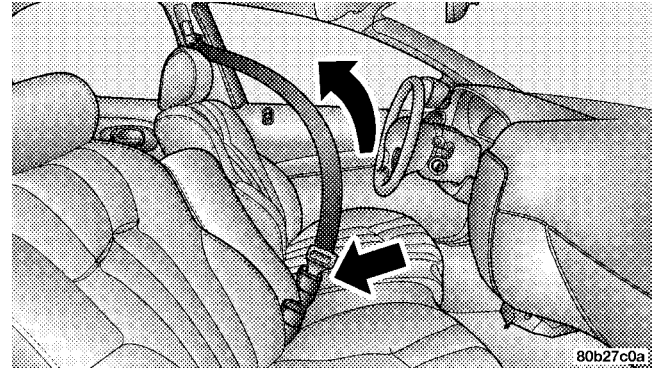

**WARNING!**

- A lap belt worn too high can increase the risk of internal injury in a collision. The belt forces won't be at the strong hip and pelvic bones, but across your abdomen. Always wear the lap belt as low as possible and keep it snug.
- A twisted belt can't do its job as well. In a collision it could even cut into you. Be sure the belt is straight. If you can't straighten a belt in your vehicle, take it to your dealer and have it fixed.

**WARNING!**

A frayed or torn belt could rip apart in a collision and leave you with no protection. Inspect the belt system periodically, checking for cuts, frays, or loose parts. Damaged parts must be replaced immediately. Do not disassemble or modify the system. Seat belt assemblies must be replaced after an accident if they have been damaged (bent retractor, torn webbing, etc.).

5. Position the shoulder belt on your chest so that it is comfortable and not resting on your neck. The retractor will withdraw any slack in the belt.
6. To release the belt, push the red button marked PRESS on the buckle. The belt will automatically retract to its stowed position. If necessary, slide the latch plate down the webbing to allow it to retract fully.

### Adjustable Upper Shoulder Belt Anchorage

In the front seats, the shoulder belt can be adjusted upward or downward to position the belt away from your neck. Push the lever above the webbing upward to release the anchorage, and then move it up or down to the position that serves you best.

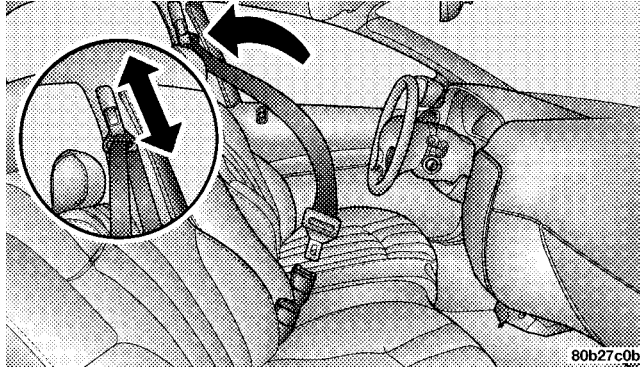

As a guide, if you are shorter than average, you will prefer a lower position, and if you are taller than average, you'll prefer a higher position. When you release the anchorage, try to move it up or down to make sure that it is locked in position.

In the rear seat, move toward the center of the seat to position the belt away from your neck.

### Seat Belts and Pregnant Women

We recommend that pregnant women use the seat belts throughout their pregnancy. Keeping the mother safe is the best way to keep the baby safe.

Pregnant women should wear the lap part of the belt across the thighs and as snug across the hips as possible. Keep the belt low so that it does not come across the abdomen. That way the strong bones of the hips will take the force if there is a collision.

### Seat Belt Extender

If a seat belt is too short, even when fully extended and when the adjustable upper shoulder belt anchorage (if so equipped) is in its lowest position, your dealer can provide you with a seat belt extender. This extender should be used only if the existing belt is not long enough. When it is not required, remove the extender and store it.



**WARNING!**

Using a seat belt extender when not needed can increase the risk of injury in a collision. Only use the extender when the lap belt is not long enough when it is worn low and snug, and in the recommended seating positions. Remove and store the extender when not needed.

**Driver and Right Front Passenger Supplemental Restraint System (SRS) - Airbag**

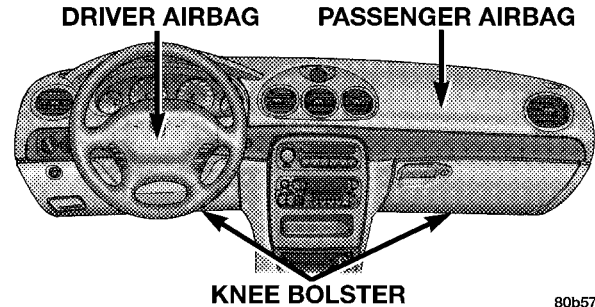

2

80b57435

This vehicle has front airbags for both the driver and front passenger as a supplement to the seat belt restraint systems. The driver's front airbag is mounted in the center of the steering wheel. The passenger's front airbag is mounted in the instrument panel, above the glove compartment. The words SRS AIRBAG are embossed on the airbag covers.

## 34 THINGS TO KNOW BEFORE STARTING YOUR VEHICLE

If the vehicle is equipped with side airbags, they are located inside the driver and front passenger seats, and their covers are also labeled SRS AIRBAG.

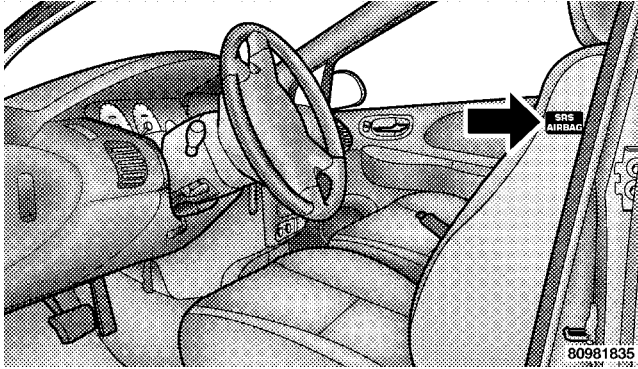

### WARNING!

- Do not put anything on or around the front airbag covers or attempt to manually open them. You may damage the airbags and you could be injured because the airbags are not there to protect you. These protective covers are designed to open only when the airbags are inflated.
- If your vehicle is equipped with side airbags, do not use accessory seat covers or place objects between you and the side airbags; the performance could be adversely affected and/or objects could be pushed into you, causing serious injury.
- If your vehicle is equipped with side airbags, do not attach cup holders or any other objects on or around the door. The inflating side airbag could drive the objects into occupants, causing serious injury.

Airbags inflate in moderate to high speed impacts. Along with the seat belts, front airbags work with the instrument panel knee bolsters to provide improved protection for the driver and front passenger. Side airbags also work with seat belts to improve occupant protection.

The seat belts are designed to protect you in many types of collisions. The front airbags deploy only in moderate to severe frontal collisions. In certain types of collisions, both the front and side airbags may be triggered. But even in collisions where the airbags work, you need the seat belts to keep you in the right position for the airbags to protect you properly.

**Here are some simple steps you can take to minimize the risk of harm from a deploying airbag.**

1. Children 12 years old and under should always ride buckled up in the rear seat.

Infants in rear-facing child restraints (designed for children up to 20 lbs. [9kg.] and at least one year old) should **NEVER** ride in the front seat of a vehicle with a passenger front airbag. An airbag deployment could cause serious injury or death to an infant in that position.

Children that are not big enough to properly wear the vehicle seat belt (see section on “Child Restraint”) should be secured in the rear seat in child restraints or belt-positioning booster seats appropriate for the size and age of the child.

Older children who do not use child restraints or belt-positioning booster seats should ride properly buckled up in the rear seat. Never allow children to slide the shoulder belt behind them or under their arm.

If a child from 1 to 12 years old must ride in the front passenger seat because the vehicle is crowded, move the seat as far back as possible, and use the proper child restraint. See the section on “Child Restraint”.

You should read the instructions provided with your child restraint to make sure that you are using it properly.

2. All occupants should wear their lap and shoulder belts properly.

3. The driver and front passenger seats should be moved back as far as practical to allow the front airbags room to inflate.

4. If your vehicle has side airbags, do not lean against the door, airbags will inflate forcefully into the space between you and the door.

**WARNING!**

- **Relying on the airbags alone could lead to more severe injuries in a collision. The airbags work with your seat belt to restrain you properly. In some collisions the airbags won't deploy at all. Always wear your seat belts even though you have airbags.**
- **Being too close to the steering wheel or instrument panel during airbag deployment could cause serious injury.**
- **Airbags need room to inflate. Sit back, comfortably extending your arms to reach the steering wheel or instrument panel.**
- **If the vehicle has side airbags, they also need room to inflate. Do not lean against the door. Sit upright in the center of the seat.**

**Airbag System Components**

The airbag system consists of the following:

- ACM (Airbag Control Module)
- AIRBAG Readiness Light
- Driver and Passenger Front Airbags
- Optional Driver and Passenger Side Airbags.
- Steering Wheel and Column
- Instrument Panel
- Interconnecting Wiring
- Crash Sensors
- Knee Impact Bolsters

The side airbag system, on vehicles so equipped, consists of the following:

- AIRBAG Readiness Light
- Side Airbag in the Driver's Seat
- Side Airbag in the Passenger's Seat

- ACM (Airbag Control Module)
- SIACM (Side Impact Airbag Control Module)
- Interconnecting Wiring

### How the Frontal Airbag System Works

- The front airbag control module determines if a frontal collision is severe enough to require the airbags to inflate.
- The airbag control module will not detect side, roll over, or rear collisions.
- The airbag control module also monitors the readiness of the electronic parts of the system whenever the ignition switch is in the START or RUN positions. These include all of the items listed above except the knee bolsters, the instrument panel, and the steering wheel and column. If the key is in the OFF position, in the ACC position, or not in the ignition, the airbags are not on and will not inflate.

#### AIR BAG

- The airbag control module also turns on the AIRBAG light in the instrument panel for 6 to 8 seconds when the ignition is first turned on, then turns the light off. If it detects a malfunction in any part of the system, it turns on the light either momentarily or continuously.

#### WARNING!

**Ignoring the AIRBAG light in your instrument panel could mean you won't have the airbags to protect you in a collision. If the light does not come on, stays on after you start the vehicle, or if it comes on as you drive, have the airbag system checked right away.**

- When the airbag control module detects an impact requiring the front airbags, it signals the inflator units. A large quantity of nontoxic gas is generated to inflate the airbags. The airbag covers separate and fold out of the way as the airbags inflate to their full size. The airbags fully inflate in about 60 milliseconds. This is only about half of the time it takes you to blink your eyes. The airbags then quickly deflate while helping to restrain the driver and right front passenger. The driver's front airbag gas is vented towards the instrument panel. The passenger's front airbag gas is vented through vent holes in the sides of the airbag. In this way the airbags do not interfere with your control of the vehicle.
- The Knee Impact Bolsters help protect the knees and position you for the best interaction with the airbags.

### If A Deployment Occurs

The airbag system is designed to deploy when the airbag control module detects a moderate-to-severe frontal collision, to help restrain the driver and right front passenger, and then to immediately deflate.

**NOTE:** A frontal collision that is not severe enough to need airbag protection will not activate the system. This does not mean something is wrong with the airbag system.

If you do have a collision which deploys the airbags, any or all of the following may occur:

- The nylon airbag material may sometimes cause abrasions and/or skin reddening to the driver and right front passenger as the airbags deploy and unfold. The abrasions are similar to friction rope burns or those you might get sliding along a carpet or gymnasium floor. They are not caused by contact with chemicals. They are not permanent and normally heal quickly. However, if you haven't healed significantly within a few days, or if you have any blistering, see your doctor immediately.

- As the airbags deflate you may see some smoke-like particles. The particles are a normal by-product of the process that generates the nontoxic gas used for airbag inflation. These airborne particles may irritate the skin, eyes, nose, or throat. If you have skin or eye irritation, rinse the area with cool water. For nose or throat irritation, move to fresh air. If the irritation continues, see your doctor. If these particles settle on your clothing, follow the garment manufacturer's instructions for cleaning.
- It is not advisable to drive your vehicle after the airbags have been deployed. If you are involved in another collision, the airbags will not be in place to protect you.

**WARNING!**

**Deployed airbags can't protect you in another collision. Have the airbags replaced by an authorized dealer as soon as possible.**

**How the Side Airbag System Works**

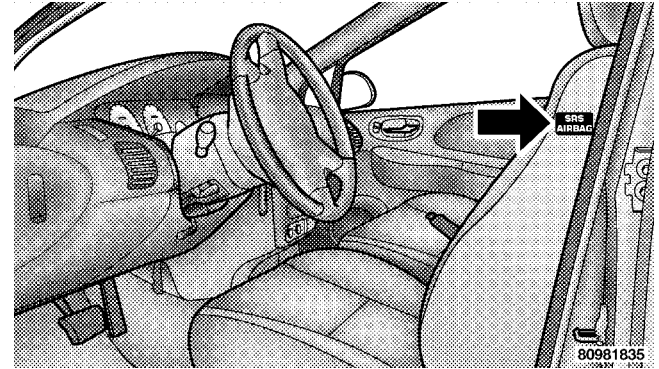

2

- The side impact airbag control module determines if a side collision is severe enough to require the airbag to inflate. The ACM will not detect rollover, front or rear impacts.
- The side impact airbag control module monitors the readiness of the electronic parts of the system whenever the ignition switch is in the "START" or "RUN" positions. These include all of the items listed above except for the AIRBAG light (which is controlled by the frontal airbag system).

#### 40 THINGS TO KNOW BEFORE STARTING YOUR VEHICLE

- In moderate to severe side collisions, the side airbag inflator on the crash side of the vehicle is triggered, releasing a quantity of nontoxic gas. The inflating side airbag exits through the seat seam into the space between the occupant and the door. The side airbag moves at a very high speed and with such a high force, that it could injure you if you are not seated properly, or if items are positioned in the area where the side airbag inflates. This especially applies to children.

#### Maintaining Your Airbag System

##### **WARNING!**

- **Modifications to any part of the airbag system could cause it to fail when you need it. You could be injured because the airbag is not there to protect you. Do not modify the components or wiring, including adding any kind of badges or stickers to the airbag covers. Do not modify the front bumper or vehicle body structure.**
- **You need proper knee impact protection in a collision. Do not mount or locate any aftermarket equipment on or behind the knee impact bolsters.**
- **It is dangerous to try to repair any part of the airbag system yourself. Be sure to tell anyone who works on your vehicle that it has airbags.**



## Airbag Light

### AIR BAG

You will want to have the airbags ready for your protection in an impact. While the airbag system is designed to be maintenance free, if any of the following occurs, have an authorized dealer service the system immediately.

- The AIRBAG light does not come on or flickers during the 6 to 8 seconds when the ignition switch is first turned on.
- The light remains on or flickers after the 6 to 8 second interval.
- The light flickers or comes on and remains on while driving.

## Child Restraint

Everyone in your vehicle needs to be buckled up all the time— babies and children too. Every state in the United States and all Canadian provinces require that small children ride in proper restraint systems. This is the law, and you can be prosecuted for ignoring it.

Children 12 years and under should ride properly buckled up in a rear seat. According to crash statistics, children are safer when properly restrained in the rear seat rather than the front.

### WARNING!

**In a collision, an unrestrained child, even a tiny baby, can become a missile inside the vehicle. The force required to hold even an infant on your lap could become so great that you could not hold the child, no matter how strong you are. The child and others could be badly injured. Any child riding in your vehicle should be in a proper restraint for the child's size.**

There are different sizes and types of restraints for children from newborn size to the child almost large enough for an adult safety belt. Always check the child seat owner's manual to ensure you have the right seat for your child. Use the restraint that is correct for your child:

### Infants and Child Restraints

- Safety experts recommend that children ride rearward-facing in the vehicle until they are at least one year old and weigh at least 20 lbs (9 kg). Two types of child restraints can be used rearward-facing: infant carriers and “convertible” child seats.
- The infant carrier is only used rearward-facing in the vehicle. It is recommended for children who weigh up to about 20 lbs (9 kg). “Convertible” child seats can be used either rearward-facing or forward-facing in the vehicle. Convertible child seats often have a higher weight limit in the rearward-facing direction than infant carriers do, so they can be used rearward-facing by children who weigh more than 20 lbs (9 kg) but are less than one year old. Both types of child restraints are held in the vehicle by the lap/shoulder belt or the LATCH anchorage system. (See the LATCH — Child Seat Anchorage System section for greater explanation.)
- Rearward-facing child seats must **NEVER** be used in the front seat of a vehicle with a front passenger airbag. An airbag deployment could cause severe injury or death to infants in this position.

#### WARNING!

- **A rearward facing infant restraint should only be used in a rear seat. A rearward facing infant restraint in the front seat may be struck by a deploying passenger airbag which may cause severe or fatal injury to the infant.**
- **Improper installation can lead to failure of an infant or child restraint. It could come loose in a collision. The child could be badly injured or killed. Follow the manufacturer’s directions exactly when installing an infant or child restraint.**

Here are some tips on getting the most out of your child restraint:

- Before buying any restraint system, make sure that it has a label certifying that it meets all applicable Safety Standards. We also recommend that you try a child restraint in the vehicle seats where you will use it before you buy it.
- The restraint must be appropriate for your child's weight and height. Check the label on the restraint for weight and height limits.
- Carefully follow the instructions that come with the restraint. If you install the restraint improperly, it may not work when you need it.
- Buckle the child into the seat according to the seat manufacturer's directions.
- When your child restraint is not in use, secure it in the vehicle with the seat belt or remove it from the vehicle. Do not leave it loose in the vehicle. In a sudden stop or collision, it could strike the occupants or seat backs and cause serious personal injury.

**NOTE:** For additional information, refer to [www.seatcheck.org](http://www.seatcheck.org) or call 1-866-SEATCHECK.

### Older Children and Child Restraints

Children who weigh more than 20 lbs (9 kg) and who are older than one year can ride forward-facing in the vehicle. Forward-facing child seats and convertible child seats used in the forward-facing direction are for children who weigh 20 to 40 lbs (9 to 18 kg) and who are older than one year. These child seats are also held in the vehicle by the lap/shoulder belt or the LATCH anchorage system. (See the LATCH — Child Seat Anchorage System Section.)

The belt-positioning booster seat is for children weighing more than 40 lbs (18 kg), but who are still too small to fit the vehicle's seat belts properly. If the child cannot sit with knees bent over the vehicle's seat cushion while the child's back is against the seat back, they should use a belt-positioning booster seat. The child and belt-positioning booster seat are held in the vehicle by the lap/shoulder belt.

### Children Too Large For Booster Seats

Children who are large enough to wear the shoulder belt comfortably, and whose legs are long enough to bend over the front of the seat when their back is against the seatback, should use the lap/shoulder belt in the rear seat.

- Make sure that the child is upright in the seat.
- The lap portion should be low on the hips and as snug as possible.
- Check belt fit periodically. A child's squirming or slouching can move the belt out of position.
- If the shoulder belt contacts the face or neck, move the child closer to the center of the vehicle. Never allow a child to put the shoulder belt behind their back or under their arm.

### LATCH – Child Seat Anchorage System (Lower Anchors and Tether for CHildren)

Your vehicle's rear seat is equipped with the child restraint anchorage system called LATCH. The LATCH system provides for the installation of the child restraints without using the vehicle's seat belts, instead securing the child restraint using lower anchorages and upper tether straps from the child restraint to the vehicle structure.

LATCH-compatible child restraint systems are now available. However, because the lower anchorages are to be introduced over a period of years, child restraint systems having attachments for those anchorages will continue to also have features for installation using the vehicle's seat belts. Child restraints having tether straps and hooks for connection to the top tether anchorages have been available for some time. For some older child restraints, many child restraint manufacturers offer add-on tether strap kits or retro-fit kits. You are urged to take advantage of all the available attachments provided with your child restraint in any vehicle.



All three rear seating positions have lower anchorages that are capable of accommodating LATCH-compatible child seats. These are round bars, located at the lower area of the seat back. Install your child seat as per child seat manufacturer recommendations.

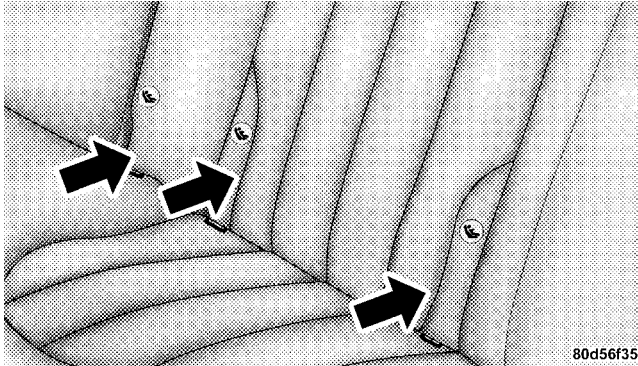

### Installing the LATCH-Compatible Child Restraint System

We urge that you carefully follow the directions of the manufacturer when installing your child restraint. Not all child restraint systems will be installed as described here.

Again, carefully follow the installation instructions that were provided with the child restraint system.

The rear seat lower anchorages are round bars, located at the rear of the seat cushion where it meets the seat back, and are just visible when you lean into the rear seat to install the child restraint. You will easily feel them if you run your finger along the intersection of the seatback and seat cushion surfaces.

2



In addition, there are tether strap anchorages behind each rear seating position located in the panel between the rear seat back and the rear window. These tether strap anchorages are under a hinged plastic cover with this symbol on it.

Many, but not all restraint systems will be equipped with separate straps on each side, with each having a hook or connector for attachment to the lower anchorage and a means of adjusting the tension in the strap. Forward-facing toddler restraints and some rear-facing infant restraints will also be equipped with a tether strap, a hook for attachment to the tether strap anchorage and a means of adjusting the tension of the strap.

You will first loosen the adjusters on the lower straps and on the tether strap so that you can more easily attach the hooks or connectors over the top of the anchorage bars, pushing aside the seat cover material. Then lift the tether anchorage cover directly behind the seat where you are placing the child restraint and attach the tether strap to the anchorage, being careful to route the tether strap to provide the most direct path between the anchor and the child restraint. If your vehicle is equipped with adjustable rear head restraints, raise the head restraint and, where possible, route the tether strap under the head restraint and between the two posts. If not possible, lower the head restraint and route the tether strap around the outboard side of the head restraint. Finally, tighten all three straps as you push the child restraint rearward and downward into the seat, removing slack in the straps according to the child restraint manufacturer's instructions.

**WARNING!**

**Improper installation of a child restraint to the LATCH anchorages can lead to failure of an infant or child restraint. The child could be badly injured or killed. Follow the manufacturer's directions exactly when installing an infant or child restraint.**

**Installing Child Restraints Using the Vehicle Seat Belts**

The passenger seat belts are equipped with cinching latch plates which are designed to keep the lap portion of the lap/shoulder belt tight around the child restraint so that it is not necessary to use a locking clip. Pull up on the shoulder portion of the lap/shoulder belt to tighten the belt. The cinching latch plate will keep the belt tight, however, any seat belt system will loosen with time, so check the belt occasionally and pull it tight if necessary.

In the rear seat, you may have trouble tightening the lap/shoulder belt on the child restraint because the buckle or latch plate is too close to the belt path opening on the restraint. Disconnect the latch plate from the

buckle and twist the short buckle-end belt several times to shorten it. Insert the latch plate into the buckle with the release button facing out.

If the belt still can't be tightened, or if by pulling and pushing on the restraint loosens the belt, you may need to do something more. Disconnect the latch plate from the buckle, turn the buckle around, and insert the latch plate into the buckle again. If you still can't make the child restraint secure, try a different seating position.

To attach a child restraint tether strap:

1. Lift the cover over the anchor directly behind the seat where you are placing the child restraint.

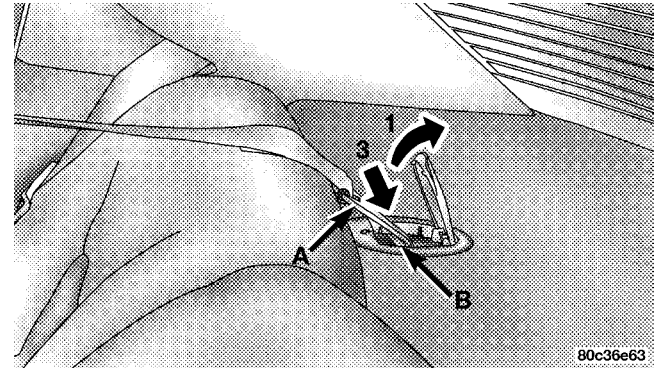

2. Route the tether strap to provide the most direct path for the strap between the anchor and the child seat. If your vehicle is equipped with adjustable rear head restraints, raise the head restraint and route the tether strap under the head restraint and between the two posts. If not possible, lower the head restraint and pass the tether strap around the outboard side of the head restraint.

3. Attach the tether strap hook (A) of the child restraint to the anchor (B) and remove slack in the tether strap according to the child restraint manufacturer's instructions.

**WARNING!**

**An incorrectly anchored tether strap could lead to increased head motion and possible injury to the child. Use only the anchor positions directly behind the child seat to secure a child restraint top tether strap.**

**Transporting Pets**

Airbags deploying in the front seat could harm your pet. An unrestrained pet will be thrown about and possibly injured, or injure a passenger during panic braking or in a collision.

Pets should be restrained in the rear seat in pet harnesses or pet carriers that are secured by seat belts.

**ENGINE BREAK-IN RECOMMENDATIONS**

The engine in your new vehicle does not require a long break-in period.

Drive moderately during the first 300 miles (500 km). After the initial 60 miles (100 km), speeds up to 50 or 55 mph (80 or 90 km/h) are desirable.

While cruising, brief full-throttle acceleration, within the limits of local traffic laws, contributes to a good break-in.

Wide open throttle acceleration in low gear can be detrimental and should be avoided.

The crankcase oil installed in the engine at the factory is a high quality energy conserving type lubricant. Oil changes should be consistent with expected climate conditions under which vehicle operations will occur. The recommended viscosity and quality grades are in Section 7 of this manual.

Do not use non-detergent or straight mineral oils.

A new engine may consume some oil during its first few thousand miles of operation. This is a normal part of the break-in and not an indication of a problem.



**SAFETY TIPS****Exhaust Gas****WARNING!**

Exhaust gases can injure or kill. They contain carbon monoxide (CO) which is colorless and odorless. Breathing it can make you unconscious and can eventually poison you. To avoid breathing (CO) follow the safety tips below.

- Do not run the engine in a closed garage or in confined areas any longer than needed to move your vehicle in or out of the area.
- If it is necessary to sit in a parked vehicle with the engine running, adjust your heating or cooling controls to force outside air into the vehicle. Set the blower at high speed.
- To avoid drawing exhaust gases into the vehicle, close the trunk while driving. However, if for some reason it

must remain open, close all windows. Adjust the heating or cooling system to force outside air into the vehicle. Set the blower at high speed.

**Safety Checks You Should Make Inside the Vehicle****Seat Belts**

Inspect the belt system periodically, checking for cuts, frays and loose parts. Damaged parts must be replaced immediately. Do not disassemble or modify the system.

Safety belt assemblies must be replaced after an accident if they have been damaged (bent retractor, torn webbing, etc.). If there is any question regarding belt or retractor condition, replace the belt.

**Airbag Light****AIR BAG**

The light should come on and remain on for 6 to 8 seconds as a bulb check when the ignition switch is first turned ON. If the bulb is not lit during starting, have it replaced. If the light stays on or comes on while driving, have the system checked by an authorized dealer.

### **Defrosters**

Check operation by selecting the defrost mode and place the blower control on high speed. You should be able to feel the air directed against the windshield.

### **Periodic Safety Checks You Should Make Outside the Vehicle**

#### **Tires**

Examine tires for excessive tread wear or uneven wear patterns. Check for stones, nails, glass, or other objects lodged in the tread. Inspect for tread cuts or sidewall cracks. Check wheel nuts for tightness and tires (including spare) for proper pressure.

### **Lights**

Have someone observe the operation of exterior lights while you work the controls. Check turn signal and high beam indicator lights on the instrument panel.

### **Fluid Leaks**

Check area under vehicle after overnight parking for brake fluid, fuel, water, oil, or other fluid leaks. Also, if gasoline fumes are present, the cause should be corrected immediately.

# UNDERSTANDING THE FEATURES OF YOUR VEHICLE

## CONTENTS

■ Cup Holders . . . . .	.55	■ Seats . . . . .	.59
□ Front Seat Cupholders (Concorde Limited Vehicles Only) . . . . .	.55	□ Power Seats . . . . .	.59
□ Rear Seat Cupholders . . . . .	.55	□ Power Reclining Seats . . . . .	.59
■ Coat Hook . . . . .	.55	□ Driver's Seat Glide –To – Exit Feature . . . . .	.60
■ Mirrors . . . . .	.56	□ Lumbar Support . . . . .	.61
□ Adjusting The Inside Day/Night Mirror . . . . .	.56	□ Heated Seats— If Equipped . . . . .	.61
□ Automatic Dimming Mirror Feature . . . . .	.56	□ Memory Feature . . . . .	.61
□ Heated Remote Control Mirrors — If Equipped . . . . .	.56	□ Programming The Remote Keyless Transmitter For The Memory Feature . . . . .	.62
□ Electric Remote Control Mirrors . . . . .	.57	□ Head Restraints . . . . .	.63
□ Mirror Adjustment . . . . .	.57	■ To Open And Close The Hood . . . . .	.64
		■ Interior Lights . . . . .	.65

## 52 UNDERSTANDING THE FEATURES OF YOUR VEHICLE

□ To Turn The Interior Lights On . . . . .	.65	□ Passing Light . . . . .	.69
□ Battery Saver Feature—Interior Lights . . . . .	.65	□ Windshield Wipers And Washers . . . . .	.69
□ Instrument Panel Lighting . . . . .	.65	□ Speed Sensitive Intermittent Wipers System . . . . .	.70
□ Front Map/Reading Lights . . . . .	.66	■ Tilt Steering Column . . . . .	.71
□ Rear Seat Reading/Courtesy Lights . . . . .	.66	■ Traction Control Switch — If Equipped . . . . .	.72
■ Exterior Lights . . . . .	.66	■ Electronic Speed Control . . . . .	.72
□ Headlights And Parking Lights . . . . .	.66	□ To Activate . . . . .	.73
□ Lights-On Reminder . . . . .	.67	□ To Set At A Desired Speed . . . . .	.73
□ Automatic Headlights . . . . .	.67	□ To Deactivate . . . . .	.73
□ Headlight Time Delay . . . . .	.67	□ To Resume Speed . . . . .	.74
□ Battery Saver Feature . . . . .	.68	□ To Vary The Speed Setting . . . . .	.74
□ Fog Lights . . . . .	.68	□ To Accelerate For Passing . . . . .	.74
□ Daytime Running Lights (Canada Only) . . . . .	.68	□ Using Speed Control On Hills . . . . .	.74
■ Multifunction Control Lever . . . . .	.68	■ Overhead Console . . . . .	.75
□ Turn Signals . . . . .	.68	□ Dome/Reading Lights . . . . .	.75
□ Headlight Dimmer Switch . . . . .	.69	■ Garage Door Opener — If Equipped . . . . .	.76

- Programming The Universal Transceiver . . . . .77
- “Rolling Code” Programming . . . . .78
- Canadian Programming/Gate Programming . . .80
- Operation . . . . .80
- Reprogramming A Single Button . . . . .80
- Security . . . . .80
- Garage Door Opener — If Equipped . . . . .81
  - Programming The Universal Transceiver . . . . .82
  - “Rolling Code” Programming . . . . .84
  - Canadian Programming/Gate Programming . . .85
  - Operation . . . . .86
  - Reprogramming a Single Universal Transceiver Button . . . . .86
  - Security . . . . .86
- Power Sun Roof — If Equipped . . . . .87
  - Wind Buffeting . . . . .88

**UNDERSTANDING THE FEATURES OF YOUR VEHICLE 53**

- Sun Roof Maintenance . . . . .88
- Electronic Vehicle Information Center (EVIC) — If Equipped . . . . .88
  - Customer Programmable Features . . . . .89
  - Compass/Temperature/Trip Computer . . . . .93
  - Trip Computer . . . . .93
- Overhead Travel Information Center — If Equipped . . . . .96
  - US/M Button . . . . .97
  - Reset Button . . . . .97
  - Global Reset . . . . .97
  - Step Button . . . . .97
  - Average Fuel Economy (AVG ECO) . . . . .97
  - Distance To Empty (DTE) . . . . .97
  - Trip Odometer (ODO) . . . . .98
  - Elapsed Time (ET) . . . . .98

**54 UNDERSTANDING THE FEATURES OF YOUR VEHICLE**

□ C/T Button . . . . .	.98	□ Manual Compass Calibration . . . . .	.98
□ Compass/Temperature Display . . . . .	.98	□ Outside Temperature . . . . .	.100
□ Automatic Compass Calibration . . . . .	.98	■ Electrical Power Outlet . . . . .	.100

## CUP HOLDERS

### Front Seat Cupholders (Concorde Limited Vehicles Only)

The cupholders are located in the forward edge of the console. Press the forward edge of the console to release the cupholders. Press the cupholder back into the console when they are no longer needed.

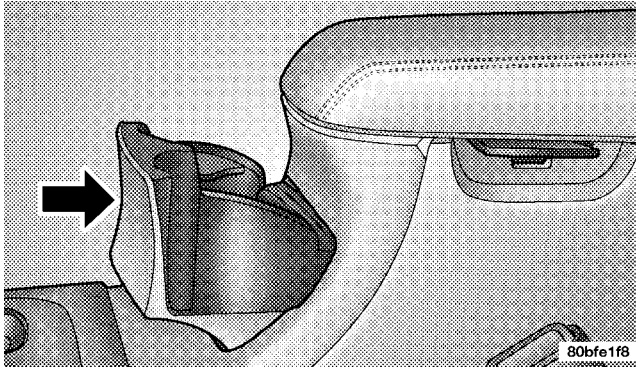

### Rear Seat Cupholders

The rear cupholders are located in the rear seat folding arm rest. Lower the arm rest and the cupholders are exposed.

### COAT HOOK

The coat hook is located next to the Rear Seat Reading/Courtesy Light Switch. Pull the hook down for access.

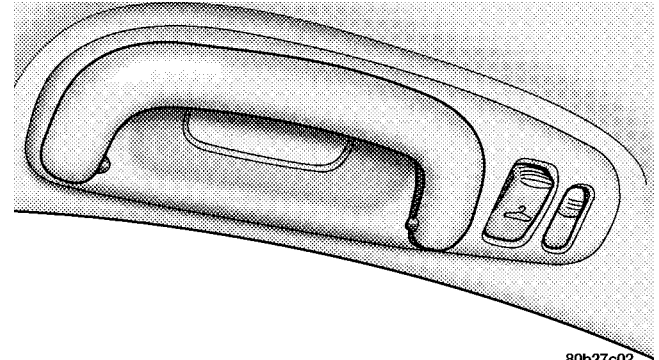

3

## MIRRORS

### Adjusting The Inside Day/Night Mirror

Adjust the mirror to center on the view through the rear window. A two point pivot system allows for horizontal and vertical mirror adjustment.

### Automatic Dimming Mirror Feature

This mirror will automatically adjust for annoying headlight glare from vehicles behind you. Push in the button on the base of the mirror to activate the dimming feature. A green light in the button will illuminate when this feature is on.

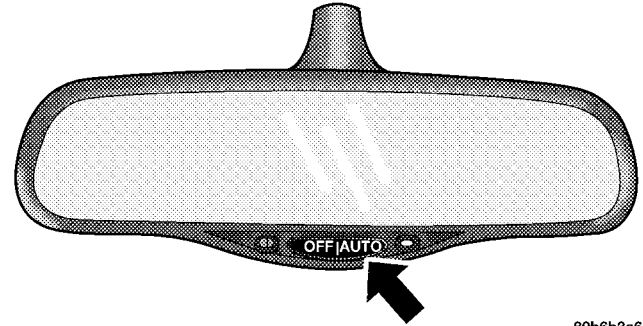

80b6b3a6

**NOTE:** This feature is most effective when left in the ON position.

### Heated Remote Control Mirrors — If Equipped



These mirrors are heated to melt frost or ice. This feature is activated whenever you turn on the rear window defrost.

**NOTE:** On vehicles equipped with the automatic dimming mirror feature, and when the dimming feature is activated, the heated remote control mirrors will be automatically dimmed as well.



### Electric Remote Control Mirrors

**NOTE:** Pre selected power mirror positions (for driver seat only) can be controlled by the Memory Seat Feature. Refer to the Seats section which follows.

Press the L or R button located on the driver's door panel for Left or Right mirror selection.

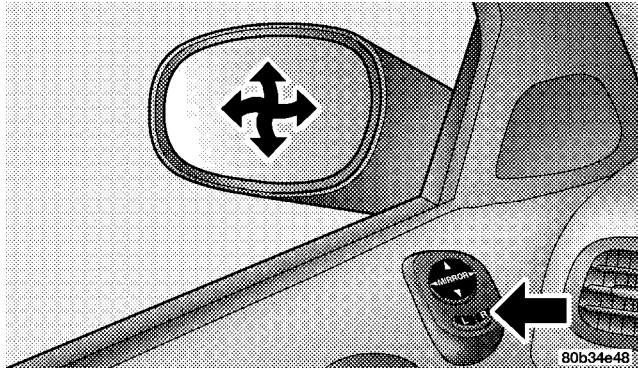

Tilt the mirror control up or down, or side to side to adjust the view in the mirror.

**NOTE:** Place the mirror switch in the neutral (center) position to prevent accidental changing of the mirror setting.

### Mirror Adjustment

#### Outside Mirror — Driver's Side

Adjust the outside mirror to center on the adjacent lane of traffic, with a slight overlap of the view obtained on the inside mirror.

#### Right Side Mirror

Adjust the convex outside mirror so you can just see the side of your vehicle. This type of mirror will give a much wider view to the rear, and especially of the lane next to your vehicle.

**WARNING!**

**Vehicles and other objects seen in the right side convex mirror will look smaller and farther away than they really are. Relying too much on your right side mirror could cause you to collide with another vehicle or other object. Use your inside mirror when judging the size or distance of a vehicle seen in this convex mirror.**

**Mirror Tilt in Reverse**

This feature will tilt the driver's exterior mirror downward to improve visibility of the rear wheel area when the vehicle is placed in reverse. Once reverse is disengaged, the driver's exterior mirror will return to its original position.

This feature can be turned on or off by performing the following procedure:

1. Press and hold the Set button.
2. Move the horizontal seat switch forward.
3. Release the Set button and the horizontal seat switch.

On vehicles equipped with an EVIC (Electronic Vehicle Information Center), these functions can be selected at the EVIC using the Customer Programmable Features for details.

**Illuminated Vanity Mirrors**

An illuminated vanity mirror is on each sun visor. To use the mirror, rotate the sun visor down and swing the mirror cover upward. The lamps turn on automatically. Closing the mirror cover turns off the lamps.

## SEATS

### Power Seats

The power seat switch is on the outboard side of the seat near the floor. Use this switch to move the driver's seat up or down, forward or rearward, or to tilt the seat. The passenger's seat will move forward or rearward.

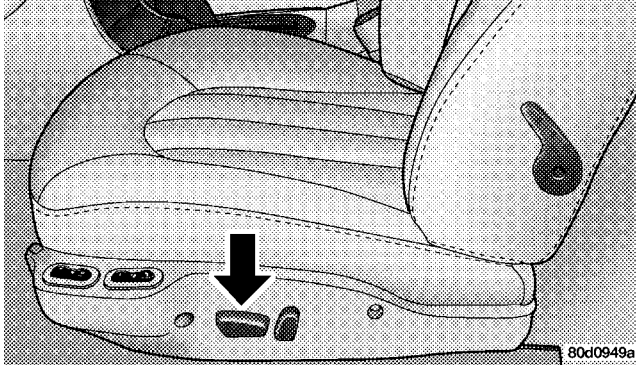

### WARNING!

Adjusting a seat while the vehicle is moving is dangerous. The sudden movement of the seat could cause you to lose control. The seat belt might not be properly adjusted and you could be injured. Adjust the seat only while the vehicle is parked.

3

### CAUTION!

Do not place any article under a power seat as it may cause damage to the seat controls.

### Power Reclining Seats

The recliner control is on the outboard side of the seat.

**WARNING!**

**Do not ride with the seatback reclined so that the shoulder belt is no longer resting against your chest. In a collision you could slide under the seat belt and be seriously or even fatally injured. Use the recliner only when the vehicle is parked.**

**Driver's Seat Glide –To – Exit Feature**

This feature provides ease of entry and exit for the driver by moving the driver's seat approximately 2-1/8 inches (55mm) rearward on exit and the same distance forward after entry, provided that the seat is not in the full rearward position.

After entry, the seat will return to its previously set position after one of the following occurs:

- The ignition switch is turned on
- The seatbelt is fastened (the seat moves when the seat belt webbing is pulled out.)

During exit, the seat will move rearward from the set position when the key is removed from the ignition providing that the seat is not in the full rearward position.

**This feature can be turned on or off by performing the following procedure.**

1. Press and hold the Set button.
2. Move the horizontal seat switch rearward.
3. Release the Set button and the horizontal seat switch.

**NOTE:** The glide feature is only available on the driver's seat.

**NOTE:** On vehicles equipped with an EVIC (Electronic Vehicle Information Center), these functions can be selected at the EVIC using the Customer Programmable Features. Refer to EVIC-Customer Programmable Features for details.

### Lumbar Support

This feature allows you to increase or decrease the amount of lumbar support. Turn the control level forward to increase and rearward to decrease the desired amount of lumbar support.

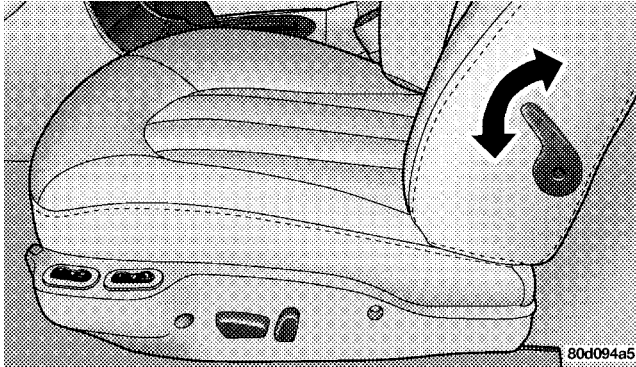

### Heated Seats— If Equipped

The front driver's and passenger seats are heated. The control for the heater is located on the outboard side of each seat. After turning on the ignition, you can choose from High, Off, or Low heat settings. An indicator on the switch shows which setting has been chosen.

Press the switch once to select a heat setting (high or low) and press the switch a second time to turn the heated seat off.

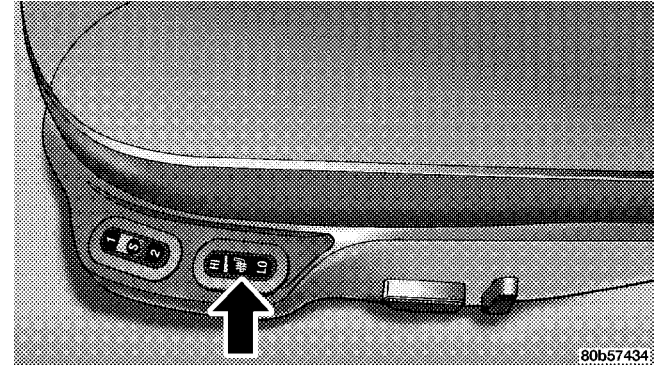

**NOTE:** Once a heat setting is selected, heat will be felt within 2 to 3 minutes.

### Memory Feature

This feature allows the driver to recall one of two pre-selected seat/outside mirror settings as well as radio station preset buttons. The radio display will show which memory position is being recalled.

The memory feature switch is located on the outboard side of the driver's seat, next to the heated seat switch.

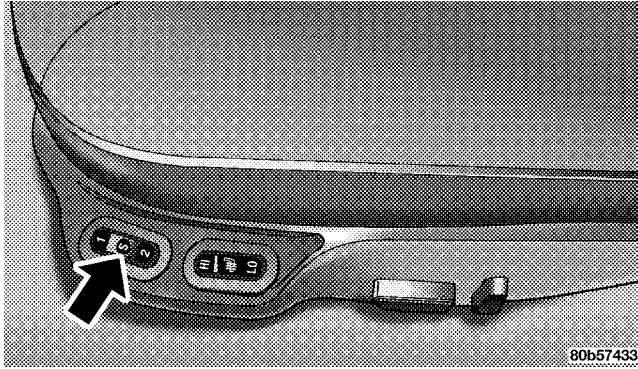

**To Set The Memory Feature:**

1. Use the seat and driver mirror switches to adjust the seat and driver mirror to the desired positions. Program the radio preset buttons to the desired stations.
2. Press and release the Set (S) button on the memory seat switch, then press either button 1 or 2 within 5 seconds. The radio display will show which memory position is being set.

3. A second memory setting can be stored in the vehicle memory. Begin with pressing 2 on the memory seat switch for driver 2. Select a second seat/radio setting, press the Set (S) button, then press button 2 within 5 seconds.

Each time the Set and a numbered button are pressed, the old memory is erased, and a new one is stored.

**NOTE:** The vehicle must be in Park to activate the Memory feature.

**Programming the Remote Keyless Transmitter for the Memory Feature**

Your remote transmitters can be programmed to return the driver's seat, mirror, and radio presets to the saved position when the Unlock button is pressed and released.

To program your transmitters, perform the following:

1. Insert the key into the ignition and turn the key to the Run position.
2. Adjust the seat and side view mirror to the desired position. Program the radio preset buttons to the desired stations.

3. Press and release the Set (S) button on the memory seat switch, then press and release button 1 or 2.
4. Press and release the Lock button on the transmitter.
5. Do not press any buttons for 10 seconds.

**NOTE:** Your transmitters may be unlinked to your memory settings by pressing the Unlock button on the transmitter in step 4 above. On vehicles equipped with an EVIC (Electronic Vehicle Information Center), these functions can be selected at the EVIC using the Customer Programmable Features. Refer to EVIC-Customer Programmable Features for details. When newly purchased (or replacement) transmitters are programmed into the vehicle, the first transmitter trained will be associated with memory setting 1, and the second transmitter trained will be associated with memory setting 2. Additional transmitters will not be associated with a memory setting.

### Head Restraints

Head restraints can reduce the risk of whiplash injury in the event of impact from the rear. Adjustable restraints should be adjusted so that the upper edge is as high as practical.

The head restraints have a locking button which must be pushed in to lower the head restraint. The restraints may be raised without pushing in the button.

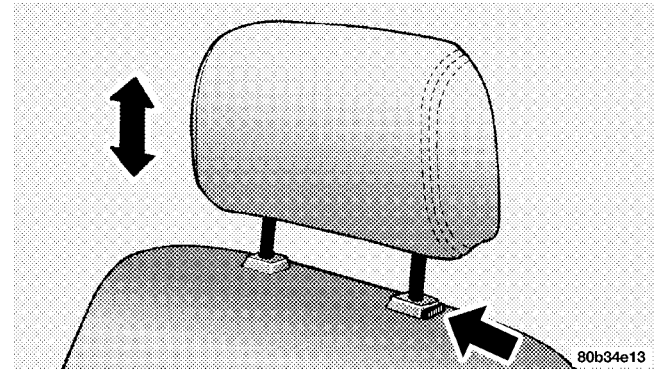

3

### TO OPEN AND CLOSE THE HOOD

To open the hood, two latches must be released. First pull up on the hood release lever located under the instrument panel.

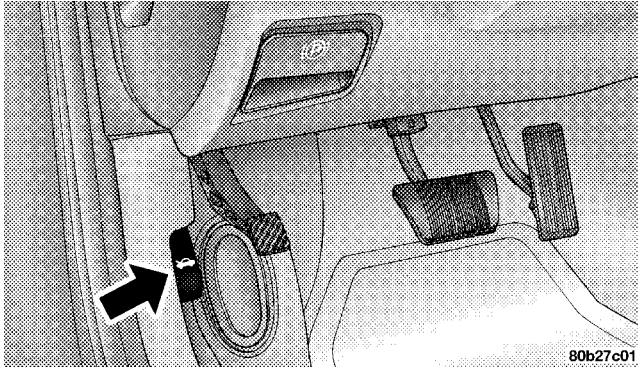

Then lift up on the catch located under the front edge of the hood, near the center.

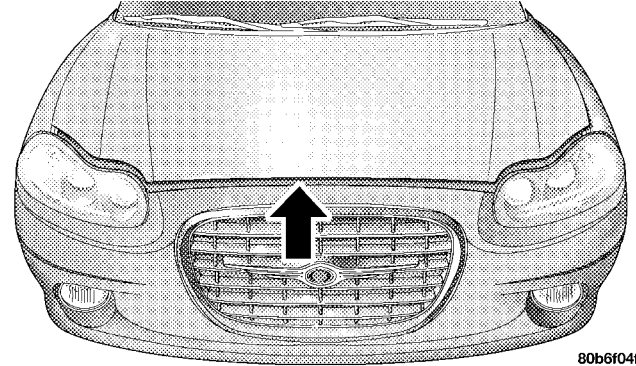

To prevent possible damage, do not slam the hood to close it. Use a firm downward push at the center front edge of the hood to ensure that both latches engage. Never drive your vehicle unless the hood is fully closed, with both latches engaged.



**WARNING!**

If the hood is not fully latched, it could fly up when the vehicle is moving and block your forward vision. You could have a collision. Be sure all hood latches are fully latched before driving.

**INTERIOR LIGHTS**

**To Turn The Interior Lights On:**

Rotate the Dimmer Control upward to the second detent. Rotate the switch downward to turn the interior lights off.

**NOTE:** The interior lights have a “fade to off” feature. When the lights are turned off, they gradually “fade” off.

**Battery Saver Feature—Interior Lights**

The interior courtesy lights come on when a door is open or left ajar. To prevent battery drain, if you leave a door open or ajar these lights will turn off after 15 minutes. After you close the door, the interior courtesy lights will again function in the normal matter.

**NOTE:** The map lights or reading lights that are manually switched on will not turn off automatically.

**Instrument Panel Lighting**

The brightness of the instrument panel lighting can be regulated by rotating the dimmer switch.

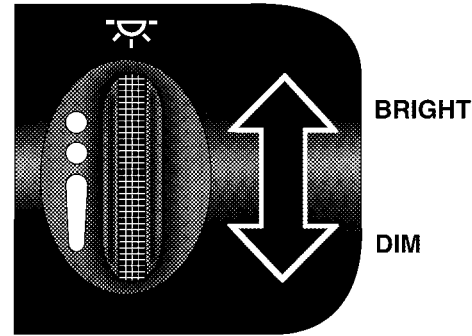

80f4396e

**Daytime Brightness Feature**

Certain instrument panel components can be illuminated at full brightness during the daytime. These are the Odometer, Transmission Range Indicator, Radio, Climate Controls, and the Overhead Travel Information Center. This can be helpful when driving with your headlights

on during the daytime such as in a parade or a funeral procession. To activate this feature, rotate the Dimmer Control upward to the first detent.

### Front Map/Reading Lights

These lights are mounted between the sun visors. Each light is turned On by pressing the lens. Press the lens a second time to turn the light Off. The lights also come on when a door is opened or the dimmer switch is turned fully upward, past the second detent.

**NOTE:** The lights will remain on until the switch is pressed a second time, so be sure they have been turned off before leaving the vehicle. They will not turn off automatically.

### Rear Seat Reading/Courtesy Lights

These lights may be individually operated by a switch next to the light. The Battery Saver feature will not turn these lights off. Be sure the lights are off before leaving the vehicle. The lights also come on when a door is opened or the dimmer switch is turned to the dome light position, past the detent.

## EXTERIOR LIGHTS

### Headlights And Parking Lights

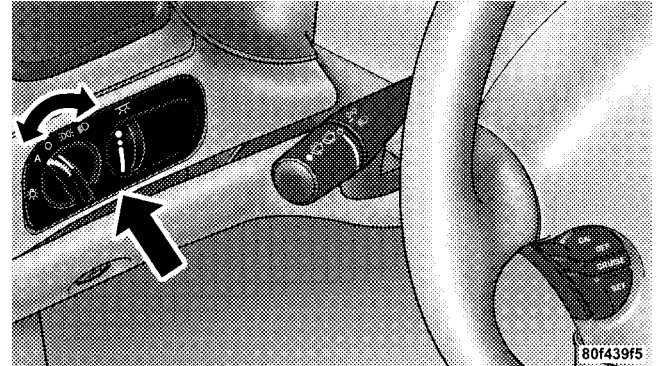

 When the headlight switch is turned clockwise from Off to the first position, the parking lights, taillights, side marker lights, license plate light and instrument panel lights are all turned on. The headlights turn on when the switch is turned to the second position.

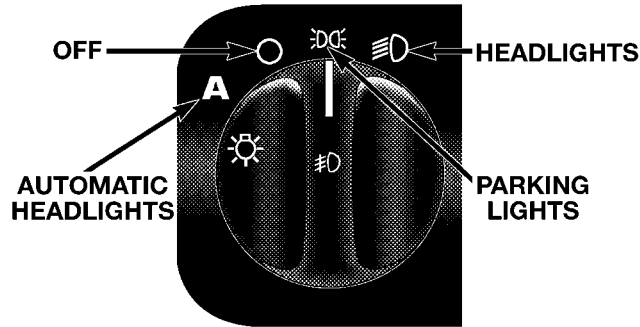

80b6f04e

### Lights-On Reminder

If the headlights or parking lights are left on after the ignition is turned Off, a chime will sound when the driver's door is opened.

### Automatic Headlights

This system automatically turns your headlights on at a preset level of outdoor lighting. To turn the system on, turn the headlight switch to the extreme left. When the system is on, the headlight delay feature is also on. This means that your headlights will stay on for about 90 seconds after you turn the ignition switch off. To turn the

Automatic system off, turn the headlight switch clockwise, to the off position.

The engine must be running before the headlights will come on in the automatic mode.

**NOTE:** The Automatic Headlight System will turn on the headlights if it detects that the windshield wipers have been in operation for more than 10 seconds.

3

### Headlight Time Delay

This feature provides the safety of headlight illumination for about 90 seconds when leaving your vehicle in an unlighted area. For vehicles equipped with Electronic Vehicle Information Center (EVIC), this is customer programmable to Off, 30, 60, or 90 seconds. (See the Electronic Vehicle Information Center (EVIC) section of this manual.)

To activate the delay, turn off the ignition while the headlights are still on. Then turn off the headlights within 45 seconds. The delay interval begins when the ignition is turned off.

If the headlights are turned off before the ignition, they will go off in the normal manner.

### Battery Saver Feature

If an exterior light is left on when the ignition switch is moved to the Off position, it will automatically turn off after 10 minutes. Normal operation will resume when the ignition is turned On or when the headlight switch is turned to another position.

### Fog Lights

#0 Turn the headlight switch to any ON position, then pull out the headlight switch knob to turn on the fog lights. A light near the switch will illuminate to show that the Fog Lights are On.

**NOTE:** Turning on the high beam headlights will turn off the fog lights. Fog light operation will resume when the high beams are turned off and the lights return to the low beam, parking light, or automatic positions.

### Daytime Running Lights (Canada Only)

The headlights are on at a dimmer level whenever the vehicle is started and the parking brake is released. The lights remain on until the ignition switch is turned OFF.

### MULTIFUNCTION CONTROL LEVER

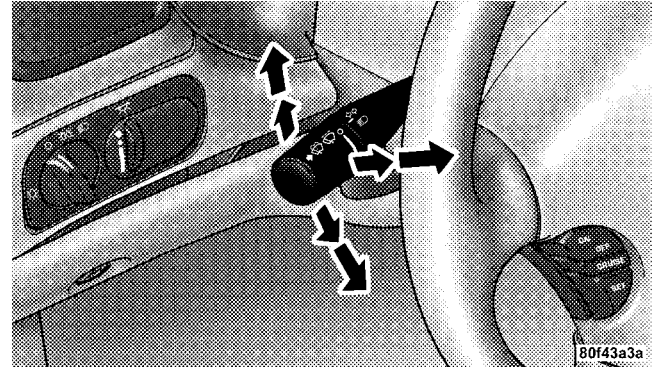

### Turn Signals

The arrows on each side of the instrument cluster flash to show operation of the front and rear turn signal lights. If either light flashes at an extremely fast rate, check for a defective outside light bulb. If both of the indicators fail to light when the lever is moved, it would suggest that the fuse or indicator bulbs are defective.

### Headlight Dimmer Switch

Pull the multi-function control lever toward the steering wheel to switch the headlights from high or low beam.

### Passing Light

You can signal another vehicle with your headlights by lightly pulling the multi-function lever toward the steering wheel. This will cause the headlights to turn on at high beam and remain on until the lever is released.

### Windshield Wipers And Washers

The wipers and washers are operated by a switch in the control lever. Turn the end of the handle to select the desired wiper speed.

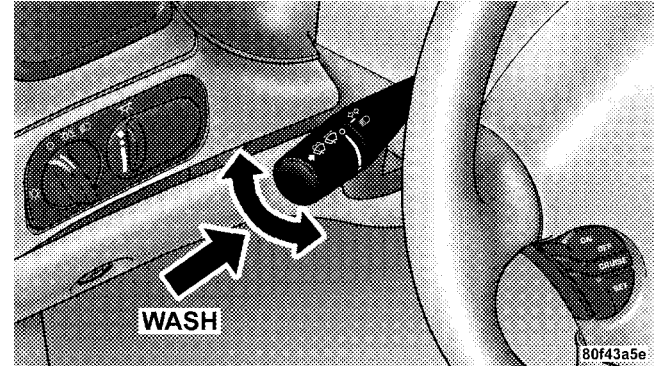

**NOTE:** The vehicle electronics will shut the windshield wiper system off if the wiper motor has been trying to move a stuck wiper blade for more than 20 seconds. This feature prevents damage to the wiper motor. If this occurs, free the stuck blade and then turn the ignition switch Off, then On. This will reset the system.

To use the washer, push the knob in when spray is desired. If the button is pushed while in the delay range, the wiper will operate for several seconds after the knob is released, and then resume the intermittent interval.

If the button is pushed and held while in the OFF position, the wiper will operate for several wipes then turn off.

If the button is pushed while in the OFF position, the wipers will cycle twice.

**NOTE:** The Automatic Headlight System will turn on the headlights if it detects that the windshield wipers have been in operation for more than 10 seconds.

**WARNING!**

**Sudden loss of visibility through the windshield could lead to an accident. You might not see other vehicles or other obstacles. To avoid sudden icing of the windshield during freezing weather, warm the windshield with the defroster before and during windshield washer use.**

**Speed Sensitive Intermittent Wipers System**

Use the intermittent feature of this system when weather conditions make a single wiping cycle, with a variable pause between cycles, desirable.

For maximum delay between cycles, turn the control knob into the upper end of the delay range. The delay interval decreases as you turn the knob until it enters the LO continual speed position. The delay can be regulated from a maximum of about 18 seconds between cycles, to a cycle every 1/2 second.

**NOTE:** Vehicle speed is monitored to calculate wiper delay intervals. The delay between cycles is shortened when the vehicle is moving above 10 mph (16 km/h) and lengthened below 10 mph (16 km/h).

### TILT STEERING COLUMN

To tilt the column, pull the small lever below the turn signal control toward you and move the wheel up or down, as desired. Release the lever to lock the wheel firmly in place.

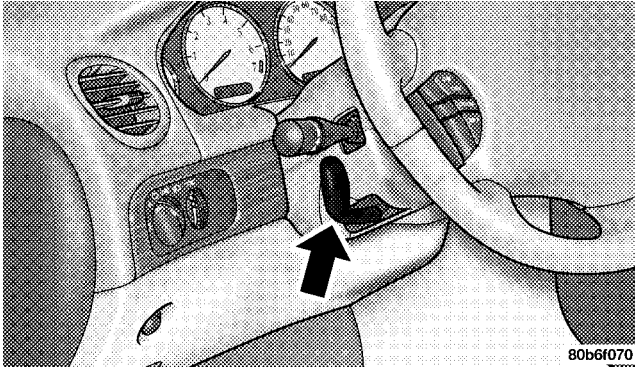

### WARNING!

Tilting the steering column while the vehicle is moving is dangerous. Without a stable steering column, you could lose control of the vehicle and have an accident. Adjust the column only while the vehicle is stopped. Be sure it is locked before driving.

3

### TRACTION CONTROL SWITCH — IF EQUIPPED

To turn the Traction Control System Off, press the switch located on the instrument panel, to the right of the steering column, until the TRAC OFF light in the instrument cluster lights up.

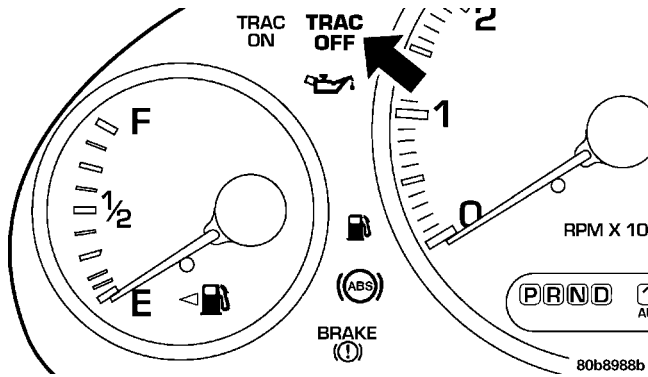

To turn the Traction Control System On, press the switch until the TRAC OFF light in the instrument cluster turns off.

**NOTE:** Traction Control System comes on each time the ignition switch is turned On. This will occur even if you used the switch to turn the Traction system off during the previous ignition cycle.

### ELECTRONIC SPEED CONTROL

This device can be engaged to take over the accelerator operation at speeds between 30 mph (48 km/h) and 85 mph (137 km/h). The controls are mounted on the steering wheel.

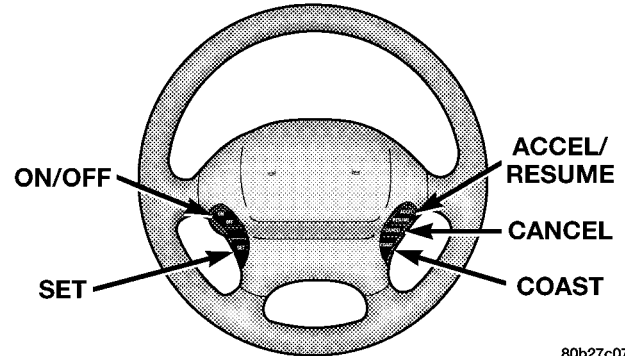



**To Activate:**

Push the ON/OFF button to turn the system ON. The CRUISE light in the instrument cluster will illuminate when the system is ON.

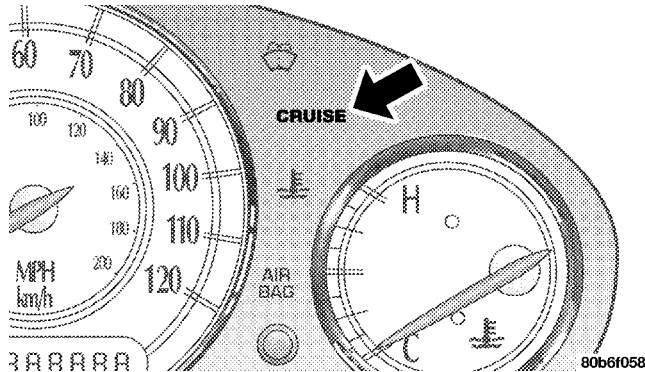

**NOTE:** You must press the ON/OFF button to activate the system each time the engine is started.

**WARNING!**

Leaving the Electronic Speed Control system on when not in use is dangerous. You could accidentally set the system or cause it to go faster than you want. You could lose control and have an accident. Always leave the system OFF when you are not using it.

3

**To Set At A Desired Speed:**

When the vehicle has reached the desired speed, and the system is activated, press and release the SET button. Release the accelerator and the vehicle will operate at the selected speed.

**To Deactivate:**

A soft tap on the brake pedal, pushing the CANCEL button or normal brake pressure while slowing the vehicle will deactivate the speed control without erasing the memory. Pushing the ON/OFF button or turning off the ignition turns the speed control system off and erases the memory.

### To Resume Speed:

To resume a previously set speed, push and release the ACCEL/RESUME button. Resume can be used at any speed above 25 mph (40 km/h).

### To Vary The Speed Setting:

When the speed control is engaged, speed can be increased by pressing and holding the ACCEL/RESUME button. When the button is released, a new set speed will be established.

Tapping the ACCEL/RESUME button once will result in a 2 mph (3 km/h) speed increase. Each time the button is tapped, speed will increase. For example, tapping the button three times will increase speed by 6 mph (10 km/h), etc.

To decrease speed while speed control is engaged, press and hold the COAST button. Release the button when the desired speed is reached, and the new speed will be set.

Tapping the COAST button once will result in a 1 mph speed decrease. Each time the button is tapped, speed will decrease. For example, tapping the button 3 times will decrease the speed by 3 mph (5 km/h), etc.

### To Accelerate For Passing:

Depress the accelerator as you would normally. When the pedal is released, the vehicle will return to the set speed.

### WARNING!

**Speed Control can be dangerous where the system can't maintain a constant speed. Your vehicle could go too fast for the conditions, and you could lose control. An accident could be the result. Don't use Speed Control in heavy traffic or on roads that are winding, icy, snow-covered, or slippery.**

### Using Speed Control On Hills

Your vehicle is equipped with Interactive Speed Control. This feature operates when traveling up or down hills with the Speed Control engaged and the driver's foot off of the accelerator.

### When Climbing A Hill

If vehicle speed drops 3 mph (5 km/h) below the Speed Control SET speed, the transmission will downshift to third gear. Under severe conditions the transmission may

downshift again to second gear. The transmission will upshift as the vehicle reaches the top of the hill.

### When Descending A Hill

If vehicle speed rises 3 mph (5 km/h) over the Speed Control SET speed, the transmission will downshift to third gear. This provides engine braking to keep vehicle speed under control. The transmission will not downshift below third gear to control vehicle overspeed. The transmission will upshift to fourth gear after the vehicle has reached the bottom of the hill.

**NOTE:** On very steep hills, a greater speed loss or gain may occur. It may be preferable to drive without Speed Control.

### Rolling Hills

The transmission may downshift into third gear and remain there as the vehicle travels over rolling hills. The transmission will upshift into fourth gear when the road flattens out.

The transmission will resume its normal shift schedule if you depress the accelerator pedal during any of the above conditions.

## OVERHEAD CONSOLE

The overhead console contains dome/reading lights, an optional universal garage door opener (HomeLink®), an optional sunroof switch, and either an Electronic Vehicle Information Center (EVIC) or an Overhead Travel Information System (OTIS).

3

### Dome/Reading Lights

Located in the overhead console are two dome/reading lights.

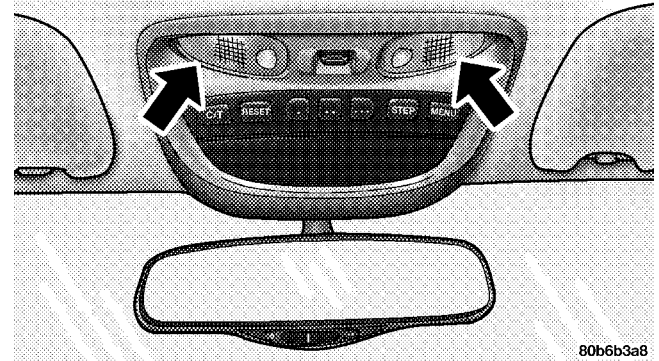

## 76 UNDERSTANDING THE FEATURES OF YOUR VEHICLE

The dome/reading lights illuminate when a door is opened or when the interior lights are turned on by rotating the dimmer control located on the multi-function lever.

The reading lights are activated by pressing on the recessed area of the corresponding lens.

**NOTE:** The dome/reading lights will remain on until the switch is pressed a second time, so be sure they have been turned off before leaving the vehicle.

### **GARAGE DOOR OPENER — IF EQUIPPED**

Equipped in vehicles that have the optional Overhead Travel Information System (OTIS)

The HomeLink® Universal Transceiver replaces up to three remote controls (hand held transmitters) that operate devices such as garage door openers, motorized gates, or home lighting. It triggers these devices at the push of a button. The Universal Transceiver operates off your vehicle's battery and charging system; no batteries are needed.

For additional information on HomeLink®, call 1-800-355-3515, or on the internet at [www.homelink.com](http://www.homelink.com).

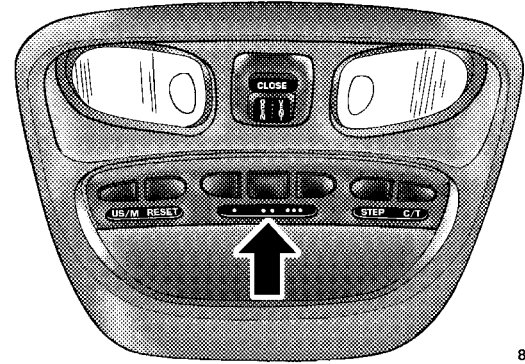

80b27b9b

**WARNING!**

A moving garage door can cause injury to people and pets in the path of the door. People or pets could be seriously or fatally injured. Only use this transceiver with a garage door opener that has a “stop and reverse” feature as required by federal safety standards. This includes most garage door opener models manufactured after 1982. Do not use a garage door opener without these safety features it could cause injury or death. Call toll-free 1-800-355-3515 or, on the Internet at [www.homelink.com](http://www.homelink.com) for safety information or assistance.

**Programming The Universal Transceiver**

For best results, install a new battery in the hand held transmitter before programming. If your garage door opener (located in the garage) is equipped with an antenna, make sure that the antenna is hanging straight down.

1. Turn off the engine.

**WARNING!**

Vehicle exhaust contains carbon monoxide, a dangerous gas. Do not run the vehicle's exhaust while training the transceiver. Exhaust gas can cause serious injury or death.

**WARNING!**

Your motorized door or gate will open and close while you are training the universal transceiver. Do not train the transceiver if people or pets are in the path of the door or gate. A moving door or gate can cause serious injury or death to people and pets or damage to objects.

2. Erase the factory test codes by pressing the two outside buttons. Release the buttons when the light in the overhead console display begins to flash (about 20 seconds).

**NOTE:** Step 2 does not have to be followed to program additional hand held transmitters.

3. Choose one of the three buttons to train. Place the hand held controller one to three inches from the universal transceiver while keeping its indicator light in view.

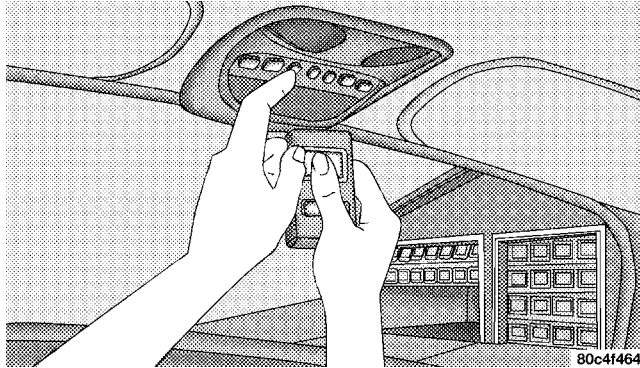

4. Using both hands, press the hand held transmitter button and the desired universal transceiver button. Do not release the buttons until step 5 has been completed.

**NOTE:** Some entry gates and garage door openers may require you to replace step 4 with the procedures listed under Canadian Programming.

5. The indicator light in the Universal Transceiver will begin to flash, first slowly and then rapidly. The rapid flashing indicates successful programming. If after 90 seconds the indicator light does not flash rapidly or goes out, return to step 1 and repeat the procedure. To train the other buttons, repeat steps 3 and 4. Be sure to keep your hand held transmitters in case you need to retrain the Universal Transceiver.

If you do not successfully program the Universal Transceiver to learn the signal of your hand held transmitter, refer to the Rolling Code Paragraph, or call toll free for customer assistance at 1-800-355-3515, or on the internet at [www.homelink.com](http://www.homelink.com).

### **“Rolling Code” Programming**

**NOTE:** If your hand held transmitter appears to program the Universal Transceiver, but your garage door or other device does not operate, and your device was

manufactured after 1996, your garage door opener or other device may have a “Rolling Code” system.

On garage door openers with the “Rolling Code” feature, the transmitter code changes after each use to prevent the copying of your code.

To check if your device is protected by a “Rolling Code” system:

- Check the owner’s manual for the device for mention of “Rolling Codes”.
- Press and hold the programmed button on the Universal Transceiver. If the Universal Transceiver indicator light flashes rapidly and then stays on after 2 seconds, the device has the “Rolling Code” feature.

To train a garage door opener (or other rolling code equipped devices) with the rolling code feature, follow these instructions **after** completing the **Programming** portion of this text:

**NOTE:** The assistance of a second person may make the following programming procedure quicker and easier.

1. Locate the training button on the garage door motor head unit. The exact location and color of the button may vary by garage door opener manufacturer. **If you have difficulty in locating the training button, check your garage door opener manual, or call 1-800-355-3515 or, on the Internet, at [www.homelink.com](http://www.homelink.com).**

2. Press and hold the training button on the garage door opener head unit. This will activate the “training” light.

**NOTE:** After completing step 2, you have 30 seconds to start step 3.

3. Return to the Universal Transceiver in the vehicle and firmly press and release the garage door button. Press and release the button a second time to complete the training process. Some garage door openers may require you to do this procedure a third time to complete the training.

Your garage door opener should now recognize your Universal Transceiver. The remaining two buttons may now be programmed if this has not previously been done. Refer to the Programming instructions. You may

use either your Universal Transceiver or your original hand-held transmitter to open you garage door.

### **Canadian Programming/Gate Programming**

Canadian frequency laws, and the technology of some entry gates, require you to press and release the hand held transmitter button every two seconds during programming

Continue to press and hold the Universal Transceiver button while you press and release the hand held transmitter button until the frequency signal has been learned. The Universal Transceiver light will flash slowly and then rapidly when the programming is successful.

**NOTE:** When programming such a garage door opener or gate, unplug the device to prevent possible damage to the garage door or gate motor.

### **Operation**

Press and hold the desired button on the Universal Transceiver until the garage door or other device begins to operate. The light in the display shows that the signal is being transmitted. The hand held transmitter may also be used at any time.

### **Reprogramming A Single Button**

1. Press and hold the Universal Transceiver button to be reprogrammed. Do not release until step 4 has been completed.
2. When the indicator light begins to flash slowly (after 20 seconds) position the hand held transmitter 1 to 3 inches (3 to 8 cm) away from the button to be trained.
3. Press and hold the hand held transmitter button.
4. The Universal Transceiver indicator light will begin to flash, first slowly, then rapidly. When the indicator lights begin to flash rapidly, release both buttons.

### **Security**

If you sell your vehicle, be sure to erase the frequencies.

To erase all of the previously trained frequencies, hold down both outside buttons until the green light begins to flash.

This device complies with part 15 of FCC rules and with RS-210 of Industry Canada. Operation is subject to the following conditions:



1. This device may not cause harmful interference.
2. This device must accept any interference that may be received including interference that may cause undesired operation.

**NOTE:** Changes or modifications not expressly approved by the party responsible for compliance could void the user's authority to operate the equipment.

HomeLink® is a trademark owned by Johnson Controls, Inc.

### **GARAGE DOOR OPENER — IF EQUIPPED**

**Equipped in vehicles that have the optional Electronic Vehicle Information Center (EVIC)**

The HomeLink® Universal Transceiver replaces up to three remote controls (hand-held transmitters) that operate devices such as garage door openers, motorized gates, or home lighting. It triggers these devices at the push of a button, located on the overhead console. The universal transceiver operates off your vehicle's battery and charging system; no batteries are needed.

For additional information on HomeLink®, call 1-800-355-3515, or on the internet at [www.homelink.com](http://www.homelink.com).

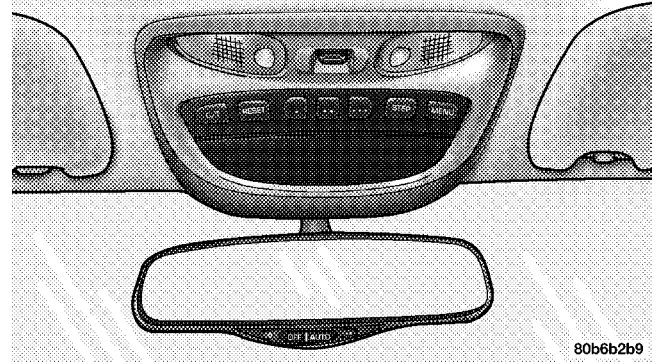

80b6b2b9

**WARNING!**

A moving garage door can cause injury to people and pets in the path of the door. People or pets could be seriously or fatally injured. Use this transceiver with a garage door opener that has a "stop and reverse" feature as required by federal safety standards. This includes most garage door opener models manufactured after 1982. Contact HomeLink® at 1-800-355-3515 for safety information or assistance or on the internet at [www.homelink.com](http://www.homelink.com).

**Programming The Universal Transceiver**

For best results, install a new battery in the hand held transmitter before programming. If your garage door opener (located in the garage) is equipped with an antenna, make sure that the antenna is hanging straight down.

1. Turn off the engine.

**WARNING!**

Vehicle exhaust contains carbon monoxide, a dangerous gas. Do not run the vehicle's engine while programming the universal transceiver. Exhaust gas can cause serious injury or death.

**WARNING!**

Your motorized door or gate will open and close while you are programming the universal transceiver. Do not program the universal transceiver if people or pets are in the path of the door or gate. A moving door or gate can cause serious injury or death to people and pets or damage to objects.

2. Erase the factory test codes by pressing and holding channels button one and three, of the universal transceiver, until **CLEARED CHANNELS** displays (about 20 seconds). Release the buttons.

**NOTE:** Step 2 does not have to be followed to program additional hand held transmitters.

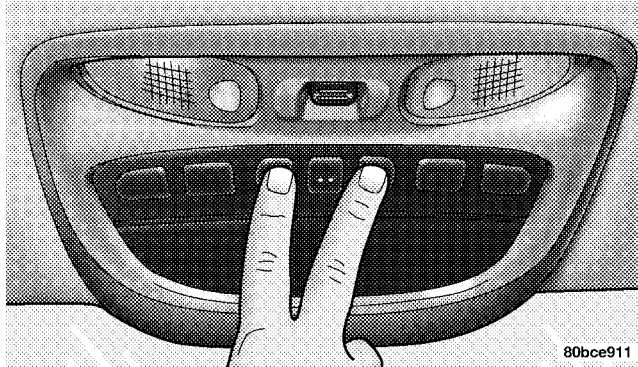

3. Choose one of the three universal transceiver buttons to program. Place the hand-held controller at the lower left corner of the display and approximately 1 to 3 inches away from the surface of the universal transceiver while keeping the display in view.

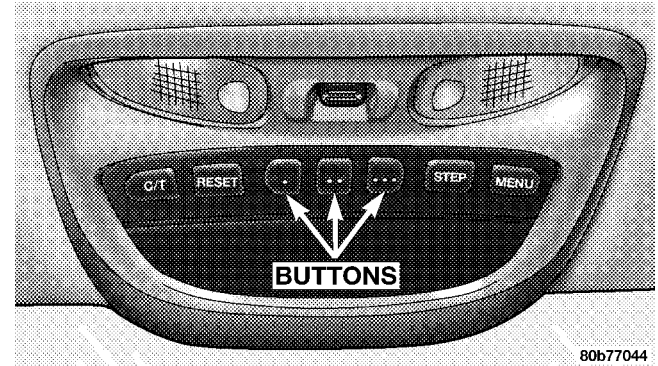

3

4. Using both hands, simultaneously press and hold the button on the hand-held transmitter and the button you would like to program on the universal transceiver. The display on the universal transmitter will show **TRAINING**. When **TRAINED** appears in the display, release

both buttons. Your universal transceiver is now programmed. After a button has been trained, TRANSMIT will appear in the display when the button is pressed.

**NOTE:** Some entry gates and garage door openers may require you to replace step 4 with the procedures listed under Canadian Programming.

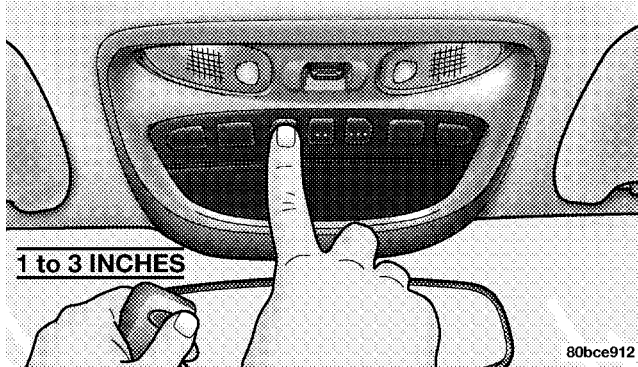

5. To program the other buttons, repeat steps 3 and 4. Be sure to keep your hand-held transmitters in case you need to reprogram the universal transceiver.

**NOTE:** If you do not successfully program the Universal Transceiver to learn the signal of the hand-held transmitter, refer to the Rolling Code Paragraph, or call toll-free for customer assistance at 1-800-355-3515 or on the internet at [www.homelink.com](http://www.homelink.com).

### “Rolling Code” Programming

**NOTE:** If your hand held transmitter appears to program the universal transceiver, but your garage door or other device does not operate, and your device was manufactured after 1996, your garage door opener or other device may have a “Rolling Code” system.

On garage door openers with the “Rolling Code” feature, the transmitter code changes after each use to prevent the copying of your code.

To check if your device is protected by a “Rolling Code” system:

- Check the owner’s manual for the device for mention of “Rolling Codes”.
- Press and hold the programmed button on the universal transceiver. If the universal transceiver indicator

light flashes rapidly and then stays on after 2 seconds, the device has the “Rolling Code” feature.

To train a garage door opener (or other rolling code equipped devices) with the rolling code feature, follow these instructions **after** completing the **Programming** portion of this text:

**NOTE:** The assistance of a second person may make the following programming procedure quicker and easier.

1. Locate the programming button on the garage door opener motor head unit. The exact location and color of the button may vary by garage door opener brand. If there is difficulty locating the programming button, reference the garage door opener owner’s manual or contact HomeLink® at 1-800-355-3515 or on the internet at [www.homelink.com](http://www.homelink.com).

2. Press and hold the training button on the garage door opener head unit. This will activate the “training” light.

**NOTE:** After completing step 2, you have 30 seconds to start step 3.

3. Return to the universal transceiver in the vehicle and firmly press and release the garage door button. Press and release the button a second time to complete the training process. Some garage door openers may require you to do this procedure a third time to complete the training.

Your garage door opener should now recognize your universal transceiver. The remaining two buttons may now be programmed if this has not previously been done. Refer to the Programming instructions. You may use either your universal transceiver or your original hand-held transmitter to open your garage door.

### **Canadian Programming/Gate Programming**

Canadian frequency laws, and the technology of some entry gates, require you to press and release the hand held transmitter button every two seconds during programming.

**NOTE:** When programming such a garage door opener or gate, unplug the device to prevent possible damage to the garage door or gate motor.

Continue to press and hold the Universal Transceiver button while you press and release the hand held transmitter button until the frequency signal has been learned.

Release both buttons when TRAINED appears in the display.

### Operation

Press the desired universal transceiver button. The display shows that the appropriate channel signal is being transmitted and the programmed device should operate. For convenience, the hand-held transmitter of the device may also be used at any time.

### Reprogramming a Single Universal Transceiver Button

1. Press and hold the desired universal transceiver button for about 20 seconds.
2. When TRAINING appears in the display, position the hand-held transmitter one to three inches away from the universal transceiver surface.
3. Press and hold the hand-held transmitter button.

4. When TRAINED appears in the display, the previous programming for the button has now been erased and a new device has been programmed to the button. This procedure will not affect any other programmed buttons.

### Security

If you sell your vehicle, be sure to erase the frequencies.

To erase all of the previously programmed frequencies, hold down buttons one and three until CLEARED CHANNELS appears in the display.

**NOTE:** Individual channels can not be erased. You must erase all three channels.

This device complies with part 15 of FCC rules and with RS-210 of Industry Canada. Operation is subject to the two following conditions: (1) This device may not cause harmful interference and (2) this device must accept any interference that may be received including interference that may cause undesired operation.

**NOTE:** Changes or modifications not expressly approved by the party responsible for compliance could void the user's authority to operate the equipment.

HomeLink® is a registered trademark owned by Johnson Controls, Inc.

**POWER SUN ROOF — IF EQUIPPED**

The sun roof controls are located on the overhead console.

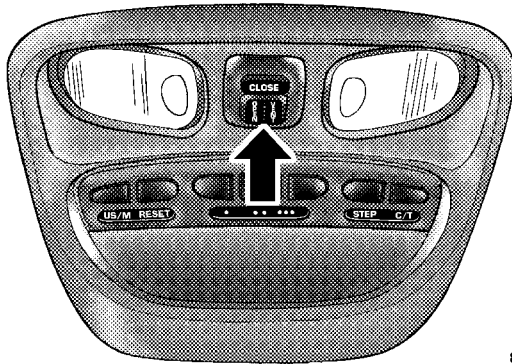

80b27b9c

To Open the sunroof from the Closed position, press and release the OPEN button. The sunroof will open fully, then stop automatically.

To Close the sunroof from an open or vent position, press and **hold** the CLOSE button. The sunroof will close fully and stop automatically. Release the CLOSE button to stop sunroof travel at any point.

If the sun roof is vented and you wish to open it, press and hold the OPEN button. If the sun roof is open and you wish to vent it, press and hold the VENT button.

The sunshade can be opened manually. It will also open as the sun roof opens. The sunshade cannot be closed if the sun roof is open.

3

**WARNING!**

In an accident, there is a greater risk of being thrown from a vehicle with an open sun roof. You could also be seriously injured or killed. Always fasten your seatbelt properly and make sure all passengers are properly secured too.

Do not allow small children to operate the sun roof. Never allow fingers or other body parts, or any object to project through the sun roof opening. Injury may result.

### Wind Buffeting

Wind buffeting can be described as the perception of pressure on the ears or a helicopter type sound in the ears. Your vehicle may exhibit wind buffeting with the windows down, or the sunroof (if so equipped) in certain open or partially open positions. This is a normal occurrence and can be minimized. If the buffeting occurs with the rear windows open, open the front and rear windows together to minimize the buffeting. If the buffeting occurs with the sunroof open, adjust the sunroof opening to minimize the buffeting.

### Sun Roof Maintenance

Use only a non abrasive cleaner and a soft cloth to clean the glass panel.

### ELECTRONIC VEHICLE INFORMATION CENTER (EVIC) — IF EQUIPPED

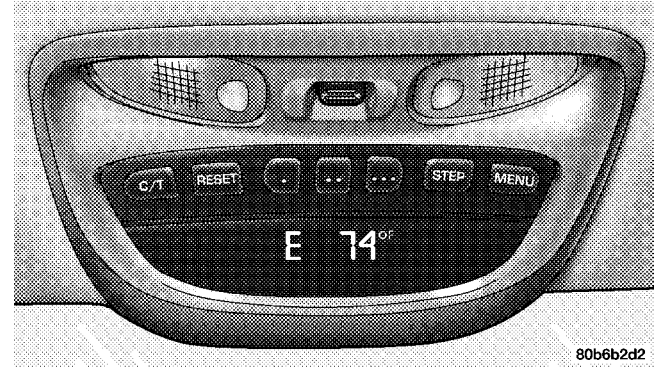

The vehicle information center, when the appropriate conditions exist, displays the following WARNING messages and symbols. Each message is accompanied by a series of beeps:

- TURN SIGNALS ON (with graphic)
- PERFORM SERVICE
- DOOR OPEN (one or more, with graphic)



- WASHER FLUID LOW (with graphic)
- MEMORY SEAT DISABLED VEHICLE (not in Park)

**Customer Programmable Features**

Press the MENU button until one of the display choices following appears:

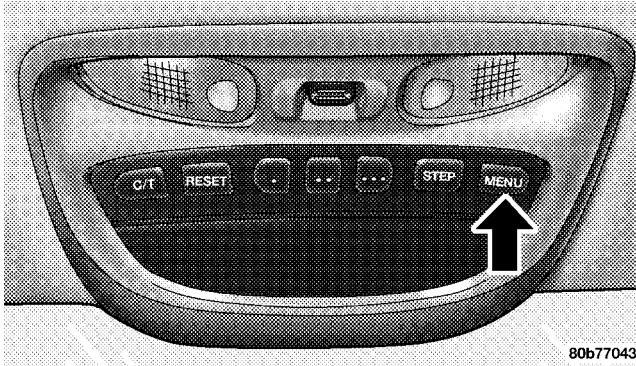

80b77043

**Language**

When in this display you may select one of five languages for all display nomenclature, including the trip computer functions. Press the STEP button while in this display selects English, Francaise, Deutsch, Italiano, or

Espanol. As you continue the displayed information will be shown in the selected language.

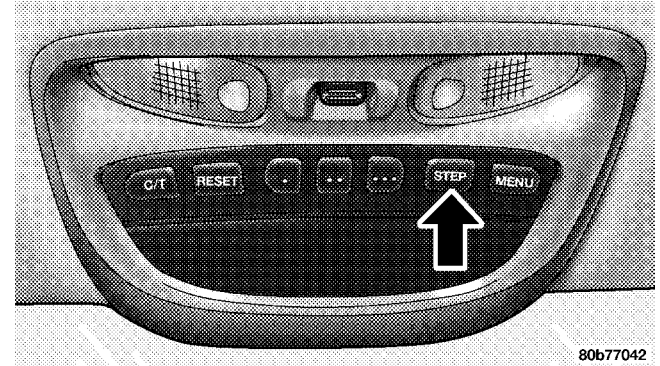

80b77042

**US or Metric**

Pressing the STEP button when in this display selects US or Metric. The overhead console and instrument panel displays will be in the selected units.

**Auto Door Locks**

When this feature is selected, all doors lock automatically when the speed of the vehicle reaches 15 mph (25 km/h). Pressing the STEP button when in this display will select “Yes” or “No.”

**Auto Unlock On Exit (Available Only When the AUTO DOOR LOCKS Feature is Turned On )**

When this feature is selected all the vehicle’s doors will unlock when the driver’s door is opened if the vehicle is stopped and the transmission is in P (Park) or N (Neutral) position. Pressing the STEP button when in this display will select “Yes” or “No.”

**Remote Unlock Driver’s Door 1st**

When this feature is selected only the driver’s door will unlock on the first press of the remote keyless entry unlock button and require a second press to unlock the remaining locked door. When **REMOTE UNLOCK ALL DOORS** is selected all of the doors will unlock at the first press of the remote keyless entry unlock button. Pressing the STEP button when in this display will select DRIVER’S DOOR 1ST or ALL DOORS.

**Remote Linked To Memory (Available with Memory Seat Only)**

When this feature is selected the memory seat, mirror, and radio settings will return to the memory set position when the remote keyless entry “Unlock” button is pressed. If this feature is not selected then the memory seat, mirror, and radio settings can only return to the memory set position using the door mounted switch. Pressing the STEP button when in this display will select “Yes” or “No.”

**Sound Horn with Lock**

When this feature is selected a short horn sound will occur when the remote keyless entry “Lock” button is pressed. This feature may be selected with or without the flash lights on lock/unlock feature. Pressing the STEP button when in this display will select “Yes” or “No.”

**Flash Lights with Lock/Unlock**

When this feature is selected, the front and rear turn signals will flash when the doors are locked or unlocked using the remote keyless entry transmitter. This feature may be selected with or without the sound horn on lock

feature selected. Pressing the STEP button when in this display will select “Yes” or “No.”

### **Headlamp Delay**

When this feature is selected the driver can choose, when exiting the vehicle, to have the headlamps remain on for 30, 60, or 90 seconds, or not remain on. Pressing the STEP button when in this display will select 30, 60, 90, or OFF.

### **Headlamp On With Wipers (Available with Auto Headlights Only)**

When this feature is selected and the headlight switch has at least once been moved to the AUTO position, the headlights will turn on when the wipers are turned on. The headlights will also turn off when the wipers are turned off if they were turned on in this way. Pressing the STEP button when in this display will select “Yes” or “No.”

**NOTE:** Turning the headlights on during the daytime causes the instrument panel lights to dim. To increase the brightness, refer to “Lights” in this section.

### **Service Interval**

When this feature is selected a service interval between 2,000 (3 200 km) and 6,000 miles (9 600 km) in 500 mile (800 km) increments may be selected. Pressing the STEP button when in this display will select distances between 2,000 (3 200 km) and 6,000 miles (9 600 km) in 500 mile (800 km) increments.

### **Reset Service Distance (Displays Only if Service Interval was Changed)**

When this feature is selected the current accumulated service distance can be reset to the newly selected service interval. Pressing the STEP button when in this display will select “Yes” or “No.”

### **Easy Exit Seat**

When this feature is selected the driver’s seat moves rearward two inches (55 mm) or to the farthest rearward position if this distance is less than two inches (55 mm) when the key is removed from the ignition switch so that the driver can more easily exit the vehicle. The seat will return to the memorized seat location (if REMOTE LINK TO MEMORY is set to YES) when the remote keyless entry transmitter is used to unlock the door. Pressing the

STEP button when in this display will select “Yes” or “No.”

### **Tilt Mirrors Down**

When this feature is selected, and the vehicle is placed in reverse, the driver’s exterior mirror will tilt downward to improve visibility of rear wheel area. Once reverse is disengaged, the driver’s exterior mirror will return to it’s original position. Pressing the STEP button when in this display will select “YES” or “NO”.

### **Train Remote**

**NOTE:** As a safety feature, successful training of at least one transmitter will erase all previously trained transmitters.

When this feature is selected the driver can choose to train up to four remote keyless entry transmitters. Pressing the STEP button when in this display will select

“YES” or “NO”. When “YES” is selected and the MENU button is pressed; the EVIC will display “PRESS REMOTE LOCK & UNLOCK THEN PRESS UNLOCK”, followed by a chime to indicate the training sequence can commence. You have approximately 30 seconds to train up to four transmitters; after each transmitter is trained a chime will sound indicating that the training was successful. If remote link to memory is “YES,” the first transmitter trained will be associated with memory setting 1 and the second transmitter trained will be associated with memory setting 2. Additional transmitters will not be associated with a memory setting. When you have finished training the transmitters, press the MENU button again and the EVIC will display “TRAIN DONE, x TRAINED”. (Where x = 1,2,3, or 4) If no transmitters are trained within approximately 30 seconds the EVIC will display “TRAIN TIMEOUT”.

### Compass/Temperature/Trip Computer

This display provides the outside temperature, one of the eight compass headings to indicate the direction the vehicle is facing, and vehicle trip information. The compass and temperature display is the normal display. When the C/T button is pressed or the customer programmable features have been “stepped through” the compass/temperature display returns.

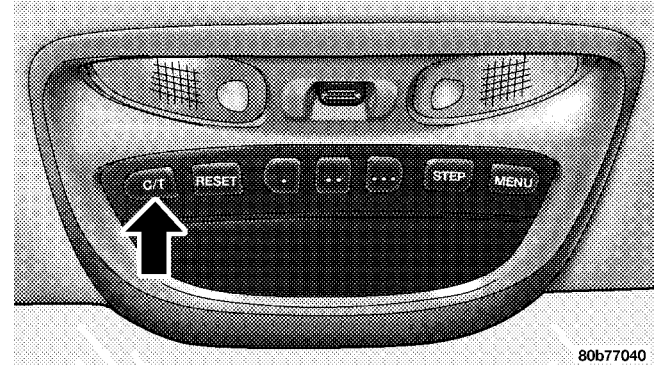
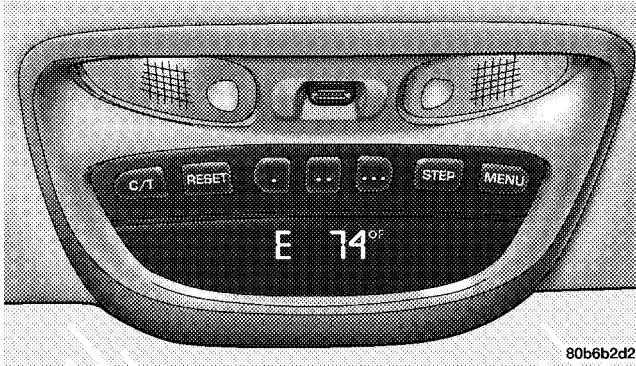

3

### Trip Computer

This feature, located in the overhead console, displays the following information when the display is in the “Compass/Temperature” mode and the STEP button is pressed:

### Step Button

Press the STEP button to cycle through all of the Compass/Mini-Trip Computer displays.

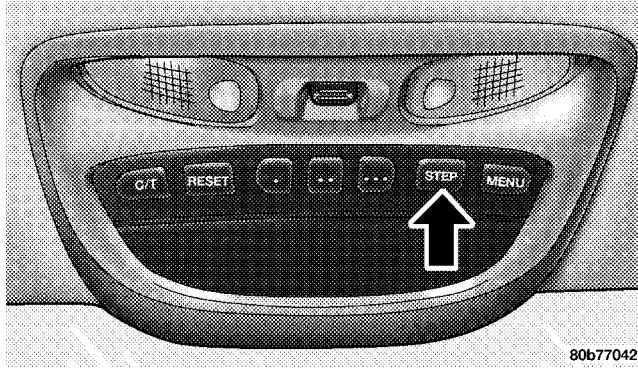

### Average Fuel Economy

Shows the average fuel economy since the last reset.

### Distance To Empty

Shows the estimated distance that can be travelled with the fuel remaining in the tank. This is calibrated using the miles per gallon for the last few minutes.

### Trip Odometer

Shows the distance travelled since the last reset.

### Elapsed Time

Shows the accumulated ignition ON time since the last reset.

### Miles to Service

Shows the distance remaining to require service.

**NOTE:** This display can be reset to the set service interval by pressing and holding the RESET button for 3 seconds.

### Blank Screen

Shows a blank screen. Pressing the STEP button returns to the compass and temperature display.

### Automatic Compass Calibration

This compass is self-calibrating which eliminates the need to manually set the compass. When the vehicle is new, the compass may appear erratic and the CAL symbol will be displayed.

After completing three 360° turns in an area free from large metal or metallic objects, the CAL symbol will turn off and the compass will function normally.

### Manual Compass Calibration

If the compass appears erratic and the CAL symbol does not appear, you must manually put the compass into the “Calibration” mode.

**NOTE:** To ensure proper compass calibration, make sure the compass variance is properly set before manually calibrating the compass (see variance map).

### To Put Into a Calibration Mode

Turn on the ignition and set the display to “Compass/Temperature.” Press and hold the RESET button to change the display between VAR (compass variance) and CAL (compass calibration) modes. When the CAL symbol is displayed complete three 360 degree turns in an area free from large metal objects or power lines. The CAL symbol will turn off and the compass will function normally.

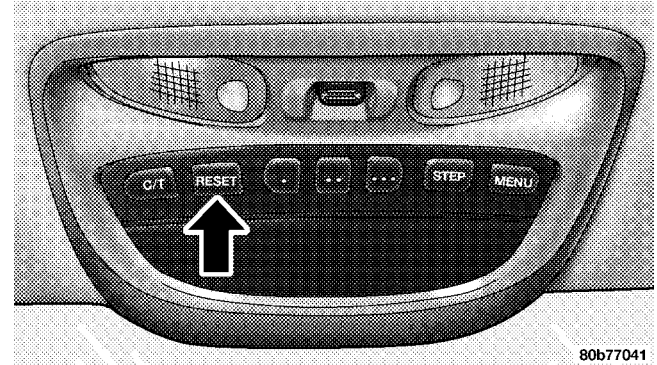

3

**Compass Variance** is the difference between magnetic north and geographic north. In some areas of the country, the difference between magnetic and geographic north is great enough to cause the compass to give false readings. If this occurs, the compass variance must be set according to the Compass Variance Map.

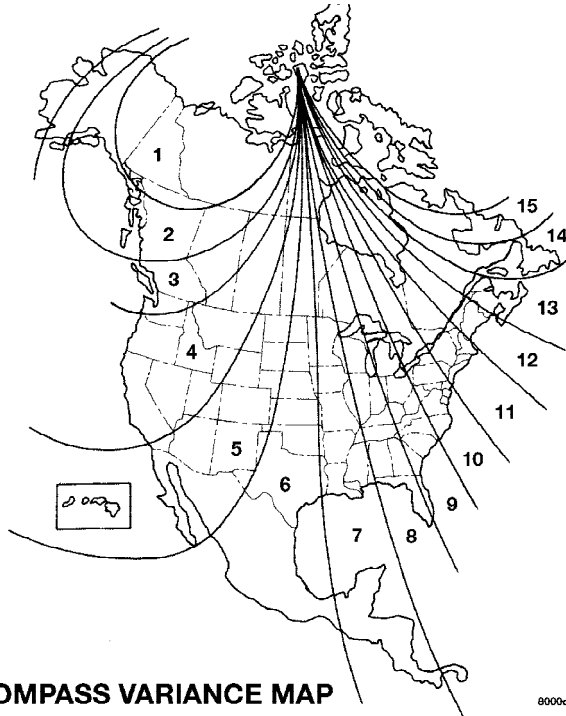

To set the variance: Turn the ignition ON and set the display to "Compass/Temperature." Press the RESET button approximately five seconds. The last variance zone number will be displayed. Press the STEP button to select the new variance zone and press the RESET button to resume normal operation.

### OVERHEAD TRAVEL INFORMATION CENTER — IF EQUIPPED

This feature allows you to choose between a compass / temperature display and one of five trip conditions being monitored.

Pressing the STEP button will select the available trip information. Pressing the US / M button will toggle between US and Metric displays. Pressing the C/T (Compass / Temperature) button will return the display to the normal compass / temperature display.



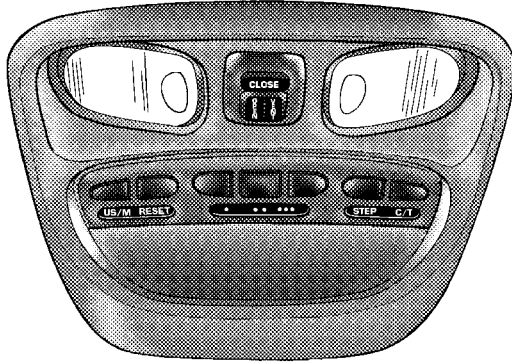

80b34e49

**US/M Button**

Use this button to change the display from U.S. to metric measurement units.

**RESET Button**

Use this button to reset the following displays to zero:  
 Average Fuel Economy  
 Trip Odometer  
 Elapsed time.

**Global Reset**

If the RESET button is pressed twice within 3 seconds while in any of the 3 resettable displays, the Global Reset button will reset all 3 displays.

**Step Button**

Use this button to choose or cycle through the five trip conditions.

**Average Fuel Economy (AVG ECO)**

This display shows the average fuel economy since the last reset.

**Distance To Empty (DTE)**

This display shows the estimated distance that can be traveled with the fuel remaining in the tank. The distance is calculated by multiplying the amount of fuel remaining by the projected fuel economy. The distance predicted will change every few seconds to a higher or lower number as these factors change.

This display cannot be reset.

**Trip Odometer (ODO)**

This display shows the distance traveled since the last reset.

**Elapsed Time (ET)**

This display shows the accumulated ignition ON time since the last reset.

**C/T Button**

Use this button to select a readout of the outside temperature and one of eight compass headings that indicate the direction in which the vehicle is facing.

**Compass/Temperature Display**

This display provides the outside temperature and one of eight compass readings to indicate the direction the vehicle is facing.

**Automatic Compass Calibration**

The self-calibrating feature of the compass eliminates the need to calibrate the compass for normal conditions. During a short initial period, the compass may appear erratic and the CAL symbol will appear on the display. The CAL symbol may also appear after the vehicle is subjected to a high level of magnetism. After completing

three 360 turns at about 5 mph (8 km/h) in an area free from large metal or metallic objects, the CAL symbol will turn off and the compass will function normally.

**Manual Compass Calibration**

If the compass appears erratic and the CAL light does not appear, you must calibrate the compass. Find an open area away from large metal objects. With the ignition ON and the compass/temperature displayed, press and hold the RESET button until the CAL symbol appears (about 10 seconds). Drive slowly (about 5 mph) (8 km/h) in 3 complete 360 circles. The CAL light will turn off and the compass will be calibrated.

Variance is the difference between magnetic North and geographic North. For proper compass function, the correct variance zone must be set. Refer to the variance map for the correct variance zone. To check the variance zone, the ignition must be on and the compass/temperature displayed. Press and hold the RESET button for about 5 seconds until VAR appears in the display. The number displayed is the variance zone used by the compass. To change the zone, press the STEP button to

scroll through numbers 1 through 15. Press the RESET button after selecting the proper zone to return to the normal compass/temperature display.

**NOTE:** To ensure proper compass calibration, make sure the compass variance is properly set before manually calibrating the compass (see variance map).

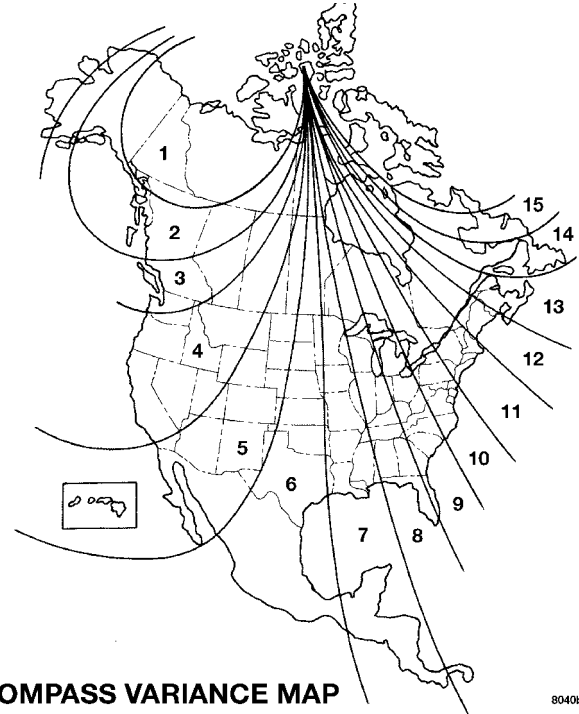

### Outside Temperature

Because engine temperature can increase the displayed temperature, temperature readings are slowly updated when vehicle speed is below 20 mph (30 km/h).

### ELECTRICAL POWER OUTLET

Your vehicle is equipped with one power outlet which is located in the forward portion of the center console if your vehicle has bucket seats or in the lower center of the instrument panel if your vehicle has bench or split bench seats. Accessories powered through this outlet are protected by a 15 amp fuse. The outlet may be converted to a cigar lighter by installing the dealer obtained smoker's package. The outlet is operated by the ignition switch, when in the "run" or "acc" positions only. You may convert the outlet from ignition to battery power by performing the following:

- Remove the fuse cover from the left end of the instrument panel (see the paragraph on fuses in section 7 of this manual.)
- Remove fuse #6 (its on the upper right of the fuse block) from its "IGN" position.

- Move the fuse slightly right and insert it in the fuse #6 "BAT" location in the fuse block.
- Reinstall the fuse cover.

# UNDERSTANDING YOUR INSTRUMENT PANEL

## CONTENTS

■ Instruments And Controls . . . . .	105	□ Power Switch, Volume Control . . . . .	114
■ Instruments And Controls (Concorde Limited Only) . . . . .	106	□ Seek Button (Radio Mode) . . . . .	115
■ Instrument Cluster . . . . .	107	□ Tuning . . . . .	115
■ Instrument Cluster (Concorde Limited Only) . .	108	□ PTY (Program Type) Button . . . . .	115
■ Instrument Cluster Description . . . . .	109	□ Balance . . . . .	116
■ Setting The Analog Clock—If Equipped . . . . .	113	□ Fade . . . . .	116
■ Electronic Digital Clock . . . . .	113	□ Tone Control . . . . .	116
□ Clock Setting Procedure . . . . .	114	□ AM/FM Selection . . . . .	117
■ Sales Code RAZ—AM/ FM Stereo Radio With Cassette Tape Player And CD Player — If Equipped . . . . .	114	□ Scan Button . . . . .	117
□ Operating Instructions — Radio . . . . .	114	□ To Set The Radio Push-Button Memory . . . . .	117
		□ To Change From Clock To Radio Mode . . . . .	117
		□ Operating Instructions — Tape Player . . . . .	117

## 102 UNDERSTANDING YOUR INSTRUMENT PANEL

□ Seek Button . . . . .	118	□ Tape CD Button . . . . .	121
□ Fast Forward (FF) . . . . .	118	□ Time Button . . . . .	121
□ Rewind (RW) . . . . .	118	□ Scan Button . . . . .	121
□ Tape Eject . . . . .	118	■ Sales Code RBB—AM/FM Stereo Radio With Cassette Tape Player And CD Changer Capability . . . . .	121
□ Scan Button . . . . .	118	□ Operating Instructions . . . . .	121
□ Changing Tape Direction . . . . .	118	□ Power Button . . . . .	122
□ Metal Tape Selection . . . . .	118	□ Electronic Volume Control . . . . .	122
□ Pinch Roller Release . . . . .	118	□ Seek . . . . .	122
□ Noise Reduction . . . . .	119	□ Tune . . . . .	122
□ Operating Instructions — CD Player . . . . .	119	□ To Set The Push-Button Memory . . . . .	122
□ Inserting The Compact Disc . . . . .	119	□ Balance . . . . .	123
□ Seek Button . . . . .	119	□ Fade . . . . .	123
□ EJT CD (Eject) Button . . . . .	120	□ Bass And Treble Tone Control . . . . .	123
□ FF/Tune/RW Button . . . . .	120	□ AM/FM Selection . . . . .	123
□ Program Button 4 (Random Play) . . . . .	120		
□ Mode . . . . .	120		

□ Mode Button . . . . .	123	□ Program Button 1 . . . . .	132
□ Cassette Player Features . . . . .	123	□ Program Button 4 (Random Play) . . . . .	132
□ CD Changer Control Capability — If Equipped . . . . .	124	□ Program Button 5 . . . . .	132
□ Radio Display Messages . . . . .	126	□ Time Button . . . . .	132
■ Sales Code RBK—AM/ FM Stereo Radio With CD Player And CD Changer Controls . . . . .	126	□ Changing Modes . . . . .	132
□ Radio Operation . . . . .	126	□ Removing Discs From The CD Changer . . . . .	133
□ CD Player Operation . . . . .	128	□ CD Changer Operation With The Changer Off . . . . .	133
□ CD Changer Operation — If Equipped . . . . .	130	■ Remote Sound System Controls — If Equipped . . . . .	133
■ 6 Disc CD Changer — If Equipped . . . . .	131	□ Radio Operation . . . . .	134
□ Loading The CD Changer . . . . .	131	□ Tape Player . . . . .	134
□ Playing Discs . . . . .	131	□ CD Player — Single Disc In Radio . . . . .	134
□ Seek Button . . . . .	132	□ CD Player — 6 Disc CD Changer . . . . .	134
□ FF/Tune/RW . . . . .	132	■ Cassette Tape And Player Maintenance . . . . .	135
□ Mode Button . . . . .	132	■ Compact Disc Maintenance . . . . .	136

**104 UNDERSTANDING YOUR INSTRUMENT PANEL**

---

■ Radio Operation And Cellular Phones . . . . .	136	□ Automatic Temperature Control (ATC) — If Equipped . . . . .	140
■ Climate Controls . . . . .	137		
□ Manual Air Conditioning/Heater Operation . .	137		



**INSTRUMENTS AND CONTROLS**

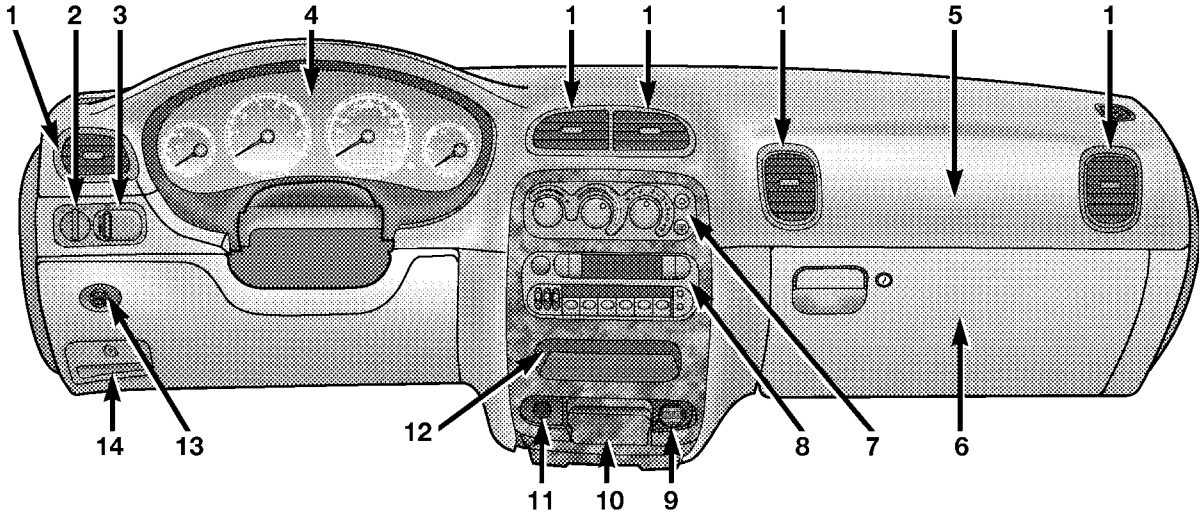

- 1. Air Outlet
- 2. Headlight Switch
- 3. Interior Lights Dimmer Control
- 4. Instrument Cluster
- 5. Passenger Airbag

- 6. Glove Compartment
- 7. Climate Control
- 8. Sound System
- 9. Power Outlet/Cigar Lighter\*

- 10. Ash Tray
  - 11. Traction Control Button\*
  - 12. Storage Bin/CD Changer\*
  - 13. Trunk Release Button
  - 14. Parking Brake Release
- \*Optional

**INSTRUMENTS AND CONTROLS (Concorde Limited Only)**

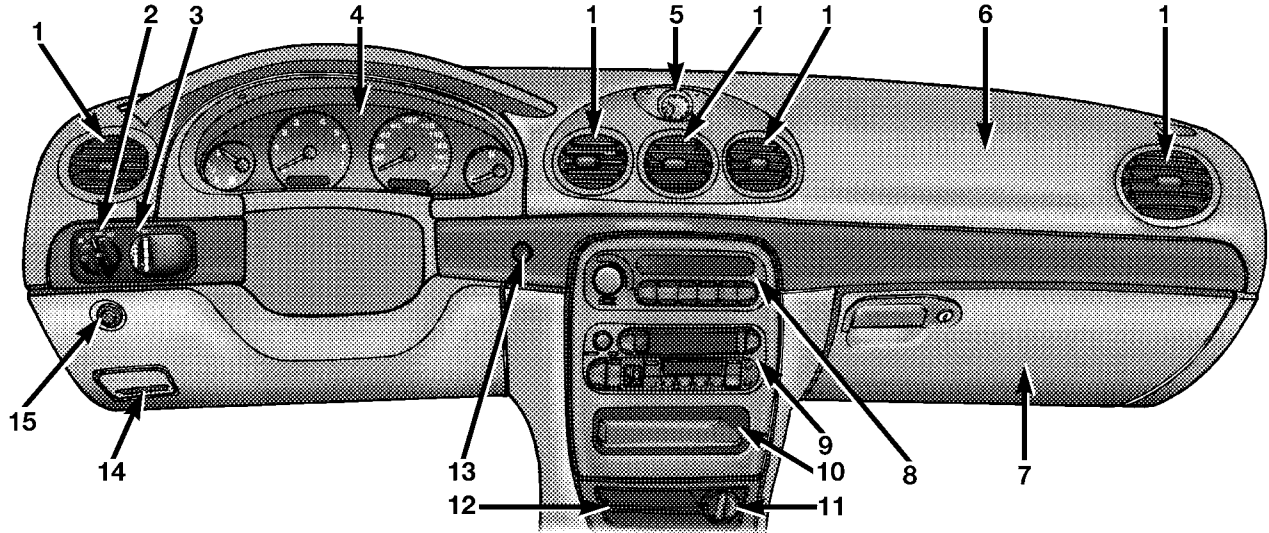

- 1. Air Outlet
- 2. Headlight Switch
- 3. Interior Lights Dimmer Control

- 4. Instrument Cluster
- 5. Clock
- 6. Passenger Airbag
- 7. Glove Compartment

- 8. Climate Control
- 9. Sound System
- 10. Storage Bin
- 11. Power Outlet

- 12. Ash Tray
- 13. Traction Control Switch
- 14. Parking Brake Release
- 15. Trunk Switch

80be44ad

INSTRUMENT CLUSTER

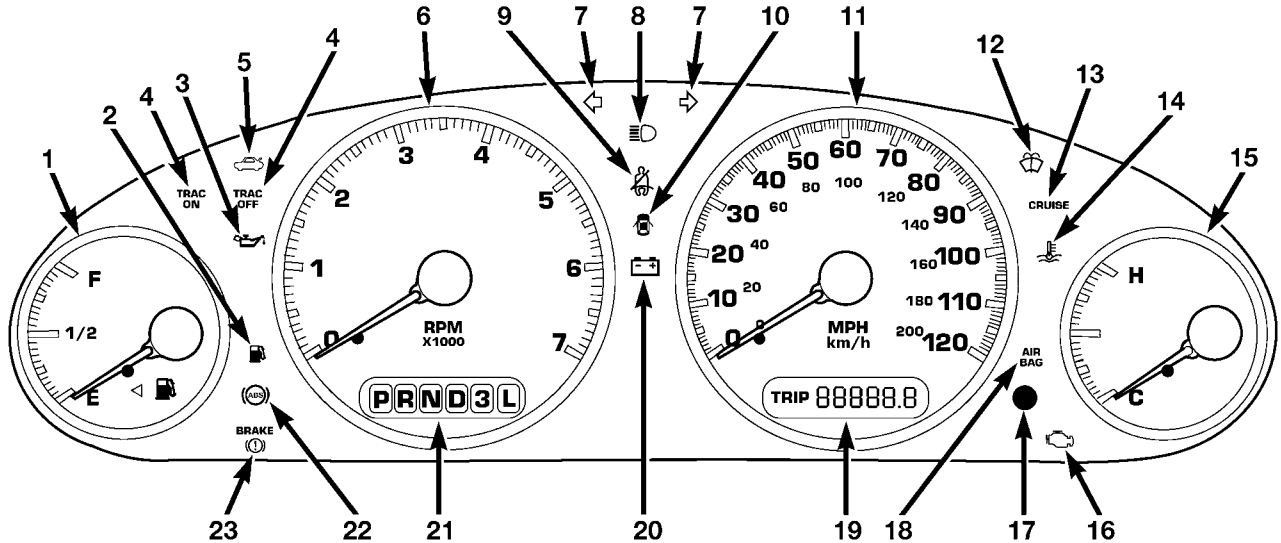

### INSTRUMENT CLUSTER (CONCORDE LIMITED ONLY)

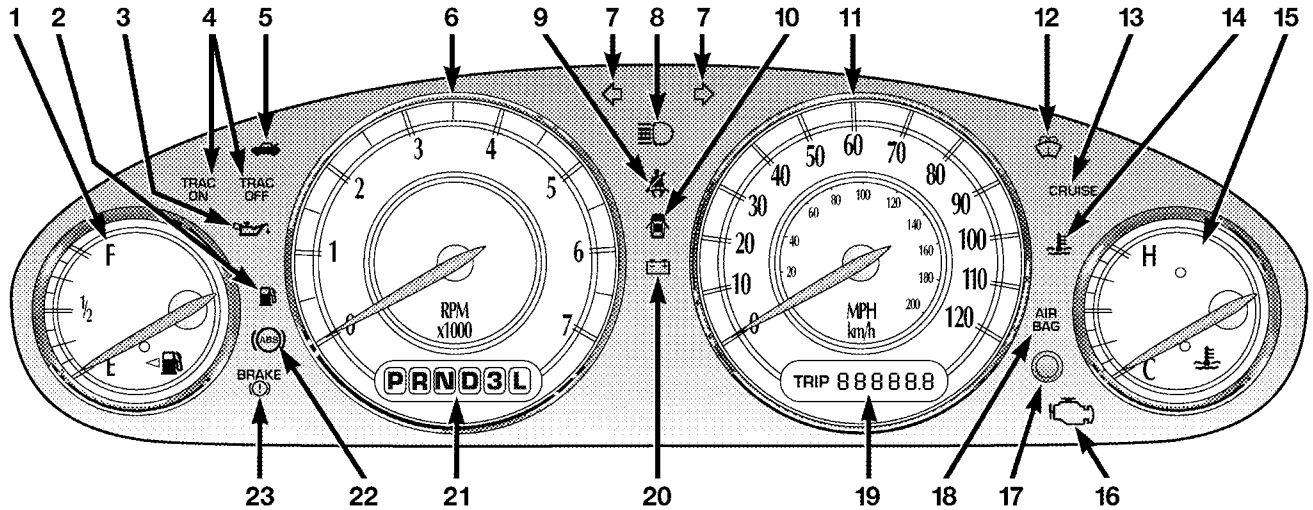

## INSTRUMENT CLUSTER DESCRIPTION

### 1. Fuel Gauge



When the ignition is in the ON position, the pointer will show the level of fuel remaining in the tank.

### 2. Low Fuel Warning Light



When the fuel level drops to about 2 gallons (8 liters), the Low Fuel symbol will light and remain lit until fuel is added. A warning chime will sound when the light comes on.

### 3. Low Oil Pressure Light



This light indicates low engine oil pressure. The light should come on briefly as a bulb check when the engine is first started. If the light stays on or comes on while driving, stop the vehicle and shut off the engine. **DO NOT** operate the vehicle until the cause is corrected. **This light does not show how much oil is in the engine.** The engine oil level must be checked under the hood.

### 4. TRAC ON/OFF Lights

The Traction Control On light (TRAC ON) will come on momentarily as a bulb check when the ignition switch is first turned ON. If the light does not come on, have the bulb replaced.

The TRAC ON light also will come on when the system is controlling traction.

The Traction Control Off light (TRAC OFF) will come on momentarily as a bulb check when the ignition switch is first turned ON. If the TRAC OFF light does not come on, have the bulb checked.

The TRAC OFF light will also come on when the Traction Control switch has been used to turn the system off.

### 5. Trunk Ajar Light



This light indicates that the trunk is not latched

### 6. Tachometer

Measures engine revolutions-per-minute (RPM). The red numbers at the end on the scale show the maximum permissible RPM's. Ease off on the accelerator before reaching the red area.

### 7. Turn Signal Indicators

 The arrow will flash in unison with the exterior turn signal, when using the turn signal lever.

### 8. High Beam Indicator

 This light shows that the headlights are on high beam. Pull the turn signal lever towards the steering wheel to switch the headlights from high or low beam.

### 9. Seat Belt Reminder Light

 The light will come on after the ignition is turned on. The light will remain lit until the seatbelt is fastened.

### 10. Door Ajar Light

 This light shows that a door is not completely closed. A warning chime will sound if the vehicle is moving with a door partially closed.

### 11. Speedometer

Shows vehicle speed in miles-per-hour or kilometers-per-hour.

### 12. Low Washer Fluid Light

 This symbol will light whenever the fluid reservoir is less than 1/4 filled. Adding washer fluid will cause the light to go out the next time the ignition is cycled. A warning chime will sound when the light comes on.

### 13. Cruise (Speed Control) Light

This light shows that the Speed Control System is ON.

### 14. Engine Coolant Temperature Light

 This light warns of an overheated engine coolant condition. A warning chime will sound when the light comes on.

### 15. Engine Coolant Temperature Gauge

 The temperature gauge shows engine coolant temperature. Any reading within the 5 gauge marks between Hot and Cold shows that the cooling system is operating properly. The gauge pointer may show a higher than normal temperature when driving in hot weather, up mountain grades, in heavy stop and go traffic, or when towing a trailer.

If the pointer rises to the “H” mark, stop the vehicle and turn off the engine until the problem is corrected.

There are steps that you can take to slow down an impending overheat condition. If your air conditioning is on, turn it off. The air conditioning system adds heat to the engine cooling system and turning off the A/C removes this heat. You can also turn the Temperature control to maximum heat, the Mode control to Floor and the Fan control to High. This allows the heater core to act as a supplement to the radiator and aids in removing heat from the engine cooling system.

### 16. Malfunction Indicator Light



This light is part of an onboard diagnostic system called OBD that monitors engine and automatic transmission control systems. The light will illuminate when the key is in the ON position before engine start. If the bulb does not come on when turning the key from OFF to ON, have the condition checked promptly.

Certain conditions such as a loose or missing gas cap or poor fuel quality may illuminate the light after engine start. The vehicle should be serviced if the light stays on

through several of your typical driving cycles. In most situations the vehicle will drive normally and will not require towing.

The Malfunction Indicator Light flashes to alert to serious conditions that could lead to immediate loss of power or severe catalytic converter damage. The vehicle should be serviced as soon as possible if this occurs.

### 17. Trip Odometer Reset Knob

To reset the trip odometer, push the reset knob for about two seconds.

### 18. Airbag Light

**AIR BAG** The light will come on and remain on for 6 to 8 seconds as a bulb check when the ignition switch is first turned ON. If the bulb is not lit during starting, have it replaced. If the light stays on, or comes on while driving, have the system checked by an authorized dealer.

### 19. Odometer/Trip Odometer

Shows the total distance the vehicle has been driven.

U.S. Federal regulations require that upon transfer of vehicle ownership, the seller certify to the purchaser the

correct mileage that the vehicle has been driven. Therefore, if the odometer reading is changed during repair or replacement, be sure to keep a record of the reading before and after the service so that the correct mileage can be determined.

The Trip Odometer shows individual trip mileage and is accessed by pressing the reset button.

### 20. Charging System Light



This light shows the status of the electrical charging system. The light should come on briefly when the ignition is first turned on and remain on briefly as a bulb check. If the light stays on or comes on while driving, turn off some of the vehicle's electrical devices, such as the Fog Lights or Rear Defroster. If the Charging System Light remains on, it means that the vehicle is experiencing a problem with the charging system and should be serviced immediately. See your local authorized dealer.

### 21. Transmission Range Indicator

This indicator illuminates to show the automatic transmission gear selection.

### 22. ABS Light



This light monitors the Anti-Lock Brake system described elsewhere in this manual. The yellow ABS light will come on when the ignition key is turned to the ON position and may stay on for several seconds. If the ABS light does not come on have the system checked by an authorized dealer.

If the ABS light remains on or comes on while driving, it indicates that the Anti-Lock portion of the brake system is not functioning and that service is required, however, the conventional brake system will continue to operate normally if the red BRAKE warning light is not on. A warning chime will sound when the light comes on.

If the ABS light is on, the brake system should be serviced as soon as possible to restore the benefits of Anti-Lock brakes.

### 23. Brake System Warning Light

**BRAKE**



The dual brake system provides a reserve braking capability if a failure occurs in a portion of the hydraulic system.



This light monitors both the brake fluid level and the parking brake. If the light comes on, it indicates either that the parking brake is on or there is a low fluid level in the brake master cylinder. On vehicles equipped with anti-lock brakes (ABS), the brake light may also indicate reduced braking performance. If the parking brake is off and the light remains on, have the brake system inspected as soon as possible.

The light will also come on when the parking brake is applied with the ignition in the RUN position.

The warning light should be checked frequently to assure that it is operating properly. This can be done by turning the ignition switch to START. The light should come on.

If the red brake light does not come on, have the system checked by an authorized dealer.

### WARNING!

**Driving a vehicle with the brake light on is dangerous. Part of the brake system may have failed. It will take longer to stop the vehicle. You could have an accident. Have the vehicle checked immediately.**

**NOTE:** This light shows only that the parking brake is on. It does not show the degree of brake application.

In an ABS equipped vehicle, the Brake System Warning light will come on if the ABS light is not functioning or if the ABS system is not communicating.

### SETTING THE ANALOG CLOCK—IF EQUIPPED

To set the analog clock at the top center of the instrument panel, press and hold the plus (+) or minus (-) buttons until the setting is correct.

### ELECTRONIC DIGITAL CLOCK

When the radio is on, pressing the TIME button will allow you to select between displaying actual time continuously or information related to the mode which the radio is in (i.e. in Radio mode, the radio frequency is displayed.)

In the Concorde Limited only, when the radio is off, time will not be displayed unless the TIME button is pressed, and then the time will only be displayed for 5 seconds. This function will operate with the ignition switch in either the on or off positions.

If your vehicle is a Concorde Limited, you can ask your dealer to enable the digital clock to be displayed continuously when the radio is off and the ignition switch is on.

### Clock Setting Procedure

1. Turn the ignition switch to the ON or ACC position. Using the point of a ballpoint pen or similar object, press either the hour (H) or minute (M) buttons on the radio. The display will show TIME.
2. Press the H button to set hours or the M button to set minutes. The time setting will increase each time you press a button.

### SALES CODE RAZ—AM/ FM STEREO RADIO WITH CASSETTE TAPE PLAYER AND CD PLAYER — IF EQUIPPED

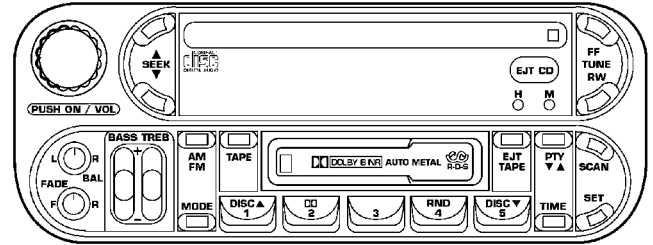

80ef1609

### Operating Instructions — Radio

**NOTE:** Power to operate the radio is controlled by the ignition switch. It must be in the ON or ACC position to operate the radio.

### Power Switch, Volume Control

Press the ON/VOL control to turn the radio on. Turn the volume control clockwise to increase the volume. The volume will be displayed and continuously updated while the button is pressed.

**Seek Button (Radio Mode)**

Press and release the Seek button to search for the next station in either the AM or FM mode. Press the top of the button to seek up and the bottom to seek down. Holding the button will by pass stations until you release the button.

**Tuning**

Press the TUNE control up or down to increase or decrease the frequency. If you press and hold the button, the radio will continue to tune until you release the button. The frequency will be displayed and continuously updated while the button is pressed.

**PTY (Program Type) Button**

Pressing this button once will turn on the PTY mode for 5 seconds. If no action is taken during the 5 second time out the PTY icon will turn off. Pressing the PTY button within 5 seconds will allow the program format type to be selected. Many radio stations do not currently broadcast PTY information.

Toggle the PTY button to select the following format types:

Program Type	Radio Display
Adult Hits	Adlt Hit
Classical	Classicl
Classic Rock	Cls Rock
College	College
Country	Country
Information	Inform
Jazz	Jazz
Foreign Language	Language
News	News
Nostalgia	Nostalga
Oldies	Oldies
Personality	Persnlty
Public	Public
Rhythm and Blues	R & B
Religious Music	Rel Musc
Religious Talk	Rel Talk
Rock	Rock

Program Type	Radio Display
Soft	Soft
Soft Rock	Soft Rck
Soft Rhythm and Blues	Soft R&B
Sports	Sports
Talk	Talk
Top 40	Top 40
Weather	Weather

By pressing the SEEK button when the PTY icon is displayed, the radio will be tuned to the next frequency station with the same selected PTY name. The PTY function only operates when in the FM mode.

The radio display will flash "SEEK" and the selected PTY program type when searching for the next PTY station. If no station is found with the selected PTY program type, the radio will return to the last preset station.

If a preset button is activated while in the PTY (Program Type) mode, the PTY mode will be exited and the radio will tune to the preset station.

Pressing PTY, then SCAN will scan the FM Band and stop at all RDS stations. Each RDS station will be played for a 10 second scan once around the FM Band and stop at the last station. The PTY icon will then turn off.

### Balance

The Balance control adjusts the left-to-right speaker balance. Push in the button and it will pop out. Adjust the balance and push the button back in. The balance will be displayed and continuously updated while the button is pressed.

### Fade

The Fade control provides for balance between the front and rear speakers. Push in the button and it will pop out. Adjust the balance and push the button back in. The fade will be displayed and continuously updated while the button is pressed.

### Tone Control

Slide the Bass and/or Treble controls up or down to adjust the sound for the desired tone. The treble, and bass will be displayed and continuously updated while the slide is moved.

### AM/FM Selection

Press the AM/FM button to change from AM to FM. The operating mode will be displayed next to the station frequency. The display will show ST when a stereo station is received.

### Scan Button

Pressing the SCAN button causes the tuner to search for the next station, in either AM or FM, pausing for 5 seconds at each listenable station before continuing to the next.

Pressing the AM/FM button continues the search in the alternate frequency band.

To stop the search, press SCAN a second time.

### To Set The Radio Push-button Memory

When you are receiving a station that you wish to commit to push-button memory, press the SET button. SET 1 will show in the display window. Select the push-button you wish to lock onto this station and press and release that button. If a station is not selected within 5 seconds after pressing the SET button, the station will continue to play but will not be locked into push-button memory.

You may add a second station to each push-button by repeating the above procedure with this exception: Press the SET button twice and SET 2 will show in the display window. Each button can be set for SET 1 and SET 2 in both AM and FM. This allows a total of 10 AM and 10 FM stations to be locked into memory. You can recall the stations stored in SET 2 memory by pressing the push-button twice.

### To Change From Clock To Radio Mode

Press the Time button to change the display between radio frequency and time.

### Operating Instructions — Tape Player

Insert the cassette with the exposed tape side toward the right and the mechanical action of the player will gently pull the cassette into the play position.

**NOTE:** When subjected to extremely cold temperatures, the tape mechanism may require a few minutes to warm up for proper operation. Sometimes poor playback may be experienced due to a defective cassette tape. Clean and demagnetize the tape heads at least twice a year.

**Seek Button**

Press the SEEK button up for the next selection on the tape and down to return to the beginning of the current selection.

Press the SEEK button up or down to move the track number to skip forward or backward 1 to 6 selections. Press the SEEK button once to move 1 selection, twice to move 2 selections, etc.

**Fast Forward (FF)**

Press the FF button up momentarily to advance the tape in the direction that it is playing. The tape will advance until the button is pressed again or the end of the tape is reached. At the end of the tape, the tape will play in the opposite direction.

**Rewind (RW)**

Press the RW button momentarily to reverse the tape direction. The tape will reverse until the button is pressed again or until the end of the tape is reached. At the end of the tape, the tape will play in the opposite direction.

**Tape Eject**

Press the EJT Tape button and the cassette will disengage and eject from the radio.

**Scan Button**

Press this button to play 10 seconds of each selection. Press the scan button a second time to cancel the feature.

**Changing Tape Direction**

If you wish to change the direction of tape travel (side being played), press the PTY button. The lighted arrow in the display window will show the new direction.

**Metal Tape Selection**

If a standard metal tape is inserted into the player, the player will automatically select the correct equalization and the 70 symbol will appear in the display window.

**Pinch Roller Release**

If ignition power or the radio ON/OFF switch are turned off, the pinch roller will automatically retract to protect the tape from any damage. When power is restored to the tape player, the pinch roller will automatically reengage and the tape will resume play.

### Noise Reduction

The Dolby Noise Reduction System\* is on whenever the tape player is on, but may be switched off.

To turn off the Dolby Noise reduction System: Press the Dolby button (button 2) after you insert the tape. The NR light in the display will go off when the Dolby System is off. The Dolby System is automatically reactivated each time a tape is inserted.

\* "Dolby" noise reduction manufactured under license from Dolby Laboratories Licensing Corporation. Dolby and the double-D symbol are trademarks of Dolby Laboratories Licensing Corporation.

### Operating Instructions — CD Player

**NOTE:** The ignition switch must be in the ON or ACC position and the volume control ON before the CD player will operate.

### Inserting The Compact Disc

The CD player contained within the radio is not a multi-disc changer, and will only accept one CD. Gently insert one CD into the CD player with the CD label facing

up. The CD will automatically be pulled into the CD Player.

If the volume control is ON, the unit will switch from radio to CD mode and begin to play. The display will show the track number and index time in minutes and seconds. Play will begin at the start of track one.

### NOTE:

- You may eject a disc with the radio OFF. The ignition switch must be in the ON or ACC position to insert a disc with the radio OFF.
- If you insert a disc with the ignition ON and the radio OFF, the CD will automatically be pulled into the CD Player and the display will show the time of day. If you insert a disc with the ignition OFF, the display will show the time of day for about 5 seconds, then go out.

### Seek Button

Press the top of the SEEK button for the next selection on the CD. Press the bottom of the button to return to the beginning of the current selection, or return to the beginning of the previous selection if the CD is within the first 10 seconds of the current selection.

### **EJT CD (Eject) Button**

Press this button and the disc will unload and move to the entrance for easy removal. The unit will switch to the radio mode.

If you do not remove the disc within 15 seconds, it will be reloaded. The radio mode will continue to appear.

The disc can be ejected with the radio OFF.

### **FF/TUNE/RW Button**

Press FF (Fast Forward) once and the CD player will begin to fast forward until FF is pressed again or RW or another CD button is pressed. The RW (Reverse) button works in a similar manner.

### **Program Button 4 (Random Play)**

Press this button while the CD is playing to activate Random Play. This feature plays the selections on the compact disc in random order to provide an interesting change of pace.

Press the SEEK button to move to the next randomly selected track.

Press TUNE FF to fast forward through the tracks. Press the FF button a second time to stop the fast forward feature. If TUNE RW is pressed, the current track will reverse to the beginning of the track and begin playing.

Press button 4 a second time to stop Random Play.

### **MODE**

Press the MODE button to select between the tape player, CD player, or satellite radio (if equipped).

To select Satellite Radio (if equipped), press the MODE button until the word SIRIUS appears. The following will be displayed in this order: After three seconds, the current channel name and number will be displayed for five seconds. The current program type and channel number will then be displayed for five seconds. The current channel name and number will then be displayed until an action occurs. A CD or tape may remain in the player while in the Satellite Radio mode.



**Tape CD Button**

Press this button to select between CD player and Tape player.

**Time Button**

Press this button to change the display from elapsed CD playing time to time of day.

**Scan Button**

Press this button to play the first 10 seconds of each track. To stop the scan function, press the button a second time.

**SALES CODE RBB—AM/FM STEREO RADIO WITH CASSETTE TAPE PLAYER AND CD CHANGER CAPABILITY**

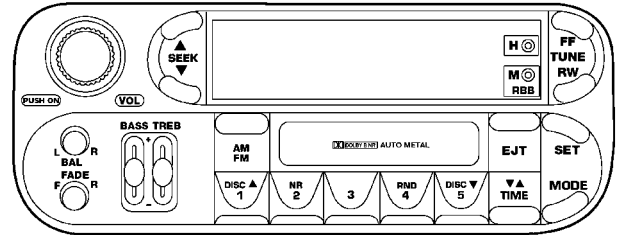

80ef1613

**Operating Instructions**

**NOTE:** Power to operate the radio is supplied through the ignition switch. It must be in the ON or ACC position to operate the radio.

**NOTE:** When first learning the control functions, the user should set the controls as shown in the following list.

Tone Controls...As illustrated.

Speaker Control...Centered.

**Power Button**

The volume control/power button pops out when pressed, this turns the sound system ON in the mode last used. Pushing the button back in turns the sound system OFF.

**Electronic Volume Control**

The electronic volume control turns continuously (360 degrees) in either direction without stopping. Turning the volume control to the right increases the volume and to the left decreases it.

When the audio system is turned on, the sound will be set at the same volume level as last played.

For your convenience, the volume can be turned down, but not up, when the audio system is off and the ignition is ON.

**Seek**

Press and release the SEEK button to search for the next station in either the AM or FM mode. Press the top of the button to seek up and the bottom to seek down. The radio will remain tuned to the new station until you make another selection. Holding the button will bypass stations without stopping until you release it.

**Tune**

Press the TUNE control up or down to increase or decrease the frequency. If the button is pushed and held, the radio will continue to tune until the button is released. The frequency will be displayed and continuously updated while the button is pushed.

**To Set The Push-Button Memory**

When you are receiving a station that you wish to commit to push-button memory, press the SET button. The symbol SET 1 will now show in the display window. Select the "1-5" button you wish to lock onto this station and press and release that button. If a button is not selected within 5 seconds after pressing the SET button, the station will continue to play but will not be locked into push-button memory.

You may add a second station to each push-button by repeating the above procedure with this exception: Press the SET button twice and SET 2 will show in the display window. Each button can be set for SET 1 and SET 2 in both AM and FM. This allows a total of 10 AM and 10 FM

stations to be locked into push-button memory. The stations stored in SET 2 memory can be selected by pressing the push-button twice.

Every time a preset button is used a corresponding button number will be displayed.

### **Balance**

The balance control adjusts the left-to-right speaker balance. Press the BAL button in and it will pop out. Adjust the balance and push the button back in.

### **Fade**

The fade control provides for balance between the front and rear speakers. Press the FADE button in and it will pop out. Adjust the balance and push the button back in.

### **Bass and Treble Tone Control**

The tone controls consist of 2 separate bands. The bass band is on the left, and the treble band is on the right. Each band is adjusted by a slider control with a detent at the mid-position. Moving the control up or down increases or decreases amplification of that band. The mid position provides a flat frequency response.

### **AM/FM Selection**

Press the AM/FM button to change from AM to FM. The operating mode will be displayed next to the station frequency. The display will show ST when a stereo station is received.

### **Mode Button**

Press the MODE button to select between the cassette tape player, CD changer, or the Satellite Radio (if equipped). When the Satellite Radio (if equipped) is selected "SA" will appear in your radio display.

A CD or tape may remain in the player while in the Satellite or radio mode.

### **Cassette Player Features**

With ignition OFF and the sound system OFF, you can eject the tape cassette by pushing the EJECT button.

You can turn the tape player ON by inserting a cassette or activating the MODE button (with a cassette in the radio), but only when the ignition and radio are on.

Each time a cassette is inserted the tape player will begin playing on the side of the cassette that is facing up in the player.

### **Music Search**

Pressing the SEEK button while playing a tape will start the Music Search mode. Press the SEEK button up for the next selection on the tape and down to return to the beginning of the current selection, or return to the beginning of the previous selection if the tape is within the first 5 seconds of the current selection.

The SEEK symbol appears on the display when Music Search is in operation. Music Search shuts off automatically when a selection has been located.

### **Selective Music Search**

Press the SEEK button up or down to move the track number to skip forward or backward 1 to 7 selections. Press the SEEK button once to move 1 selection, twice to move 2 selections, etc.

### **Fast Forward And Rewind Buttons**

Pressing the TUNE button up or down momentarily activates Fast Forward or Rewind and makes the directional arrows appear on the display.

To stop Fast Forward or Rewind, press the TUNE button again.

### **Time Button**

Press the time button to toggle between station frequency and time of day.

Pressing this button while playing a cassette tape will change the side of the tape being played.

### **NR (Noise Reduction)**

Pushing the Number 2 Pre-set button when a tape is playing deactivates the Dolby Noise Reduction System\*. When Dolby is ON, the NR symbol appears on the display. Each time a tape is inserted the Dolby will turn ON.

\* "Dolby" noise reduction manufactured under license from Dolby Laboratories Licensing Corporation. Dolby and the double-D symbol are trademarks of Dolby Laboratories Licensing Corporation.

### **CD Changer Control Capability — If Equipped**

This radio is compatible with a remote mounted CD changer available through Mopar Accessories. The following instructions are for the radio controls that operate this CD changer.

**Mode Button**

To activate the CD changer, press the MODE button until CD information appears on the display.

**Push-Button**

While the CD changer is playing, press the NUMBER 1 push-button or the NUMBER 5 push-button to select a disc numbered higher or lower than the one currently being played.

**Seek Button**

Press the SEEK up or down to select another track on the same disc. A SEEK symbol will appear on the display.

**Fast Forward And Rewind Buttons**

Press and hold the FF button for fast forward. Press and hold the RW button for fast reverse.

The audio output can be heard when fast forward and fast reverse are activated.

**Random Play (RND)**

Press the Random button to play the tracks on the disc in random order for an interesting change of pace.

Random can be cancelled by pressing the button a second time or by ejecting the CD from the changer.

**CD Diagnostic Indicators**

When driving over a very rough road, the CD player may skip momentarily. Skipping will not damage the disc or the player, and play will resume automatically.

As a safeguard and to protect your CD player, one of the following warning symbols may appear on your display.

A CD HOT symbol indicates the player is too hot.

CD HOT will pause the operation. Play can be resumed when the operating temperature is corrected or another MODE is selected.

An ERR symbol will appear on the display if the laser is unable to read the Disc data for the following reasons:

- Excessive vibration
- Disc inserted upside down
- Damaged disc
- Water condensation on optics

### Radio Display Messages

Your radio has been designed to display certain messages when a problem is detected with the CD player.

DISPLAY	EXPLANATION	WHAT TO DO
E-01	Deadlock problem	See your dealer for service
E-02	Disc eject problem	See your dealer for service
E-06	Elevator problem	See your dealer for service
E-07	Magazine eject problem	Check that magazine is OK- if not see your dealer for service
 	<p>No discs in magazine. Load discs in magazine.</p> <p>Player overheating. Allow to cool down.</p>	

605e2ab6

### SALES CODE RBK—AM/ FM STEREO RADIO WITH CD PLAYER AND CD CHANGER CONTROLS

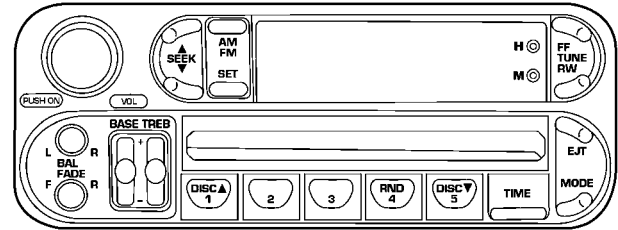

80e571f6

### Radio Operation

#### Power/Volume Control

Press the ON/VOL control to turn the radio on. Turn the volume control clockwise to increase the volume.

**NOTE:** Power to operate the radio is supplied through the ignition switch. It must be in the ON or ACC position to operate the radio.

**Seek**

Press and release the SEEK button to search for the next station in either the AM or FM mode. Press the top of the button to seek up and the bottom to seek down. The radio will remain tuned to the new station until you make another selection. Holding the button in will bypass stations without stopping until you release it.

**Tune**

Press the TUNE control up or down to increase or decrease the frequency. If you press and hold the button, the radio will continue to tune until you release the button. The frequency will be displayed and continuously updated while the button is pressed.

**Balance**

The Balance control adjusts the left-to-right speaker balance. Press the BAL button in and it will pop out. Adjust the balance and push the button back in.

**Fade**

The Fade control provides for balance between the front and rear speakers. Press the FADE button in and it will pop out. Adjust the balance and push the button back in.

**Bass and Treble Tone Control**

The tone controls consist of 2 separate bands. The bass band is on the left, and the treble band is on the right. Each band is adjusted by a slider control with a detent at the mid-position. Moving the control up or down increases or decreases amplification of that band. The mid position provides a flat frequency response.

**AM/FM Selection**

Press the AM/FM button to change from AM to FM. The operating mode will be displayed next to the station frequency. The display will show ST when a stereo station is received.

**To Set The Radio Push-Button Memory**

When you are receiving a station that you wish to commit to push-button memory, press the SET button. SET 1 will show in the display window. Select the "1-5" button you wish to lock onto this station and press and release that button. If a button is not selected within 5 seconds after pressing the SET button, the station will continue to play but will not be locked into push-button memory.

You may add a second station to each push-button by repeating the above procedure with this exception: Press the SET button twice and SET 2 will show in the display window. Each button can be set for SET 1 and SET 2 in both AM and FM. This allows a total of 10 AM and 10 FM stations to be locked into push-button memory. The stations stored in SET 2 memory can be selected by pressing the push-button twice. Every time a preset button is used a corresponding button number will be displayed.

### Time

Press the TIME button to change the display between radio frequency and time.

### General Information

This radio complies with Part 15 of FCC rules and with RSS-210 of Industry Canada. Operation is subject to the following conditions:

1. This device may not cause harmful interference,
2. This device must accept any interference received, including interference that may cause undesired operation.

**NOTE:** Changes or modifications not expressly approved by the party responsible for compliance could void the user's authority to operate the equipment.

### CD Player Operation

**NOTE:** The ignition switch must be in the ON or ACC position and the volume control ON before the CD player will operate.

### Inserting The Compact Disc

#### CAUTION!

**This CD player will accept 4 ¾ inch (12 cm) discs only. The use of other sized discs may damage the CD player mechanism.**

You may either insert or eject a disc with the radio OFF.

If you insert a disc with the ignition ON and the radio OFF, the display will show the time of day.

If the power is ON, the unit will switch from radio to CD mode and begin to play when you insert the disc. The



display will show the track number and index time in minutes and seconds. Play will begin at the start of track one.

### **Seek**

Press the top of the SEEK button for the next selection on the CD. Press the bottom of the button to return to the beginning of the current selection, or return to the beginning of the previous selection if the CD is within the first second of the current selection.

### **EJT — Eject**

Press the EJT button and the disc will unload and move to the entrance for easy removal. The unit will switch to the radio mode.

If you do not remove the disc within 15 seconds, it will be reloaded. The unit will continue in radio mode.

The disc can be ejected with the radio and ignition OFF.

### **FF/TUNE/RW**

Press FF (Fast Forward) and the CD player will begin to fast forward until FF is released. The RW ( Reverse) button works in a similar manner.

### **Random Play — RND/Program Button 4**

Press the RND (button 4) button while the CD is playing to activate Random Play. This feature plays the selections on the compact disc in random order to provide an interesting change of pace.

Press the SEEK button to move to the next randomly selected track.

Press the RND (button 4) button a second time to stop Random Play.

### **Mode**

Press the MODE button repeatedly to select between the CD player, the optional remote CD changer and the Satellite Radio (if equipped). When Satellite Radio (if equipped) is selected "SA" will appear in your radio display.

A CD or tape may remain in the player while in the Satellite mode.

### **Time**

Press the TIME button to change the display from elapsed CD playing time to time of day.

## CD Changer Operation — If Equipped

### MODE

Press the MODE button to select between the cassette tape player, CD player, and the CD changer (if equipped).

### Disc/Program Button 1

Press the DISC (button 1) button to play the next available disc.

### Random Play — RND/Program Button 4

Press the RND (button 4) button while the CD is playing to activate Random Play. This feature plays the selections on the currently playing compact disc in random order to provide an interesting change of pace.

Press the top of the SEEK button to move to the next randomly selected track.

Press the RND (button 4) button a second time to stop Random Play.

### FF/RW — TUNE

Press FF/TUNE/RW to skip through the tracks in the desired direction, until the button is released (it will not

stop at the beginning/end of any track until you release the button).

### Disc/Program Button 5

Press the DISC (button 5) button to play the previous disc.

### Seek

Press the top of the SEEK button for the next selection on the CD. Press the bottom of the button to return to the beginning of the current selection, or return to the beginning of the previous selection if the CD is within the first second of the current selection.

### Time

Press the TIME button to switch between time of day and CD track time.

## 6 DISC CD CHANGER — IF EQUIPPED

The CD changer is located below the radio in the instrument panel. The changer plays only 4 ¾ inch (12 cm) discs. The changer holds up to 6 discs. Each disc is loaded and ejected through a single slot in front of the changer. Each disc has a numbered button with an amber light above it which, when illuminated, indicates that a disc is loaded in that particular chamber.

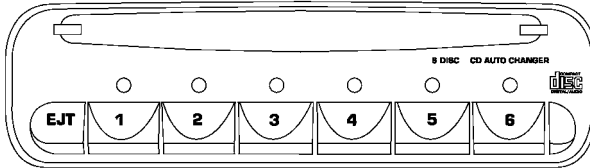

80ef1625

### Loading the CD Changer

When inserting the first CD into the changer if the radio is on, wait until the single slot is illuminated on both sides and simply insert the first disc.

To insert additional CDs into the changer, the instructions follow:

1. Select and press any numbered button without an illuminated light above it.
2. Insert the CD while the light above the chosen button is flashing and the two lights on either side of the slot are illuminated.
3. Upon insertion, the CD will begin to play, and both the button light and the lights in the corner of the loading slot will illuminate.
4. Repeat the process for loading any additional CDs. The CD player will stop while additional CDs are loaded.

### Playing Discs

The radio will show the CD number, the CD track number, and the Track Time Elapsed while the radio is in the CD mode. If more than one CD is loaded in the changer, the changer will automatically play the next disc after playing the last track of the current disc.

**Seek Button**

Press the top of this button on the radio once to play the next track. Press the bottom of the button once to return to the beginning of the current track. Press the bottom of the button twice to play the previous track.

**FF/TUNE/RW**

Press the FF (fast forward) button and the CD player will fast forward through the tracks until the button is released. Press the RW (rewind) button and the CD player will reverse through the tracks until the button is released.

**Mode Button**

Press this button to toggle between radio and cd modes.

**Program Button 1**

Press this button to play the next available disc.

**Program Button 4 (Random Play)**

Press this button while the CD is playing to activate Random Play. This feature plays the selections on the current compact disc in random order to provide an interesting change of pace. The CD changer stays in the random play mode when changing to the next disc.

**NOTE:** The changer will not random play between discs.

Press the top of the Seek button once to move to the next randomly selected track. Press the bottom of the Seek button to go back to the beginning of the track.

Press button 4 a second time to stop random play.

**Program Button 5**

Press this button to play the previous disc.

**Time Button**

Press this button to switch between time of day and CD track time.

**Changing Modes**

While in the radio mode, if a cassette is loaded, press the Mode button to switch to the tape mode. If a CD is loaded, press the Mode button to select the CD mode. If neither a tape nor CD is loaded, the radio will ignore the command.

- Inserting either a tape or CD automatically starts that mode of play.

- Pressing the AM/FM button while in the tape or CD mode will select the radio mode.
- If in the CD mode and the last CD is ejected, the radio will tune to the last station selected.

### Removing Discs from the CD Changer

If there is a single CD in the changer, press the EJT button and the CD will eject. If the CD is not removed within 15 seconds, it will automatically reload into the CD changer. To eject additional CDs from the changer, first select the numbered button where the CD is located and then press the EJT button.

### CD Changer Operation with the Changer Off

The CD changer is able to load and eject discs with the ignition power off. However, while the ignition is off, one of the six numbered buttons must be pressed first.

### REMOTE SOUND SYSTEM CONTROLS — IF EQUIPPED

The remote sound system controls are located on the rear surface of the steering wheel. Reach behind the wheel to access the switches.

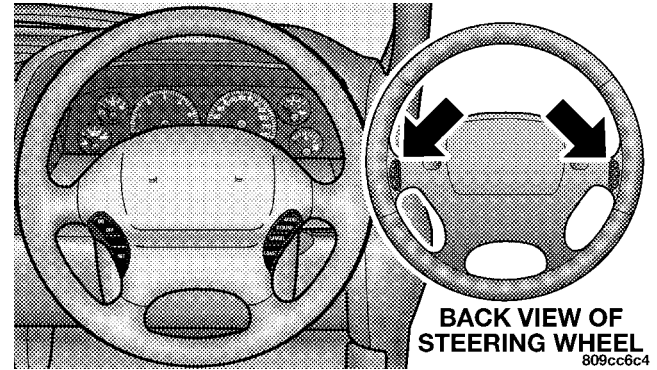

The right hand control is a rocker type switch with a push-button in the center and controls the volume and mode of the sound system. Pressing the top of the rocker switch will increase the volume and pressing the bottom of the rocker switch will decrease the volume.

Pressing the center button will make the radio switch between the various modes available (AM/FM/TAPE/CD, Etc.).

The left hand control is a rocker type switch with a push-button in the center. The function of the left hand control is different depending on which mode you are in.

The following describes the left hand control operation in each mode.

### **Radio Operation**

Pressing the top of the switch will “Seek” up for the next listenable station and pressing the bottom of the switch will “Seek” down for the next listenable station.

The button located in the center of the left hand control will tune to the next preset station that you have programmed in the radio preset push-button.

### **Tape Player**

Pressing the top of the switch once will go to the next selection on the cassette. Pressing the bottom of the switch once will go to the beginning of the current selection or to the beginning of the previous selection if it is within the first 5 seconds of the current selection.

If you press the switch up or down twice it plays the second selection, three times, it will play the third, etc.

The button in the center of the left hand switch has no function in this mode.

### **CD Player — Single Disc in Radio**

Pressing the top of the switch once will go to the next track on the CD. Pressing the bottom of the switch once will go to the beginning of the current track or to the beginning of the previous track if it is within one second after the current track begins to play.

If you press the switch up or down twice it plays the second track, three times, it will play the third, etc.

The button in the center of the left hand switch has no function in this mode.

### **CD Player — 6 Disc CD Changer**

Pressing the top of the switch once will go to the next track on the CD. Pressing the bottom of the switch once will go to the beginning of the current track or to the beginning of the previous track if it is within one second after the current track begins to play.

If you press the switch up or down twice it plays the second track, three times, it will play the third, etc.

The button in the center of the left hand switch will cause the CD changer to play the next available disc.

### **CASSETTE TAPE AND PLAYER MAINTENANCE**

To keep the cassette tapes and player in good condition, take the following precautions:

1. Do not use cassette tapes longer than C-90; otherwise, sound quality and tape durability will be greatly diminished.
2. Keep the cassette tape in its case to protect from slackness and dust when it is not in use.
3. Keep the cassette tape away from direct sunlight, heat and magnetic fields such as the radio speakers.
4. Before inserting a tape, make sure that the label is adhering flatly to the cassette.
5. A loose tape should be corrected before use. To rewind a loose tape, insert the eraser end of a pencil into the tape drive gear and twist the pencil in the required directions.

Maintain your cassette tape player. The head and capstan shaft in the cassette player can pick up dirt or tape deposits each time a cassette is played. The result of deposits on the capstan shaft may cause the tape to wrap around and become lodged in the tape transport. The other adverse condition is low or “muddy” sound from one or both channels, as if the treble tone control were turned all the way down. To prevent this, you should periodically clean the head with a commercially available WET cleaning cassette.

As preventive maintenance, clean the head about every 30 hours of use. If you wait until the head becomes very dirty (noticeably poor sound), it may not be possible to remove all deposits with a simple WET cleaning cassette.

### COMPACT DISC MAINTENANCE

To keep the compact discs in good condition, take the following precautions:

1. Handle the disc by its edge; avoid touching the surface.
2. If the disc is stained, clean the surface with a soft cloth, wiping from center to edge.
3. Do not apply paper or tape to the disc; avoid scratching the disc.
4. Do not use solvents such as benzine, thinner, cleaners, or antistatic sprays.
5. Store the disc in its case after playing.
6. Do not expose the disc to direct sunlight.
7. Do not store the disc where temperatures may become too high.

**NOTE:** If you experience difficulty in playing a particular disc, it may be damaged, oversized, or have theft protection encoding. Try a known good disc before considering disc player service.

### RADIO OPERATION AND CELLULAR PHONES

Under certain conditions, the operation of a cellular phone in your vehicle can cause erratic or noisy performance from your radio. This condition may be lessened or eliminated by relocating the cellular phone antenna. This condition is not harmful to the radio. If your radio performance does not satisfactorily “clear” by the repositioning of the antenna, it is recommended that the radio volume be turned down or off during cellular phone operation.



## CLIMATE CONTROLS

### Manual Air Conditioning/Heater Operation

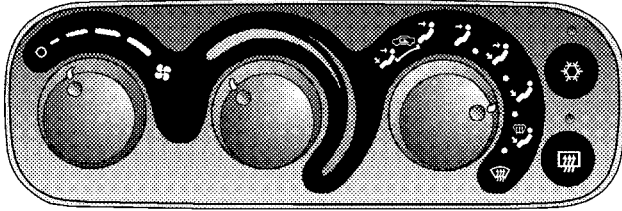

80b2b459

The Air Conditioning System allows you to balance the temperature, amount, and direction of the air circulating throughout the vehicle.

The controls are as follows:

#### Fan Control

 Use this control to regulate the amount of air forced through the system in any mode you select. Turn the control clockwise to increase fan speed. Turn the control

to the O (Off) position to shut off the fan and to prevent any outside air from entering the vehicle. This also turns off the A/C compressor.

#### Temperature Control

Use this control to regulate the temperature of the air inside the passenger compartment. The blue area of the control indicates cooler temperatures while the red area indicates warmer temperatures.

4

#### Mode Control

Use this control to direct the flow of air as follows:

**NOTE:** The dot between the mode control icons is a mix position between the two modes.

#### *Recirculate*

 Air is recirculated inside the vehicle. You may choose between Bi-Level and Panel air outlets while in this mode. Use this mode to temporarily block out any outside odors, smoke, or dust and to cool the interior rapidly upon initial start up in very hot or humid weather.

***Panel Recirculation***

Directs all air through the panel outlets.

***Bi-Level Recirculation***

Directs air through the panel and floor outlets.

**NOTE:** Continuous use of the Recirculate modes may make the inside air stuffy. Use of these modes for longer than fifteen minutes is not recommended.

The A/C compressor turns on automatically when this mode is selected. This is to help reduce moisture build up on the windshield.

***Panel***

 Air is directed through the outlets in the instrument panel. These outlets can be adjusted to direct air flow.

***Bi-Level***

 Air is directed through the instrument panel and floor outlets. A small amount of air is also directed through the defrost outlets.

**NOTE:** There is a varying temperature differential between the upper and lower outlets for added comfort.

The warmer air goes to the floor outlets. This feature provides improved comfort during sunny but cool conditions.

***Floor***

 Air is directed through the floor outlets with a lesser amount through the defrost and side window demist outlets.

***Mix***

 Air is directed through the floor, defrost, and side window demist outlets. This setting works best in cold or snowy conditions that require extra heat at the windshield. This setting is good for maintaining comfort while reducing moisture on the windshield.

***Windshield Defrost***

 Air is directed through the windshield and side window demist outlets. Use this mode with maximum fan and temperature settings for best windshield and side window defrosting.

**NOTE:** The air conditioning compressor operates in this mode. This dehumidifies the air to help dry the windshield. To improve fuel economy, leave in the Defrost mode only when necessary.

**A/C Pushbutton**



With the fan control in the ON position, pushing the A/C button turns on the air conditioning compressor. An indicator light above the button shows that the Air Conditioning compressor is on. Conditioned air is now directed through the outlets selected. Pushing the button a second time turns the compressor OFF.

Slight changes in engine speed or power may be noticed when the compressor is on. This is a normal occurrence since the compressor will cycle on and off to maintain comfort and increase fuel economy.

**NOTE:** If your air conditioning performance seems lower than expected, check the front of the A/C condenser for an accumulation of dirt or insects. Clean with a gentle water spray from behind the radiator and

through the condenser as required. Fabric front fascia protectors may reduce air flow to the condenser, reducing air conditioning performance.

**NOTE:** See Operating Tips chart (for both Manual A/C and ATC systems) at the end of this section for suggested control settings in different weather conditions.

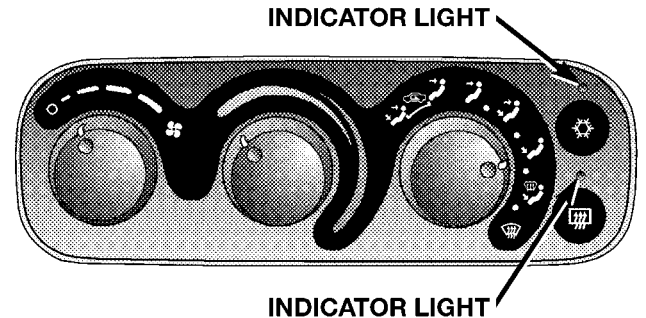

80b8985e

**Rear Window Defroster**



Press the button once to turn on the Rear Window Defroster and a second time to turn it off. A light above the button shows that the Rear Defroster is On.

**NOTE:** The defroster turns off automatically after 15 minutes of operation. Each later activation will allow 7 1/2 minutes of operation.

**CAUTION!**

To avoid damaging the electrical conductors, do not use scrapers, sharp instruments, or abrasive window cleaners on the interior surface of the rear window. Labels can be peeled off by soaking with warm water.

**Automatic Temperature Control (ATC) — If Equipped**

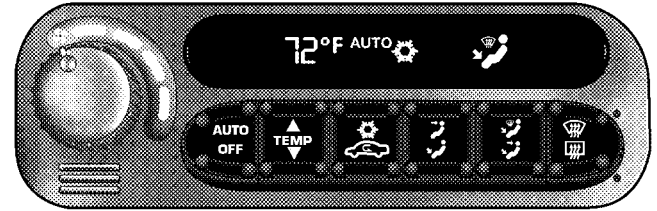

80b8985c

The ATC system can maintain a steady comfort level in various weather conditions with a simple two step operation. Press the AUTO button and select your comfort setting. The system will automatically control comfort by varying temperature, fan speed, and Mode.

You also may choose to customize your comfort by selecting the fan speed and Mode. This will place the system into manual operation

**Interior ATC Sensors**

There are two interior sensors in the vehicle. The Sun Sensor is mounted in the center of the instrument panel

near the windshield glass. The In-Car Temperature Sensor is mounted behind the ATC control panel. These sensors transmit data on sun strength and vehicle interior temperatures to enhance system performance.

### CAUTION!

**Do not cover either sensor with any foreign material as improper operation of the system will result.**

#### Level Of Automatic Control

72°F (22°C) is the recommended setting for maximum comfort for the average person, however, this may vary.

**NOTE:** The temperature setting can be adjusted at any time without affecting automatic control operation.

The control also will show what Mode the system is in by the figure shown in the display.

**NOTE:** The Mode can change when the system is in the Auto Mode. This will be indicated in changes in the display window. This shows automatic changes in air direction.

#### Fan Control

 Use this control to regulate the amount of air forced through the system in any mode you select. Turn the control clockwise to increase fan speed.

In ambient temperatures below 70°F (21°C), fan operation is delayed when the engine is first started. The fan will automatically start when the engine coolant is warm enough to heat the air. This feature can be defeated by turning the fan control.

#### AUTO Control

Press the top of the button to turn the ATC system On. Press the lower portion of the button to turn the entire system Off.

#### Comfort Control

Use this control to regulate the comfort inside the passenger compartment. Press the top of the switch to raise the temperature selection and the bottom of the switch to lower it. The comfort setting range is from Lo, 60, 61,...to 89,90, Hi, for automatic temperature control. You can select a very hot or cold comfort setting by holding the comfort control until it reaches its highest or lowest levels.

The system adjusts to bring the interior temperature to the desired comfort level. All comfort settings are automatic; even Hi and Low.

**NOTE:** You can change the display from U.S. to metric units by pressing the Mix and Panel mode buttons simultaneously or by pressing the English/Metric button on the overhead console.

### Air Conditioning Button



Press this button to turn on the air conditioning compressor. A snowflake symbol in the display shows that the compressor is on. Compressor operation is automatic when you press the Auto button.

The compressor can operate at any temperature above 32°F (0°C).

With the compressor off and the temperature set at Lo, air entering the vehicle will be slightly warmer than the air outside the vehicle.

**NOTE:** The compressor will not engage until the engine has been running for several seconds. Slight changes in

engine speed or power may be noticed when the compressor is on. This is a normal occurrence since the compressor will cycle on and off to maintain comfort and improve fuel economy.

### Recirculate Button



Press this button to recirculate the air inside the vehicle. Outside air is prevented from entering the vehicle. Recirculation is automatically controlled when the system is in Auto Mode. Use this mode to temporarily block out any outside odors, smoke, or dust.

Manual control of Recirculation is possible only in Panel, Floor, and Bi-Level modes. It will not operate in Mix, or Defrost modes.

**NOTE:** The Recirc button light will blink if you try to use it in the Mix or Defrost modes.

### Air Direction Buttons (Mode)

These buttons allow you to select from five air distribution patterns. These buttons should be used only when you can not achieve comfort or visibility in Auto operation. A symbol in the display window will show which mode is operating.

**Panel**

 Air is directed through the outlets in the instrument panel. These outlets can be adjusted to direct air flow. This mode is not recommended when heat is required.

**Floor**

 Air is directed through the floor outlets with a lesser amount through the Defrost and side window demist outlets. This mode is recommended when heat is desired.

**Mix**

 Air is directed through the floor, defrost, and side window demist outlets. Use this setting in cold or snowy conditions that require extra heat at the windshield. This setting is good for maintaining comfort while reducing moisture on the windshield. The compressor is on in this mode.

**Bi-Level**

 Air is directed through both the panel and floor outlets. This mode is not recommended when heat is required in very cold temperatures.

**NOTE:** There is a varying difference in temperature between the upper and lower outlets for added comfort. The warmer air goes to the floor outlets. This feature provides improved comfort during sunny but cool conditions.

**Windshield Defrost**

 Air is directed through the defrost outlets and side window demist outlets. A small amount of air also is directed through the floor outlets. Use this mode with maximum fan and comfort level settings for best windshield and side window defrosting. The defrost symbol will glow in amber to show that the defroster is on.

**NOTE:** The air conditioning compressor is on in this mode. This dehumidifies the air to help dry the windshield. To improve fuel economy, leave in the defrost mode only when necessary.

**Rear Window Defroster**

 Press the button once to turn on the Rear Window Defroster and a second time to turn it off. An indicator light in the control shows that the defroster is on.

**NOTE:** The defroster turns off automatically after 15 minutes of operation. Each later activation will allow 7 1/2 minutes of operation.

### CAUTION!

**To avoid damaging the electrical conductors, do not use scrapers, sharp instruments, or abrasive window cleaners on the interior surface of the rear window. Labels can be peeled off by soaking with warm water.**

### Window Fogging

In mild but rainy or humid weather, your windows may fog up on the inside. You can remove this fog by pressing the Defrost button. The Mix mode can be used to maintain a clear windshield and provide sufficient heating. If side window fogging becomes a problem, increase blower speed. The compressor will remain on during these conditions.

### Hot Weather Automatic Recirculation

The system will automatically recirculate the air inside the vehicle when the interior is very warm. This will provide maximum cooling. The system will also occasionally return to REC on hot, humid days to maintain occupant comfort. See Operating Tips chart (for both Manual A/C and ATC systems) at the end of this section for suggested control settings in different weather conditions.

### Side Window Demisters

Side window demisters are located on the instrument panel. These non adjustable outlets direct air toward the side windows in any mode except Panel or Panel Recirculation. The air is directed toward the area of the side windows through which you view the outside rearview mirrors.





















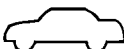

### **Rear Seat Air Outlets**

The center console on vehicles with bucket seats has upper and lower outlets located on the rear of the console.

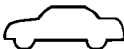
Air is directed through the outlets in all Modes. A control can be used to direct the flow of air to either the upper or lower outlets.

On vehicles with 50/50 bench seats, air is routed under the seats.

Operating Tips (Manual A/C and ATC)

WEATHER	CONTROL SETTINGS
<p>HOT WEATHER AND VEHICLE INTERIOR IS VERY HOT</p>  	<p>Open the windows, start the vehicle, set the Mode control to Panel  or Bi-Level , and turn on A/C. Set the Fan control to the High position (full clockwise). Set the temperature control to full cool. After the hot air is flushed from the vehicle, set the Mode control to Recirculate  with A/C on and roll up the windows. Once you are comfortable, set the Mode control to Panel  or Bi-Level  with A/C on.</p>
<p>WARM WEATHER</p>  	<p>If it's sunny, set the Mode control to Panel  and turn on A/C. If it's cloudy or dark, set the Mode control to Bi-Level  with A/C on. Adjust Temperature control for comfort.</p>
<p>COOL OR COLD HUMID CONDITIONS</p>  	<p>Set the Mode control to Mix  or Defrost . Set the Fan Control to the High position (full clockwise). Adjust Fan and Temperature control for comfort if windows are clear.</p>
<p>COLD DRY CONDITIONS</p>  	<p>Set the Mode control to Floor . If it's sunny, you may want more upper air. In this case, set the Mode control to Bi-Level . In very cold weather, if you need extra heat at the windshield, set the Mode control to Mix  or Defrost  as needed. Adjust Fan and Temperature control for comfort.</p>

81087f0c

### **Outside Air Intake**

Make sure that the air intake directly in front of the windshield is free of obstructions. Leaves, snow, etc., could block air flow into the vehicle.



# STARTING AND OPERATING

## CONTENTS

■ Starting Procedures . . . . .	151	■ Parking Brake . . . . .	156
□ Normal Starting . . . . .	151	■ Brake System . . . . .	157
□ Extremely Cold Weather (Below -20°F Or -29°C) . . . . .	151	□ Anti-Lock Brake System (ABS) — If Equipped . . . . .	157
□ If Engine Fails To Start . . . . .	152	■ Power Steering . . . . .	158
□ After Starting . . . . .	153	■ Speed Proportional Steering . . . . .	158
■ Engine Block Heater — Optional U.S. And Standard Canada . . . . .	153	■ Traction Control— If Equipped . . . . .	159
■ Automatic Transaxle . . . . .	153	■ Tires . . . . .	159
□ Brake/Transmission Interlock . . . . .	153	□ Tire Inflation Pressures . . . . .	161
□ Transaxle Reset Mode . . . . .	154	□ High Speed Operation . . . . .	161
□ Gear Ranges . . . . .	154	□ Radial-Ply Tires . . . . .	162
		□ Compact Spare Tire . . . . .	162

**150 STARTING AND OPERATING**

□ Tire Spinning . . . . .	163	□ MMT In Gasoline . . . . .	169
□ Tire Chains . . . . .	163	□ Materials Added To Fuel . . . . .	169
□ Snow Tires . . . . .	164	□ Sulfur In Gasoline . . . . .	169
□ Tread Wear Indicators . . . . .	164	■ Adding Fuel . . . . .	170
□ Replacement Tires . . . . .	165	□ Fuel Filler Cap (Gas Cap) . . . . .	171
□ Tire Rotation Recommendations . . . . .	166	■ Vehicle Loading . . . . .	171
□ Alignment And Balance . . . . .	167	□ Luggage Racks . . . . .	172
■ Fuel Requirements . . . . .	167	■ Trailer Towing . . . . .	172
□ Reformulated Gasoline . . . . .	168	□ Warranty Requirements . . . . .	172
□ Gasoline/Oxygenate Blends . . . . .	168		

## STARTING PROCEDURES

### WARNING!

Do not leave children or animals inside parked vehicles in hot weather. Interior heat build up may cause serious injury or death.

The gear selector must be in the NEUTRAL or PARK position before you can start the engine. Apply the brakes before shifting to any driving gear.

### Normal Starting

Normal Starting of either a cold or a warm engine does not require pumping or depressing the accelerator pedal. Simply turn the key to the "START" position and release when the engine starts. If the engine has not started within 3 seconds, slightly depress the accelerator pedal while continuing to crank. If the engine fails to start within 15 seconds, turn the key to the "OFF" position, wait 10 to 15 seconds, then repeat the normal starting procedure.

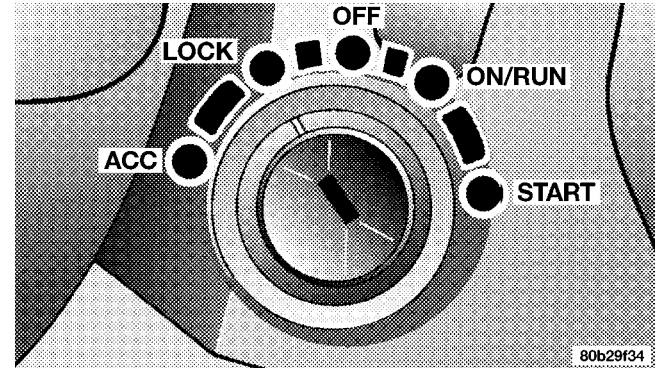

5

### Extremely Cold Weather (below -20°F or -29°C)

For reliable starting at these temperatures, use externally powered battery and electric engine block heaters that are available from your dealer.

### If Engine Fails To Start

**CAUTION!**

Do not try to push or tow your vehicle to get it started. Your vehicle cannot be started this way. Pushing with another vehicle may damage the trans-axle or the rear of your vehicle. See Section 6 of this manual for the proper jump starting procedures.

**WARNING!**

Never pour fuel or other flammable liquid into the throttle body air inlet opening in an attempt to start the vehicle. This could result in flash fire causing serious personal injury.

If the engine fails to start after following the Normal Starting procedure, it may be flooded. Push the accelerator pedal all the way to the floor and hold it there while cranking the engine. This should clear any excess fuel in case the engine is flooded.

**CAUTION!**

To prevent damage to the starter, do not crank the engine for more than 15 seconds at a time. Wait 10 to 15 seconds before trying again.

If the engine has been flooded, it may start to run, but not have enough power to continue running when the key is released. If this occurs, continue cranking with the accelerator pedal pushed all the way to the floor. Release the accelerator pedal and the key once the engine is running smoothly.

If the engine shows no sign of starting after two 15 second periods of cranking with the accelerator pedal held to the floor, the Normal Starting procedure should be repeated.



### After Starting

The idle speed will automatically decrease as the engine warms up.

### ENGINE BLOCK HEATER — Optional U.S. and Standard Canada

These heaters use a common power cord which is stored under the hood, behind the Air Cleaner housing. Plug the cord into any 110 volt AC outlet and both heaters will be energized. Use the heaters when temperatures below 0°F (-18°C) are expected to last for several days.

### AUTOMATIC TRANSAXLE

#### Brake/Transmission Interlock

This interlock system prevents you from moving the gear selector out of the Park position unless the brake pedal is pressed. This system is active only while the key is in the RUN position.

### CAUTION!

Damage to the transaxle may occur if the following precautions are not observed:

- Shift into PARK only after the vehicle has come to a complete stop.
- Shift into or out of REVERSE only after the vehicle has come to a complete stop and the engine is at idle speed.
- Do not shift from REVERSE, PARK or NEUTRAL into any forward gear when the engine is above idle speed.
- Before shifting into any gear, make sure your foot is firmly on the brake pedal.

The electronically controlled transaxle provides a precise shift schedule. The transaxle electronics are self-calibrating. Therefore, the first few shifts on a new vehicle may be somewhat abrupt. This is a normal condition, and precision shifts will develop within a few shift cycles.

### Transaxle Reset Mode

The transaxle is monitored for abnormal conditions. If a condition is detected that could cause damage, the transaxle automatically shifts into second gear. The transaxle remains in second gear despite the forward gear selected. Park (P), Reverse (R), and Neutral (N) will continue to operate. This Reset feature allows the vehicle to be driven to a dealer for service without damaging the transaxle.

If the problem has been momentary, the transaxle can be reset to regain all forward gears.

- Stop the vehicle and shift into PARK (P).
- Turn the key to OFF then start the engine.
- Shift into “D” and resume driving.

**NOTE:** Even if the transaxle can be reset, we recommend that you visit a dealer at your earliest possible convenience. Your dealer has diagnostic equipment to determine if the problem could recur.

If the transaxle cannot be reset, dealer service is required.

### Gear Ranges

#### “P” Park

**NOTE:** If the key is in the RUN position, you must press the brake pedal to shift out of the “P” Park position.

Supplements the parking brake by locking the transaxle. Engine can be started in this range. Never attempt to use PARK while vehicle is in motion.

Apply parking brake when leaving vehicle in this range.

#### **WARNING!**

**Your vehicle could move and injure you and others if it is not completely in Park (P). Check by trying to move the gearshift lever back and forth without depressing the shift button after you have set it in P. Make sure it is in Park before leaving the vehicle.**

**WARNING!**

Never use the Park position as a substitute for the parking brake. Always apply the parking brake fully when parked to guard against vehicle movement and possible injury or damage.

**“R” Reverse**

Shift into this range only after the vehicle has come to a complete stop.

**“N” Neutral**

The engine may be started in this range. Use this range for starting your vehicle if it is moving or is being towed.

**Overdrive**

This range should be used for most city and highway driving. It provides smoothest up shifts and down shifts and best fuel economy.

When frequent transaxle shifting occurs when using the Overdrive range, such as when operating the vehicle

under heavy loading conditions (in hilly terrain, traveling into strong head winds, or while towing heavy trailers, use the “3” range).

**“3” Drive**

This range eliminates shifts into Overdrive. The transaxle will operate normally in first and second while in this range.

A delayed shift from second to third will occur at speeds of about 31 to 38 mph (50 to 60 km/h) and low levels of accelerator pedal travel. An early down-shift from third to second will occur at a speed of about 34 to 30 mph (54 to 48 km/h). This is done to provide second gear engine braking at speeds less than 30 mph (48 km/h).

**NOTE:** Using the “3” range while operating the vehicle under heavy operating conditions will improve performance, fuel economy, and extend transaxle life by reducing excessive shifting and heat build up.

Use the “3” range when descending steep grades to prevent brake system distress.

**“L” Low**

This range should be used for maximum engine braking when descending steep grades. In this range, up-shifts will occur only to prevent engine over speed while down shifts occur as early as possible.

**PARKING BRAKE**

When the parking brake is applied with the ignition on, the red Brake light in the instrument cluster will come on.

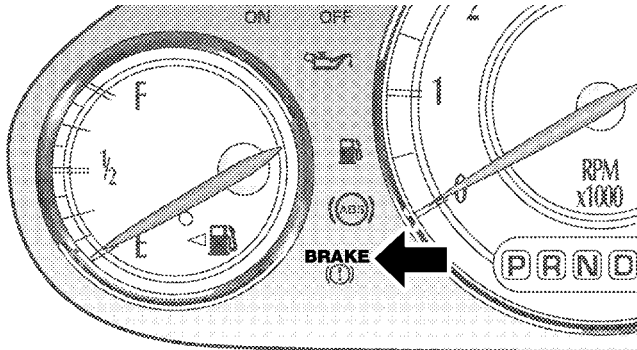

**NOTE:** This light only shows that the parking brake is applied. It does not show the degree of brake application.

Before leaving the vehicle, make sure that the parking brake is fully applied and place the gear selector in the Park position.

To release the parking brake, pull the release lever located on the lower edge of the instrument panel.

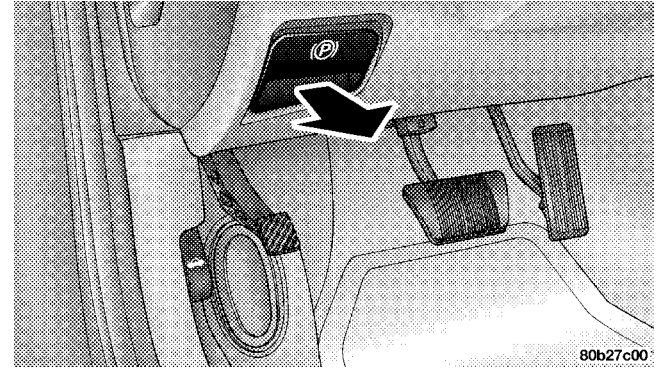

When parking on a hill, you must set the parking brake **before** placing the gear selector in Park. If you don't, the load on the transmission locking mechanism may make it difficult to move the selector out of Park. As an added

precaution, turn the front wheels toward the curb on a downhill grade and away from the curb on an uphill grade.

The parking brake should always be applied when the driver is not in the vehicle.

### WARNING!

- **Leaving children in a vehicle unattended is dangerous for several reasons. A child or others could be injured. Children should be warned not to touch the parking brake or the gear selector. Don't leave the keys in the ignition. A child could operate power windows, other controls, or move the vehicle.**
- **Be sure the parking brake is fully disengaged before driving; failure to do so can lead to brake failure and an accident.**

## BRAKE SYSTEM

Your vehicle is equipped with power brakes as standard equipment. In the event you lose power assist for any reason (for example, repeated brake applications with the engine off), the brakes will still function. The effort required to brake the vehicle will be substantially increased over that required with the power system operating.

If either of the two hydraulic systems lose normal capability, the remaining system will still function with some loss of overall braking effectiveness. This will be evident by increased pedal travel during application, greater pedal force required to slow or stop, and activation of the Brake Warning Lamp during brake use.

### Anti-Lock Brake System (ABS) — If Equipped

The ABS gives increased vehicle stability and brake performance under most braking conditions. The system automatically “pumps” the brakes during severe braking conditions to prevent wheel lock-up.

All vehicle wheels and tires must be the same size and tires must be properly inflated to produce accurate

signals for the ABS computer. However, the system will compensate when the compact spare is in use.

During stops where ABS is activated, a vibration of the brake pedal may be felt and associated system noises may be heard.

**WARNING!**

**Pumping of the brake pedal will diminish the effectiveness of Anti-lock brakes and may lead to an accident. Pumping makes the stopping distance longer. Just press firmly on your brake pedal when you need to slow down or stop.**

**POWER STEERING**

Your vehicle is equipped with power assisted steering as standard equipment. The power assisted steering system of your vehicle provides mechanical steering capability in the event power assist is lost.

If for some reason the hydraulic pressure is interrupted, it will still be possible to steer your vehicle. Under these conditions you will observe a substantial increase in steering effort.

**SPEED PROPORTIONAL STEERING**

This feature automatically adjusts steering effort based on vehicle speed. At slower speeds, the system provides more power assist as an aid in parking. At higher speeds, less power assist is provided and steering effort is increased to aid in high speed handling.

### TRACTION CONTROL— IF EQUIPPED

The Traction Control System reduces wheel slip and maintains traction at the driving (front) wheels. The system reduces wheel slip by engaging the brake on the wheel that is losing traction while spinning. The traction system operates at speeds below 35 mph (56 km/h).

The system is always in the “stand by” mode unless:

- The Traction Control switch has been used to turn the system off;
- There is a Anti-Lock Brake System malfunction;
- There is a Traction Control System malfunction;
- The system has been deactivated to prevent damage to the brake system due to overheated brake temperatures.

**NOTE:** Extended heavy use of Traction Control may cause the system to deactivate and turn on the Traction Control OFF Light, indicated by **TRAC OFF** , located in the instrument cluster.

This is to prevent overheating of the brake system and is a normal condition. After cooling, the system will automatically reactivate and turn off the **TRAC OFF** light.

If your vehicle becomes stuck in mud, ice, or snow, turn the Traction Control System Off before attempting to “rock” the vehicle free.

### TIRES

Proper tire inflation pressure is essential to the safe and satisfactory operation of your vehicle. Three primary areas are affected by improper tire pressure:

### 1. *Safety*—

#### WARNING!

- **Improperly inflated tires are dangerous and can cause accidents.**
- **Under inflation increases tire flexing and can result in tire failure.**
- **Over inflation reduces a tire's ability to cushion shock. Objects on the road and chuck holes can cause damage that results in tire failure.**
- **Unequal tire pressures can cause steering problems. You could lose control of your vehicle.**
- **Overinflated or under inflated tires can affect vehicle handling and can fail suddenly, resulting in loss of vehicle control.**
- **Always drive with each tire inflated to the recommended pressure.**

### 2. *Economy*—

Improper inflation pressures can cause uneven wear patterns to develop across the tire tread. These abnormal wear patterns will reduce tread life resulting in a need for earlier tire replacement. Under inflation also increases tire rolling resistance and results in higher fuel consumption.

### 3. *Ride Comfort and Vehicle Stability*—

Proper tire inflation contributes to a comfortable ride. Over inflation produces a jarring and uncomfortable ride. Both under-inflation and over inflation affect the stability of the vehicle and can produce a feeling of sluggish response or over-responsiveness in the steering.

Unequal tire pressures can cause erratic and unpredictable steering response.

Unequal tire pressure from side to side may cause the vehicle to drift left or right.



### Tire Inflation Pressures

The proper tire pressure for your vehicle is listed on a label attached to the rear face of the driver's door. The pressure should be checked and adjusted at least once every month. Check more often if subject to a wide range of outdoor temperatures, as tire pressures vary with temperature changes.

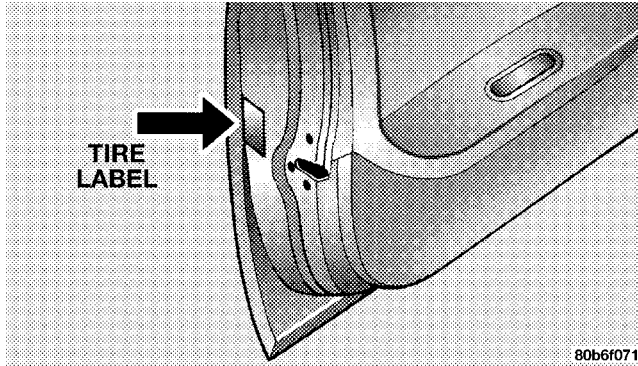

Inflation pressures specified on the label are always “cold inflation pressure”. Cold inflation pressure is defined as the tire pressure after the vehicle has not been driven for at least 3 hours, or driven less than a mile after a 3 hour

period. The cold inflation pressure must not exceed the maximum values molded into the tire side wall.

Tire pressure may increase from 2 to 6 psi [.13 to .41 bars](13 to 40 kPa) during operation. Do NOT reduce this normal pressure build up or your tire pressure will be too low.

The tire pressures shown on the tire label apply only to the tire sizes listed on the label.

### High Speed Operation

The manufacturer advocates driving at safe speeds within posted speed limits. Where speed limits or conditions are such that the vehicle can be driven at high speeds, correct tire inflation pressure is very important.

**WARNING!**

High speed driving with your vehicle under load is dangerous. The added strain on your tires could cause them to fail. You could have a serious accident. Don't drive a vehicle loaded to the maximum capacity at continuous speeds above 75 mph (120 km/h).

**Radial-Ply Tires****WARNING!**

Combining radial ply tires with other tires on your vehicle will cause your vehicle to handle poorly. The instability could cause an accident. Always use radial tires in sets of four. Never combine them with other types of tires.

Cuts and punctures in radial tires are repairable only in the tread area because of sidewall flexing. Consult your tire dealer for radial tire repairs.

**Compact Spare Tire**

Maintain the compact spare tire inflation pressure at 60 psi [4.1 bars](414 kPa). Do not exceed 50 mph (80 km/h) while the compact spare is installed on the vehicle.

Do not install a wheel cover or attempt to mount a conventional tire on the compact spare wheel, since the wheel is designed specifically for the compact spare.

**Because of the reduced ground clearance, do not take your vehicle through an automatic car wash with the compact spare installed.**

**WARNING!**

Temporary-use spare tires are for emergency use only. With the compact spare tire assembly installed on your vehicle, do not exceed 50 mph (80 km/h). Vehicle handling and braking performance will be reduced. Also, do not drive more than 50 mph (80 km) with the compact spare installed. Failure to follow compact spare tire warning may result in an accident and/or fatal injury. Temporary-use spare tires have a total tread life of 2,000 miles (3 200 km). Be sure to follow the warnings, which apply to your spare. Failure to do so could result in spare tire failure and loss of vehicle control.

**Tire Spinning**

When stuck in mud, sand, snow, or ice conditions, do not spin your vehicle's wheels above 30 mph. (48 km/h).

See the paragraph on Freeing A Stuck Vehicle in section 6 of this manual.

**WARNING!**

Fast spinning tires can be dangerous. Forces generated by excessive wheel speeds may cause tire damage or failure. A tire could explode and injure someone. Do not spin your vehicle's wheels faster than 30 mph (48 km/h) when you are stuck. And don't let anyone near a spinning wheel, no matter what the speed.

**5****Tire Chains**

Due to limited clearance, tire chains are not recommended.

**CAUTION!**

Damage to the vehicle may result if tire chains are used.

### Snow Tires

Some areas of the country require the use of snow tires during winter. Standard tires are of the all season type and satisfy this requirement as indicated by the M+S designation on the tire sidewall.

If you need snow tires, see the tire pressure label for size(s) and inflation pressure(s).

Snow tires may have a lower speed rating than factory equipped tires and may not match the maximum vehicle speed.

Snow tires should not be operated at sustained speeds over 75 mph (120 km/h).

### Tread Wear Indicators

Tread wear indicators are in the original equipment tires to help you in determining when your tires should be replaced.

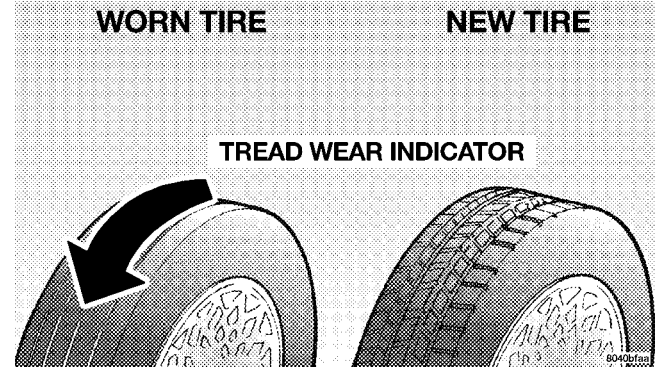

These indicators are molded into the bottom of the tread grooves and will appear as bands when the tread depth becomes 1/16 inch (2 mm). When the indicators appear in 2 or more adjacent grooves, the tire should be replaced.

Many states have laws requiring tire replacement at this point.

## Replacement Tires

The tires on your new vehicle provide a balance of many characteristics. They should be inspected regularly for wear and correct inflation pressure. The manufacturer strongly recommends that you use tires equivalent to the originals in size, quality and performance when replacement is needed (see the paragraph on tread wear indicators). Failure to use equivalent replacement tires may adversely affect the safety, handling, and ride of your vehicle. We recommend that you contact your original equipment dealer on any questions you may have on tire specifications or capability.

### WARNING!

- Do not use a tire, wheel size or rating other than that specified for your vehicle. Some combinations of unapproved tires and wheels may change suspension dimensions and performance characteristics, resulting in changes to steering, handling, and braking of your vehicle. This can cause unpredictable handling and stress to steering and suspension components. You could lose control and have an accident resulting in serious injury or death. Use only the tire and wheel sizes with load ratings approved for your vehicle.
- Never use a tire smaller than the minimum tire size listed on your vehicle's tire label located on the driver's door. Using a smaller tire could result in tire overloading and failure. You could lose control and have an accident.
- Failure to equip your vehicle with tires having adequate speed capability can result in sudden tire failure and loss of vehicle control.
- Overloading your tires is dangerous. Like under inflation, overloading can cause tire failure. Use tires of the recommended load capacity for your vehicle and never overload them.

**CAUTION!**

Replacing original tires with tires of a different size may result in false speedometer and odometer readings. Check with your dealer before replacing tires with a different size.

**Tire Rotation Recommendations**

Tires on the front and rear axles of vehicles operate at different loads and perform different steering, driving and braking functions. For these reasons, they wear at unequal rates, and tend to develop irregular wear patterns.

These effects can be reduced by timely rotation of tires. The benefits of rotation are especially worthwhile with aggressive tread designs such as those on all season type tires. Rotation will increase tread life, help to maintain mud, snow and wet traction levels, and contribute to a smooth, quiet ride.

Rotate your tires at intervals shown on the maintenance schedules. More frequent rotation is permissible if desired. The reasons for any rapid or unusual wear should be corrected before rotating.

**TIRE ROTATION PATTERN**

← FRONT OF VEHICLE

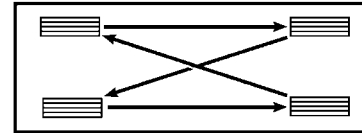
**4 TIRE ROTATION**

80ba79fe

The suggested rotation method is the “forward-cross” shown in the diagram.

## Alignment And Balance

The suspension components of your vehicle should be inspected and aligned when needed to obtain full tire tread mileage.

Poor suspension alignment may result in:

- fast tire wear;
- uneven tire wear, such as feathering and one-sided wear;
- vehicle pull to right or left.

Tires may also cause vehicle to pull to the left or right. Alignment will not correct this condition. See your dealer for proper diagnosis.

Improper alignment will not cause vehicle vibration. Vehicle vibration may be a result of tire and wheel out-of-balance. Proper balancing will reduce vibration and avoid tire cupping and spotty wear.

## FUEL REQUIREMENTS



Your engine is designed to meet all emissions regulations and provide satisfactory fuel economy and performance when using high quality unleaded gasoline having an octane range of 87 to 89 or higher. The manufacturer recommends the use of 89 octane for optimum performance.

Light spark knock at low engine speeds is not harmful to your engine. However, continued heavy spark knock at high speeds can cause damage and should be reported to your dealer immediately. Engine damage resulting from operating with a heavy spark knock may not be covered by the new vehicle warranty.

Poor quality gasoline can cause problems such as hard starting, stalling and stumble. If you experience these problems, try another brand of gasoline before considering service for the vehicle.

Over 40 automobile manufacturers around the world have issued and endorsed consistent gasoline specifications (the World Wide Fuel Charter, WWFC) to define fuel properties necessary to deliver enhanced emissions, engine performance, and durability for your vehicle. The manufacturer recommends the use of gasolines that meet the WWFC specifications if they are available.

### Reformulated Gasoline

Many areas of the country require the use of cleaner burning fuel referred to as “Reformulated Gasoline”.

Reformulated gasolines contain oxygenates, and are specially blended to reduce vehicle emissions and improve air quality.

The manufacturer supports the use of reformulated gasolines. Properly blended reformulated gasolines will provide excellent performance and durability of engine and fuel system components.

### Gasoline/Oxygenate Blends

Some fuel suppliers blend unleaded gasoline with materials called oxygenates such as 10% ethanol, MTBE and ETBE. Oxygenates are required in some areas of the country during the winter months to reduce carbon monoxide emissions. Fuels blended with these oxygenates may be used in your vehicle.

#### CAUTION!

**DO NOT use gasolines containing Methanol. Use of these blends may result in starting and driveability problems and may damage critical fuel system components.**

Problems that result from using methanol/gasoline blends are not the responsibility of the manufacturer and may not be covered by the vehicle warranty. While MTBE is an oxygenate made from Methanol, it does not have the negative effects of Methanol.



### MMT in Gasoline

MMT is a manganese containing metallic additive that is blended into some gasoline to increase the octane number. Gasolines blended with MMT offer no performance advantage beyond gasolines of the same octane number without MMT. Gasolines blended with MMT have shown to reduce spark plug life and reduce emission system performance in some vehicles. The manufacturer recommends using gasolines without MMT. Since the MMT content of gasoline may not be indicated on the pump, you should ask your gasoline retailer whether or not his/her gasoline contains MMT.

MMT is prohibited in both Federal and California reformulated gasolines.

In Canada, MMT can be used at levels higher than those allowed in the United States. For this reason, it is even more important to look for gasolines without MMT in Canada.

### Materials Added to Fuel

All gasoline sold in the United States is required to contain effective detergent additives. Use of additional detergents or other additives is not needed under normal conditions and would result in unnecessary cost. Therefore, you should not have to add anything to the fuel.

### Sulfur in Gasoline

If you live in the Northeast United States, your vehicle may have been designed to meet California low emission standards with cleaner burning California reformulated gasoline with low sulfur. If such fuels are not available in states adopting California emission standards, your vehicle will operate satisfactorily on fuels meeting Federal specifications, but emission control system performance may be adversely affected.

Gasoline sold outside of California is permitted to have higher sulfur levels which may affect the performance of the vehicle's catalytic converter. This may cause the Malfunction Indicator Light to illuminate. The manufacturer recommends that you try a different brand of

unleaded gasoline having lower sulfur to determine if the problem is fuel related prior to returning your vehicle to an authorized dealer for service.

**CAUTION!**

**If the Malfunction Indicator Light is flashing, immediate service is required. See the On Board Diagnostics paragraph in the Maintenance section of this manual.**

**Adding Fuel**

**NOTE:** The fuel tank filler tube has a restricting door about 2 inches (50 mm) down from the opening. If fuel is poured from a portable container, the container should have a flexible nozzle long enough to force open the restricting door.

**CAUTION!**

**To avoid fuel spillage and overfilling, do not “top off” the fuel tank after filling.**

**NOTE:** When the fuel nozzle “clicks” or shuts off, the fuel tank is full.

**NOTE:** Tighten the gas cap until you hear a “clicking” sound. This is an indication that the gas cap is properly tightened.

The Malfunction Indicator light will come on if the gas cap is not properly secured. Make sure that the gas cap is tightened each time the vehicle is refueled.

**WARNING!**

**A fire may result if gasoline is pumped into a portable container that is inside of a vehicle. You could be burned. Always place gas containers on the ground while filling.**

### Fuel Filler Cap (Gas Cap)

The gas cap is behind the fuel filler door, on the driver's side of the vehicle. If the gas cap is lost or damaged, be sure the replacement cap is for use with this vehicle.

#### CAUTION!

Damage to the fuel system or emission control system could result from using an improper fuel tank filler tube cap (gas cap). A poorly fitting cap could let impurities into the fuel system. The Malfunction Indicator light will come on if the gas cap is not properly secured.

#### WARNING!

- Never have any smoking materials lit in or near the vehicle when the gas cap is removed or the tank filled.
- Never add fuel to the vehicle when the engine is running.

### VEHICLE LOADING

The load carrying capacity of your vehicle is shown in the following sample chart and on the tire pressure label attached to the driver's door.

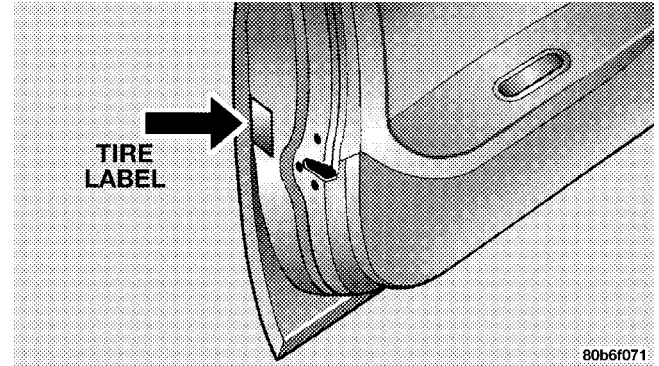

5

#### Vehicle Loading Capacities

Front Seat Occupants . . . . .	2 or 3
Rear Seat Occupants . . . . .	3
Luggage . . . . .	115 lbs. (52 kg)
Rated Vehicle Capacity . . . . .	865 lbs. (392 kg)

### Luggage Racks

External racks do not increase the total load carrying capacity of the vehicle. Be sure the total occupant and luggage load inside the vehicle, plus that on the external rack, do not exceed the rated vehicle capacity shown on the Vehicle Loading Capacity chart.

### TRAILER TOWING

#### Warranty Requirements

The Manufacturer's Passenger Vehicle Warranty will apply to vehicles used to tow trailers for non commercial use. However the following conditions must be met:

- The maximum frontal area of the trailer cannot exceed 32 square feet (2.97 square meters)
- The maximum trailer load for vehicles equipped with 2.7L engines is 1500 lbs. (680 kg.).
- The maximum trailer load for vehicles equipped with 3.5L engines is 2000 lbs. (900 kg.).

- For vehicles equipped with 2.7L engines: when driving in hot weather (more than 95°F, 35°C), maximum vehicle speed when towing a trailer should not exceed 65 mph (105 km/h).
- The "D" range can be selected when towing. However, if frequent shifting occurs while in this range, the "3" range MUST be selected.

**NOTE:** Using the "3" range while operating the vehicle under heavy operating conditions will improve performance and extend transaxle life by reducing excessive shifting and heat build up.

- The trailer tongue load must be considered as part of the tow vehicle load capacity when loading the vehicle.
- If the trailer weighs more than 1,000 lbs. (450 kg), it should have its own brakes.

**WARNING!**

**Connecting trailer brakes to your vehicle's hydraulic brake lines can overload your brake system and cause it to fail. You might not have brakes when you need them and could have an accident.**

- Whenever you pull a trailer, regardless of the trailer size, stop lights and turn signals on the trailer are recommended for motoring safety.
- The automatic transmission fluid, filter, and hypoid differential fluid should be changed per Maintenance Schedule "B" if you tow a trailer.
- If your Engine Coolant Light comes on, see the paragraph on Overheating in Section 6 of this manual.

**NOTE:** Check the automatic transmission fluid level before all towing. Fluid discoloration, or a burnt odor, shows the need for a transmission fluid and filter change.



---

# WHAT TO DO IN EMERGENCIES

## CONTENTS

---

■ Hazard Warning Flasher . . . . .	176	■ Jump-Starting The Battery . . . . .	182
■ If Your Engine Overheats . . . . .	176	■ Driving On Slippery Surfaces . . . . .	185
■ Jacking And Tire Changing . . . . .	177	□ Acceleration . . . . .	185
□ Preparations For Jacking . . . . .	178	□ Traction . . . . .	185
□ Jacking And Changing a Tire . . . . .	178	■ Freeing A Stuck Vehicle . . . . .	186
□ Compact Spare Tire-For Temporary Emergency Use Only . . . . .	181	■ Towing A Disabled Vehicle . . . . .	186
□ Wheel Cover Installation (If Required) . . . . .	182		

**HAZARD WARNING FLASHER**

 The flasher switch is on the steering column, just behind the steering wheel. Push in the flasher switch and all front and rear directional signals will flash. Press the flasher switch a second time to turn the flashers off.

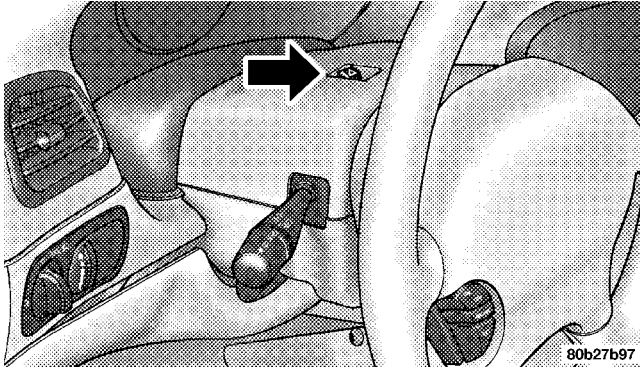

Do not use this emergency warning system when the vehicle is in motion. Use it when your vehicle is disabled and is creating a safety hazard for other motorists.

If it is necessary to leave the vehicle to go for service, the flasher system will continue to operate with the ignition key removed and the vehicle locked.

**NOTE:** With extended use, the flasher may run down your battery.

**IF YOUR ENGINE OVERHEATS**

In any of the following situations, you can reduce the potential for overheating by taking the appropriate action.

- On the highways — Slow down.
- In city traffic — While stopped, put transaxle in neutral, but do not increase engine idle speed.

**NOTE:** There are steps that you can take to slow down an impending overheat condition. If your air conditioner is on, turn it off. The air conditioning system adds heat to the engine cooling system and turning off the A/C removes this heat. You can also turn the Temperature control to maximum heat, the Mode control to floor, and



the fan control to High. This allows the heater core to act as a supplement to the radiator and aids in removing heat from the engine cooling system.

### CAUTION!

Driving with a hot cooling system could damage your vehicle. If temperature gauge reads "H", pull over and stop the vehicle. Idle the vehicle with the air conditioner turned off until the pointer drops back into the normal range. If the pointer remains on the "H", turn the engine off immediately, and call for service.

### WARNING!

A hot engine cooling system is dangerous. You or others could be badly burned by steam or boiling coolant. You may want to call a service center if your vehicle overheats. If you decide to look under the hood yourself, see Section 7, Maintenance, of this manual. Follow the warnings under the Cooling System Pressure Cap paragraph.

## JACKING AND TIRE CHANGING

**6**

### WARNING!

Getting under a jacked-up vehicle is dangerous. The vehicle could slip off the jack and fall on you. You could be crushed. Never get any part of your body under a vehicle that is on a jack. Never start or run the engine while the vehicle is on a jack. If you need to get under a raised vehicle, take it to a service center where it can be raised on a lift.

### Preparations For Jacking

- Turn on the Hazard Warning Flashers and park the vehicle on a firm level surface, avoiding ice or slippery areas.

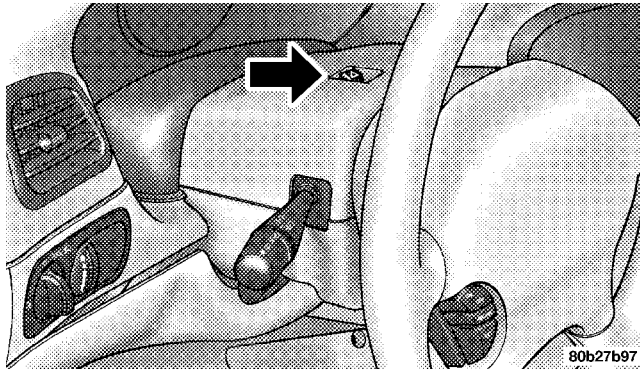

- Put the gear shift in PARK (Automatic transmission) or REVERSE (Manual Transmission).
- Set the parking brake and turn off the engine.

### WARNING!

Do not attempt to change a tire on the side of the vehicle close to moving traffic. Pull far enough off the road to avoid the danger of being hit when operating the jack or changing the wheel.

### Jacking and Changing a Tire

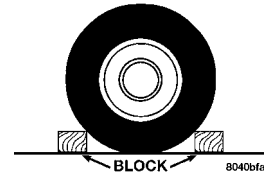

1. Block the wheel diagonally opposite the flat tire. Passengers should not remain in the vehicle when the vehicle is being jacked.
2. Remove the spare tire, scissors, jack and lug wrench.

3. Before raising the vehicle, use the lug wrench to loosen the lug nuts of the flat tire.

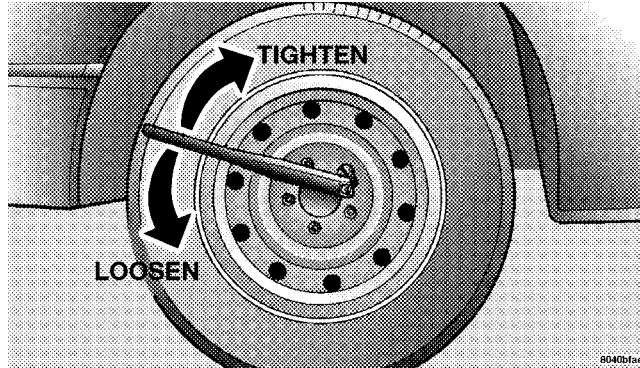

4. Turn the jack screw clockwise to firmly engage the jack saddle with the lift area of the sill flange, use the lift area closest to the flat tire.

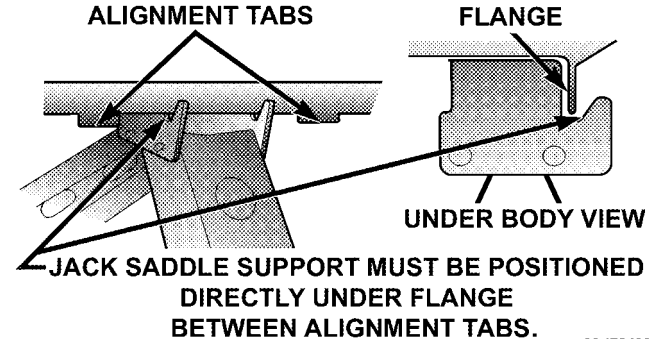

5. Raise the vehicle just enough to remove the flat tire and install the spare tire.

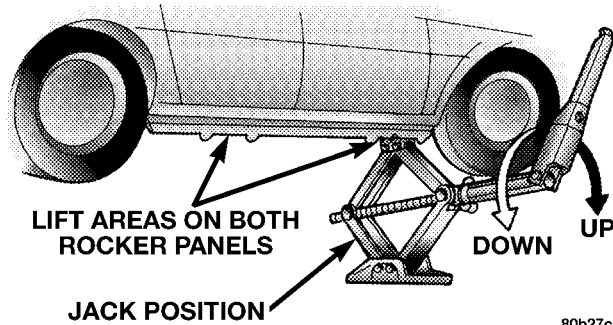

80b27c1a

6. Remove the lug nuts, wheel cover (if equipped) and tire. Remove the cover by hand, do not pry off.

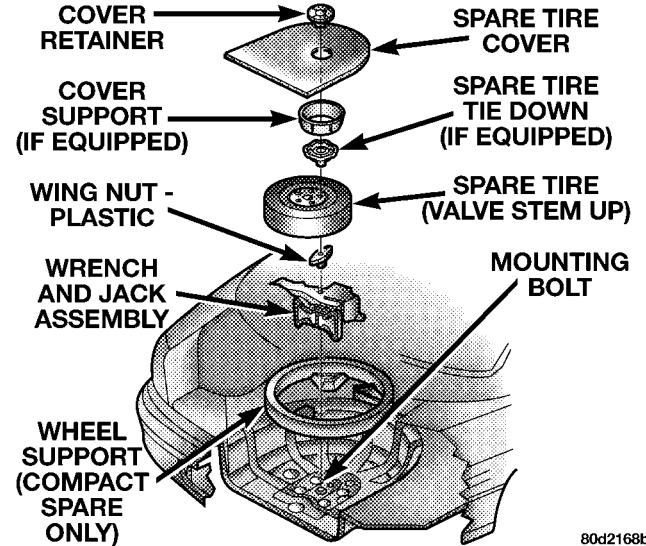

80d2168b

7. Mount the spare tire. For vehicles equipped with wheel covers, see the wheel cover installation instructions. Do not attempt to install a wheel cover on a compact spare.

8. Tighten all the lug nuts on the mounting studs.

9. Lower the vehicle to the ground by turning the jack handle counterclockwise.
10. Fully tighten the lug nuts. Torque the wheel lug nuts to 100 ft/lb. (135N. m).
11. Store the flat tire, jack and tools.

**WARNING!**

**Raising the vehicle higher than necessary can make the vehicle less stable. It could slip off the jack and hurt someone near it. Raise the vehicle only enough to remove the tire.**

**WARNING!**

**A loose tire or jack thrown forward in a collision or hard stop could endanger the occupants of the vehicle. Always stow the jack parts and the spare tire in the places provided.**

**Compact Spare Tire-For Temporary Emergency Use Only**

- Keep tire inflated to 60 PSI (414 KPa) Cold Inflation Pressure.
- Avoid driving more than 50 miles (80 km) before replacing tire and wheel.
- This tire is designed as an emergency spare only-do not exceed 50 MPH (80 km/h) speed.

### Wheel Cover Installation (If Required)

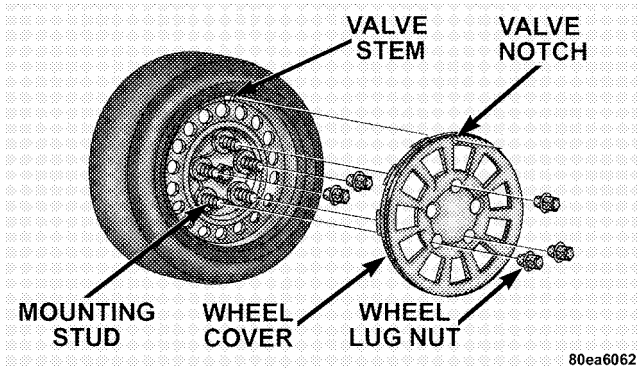

1. Tighten the two lug nuts on the mounting studs on each side of the stud which is in alignment with the valve stem.
2. Align the valve notch in the wheel cover with the valve stem on the wheel.
3. Install the cover by hand, snapping the cover over the two lug nuts. Do not use a hammer or excessive force to install the cover.
4. Return to Changing a Tire Section, Item #8 above.

### JUMP-STARTING THE BATTERY

#### WARNING!

Take care to avoid the radiator cooling fan whenever the hood is raised. It can start anytime the ignition switch is on. You can be hurt by the fan.

#### CAUTION!

Do not try to push or tow your vehicle to get it started. Your vehicle cannot be started this way. Pushing with another vehicle may damage the trans-axle or the rear of your vehicle. If your vehicle has a discharged (dead) battery, booster cables may be used to obtain a start from another vehicle. This type of start can be dangerous if done improperly, so follow the procedure carefully.

**WARNING!**

Battery fluid is a corrosive acid solution; do not allow battery fluid to contact eyes, skin or clothing. Don't lean over battery when attaching clamps or allow the clamps to touch each other. If acid splashes in eyes or on skin, flush the contaminated area immediately with large quantities of water.

A battery generates hydrogen gas which is flammable and explosive. Keep flame or spark away from the vent holes. Do not use a booster battery or any other booster source with an output that exceeds 12 volts.

**NOTE:** The battery is stored in a compartment in front of the tire in the right front fender and is accessible through the engine compartment. The tire and wheel need not be removed to gain access to the battery.

Remote jump starting terminals are located in the engine compartment.

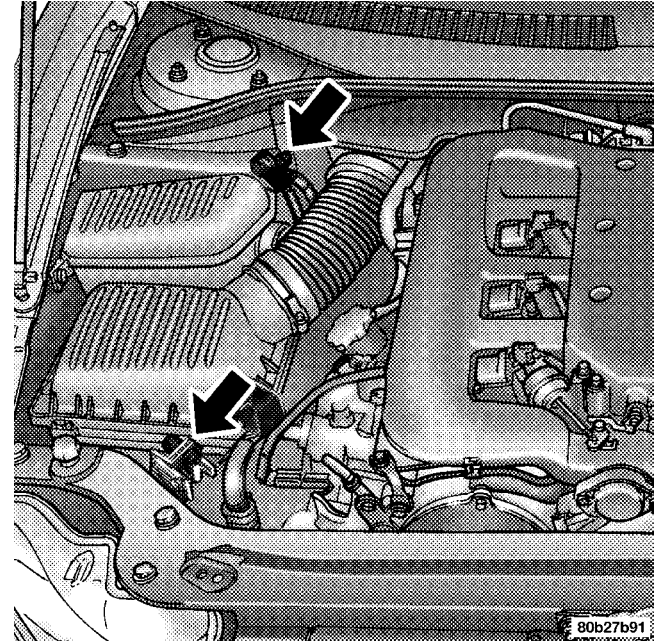

Remote Jump Starting Terminals

Check the Battery Test Indicator. If a light or bright colored dot is visible in the indicator, DO NOT jump-start the battery.

If the indicator is dark or shows a green dot, proceed as follows:

1. Wear eye protection and remove any metal jewelry such as watch bands or bracelets that might make an inadvertent electrical contact.
2. When boost is provided by a battery in another vehicle, park that vehicle within booster cable reach but without letting the vehicles touch. Set parking brake, place automatic transaxle in PARK, and turn ignition to OFF for both vehicles.

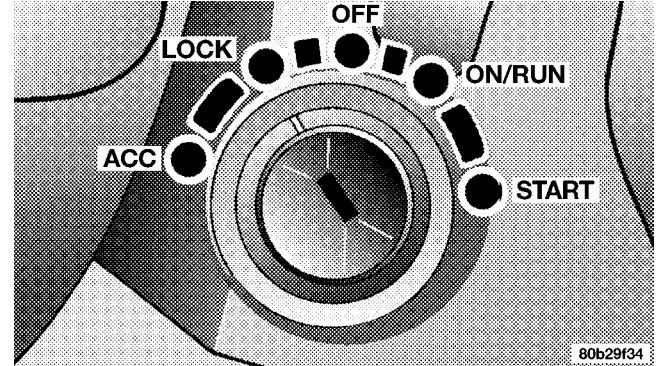

3. Turn off heater, radio and all unnecessary electrical loads.
4. Connect one end of a jumper cable to the positive jump start attachment of the booster battery. Connect the other end of the same cable to the positive jump start attachment of the discharged battery.
5. Connect the other cable, first to the negative jump start attachment of the booster battery and then to the engine of the vehicle with the discharged battery. Make sure you have a good contact on the engine.



6. Start the engine in the vehicle which has the booster battery, let the engine idle a few minutes, then start the engine in the vehicle with the discharged battery.

7. When removing the jumper cables, reverse the above sequence exactly. Be careful of the moving belts and fan.

## DRIVING ON SLIPPERY SURFACES

### Acceleration

Rapid acceleration on snow covered, wet, or other slippery surfaces may cause the front wheels to pull erratically to the right or left. This phenomenon occurs when there is a difference in the surface traction under the front (driving) wheels.

### WARNING!

**Rapid acceleration on slippery surfaces is dangerous. Unequal traction can cause sudden pulling of the front wheels. You could lose control of the vehicle and possibly have an accident. Accelerate slowly and carefully whenever there is likely to be poor traction (ice, snow, wet, mud, loose sand, etc.).**

### Traction

When driving on wet or slushy roads, it is possible for a wedge of water to build up between the tire and road surface. This is known as hydroplaning and may cause partial or complete loss of vehicle control and stopping ability. To reduce this possibility, the following precautions should be observed:

1. Slow down during rainstorms or when roads are slushy.
2. Slow down if road has standing water or puddles.
3. Replace tires when tread wear indicators first become visible.
4. Keep tires properly inflated.
5. Maintain sufficient distance between your vehicle and the vehicle in front of you to avoid a collision in a sudden stop.

**NOTE:** If so equipped, turn on the Traction Control System to accelerate on slippery surfaces.

### FREEING A STUCK VEHICLE

If your vehicle is equipped with Traction Control, turn the system off before attempting to “rock” the vehicle.

If your vehicle becomes stuck in mud, sand or snow, it can often be moved by a rocking motion. Turn your steering wheel right and left to clear the area around the front wheels. Then shift back and forth between Reverse and Drive. Usually the least accelerator pedal pressure to maintain the rocking motion without spinning the wheels is most effective.

#### CAUTION!

Racing the engine or spinning the wheels too fast may lead to transmission overheating and failure. It can also damage the tires. Do not spin the wheels above 30 mph (48 km/h).

### TOWING A DISABLED VEHICLE

Only two ways of towing are approved; front towing and flat bed towing.

#### CAUTION!

- Do not attempt to tow this vehicle from the front with sling type towing equipment. Damage to the front fascia will result.
- Always use wheel lift equipment when towing from the front. The only other approved method of towing is with a flat bed truck.
- Do not tow the vehicle from the rear. Damage to the rear sheet metal and fascia will occur.
- Do not push or tow this vehicle with another vehicle as damage to the bumper fascia and trans-axle may result.

If damage to the vehicle prevents towing from the front, move the vehicle onto a flat bed tow truck.

# MAINTAINING YOUR VEHICLE

## CONTENTS

---

■ 2.7L Engine . . . . .	189	□ Maintenance-Free Battery . . . . .	203
■ 3.5L Engine . . . . .	190	□ Air Conditioner . . . . .	204
■ Onboard Diagnostic System (OBD II) . . . . .	191	□ Power Steering Fluid Check . . . . .	205
■ Emissions Inspection And Maintenance Programs . . . . .	192	□ Chassis Lubrication . . . . .	207
■ Replacement Parts . . . . .	193	□ Drive Shaft Universal Joints . . . . .	207
■ Dealer Service . . . . .	193	□ Body Mechanism Lubrication . . . . .	207
■ Maintenance Procedures . . . . .	194	□ Windshield Wiper Blades . . . . .	209
□ Engine Oil . . . . .	194	□ Windshield Washers . . . . .	209
□ Crankcase Emission Control System . . . . .	202	□ Exhaust System . . . . .	210
□ Fuel Filter . . . . .	202	□ Cooling System . . . . .	210
□ Air Cleaner Filter . . . . .	202	□ Hoses And Vacuum/Vapor Harnesses . . . . .	214
		□ Brake System . . . . .	214

**188 MAINTAINING YOUR VEHICLE**

□ Fuel System Hoses . . . . .	217	□ Fog Light . . . . .	230
□ Automatic Transaxle . . . . .	217	□ Center Stop Light . . . . .	231
□ Appearance Care And Protection From Corrosion . . . . .	220	□ Tail, Stop, Back Up, And Turn Signal Lights . .	231
■ Fuses . . . . .	224	□ License Plate Light . . . . .	232
□ Fuse Block Relays . . . . .	224	■ Specifications . . . . .	232
□ Underhood Fuses . . . . .	224	■ Fluid Capacities . . . . .	233
■ Replacement Light Bulbs . . . . .	226	■ Recommended Fluids, Lubricants And Genuine Parts . . . . .	233
■ Bulb Replacement . . . . .	227	□ Engine . . . . .	233
□ Headlight, Parking Light Replacement . . . . .	227	□ Chassis . . . . .	234
□ Front Park And Turn Signal Light . . . . .	230	□ Body . . . . .	234
□ Front Sidemarket Light . . . . .	230		

## 2.7L ENGINE

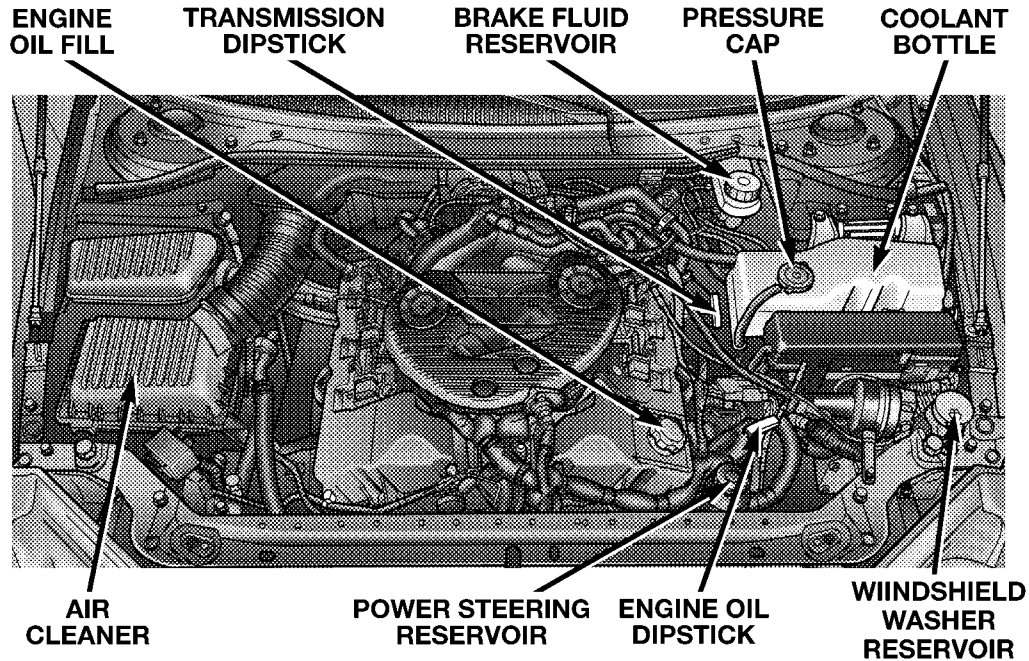

### 3.5L ENGINE

ENGINE  
OIL FILL

TRANSMISSION  
DIPSTICK

BRAKE FLUID  
RESERVOIR

PRESSURE  
CAP

COOLANT  
BOTTLE

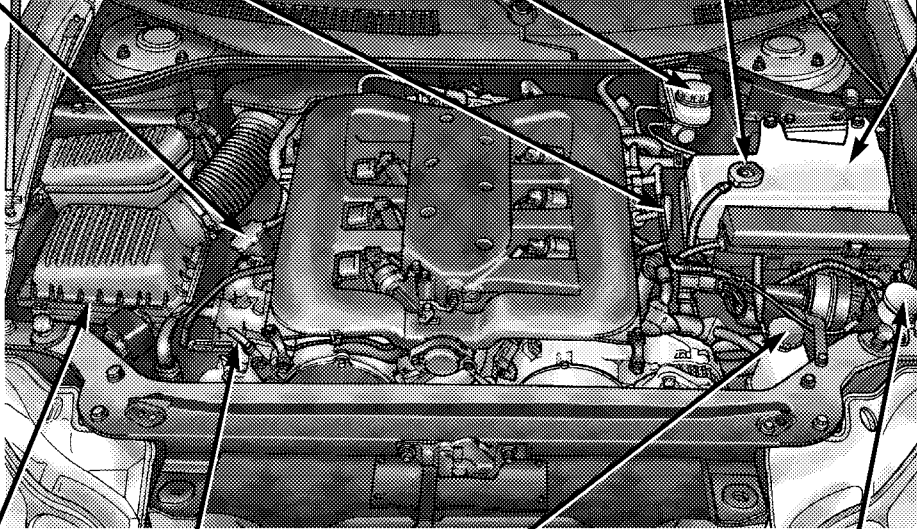

AIR  
CLEANER

ENGINE OIL  
DIPSTICK

POWER STEERING  
RESERVOIR

WINDSHIELD  
WASHER RESERVOIR

80b27c0d

## ONBOARD DIAGNOSTIC SYSTEM (OBD II)

To meet new government regulations and promote cleaner air, your vehicle is equipped with a sophisticated onboard diagnostic system called OBD II. This system monitors the performance of the emissions, engine, and automatic transaxle control systems. When these systems are operating properly, your vehicle will provide excellent performance and fuel economy, as well as engine emissions well within current government regulations.

If any of these systems require service, the OBD II system will turn on the Malfunction Indicator or Service Engine Soon Light. It will also store diagnostic codes and other information to assist your service technician in making repairs. Although your vehicle will usually be driveable and not need towing, see your dealer for service as soon as possible.

### CAUTION!

**Prolonged driving with the light on could cause further damage to the emission control system. It could also affect fuel economy and driveability. The vehicle must be serviced before any state emissions tests can be performed.**

If the light is flashing, severe catalytic converter damage and power loss will soon occur. Immediate service is required.

If the gas cap is not tightened properly, the light may come on. Be sure the gas cap is tightened every time you add fuel. Tighten the cap until you hear it “click.”

**7**

## EMISSIONS INSPECTION AND MAINTENANCE PROGRAMS

In some localities, it may be a legal requirement to pass an inspection of your vehicle's emissions control system. Failure to pass could prevent vehicle registration.



For states which have an I/M (Inspection and Maintenance) requirement, this check verifies the following: the MIL (Malfunction Indicator Lamp) is functioning and is not on when the engine is running, and that the OBD (On Board Diagnostic) system is ready for testing.

Normally, the OBD system will be ready. The OBD system may **not** be ready if your vehicle was recently serviced, if you recently had a dead battery, or a battery replacement. If the OBD system should be determined not ready for the I/M test, your vehicle may fail the test.

Your vehicle has a simple ignition key actuated test which you can use prior to going to the test station. To check if your vehicle's OBD system is ready, you must do the following:

1. Insert your ignition key into the ignition switch.
2. Turn the ignition to the ON position, but do not crank or start the engine.
3. If you crank or start the engine, you will have to start this test over.
4. As soon as you turn your key to the ON position, you will see your MIL symbol come on as part of a normal bulb check.
5. Approximately 15 seconds later, one of two things will happen:
  - a. The MIL will flash for about 10 seconds and then return to being fully illuminated until you turn off the ignition key or start the engine. This means that your vehicle's OBD system is **not ready** and you should **not** proceed to the I/M station.
  - b. The MIL will not flash at all and will remain fully illuminated until you turn off the ignition key or start the engine. This means that your vehicle's OBD system is **ready** and you can proceed to the I/M station.



If your OBD system is **not ready**, you should see your authorized dealer or repair facility. If your vehicle was recently serviced or had a battery failure or replacement, you may need to do nothing more than drive your vehicle as you normally would in order for your OBD system to update. A recheck with the above test routine may then indicate that the system is now ready.

Regardless of whether your vehicle's OBD system is ready or not ready, if the MIL symbol is illuminated during normal vehicle operation, you should have your vehicle serviced before going to the I/M station. The I/M station can fail your vehicle because the MIL symbol is on with the engine running.

### REPLACEMENT PARTS

Use of genuine Mopar® parts for normal/scheduled maintenance and repairs is highly recommended to insure the designed performance. Damage or failures caused by the use of non-Mopar® parts for maintenance and repairs will not be covered by the manufacturer's warranty.

### DEALER SERVICE

Your dealer has the qualified service personnel, special tools and equipment to perform all service operations in an expert manner. Service Manuals are available which include detailed service information for your vehicle. Refer to these manuals before attempting any procedure yourself.

**NOTE:** Intentional tampering with emissions control systems can result in civil penalties being assessed against you.

**WARNING!**

You can be badly injured working on or around a motor vehicle. Do only that service work for which you have the knowledge and the proper equipment. If you have any doubt about your ability to perform a service job, take your vehicle to a competent mechanic.

**MAINTENANCE PROCEDURES**

The pages that follow contain the maintenance service recommended by the engineers who designed your vehicle.

Besides the maintenance items for which there are fixed maintenance intervals, there are other items that should operate satisfactorily without periodic maintenance. However, if a malfunction of these items does occur, it could adversely affect the engine or vehicle performance. These items should be inspected if a malfunction is observed or suspected.

**Engine Oil****Checking Oil Level**

To assure proper lubrication of your vehicle's engine, the engine oil must be maintained, at the correct level. Check the oil level at regular intervals, such as every fuel stop.

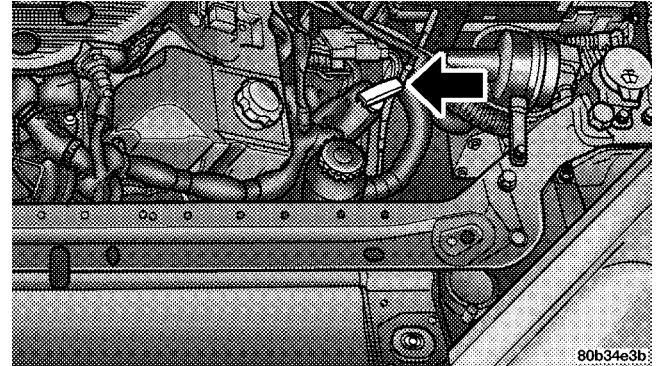

2.7L Engine Oil Dipstick

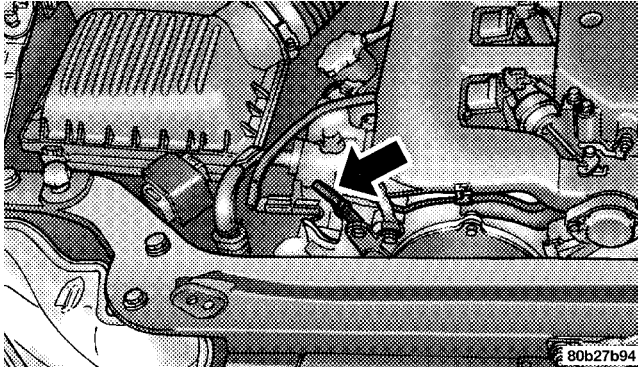

### 3.5L Engine Oil Dipstick

The best time to check the oil level is about 5 minutes after a fully warmed up engine is shut off or before starting the engine after it has sat overnight.

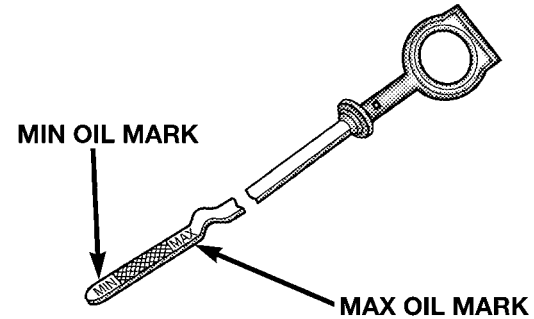

Engine Oil Dipstick

809744ab

Checking the oil while the vehicle is on level ground also will improve the accuracy of the oil level readings. Maintain the oil level between the MIN and MAX markings on the dipstick. Adding one quart of oil when the reading is at the MIN mark will result in a MAX reading on these engines.

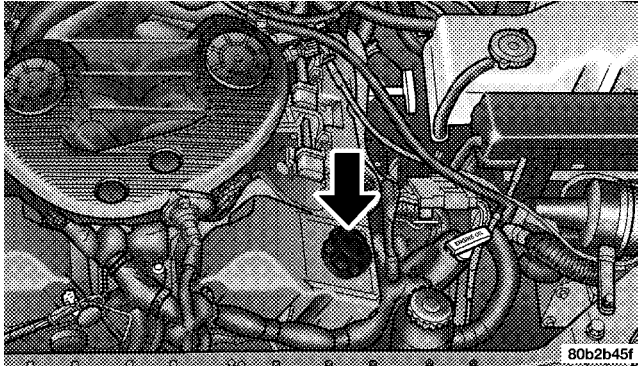

2.7L Engine Oil Fill

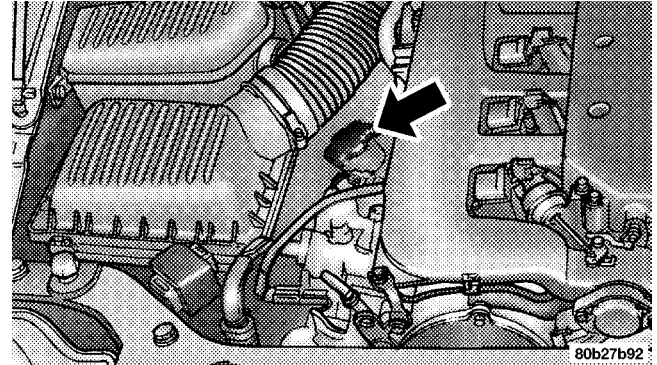

3.5L Engine Oil Fill

### Change Engine Oil

Road conditions and your kind of driving affects the interval at which your oil should be changed.

- Day or night temperatures are below 32°F (0°C)
- Stop and go driving
- Extensive engine idling
- Driving in dusty conditions
- Short trips of less than 10 miles (16.2 km)
- More than 50% of your driving is at sustained high speeds during hot weather above 90°F (32°C)
- Trailer towing
- Taxi, police, or delivery service (commercial operation)
- Off road or desert operation
- **If equipped for and operating with E —85 (ethanol) fuel**

**NOTE:** If **ANY** of these apply to you then change your engine oil every 3,000 miles (5 000 km) or 3 months, whichever comes first and follow schedule "B" of the "Maintenance Schedules" section of this manual.

If none of these apply to you, then change your engine oil at every interval shown on schedule "A" of the "Maintenance Schedules" section of this manual.

**NOTE:** Under no circumstances should oil change intervals exceed 6,000 miles (10 000 km) or 6 months whichever comes first.

#### CAUTION!

**Overfilling or underfilling the crankcase will cause oil aeration or loss of oil pressure. This could damage your engine.**

### Engine Oil Selection

For best performance and maximum protection under all types of operating conditions, we only recommend engine oils that are API Certified and meet the requirements of DaimlerChrysler's Material Standard MS-6395. Use Mopar or an equivalent oil meeting the specification MS-6395.

### American Petroleum Institute (API) Engine Oil Identification Symbol



This symbol means that the oil has been certified by the American Petroleum Institute (API). We only recommend API Certified engine oils that meet the requirements of DaimlerChrysler's Material Standard MS-6395. Use Mopar or an equivalent oil meeting the specification MS-6395.

### Engine Oil Viscosity Charts

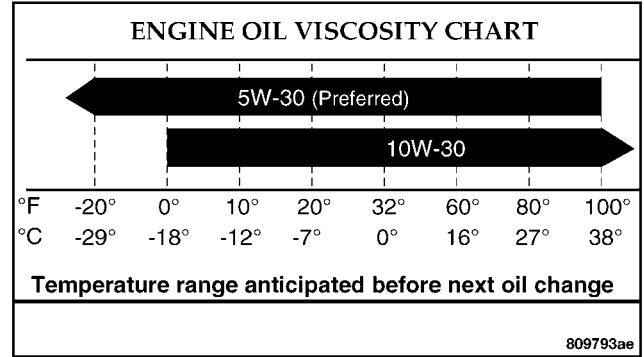

#### 2.7L Engine Oil Chart

**NOTE:** The first Viscosity Chart (5W-30 Preferred) is for the 2.7L engine only while the next chart (10W-30 Preferred) is for the 3.5L engine only.

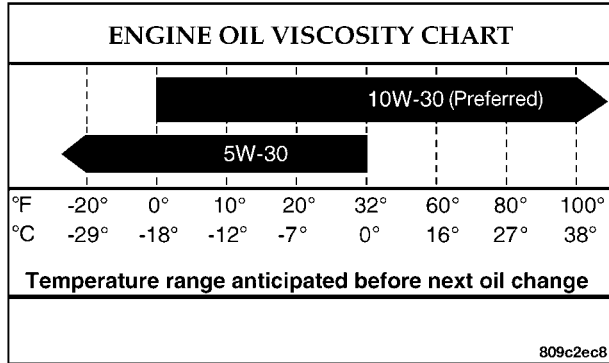

### 3.5L Engine Oil Chart

The proper SAE viscosity grade of engine oil should be selected based on the following recommendations and be within the operating temperature shown in the engine oil viscosity charts.

SAE 10W-30 engine oil is preferred for use in 3.5L engines within the operating temperatures shown in the viscosity chart. SAE 5W-30 engine oil is allowed for use in the 3.5L engines during cold weather only to improve cold weather starting.

SAE 5W-30 oil is preferred for use in 2.7L engines within the operating temperatures shown in the viscosity chart. You are highly encouraged to use SAE 5W-30 oils to aid in low temperature starting and for improved fuel economy.

### Synthetic Engine Oils

There are a growing number of engine oils being promoted as either synthetic or semi-synthetic. If you choose to use such a product, use **only** those oils that meet the American Petroleum Institute (API) and SAE viscosity standard. Follow the service schedule that describes your driving type.

### Materials Added To Engine Oils

The manufacturer strongly recommends against the addition of any additives (other than leak detection dyes) to engine oil. Engine oil is an engineered product and it's performance may be impaired by supplemental additives.

### Disposing of Used Engine Oil

Care should be taken in disposing of used engine oil from your vehicle. Used oil, indiscriminately discarded, can present a problem to the environment. Contact your

dealer, service station, or governmental agency for advice on how and where used oil can be safely discarded in your area.

### **Engine Oil Filter**

The engine oil filter should be replaced at every engine oil change.

### **Engine Oil Filter Selection**

All manufacturer's engines have a full-flow type disposable oil filter. Use a filter of this type for replacement. The quality of replacement filters varies considerably. Only high quality filters should be used to assure most efficient service. Mopar Engine Oil Filters are high quality oil filters and are recommended.

### **Drive Belts — Check Condition and Tension**

At the mileage shown in the maintenance schedules, check all drive belts for condition and proper tension. Improper belt tension can cause belt slippage and failure.

Inspect the drive belts for evidence of cuts, cracks, or glazing and replace them if there is any sign of damage which could result in belt failure. If adjustment is required, adjust the belts according to the specifications

and procedures shown in the Service Manual. See the Consumer Assistance section for information on ordering a Service Manual.

Special tools are required to properly measure tension and to restore belt tension to factory specifications. Also, check belt routing to make sure there is no interference between the belts and other engine components.

### **Spark Plugs**

Spark plugs must fire properly to assure engine performance and emission control. New plugs should be installed at the mileage specified in the appropriate maintenance chart. The entire set should be replaced if there is any malfunction due to a faulty spark plug. Check the specifications section for the proper type of spark plug for use in your vehicle.

### **Catalytic Converter**

The catalytic converter requires the use of unleaded fuel only. Leaded gasoline will destroy the effectiveness of the catalyst as an emission control device.



Under normal operating conditions, the catalytic converter will not require maintenance. However, it is important to seek service to assure proper catalyst operation and prevent possible catalyst damage. If the Malfunction Indicator light is flashing, immediate service is required.

### CAUTION!

**Damage to the catalytic converter can result if your vehicle is not kept in proper operating condition. In the event of engine malfunction, particularly involving engine misfire or other apparent loss of performance, have your vehicle serviced promptly. Continued operation of your vehicle with a severe malfunction could cause the converter to overheat, resulting in possible damage to the converter and the vehicle.**

### WARNING!

**A hot exhaust system can start a fire if you park over materials that can burn. Such materials might be grass or leaves coming into contact with your exhaust system. Do not park or operate your vehicle in areas where your exhaust system can contact anything that can burn.**

In unusual situations involving grossly malfunctioning engine operation, a scorching odor may suggest severe and abnormal catalyst overheating. If this occurs, stop the vehicle, turn off the engine and allow it to cool. Service, including a tune up to manufacturer's specifications, should be obtained immediately.

To minimize the possibility of catalyst damage:

- Do not shut off the engine or interrupt the ignition when the transaxle is in gear and the vehicle is in motion.
- Do not try to start the engine by pushing or towing the vehicle.

### Engine Timing Belt

Replace the engine timing belt at the intervals described in the appropriate maintenance schedule.

### Crankcase Emission Control System

Proper operation of this system depends on freedom from sticking or plugging due to deposits. As vehicle mileage builds up, the PCV valve and passages may accumulate deposits. If a valve is not working properly, replace it with a new valve. **DO NOT ATTEMPT TO CLEAN THE OLD PCV VALVE!**

Check ventilation hose for indication of damage or plugging deposits. Replace if necessary.

### Fuel Filter

A plugged fuel filter can cause hard starting or limit the speed at which a vehicle can be driven. Should an excessive amount of dirt accumulate in the fuel tank, frequent replacement of the fuel filter which is mounted in the fuel tank may be necessary. See your dealer for service.

### Air Cleaner Filter

Under normal driving conditions, replace the air filter at the intervals shown on Schedule "A". If, however, you drive the vehicle frequently under dusty or severe conditions, the filter element should be inspected periodically and replaced if necessary at the intervals shown on Schedule "B".

#### **WARNING!**

**The air cleaner can provide a measure of protection in the case of engine backfire. Do not remove the air cleaner unless such removal is necessary for repair or maintenance. Make sure that no one is near the engine compartment before starting the vehicle with the air cleaner removed. Failure to do so can result in serious personal injury.**

### Maintenance-Free Battery

The top of the MAINTENANCE-FREE battery is permanently sealed. You will never have to add water, nor is periodic maintenance required.

**NOTE:** The battery is stored in a compartment in front of the tire in the right front fender and is accessible through the engine compartment. The tire and wheel need not be removed to access the battery.

To access the battery:

1. Turn the steering wheel fully to the right.
2. Remove the battery access panel from the inner fender shield.
3. Remove the air cleaner.
4. Move the battery into the opening and lift it out.

#### WARNING!

Battery fluid is a corrosive acid solution and can burn or even blind you. Don't allow battery fluid to contact your eyes, skin or clothing. Don't lean over a battery when attaching clamps. If acid splashes in eyes or on skin, flush the area immediately with large amounts of water. Battery gas is flammable and explosive. Keep flame or sparks away from the battery. Don't use a booster battery or any other booster source with an output greater than 12 volts. Don't allow cable clamps to touch each other.

#### WARNING!

Battery posts, terminals and related accessories contain lead and lead compounds. Wash hands after handling.

**CAUTION!**

It is essential when replacing the cables on the battery that the positive cable is attached to the positive post and the negative cable is attached to the negative post. Battery posts are marked positive (+) and negative (-) and identified on the battery case. Cable clamps should be tight on the terminal posts and free of corrosion. Apply grease to posts and clamps after tightening. If a "fast charger" is used while the battery is in the vehicle, disconnect both vehicle battery cables before connecting the charger to battery. Do not use a "fast charger" to provide starting voltage as battery damage can result.

**Air Conditioner**

Check the air conditioning system at the start of the warm weather season.

**NOTE:** If your air conditioning performance seems lower than expected, check the front of the A/C condenser for an accumulation of dirt or insects. Clean with a gentle water spray from behind the radiator and through the condenser as required. Fabric front fascia protectors may reduce air flow to the condenser, reducing air conditioning performance.

**WARNING!**

The air conditioning system contains refrigerant under high pressure. To avoid risk of personal injury or damage to the system, adding refrigerant or any repair requiring lines to be disconnected should be done by an experienced repairman.

### Refrigerant Recovery and Recycling

The air conditioning system of your vehicle contains R-134a, a refrigerant that does not deplete the ozone layer in the upper atmosphere. The manufacturer recommends that air conditioning service be done by facilities using refrigerant recycling and recovery equipment that meets SAE standard J1991.

### Power Steering Fluid Check

#### **WARNING!**

**Fluid level should be checked with the engine off to prevent injury from moving parts. Do not overfill. Use only the manufacturer's recommended power steering fluid. Refer to Recommended Fluids, Lubricants and Genuine Parts for the correct fluid type.**

During scheduled maintenance, check the power steering fluid level at the power steering fluid reservoir.

Before removing the reservoir cap, wipe the outside of the cap and reservoir so that no dirt can fall into the reservoir.

**7**

Fluid level should be maintained at the proper level indicated on the side of the reservoir. If necessary, add fluid to restore to the proper indicated level. With a clean cloth, wipe any spilled fluid from all surfaces. See your dealer or the Recommended Fluids, Lubricants and Genuine Parts section in this manual for the correct power steering fluid for your vehicle.

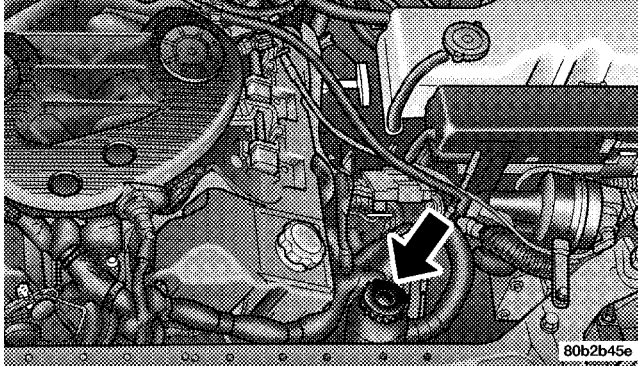

2.7L Power Steering Reservoir

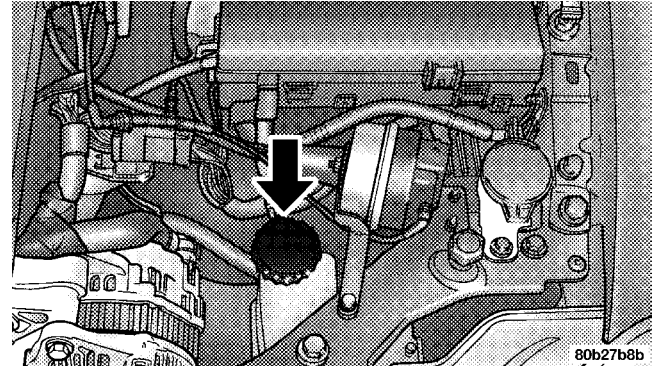

3.5L Power Steering Reservoir

## Chassis Lubrication

### Front Suspension Ball Joints

Inspect these ball joints whenever your vehicle is serviced. They are permanently lubricated and do not require periodic lubrication.

### Steering Linkage

Inspect tie rod ends whenever the vehicle is serviced. They are permanently lubricated and do not require periodic lubrication.

### Drive Shaft Universal Joints

Your vehicle has four constant velocity universal joints. Periodic lubrication of these joints is not required. However, the joint boots should be inspected for external leakage or damage when other maintenance is performed.

If leakage or damage is evident, replace the universal joint boot and grease immediately.

Continued operation could result in failure of the universal joint due to water and dirt contamination of the grease. This would require complete replacement of the joint assembly.

## Body Mechanism Lubrication

Body and other operating mechanisms and linkages should be inspected, cleaned, and lubricated, as required, to maintain ease of operation and to provide protection against rust and wear.

Before the application of any lubricant, the parts concerned should be wiped clean to remove dust and grit; after lubricating, excess oil or grease should be removed.

### Hood Latch

When performing other under hood services, the hood latch release mechanism and safety catch should be inspected, cleaned, and lubricated.

It is important to maintain proper lubrication to insure that the hood mechanisms work properly and safely. Multi-Purpose Lubricant, NLGI Grade 2, should be applied sparingly to all pivot and sliding contact areas.

### External Lock Cylinders

Lubricate the external lock cylinders twice a year, preferably in the fall and spring. Apply a small amount of lubricant, such as Mopar Lock Cylinder Lubricant directly into the lock cylinder (avoid excess lubricant). Insert the key into the lock cylinder and rotate from the unlocked to the locked position; without adding more lubricant. Repeat this procedure three or four times. Wipe all the lubricant off the key with a clean cloth, to avoid soiling clothing.

If you use a lubricant that cannot be dispensed directly into the lock cylinder, apply a small amount of the lubricant to the key. Insert the key into the lock cylinder, then proceed as described above, to distribute the lubricant within the lock cylinder. Pay attention to trunk hinges, especially during cold weather, to ensure ease of trunk operation.

### Other Body Mechanisms

The following body mechanisms should be inspected and, if necessary, all pivot and sliding contact areas of these components should be lubricated with the lubricant specified as follows:

#### *Engine Oil*

- Door hinges
- Hood hinges
- Trunk hinges

#### *Smooth White Body Lubricant - Such as Mopar Spray White Lube:*

- Hood hinge springs and links
- Lock cylinders
- Parking brake mechanism
- Trunk latches
- Ash tray
- Door Check Straps



### Windshield Wiper Blades

Clean the rubber edges of the wiper blades and the windshield periodically with a sponge or soft cloth and a mild non abrasive cleaner. This will remove accumulations of salt or road film.

Operation of the wipers on dry glass for long periods may cause deterioration of the wiper blades. Always use washer fluid when using the wipers to remove salt or dirt from a dry windshield. Avoid using the wiper blades to remove frost or ice from the windshield. Keep the blade rubber out of contact with petroleum products such as engine oil, gasoline, etc.

### Windshield Washers

The fluid reservoir in the engine compartment should be checked for fluid level at regular intervals. Fill the reservoir with windshield antifreeze (not radiator antifreeze) rated not to freeze at  $-25^{\circ}\text{F}$  ( $-31^{\circ}\text{C}$ ). Operate the system for a few seconds to flush out the residual water.

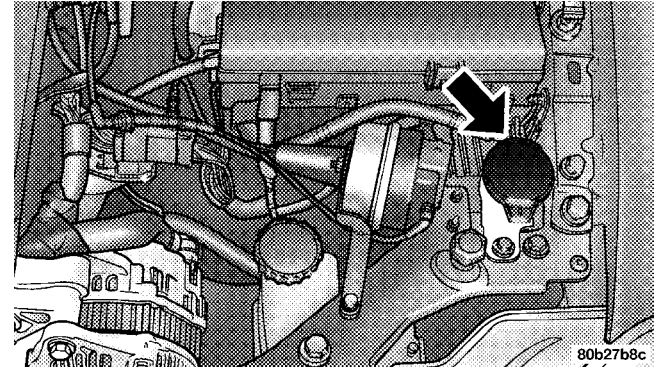

#### WARNING!

Commercially available windshield washer solvents are flammable. They could ignite and burn you. Care must be exercised when filling or working around the washer solution.

7

### Exhaust System

The best protection against carbon monoxide entry into the vehicle body is a properly maintained engine exhaust system.

If you notice a change in the sound of the exhaust system; or if exhaust fumes can be detected inside the vehicle; or when the underside or rear of the vehicle is damaged; have a competent mechanic inspect the complete exhaust system and adjacent body areas for broken, damaged, deteriorated, or mispositioned parts. Open seams or loose connections could permit exhaust fumes to seep into the passenger compartment. In addition, inspect the exhaust system each time the vehicle is raised for lubrication or oil change. Replace as required.

#### WARNING!

**Exhaust gases can injure or kill. They contain carbon monoxide which is colorless and odorless. Breathing it can make you unconscious and can eventually poison you. Follow the above precautions to keep your exhaust system as safe as possible.**

### Cooling System

#### WARNING!

- **When working near the radiator cooling fan, disconnect the fan motor lead or turn the ignition key to the OFF position. The fan is temperature controlled and can start at any time the ignition key is in the ON position.**
- **You or others can be badly burned by hot coolant or steam from your radiator. If you see or hear steam coming from under the hood, don't open the hood until the radiator has had time to cool. Never try to open a cooling system pressure cap when the radiator is hot.**

### Coolant Checks

Check coolant protection every 12 months (before the onset of freezing weather, where applicable). If coolant is dirty or rusty in appearance, the system should be drained, flushed and refilled with fresh coolant.

Check the front of the radiator and condenser for any accumulation of bugs, leaves, etc. Clean the radiator and condenser by gently spraying water from a garden hose at the back of the core.

Check the engine cooling system hoses for condition and tightness of connection. Inspect the entire system for leaks. Any hoses that show cuts or severe abrasion must be replaced.

### Cooling System — Drain, Flush and Refill

At the intervals shown on the Maintenance Schedule (5 years/100,000 miles), the system should be drained, flushed and refilled.

If the solution is dirty and contains a considerable amount of sediment, clean and flush with a reliable cooling system cleaner. Follow with a thorough rinsing to remove all deposits and chemicals.

### Engine Coolant Disposal

Used ethylene glycol based engine coolant is a regulated substance requiring proper disposal. Check with your local authorities to determine the disposal rules for your community. Do not store ethylene glycol based engine

coolant in open containers or allow it to remain in puddles on the ground. Prevent ingestion by animals or children. If ingested by a child, contact a physician immediately.

### Selection Of Coolant

Use only the manufacturer's recommended coolant. Refer to the Recommended Fluids, Lubricants and Genuine Parts section for the correct coolant type.

### CAUTION!

**Failure to use the proper antifreeze could cause radiator plugging and engine overheating. Do not mix antifreeze brands or types. Do not use plain water alone or alcohol base antifreeze products. Do not use additional rust inhibitors or antirust products, as they may not be compatible with the radiator coolant and may plug the radiator.**

### Adding Coolant

When adding coolant, a minimum solution of 50% ethylene glycol antifreeze coolant in water should be used.

Higher concentrations (not to exceed 70%) may be used if temperatures below -37°F (-38°C) are anticipated.

Use only high purity water such as distilled or deionized water when mixing the water/antifreeze solution. The use of lower quality water will reduce the amount of corrosion protection in the engine cooling system.

**NOTE:** Mixing coolant types will decrease the life of the engine coolant and will require more frequent engine coolant changes.

Please note that it is the owner's responsibility to maintain the proper level of protection against freezing according to the temperatures occurring in the area where the vehicle is operated.

### Cooling System Pressure Cap

The cap must be fully tightened to prevent loss of coolant, and to insure that coolant will return to the radiator from the coolant reserve tank.

The cap should be inspected and cleaned if there is any accumulation of foreign material on the sealing surfaces.

#### WARNING!

**The warning words "DO NOT OPEN HOT" on the cooling system pressure cap are a safety precaution. Never add coolant when the engine is overheated. Do not loosen or remove the cap to cool an overheated engine. Heat causes pressure to build up in the cooling system. To prevent scalding or injury, do not remove the pressure cap while the system is hot or under pressure.**

#### WARNING!

**Do not use a pressure cap other than the one specified for your vehicle. Personal injury or engine damage may result.**

## Coolant Level

The coolant bottle provides a quick visual method for determining that the coolant level is adequate. With the engine Off and cold, the level of the coolant in the bottle should be between the MIN and MAX cold fill lines.

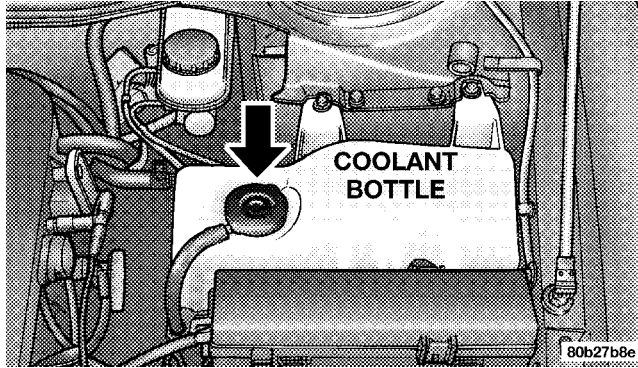

When additional coolant is needed to maintain the proper level, it should be added to the coolant bottle. Do not overfill.

## Points to Remember

**NOTE:** When the vehicle is stopped after a few miles of operation, you may observe vapor coming from the front of the engine compartment. This is normally a result of moisture from rain, snow, or high humidity accumulating on the radiator and being vaporized when the thermostat opens, allowing hot water to enter the radiator.

If an examination of your engine compartment shows no evidence of radiator or hose leaks, the vehicle may be safely driven. The vapor will soon dissipate.

- Do not overfill the coolant bottle.
- Check coolant freeze point in the system.
- If frequent coolant additions are required, or if the level in the recovery bottle does not drop when the engine cools, the cooling system should be pressure tested for leaks.

- Maintain coolant concentration of a minimum of 50% ethylene glycol and high quality water with recommended antifreeze for proper corrosion protection of your engine cooling system that contains aluminum components.
- Make sure that the radiator and coolant bottle hoses are not kinked or obstructed.
- Keep the front of the radiator and air conditioning condenser clean.
- Do not change the thermostat for summer or winter operation. If replacement is ever necessary, install **ONLY** the correct type thermostat. Other designs may result in unsatisfactory engine cooling performance, poor gas mileage, and increased emissions.

### **Hoses and Vacuum/Vapor Harnesses**

Inspect surfaces of hoses and nylon tubing for evidence of heat and mechanical damage. Hard or soft spots, brittle rubber, cracking, checking, tears, cuts, abrasions, and excessive swelling indicate deterioration of the rubber.

Pay particular attention to those hoses nearest to high heat sources such as the exhaust manifold. Inspect hose routing to be sure hoses do not touch any heat source or moving component that may cause heat damage or mechanical wear.

Insure nylon tubing in these areas has not melted or collapsed. Inspect all hose connections such as clamps and couplings to make sure they are secure and no leaks are present. Components should be replaced immediately if there is any evidence of degradation that could cause failure.

### **Brake System**

In order to assure brake system performance, all brake system components should be inspected periodically. Suggested service intervals can be found in Section 8.

**WARNING!**

**Riding the brakes can lead to brake failure and possibly an accident. Driving with your foot resting or riding on the brake pedal can result in abnormally high brake temperatures, excessive lining wear, and possible brake damage. You wouldn't have your full braking capacity in an emergency.**

**Brake and Power Steering System Hoses**

When servicing the vehicle for scheduled maintenance, inspect surface of hoses for evidence of heat and mechanical damage. Hard and brittle rubber, cracking, checking, tears, cuts, abrasion, and excessive swelling suggest deterioration of the rubber. Particular attention should be made to examining those hose surfaces nearest to high heat sources, such as the exhaust manifold.

Inspect all hose clamps and couplings to make sure they are secure and no leaks are present.

**NOTE:** Often, fluids such as oil, power steering fluid, and brake fluid are used during assembly plant operations to ease the assembly of hoses to couplings. Therefore, oil wetness at the hose-coupling area is not necessarily an indication of leakage. Actual dripping of hot fluid when systems are under pressure (during vehicle operation) should be noted before hose is replaced based on leakage.

**NOTE:** Inspection of brake hoses should be done whenever the brake system is serviced and every engine oil change.

**WARNING!**

**Worn brake hoses can burst and cause brake failure. You could have an accident. If you see any signs of cracking, scuffing, or worn spots, have the brake hoses replaced immediately.**

### Brake Master Cylinder

The fluid level in the master cylinder should be checked when performing under hood services, or immediately if the brake system warning lamp shows system failure.

Be sure to clean the top of the master cylinder area before removing the cap. If necessary, add fluid to bring the fluid level up to the requirements described on the brake fluid reservoir. With disc brakes, fluid level can be expected to fall as the brake pads wear. However, low fluid level may be caused by a leak and a checkup may be needed.

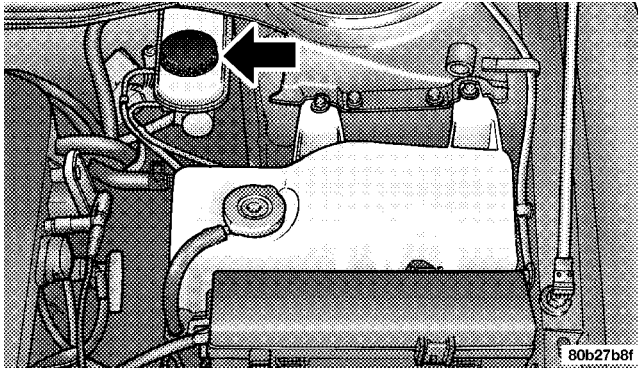

Use only manufacturer's recommended brake fluid. Refer to the Recommended Fluids, Lubricants and Genuine Parts section for the correct fluid type.

#### WARNING!

**Use of a brake fluid that may have a lower initial boiling point or unidentified as to specification, may result in sudden brake failure during hard prolonged braking. You could have an accident.**

Use only brake fluid that has been in a tightly closed container to avoid contamination from foreign matter.

Do not allow petroleum base fluid to contaminate the brake fluid as seal damage will result!



### Fuel System Hoses

Electronic Fuel Injection high pressure fuel systems are designed with hoses and clamps which have unique material characteristics to provide adequate sealing and resist attack by deteriorated gasoline.

You are urged to use only manufacturer specified hoses and clamps, or their equivalent in material and specification, in any fuel system servicing. It is mandatory to replace all clamps that have been loosened or removed during service. Care should be taken in installing new clamps to insure they are properly torqued.

### Automatic Transaxle

All front wheel drive vehicles have a transaxle and differential assembly contained within a single housing.

### Selection of Lubricant

It is important that the proper lubricant is used in the transaxle to assure optimum transaxle performance. Use only the manufacturer's recommended transmission fluid. Refer to the Recommended Fluids, Lubricants and Genuine Parts section for the correct fluid type. It is important that the transmission fluid be maintained at the prescribed level using the recommended fluid.

#### CAUTION!

**Using a transmission fluid other than the manufacturer's recommended fluid may cause deterioration in transmission shift quality and/or torque converter shudder. Using a transmission fluid other than that recommended by the manufacturer will result in more frequent fluid and filter changes. Refer to the Recommended Fluids, Lubricants and Genuine Parts for the correct fluid type.**

### Fluid Level Check

The fluid level in the automatic transaxle should be checked whenever the vehicle is serviced. Operation with an improper fluid level will greatly reduce the life of the transaxle and of the fluid.

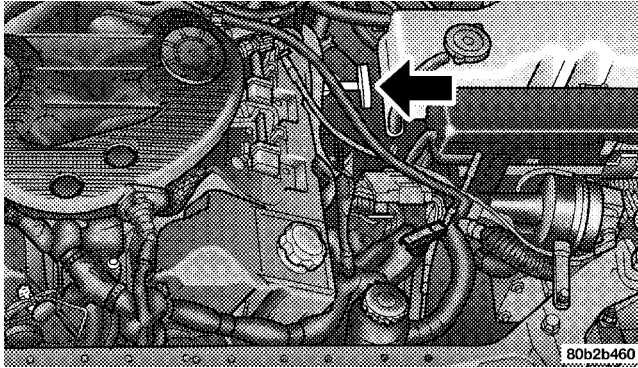

2.7L Transmission Dipstick

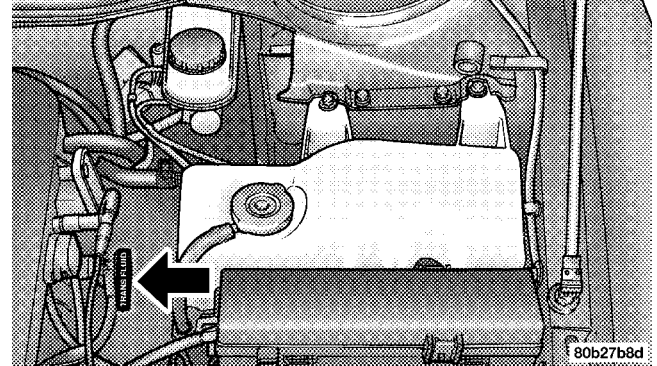

3.5L Transmission Dipstick

### Procedure For Checking Fluid Level

To properly check the automatic transaxle fluid level, the following procedure must be used:

- The vehicle must be on level ground.
- The engine should be running at curb idle speed for a minimum of 60 seconds.
- Fully apply parking brake.
- Place the gear selector momentarily in each gear position ending with the lever in P (PARK).

- Wipe the dipstick clean and reinsert until seated. Remove dipstick and note reading.
- If the fluid is hot (180° F / 82° C), the reading should be in the cross hatched area marked "HOT" (between the upper two holes in the dipstick).
- If the fluid is cold (80° F / 27° C), the reading should be in the cross hatched area marked "COLD" (between the lower two holes in the dipstick).
- If the fluid level shows low, add sufficient transmission fluid to bring to the proper level.

### CAUTION!

**Do not overfill. Dirt and water in the transaxle can cause serious damage. To prevent dirt and water from entering the transaxle after checking or replenishing fluid, make certain that the dipstick cap is seated properly.**

### Fluid and Filter Changes

Automatic transmission fluid and filter should be changed as follows:

**Maintenance schedule "A"** — No change necessary

**Maintenance schedule "B"** — Every 60,000 miles (96 000 km) change fluid and filter under the following conditions:

- Police, taxi, limousine, commercial type operation, or trailer towing where the vehicle is driven **regularly** for more than 45 minutes of continuous operation.

**NOTE:** Refer to Section 8 of this manual for maintenance schedules.

If the transaxle is disassembled for any reason, the fluid and filter should be changed.

### Special Additives

The manufacturer recommends against the addition of any fluid additives to the transaxle. The only exception to this policy is the use of special dyes to aid in detecting fluid leaks. The use of transmission sealers should be avoided as they may adversely affect seals.

## Appearance Care And Protection From Corrosion

### Protection of Body and Paint from Corrosion

Vehicle body care requirements vary according to geographic locations and usage. Chemicals that make roads passable in snow and ice, and those that are sprayed on trees and road surfaces during other seasons, are highly corrosive to the metal in your vehicle. Outside parking, which exposes your vehicle to airborne contaminants, road surfaces on which the vehicle is operated, extreme hot or cold weather and other extreme conditions will have an adverse effect on paint, metal trim, and underbody protection.

The following maintenance recommendations will enable you to obtain maximum benefit from the corrosion resistance built into your vehicle.

### What Causes Corrosion?

Corrosion is the result of deterioration or removal of paint and protective coatings from your vehicle.

The most common causes are:

- Road salt, dirt and moisture accumulation.

- Stone and gravel impact.
- Insects, tree sap and tar.
- Salt in the air near seacoast localities.
- Atmospheric fallout/industrial pollutants.
- Bird droppings.

### Washing

- Wash your vehicle regularly. Always wash your vehicle in the shade using a mild car wash soap, and rinse the panels completely with clear water.
- If insects, tar or other similar deposits have accumulated on your vehicle, wash it as soon as possible.
- Use Mopar auto polish to remove road film and stains and to polish your vehicle. Take care never to scratch the paint.
- Avoid using abrasive compounds and power buffing that may diminish the gloss or thin out the paint finish.

**CAUTION!**

**Do not use abrasive or strong cleaning materials such as steel wool or scouring powder, which will scratch metal and painted surfaces.**

**Special Care**

- If you drive on salted or dusty roads or if you drive near the ocean, hose off the undercarriage at least once a month.
  - It is important that the drain holes in the lower edges of the doors, rocker panels and rear deck lid be kept clear and open.
  - If you detect any stone chips or scratches in the paint, touch them up immediately. The cost of such repairs is considered the responsibility of the owner.
  - Use Mopar touch up paint on scratches or chips as soon as possible. Your dealer has touch up paint to match the color of your vehicle.
- If your vehicle is damaged due to an accident or similar cause which destroys the paint and protective coating have your vehicle repaired as soon as possible. The cost of such repairs is considered the responsibility of the owner.
  - Aluminum wheels should be cleaned regularly with mild soap and water to prevent corrosion. To remove heavy soil, select a non abrasive, non-acidic cleaner. Do not use scouring pads or metal polishes. Avoid automatic car washes that use acidic solutions or harsh brushes that may damage the wheels' protective finish.
  - If you carry special cargo such as chemicals, fertilizers, deicer salt, etc., be sure that such materials are well packaged and sealed.
  - If a lot of driving is done on gravel roads, consider mud or stone shields behind each wheel.

**Interior Care**

Use Mopar Fabric Cleaner to clean fabric upholstery and carpeting.

Use a mild soap and warm water solution to clean vinyl or leather upholstery. For stubborn stains, use Mopar Vinyl Cleaner.

Mopar Vinyl Cleaner is specifically recommended for vinyl trim.

**WARNING!**

**Do not use volatile solvents for cleaning purposes. Many are potentially flammable, and if used in closed areas they may cause respiratory harm.**

**CAUTION!**

**The use of vinyl, leather or plastic protectants may cause excessive gloss and/or discoloration of interior trim parts.**

**Leather Seat Care and Cleaning**

Leather is best preserved by regular cleaning with a damp soft cloth. Small particles of dirt can act as an

abrasive and damage the leather surface and should be removed immediately with a damp cloth. Stubborn soils can be removed easily with a soft cloth and Mopar Total Clean. Care should be taken to avoid soaking the leather with any liquid. Please do not use polishes, oils, cleaning fluids, solvents, detergents, or ammonia based cleaners to clean the leather. Application of a leather conditioner is not required to maintain the original condition.

**Wooden Steering Wheel Care — If Equipped**

If your vehicle is equipped with a wood steering wheel, it is finished with a clear topcoat. Please take care to avoid scratching the surface with sharp or abrasive materials.

**Cleaning Headlights**

Your vehicle has plastic headlights that are lighter and less susceptible to stone breakage than glass headlights.

Plastic is not as scratch resistant as glass and therefore different lens cleaning procedures must be followed.

To minimize the possibility of scratching the lenses and reducing light output, avoid wiping with a dry cloth. To remove road dirt, wash with a mild soap solution followed by rinsing.

Do not use abrasive cleaning components, solvents, steel wool or other aggressive material to clean the lenses.

### **Glass Surfaces**

All glass surfaces should be cleaned on a regular basis with any commercial household-type glass cleaner. Never use an abrasive type cleaner. Use caution when cleaning inside rear windows equipped with electric defrosters. Do not use scrapers or other sharp instruments which may scratch the elements.

### **Instrument Panel Cover**

The instrument panel cover has a low glare surface which minimizes reflections in the windshield. Do not use protectants or other products which may cause undesirable reflections. Use soap and warm water to restore the low glare surface.

### **Cleaning Plastic Instrument Cluster Lenses**

The lenses in front of the instruments in this vehicle are molded in clear plastic. When cleaning the lenses, care must be taken to avoid scratching the plastic.

- Clean with a wet soft rag. A mild soap solution may be used, but do not use high alcohol content or abrasive cleaners. If soap is used, wipe clean with a clean damp rag.
- Dry with a soft tissue.

### **Seat Belt Maintenance**

Do not bleach, dye or clean the belts with chemical solvents or abrasive cleaners. This will weaken the fabric.

If the belts need cleaning, use a mild soap solution or lukewarm water. Do not remove the belts from the vehicle to wash them.

Replace the belts if they appear frayed or worn or if the buckles do not work properly.

## FUSES

The fuse block is behind the end cover at the left side of the instrument panel. Pull the cover straight away from the instrument panel for access to the fuses.

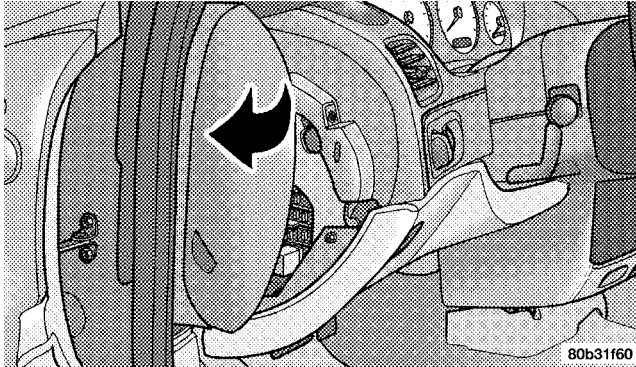

### Fuse Block Relays

The location and identification of fuse block relays can be found on the inside of the instrument panel end cover.

## Underhood Fuses

A Power Distribution center is located in the engine compartment. This center contains fuses and relays for circuits that operate only under the hood. A label which identifies these components is located on the underside of the cover.

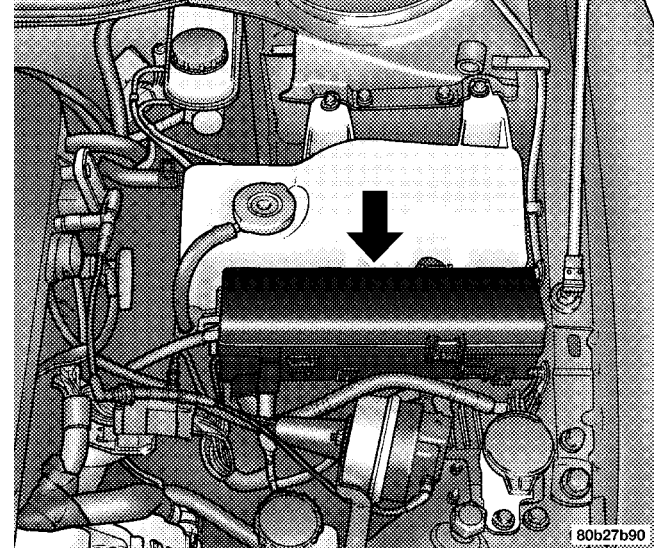



**CAUTION!**

When replacing a blown fuse, it is important to use only a fuse having the correct amperage rating. The use of a fuse with a rating other than indicated may result in a dangerous electrical system overload. If a properly rated fuse continues to blow, it indicates a problem in the circuit that must be corrected.

**Interior Fuses**

Cavity	Fuse	Circuits
1	10 Amp Red	Transmission Controller, Gauges, Autostick
2	10 Amp Red	Right High Beam Headlight
3	10 Amp Red	Left High Beam Headlight
4	10 Amp Red	Radio, CD Player
5	10 Amp Red	Washer Motor
6	15 Amp Lt. Blue	Power Outlet
7	20 Amp Yel-low	Tail, License, Parking, Illumination Lights, Instrument Cluster
8	10 Amp Red	Airbag

Cavity	Fuse	Circuits
9	10 Amp Red	Turn Signal Lights, Turn Signal/Hazard Indicator
10	15 Amp Lt. Blue	Right Low Beam
11	20 Amp Yel-low	High Beam Relay, High Beam Indicator, High Beam Switch
12	15 Amp Lt. Blue	Left Low Beam Headlight
13	10 Amp Red	Fuel Pump Relay, Power Train Control Module
14	10 Amp Red	Cluster, Day/Night Mirror, Sunroof, Overhead Console, Garage Door Opener, Body Control Module
15	10 Amp Red	Daytime Running Light Module (Canada)
16	20 Amp Yel-low	Fog Light Indicator
17	10 Amp Red	ABS Control, Back Up Lights, Daytime Running Lights, A/C Heater Control,

Cavity	Fuse	Circuits
18	20 Amp Yellow	Power Amplifier, Horn
19	15 Amp Lt. Blue	Overhead Console, Garage Door Opener, Trunk, Overhead, Rear Reading, and Visor Vanity Lights, Trunk Release Solenoid, Power Mirrors, Power Door Locks, Body Control Module, Aspirator Motor
20	20 Amp Yellow	Brake Lights
21	10 Amp Red	Leak Detection Pump, Low Rad Relay, High Rad Relay, A/C Clutch Relay
22	10 Amp Red	Airbag
23	30 Amp Green	Blower Motor, ATC Power Module
24	20 Amp C/BRKR	Power Window Motors
25	20 Amp C/BRKR	Power Door Lock Motors, Power Seats

## REPLACEMENT LIGHT BULBS

Interior Light Bulbs	Bulb No.
Turn Signal . . . . .	PC194
Climate Control . . . . .	330
Overhead Console, Front Reading, Courtesy, Grab Handle . . . . .	192
Trunk . . . . .	906

Exterior Light Bulbs	Bulb No.
Low Beam Headlights . . . . .	9006
High Beam Headlights . . . . .	9005XSL
Park, Turn, & Side Marker . . . . .	3157A
Fog Lights . . . . .	9040
Center Stop Light . . . . .	921
Tail, Stop, & Turn . . . . .	3157K
Back-Up . . . . .	921
License . . . . .	168
Front Sidemarker . . . . .	168
Tail . . . . .	916

## BULB REPLACEMENT

### Headlight, Parking Light Replacement

1. Open the hood.
2. Remove the upper crossmember attachments on both sides of the vehicle; 6 in total.

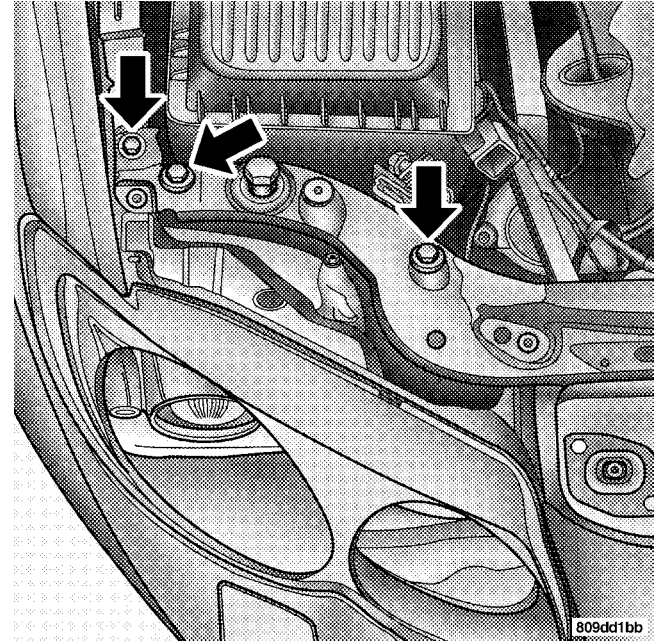

3. Remove the headlamp jackscrews on both sides of the vehicle.

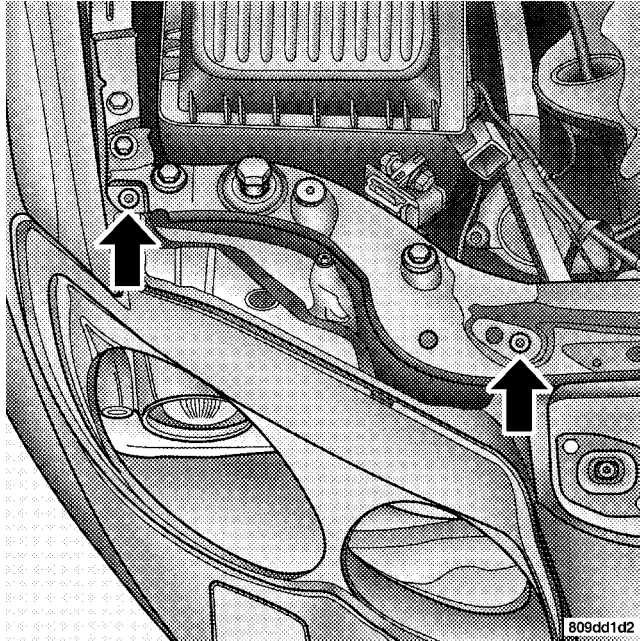

4. Remove the windshield filler neck screw.

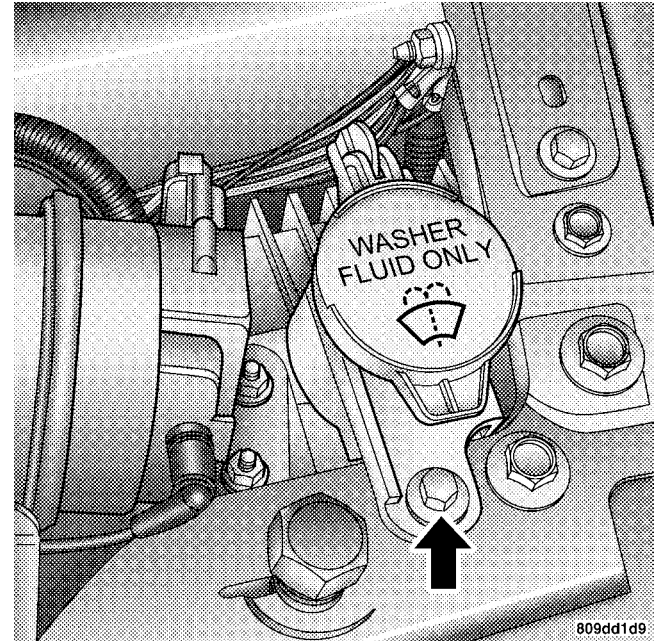

5. Remove the speed control servo screw.

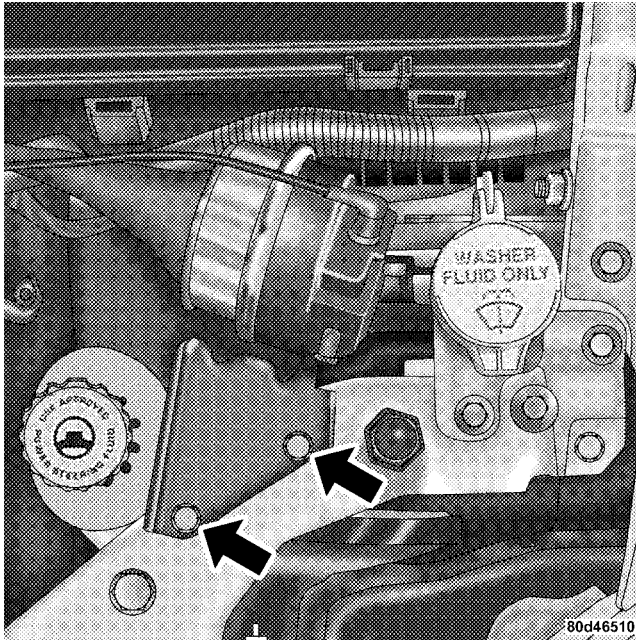

6. Lift and prop the crossmember above the headlamp on the side being serviced, and remove the electrical connectors from the headlamp.

7. Pull headlamp up and under crossmember to remove it from the vehicle.

8. Remove the bulb retaining ring by turning it counter-clockwise. Pull the bulb and socket assembly from the housing and pull the bulb from the socket.

9. Install a new headlight bulb in the socket, reinstall the bulb and socket assembly and tighten the retaining ring.

**CAUTION!**

**Do not touch the new bulb with your fingers. Oil contamination will severely shorten bulb life.**

**If the bulb comes into contact with any oily surface, clean the bulbs with rubbing alcohol.**

10. Reinstall the headlight assembly, replace the electrical connectors from the headlamp and lower the crossmember back on the headlamp.

11. Reinstall the upper crossmember attachments, headlamp jackscrews, windshield filler neck screw and speed control servo screw.

### Front Park and Turn Signal Light

1. Remove the headlight assembly from the vehicle.
2. Turn the park/turn signal bulb and socket assembly counterclockwise and remove it from the housing.
3. Pull the bulb from the socket and install a new bulb.
4. Reinstall the bulb and socket assembly.
5. Reinstall the headlight assembly.

### Front Sidemarkers Light

1. Reach up under the fascia and grasp the light bulb socket.
2. Turn the socket counterclockwise to remove it from the housing.
3. Pull the bulb out of the socket.
4. Replace the bulb and reinstall the socket. Turn the socket clockwise to secure it in the housing.

### Fog Light

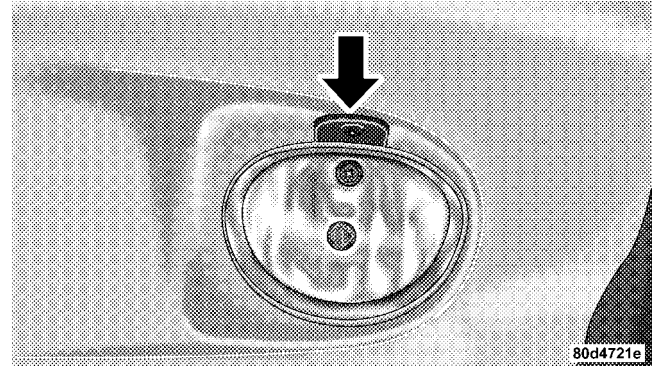

1. Remove the screw securing the fog light to the fascia and pull the light away from the vehicle to expose the bulb.
2. Remove the bulb by turning counter-clockwise. Pull the bulb out of the light housing.
3. Remove the wiring connector from the bulb.
4. Insert new bulb and turn clockwise.

5. Connect the wiring connector to the new bulb and reinstall the assembly.

### Center Stop Light

1. Open the trunk and reach up under the package shelf.

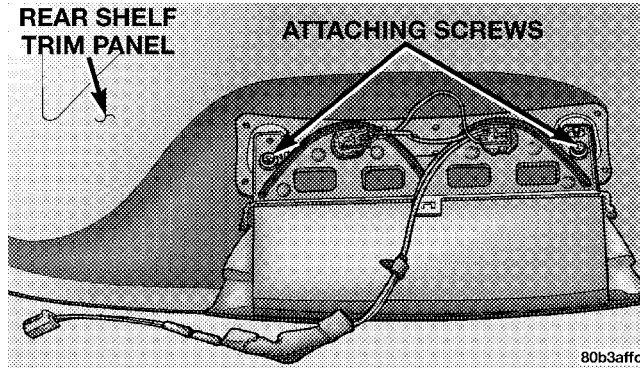

2. Turn the bulb socket counterclockwise and remove it from the housing.
3. Pull the bulb from the socket and replace the bulb.
4. Reinstall the bulb and socket assembly.

### Tail, Stop, Back Up, and Turn Signal Lights

1. Open the trunk and remove the fasteners securing the light housing to the body.
2. Pull the light housing from the body to expose the wiring socket.

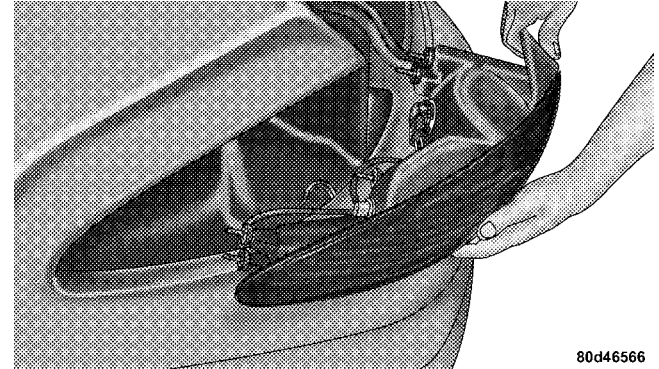

3. Turn the bulb socket counterclockwise to remove from the housing. Pull the bulb out of the socket and remove the bulb.
4. Replace the bulb, reinstall the bulb and socket assembly and reattach the light housing.

### License Plate Light

1. Remove the screws securing the light to the rear fascia.
2. Remove the bulb and socket assembly and pull the bulb from the socket.

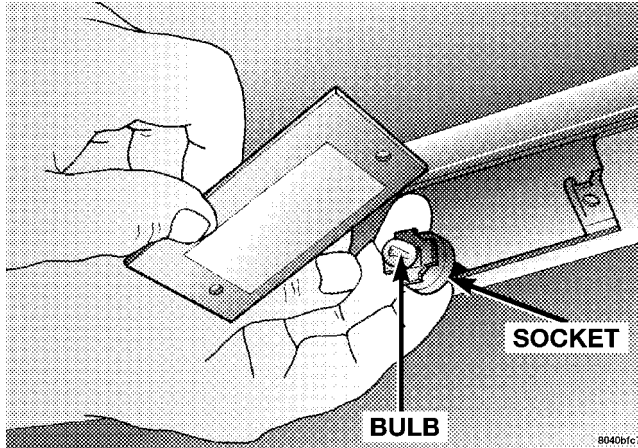

3. Replace the bulb and reinstall the bulb and socket assembly.
4. Reattach the light to the rear fascia.

### SPECIFICATIONS

ENGINE	ALL
Oil Filter	Mopar 5281090 or equivalent
Thermostat	180°F (82°C)
Spark Plug	See Underhood Label
Spark Plug Gap	See Underhood Label
Firing Order	1-2-3-4-5-6



**FLUID CAPACITIES**

	U.S.	Metric
<b>Fuel (Approximate)</b>	17 Gallons	64 Liters
<b>Engine Oil with Filter</b>		
2.7 & 3.5 Liter Engine	5 Qts	4.7 Liters
<b>Cooling System*</b>		
2.7 Liter Engine	10.5 Qts	10 Liters
3.5 Liter Engine	11 Qts	10.5 Liters

\* Includes heater and coolant recovery bottle filled to MAX level.

**RECOMMENDED FLUIDS, LUBRICANTS AND GENUINE PARTS**

**Engine**

Component	Fluid, Lubricant or Genuine Part
Engine Coolant	Mopar® Antifreeze/Coolant 5 Year/100,000 Mile Formula HOAT (Hybrid Organic Additive Technology)
Engine Oil	Use API Certified (GF-3). Refer to oil viscosity chart for correct SAE grade.
Spark Plugs	Refer to the Vehicle Emission Control Information label in the engine compartment.
Oil Filter	Mopar® Oil Filter
Fuel Selection	89 Octane

**Chassis**

Component	Fluid, Lubricant or Genuine Part
Automatic Transmission	Mopar® ATF+4 Automatic Transmission Fluid.
Axle Differential (front-rear)	Mopar® Hypoid Gear Lubricant (SAE 80W-90). Do not use synthetic gear lubricants.
Brake Master Cylinder	Mopar® DOT-3 Brake Fluid.
Power Steering Reservoir	Mopar® ATF+4 Automatic Transmission Fluid.
Tire Pressure	Refer to label on driver's door pillar.

**Body**

Component	Fluid, Lubricant or Genuine Part
Hinges: Door, Hood and Trunk Hood hinge springs and links	Mopar® Engine Oil Mopar® Spray White Lube
Latches: Door and Hood Trunk	Mopar® Multi-Purpose Lube NLGI Grade 2 Mopar® Spray White Lube
Door check straps	Mopar® Spray White Lube
Window System Components	Mopar® Spray White Lube
Lock Cylinders	Mopar® Spray White Lube
Parking Brake Mechanism	Mopar® Spray White Lube

# MAINTENANCE SCHEDULES

## CONTENTS

---

<ul style="list-style-type: none"> <li>■ Emission Control System Maintenance . . . . .236</li> <li>■ Maintenance Schedules . . . . .236</li> </ul>	<ul style="list-style-type: none"> <li>□ Schedule “B” . . . . .239</li> <li>□ Schedule “A” . . . . .246</li> </ul>
--	--

### EMISSION CONTROL SYSTEM MAINTENANCE

The “Scheduled” maintenance services, listed in **bold type** must be done at the times or mileages specified to assure the continued proper functioning of the emission control system. These, and all other maintenance services included in this manual, should be done to provide best vehicle performance and reliability. More frequent maintenance may be needed for vehicles in severe operating conditions such as dusty areas and very short trip driving.

Inspection and service also should be done any time a malfunction is suspected.

**NOTE:** Maintenance, replacement, or repair of the emission control devices and systems on your vehicle may be performed by any automotive repair establishment or individual using any automotive part which has been certified pursuant to U.S. EPA or, in the State of California, California Air Resources Board regulations.

### MAINTENANCE SCHEDULES

There are two maintenance schedules that show the **required** service for your vehicle.

First is Schedule “**B**”. It is for vehicles that are operated under the conditions that are listed below and at the beginning of the schedule.

- Day or night temperatures are below 32° F (0° C).
- Stop and go driving.
- Extensive engine idling.
- Driving in dusty conditions.
- Short trips of less than 10 miles (16 km).
- More than 50% of your driving is at sustained high speeds during hot weather, above 90° F (32° C). ◇
- Trailer towing. ◇
- Taxi, police, or delivery service (commercial service). ◇
- Off-road or desert operation.

**NOTE:** If **ANY** of these apply to you then change your engine oil every 3,000 miles (5 000 km) or 3 months, whichever comes first and follow schedule "B" of the "Maintenance Schedules" section of this manual.

**NOTE:** Most vehicles are operated under the conditions listed for Schedule "B".

Second is Schedule "A". It is for vehicles that are not operated under any of the conditions listed under Schedule "B".

Use the schedule that best describes your driving conditions. Where time and mileage are listed, follow the interval that occurs first.

**NOTE:** Under no circumstances should oil change intervals exceed 6000 miles (10 000 km) or 6 months whichever comes first.

### CAUTION!

**Failure to perform the required maintenance items may result in damage to the vehicle.**

#### *At Each Stop for Fuel*

- Check the engine oil level about 5 minutes after a fully warmed engine is shut off. Checking the oil level while the vehicle is on level ground will improve the accuracy of the oil level reading. Add oil only when the level is at or below the ADD or MIN mark.
- Check the windshield washer solvent and add if required.

238 MAINTENANCE SCHEDULES

*Once a Month*

- Check tire pressure and look for unusual wear or damage.
- Inspect the battery and clean and tighten the terminals as required.
- Check the fluid levels of coolant reservoir, brake master cylinder, power steering and transaxle and add as needed.
- Check all lights and all other electrical items for correct operation.
- Check rubber seals on each side of the radiator for proper fit.

*At Each Oil Change*

- Change the engine oil filter.
- Inspect the exhaust system.
- Inspect the brake hoses.
- Inspect the CV joints and front and rear suspension components.
- Check the automatic transmission fluid level.
- Check the coolant level, hoses, and clamps.
- Rotate the tires at each oil change interval shown on Schedule "A" 6,000 miles (10 000 km) or every other interval shown on Schedule "B" 6,000 miles (10 000 km).

## SCHEDULE "B"

Follow schedule "B" if you usually operate your vehicle under one or more of the following conditions. Change the automatic transmission fluid and filter every 60,000 miles (96 000 km) if the vehicle is usually operated under one or more of the conditions marked with an  $\diamond$ .

- Day or night temperatures are below 32° F (0° C).
- Stop and go driving.
- Extensive engine idling.
- Driving in dusty conditions.
- Short trips of less than 10 miles (16.2 km).
- More than 50% of your driving is at sustained high speeds during hot weather, above 90° F (32° C).  $\diamond$

- Trailer towing.  $\diamond$
- Taxi, police or delivery service (commercial services).  $\diamond$
- Off-road or desert operation.
- **If equipped for and operating with E-85 (ethanol) fuel.**

**NOTE:** If **ANY** of these apply to you then change your engine oil every 3,000 miles (5 000 km) or 3 months, whichever comes first and follow schedule "B" of the "Maintenance Schedules" section of this manual.

240 SCHEDULE "B"

Miles (Kilometers)	3,000 (5 000)	6,000 (10 000)	9,000 (14 000)	12,000 (19 000)	15,000 (24 000)	18,000 (29 000)
Change engine oil and engine oil filter.	X	X	X	X	X	X
Inspect the <b>air cleaner filter</b> and replace if required.*	X	X	X	X		X
Replace the <b>air cleaner filter</b> . *					X	
Inspect the front and rear brake linings and rotors.			X			X
Adjust the drive belt tension.					X	



Miles (Kilometers)	21,000 (34 000)	24,000 (38 000)	27,000 (43 000)	30,000 (48 000)	33,000 (53 000)	36,000 (58 000)
Change engine oil and engine oil filter.	X	X	X	X	X	X
Inspect the <b>air cleaner filter</b> and replace if required.*	X	X	X		X	X
Replace the <b>air cleaner filter</b> .				X		
Inspect the front and rear brake linings and rotors.			X			X
Adjust the drive belt tension.				X		
Check and replace, if necessary, the <b>PCV valve</b> . *				X		

**242 SCHEDULE "B"**

Miles (Kilometers)	39,000 (62 000)	42,000 (67 000)	45,000 (72 000)	48,000 (77 000)	51,000 (82 000)	54,000 (86 000)
Change engine oil and engine oil filter.	X	X	X	X	X	X
Inspect the <b>air cleaner filter</b> and replace if required.*	X	X		X	X	X
Replace the <b>air cleaner filter</b> . *			X			
Adjust the drive belt tension.			X			
Inspect the front and rear brake linings and rotors.			X			X
Replace the differential fluid.				X		

Miles (Kilometers)	57,000 (91 000)	60,000 (96 000)	63,000 (101 000)	66,000 (106 000)	69,000 (110 000)	72,000 (115 000)
Change engine oil and engine oil filter.	X	X	X	X	X	X
Inspect the <b>air cleaner filter</b> and replace if required.*	X		X	X	X	X
Replace the <b>air cleaner filter</b> .		X				
Inspect the front and rear brake linings and rotors.			X			X
Replace the drive belts.		X				
Replace the power steering fluid.		X				
Check and replace, if necessary, the <b>PCV valve</b> . * ‡		X				
Change the automatic transaxle fluid and filter.		X				

**244 SCHEDULE "B"**

Miles (Kilometers)	75,000 (120 000)	78,000 (125 000)	81,000 (130 000)	84,000 (134 000)	87,000 (139 000)	90,000 (144 000)
Change engine oil and engine oil filter.	X	X	X	X	X	X
Inspect the <b>air cleaner filter</b> and replace if required.*		X	X	X	X	
Replace the <b>air cleaner filter.</b> *	X					
Replace the <b>air cleaner filter.</b>						X
Adjust the drive belt tension.	X					X
Inspect the front and rear brake linings and rotors.			X			X
Check and replace, if necessary, the <b>PCV valve.</b> * ‡						X

Miles (Kilometers)	93,000 (149 000)	96,000 (154 000)	99,000 (158 000)	100,000 (160 000)	102,000 (163 000)	105,000 (168 000)
Change engine oil and engine oil filter.	X	X	X		X	X
Inspect the <b>air cleaner filter</b> and replace if required.*	X	X	X		X	
Replace the <b>air cleaner filter</b> .						X
Inspect the front and rear brake linings and rotors.			X			
Flush and replace the engine coolant.				X		
Replace the <b>engine timing belt</b> (Federal Emissions).				X		
Replace the <b>engine timing belt</b> (California Emissions).						X
Replace the <b>spark plugs</b> .				X		
Adjust the drive belt tension.						X
Change the differential fluid.		X				

\* This maintenance is recommended by the manufacture to the owner but is not required to maintain the emissions warranty.

Inspection and service should also be performed anytime a malfunction is observed or suspected. Retain all receipts.

‡ This maintenance is not required if previously replaced.

246 SCHEDULE "A"

**SCHEDULE "A"**

Miles (Kilometers) [Months]	6,000 (10 000) [6]	12,000 (19 000) [12]	18,000 (29 000) [18]	24,000 (38 000) [24]	30,000 (48 000) [30]	36,000 (58 000) [36]
Change engine oil and engine oil filter.	X	X	X	X	X	X
Inspect the <b>air cleaner filter</b> and replace if required.*	X	X	X	X		X
Replace the <b>air cleaner filter</b> . *					X	
Adjust the drive belt tension.					X	
Inspect the front and rear brake linings and rotors.			X			X
Inspect and replace PCV valve if required.					X	

Miles (Kilometers) [Months]	42,000 (67 000) [42]	48,000 (77 000) [48]	54,000 (86 000) [54]	60,000 (96 000) [60]	66,000 (106 000) [66]	72,000 (115 000) [72]
Change engine oil and engine oil filter.	X	X	X	X	X	X
Inspect the <b>air cleaner filter</b> and replace if required.*	X	X	X		X	X
Replace the <b>air cleaner filter</b> . *				X		
Replace the drive belts.				X		
Inspect the front and rear brake linings and rotors.			X			X
Flush and replace engine coolant at 60 months or 100,000 miles.				X		
Check and replace, if necessary, the <b>PCV valve</b> . *				X		

248 SCHEDULE "A"

Miles (Kilometers) [Months]	78,000 (125 000) [78]	84,000 (134 000) [84]	90,000 (144 000) [90]	96,000 (154 000) [96]	102,000 (163 000) [102]
Change engine oil and engine oil filter.	X	X	X	X	X
Inspect the <b>air cleaner filter</b> and replace if required.*	X	X		X	X
Replace the <b>air cleaner filter</b> . *			X		
Adjust the drive belt tension.			X		
Inspect the front and rear brake linings and rotors.			X		
Replace the <b>spark plugs</b> .					X
Check and replace, if necessary, the <b>PCV valve</b> . *‡			X		
Replace the <b>engine timing belt</b> (Federal Emissions equipped vehicles only).					X
Replace the <b>engine timing belt</b> (California Emissions equipped vehicles only).					X
Flush and replace the engine coolant at 60 months or 100,000 miles.					X

\* This maintenance is recommended by the manufacture to the owner but is not required to maintain the emissions warranty.

Inspection and service should also be performed anytime a malfunction is observed or suspected. Retain all receipts.

‡ This maintenance is not required if previously replaced.



**WARNING!**

You can be badly injured working on or around a motor vehicle. Do only that service work for which you have the knowledge and the right equipment. If you have any doubt about your ability to perform a service job, take your vehicle to a competent mechanic.



---

# IF YOU NEED CONSUMER ASSISTANCE

## CONTENTS

---

■ Suggestions For Obtaining Service For Your Vehicle . . . . .	252	■ Reporting Safety Defects . . . . .	255
□ Prepare For The Appointment . . . . .	252	□ In Canada . . . . .	255
□ Prepare A List . . . . .	252	■ Publication Order Forms . . . . .	257
□ Be Reasonable With Requests . . . . .	252	■ Department Of Transportation Uniform Tire Quality Grades . . . . .	259
■ If You Need Assistance . . . . .	252	□ Treadwear . . . . .	259
■ Warranty Information . . . . .	254	□ Traction Grades . . . . .	259
■ Mopar® Parts . . . . .	255	□ Temperature Grades . . . . .	259

## **SUGGESTIONS FOR OBTAINING SERVICE FOR YOUR VEHICLE**

### **Prepare For The Appointment**

If you're having warranty work done, be sure to have the right papers with you. Take your warranty folder. All work to be performed may not be covered by the warranty, discuss additional charges with the service manager. Keep a maintenance log of your vehicle's service history. This can often provide a clue to the current problem.

### **Prepare A List**

Make a written list of your vehicle's problems or the specific work you want done. If you've had an accident, or work done that is not on your maintenance log, let the service advisor know.

### **Be Reasonable With Requests**

If you list a number of items, and you must have your vehicle by the end of the day, discuss the situation with the service advisor and list the items in order of priority. At many dealers you may obtain a rental vehicle at a minimal daily charge. If you need a rental, it is advisable to make these arrangements when you call for an appointment.

## **IF YOU NEED ASSISTANCE**

The manufacturer and its dealers are vitally interested in your satisfaction. We want you to be happy with our products and services.

Your selling dealer is best equipped and most anxious to provide prompt resolution for any warranty issue or related matter that you may experience. The manufacturer's dealers have the facilities, factory-trained technicians, special tools, and the latest information to assure your vehicle is fixed correctly and in a timely manner. The manufacturer has empowered its dealers to make warranty and repair decisions that ensure you are not inconvenienced. There is no need for you to wait for a decision from the manufacturer. If a special circumstance occurs that requires information from the manufacturer, we have asked the dealer's service management to make the contact on your behalf.

This is why you should always talk to your dealer's service manager first. Most matters can be resolved with this process.

- If for some reason you are still not satisfied, talk to the general manager or owner of the dealership. They want to know if you need assistance.
- If your dealership is unable to resolve the concern, you may contact the Manufacturer's Customer Center.

Any communication to the Manufacturer's Customer Center should include the following information:

- Owner's name and address
- Owner's telephone number (home and office)
- Dealership name
- Vehicle identification number
- Vehicle delivery date and mileage

***DaimlerChrysler Motors Corporation Customer Center***

P.O. Box 21-8004  
 Auburn Hills, MI 48321-8004  
 Phone: (800) 992-1997

***DaimlerChrysler Canada Inc. Customer Center***

P.O. Box 1621  
 Windsor, Ontario N9A 4H6  
 Phone —(800) 465-2001

***In Mexico contact:***

Av. Prolongacion Paseo de la Reforma, 1240  
 Sante Fe C.P. 05109  
 Mexico, D. F.  
 In Mexico (915) 729-1248 or 729-1240  
 Outside Mexico (525) 729-1248 or 729-1240

***Customer Assistance For The Hearing Or Speech Impaired (TDD/TTY)***

To assist customers who have hearing difficulties, the manufacturer has installed special TDD (Telecommunication Devices for the Deaf) equipment at its Customer Center. Any hearing or speech impaired customer who has access to a TDD or a conventional teletypewriter (TTY) in the United States can communicate with the manufacturer by dialing 1-800-380-CHRY.

**Service Contract**

You may have purchased a service contract for your vehicle to help protect you from the high cost of unexpected repairs after your manufacturer's new vehicle limited warranty expires. The manufacturer stands behind only the manufacturer's Service Contracts. If you purchased a manufacturer's Service Contract, you will receive Plan Provisions and an Owner Identification Card in the mail within three weeks of your vehicle delivery date. If you have any questions about your service contract, call the manufacturer's Service Contract National Customer Hotline at 1-800-521-9922.

The manufacturer will not stand behind any service contract that is not the manufacturer's Service Contract. It is not responsible for any service contract other than the manufacturer's Service Contract. If you purchased a service contract that is not a manufacturer's Service Contract, and you require service after your manufacturer's new vehicle limited warranty expires, please refer to your contract documents, and contact the person listed in those documents.

We appreciate that you have made a major investment when you purchased your new vehicle. Your dealer has also made a major investment in facilities, tools, and training to assure that you are absolutely delighted with your ownership experience. You'll be pleased with their sincere efforts to resolve any warranty issues or related concerns.

**WARRANTY INFORMATION**

See your manufacturer's Warranty Information Booklet for information on warranty coverage and transfer of warranty.

**TIME/MILEAGE**

1 YEAR/ 12,000	2 YEAR/ 24,000	3 YEAR/ 36,000	3 YEAR/ 50,000	3 YEAR/ UNLMTD	5 YEAR/ 100,000	7 YEAR/ 70,000	8 YEAR/ 80,000
<b>BASIC LIMITED WARRANTY COVERAGE</b>							
<b>SPECIAL EXTENDED WARRANTY COVERAGE</b>							
<b>ANTI-CORROSION PERFORATION: ALL PANELS</b>							
<b>OUTER PANELS</b>							
<b>FED. EMISSION WARR.</b>							
<b>FEDERAL EMISSION WARRANTY - SPECIFIED COMPONENTS</b>							
<b>CALIFORNIA EMISSION WARRANTY</b>							
<b>CALIFORNIA EMISSION WARRANTY - SPECIFIED COMPONENTS</b>							
							80b88ac0

## **MOPAR® PARTS**

Mopar® fluids, lubricants, parts, and accessories are available from your dealer. They will help you keep your vehicle operating at its best.

## **REPORTING SAFETY DEFECTS**

In the 50 United States and Washington D.C.: If you believe that your vehicle has a defect which could cause a crash or cause injury or death, you should immediately inform the National Highway Traffic Safety Administration (NHTSA) in addition to notifying the manufacturer.

If NHTSA receives similar complaints, it may open an investigation, and if it finds that a safety defect exists in a group of vehicles, it may order a recall and remedy campaign. However, NHTSA cannot become involved in individual problems between you, your dealer, and the manufacturer.

To contact NHTSA, you may either call the Auto Safety Hotline toll free at 1-800-424-9393 (or 366-0123 in Washington DC area) or write to: NHTSA, U.S. Dept. of Transportation, Washington DC 20590. You can also obtain other information about motor vehicle safety from the Hotline.

### **In Canada:**

If you believe that your vehicle has a safety defect, you should contact the Customer Service Department immediately. Canadian customers who wish to report a safety defect to the Canadian government should write to Transport Canada, Motor Vehicle Defect Investigations and Recalls, 2780 Sheffield Road, Ottawa, Ontario K1B 3V9.





## PUBLICATION ORDER FORMS

**U.S. RESIDENTS ONLY** To order the publications shown, tear out this page, fill in **all** information and mail to the address below. Enclose a check or money order payable to DaimlerChrysler. **Visa and Mastercard orders** are accepted by telephone. Please have your card and order information available when you call our distributor. Please allow 30 days.

*Prices subject to change without notice.*

**Dymet Distribution Services**  
**P.O. Box 360450**  
**Strongsville, OH 44136 1-800-890-4038**

*The toll-free number is not answered by DaimlerChrysler.*

PLEASE TYPE OR PRINT	
Name	_____
Address	_____
City	_____
State	Zip
Date	_____
Amount of check or money order \$	_____

**SERVICE MANUAL: \$110.00 + TAX**  
Specify year, make and model  
(example: 2002 Dodge Caravan)

---

**OWNER'S MANUAL: \$10.00 + TAX**  
Specify year, make and model  
(example: 2002 Dodge Caravan)

---

**DaimlerChrysler Child Seat instructions**  
(if applicable) Specify year, make and model  
(example: 1997 Dodge Caravan)

---

**Shipping and Handling:** Purchase up to \$40.00 add \$4.00. Purchases over \$40.00 add 10% of the total order.

## CANADIAN RESIDENTS ONLY

To order the publications shown, tear out this page, fill in **all** information and mail to the address below. Enclose a cheque or money order payable to DaimlerChrysler Canada Inc. **Visa and Mastercard orders** are accepted by telephone. Please have your card and order information available when you call our distributor. Please allow 30 days.

*Prices subject to change without notice.*

### Dyment Distribution Services

210 Wicksteed Ave.

Toronto, ON M4G 2C3

1-800-387-1143

*The toll-free number is not answered by DaimlerChrysler.*

PLEASE TYPE OR PRINT	
Name	_____
Address	_____
City	_____
Province	Postal Code
_____	_____
Date	_____
Amount of cheque or money order \$	_____

- SERVICE MANUAL: \$110.00 + GST**  
English only. Specify year, make and model  
(example: 2002 Dodge Caravan)

- \_\_\_\_\_
- OWNER'S MANUAL: \$10.00 + GST**  
Specify language  English  French  
and year, make and model:

- \_\_\_\_\_
- DaimlerChrysler Child Seat instructions  
(if applicable) Specify language  English  
 French and year, make and model:

\_\_\_\_\_

GST Reg. No. R100963941

80ea318f

## DEPARTMENT OF TRANSPORTATION UNIFORM TIRE QUALITY GRADES

The following describes the tire grading categories established by the National Highway Traffic Safety Administration. The specific grade rating assigned by the tire's manufacturer in each category is shown on the sidewall of the tires on your car.

All Passenger Car Tires Must Conform to Federal Safety Requirements in Addition to These Grades.

### Treadwear

The treadwear grade is a comparative rating based on the wear rate of the tire when tested under controlled conditions on a specified government test course. For example, a tire graded 150 would wear one and a half (1 1/2) times as well on the government course as a tire graded 100. The relative performance of tires depends upon the actual conditions of their use, however, and may depart significantly from the norm due to variations in driving habits, service practices and differences in road characteristics and climate.

### Traction Grades

The traction grades, from highest to lowest, are A, B, and C, and they represent the tire's ability to stop on wet pavement as measured under controlled conditions on specified government test surfaces of asphalt and concrete. A tire marked C may have poor traction performance.

### WARNING!

**The traction grade is based on braking (straight-ahead) traction tests and does not include cornering (turning) performance.**

### Temperature Grades

The temperature grades are A (highest), B, and C, representing the tire's resistance to the generation of heat and its ability to dissipate heat when tested under controlled conditions on a specified indoor laboratory test wheel. Sustained high temperature can cause the material of the tire to degenerate and reduce tire life, and excessive temperature can lead to sudden tire failure. The grade C

corresponds to a level of performance which all passenger car tires must meet under the Federal Motor Vehicle Safety Standard No. 109. Grades B and A represent higher levels of performance on the laboratory test wheel than the minimum required by law.

**WARNING!**

**The temperature grade is established for a tire that is properly inflated and not overloaded. Excessive speed, underinflation, or excessive loading, either separately or in combination, can cause heat buildup and possible tire failure.**

---

# INDEX

About Your Brakes . . . . .	157	Appearance Care . . . . .	220
ABS (Anti-Lock Brake) System . . . . .	112	Auto Down Power Windows . . . . .	25
Accident Damage . . . . .	221	Automatic Dimming Mirror . . . . .	56
Adding Engine Coolant (Antifreeze) . . . . .	211	Automatic Door Locks . . . . .	16
Adding Fuel . . . . .	170	Automatic Headlights . . . . .	67,70
Air Cleaner, Engine . . . . .	202	Automatic Off, Interior Lights . . . . .	65
Air Conditioning . . . . .	137,140	Automatic Temperature Control . . . . .	140
Air Conditioning Controls . . . . .	137,140	Automatic Transaxle . . . . .	153,217
Air Conditioning, Operating Tips . . . . .	146	Fluid and Filter Changes . . . . .	219
Air Conditioning Refrigerant . . . . .	205	Fluid Level Check . . . . .	218
Air Conditioning System . . . . .	204	Reset Mode . . . . .	154
Air Pressure, Tires . . . . .	159,161	Selection Of Lubricant . . . . .	217
Airbag . . . . .	33	Shifting . . . . .	154
Airbag Deployment . . . . .	37,38	Special Additives . . . . .	219
Airbag Light . . . . .	37,41,49,111	Backfire, Engine . . . . .	202
Airbag Maintenance . . . . .	40	Ball Joints . . . . .	207
Alarm System . . . . .	23	Battery . . . . .	182,203
Alignment and Balance . . . . .	167	Emergency Starting . . . . .	182
Antifreeze Disposal . . . . .	211	Gas Caution . . . . .	182,203
Antifreeze (Engine Coolant) . . . . .	211	Jump Starting . . . . .	182
Anti-Lock Brake System . . . . .	157	Keyless Transmitter Replacement . . . . .	22
Anti-Lock Warning Light . . . . .	112	Location . . . . .	183,203
Anti-Theft Security Alarm . . . . .	23		

Saving Feature . . . . .	65,66,68	Luggage Carrier . . . . .	172
Belts, Drive . . . . .	200	Carpeting . . . . .	221
Belts, Engine . . . . .	202	Cassette Tape and Player Maintenance . . . . .	135
Body Mechanism Lubrication . . . . .	207	Cassette Tape Player . . . . .	114,121,135
Brake, Parking . . . . .	156	Catalytic Converter . . . . .	200
Brake System . . . . .	157,214	CD Changer . . . . .	124,129,130
Anti-Lock . . . . .	157	CD Player . . . . .	119,126,128,134
Fluid Check . . . . .	216	Central Door Locks . . . . .	15
Hoses . . . . .	215	Chains, Tire . . . . .	163
Master Cylinder . . . . .	216	Changing A Flat Tire . . . . .	177
Warning Light . . . . .	112	Charging System Light . . . . .	112
Brake/Transmission Interlock . . . . .	153,154	Check Engine Light . . . . .	111
Break-In Recommendations, New Vehicle . . . . .	48	Checks, Safety . . . . .	49
Brightness, Interior Lights . . . . .	65	Child Restraint . . . . .	41,43,45,46
Bulb Replacement . . . . .	227	Child Restraint Tether Anchors . . . . .	44,45
Bulbs, Light . . . . .	226,227	Child Safety Locks . . . . .	15
Calibration, Compass . . . . .	98	Circuit Breakers . . . . .	224
Capacities, Fluid . . . . .	233	Clean Air Gasoline . . . . .	168
Capacity, Cargo Weight . . . . .	171	Cleaning . . . . .	
Car Washes . . . . .	220,221	Carpets . . . . .	221
Cargo Compartment . . . . .		Cloth . . . . .	221
Capacity . . . . .	171	Glass . . . . .	223
		Headlights . . . . .	222

Instrument Panel . . . . .	223	Drain, Flush, and Refill . . . . .	211
Seat Belts . . . . .	223	Inspection . . . . .	210
Vinyl . . . . .	221	Points to Remember . . . . .	213
Washing . . . . .	220	Pressure Cap . . . . .	212
Waxing . . . . .	221	Radiator Cap . . . . .	212
Wheels . . . . .	221	Rubber and Plastic Components . . . . .	214
Windshield Wiper Blades . . . . .	209	Selection of Coolant . . . . .	211
Climate Control . . . . .	137	Corrosion Protection . . . . .	220
Clock . . . . .	113	Courtesy Lights . . . . .	66
Coat Hook . . . . .	55	Crankcase Emission Control System . . . . .	202
Compact Disc Maintenance . . . . .	136	Cruise Light . . . . .	73,110
Compact Disc Player . . . . .	114,119	Cup Holder . . . . .	55
Compact Spare Tire . . . . .	162	Customer Assistance . . . . .	252
Compass . . . . .	94,98	Daytime Brightness, Interior Lights . . . . .	65
Compass Calibration . . . . .	94,98	Daytime Running Lights . . . . .	68
Compass Variance . . . . .	95	Dealer Service . . . . .	193
Computer, Trip/Travel . . . . .	93,96	Defroster, Rear Window . . . . .	139
Console, Overhead . . . . .	75	Defroster, Windshield . . . . .	50,138,143
Contract, Service . . . . .	254	Diagnostic System, Onboard . . . . .	111,191
Cooling System . . . . .	210	Dimmer Switch, Headlight . . . . .	69
Adding Coolant (Antifreeze) . . . . .	211	Disabled Vehicle Towing . . . . .	186
Coolant Level . . . . .	213		
Disposal of Used Coolant . . . . .	211		



Disposal		Break-In Recommendations . . . . .	48
Antifreeze . . . . .	211	Checking Oil Level . . . . .	194
Engine Oil . . . . .	199	Compartment . . . . .	189,190
Door Locks . . . . .	14,15	Cooling . . . . .	110,210
Door Locks, Automatic . . . . .	16	Fails to Start . . . . .	152
Door Locks, Central . . . . .	15	Oil . . . . .	109,194
Door Opener, Garage . . . . .	76,81	Oil Change Interval . . . . .	197
Drive Belts . . . . .	200	Oil Selection . . . . .	198
Drive Shaft Universal Joints . . . . .	207	Oil Synthetic . . . . .	199
Driver's Seat Glide Feature . . . . .	60	Overheating . . . . .	110,176
Driving		Specifications . . . . .	232
On Slippery Surfaces . . . . .	185	Timing Belt . . . . .	202
With an Automatic Transaxle . . . . .	153	Entry System, Illuminated . . . . .	14
Electric Remote Mirrors . . . . .	57	Exhaust Gas Caution . . . . .	49,82,210
Electronic Speed Control . . . . .	72	Exhaust System . . . . .	210
Electronic Vehicle Information Center . . . . .	88	Exterior Lights . . . . .	66,227
Emergency Flashers . . . . .	176	Filters	
Emission Control System Maintenance . . . . .	192,202,236	Air Cleaner . . . . .	202
Engine		Automatic Transaxle . . . . .	219
Backfire . . . . .	202	Engine Fuel . . . . .	202
Block Heater . . . . .	153	Engine Oil . . . . .	200

Flashers			
Hazard Warning	176		
Flat Tire Changing	177		
Floor Shift Interlock	13		
Fluid Capacities	233		
Fluid Leaks	50		
Fluid Level Checks	218		
Fog Lights	68		
Freeing A Stuck Vehicle	186		
Fuel	109,167		
Adding	170		
Filler Cap	171		
Filter	202		
Gauge	109		
Materials Added	169		
Octane Rating	167		
System Hoses	217		
Fuses	224,225		
Garage Door Opener	76,81		
Gas Cap	171		
Gasoline, Reformulated	168		
Gasoline/Oxygenate Blends	168		
Gauges			
Coolant Temperature	110		
Fuel	109		
Oil Pressure	109		
Speedometer/Odometer	111		
Glass Cleaning	223		
Glove Compartment	13		
Hazard Warning Flasher	176		
Head Restraints	63		
Headlights			
Automatic	67		
Bulb Replacement	226,227		
Cleaning	222		
Dimmer Switch	69		
Lights On Reminder	67		
Switch	66		
Time Delay	67		
Heated Mirrors	56		
Heated Seats	61		
Heater	137,140		
High Beam Indicator	110		
Holder, Cup	55		

Homelink Transmitter . . . . .	76,81	Key-In Reminder . . . . .	12
Hood Release . . . . .	64	Keyless Entry System . . . . .	18
Hook, Coat . . . . .	55	Keys . . . . .	9
Hoses . . . . .	214,217	Knee Bolster . . . . .	33
Ignition		Lap/Shoulder Belts . . . . .	28
Key . . . . .	12	LATCH	
Lock . . . . .	13	(Lower Anchors and Tether for CHildren) . . . . .	45
Illuminated Entry . . . . .	14	Leaks, Fluid . . . . .	50
Infant Restraint . . . . .	42	Light Bulbs . . . . .	226,227
Instrument Cluster . . . . .	107,108,109	Lights	
Instrument Panel and Controls . . . . .	105,106	Airbag . . . . .	37,49,111
Instrument Panel Cover . . . . .	223	Anti-Lock . . . . .	112
Instrument Panel Lens Cleaning . . . . .	223	Automatic Off . . . . .	65,66
Interior Fuses . . . . .	225	Back-Up . . . . .	231
Interior Lights . . . . .	65,226	Battery Saver . . . . .	65,66
Intermittent Wipers . . . . .	70	Brake Warning . . . . .	112,156
Introduction . . . . .	4	Center Mounted Stop . . . . .	231
Jack Operation . . . . .	178	Check Engine . . . . .	111
Jump Starting . . . . .	182	Courtesy/Reading . . . . .	66
Key, Sentry . . . . .	9	Cruise . . . . .	73,110
		Daytime Running . . . . .	68
		Dimmer Switch, Headlight . . . . .	69

Dome	75	Service Engine Soon	191
Door Ajar	110	Side Marker	226,230
Exterior Check	50	Theft Alarm	10
Fog	68,230	Traction Control	72,159
Front Replacement	226	Trunk Ajar	109
Hazard Warning Flasher	176	Turn Signal	110,230,231
Headlight Switch	66	Voltage	112
Headlights	66,226,227	Locks	
High Beam Indicator	110	Cylinder Maintenance	15
Illuminated Entry	14	Door	14,15
Instrument Cluster	65	Glove Compartment	13
Interior	14,65	Lubricants	207
License	232	Luggage Carrier	172
Low Fuel	109	Luggage Rack	172
Malfunction Indicator	169,191	Lumbar Support	61
Map Reading	66	Maintenance Free Battery	203
Oil Pressure	109	Maintenance Schedule	236
Park	66,227,230	Light Duty Schedule "B"	239
Passing	69	Schedule "A"	246
Reading	75	Schedule "B"	239
Rear Tail	231	Malfunction Indicator Light	111,169,192
Seat Belt Reminder	110	Manual, Service	257
Security Alarm	24		

Memory Feature . . . . .	57,61	Quality . . . . .	198
Memory Seat . . . . .	21	Recommendation . . . . .	198
Mini-Trip Computer . . . . .	93	Synthetic . . . . .	199
Mirrors . . . . .	56	Onboard Diagnostic System . . . . .	191,192
Automatic Dimming . . . . .	56	Opener, Garage Door . . . . .	76,81
Electric Remote . . . . .	57	Operator Manuals . . . . .	4
Heated . . . . .	56	Overhead Console . . . . .	75,96
Outside . . . . .	57	Overhead Travel Information Center . . . . .	96
Rearview . . . . .	56	Overheating, Engine . . . . .	176
Vanity . . . . .	58	Owner's Manual . . . . .	4,257
Mopar Parts . . . . .	193,255	Paint Care . . . . .	220
Multi-Function Control Lever . . . . .	68	Paint Damage . . . . .	220
Occupant Restraints . . . . .	27	Panic Alarm . . . . .	20
Odometer . . . . .	111	Parking Brake . . . . .	156
Oil, Engine . . . . .	194	Parking On Hill . . . . .	156
Change Interval . . . . .	197	Passing Light . . . . .	69
Checking . . . . .	194	Pets . . . . .	48
Dipstick . . . . .	194	Pets, Transporting . . . . .	48
Disposal . . . . .	199	Power . . . . .	
Filter . . . . .	200	Distribution Center . . . . .	224
Identification Logo . . . . .	198	Door Locks . . . . .	14
Materials Added to . . . . .	199	Outlet . . . . .	100

Seats	59	Remote Keyless Entry	18
Steering	158	Remote Trunk Release	25
Steering, Checking	205	Replacement Bulbs	226
Sunroof	87	Replacement Tires	165
Trunk Lid	25	Reporting Safety Defects	255
Windows	25	Restraint, Head	63
Pregnant Women and Seat Belts	32	Restraints, Occupant	27
Programmable Electronic Features	77,80,82,86	Rotation, Tires	166
Programming Transmitters	20,77,80,82,86		
		Safety Checks Inside Vehicle	49
Radial Ply Tires	162	Safety Checks Outside Vehicle	50
Radiator Cap	212	Safety, Exhaust Gas	49
Radio	114,121,126	Safety Tips	49
Radio Operation	134,136	Schedule, Maintenance	236
Radio Remote Controls	133	Scheduled Maintenance	194
Rear Window Defroster	139	Seat Belt Maintenance	223
Reclining Front Seats	59	Seat Belts	27,28
Recommended Fluids, Lubricants and Genuine Parts	233	Adjustable Upper Shoulder Anchorage	32
Reformulated Gasoline	168	Child Restraint	46
Refrigerant	205	Extender	32
Reminder, Lights On	67	Inspection	49
		Reminder	110

Seats . . . . .	59	Engine . . . . .	232
Cleaning . . . . .	221	Speed Control . . . . .	72
Glide-To-Exit . . . . .	60	Speed Proportional Steering . . . . .	158
Heated . . . . .	61	Speedometer . . . . .	110
Lumbar Support . . . . .	61	Starting . . . . .	151
Power . . . . .	59	Steering	
Reclining . . . . .	59	Linkage . . . . .	207
Sentry Key . . . . .	9	Power . . . . .	158,205
Service Assistance . . . . .	252	Speed Proportional . . . . .	158
Service Contract . . . . .	254	Tilt Column . . . . .	71
Service Engine Soon Light . . . . .	191	Steering Wheel Mounted Sound System	
Service Manuals . . . . .	257	Controls . . . . .	133
Setting the Clock . . . . .	113	Stuck, Freeing . . . . .	186
Shoulder Belts . . . . .	32	Sulfur in Gasoline . . . . .	169
Side Airbag . . . . .	39	Sun Roof . . . . .	87,88
Side View Mirror Adjustment . . . . .	57	Supplemental Restraint System - Airbag . . . . .	33
Side Window Demisters . . . . .	144	Synthetic Engine Oil . . . . .	199
Slippery Surfaces, Driving On . . . . .	185		
Snow Chains . . . . .	163	Tachometer . . . . .	109
Snow Tires . . . . .	164	Tape Player . . . . .	134
Spare Tire . . . . .	162	Temperature Gauge, Engine Coolant . . . . .	177
Spark Plugs . . . . .	200	Theft Alarm . . . . .	23
Specifications . . . . .	232	Theft System . . . . .	23

Tilt Steering Column . . . . .	71	Towing . . . . .	172
Time Delay, Headlight . . . . .	67	Disabled Vehicle . . . . .	186
Timing Belt . . . . .	202	Trailer . . . . .	172
Tires . . . . .	50,159,259	Traction Control . . . . .	72,109,159
Air Pressure . . . . .	159,161	Trailer Towing . . . . .	172
Alignment . . . . .	167	Transaxle	
Balancing . . . . .	167	Additives . . . . .	219
Chains . . . . .	163	Automatic . . . . .	153,217
Changing . . . . .	177,178	Filter . . . . .	219
Flat Changing . . . . .	177	Operation . . . . .	154
High Speed . . . . .	161	Selection of Lubricant . . . . .	217
Jacking . . . . .	178	Transmission	
Pressure Label . . . . .	161	Range Indicator . . . . .	112,154
Quality Grading . . . . .	259	Transmitter Battery Service . . . . .	22
Radial . . . . .	162	Transmitter, Garage Door Opener . . . . .	76,81
Replacement . . . . .	165	Transmitter Programming . . . . .	20
Rotation . . . . .	166	Transporting Pets . . . . .	48
Snow Tires . . . . .	164	Traveler Trip Computer . . . . .	93
Spare Tire . . . . .	162	Tread Wear Indicators . . . . .	164
Spinning . . . . .	163	Trip Computer . . . . .	93,96
Tread Wear Indicators . . . . .	164	Trip Odometer . . . . .	98
To Open Hood . . . . .	64	Trip Odometer Reset Button . . . . .	111



Trunk Release, Emergency . . . . .	26	Warning Flasher, Hazard . . . . .	176
Trunk Release Remote Control . . . . .	25	Warnings and Cautions . . . . .	6
Turn Signals . . . . .	68,110	Warranty Information . . . . .	172,254
Underhood Fuses . . . . .	224	Washers, Windshield . . . . .	209
Uniform Tire Quality Grades . . . . .	259	Washing Vehicle . . . . .	220
Universal Joints . . . . .	207	Waxing and Polishing . . . . .	220
Universal Transmitter . . . . .	76,81	Wind Buffeting . . . . .	88
Vacuum/Vapor Harnesses . . . . .	214	Windows	
Vehicle Identification Number . . . . .	6	Power . . . . .	25
Vehicle Loading . . . . .	171	Windshield Defroster . . . . .	138
Vinyl Trim . . . . .	221	Windshield Washers . . . . .	69,209
		Windshield Wipers . . . . .	67,69,209
		Wipers, Intermittent . . . . .	70