

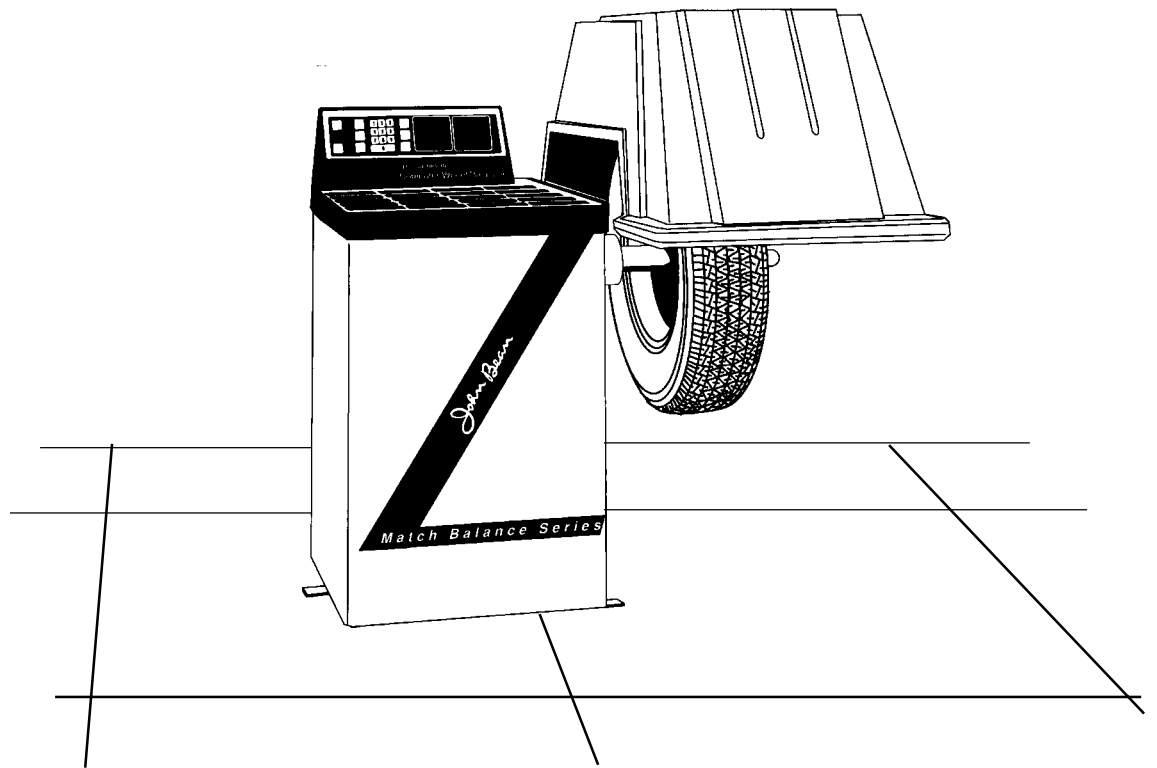

4100 Digital Wheel Balancer Operators Manual



IMPORTANT SAFETY INSTRUCTIONS

When using this equipment, basic safety precautions should always be followed, including the following:

1. Read all instructions.
2. Do not operate equipment with a damaged power cord or if the equipment has been damaged - until it has been examined by a qualified authorized service technician.
3. If an extension cord is used, a cord with a current rating equal to or more than that of the machine should be used. Cords rated for less current than the equipment may overheat. Care should be taken to arrange the cord so that it is not be tripped over or pulled.
4. Always unplug equipment from electrical outlet when not in use. Never use the cord to pull the plug from the outlet. Grasp plug and pull to disconnect.
5. To reduce the risk of fire, do not operate equipment in the vicinity of open containers of flammable liquids (gasoline).
6. Keep hair, loose fitting clothing, fingers and all parts of the body away from moving parts.
7. Adequate ventilation should be provided when working on operating internal combustion engines.
8. To reduce the risk of electric shock, do not use on wet surfaces or expose to rain.
9. Do not hammer on or hit any part of the machine with weight pliers.
10. Do not disable the hood safety interlock system or bypass the intended operation.
11. Do not allow unauthorized personnel to operate the equipment.
12. Use only as described In this manual. Use only manufacturer's recommended attachments.
13. Always securely tighten the wing nut before spinning the shaft.
14. **ALWAYS WEAR SAFETY GLASSES.** Everyday eyeglasses only have impact resistant lenses, they are NOT safety glasses.
15. Do not raise wheel guard until wheel is completely stopped

SAVE THESE INSTRUCTIONS

TABLE OF CONTENTS

	Page
Introduction and Specifications	4
I Equipment/Accessories	5
II Installation	6
III Principles of Operation	7
IV Calibration	8
V Mounting	9
VI Balancing Std. Wheels	11
Weight Application Chart	12-13
Function Codes	14
Match Balancing	16-17
Calibration Check Procedure	18
Preventive Maintenance Tips	18
Vibration Complaint Diagnostics	19-20

TO THE PURCHASER

Congratulations! You have purchased one of the finest wheel balancers built today. It will bring you many years of dependable service and a rewarding return on your investment. Please read this Operating Manual carefully. It contains step by step operating procedures that will enable you to make maximum use of your balancer. The manual contains information on calibration and preventive maintenance tips. Your balancer incorporates the latest electronic technology and offers these features:

Programmed Computer Balance: Operator actually programs the balancing computer for wheel size, diameter, and location on the balancing shaft (distance). Ability to program for specific wheel size permits extreme accuracy.

Microprocessor Computer Control: Finger tip data entry insures ease of operation. The unique keyboard and computer combination provide a visual indication of each step performed for programming. Computer to operator **feedback** reduces operator error.

Automatic Single Spin: Operator closes wheel cover (if auto-spin model) or pushes SPIN button (early machines or one with auto-spin function disabled) and balancer starts spinning, makes imbalance measurements, and stops automatically within seconds.

Precise Weight Amount and Location: Weight amount is accurate to 0.1 oz. (2.8gm). Weight angle resolution is 1.4°. This provides precision wheel balancing that virtually eliminates vibration complaints. Automatic cycle plus centering cone mounting means wheel balancing is done accurately the first time.

Overhead Guard With Safety Interlock: Guard swings overhead requiring minimum floor space. Balancer will not operate unless guard is safely in place over tire/wheel.

Static Balance: Built-in static feature enables static balancing only. No need to turn down special wheel balancing applications.

Special ALU Mode: Automatic data entry for hidden weight placement on aluminum styled wheels. Eliminates tape measurements for correct weight placement in many instances.

Special Wheel Capability: Adapters allow balancing of almost all wheels including specialty OEM, foreign cars, and aftermarket alloy wheels without the need to use face plates.

Dynamic Self-Calibration: Operator calibrates unit in a matter of seconds. Complete system is calibrated under actual operating conditions using calibration weight supplied with the unit. Special adapters, adjustment tools, and training are not necessary.

Match Balancing Capability: The John Bean computerized Match Balance program can be used to perform diagnosis and/or correction of problems resulting from rims and tires with runout and imbalance conditions.

Generous Weight Storage: 17 weight storage bins are provided. Operator need not lose time and efficiency hunting for weights.

Drive Motor: Rated at 1/2HP - less strain and longer motor life.

Specifications:

Accuracy: To 0.10 oz. (2.8gm)
Digital Readout: ounces or grams
Spin: Automatic or manual

9 BALANCING MODES

Static or dynamic balance
6 weight placement (Alum) modes
Match Balancing

- Single spin balance
- Enclosed wheel guard with safety interlock
- Shaft Rotation Speed: 200 rpm
- 14 revolutions for measurement
- Microprocessor controlled
- Operator self-calibration
- Touch pad keyboard
- Self-diagnostic capabilities
- Digital display round off to .25 oz. (5gms), non round-off to .05 oz. (1 gm)
- 1/2 H.P. Induction motor
- Shaft size: 1 9/16" diameter (40 mm)
- Parameter memory up to 4 jobs simultaneously
- 20 weight pockets
- Weight angle resolution: 1.4°
- Digital display panel

Note: John Bean Company reserves the right to incorporate changes in designs or materials, affecting product improvements, without obligation of incorporating same on equipment of prior manufacture.

Rim Width: 3-19" (76mm-483mm)
Rim Diameter: 3-24" (202mm-1016mm)
Tire Diameter: up to 40" (1016mm)
Tire Wt: up to 120lbs. (54kg)
Footprint: 97"x 60" (2464mm x 1524mm)
Shipping Weight: 380 lbs. (173kg)
Shipping Volume: 38.8 cu.ft. (1.1m³)
Power: 115volt 1 ph, 60 cycle

Manufactured in U.S.A.

I EQUIPMENT & ACCESSORIES:

Be sure the equipment and accessories you ordered are included. Report any shortages immediately to John Bean Co. Service.

61123 - Rim Width Caliper. Used to measure rim width for proper setting on balancer.

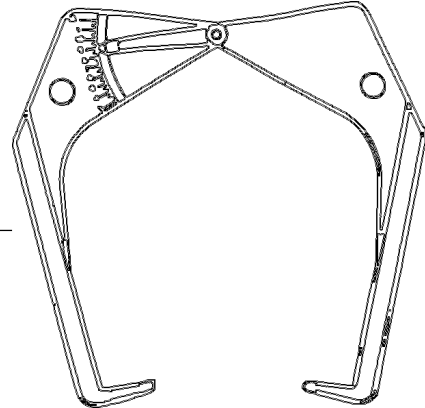

61078 - Retainer Cup. To retain steel wheels, and some mags, against the backing plate.



61077 - Plastic Protector Ring. For use with mag/custom wheels.

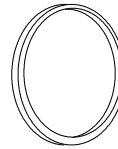

61476 - Small Passenger Car Cone. Mounts wheels with center hole from 1-11/16" (43mm) to 2 1/2" (63.5mm) diameter.

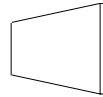

61253 - Small Passenger Car Cone. Mounts wheels with center hole from 2 3/16" (55.6mm) to 2 15/16" (75.4mm) diameter.

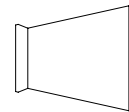

61252 - Large Passenger Car Cone. Mounts wheels from 2 13/16" (71.45mm) to 3 9/16" (90.5mm).

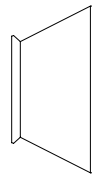

60781 - Light Truck Cone. Mounts light truck wheels from 3 3/8" (85.7mm) to 5 1/4" (133.35mm).

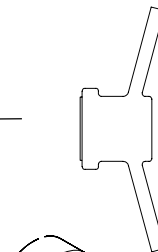

61072 - Ball Bearing Wing Nut w/ - Plastic Insert. Used to secure wheels and adapters to balancer shaft, and protects specialty wheels when 61076 is not used.

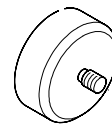

110563 - Calibration Weight. 5.5oz. slug weight used to dynamically calibrate unit.

61075 - Coil Spring. Assures accurate mounting of cones from the back side of the wheel.



61379 - Threaded Extension Shaft. The normal wheel mounting shaft which can be removed to mount wheels with small or no center hole. (See "Using the Unilug Adapter option")



II INSTALLATION

1- Position the Balancer

Floor Space.

Locate your balancer where it can be seen by your customers and where it will merchandise your computer wheel balancing capability. Allow sufficient room to mount wheels on one side and to remove accessories from their mounting pegs on the other.

Unpacking the Balancer

Cut banding straps. Use caution to avoid sharp edges of banding. Lift cardboard box upward over balancer top. Cut banding from the hood guard and the accessory package. Set these aside for now. Remove the skid mounting bolts from the balancer base. Lift the balancer from the skid and place gently onto the floor.

CAUTION! DO NOT LIFT BALANCER BY THE SHAFT!

Site Preparation.

Floor should be maintained level within 1/4" (6mm) beneath the balancer. Floor should be concrete and free of heavy equipment vibrations.

1. Anchor to floor.

The balancer should be anchored to the floor, since large imbalances can cause vibration in the balancer that may make it necessary to spin more than once.

a. Mark anchor holes either by placing the balancer in the desired location and marking through the tie-down holes or by using the dimensions shown on adjacent diagram.

b. Drill four 1/2"(12mm) diameter holes by 3"(76.2mm) minimum depth and install stud anchors through balancer mounting holes and into concrete holes. Tighten bolts.

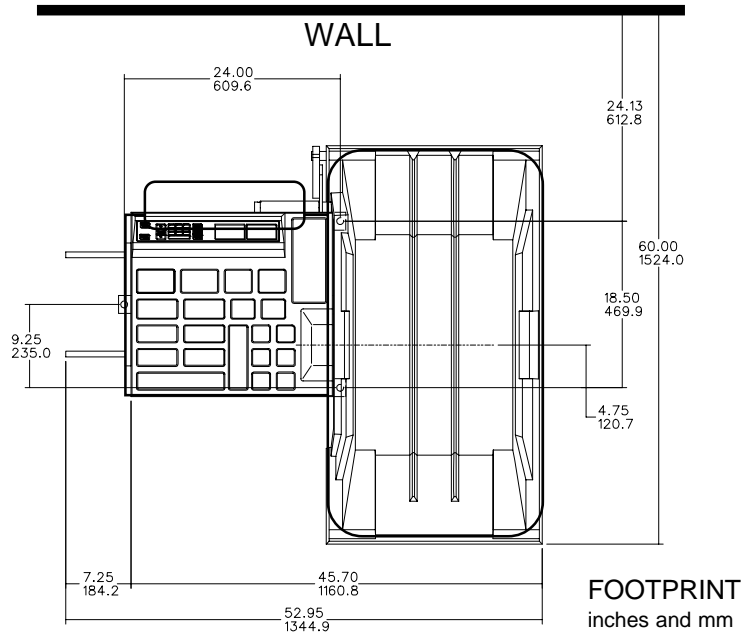

2. Install Wheel Guard

a. Insert the wheel guard shaft into the support column pivot tube.

b. Secure the hood shaft in place by tapping the 5/16" diameter roll pin into the drilled hole of the guard pivot shaft.

c. After power is input to the machine, check function of the auto-spin feature.

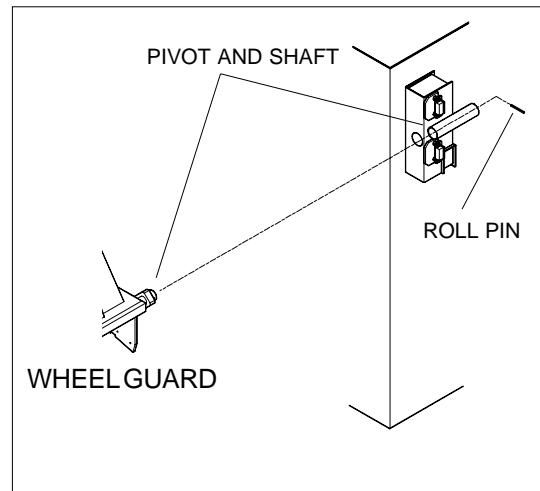

CHECK THE BALANCER TO BE SURE IT MEETS YOUR VOLTAGE SUPPLY. SEE THE IDENTIFICATION PLATE ON THE REAR OF THE BALANCER.

IMPORTANT: Consult your electrician for proper wire size and grounding if a service outlet is being installed for the balancer. Avoid excessively long power cords since a voltage drop can occur and supply the balancer with less than adequate voltage. Extension cords should not be longer than 20 feet (6m).



III PRINCIPLES OF OPERATION

This machine is a two-plane micro-processor-based electronic balancer. "Two-plane" means that any imbalance in the wheel -- whether static or dynamic -- can be corrected through proper placement of weights. These two planes must naturally be at the inner and outer faces of the wheel, since these are the normal places where corrective weights are applied. Under special circumstances, the location of these planes can be altered as long as the balancer is properly programmed.

When the distance from the machine to the wheel is measured and entered into the computer, we are telling the computer where the "inner" plane is located on the balancer shaft. When the rim width is measured and entered into the computer, we are telling the computer to add this measurement to the distance gauge data so that the computer knows where the "outer" plane is located on the shaft. Programming in the rim diameter tells the computer how far away the correc-

tive weights will be applied from the center of the wheel.

When a wheel is spun, the computer detects any imbalance on the shaft. Weight amount readouts, left and right, for inner and outer planes, indicate the amount required to correct each plane. Weight position displays indicate where weights must be applied. The balancer detects shaft RPM and does not begin to take these measurements until the wheel has reached proper speed.

Control Panel

Static - 2 Plane button.

Balancer normally in 2 plane mode. Press Static - 2 plane button for static mode. Mode of operation changes (toggles) each time button is pressed.

Alloy Mode button.

Changes weight placement mode for specialty wheels and hidden weight balancing.

Stop (Red) button.

Push anytime to interrupt automatic cycle. Wheel will stop spinning.



STA
DYN

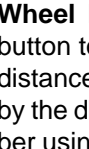
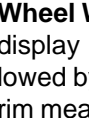
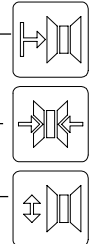
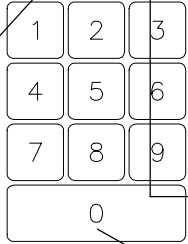

Spin (Green) button.

Used to initiate spin cycle and function codes.



F

"F" button. Allows the entry of function codes. Function codes are used for customizing, calibrating, and diagnosing the balancer.

Numbered Keyboard. Used to enter wheel parameters, and function codes.

Wheel Diameter button. Push to display or enter the wheel diameter as read from the side wall of the tire. Use the numbered keyboard to enter the wheel diameter parameter.

Wheel Width button. Push button to display or enter the wheel width, followed by a keyboard entry of the tire's rim measured width.

Wheel Distance button. Push this button to display or enter the wheel's distance from the balancer measured by the distance gauge. Enter the number using the numbered keyboard.

Left Hand Weight Amount Window. Indicates the weight imbalance of the left or inside plane of the tire and wheel.

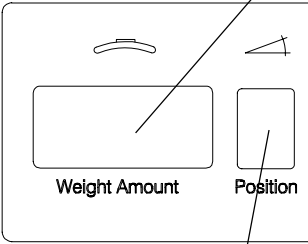
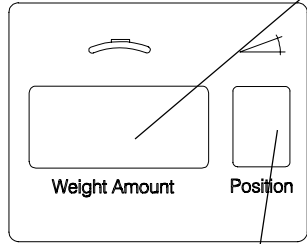

Left hand Position Window. Indicates the left or inside plane weight location. A reading of 0 indicates the weight be placed at top dead center of the wheel.

Left hand Position Window. Indicates the left or inside plane weight location. A reading of 0 indicates the weight be placed at top dead center of the wheel.

Note: If the **STOP** button is pressed, followed by a wheel cover closure (raise & lower), the displays will show a series of scanning dashes. This shows the balancer is still in use but that there is no reading to be displayed. Normal display will return upon a completed spin cycle.

Right Hand Weight Amount Window. Indicates the weight imbalance of the right or outside plane of the tire and wheel.

IV Calibration

1. Press F1 and SPIN
2. The display will read "**CAL Slu**". Attach the round calibration weight in the threaded hole from the **outer** edge. See Figure 1
3. Press SPIN again or lower the Wheel Guard to initiate the balancer spin cycle. The shaft will turn for about 15 seconds.
4. The display will then change to "**CAL 0**". Remove calibration weight and Press SPIN or lower the wheel guard to perform second step of calibration. See Figure 2
5. After another 15 second spin the display will read "**CAL Good**" to indicate a good calibration. Please secure the calibration weight in its proper place for safe keeping.

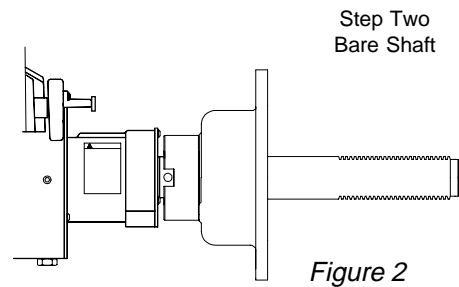
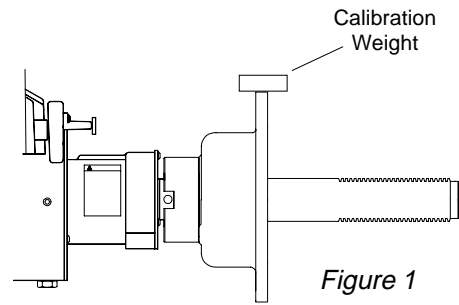

CHECK SPIN: To verify a calibration, place the calibration weight onto the bare shaft in its threaded hole. With the **default** wheel parameters, lower the hood to spin. When braked, the display should read approximately **5.50** ozs on the left side and **0.00** ozs on the right. To make sure default parameters are loaded, simply turn the machine off, then back on.

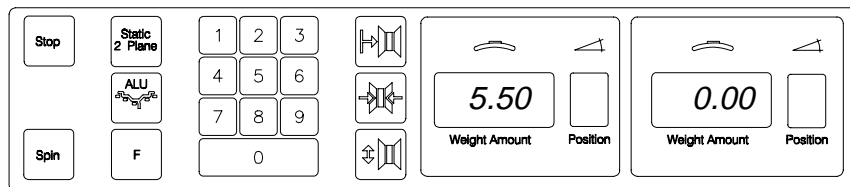

NOTE: If any step is performed incorrectly or out of sequence, you may have a display that reads "SHAFT UNB"* or "CAL ER"*. If so, repeat the calibration procedure. If the display "SHAFT UNB" appears when the procedure is correct, then run a test spin with the calibration weight installed. If its weight is 5.5oz., the calibration is acceptable. If the display "CAL ER" appears the second time, service may be required.

NOTE: If "CAL ER" appears on the display during a normal wheel balance routine, the balancer must be calibrated before proceeding.

- * Calibration Error is represented by a display of "CAL ER"
- * Acceleration Error is displayed with "ACL ER"
- * Shaft Unbalanced is displayed as "SFT UNB"

V. WHEEL MOUNTING

Standard Wheels

Nearly all standard wheels and many alloy wheels have accurately machined center holes, and they should be mounted with center cones. Accurate balancing depends on accurate mounting of the wheel and correct seating of the cone in the pilot hole to insure that the wheel is centered on the shaft.

Mount the wheel as shown at right:

1. Mount coil spring inside backing plate.
2. Mount proper cone against spring.
3. Mount wheel on shaft in the same manner as you would on the car.
4. Mount retainer cup against outside of wheel
5. Tighten wing nut securely with both hands.

NOTE: Some wheels not center centric may require the use of an optional lug adapter plate.* An adapter plate allows a wheel to be mounted using the lug holes as a center reference.

* Spring, cone, retainer cup, and wing nut may not be needed if adapter plate is used to mount wheel to balancer shaft.

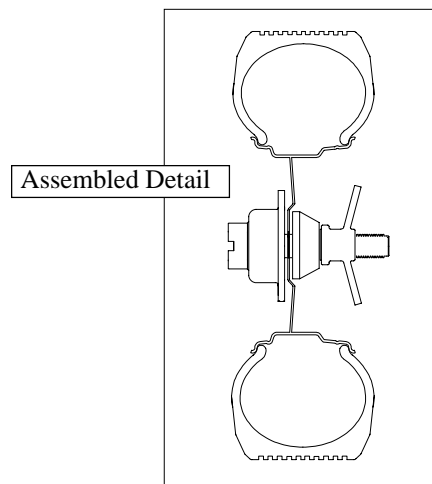
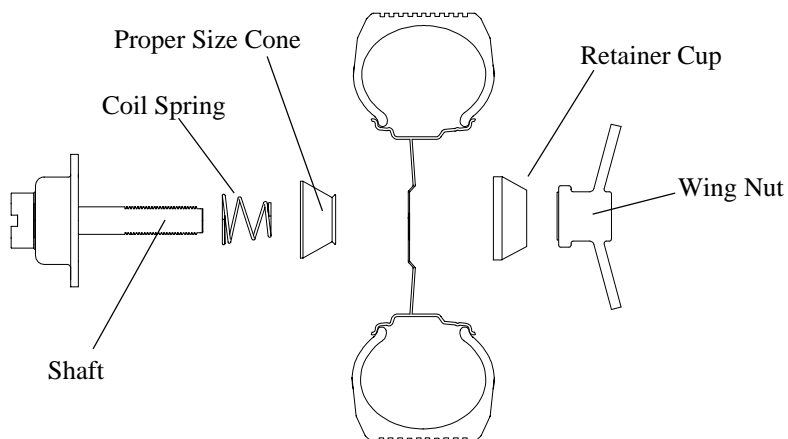

Warning

Failure to tighten wing nut securely may result in serious personal injury.



Check List

Observe Before Balancing Wheel

1. Check for proper air pressure. If not correct, inflate to correct pressure.
2. Check for any foreign material inside tire. If present, remove before balancing tire.

WATER IS FOREIGN MATERIAL.

3. Be sure the tire and wheel are free of excessive dirt and large stones.

4. Remove old weights -- old weights may be improper value or in wrong location.

5. Be sure that the right size tire has been mounted on the wheel.

Specialty Wheels

Most specialty wheels can be accurately mounted and balanced using a centering cone. When using centering cones, be certain cone is properly seated in the pilot hole. Examine the hole for obvious damage and correct before balancing.

Mount the wheel as shown at right:

1. Mount coil spring inside backing plate.
2. Mount proper cone against spring.
3. Mount wheel on shaft as you would on the car.
4. Tighten wing nut securely with both hands.

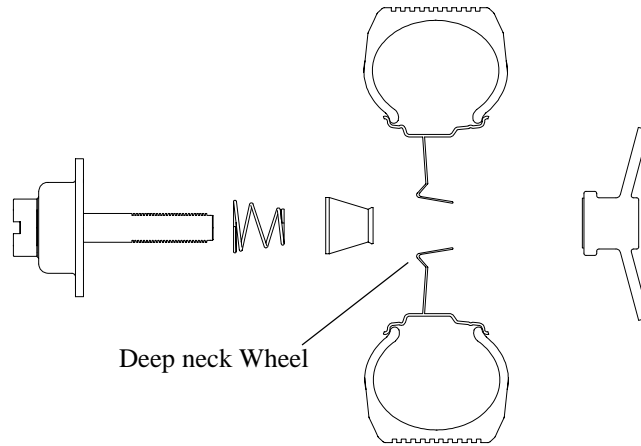

WARNING!!!

Failure to tighten wing nut securely may result in serious personal injury.



NOTE: If specialty wheel does not have an extended neck, use 61076 retainer cup.

Truck Wheels

Offset and Ford/Dodge Pinned Dual Wheels Using Optional Offset Spacer

Some wheels are "STANDARD", except that they have offset centers which may extend around the backing plate. Under normal conditions no spacer is required because of the unique design of the balancing shaft and bearing housing. For unusual applications, an optional offset spacer may be used. See section "Optional Accessories for Computer Wheel Balancers".

Mount the wheel as shown at right and balance as a "Standard" wheel.

1. Mount offset spacer against backing plate.
2. Mount wheel on shaft as you would on the car.
3. Select proper cone and mount onto shaft as shown above.

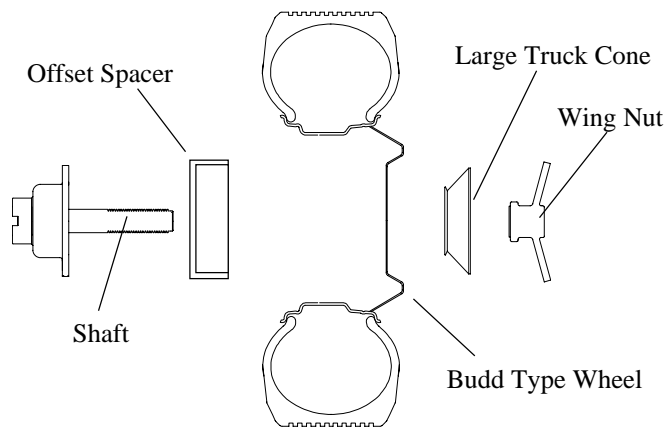

4. Tighten wing nut securely with both hands.

WARNING:

Failure to tighten wing nut securely may result in serious personal injury.

Pinned Wheels

Ford E/F 350 Series and Dodge 350 Series 1-Ton trucks (also some Specialty vehicles, such as motor homes, ambulances, emergency rescue, tow

trucks, etc.) may have the safety pinned dual wheels installed on the rear axles.

The Offset Spacer was designed to provide clearance for the pin on these wheels, with a tapered inner lip to allow the clearance needed for the outside mounted cone to fit inside of it without binding.

VI BALANCING STANDARD WHEELS

Mode

1. Select the 2 plane mode of balancing by pressing the “Static/2 Plane” button . Defaults to “2 Plane” when powered up. Only the Static mode needs to be selected.

NOTE: Mode of operation will toggle each time button is pressed.

See section **Static Balancing** for single plane operation on page 13.

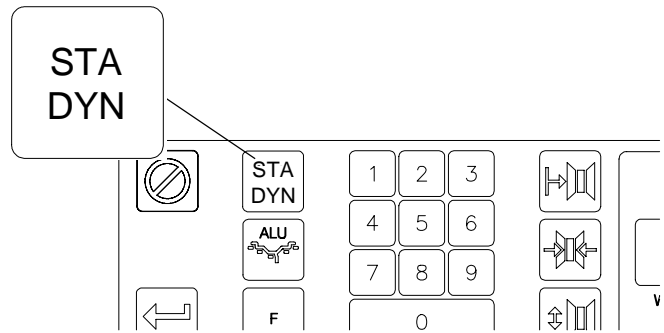

Distance Entry

2. Move the distance gauge arm to touch the inner edge of the wheel and observe the reading on the scale of the distance gauge.

Press wheel distance button . Enter wheel distance reading by pressing appropriate buttons on keyboard.

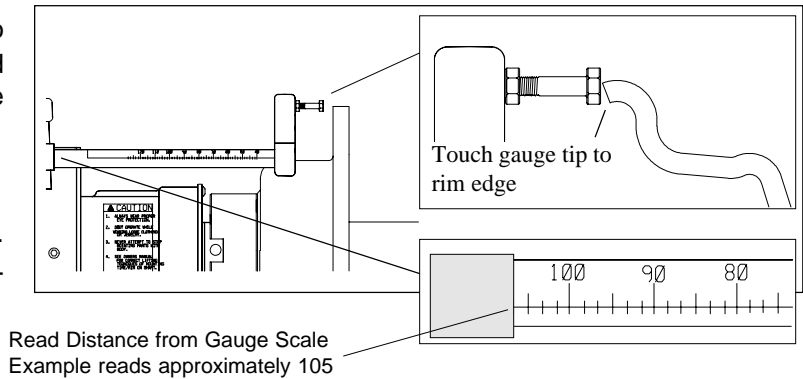

Rim Width Entry

3. Measure rim width using rim width calipers. Measure against wheel where corrective weight will be applied.

NOTE: If clip weights cannot be applied, refer to section “Balancing Special Wheels” on page 16.

4. Press wheel width button . Enter wheel width reading by pressing appropriate buttons on keyboard.

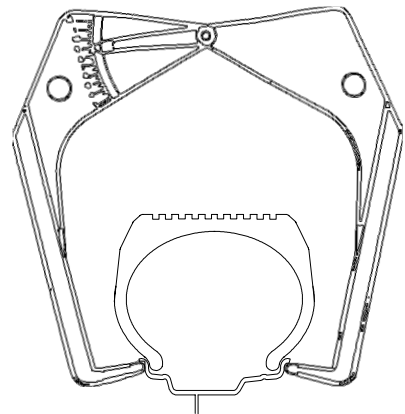
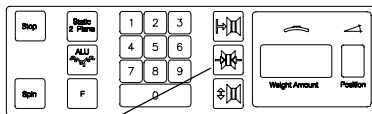

Wheel Diameter Entry

5. Press wheel diameter button . Enter wheel diameter (see tire side wall for specification) by pressing the appropriate buttons on the keyboard. Metric designations may be entered directly after pressing function keys F7 (turns on conversion to metric) and then entering correct number in mm.

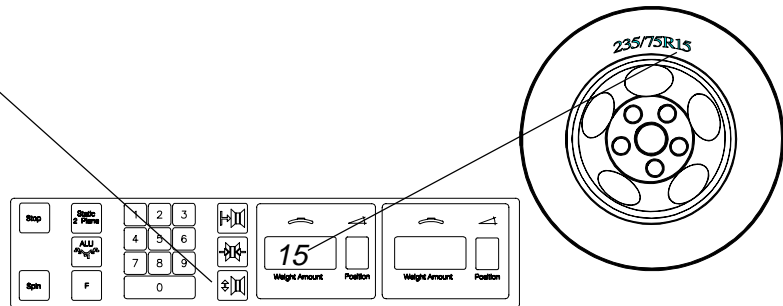

SPINNING THE WHEEL

Lower the wheel guard to activate spin function. The balancer will automatically spin the wheel and stop itself. (NOTE: F6 switches between auto-spin and non-auto-spin.) Imbalance reading will be displayed and stored as long as power is applied to the balancer.

After wheel has come to a complete stop, raise the wheel guard.

WARNING

Balancer will not operate unless wheel guard is in lowered position. Do not raise wheel guard until wheel has come to a complete stop.



WARNING

Do not raise wheel guard until wheel is completely stopped. Failure to do so may result in serious personal injury.



PLACING THE WEIGHT

Starting with either left or right of the wheel (inner or outer plane), rotate the wheel until a zero (0) appears in the appropriate weight position window.

Apply weight displayed in the appropriate weight amount window at top dead center (12 o'clock) while weight position window displays zero (0). Repeat for the other side.

TOP DEAD CENTER

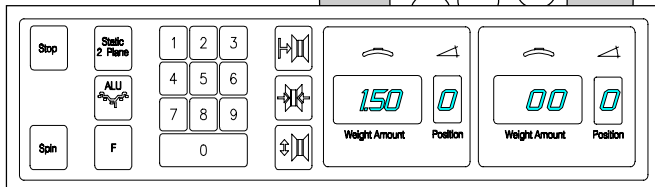
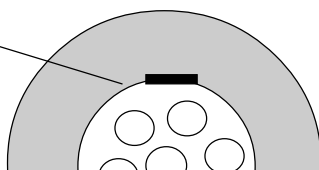

WARNING

Be sure weights are properly applied and are secure on the wheel. Failure to do so may cause weights to come loose resulting in serious personal injury.

CHECK SPIN

Lower the wheel guard. After spin is completed, weight amount windows should display zero (0.00), indicating that balance has been achieved.

VII. CHECK FOR PROPER WEIGHT APPLICATION

NOTE: On rare occasions, more than one spin may be required to balance the wheel. If so, check the following steps:

Weight Error

If weight amount windows do not read zero (0.00) and show that a second weight is required at the same or opposite location as the first weight, you have a weight error. You can replace the first weight with the correct amount or apply the second weight where it calls for it.

Position (Location) Error

If weight amount windows do not read zero (0.00) and you find that a second weight is required at an angle (less than 180°) to the first weight, you have a position error. Move the first weight toward the position that it calls for, or add a second weight at the proper position.

All of the above methods will produce a perfect balance if done properly.

BALANCING SPECIAL/ALLOY WHEELS

(Adhesive Weights)

If standard clip weights are to be used, balance as a "Standard" wheel.

The **Alloy Mode** or **Aluminum** mode of operation is used when some specialty wheels are to be balanced, or when adhesive weights are required, i.e., hidden weight method. The ALU mode is entered by pressing the **ALU** button followed by the desired mode location number.

IF ADHESIVE WEIGHTS OR TAPE WEIGHTS MUST BE USED, FOLLOW THESE INSTRUCTIONS:

1. See placement illustration below and select how weights will be applied.
2. Enter distance, wheel width, and diameter as explained previously. See Note below.
3. Press **ALU** button followed by a mode number.

Placement Chart

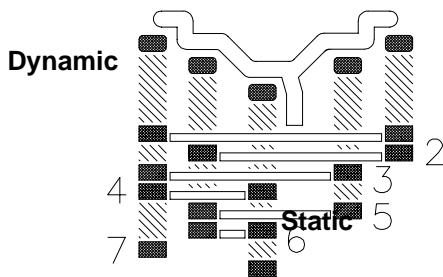

NOTE: Decimals will be viewed in the weight position windows when the unit is in the **ALU** mode.

4. Lower the hood to spin the wheel assembly. Lift the hood guard only after the wheel has come to a complete stop.
5. Starting with either left or right of the wheel (inner or outer plane), rotate the wheel until a zero (0) appears in the appropriate weight position window.
6. Apply weight displayed in the appropriate weight amount window at top dead center (12 o'clock) while weight position window displays zero (0). Repeat for the other side.

NOTE: When operating from a hidden weight mode, measure the distance from the inside weight to the outer weight for the width entry.

NOTE: BE SURE ADHESIVE WEIGHTS WILL CLEAR DISC BRAKE CALIPERS.

NOTE: SINCE HIDING ADHESIVE WEIGHTS INVOLVES APPROXIMATIONS TO ACTUAL WHEEL WIDTH AND WHEEL DIAMETER, ADDITIONAL SPINS MAY BE REQUIRED. SIMPLY RE-SPIN AND APPLY WEIGHTS AS CALLED FOR.

STATIC BALANCING

For single plane operation, push the “**Static/2 Plane**” button once for static mode.

NOTE: Mode of operation will change each time button is pressed. Note also that the ALU positions number seven and eight represent static modes.

Wheel width and distance entries are not required for static balancing.

A. Adhesive Weight Method

1. Adhesive weight will be applied here. Enter diameter as read from tire side wall.
2. Lower wheel guard. Balancer will spin & stop automatically, unless the auto-spin function has been turned off.
3. Read left weight amount and position windows only for static imbalance.

B. Clip-on Weight Method

NOTE: Since an adhesive weight will not be applied at the center of the wheel, an adjustment must be made for the change in static weight placement.

1. Enter wheel diameter 2.5 inches larger than the diameter read on the tire side wall.
2. Lower wheel guard. Balancer will spin and stop automatically, unless the auto-spin function has been turned off.
3. Read left weight amount and position windows for static balancing. Apply the necessary clip-on weight.

FUNCTION or "F" CODES

The 4100 Series Wheel Balancers utilize "F" (function) codes for operator convenience and service diagnostics. Some of the "F" codes are listed on this and following page(s). If any of the below functions are not correct, consult your John Bean Field Service Representative.

F1 Calibration

The 4100 Series was designed to be calibrated by the operator. It automatically adjusts itself to read accurate weight amount. See page 8 for calibration detail.

NOTE: Calibration can be performed at any time.

NOTE: To cancel any F code sequence, press the stop button.

F2 Round-off

The 4100 balancer rounds off weight imbalances to the nearest 0.25oz. (5gr.) increments. This mode of operation is automatically used (default) when the machine is turned on.

F3 Non-Round-off

The balancer may be operated in the non-Round-off mode to display weight imbalance in .05 oz. or 1 gm increments.

F4 Ounces

The domestic model balancer displays weight imbalances in ounces, while the export models display weight in grams. F4 and F5 below can be used to switch from ounces to grams and back again if desired.

F5 Grams

Domestic units display weights in ounces. To display in grams enter F5.

F6 Auto-spin

The balancer can be switched to spin automatically when the hood guard is lowered. If autospin is not desired enter F6 again to switch off.

F7 Convert

This code allows the direct entry of millimeters for the wheel diameter found on some vehicles (i.e. 390mm). The display will read "CON ON".

NOTE: To return to inches, simply reenter F7. The display should read "CON OFF".

F8 Dead Zone Roundoff

Measurement sensitivity of the weight imbalance in the range from 0 to 0.50oz can be changed from the keyboard. This should normally be in the off mode.

If dr **OFF** appears, the machine will round off as follows:
Imbalance of 0.125oz or below will round off to zero (0).

Imbalance greater than 0.125oz and less than 0.375oz will round off to 0.25oz.

If dr **ON** appears, the machine will round off as follows:
Imbalance of 0.30oz or below will round off to zero (0).

Imbalance greater than 0.30 and less than 0.35 will round off to 0.25.

NOTE:

TURNING THE POWER OFF AND ON WILL NOT CHANGE YOUR SELECTION.

Dead zone should be in the OFF mode for the majority of operations.

F90 Computerized Match Balance Procedure

The Match Balance feature allows a wheel and tire to be "Matched" to one another for optimum performance and minimum correcting weight placement. If a wheel is not center centric or has a heavy spot on one side, pressing F90 will prompt the machine to look for the heavy side of the tire and place it opposite the wheel heavy side to help offset imbalance. This will not only minimize weight amount placement but also helps smooth out a ride.

F80 Series (Storage) Codes

This feature allows the operator to store common used wheel parameters for later recall. This a time saving feature especially useful in high volume shops. See following page for instructions.

WHEEL PARAMETER STORAGE

F80 Series (Storage) Codes

This balancer is programmed to allow storage and retrieval of the wheel parameters (Distance, Width and Diameter) used to balance wheels.

This feature is especially useful for a shop that balances a large quantity of one type wheel. For example, a shop may balance a large quantity of one particular custom wheel that has the same offset, same width and the same diameter.

It may also be simultaneously used by four individual technicians by storing the parameters for four vehicles.

Program the balancer in the following manner:

1. Assign each of the following "F" codes to a particular wheel/Tire or to an individual technician.

- F 80 Technician #1 or wheel #1
- F 81 Technician #2 or wheel #2
- F 82 Technician #3 or wheel #3
- F 83 Technician #4 or wheel #4

2. Enter the wheel parameters (Distance, Width, and Diameter) in the normal manner.

3. Press the assigned "F" Code, followed by pressing the SPIN button. For example, press F81 and SPIN.

4. The display will change to the following:
r=0 S=1

5. This instructs the operator to press (1) one on the keypad to STORE the parameters. The parameters are stored until changed by entering and storing new parameters.

6. To recall previous stored parameters, press the assigned "F" Code followed by pressing the SPIN button. Press (0) zero on the keypad to RECALL.

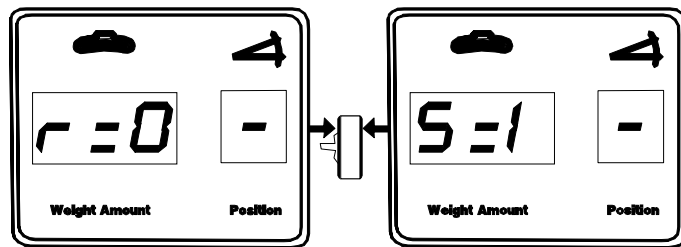
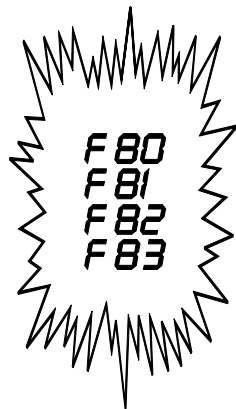

RECALL

Press the assigned "F" Code (F80-F83) followed by pressing the SPIN button. Press (0) zero to RECALL.

STORE

Enter the wheel parameters in the normal manner. Press the assigned "F" Code (F80-F83) followed by pressing the SPIN button. Press (1) one to store.

Computerized Match Balance

Remove all old balance weights and remove dirt and stones from tire and wheel. Mount the tire/wheel assembly on the balancer using the proper mounting method. Enter the proper wheel parameters for DISTANCE, WIDTH & DIAMETER.

Press F 90 & SPIN to activate Tire Match Procedure.

Rotate the Wheel/Balancer Shaft so the valve stem is at the top and **Press "F"**.

Press SPIN or lower the hood for auto SPIN to measure the imbalance of Position #1.

NOTE: If, anytime during the procedure, the normal dynamic weight amounts are displayed, install the indicated weight and complete the balance. This is an indication of an insignificant amount of runout.

If a **STATIC** amount of weight is displayed, this indicates a severe problem. You may continue by pressing "F".

Remove the tire from the balancer and deflate. Break the beads and rotate the tire 180 degrees on the rim. Use the valve stem as a reference when rotating the tire. Inflate the tire to the recommended pressure.

Install the tire/wheel assembly on the balancer as before.

Rotate the valve stem so it is positioned at the top and **Press "F"**.

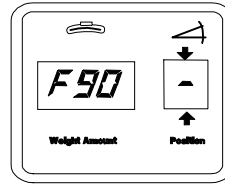

NOTE: Press STOP to end the Match Mount Procedure at any time.

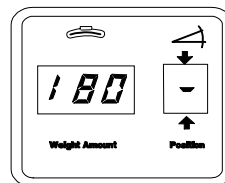
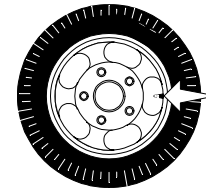
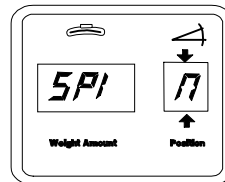
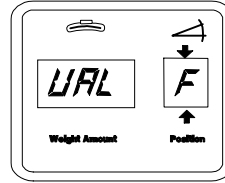
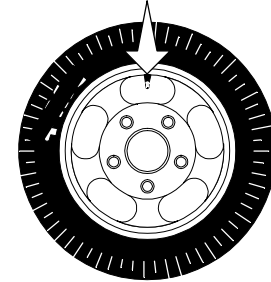

Rotate Tire on Rim 180°

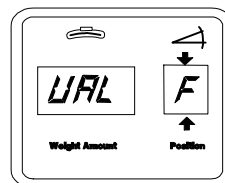
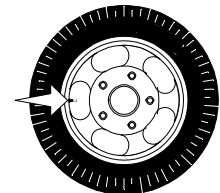

Place Tire back on balancer. Place Valve Stem at top and Press "F"

Press **SPIN** or lower the hood for auto SPIN to measure the imbalance of Position #2.

If "**SPOT**" is displayed, rotate the wheel/balancer shaft to position "**0**" as indicated on the right display window. Mark the tire at the top with chalk. This is the tire **Match SPOT**. The wheel's valve stem will be matched to this spot.

NOTE: If, anytime during the procedure, the normal dynamic weight amounts are displayed, install the indicated weight and complete the balance. This is an indication of an insignificant amount of runout.

If a **STATIC** amount of weight is displayed, this indicates a severe problem. You may continue by pressing "**F**".

OPTIONAL: To display the percent of rim (**r**) or tire (**t**) problem Press **F**. To return to the previous step, Press **F** again.

Remove the tire/wheel assembly from the balancer and deflate. Break the beads and rotate the **Match SPOT** to align with the valve stem. Inflate the tire to specifications and install the tire on the balancer.

Press **SPIN** or lower the hood for auto spin.

Place balance weights as indicated to complete the normal balance.

NOTE: If an error (**ER**) is displayed, it would indicate an error was made in rotating the tire or an error was made in the procedure. In the case of an error, press **STOP** and begin the procedure from the start.

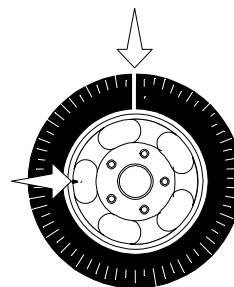
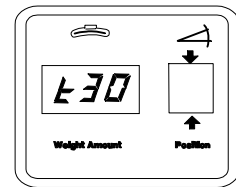
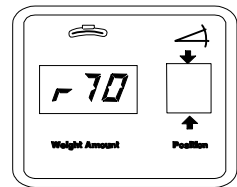
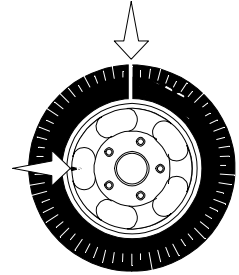
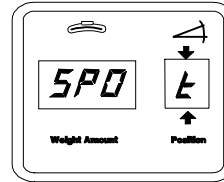
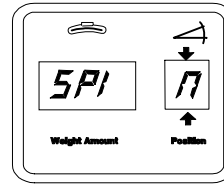

Rotate chalk mark **SPOT** to Valve Stem

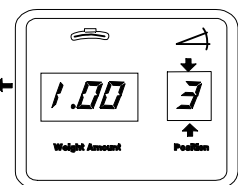
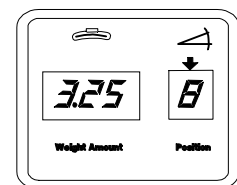
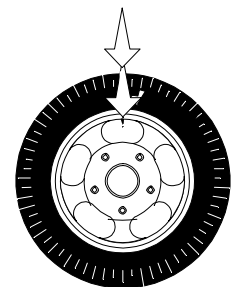

Calibration Check Procedure

This procedure can be performed by anyone and quickly checks that the balancer is properly calibrated. If any of the checks below are not correct, consult with a John Bean Company Service Representative.

1. Calibrate unit following procedure outlined under the section headed "Function Codes".
2. Mount a wheel and balance to zero. Insure that unit has been properly programmed for wheel distance, width, and diameter.
3. Select F3 (non-Round-off mode of operation) and fine balance to zero, within 0.1 ounces (4gr.).
4. Apply 3oz. (85gr.) test weight to inner plane. Spin and check that right hand weight amount reads 0 within 0.1oz. (4gr.). This checks plane separation.
5. With test weight still on inner plane, check that left hand amount meter reads 3oz. (85gr.) within 0.1oz. (4gr.) (weight amount - inside plane).
6. Stop and rotate the wheel so that the 3oz. (85gr.) test weight is at bottom dead center (6 o'clock). Check that left hand position is zero (0) (location - inside plane).
7. Move test weight to outer plane. Spin and check that left hand amount reads 0 within 0.1oz. (4gr.) (plane separation).
8. With test weights still on the outer place, check that right hand amount reads 3oz. (85gr.) within 0.1oz. (4gr.) (weight amount - outside plane).
9. Stop and rotate the wheel so that the test weight is at bottom dead center (6 o'clock). Check that right hand position is zero (0) (location - outside plane).

Preventive Maintenance Tips

The 4100 Balancer has been designed for many years of trouble-free operation. However, it is a precision machine and should be used with care. We recommend attention to the following points for maximum use and benefit from the equipment.

1. **Control Panel:** Clean periodically with a non-solvent, nonabrasive household cleaner. *Do Not* use brake cleaner or carburetor cleaner.

2. Balancer Shaft: Avoid dropping wheels heavily on the shaft, because doing so can cause nicks and affect mounting accuracy. Apply a light coat of 20 or 30 weight machine oil to the shaft for rust prevention. Wipe off excess and keep shaft clean. **DO NOT** use excessive grease on shaft -- doing so may allow accumulation of grit and debris.

3. Mounting Adapters: Keep adapters clean. To prevent rust, apply a light coat of machine oil and wipe off excess. Do not use grease on adapters. Do not use adapters for purposes other than mounting wheels -- nicks or cuts in the adapters can cause mounting errors.

4. Overhead Hood Guard: Periodically, apply a light coat of grease to the overhead guard support rod to prevent squeaking.

5. Impact Wrenches: Do not use impact wrenches when mounting wheels on the balancer adapters. Use of impact wrenches can cause adapters to become over tightened, possibly damaging the adapters and/or mounting bolts. Use only the T-handled wrench available as an option.

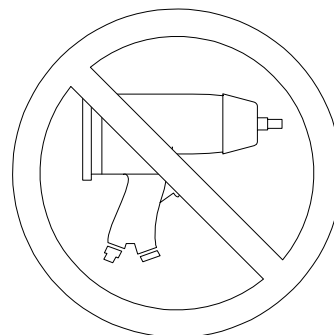

VIBRATION COMPLAINT DIAGNOSTICS

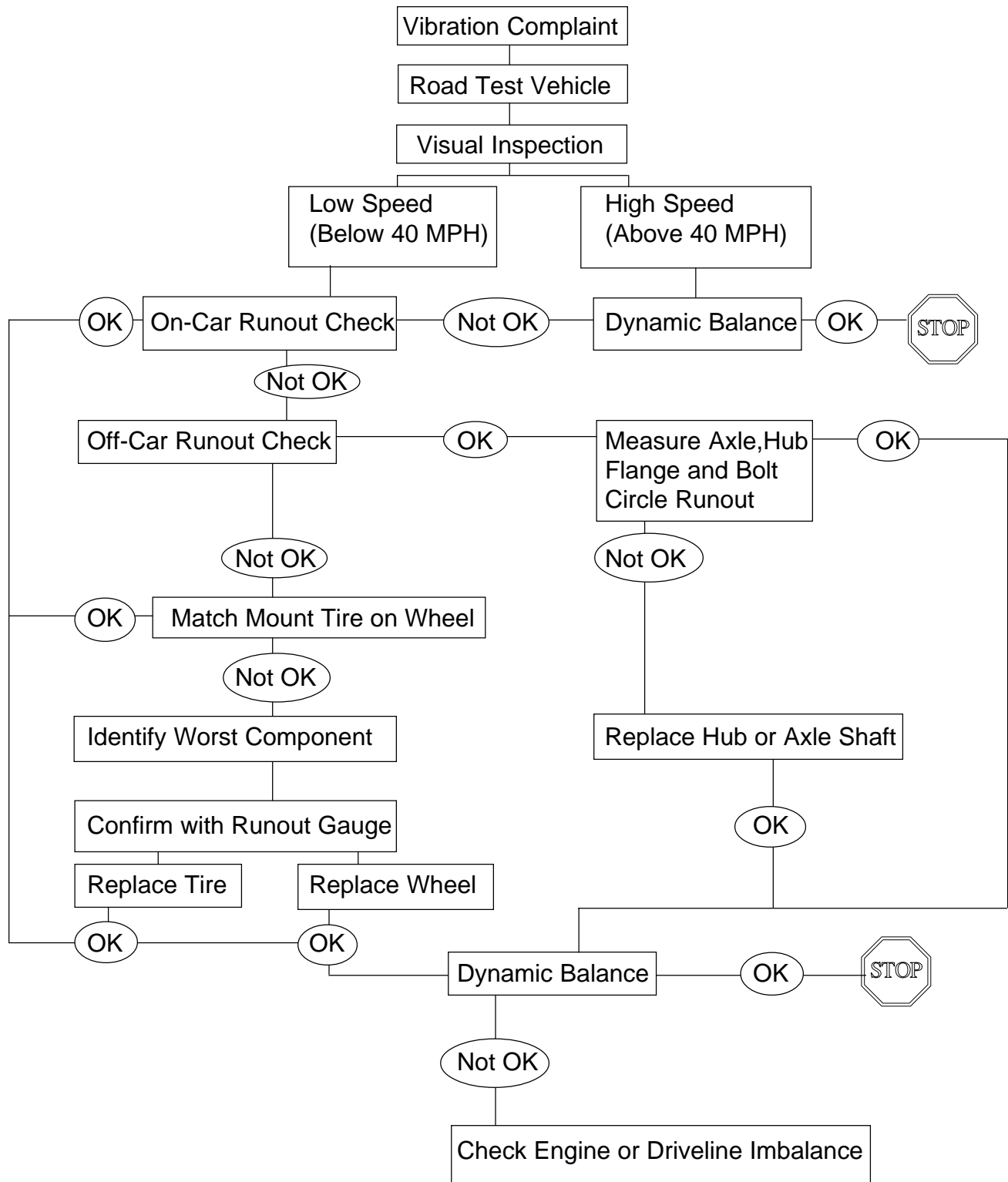

Problem

1. Check for proper air pressure.
2. Check for radial and lateral runout of tire with indicator.
3. Check for radial and lateral runout of wheel with Indicator.
4. Check for foreign material inside the tire.
5. Be sure that the right size tire has been mounted on the wheel.
6. Make sure wheels are the same diameter and width on the same axle.
7. Bad or loose wheel bearings.
8. Front end alignment.
9. Loose suspension parts.
10. Check brake rotors or drums for imbalance.
11. Wheel incorrectly mounted on the car.
12. Heavy unbalanced wheel covers.
13. Center hole out of round.
14. Oblong bolt holes.
15. Disc or drum brake drag
16. Bad U-joints
17. Drive shaft could be out of balance.

Recommended Solution

1. Inflate to proper pressure.
2. If the runout is too much, replace the tire.
3. If the runout is too much, replace the wheel.
4. Remove any foreign material inside the tire.
5. Check for correct tire size.
6. Check for correct diameter and width on the same axle.
7. Replace wheel bearings.
8. Check the front end alignment.
9. Replace or tighten suspension parts.
10. Have rotors or drums balanced.
11. Remount the wheel on the car.
12. Replace wheel covers.
13. Replace the wheel.
14. Replace the wheel.
15. Correct brake problem.
16. Replace U-joints.
17. Have drive shaft balanced.

If you recheck the wheel and it is out of balance, then the problem could be any one of the following:

Problem

1. The original weights have been knocked off
2. Foreign material inside the tire
3. Large stones in tread and excessive
4. Tire slipping on the wheel.
5. Centerhole out of round.
6. Check for proper air pressure.

Recommended Solution

1. Rebalance the wheel.
2. Remove any foreign material inside the tire
3. Remove large stones in tread and excessive dirt on wheel.
4. Remount tire on wheel using a good tire lubricant and inflate to assure proper bead seating. Then check for proper air pressure.
5. Replace the wheel or use backing plate adapter.
6. Inflate to proper pressure.

Blank Page

**USA**

John Bean
309 Exchange Avenue
Conway, Arkansas 72032
Tel.: (800) 362-8326 or (501) 450-1500
Fax: (501) 450-1585

FRANCE

John Bean
Snap-On Equipment France
Z.A. Du Vert Galant
15, rue de la Guivernone
BP 7175
95310 Saint Ouen L'Aumone
Tel: (33) 1-3448-5878
Fax: (33) 1-3448-5879

UNITED KINGDOM

Snap-On Equipment Ltd.
John Bean Equipment Group
Old Meadow Road
Kings Lynn
Norfolk
PE30 4WJ

CANADA

John Bean
6500 Millcreek Drive
Mississauga, Ontario
Canada L5N 2W6
Tel: (905) 814-0114
Fax: (905) 814-0110

GERMANY

John Bean Auto Service Gerate
Division to Sun Electric Deutschland GmbH
Gewerbepark Sinn
D-35764 Sinn Herborner Str. 7-9
Tel: (49) 2772-9404-0
Fax: (49) 2772-94042-23

LATIN AMERICA

Snap-on Tools International, Ltd.
2801 80th Street
Kenosha, WI 53143
Tel: (262) 656-5003
Fax: (414) 656-1403

Notice: The information contained in this document is subject to change without notice. **John Bean** makes no warranty with regard to this material. **John Bean** shall not be liable for errors contained herein or for incidental consequential damages in connection with furnishings, performance, or use of this material.

This document contains proprietary information which is protected by copyright and patents. All rights are reserved. No part of this document may be photocopied, reproduced, or translated without prior written consent of **John Bean**.



are registered trademarks of Snap-on Technologies