



OWNER'S MANUAL

Diversión

XJ600S

XJ600N

4BR-28199-E6

Welcome to the Yamaha world of motorcycling!

As the owner of a XJ600S/XJ600N, you are benefiting from Yamaha's vast experience in and newest technology for the design and the manufacture of high-quality products, which have earned Yamaha a reputation for dependability.

Please take the time to read this manual thoroughly, so as to enjoy all your XJ600S/XJ600N's advantages. The owner's manual does not only instruct you in how to operate, inspect and maintain your motorcycle, but also in how to safeguard yourself and others from trouble and injury.

In addition, the many tips given in this manual will help to keep your motorcycle in the best possible condition. If you have any further questions, do not hesitate to contact your Yamaha dealer.

The Yamaha team wishes you many safe and pleasant rides. So, remember to put safety first!

IMPORTANT MANUAL INFORMATION

EAU00005

Particularly important information is distinguished in this manual by the following notations:



The Safety Alert Symbol means **ATTENTION! BECOME ALERT! YOUR SAFETY IS INVOLVED!**



Failure to follow **WARNING** instructions could result in severe injury or death to the motorcycle operator, a bystander or a person inspecting or repairing the motorcycle.

CAUTION:

A **CAUTION** indicates special precautions that must be taken to avoid damage to the motorcycle.

NOTE:

A **NOTE** provides key information to make procedures easier or clearer.

NOTE:

- This manual should be considered a permanent part of this motorcycle and should remain with it even if the motorcycle is subsequently sold.
 - Yamaha continually seeks advancements in product design and quality. Therefore, while this manual contains the most current product information available at the time of printing, there may be minor discrepancies between your motorcycle and this manual. If there is any question concerning this manual, please consult your Yamaha dealer.
-

IMPORTANT MANUAL INFORMATION

EW000002



PLEASE READ THIS MANUAL CAREFULLY AND COMPLETELY BEFORE OPERATING THIS MOTORCYCLE.

EAU00008

**XJ600S/XJ600N
OWNER'S MANUAL**

© 1999 by Yamaha Motor Co., Ltd.

1st Edition, April 1999

**All rights reserved. Any reprinting or
unauthorized use without the written
permission of Yamaha Motor Co., Ltd.
is expressly prohibited.**

Printed in Japan.

TABLE OF CONTENTS

1 GIVE SAFETY THE RIGHT OF WAY

1

2 DESCRIPTION

2

3 INSTRUMENT AND CONTROL FUNCTIONS

3

4 PRE-OPERATION CHECKS

4

5 OPERATION AND IMPORTANT RIDING POINTS

5

6 PERIODIC MAINTENANCE AND MINOR REPAIR

6

7 MOTORCYCLE CARE AND STORAGE

7

8 SPECIFICATIONS

8

9 CONSUMER INFORMATION

9

INDEX



GIVE SAFETY THE RIGHT OF WAY

GIVE SAFETY THE RIGHT OF WAY..... 1-1



GIVE SAFETY THE RIGHT OF WAY

EAU00021

Motorcycles are fascinating vehicles, which can give you an unsurpassed feeling of power and freedom. However, they also impose certain limits, which you must accept; even the best motorcycle does not ignore the laws of physics.

Regular care and maintenance are essential for preserving your motorcycle's value and operating condition. Moreover, what is true for the motorcycle is also true for the rider: good performance depends on being in good shape. Riding under the influence of medication, drugs and alcohol is, of course, out of the question. Motorcycle riders – more than car drivers – must always be at their mental and physical best. Under the influence of even small amounts of alcohol, there is a tendency to take dangerous risks.

Protective clothing is as essential for the motorcycle rider as seat belts are for car drivers and passengers. Always wear a complete motorcycle suit (whether made of leather or tear-resistant synthetic materials with protectors), sturdy boots, motorcycle gloves and a properly fitting helmet. Optimum protective wear, however, should not encourage carelessness. Though full-coverage helmets and suits, in particular, create an illusion of total safety and protection, motorcyclists will always be vulnerable. Riders who lack critical self-control run the risk of going too fast and are apt to take chances. This is even more dangerous in wet weather. The good motorcyclist rides safely, predictably and defensively – avoiding all dangers, including those caused by others.

Enjoy your ride!

Left view (XJ600S) 2-1
Right view (XJ600S)..... 2-2
Controls/Instruments (XJ600S) 2-3
Left view (XJ600N)..... 2-4
Right view (XJ600N) 2-5
Controls/Instruments (XJ600N)..... 2-6

Left view (XJ600S)

2

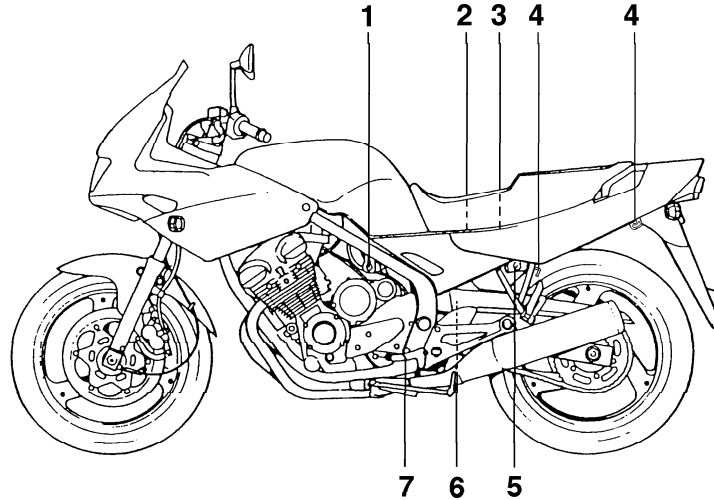

- 1. Fuel cock (page 3-13)
- 2. Helmet holder (page 3-15)
- 3. Fuse box (page 6-26)
- 4. Luggage strap holders (page 3-16)
- 5. Seat lock (page 3-14)

- 6. Rear shock absorber spring preload adjusting ring (page 3-15)
- 7. Shift pedal (page 3-10)

Right view (XJ600S)

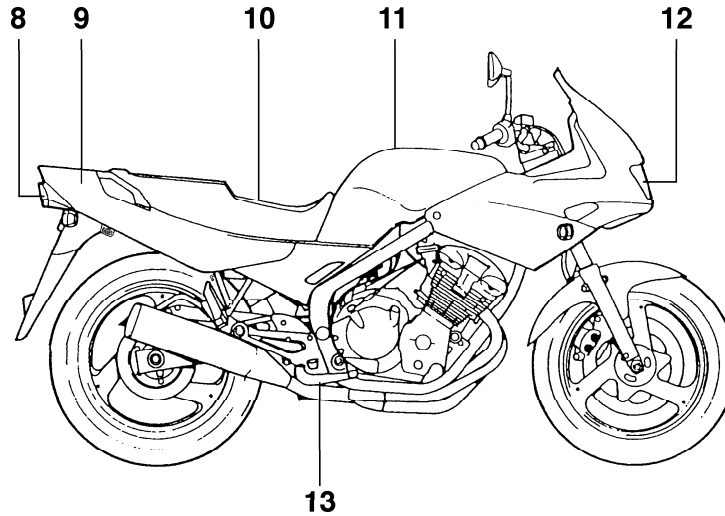

- | | |
|------------------------|-------------|
| 8. Tail/brake light | (page 6-17) |
| 9. Storage compartment | (page 3-15) |
| 10. Seat | (page 3-14) |
| 11. Fuel tank | (page 3-11) |
| 12. Headlight | (page 6-27) |
| 13. Rear brake pedal | (page 3-11) |

DESCRIPTION

Controls/Instruments (XJ600S)

2

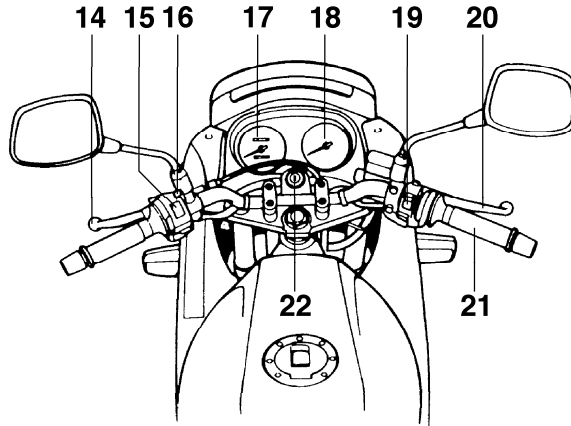

- | | |
|------------------------------|-------------|
| 14. Clutch lever | (page 3-9) |
| 15. Left handlebar switches | (page 3-7) |
| 16. Starter (choke) “ x ” | (page 3-14) |
| 17. Speedometer | (page 3-6) |
| 18. Tachometer | (page 3-7) |
| 19. Right handlebar switches | (page 3-9) |
| 20. Front brake lever | (page 3-10) |
| 21. Throttle grip | (page 6-12) |
| 22. Main switch | (page 3-1) |

Left view (XJ600N)

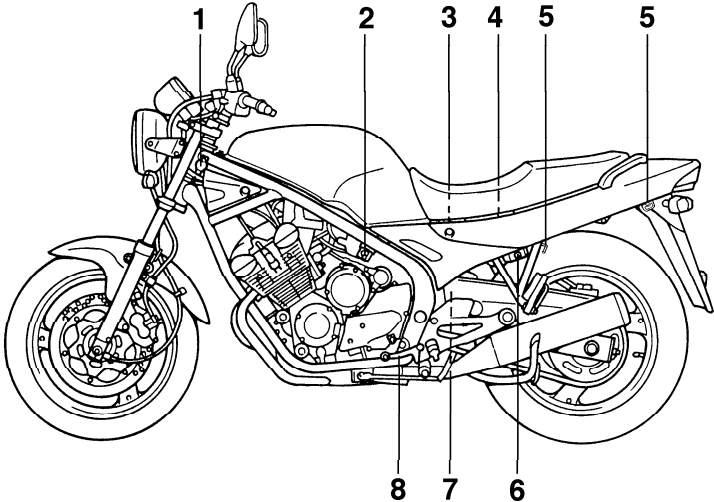

- | | | | |
|--------------------------|-------------|---|-------------|
| 1. Steering lock | (page 3-3) | 6. Seat lock | (page 3-14) |
| 2. Fuel cock | (page 3-13) | 7. Rear shock absorber spring preload
adjusting ring | (page 3-15) |
| 3. Helmet holder | (page 3-15) | 8. Shift pedal | (page 3-10) |
| 4. Fuse box | (page 6-26) | | |
| 5. Luggage strap holders | (page 3-16) | | |

DESCRIPTION

Right view (XJ600N)

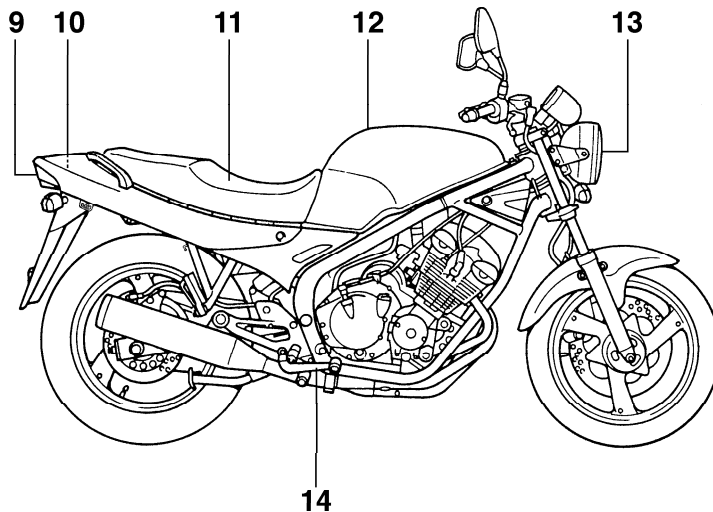

- | | |
|-------------------------|-------------|
| 9. Tail/brake light | (page 6-17) |
| 10. Storage compartment | (page 3-15) |
| 11. Seat | (page 3-14) |
| 12. Fuel tank | (page 3-11) |
| 13. Headlight | (page 6-27) |
| 14. Rear brake pedal | (page 3-11) |

Controls/Instruments (XJ600N)

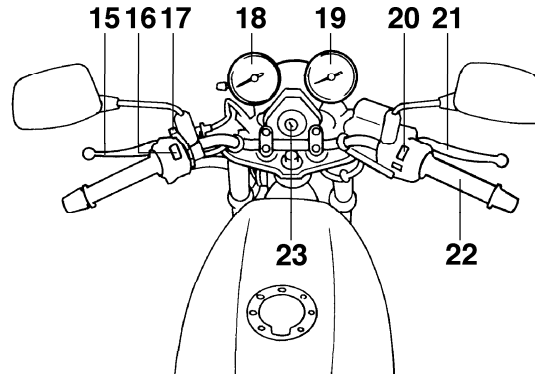

- 15. Clutch lever (page 3-9)
- 16. Left handlebar switches (page 3-7)
- 17. Starter (choke) “|x|” (page 3-14)
- 18. Speedometer (page 3-6)
- 19. Tachometer (page 3-7)
- 20. Right handlebar switches (page 3-9)
- 21. Front brake lever (page 3-10)
- 22. Throttle grip (page 6-12)
- 23. Main switch (page 3-1)

INSTRUMENT AND CONTROL FUNCTIONS

Main switch.....	3-1	Fuel tank cap	3-11
Steering lock (for XJ600N)	3-3	Fuel.....	3-12
Indicator lights	3-3	Fuel tank breather hose (for Germany only)	3-12
Oil level indicator circuit check	3-5	Fuel cock.....	3-13
Speedometer (for XJ600S).....	3-6	Starter (choke) “ ↘ ”	3-14
Speedometer (for XJ600N)	3-6	Seat.....	3-14
Tachometer	3-7	Helmet holders.....	3-15
Handlebar switches	3-7	Storage compartment	3-15
Clutch lever	3-9	Rear shock absorber adjustment	3-15
Shift pedal	3-10	Luggage strap holders	3-16
Front brake lever	3-10	Sidestand	3-17
Rear brake pedal.....	3-11	Sidestand/clutch switch operation check	3-17

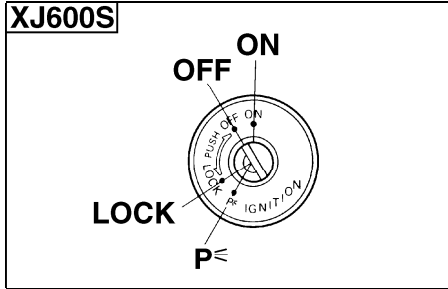

EAU00028

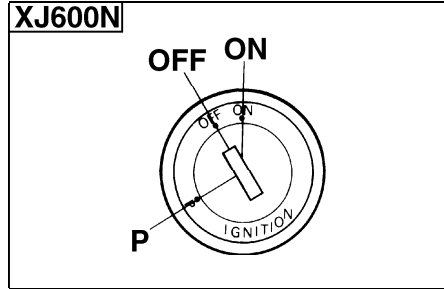

EAU00038

Main switch

The main switch controls the ignition and lighting systems. Its operation is described below.

ON

Electrical circuits are switched on. The engine can be started. The key cannot be removed in this position.

EAU00036

OFF

All electrical circuits are switched off. The key can be removed in this position.

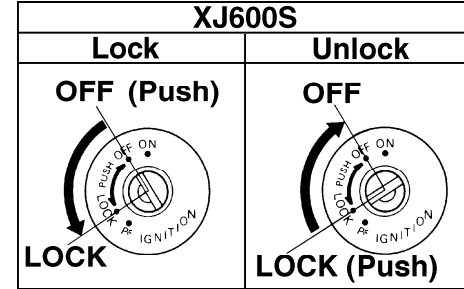

EAU00040

LOCK (for XJ600S)

The steering is locked in this position and all electrical circuits are switched off. The key can be removed in this position. To lock the steering, turn the handlebars all the way to the left. While pushing the key into the main switch, turn it from "OFF" to "LOCK" and remove it. To release the lock, turn the key to "OFF" while pushing.

INSTRUMENT AND CONTROL FUNCTIONS

XJ600S

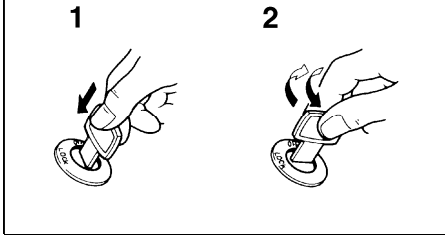

1. Push
2. Turn

EW000016

WARNING

Never turn the key to “OFF” or “LOCK” when the motorcycle is moving. The electrical circuits will be switched off which may result in loss of control or an accident. Be sure the motorcycle is stopped before turning the key to “OFF” or “LOCK”.

EAU01590

P (Parking) (for XJ600S)

The steering is locked in this position, and the taillight and auxiliary light come on but all other circuits are off. The key can be removed in this position.

To use the parking position, first lock the steering, then turn the key to “P”. Do not use this position for an extended length of time as the battery may discharge.

XJ600N

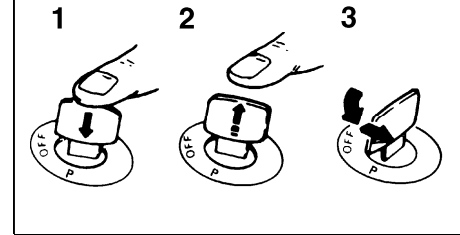

1. Push
2. Release
3. Turn

EAU00055

P (Parking) (for XJ600N)

The taillight and auxiliary light come on but all other circuits are off. With the key at “OFF”, push it into the main switch and release it. Then turn it counterclockwise to “P”, and remove it. (Do not use this position for an extended length of time as the battery may discharge.) To cancel the parking, turn the key clockwise.

INSTRUMENT AND CONTROL FUNCTIONS

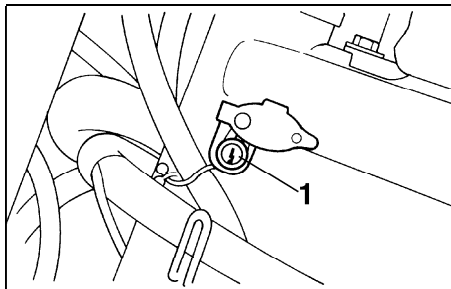

1. Steering lock

Steering lock (for XJ600N)

To lock the steering





Turn the handlebars all the way to the right and open the steering lock cover. Insert the key and turn it 1/8 turn counterclockwise. Then, push the key in while turning the handlebars slightly to the left and turn the key 1/8 turn clockwise. Check that the steering is locked, remove the key and close the lock cover.

To unlock the steering

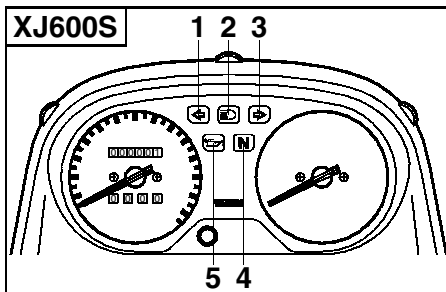
Insert the key, push it in and turn it 1/8 turn counterclockwise so that it moves out. Then, release and remove the key.

EAU02934



1. Left turn indicator light “”
2. High beam indicator light “”
3. Right turn indicator light “”
4. Neutral indicator light “”
5. Oil level indicator light “”

EAU00056

Indicator lights

Turn indicator lights “” / “”

The corresponding indicator flashes when the turn switch is moved to the left or right.





EAU00058

Neutral indicator light “”

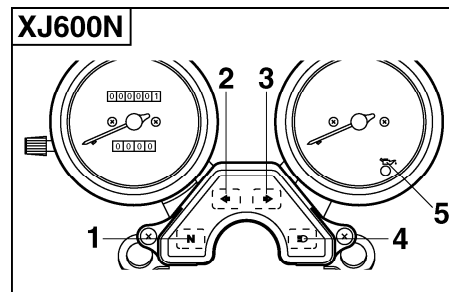
This indicator comes on when the transmission is in neutral.

EAU00061



1. Neutral indicator light “”
2. Left turn indicator light “”
3. Right turn indicator light “”
4. High beam indicator light “”
5. Oil level indicator light “”

EAU00063

High beam indicator light “”

This indicator comes on when the headlight high beam is used.

EAU01313

Oil level indicator light “”

This indicator comes on when the oil level is low. This light circuit can be checked by the procedure on page 3-5.

INSTRUMENT AND CONTROL FUNCTIONS

EC000000

CAUTION: _____

Do not run the motorcycle until you know it has sufficient engine oil.

NOTE: _____

Even if the oil is filled to the specified level, the indicator light may flicker when riding on a slope or during sudden acceleration or deceleration, but this is normal.

INSTRUMENT AND CONTROL FUNCTIONS

EAU00071

Oil level indicator circuit check

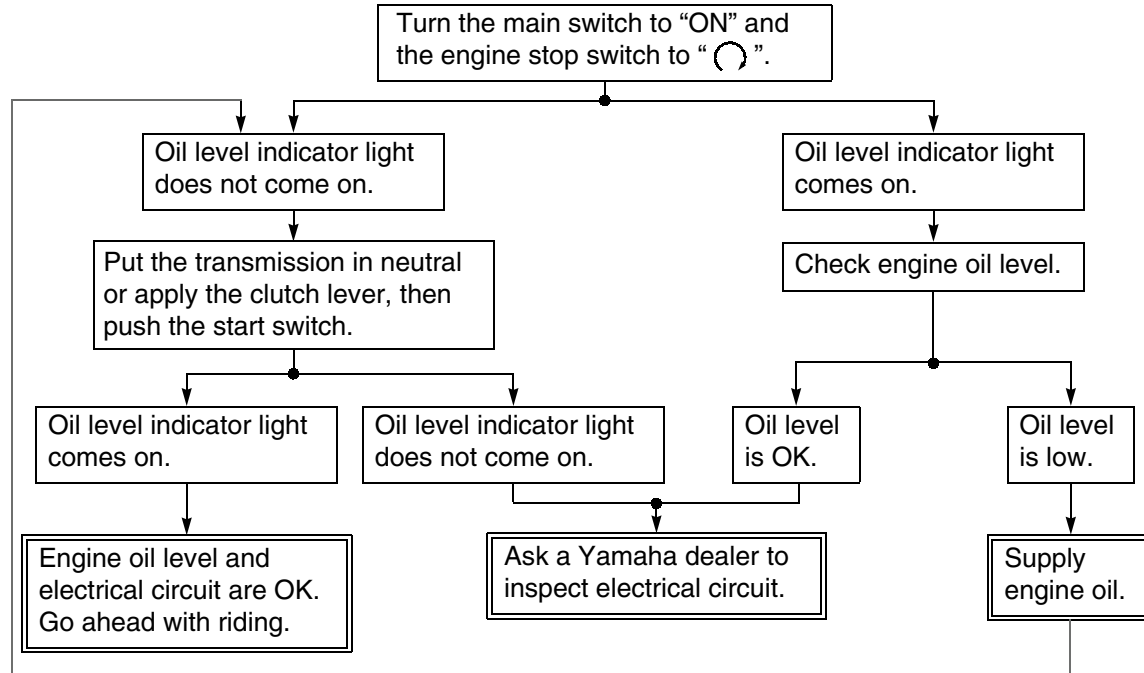

3

INSTRUMENT AND CONTROL FUNCTIONS

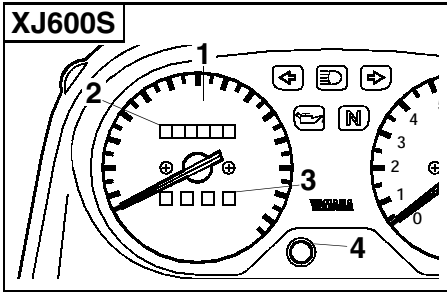

1. Speedometer
2. Odometer
3. Trip odometer
4. Reset button

EAU00094

Speedometer (for XJ600S)

The speedometer shows riding speed. This speedometer is equipped with an odometer and trip odometer. The trip odometer can be reset to “0” with the reset button. Use the trip odometer to estimate how far you can ride on a tank of fuel. This information will enable you to plan fuel stops in the future.

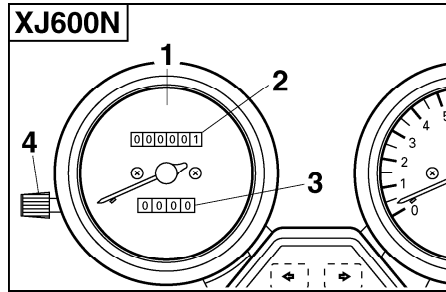

1. Speedometer
2. Odometer
3. Trip odometer
4. Reset knob

EAU00095

Speedometer (for XJ600N)

The speedometer shows riding speed. This speedometer is equipped with an odometer and trip odometer. The trip odometer can be reset to “0” with the reset knob. Use the trip odometer to estimate how far you can ride on a tank of fuel. This information will enable you to plan fuel stops in the future.

INSTRUMENT AND CONTROL FUNCTIONS

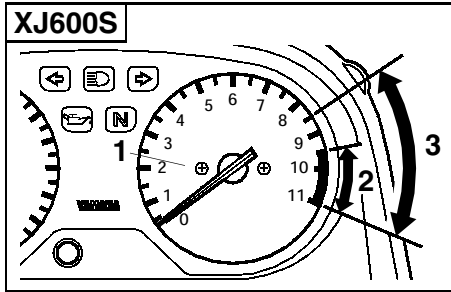

1. Tachometer
2. Red zone (except for CH, A)
3. Red zone (for CH, A)

EAU00101

Tachometer

This model is equipped with an electric tachometer so the rider can monitor the engine speed and keep it within the ideal power range.

EC000003

CAUTION:

Do not operate in the red zone.
Red zone: 9,500 r/min and above
(except for CH, A)
8,500 r/min and above
(for CH, A)

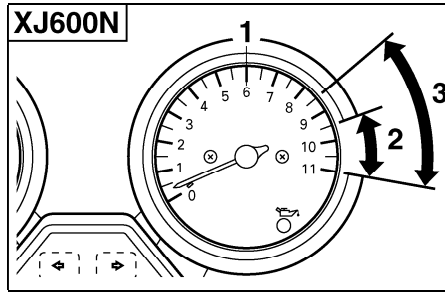

1. Tachometer
2. Red zone (except for CH, A)
3. Red zone (for CH, A)

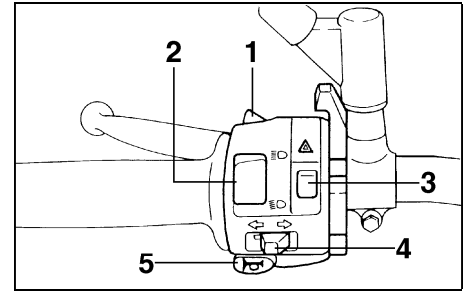

1. Pass switch "PASS"
2. Dimmer switch
3. Hazard switch "▲"
4. Turn signal switch
5. Horn switch "📣"

EAU00118

Handlebar switches

EAU00120

Pass switch "PASS"

Press the switch to operate the passing light.

EAU00121

Dimmer switch

Turn the switch to "☰" for the high beam and to "☷" for the low beam.

Hazard switch “”

EAU00144

The hazard switch should be turned on under emergency or hazardous conditions. All turn signal lights will flash simultaneously when this switch is turned on with the main switch in the “ON” or “P” position.

EC000006

CAUTION:



The battery can discharge from extended use, making it difficult to operate the starter.

NOTE:

Turn on the hazard switch to warn other drivers if your motorcycle must be stopped where it might be a traffic hazard.

Turn signal switch

EAU00127

To signal a right-hand turn, push the switch to “”. To signal a left-hand turn, push the switch to “”. Once the switch is released it will return to the center position. To cancel the signal, push the switch in after it has returned to the center position.

Horn switch “”

EAU00129

Press the switch to sound the horn.

INSTRUMENT AND CONTROL FUNCTIONS

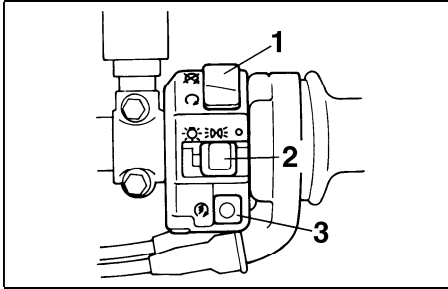

1. Engine stop switch
2. Lights switch
3. Start switch “

Engine stop switch

EAU00138

The engine stop switch is a safety device for use in an emergency such as when the motorcycle overturns or if trouble occurs in the throttle system. Turn the switch to “

Lights switch

EAU00134

Turning the light switch to “

Start switch “ EAU00143

The starter motor cranks the engine when pushing the start switch.

EC000005

CAUTION:

See starting instructions prior to starting the engine.

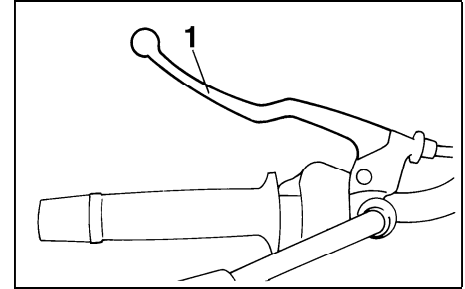

1. Clutch lever

EAU00152

Clutch lever

The clutch lever is located on the left handlebar, and the ignition circuit cut-off system is incorporated in the clutch lever holder. Pull the clutch lever to the handlebar to disengage the clutch, and release the lever to engage the clutch. The lever should be pulled rapidly and released slowly for smooth clutch operation. (Refer to the engine starting procedures for a description of the ignition circuit cut-off system.)

INSTRUMENT AND CONTROL FUNCTIONS

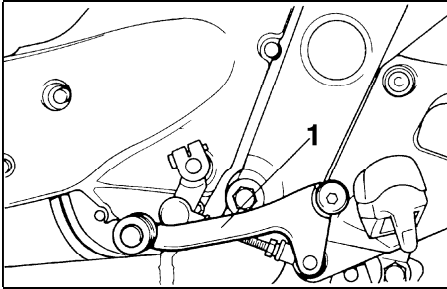

1. Shift pedal

EAU00157

Shift pedal

This motorcycle is equipped with a constant-mesh 6-speed transmission.

The shift pedal is located on the left side of the engine and is used in combination with the clutch when shifting.

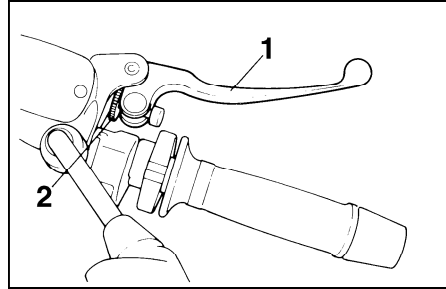

1. Front brake lever
2. Position adjusting nut

EAU00160

Front brake lever

The front brake lever is located on the right handlebar and is equipped with a position adjuster. To activate the front brake, pull the lever toward the handlebar.

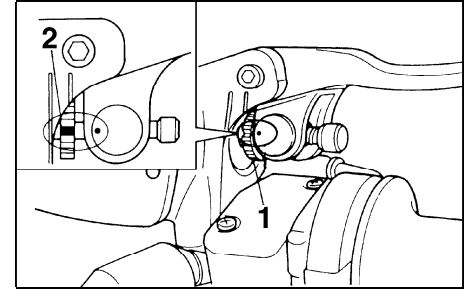

1. Position adjusting nut
2. Proper position

To adjust the front brake lever position, turn the adjusting nut while pulling the lever forward. Make sure the mark “■” on the adjusting nut is aligned with the mark “●” on the lever.

INSTRUMENT AND CONTROL FUNCTIONS

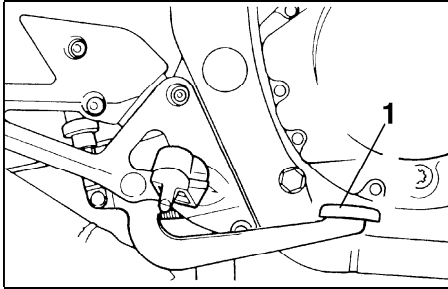

1. Rear brake pedal

EAU00162

Rear brake pedal

The rear brake pedal is on the right side of the motorcycle. Press down on the brake pedal to apply the rear brake.

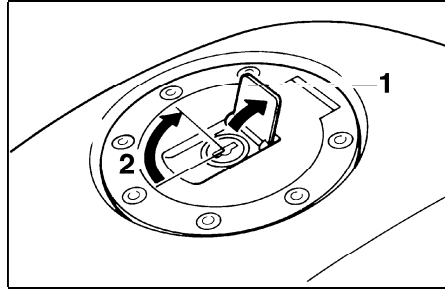

1. Lock cover
2. Open

EAU02935

Fuel tank cap

To open

Open the lock cover. Insert the key and turn it 1/4 turn clockwise. The lock will be released and the cap can be opened.

To close

Push the tank cap into position with the key inserted. To remove the key, turn it counterclockwise to the original position. Then, close the lock cover.

NOTE:

This tank cap cannot be closed unless the key is in the lock. The key cannot be removed if the cap is not locked properly.

EW000023

WARNING

Be sure the cap is properly installed and locked in place before riding the motorcycle.

INSTRUMENT AND CONTROL FUNCTIONS

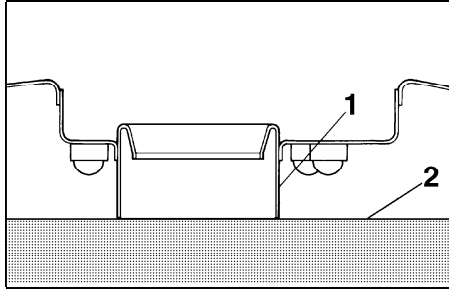

1. Filler tube
2. Fuel level

EAU01183

Fuel

Make sure there is sufficient fuel in the tank. Fill the fuel tank to the bottom of the filler tube as shown in the illustration.

EW000130

WARNING

Do not overfill the fuel tank. Avoid spilling fuel on the hot engine. Do not fill the fuel tank above the bottom of the filler tube or it may overflow when the fuel heats up later and expands.

EAU00185

CAUTION:

Always wipe off spilled fuel immediately with a dry and clean soft cloth. Fuel may deteriorate painted surfaces or plastic parts.

EAU00191

Recommended fuel:

Regular unleaded gasoline with a research octane number of 91 or higher.

Fuel tank capacity:

Total:
17.0 L
Reserve:
3.5 L

NOTE:

If knocking or pinging occurs, use a different brand of gasoline or higher octane grade.

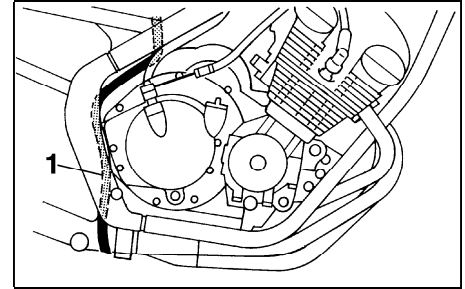

1. Fuel tank breather hose

EAU00196

Fuel tank breather hose (for Germany only)

This model is equipped with a fuel tank breather hose. Before using this motorcycle, be sure to:

- Check hose connection.
- Check hose for cracks or damage. Replace if damaged.
- Make sure the end of the hose is not blocked. Clean it if necessary.

INSTRUMENT AND CONTROL FUNCTIONS

3

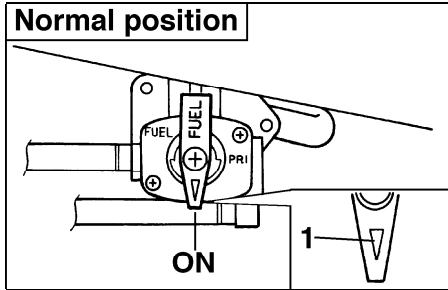

1. Arrow mark positioned over "ON"

EAU00207

Fuel cock

The fuel cock supplies fuel from the tank to the carburetors while also filtering it.

The fuel cock has three positions, which should be set as illustrated.

ON

With the fuel cock in this position, fuel flows to the carburetors when the engine is running. Set the fuel cock to this position when starting the engine and for riding.

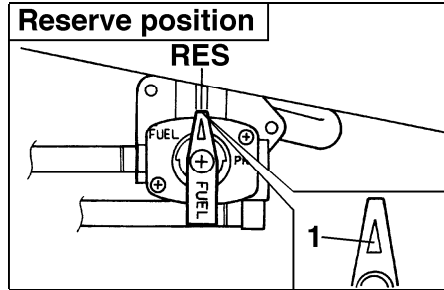

1. Arrow mark positioned over "RES"

RES

This stands for "reserve". If you are running out of fuel while riding with the fuel cock in the "ON" position, quickly turn the lever to this position. Otherwise the engine may die and will have to be primed (see "PRI" below). After turning the lever to "RES", fill the tank at the first opportunity and be sure to set the fuel cock back to "ON"!

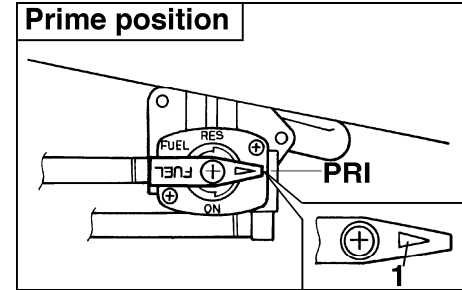

1. Arrow mark positioned over "PRI"

PRI

This stands for "prime". If the engine has been allowed to run out of fuel, turn the lever to the "PRI" position to send fuel directly to the carburetors. This will make starting easier. However, be sure to turn the lever to the "ON" position (or "RES" if you have not refuelled yet) after the engine has started.

INSTRUMENT AND CONTROL FUNCTIONS

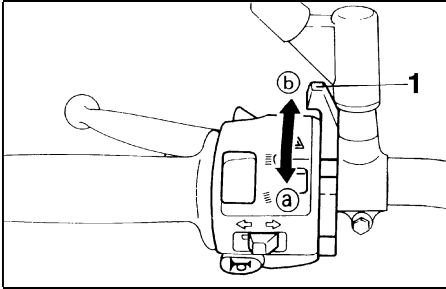

1. Starter (choke) “|↘|”

EAU02976

Starter (choke) “|↘|”

Starting a cold engine requires a richer air-fuel mixture. A separate starter circuit supplies this mixture.

Move in direction ① to turn on the starter (choke).

Move in direction ② to turn off the starter (choke).

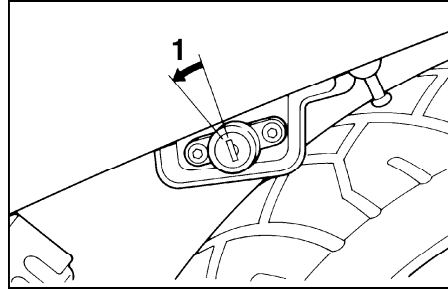

1. Open

EAU02925

Seat

To remove

Insert the key in the lock and turn it counterclockwise.

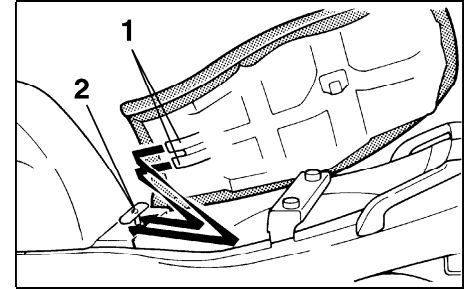

1. Projection (× 2)

2. Seat holder

To install

Insert the projections on the front of the seat into the seat holder, then push down on the seat.

NOTE: _____
Make sure that the seat is securely fitted.

INSTRUMENT AND CONTROL FUNCTIONS

3

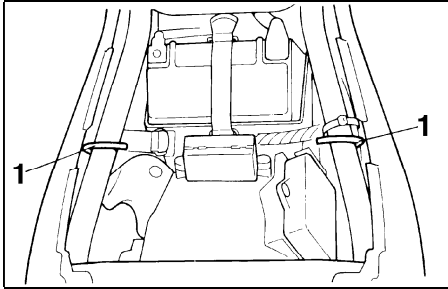

1. Helmet holder (× 2)

EAU02936

Helmet holders

The helmet holders are under the seat. Remove the seat and hook the helmets on the helmet holders. Then, install the seat and lock it.

EWA00022

WARNING

Never ride with helmets in the helmet holders. The helmets may hit objects, causing loss of control and possibly an accident.

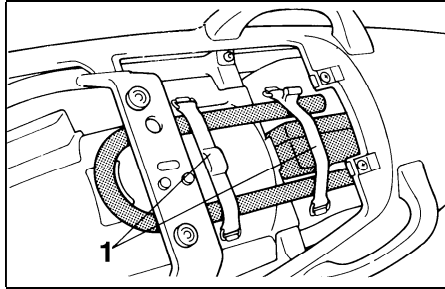

1. Strap for U-LOCK (× 2)

EAU01688

Storage compartment

This compartment is designed to store a genuine Yamaha U-LOCK. (Other locks may not fit.)

Be sure the lock is fastened securely with the straps when storing it in the compartment.

To prevent losing the straps, be sure to secure them even when a U-LOCK is not being stored in the compartment.

When storing this Owner's manual or other documents in the compartment, be sure to put them in a vinyl bag so they do not get wet. When washing the motorcycle, be careful not to flood this compartment with water.

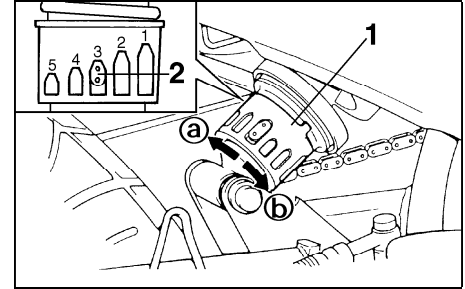

1. Spring preload adjusting ring
2. Position indicator

EAU00295

Rear shock absorber adjustment

This shock absorber is equipped with a spring preload adjusting ring. Adjust spring preload as follows. Turn the adjusting ring in direction **a** to increase spring preload and in direction **b** to decrease spring preload. Make sure that the appropriate notch in the adjusting ring is aligned with the position indicator on the rear shock absorber.

INSTRUMENT AND CONTROL FUNCTIONS

EAU00315

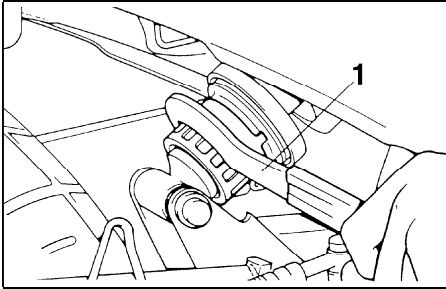

1. Special wrench

Adjusting position	Hard				Standard	Soft	
	7	6	5	4	3	2	1

⚠ WARNING

This shock absorber contains highly pressurized nitrogen gas. Read and understand the following information before handling the shock absorber. The manufacturer cannot be held responsible for property damage or personal injury that may result from improper handling.

- Do not tamper with or attempt to open the cylinder assembly.
- Do not subject the shock absorber to an open flame or other high heat source. This may cause the unit to explode due to excessive gas pressure.
- Do not deform or damage the cylinder in any way. Cylinder damage will result in poor damping performance.
- Take your shock absorber to a Yamaha dealer for any service.

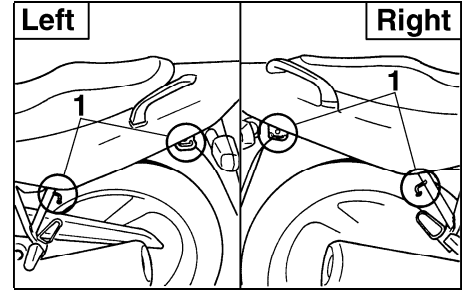

1. Luggage strap holder (x 4)

EAU01398

Luggage strap holders

This motorcycle is equipped with four luggage strap holders. There is a holder on each passenger footrest bracket and below each side of the seat.

INSTRUMENT AND CONTROL FUNCTIONS

Sidestand

This model is equipped with an ignition circuit cut-off system. The motorcycle must not be ridden when the sidestand is down. The sidestand is located on the left side of the frame. (Refer to page 5-1 for an explanation of this system.)

EAU00330

WARNING

This motorcycle must not be operated with the sidestand in the down position. If the stand is not properly retracted, it could contact the ground and distract the operator, resulting in a possible loss of control. Yamaha has designed into this motorcycle a lockout system to assist the operator in fulfilling the responsibility of retracting the sidestand. Please check carefully the operating instructions listed below and if there is any indication of a malfunction, return the motorcycle to a Yamaha dealer immediately for repair.

EW000044

Sidestand/clutch switch operation check

Check the operation of the sidestand switch and clutch switch against the information below.

EAU00332

WARNING

- Be sure to use the centerstand during this inspection.
- If improper operation is noted, consult a Yamaha dealer.

EW000046

TURN MAIN SWITCH TO "ON" AND ENGINE STOP SWITCH TO " ".

TRANSMISSION IS IN GEAR AND SIDESTAND IS UP.

PULL IN CLUTCH LEVER AND PUSH START SWITCH.

ENGINE WILL START.

CLUTCH SWITCH IS OK.

SIDESTAND IS DOWN.

ENGINE WILL STALL.

SIDESTAND SWITCH IS OK.

Pre-operation check list..... 4-1

PRE-OPERATION CHECKS

Owners are personally responsible for their vehicle's condition. Your motorcycle's vital functions can start to deteriorate quickly and unexpectedly, even if it remains unused (for instance, if it is exposed to the elements). Any damage, fluid leak or loss of tire pressure could have serious consequences. Therefore, it is very important that, in addition to a thorough visual inspection, you check the following points before each ride.

PRE-OPERATION CHECK LIST

ITEM	CHECKS	PAGE
Front brake	<ul style="list-style-type: none">• Check operation, fluid level and fluid leakage.• Fill with DOT 4 (or DOT 3) brake fluid if necessary.	6-18 ~ 6-20
Rear brake		6-17 ~ 6-20
Clutch	<ul style="list-style-type: none">• Check operation, condition and free play.• Adjust if necessary.	6-15 ~ 6-16
Throttle grip and housing	<ul style="list-style-type: none">• Check for smooth operation.• Lubricate if necessary.	6-12, 6-22
Engine oil	<ul style="list-style-type: none">• Check oil level.• Fill with oil if necessary.	6-7 ~ 6-9
Drive chain	<ul style="list-style-type: none">• Check chain slack and condition.• Adjust if necessary.	6-20 ~ 6-21
Wheels and tires	<ul style="list-style-type: none">• Check tire pressure, wear and damage.	6-13 ~ 6-15, 6-31 ~ 6-34
Control and meter cables	<ul style="list-style-type: none">• Check for smooth operation.• Lubricate if necessary.	6-22
Brake and shift pedal shafts	<ul style="list-style-type: none">• Check for smooth operation.• Lubricate if necessary.	6-22
Brake and clutch lever pivots	<ul style="list-style-type: none">• Check for smooth operation.• Lubricate if necessary.	6-23
Center and sidestand pivots	<ul style="list-style-type: none">• Check for smooth operation.• Lubricate if necessary.	6-23

PRE-OPERATION CHECKS

ITEM	CHECKS	PAGE
Chassis fasteners	<ul style="list-style-type: none">• Make sure that all nuts, bolts and screws are properly tightened.• Tighten if necessary.	—
Fuel tank	<ul style="list-style-type: none">• Check fuel level.• Fill with fuel if necessary.	3-11 ~ 3-12
Lights, signals and switches	<ul style="list-style-type: none">• Check for proper operation.	3-7 ~ 3-9, 6-27 ~ 6-30

NOTE:

Pre-operation checks should be made each time the motorcycle is used. Such an inspection can be thoroughly accomplished in a very short time; and the added safety it assures is more than worth the time involved.

 WARNING

If any item in the PRE-OPERATION CHECK is not working properly, have it inspected and repaired before operating the motorcycle.

OPERATION AND IMPORTANT RIDING POINTS

Starting the engine	5-1
Starting a warm engine	5-4
Shifting	5-4
Recommended shift points (for Switzerland only)	5-5
Tips for reducing fuel consumption	5-5
Engine break-in	5-5
Parking	5-6

EAU00373

EAU00381

⚠ WARNING

- Before riding this motorcycle, become thoroughly familiar with all operating controls and their functions. Consult a Yamaha dealer regarding any control or function that you do not thoroughly understand.
- Never start your engine or let it run for any length of time in a closed area. The exhaust fumes are poisonous and can cause loss of consciousness and death within a short time. Always operate your motorcycle in an area with adequate ventilation.
- Before starting out, always be sure the sidestand is up. Failure to retract the sidestand completely can result in a serious accident when you try to turn a corner.

Starting the engine

NOTE:

This motorcycle is equipped with an ignition circuit cut-off system. The engine can be started only under one of the following conditions:

- The transmission is in neutral.
- The sidestand is up, the transmission is in gear and the clutch is disengaged.

The motorcycle must not be ridden when the sidestand is down.

EW000054

⚠ WARNING

Before going through the following steps, check the function of the sidestand switch and clutch switch. (Refer to page 3-17.)

OPERATION AND IMPORTANT RIDING POINTS

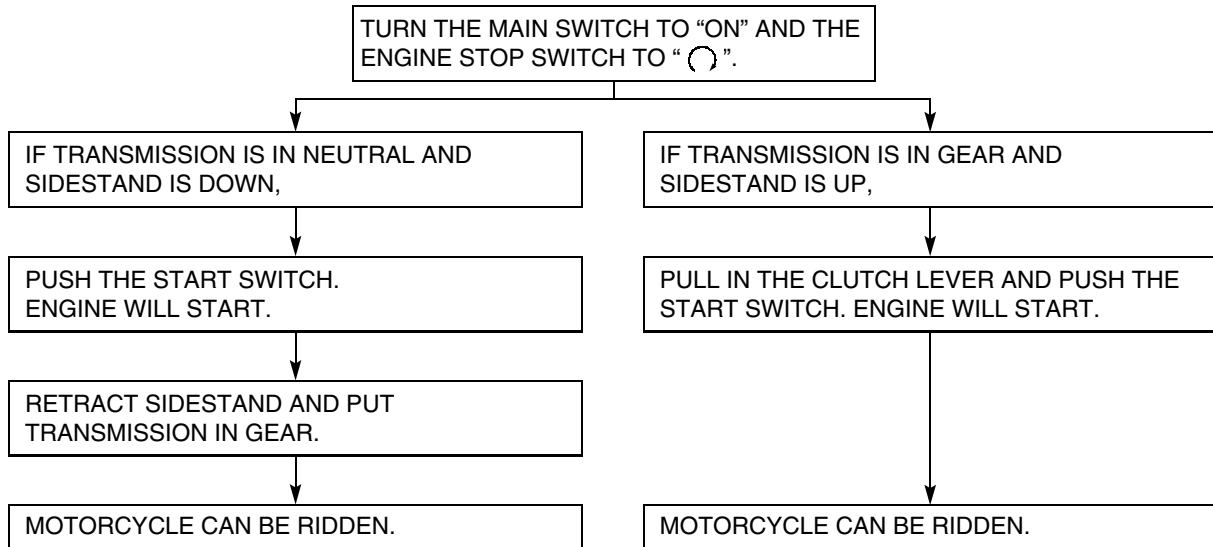

OPERATION AND IMPORTANT RIDING POINTS

EC000034

1. Turn the fuel cock to "ON".
2. Turn the main switch to "ON" and the engine stop switch to " ".
3. Shift transmission into neutral.

NOTE: _____

When the transmission is in neutral, the neutral indicator light should be on. If the light does not come on, ask a Yamaha dealer to inspect it.

4. Turn on the starter (choke) and completely close the throttle grip.
5. Start the engine by pushing the start switch.

NOTE: _____

If the engine fails to start, release the start switch, wait a few seconds, then try again. Each attempt should be as short as possible to preserve the battery. Do not crank the engine more than 10 seconds on any one attempt.

CAUTION: _____

The oil level indicator light should come on when the start switch is pushed and should go off when the start switch is released. If the indicator light flickers or remains on, immediately stop the engine and check the engine oil level and for oil leakage. If necessary, fill the engine with oil and check to see that the oil level indicator light goes off. If the light does not go off even with sufficient oil in the crankcase or the light does not come on when pushing the start switch, consult a Yamaha dealer.

6. After starting the engine, move the starter (choke) halfway back.

NOTE: _____

For maximum engine life, never accelerate hard with a cold engine!

7. After the engine is warm, turn off the starter (choke) completely.

NOTE: _____

The engine is warm when it responds normally to the throttle with the starter (choke) turned off.

OPERATION AND IMPORTANT RIDING POINTS

EAU01258

Starting a warm engine

The starter (choke) is not required when the engine is warm.

EC000046

CAUTION:

See the “Engine break-in” section prior to operating the motorcycle for the first time.

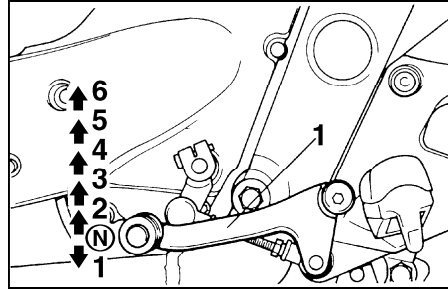

1. Shift pedal
N. Neutral

EAU00423

Shifting

The transmission lets you control the amount of power you have available at a given speed for starting, accelerating, climbing hills, etc. The use of the shift pedal is shown in the illustration.

To shift into neutral, depress the shift pedal repeatedly until it reaches the end of its travel, then raise the pedal slightly.

EC000048

CAUTION:

- Do not coast for long periods with the engine off, and do not tow the motorcycle a long distance. Even with gears in neutral, the transmission is only properly lubricated when the engine is running. Inadequate lubrication may damage the transmission.
- Always use the clutch when changing gears. The engine, transmission, and driveline are not designed to withstand the shock of forced shifting and can be damaged by shifting without using the clutch.

OPERATION AND IMPORTANT RIDING POINTS

EAU002937

Recommended shift points (for Switzerland only)

The recommended shift points are shown in the table below.

	Acceleration shift point (km/h)
1st → 2nd	20
2nd → 3rd	30
3rd → 4th	40
4th → 5th	50
5th → 6th	60

NOTE:

When shifting two gears down from 5th to 3rd, bring your motorcycle to a speed of 35 km/h.

EAU00424

Tips for reducing fuel consumption

Your motorcycle's fuel consumption depends to a large extent on your riding style. The following tips can help reduce fuel consumption:

- Warm up the engine before riding.
- Turn off the starter (choke) as soon as possible.
- Shift up swiftly and avoid high engine speeds during acceleration.
- Do not double-clutch or rev the engine while shifting down and avoid high engine speeds with no load on the engine.
- Turn off the engine instead of letting it idle for an extended length of time, i.e. in traffic jams, at traffic lights or railroad crossings.

EAU00436

Engine break-in

There is never a more important period in the life of your motorcycle than the period between zero and 1,000 km. For this reason we ask that you carefully read the following material. Because the engine is brand new, you must not put an excessive load on it for the first 1,000 km. The various parts in the engine wear and polish themselves to the correct operating clearances. During this period, prolonged full throttle operation, or any condition which might result in excessive heating of the engine, must be avoided.

OPERATION AND IMPORTANT RIDING POINTS

EAU00440

0 ~ 150 km

Avoid operation above 5,000 r/min. Stop the engine and let it cool for 5 to 10 minutes after every hour of operation. Vary the speed of the motorcycle from time to time. Do not operate it at one set throttle position.

150 ~ 500 km

Avoid prolonged operation above 6,000 r/min. Rev the motorcycle freely through the gears, but do not use full throttle at any time.

500 ~ 1,000 km

Avoid prolonged full throttle operation. Avoid cruising speeds in excess of 7,000 r/min.

EC000052

CAUTION:

After 1,000 km of operation, be sure to replace the engine oil and oil filter.

1,000 km and beyond

Full throttle can be used.

EC000053

CAUTION:

- **Never let engine speeds enter the red zone.**
- **If any engine trouble should occur during the break-in period, consult a Yamaha dealer immediately.**

EAU00460

Parking

When parking the motorcycle, stop the engine and remove the ignition key.

EW000058

WARNING

The exhaust system is hot. Park the motorcycle in a place where pedestrians or children are not likely to touch the motorcycle. Do not park the motorcycle on a slope or soft ground; the motorcycle may overturn.

PERIODIC MAINTENANCE AND MINOR REPAIR

Tool kit.....	6-1	Drive chain lubrication.....	6-21
Periodic maintenance and lubrication.....	6-2	Cable inspection and lubrication	6-22
Panel removal and installation	6-5	Throttle cable and grip lubrication.....	6-22
Panel A.....	6-5	Brake and shift pedal lubrication.....	6-22
Spark plug inspection	6-6	Brake and clutch lever lubrication	6-23
Engine oil.....	6-7	Center and sidestand lubrication	6-23
Air filter	6-10	Rear suspension lubrication.....	6-23
Carburetor adjustment.....	6-11	Front fork inspection	6-24
Idle speed adjustment	6-12	Steering inspection	6-24
Throttle cable free play inspection.....	6-12	Wheel bearings.....	6-25
Valve clearance adjustment	6-13	Battery.....	6-25
Tires	6-13	Fuse replacement	6-26
Wheels	6-15	Headlight bulb replacement (for XJ600S).....	6-27
Clutch lever free play adjustment	6-15	Headlight bulb replacement (for XJ600N).....	6-29
Rear brake pedal height adjustment	6-17	Front wheel removal	6-31
Brake light switch adjustment.....	6-17	Front wheel installation	6-31
Checking the front and rear brake pads	6-18	Rear wheel removal.....	6-33
Inspecting the brake fluid level	6-19	Rear wheel installation.....	6-34
Brake fluid replacement.....	6-20	Troubleshooting	6-34
Drive chain slack check.....	6-20	Troubleshooting chart	6-35
Drive chain slack adjustment.....	6-21		

EAU00464

Periodic inspection, adjustment and lubrication will keep your motorcycle in the safest and most efficient condition possible. Safety is an obligation of the motorcycle owner. The maintenance and lubrication schedule chart should be considered strictly as a guide to general maintenance and lubrication intervals. YOU MUST TAKE INTO CONSIDERATION THAT WEATHER, TERRAIN, GEOGRAPHICAL LOCATIONS, AND A VARIETY OF INDIVIDUAL USES ALL TEND TO DEMAND THAT EACH OWNER ALTER THIS TIME SCHEDULE TO SHORTER INTERVALS TO MATCH THE ENVIRONMENT. The most important points of motorcycle inspection, adjustment, and lubrication are explained in the following pages.

EW000060

⚠ WARNING

If you are not familiar with motorcycle service, this work should be done by a Yamaha dealer.

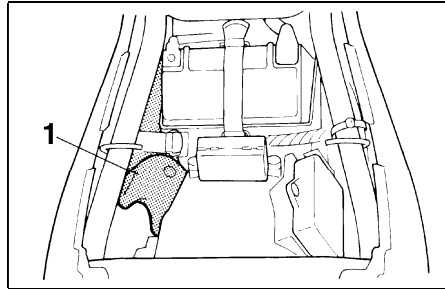

1. Tool kit

EAU00469

Tool kit

The service information included in this manual is intended to provide you, the owner, with the necessary information for completing some of your own preventive maintenance and minor repairs. The tools provided in the owner's tool kit are to assist you in the performance of periodic maintenance. However, some other tools such as a torque wrench are also necessary to perform the maintenance correctly.

NOTE:

If you do not have necessary tools required during a service operation, take your motorcycle to a Yamaha dealer for service.

EW000063

⚠ WARNING

Modifications to this motorcycle not approved by Yamaha may cause loss of performance, and render it unsafe for use. Consult a Yamaha dealer before attempting any changes.

PERIODIC MAINTENANCE AND MINOR REPAIR

EAU00473

PERIODIC MAINTENANCE AND LUBRICATION

NO.	ITEM	CHECKS AND MAINTENANCE JOBS	INITIAL (1,000 km)	EVERY	
				6,000 km or 6 months (whichever comes first)	12,000 km or 12 months (whichever comes first)
1	* Fuel line	<ul style="list-style-type: none"> • Check fuel hoses and vacuum hose for cracks or damage. • Replace if necessary. 		√	√
2	* Fuel filter	<ul style="list-style-type: none"> • Check condition. • Replace if necessary. 			√
3	Spark plugs	<ul style="list-style-type: none"> • Check condition. • Clean, regap or replace if necessary. 	√	√	√
4	* Valves	<ul style="list-style-type: none"> • Check valve clearance. • Adjust if necessary. 	Every 24,000 km or 24 months (whichever comes first)		
5	Air filter	<ul style="list-style-type: none"> • Clean or replace if necessary. 		√	√
6	Clutch	<ul style="list-style-type: none"> • Check operation. • Adjust or replace cable. 	√	√	√
7	* Front brake	<ul style="list-style-type: none"> • Check operation, fluid level and vehicle for fluid leakage. (See NOTE on page 6-4.) • Correct accordingly. • Replace brake pads if necessary. 	√	√	√
8	* Rear brake	<ul style="list-style-type: none"> • Check operation, fluid level and vehicle for fluid leakage. (See NOTE on page 6-4.) • Correct accordingly. • Replace brake pads if necessary. 	√	√	√
9	* Wheels	<ul style="list-style-type: none"> • Check balance, runout and for damage. • Rebalance or replace if necessary. 		√	√
10	* Tires	<ul style="list-style-type: none"> • Check tread depth and for damage. • Replace if necessary. • Check air pressure. • Correct if necessary. 		√	√

PERIODIC MAINTENANCE AND MINOR REPAIR

NO.	ITEM	CHECKS AND MAINTENANCE JOBS	INITIAL (1,000 km)	EVERY	
				6,000 km or 6 months (whichever comes first)	12,000 km or 12 months (whichever comes first)
11	* Wheel bearings	<ul style="list-style-type: none"> • Check bearing for looseness or damage. • Replace if necessary. 		√	√
12	* Swingarm	<ul style="list-style-type: none"> • Check swingarm pivoting point for play. • Correct if necessary. • Lubricate with molybdenum disulfide grease every 24,000 km or 24 months (whichever comes first). 		√	√
13	Drive chain	<ul style="list-style-type: none"> • Check chain slack. • Adjust if necessary. Make sure that the rear wheel is properly aligned. • Clean and lubricate. 	Every 1,000 km and after washing the motorcycle or riding in rain.		
14	* Steering bearings	<ul style="list-style-type: none"> • Check bearing play and steering for roughness. • Correct accordingly. • Lubricate with lithium soap base grease every 24,000 km or 24 months (whichever comes first). 		√	√
15	* Chassis fasteners	<ul style="list-style-type: none"> • Make sure that all nuts, bolts and screws are properly tightened. • Tighten if necessary. 		√	√
16	Sidestand/centerstand	<ul style="list-style-type: none"> • Check operation. • Lubricate and repair if necessary. 		√	√
17	* Sidestand switch	<ul style="list-style-type: none"> • Check operation. • Replace if necessary. 	√	√	√
18	* Front fork	<ul style="list-style-type: none"> • Check operation and for oil leakage. • Correct accordingly. 		√	√
19	* Rear shock absorber assembly	<ul style="list-style-type: none"> • Check operation and shock absorber for oil leakage. • Replace shock absorber assembly if necessary. 		√	√
20	* Rear shock absorber assembly pivoting points	<ul style="list-style-type: none"> • Check operation. • Lubricate with molybdenum disulfide grease every 24,000 km or 24 months (whichever comes first). 		√	√

PERIODIC MAINTENANCE AND MINOR REPAIR

NO.	ITEM	CHECKS AND MAINTENANCE JOBS	INITIAL (1,000 km)	EVERY	
				6,000 km or 6 months (whichever comes first)	12,000 km or 12 months (whichever comes first)
21	* Carburetors	<ul style="list-style-type: none"> • Check engine idling speed, synchronization and starter operation. • Adjust if necessary. 	√	√	√
22	Engine oil	<ul style="list-style-type: none"> • Check oil level and vehicle for oil leakage. • Correct if necessary. • Change. (Warm engine before draining.) 	√	√	√
23	Engine oil filter cartridge	<ul style="list-style-type: none"> • Replace. 	√		√

* Since these items require special tools, data and technical skills, they should be serviced by a Yamaha dealer.

EAU01792

NOTE:

- The air filter needs more frequent service if you are riding in unusually wet or dusty areas.
- Hydraulic brake system
 - When disassembling the master cylinder or caliper, always replace the brake fluid. Check the brake fluid level regularly and fill as required.
 - Replace the oil seals on the inner parts of the master cylinder and caliper cylinder every two years.
 - Replace the brake hoses every four years or if cracked or damaged.

PERIODIC MAINTENANCE AND MINOR REPAIR

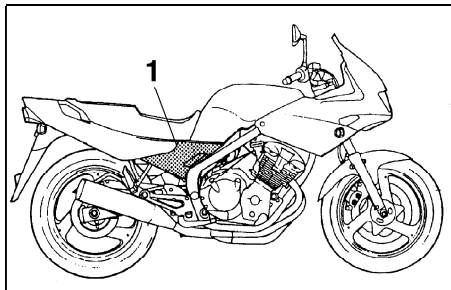

1. Panel A

EAU01777

Panel removal and installation

The panel illustrated needs to be removed to perform some of the maintenance described in this chapter. Refer to this section each time the panel has to be removed or installed.

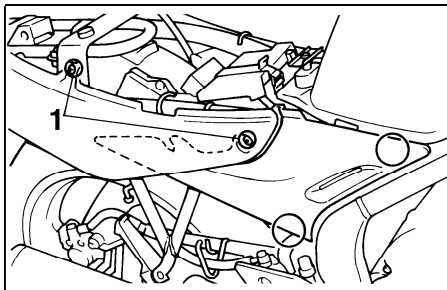

1. Screw (× 2)

EAU02926

Panel A

To remove

1. Remove the seat. (See page 3-14 for seat removal and installation procedures.)
2. Remove the screws and slide it as shown to unhook it.

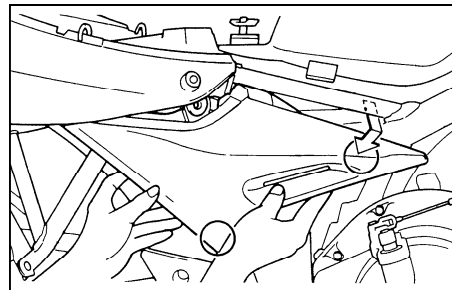

PERIODIC MAINTENANCE AND MINOR REPAIR

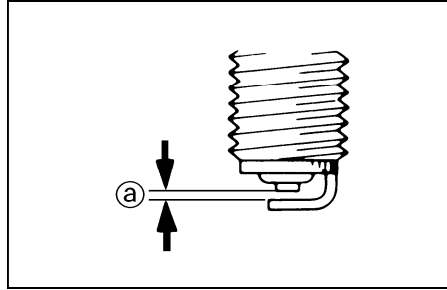
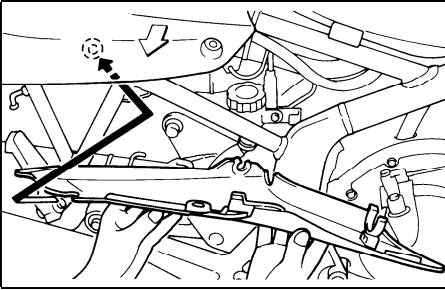

a. Spark plug gap

EAU01880

To install

1. Place in the original position and install the screws.
2. Install the seat.

Spark plug inspection

The spark plug is an important engine component and should be inspected periodically, preferably by a Yamaha dealer. The condition of the spark plug can indicate the condition of the engine.

Normally, all spark plugs from the same engine should have the same color on the white insulator around the center electrode. The ideal color at this point is a medium-to-light tan color for a motorcycle that is being ridden normally. If one spark plug shows a distinctly different color, there could be something wrong with the engine.

Do not attempt to diagnose such problems yourself. Instead, take the motorcycle to a Yamaha dealer. The spark plugs should be periodically removed and inspected because heat and deposits will cause any spark plug to slowly break down and erode. If electrode erosion becomes excessive, or if carbon and other deposits are excessive, the spark plug should be replaced with the specified plug.

Specified spark plug:
CR8E (NGK) or
U24ESR-N(DENSO)

Before installing any spark plug, measure the electrode gap with a wire thickness gauge and adjust it to specification.

Spark plug gap:
0.7 ~ 0.8 mm

PERIODIC MAINTENANCE AND MINOR REPAIR

When installing a spark plug, the gasket surface should always be cleaned and a new gasket used. Any grime should be wiped off from the threads and the spark plug tightened to the specified torque.

Tightening torque:
Spark plug:
12.5 Nm (1.25 m·kg)

NOTE:

If a torque wrench is not available when installing a spark plug, a good estimate of the correct torque is 1/4 to 1/2 turn past finger tight. The spark plug should be tightened to the specified torque as soon as possible.

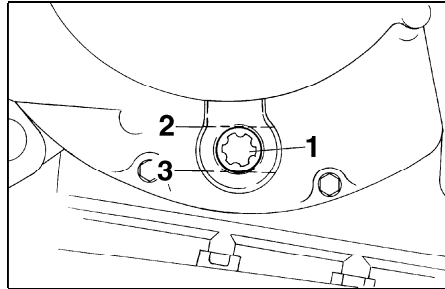

1. Level window
2. Maximum level mark
3. Minimum level mark

EAU02938

Engine oil

Oil level inspection

1. Place the motorcycle on the centerstand. Warm up the engine for several minutes.

NOTE:

Be sure the motorcycle is positioned straight up when checking the oil level. A slight tilt toward the side can result in false readings.

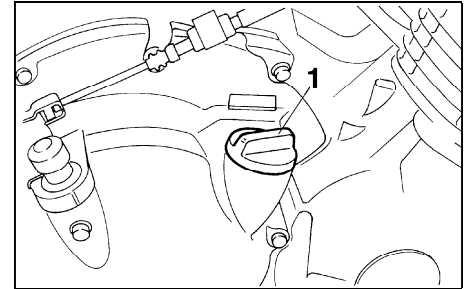

1. Engine oil filler cap
2. With the engine stopped, check the oil level through the level window located at the lower part of the right side crankcase cover.

NOTE:

Wait a few minutes until the oil level settles before checking.

3. The oil level should be between the maximum and minimum marks. If the level is low, fill the engine with sufficient oil to reach the specified level.

PERIODIC MAINTENANCE AND MINOR REPAIR

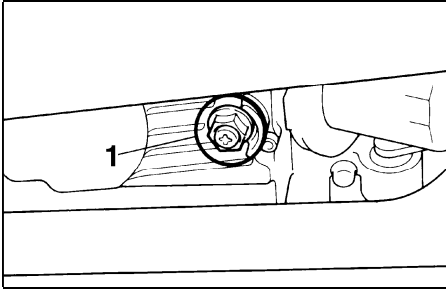

1. Engine oil drain bolt

Engine oil and oil filter cartridge replacement

1. Warm up the engine for several minutes.
2. Stop the engine. Place an oil pan under the engine and remove the oil filler cap.
3. Remove the drain bolt and drain the oil.

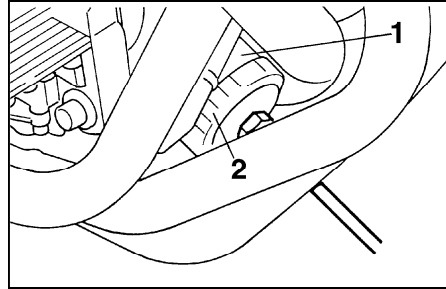

1. Oil filter cartridge
2. Oil filter wrench
4. Remove the oil filter by using an oil filter wrench.

NOTE: _____
An oil filter wrench is available at a nearby Yamaha dealer.

5. Install the drain bolt and tighten it to the specified torque.

Tightening torque:
Drain bolt:
43 Nm (4.3 m·kg)

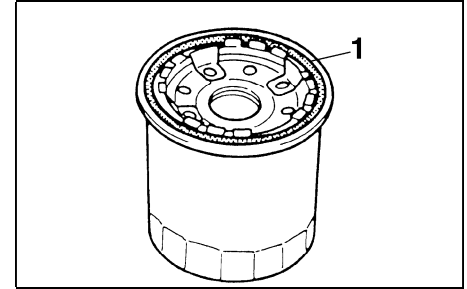

1. O-ring
6. Apply a light coat of engine oil to the O-ring of the new oil filter.

NOTE: _____
Make sure the O-ring is seated properly.

PERIODIC MAINTENANCE AND MINOR REPAIR

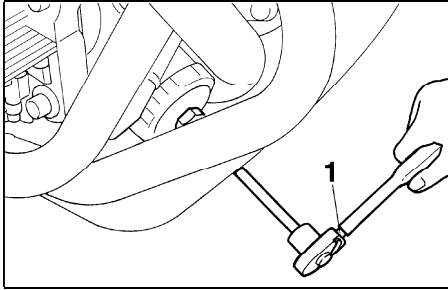

1. Torque wrench

7. Install the new oil filter and tighten it to the specified torque with an oil filter wrench.

NOTE: _____

When installing the oil filter, tighten it to the proper torque by using a torque wrench.

Tightening torque:

Oil filter:

17 Nm (1.7 m·kg)

8. Fill the engine with sufficient oil to reach the specified level. Install the oil filler cap and tighten it.

Recommended oil:

See page 8-1.

Oil quantity:

Total amount:

3.1 L

Periodic oil change:

2.3 L

With oil filter replacement:

2.6 L

EC000066

CAUTION: _____

- Do not put in any chemical additives. Engine oil also lubricates the clutch and additives could cause clutch slippage.
- Be sure no foreign material enters the crankcase.

9. Start the engine and warm it up for several minutes. While warming up, check for oil leakage. If oil leakage is found, stop the engine immediately and check for the cause.

NOTE: _____

After the engine is started, the oil level indicator light should go off if the oil is at the specified level.

EC000067

CAUTION: _____

If the indicator light flickers or remains on, immediately stop the engine and consult with a Yamaha dealer.

PERIODIC MAINTENANCE AND MINOR REPAIR

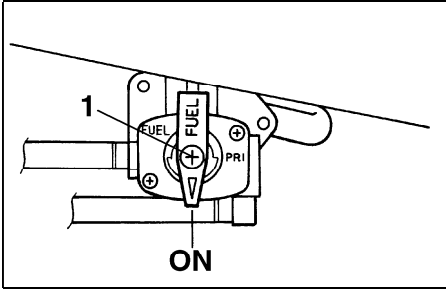

1. Screw

EAU02928

Air filter

The air filter should be cleaned at the specified intervals. It should be cleaned more frequently if you are riding in unusually wet or dusty areas.

1. Remove the seat. (See page 3-14 for seat removal and installation procedures.)
2. Turn the fuel cock lever to "ON". Then, remove the fuel cock lever by removing the screw.

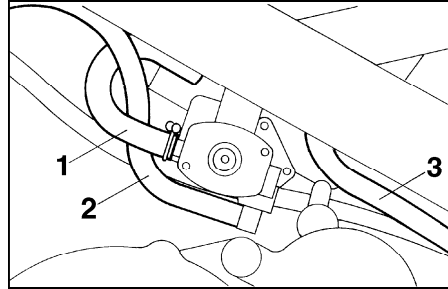

1. Fuel hose
 2. Vacuum hose
 3. Drain hose
3. Disconnect the hoses.

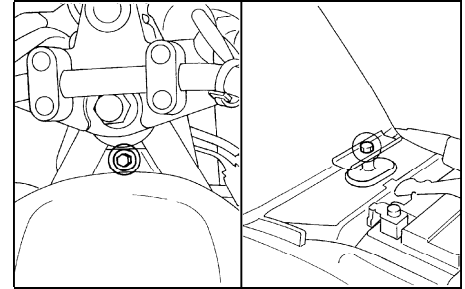

4. Remove the fuel tank.

PERIODIC MAINTENANCE AND MINOR REPAIR

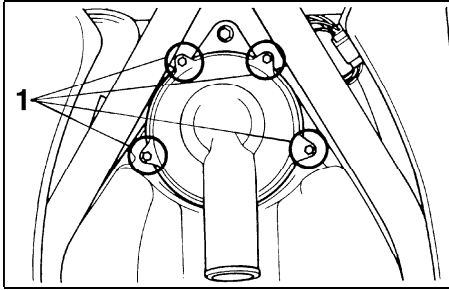

1. Screw (× 4)

5. Remove the air filter case cover by removing the screws.
6. Pull out the air filter.

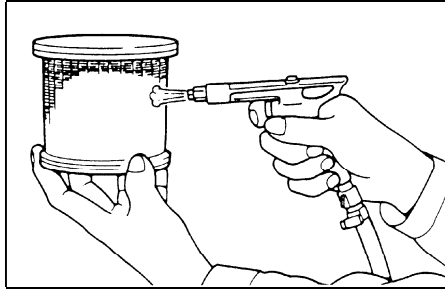

7. Tap the air filter lightly to remove most of the dust and dirt. Blow out the remaining dirt with compressed air as shown. If the air filter is damaged, replace it.
8. Reassemble by reversing the removal procedure.

EC000082

CAUTION:

- Make sure the air filter is properly seated in the air filter case.
- The engine should never be run without the air filter installed. Excessive piston and/or cylinder wear may result.

EAU00630

Carburetor adjustment

The carburetors are important parts of the engine and require very sophisticated adjustment. Most adjustments should be left to a Yamaha dealer who has the professional knowledge and experience to do so. However, the idle speed may be adjusted by the owner as part of routine maintenance.

EC000095

CAUTION:

The carburetors were set at the Yamaha factory after many tests. If they are changed, poor engine performance and damage may result.

PERIODIC MAINTENANCE AND MINOR REPAIR

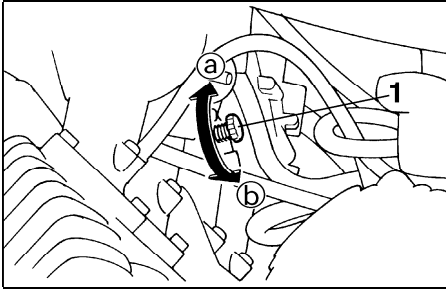

1. Throttle stop screw

EAU00632

Idle speed adjustment

1. Start the engine and warm it up for a few minutes at approximately 1,000 to 2,000 r/min. Occasionally rev the engine to 4,000 to 5,000 r/min. The engine is warm when it quickly responds to the throttle.
2. Set the idle to the specified engine speed by adjusting the throttle stop screw. Turn the screw in direction **(a)** to increase engine speed and in direction **(b)** to decrease engine speed.

Standard idle speed:
1,200 ~ 1,300 r/min

NOTE: _____
If the specified idle speed cannot be obtained by performing the above adjustment, consult a Yamaha dealer.

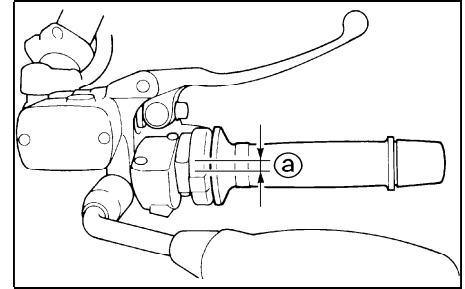

a. Free play

EAU00635

Throttle cable free play inspection

There should be a free play of 3 ~ 5 mm at the throttle grip. If the free play is incorrect, ask a Yamaha dealer to make this adjustment.

PERIODIC MAINTENANCE AND MINOR REPAIR

EAU00637

Valve clearance adjustment

The correct valve clearance changes with use, resulting in improper fuel/air supply or engine noise. To prevent this, the valve clearance must be adjusted regularly. This adjustment however, should be left to a professional Yamaha service technician.

EAU00647

Tires

To ensure maximum performance, long service, and safe operation, note the following:

Tire air pressure

Always check and adjust the tire pressure before operating the motorcycle.

EW000082



Tire inflation pressure should be checked and adjusted when the temperature of the tire equals the ambient air temperature. Tire inflation pressure must be adjusted according to total weight of cargo, rider, passenger, and accessories (fairing, saddlebags, etc. if approved for this model), and vehicle speed.

Maximum load*	XJ600S: 184 kg XJ600N: 187 kg	
Cold tire pressure	Front	Rear
Up to 90 kg*	200 kPa (2.00 kg/cm ² , 2.00 bar)	225 kPa (2.25 kg/cm ² , 2.25 bar)
90 kg load ~ Maximum load*	200 kPa (2.00 kg/cm ² , 2.00 bar)	250 kPa (2.50 kg/cm ² , 2.50 bar)
High speed riding	200 kPa (2.00 kg/cm ² , 2.00 bar)	250 kPa (2.50 kg/cm ² , 2.50 bar)

* Load is the total weight of cargo, rider, passenger and accessories.

PERIODIC MAINTENANCE AND MINOR REPAIR

EW000083

⚠ WARNING

Proper loading of your motorcycle is important for several characteristics of your motorcycle, such as handling, braking, performance and safety. Do not carry loosely packed items that can shift. Securely pack your heaviest items close to the center of the motorcycle, and distribute the weight evenly from side to side. Properly adjust the suspension for your load, and check the condition and pressure of your tires. **NEVER OVERLOAD YOUR MOTORCYCLE.** Make sure the total weight of the cargo, rider, passenger, and accessories (fairing, saddlebags, etc. if approved for this model) does not exceed the maximum load of the motorcycle. Operation of an overloaded motorcycle could cause tire damage, an accident, or even injury.

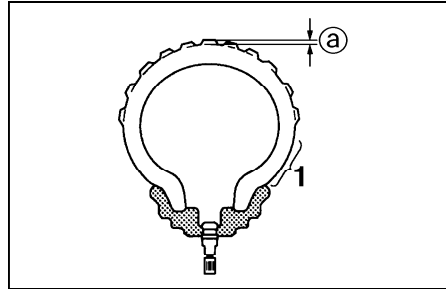

- a. Tread depth
- 1. Side wall

Tire inspection

Always check the tires before operating the motorcycle. If center tread depth reaches the limit as shown, if the tire has a nail or glass fragments in it, or if the side wall is cracked, contact a Yamaha dealer immediately and have the tire replaced.

FRONT

Manufacturer	Size	Type
DUNLOP	110/80-17 57H	D103FA
MICHELIN	110/80-17 57H	MACADAM 50

REAR

Manufacturer	Size	Type
DUNLOP	130/70-18 63H	D103A
MICHELIN	130/70-18 63H	MACADAM 50

Minimum tire tread depth (front and rear)	1.6 mm
---	--------

NOTE:

These limits may be different by regulation from country to country. If so, conform to the limits specified by the regulations of your own country.

PERIODIC MAINTENANCE AND MINOR REPAIR

EAU00683

WARNING

Operating the motorcycle with excessively worn tires decrease riding stability and can lead to loss of control. Have excessively worn tires replaced by a Yamaha dealer immediately. Brakes, tires, and related wheel parts replacement should be left to a Yamaha Service Technician.

6

Wheels

To ensure maximum performance, long service, and safe operation, note the following:

- Always inspect the wheels before a ride. Check for cracks, bends, or warpage of the wheels. If any abnormal condition exists in a wheel, consult a Yamaha dealer. Do not attempt even small repairs to the wheel. If a wheel is deformed or cracked, it must be replaced.
- Tires and wheels should be balanced whenever either one is changed or replaced. Failure to have a wheel balanced can result in poor performance, adverse handling characteristics, and shortened tire life.
- Ride at moderate speeds after changing a tire since the tire surface must first be broken in for it to develop its optimal characteristics.

EAU00687

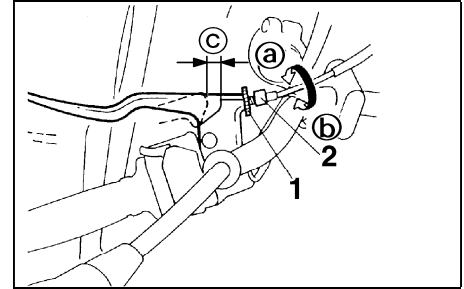

1. Locknut
2. Adjusting bolt
- c. Free play

EAU00694

Clutch lever free play adjustment

The clutch lever free play should be adjusted to 2 ~ 3 mm.

1. Loosen the locknut at the clutch lever.
2. Turn the adjusting bolt at the clutch lever in direction (a) to increase free play or in direction (b) to decrease free play.
3. Tighten the locknut at the clutch lever.

PERIODIC MAINTENANCE AND MINOR REPAIR

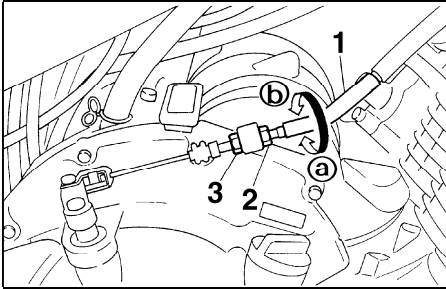

1. Clutch lever cable
2. Adjusting nut
3. Locknut

If the specified free play cannot be obtained, proceed with the following steps.

4. Loosen the locknut at the clutch lever.
5. Turn the adjusting bolt at the clutch lever in direction ① to loosen the cable.
6. Loosen the locknut at the crankcase side.

7. Turn the adjusting nut at the crankcase in direction ② to increase free play or in direction ③ to decrease free play.
8. Tighten the locknut at the crankcase and the clutch lever.

PERIODIC MAINTENANCE AND MINOR REPAIR

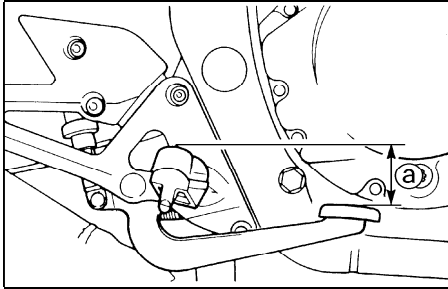

a. Pedal height

Rear brake pedal height adjustment

The top of the brake pedal should be positioned 40 mm below the top of the footrest. If not, ask a Yamaha dealer to adjust it.

EAU00712

EW000109

⚠ WARNING

A soft or spongy feeling in the brake pedal can indicate the presence of air in the brake system. This air must be removed by bleeding the brake system before the motorcycle is operated. Air in the system will cause greatly diminished braking capability and can result in loss of control and an accident. Have a Yamaha dealer inspect and bleed the system if necessary.

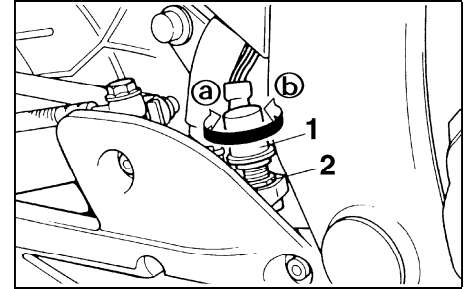

1. Brake light switch
2. Adjusting nut

EAU00713

Brake light switch adjustment

The rear brake light switch is activated by the brake pedal and is properly adjusted when the brake light comes on just before braking takes effect. To adjust the rear brake light switch, hold the switch body so it does not rotate while turning the adjusting nut. Turn the adjusting nut in direction **a** to make the brake light come on earlier. Turn the adjusting nut in direction **b** to make the brake light come on later.

PERIODIC MAINTENANCE AND MINOR REPAIR

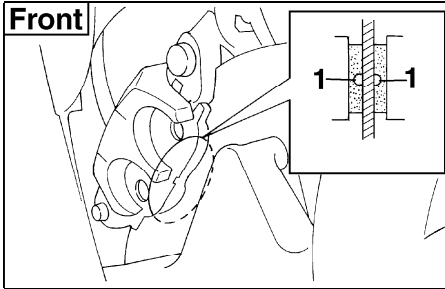

1. Wear indicator groove (× 2)

EAU00721

Checking the front and rear brake pads

Front brake

EAU00725

A wear indicator groove is provided on each brake pad. This indicator allows checking of brake pad wear without disassembling the brake. Inspect the groove. If the groove has almost disappeared, ask a Yamaha dealer to replace the pads.

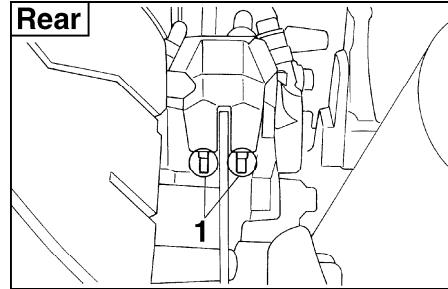

1. Wear indicator (× 2)

EAU00728

Rear brake

Apply the brake and inspect the wear indicator. If the wear indicator is ALMOST in contact with the disc plate, ask a Yamaha dealer to replace the pads.

PERIODIC MAINTENANCE AND MINOR REPAIR

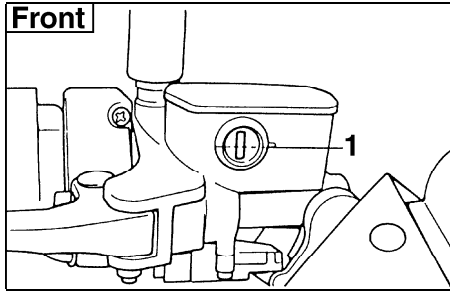

1. Minimum level mark

EAU00732

Inspecting the brake fluid level

Insufficient brake fluid may let air enter the brake system, possibly causing the brakes to become ineffective.

Before riding, check that the brake fluid is above the minimum level and fill when necessary.

Observe these precautions:

- When checking the fluid level, make sure the top of the master cylinder is level by turning the handlebars.

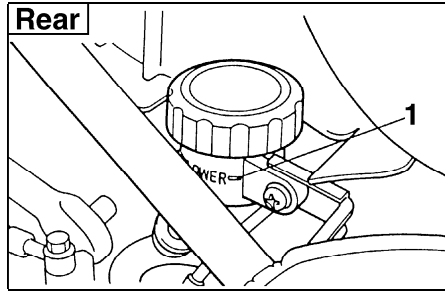

1. Minimum level mark

- Use only the designated quality brake fluid. Otherwise, the rubber seals may deteriorate, causing leakage and poor brake performance.

Recommended brake fluid: DOT 4

NOTE: _____
If DOT 4 is not available, DOT 3 can be used.

- Refill with the same type of brake fluid. Mixing fluids may result in a harmful chemical reaction and lead to poor brake performance.
- Be careful that water does not enter the master cylinder when refilling. Water will significantly lower the boiling point of the fluid and may result in vapor lock.
- Brake fluid may deteriorate painted surfaces or plastic parts. Always clean up spilled fluid immediately.
- Have a Yamaha dealer check the cause if the brake fluid level goes down.

PERIODIC MAINTENANCE AND MINOR REPAIR

EAU00742

Brake fluid replacement

The brake fluid should be replaced only by trained Yamaha service personnel. Have the Yamaha dealer replace the following components during periodic maintenance or when they are damaged or leaking:

- oil seals (every two years)
- brake hoses (every four years)

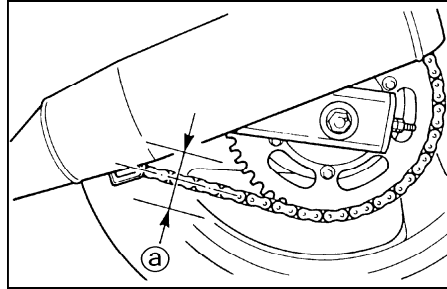

a. Chain slack

EAU00745

Drive chain slack check

NOTE: _____

Spin the wheel several times and find the tightest position of the chain. Check and/or adjust the chain slack while it's in this tightest position.

Inspect the drive chain when the motorcycle is on the centerstand. Check the slack at the position shown in the illustration. Normal slack is approximately 30 ~ 40 mm. If the slack exceeds 40 mm, adjust.

PERIODIC MAINTENANCE AND MINOR REPAIR

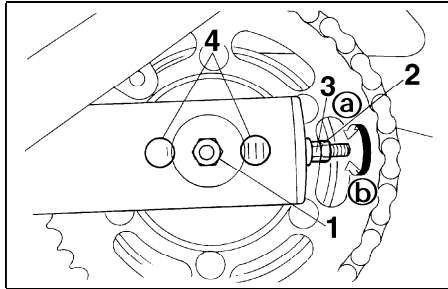

1. Axle nut
2. Locknut
3. Adjusting nut
4. Alignment marks

EAU00762

Drive chain slack adjustment

1. Loosen the axle nut.
2. Loosen the locknuts on each side. To tighten the chain, turn the chain adjusting nuts in direction (a). To loosen the chain, turn the adjusting nuts in direction (b) and push the wheel forward. Turn each adjusting nut exactly the same amount to maintain correct axle alignment. There are marks on

each side of the swingarm. Use these marks to align the rear wheel.

EC000096

CAUTION:

Too little chain slack will overload the engine and other vital parts. Keep the slack within the specified limits.

3. After adjusting, tighten the locknuts. Then tighten the axle nut to the specified torque.

Tightening torque:

Axle nut:
105 Nm (10.5 m·kg)

EAU00769

Drive chain lubrication

The chain consists of many parts which work with each other. If the chain is not maintained properly, it will wear out quickly. Therefore, the chain must be serviced regularly. This service is especially necessary when riding in dusty areas. This motorcycle is equipped with a sealed type chain. Steam cleaning, high-pressure washes, and solvents can damage chain so do not use these for cleaning it. Use only kerosene to clean the drive chain. Wipe it dry, and thoroughly lubricate it with SAE 30 ~ 50W motor oil. Do not use any other lubricants on the drive chain. They may contain solvents that could damage the sealed chain.

EC000097

CAUTION:

Be sure to oil the chain after washing the motorcycle or riding in the rain.

PERIODIC MAINTENANCE AND MINOR REPAIR

Cable inspection and lubrication

EAU02962

WARNING

Damage to the outer housing of cables may lead to internal rusting and interfere with the cable movement. Replace damaged cables as soon as possible to prevent unsafe conditions.

EW000112

Lubricate the cables and cable ends. If a cable does not operate smoothly, ask a Yamaha dealer to replace it.

Recommended lubricant:
Engine oil

Throttle cable and grip lubrication

EAU00773

The throttle twist grip assembly should be greased at the time that the cable is lubricated, since the grip must be removed to get at the end of the throttle cable. After removing the screws, hold the end of the cable up in the air and put in several drops of lubricant. With the throttle grip disassembled, coat the metal surface of the grip assembly with a suitable all-purpose grease.

Brake and shift pedal lubrication

EAU02984

Lubricate the pivoting parts.

Recommended lubricant:
Engine oil

PERIODIC MAINTENANCE AND MINOR REPAIR

Brake and clutch lever lubrication

EAU02985

Lubricate the pivoting parts.

Recommended lubricant:
Engine oil

Center and sidestand lubrication

EAU02965

Lubricate the pivoting and mating joints.

Check to see that the center and sidestand move up and down smoothly.

Recommended lubricant:
Engine oil

EW000114

WARNING

If the center and/or sidestand does not move smoothly, consult a Yamaha dealer.

Rear suspension lubrication

EAU00790

Lubricate the pivoting parts.

Recommended lubricant:
Molybdenum disulfide grease

PERIODIC MAINTENANCE AND MINOR REPAIR

Front fork inspection

Visual check

EAU02939

EW000115

⚠ WARNING

Securely support the motorcycle so there is no danger of it falling over.

Check for scratches or damage on the inner tube and excessive oil leakage from the front fork.

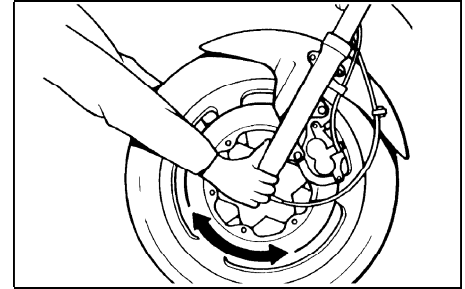
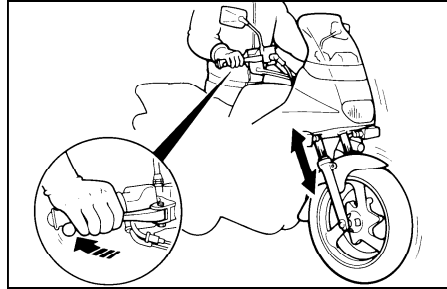

EAU00794

Operation check

1. Place the motorcycle on a level place.
2. Hold the motorcycle in an upright position and apply the front brake.
3. Push down hard on the handlebars several times and check if the fork rebounds smoothly.

EC000098

CAUTION:

If any damage or unsmooth movement is found with the front fork, consult a Yamaha dealer.

Steering inspection

Periodically inspect the condition of the steering. Worn out or loose steering bearings may be dangerous. Place a stand under the engine to raise the front wheel off the ground. Hold the lower end of the front forks and try to move them forward and backward. If any free play can be felt, ask a Yamaha dealer to inspect and adjust the steering. Inspection is easier if the front wheel is removed.

EW000115

⚠ WARNING

Securely support the motorcycle so there is no danger of it falling over.

PERIODIC MAINTENANCE AND MINOR REPAIR

Wheel bearings

If there is play in the front or rear wheel hub or if the wheel does not turn smoothly, have a Yamaha dealer inspect the wheel bearings.

EAU01144

Battery

This motorcycle is equipped with a sealed-type battery. Therefore it is not necessary to check the electrolyte or fill the battery with distilled water.

- If the battery seems to have discharged, consult a Yamaha dealer.
- If the motorcycle is equipped with optional electrical accessories, the battery tends to discharge more quickly, so be sure to recharge it periodically.

EAU00800

EC000101

CAUTION:

Never try to remove the sealing caps of the battery cells. The battery will be damaged.

WARNING

Battery electrolyte is poisonous and dangerous, causing severe burns, etc. It contains sulfuric acid. Avoid contact with skin, eyes or clothing.

ANTIDOTE:

- **EXTERNAL:** Flush with water.
- **INTERNAL:** Drink large quantities of water or milk. Follow with milk of magnesia, beaten egg, or vegetable oil. Call a physician immediately.
- **EYES:** Flush with water for 15 minutes and get prompt medical attention.

Batteries produce explosive gases. Keep sparks, flame, cigarettes etc., away. Ventilate when charging or using in an enclosed space. Always shield your eyes when working near batteries. KEEP OUT OF REACH OF CHILDREN.

EW000116

PERIODIC MAINTENANCE AND MINOR REPAIR

Battery storage

When the motorcycle is not used for a month or longer, remove the battery, fully charge it and store it in a cool, dry place.

EC000102

CAUTION:

- **Completely recharge the battery before storing. Storing a discharged battery can cause permanent battery damage.**
- **Use a battery charger designed for a sealed-type (MF) battery. Using a conventional battery charger will cause battery damage. If you do not have a sealed-type battery charger, contact your Yamaha dealer.**
- **Always make sure the connections are correct when reinstalling the battery.**

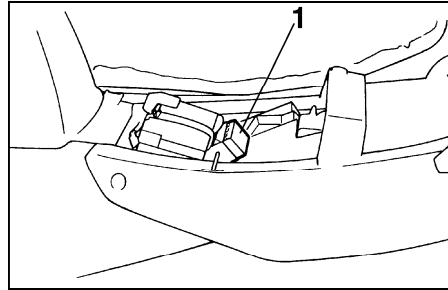

1. Fuse box

EAU01470

Fuse replacement

The fuse box is located under the seat. (See page 3-14 for seat removal and installation procedures.)

If any fuse is blown, turn off the main switch and the switch of the circuit in question. Install a new fuse of specified amperage. Turn on the switches and see if the electrical device operates. If the fuse immediately blows again, consult a Yamaha dealer.

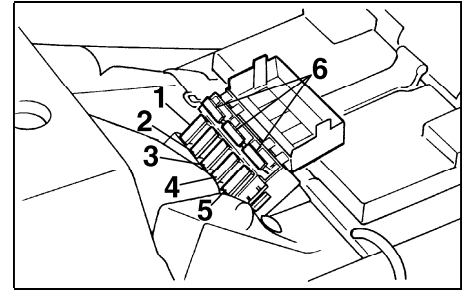

1. Main fuse
2. Ignition fuse
3. Signaling system fuse
4. Headlight fuse
5. Hazard light fuse
6. Spare fuse (x 3)

EC000103

CAUTION:

Do not use fuses of higher amperage rating than those recommended. Substitution of a fuse of improper rating can cause extensive electrical system damage and possibly a fire.

PERIODIC MAINTENANCE AND MINOR REPAIR

Specified fuses:

Main fuse:	30 A
Ignition fuse:	10 A
Signaling system fuse:	15 A
Headlight fuse:	15 A
Hazard light fuse:	10 A

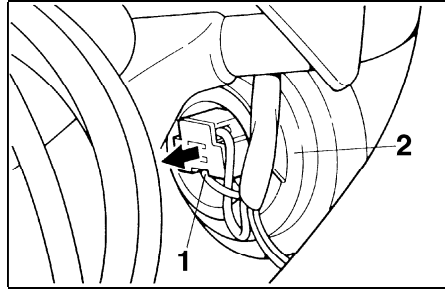

1. Connector
2. Bulb holder cover

EAU00829

Headlight bulb replacement (for XJ600S)

This motorcycle is equipped with a quartz bulb headlight. If a headlight bulb burns out, replace it as follows:

1. Remove the headlight connector and the bulb holder cover.

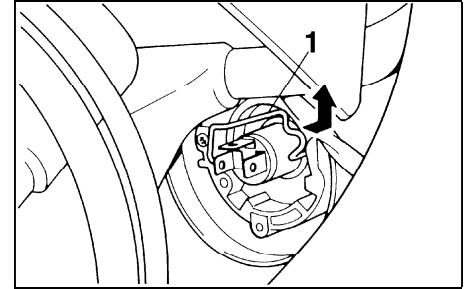

1. Bulb holder
2. Unhook the bulb holder and remove the defective bulb.

EW000119

WARNING

Keep flammable products and your hands away from a bulb while it is on, as it is hot. Do not touch a bulb until it cools down.

PERIODIC MAINTENANCE AND MINOR REPAIR

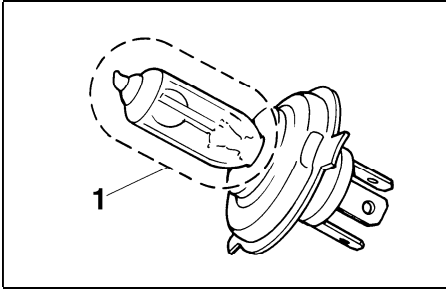

1. Don't touch

3. Put a new bulb into position and secure it in place with the bulb holder.

EC000105

CAUTION:

Avoid touching the glass part of a bulb. Keep it free from oil; otherwise, the transparency of the glass, life of the bulb, and luminous flux will be adversely affected. If oil gets on a bulb, thoroughly clean it with a cloth moistened with alcohol or lacquer thinner.

4. Install the bulb holder cover and the headlight connector.
If a headlight beam adjustment is necessary, ask a Yamaha dealer to make adjustment.

PERIODIC MAINTENANCE AND MINOR REPAIR

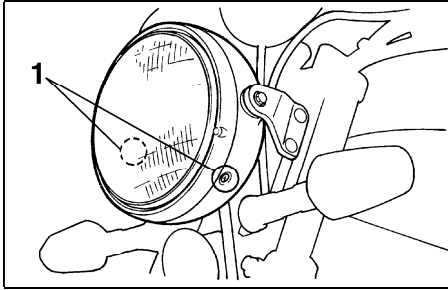

1. Screw (× 2)

EAU00833

Headlight bulb replacement (for XJ600N)

This motorcycle is equipped with a quartz bulb headlight.

If the headlight bulb burns out, replace the bulb as follows:

1. Remove the headlight unit screws.

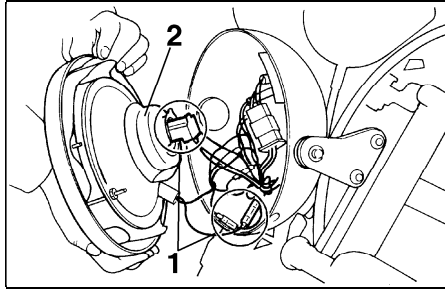

1. Connector (× 2)
 2. Bulb cover
2. Remove the connectors, the headlight unit and then the bulb cover.

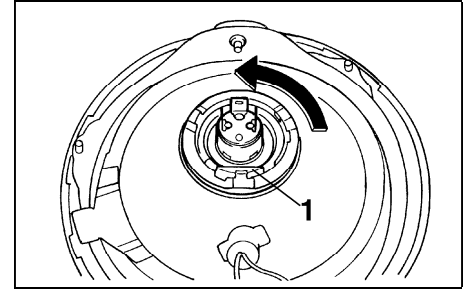

1. Bulb holder
3. Turn the bulb holder counterclockwise to remove it and remove the defective bulb.

EW000119

WARNING

Keep flammable products and your hands away from a bulb while it is on, as it is hot. Do not touch a bulb until it cools down.

PERIODIC MAINTENANCE AND MINOR REPAIR

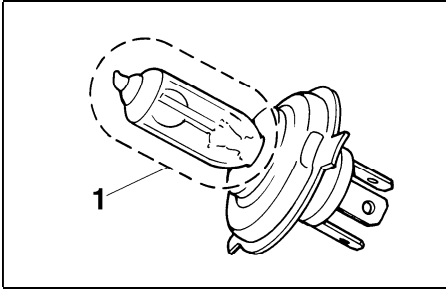

5. Install the bulb cover, connectors and headlight unit. Ask a Yamaha dealer to adjust the headlight beam if necessary.

1. Don't touch
4. Put a new bulb into position and secure it in place with the bulb holder.

EC000105

CAUTION:

Avoid touching the glass part of a bulb. Keep it free from oil; otherwise, the transparency of the glass, life of the bulb, and luminous flux will be adversely affected. If oil gets on a bulb, thoroughly clean it with a cloth moistened with alcohol or lacquer thinner.

PERIODIC MAINTENANCE AND MINOR REPAIR

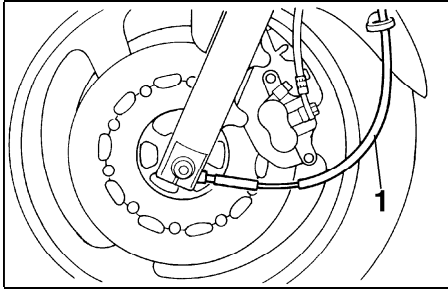

1. Speedometer cable

EAU00868

Front wheel removal

EW000122

⚠ WARNING

- It is advisable to have a Yamaha dealer service the wheel.
- Securely support the motorcycle so there is no danger of it falling over.

1. Place the motorcycle on the centerstand.
2. Remove the speedometer cable from the front wheel side.
3. Remove the calipers.

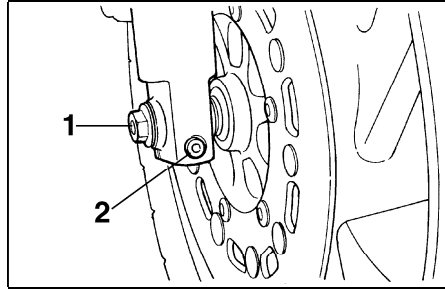

1. Wheel axle
2. Pinch bolt

NOTE: _____
Do not depress the brake lever when the disc and caliper are separated.

4. Loosen the pinch bolt.
5. Remove the wheel axle. Make sure the motorcycle is properly supported.

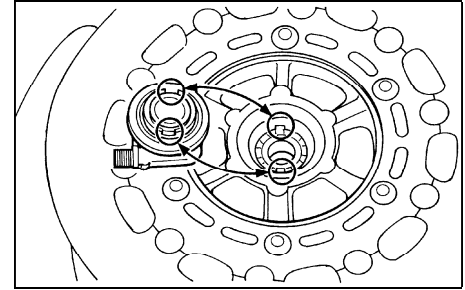

EAU01469

Front wheel installation

1. Install the speedometer gear unit into the wheel hub. Make sure the wheel hub and the speedometer gear unit are installed with the projections meshed into the slots.
2. Lift up the wheel between the front fork legs. Make sure the slot in the speedometer gear unit fits over the stopper on the front fork outer tube.

PERIODIC MAINTENANCE AND MINOR REPAIR

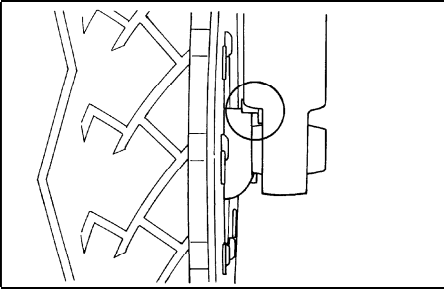

Tightening torque:

Wheel axle:

58 Nm (5.8 m·kg)

Pinch bolt:

40 Nm (4.0 m·kg)

Caliper bolt:

19 Nm (1.9 m·kg)

3. Install the wheel axle and let the motorcycle down.
4. Install the calipers and caliper bolts. Make sure there is enough gap between the brake pads before installing the calipers onto the brake discs.
5. Push down hard on the handlebars several times to check for proper fork operation.
6. Tighten the wheel axle, pinch bolt and caliper bolts to the specified torque.

7. Install the speedometer cable.

PERIODIC MAINTENANCE AND MINOR REPAIR

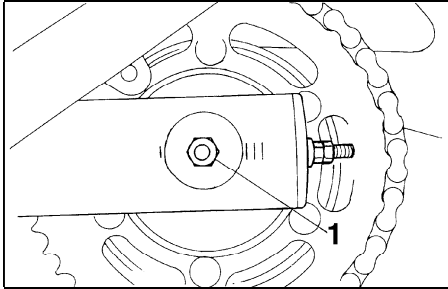

1. Axle nut

EAU01480

Rear wheel removal

EW000122

WARNING

- It is advisable to have a Yamaha dealer service the wheel.
- Securely support the motorcycle so there is no danger of it falling over.

1. Place the motorcycle on the centerstand.
2. Remove the axle nut.

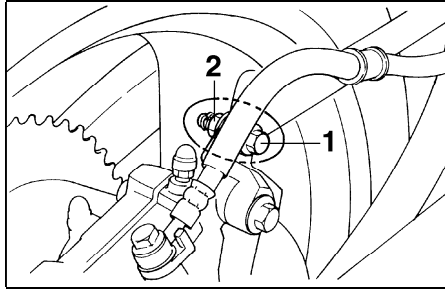

1. Brake torque rod bolt
2. Nut
3. Remove the brake torque rod bolt by removing the nut.

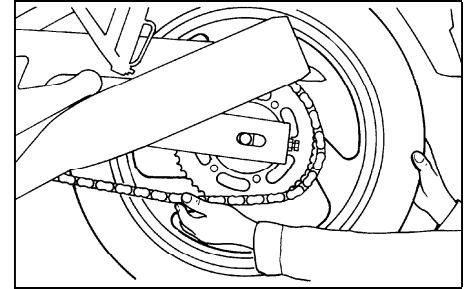

4. While supporting the brake caliper, pull out the wheel axle.
5. Push the wheel forward and remove the drive chain.
6. Remove the wheel assembly.

NOTE: _____

- Do not depress the brake pedal when the disc and caliper are separated.
- You do not have to disassemble the chain in order to remove or install the rear wheel.

EAU01468

EAU01008

Rear wheel installation

1. Install the wheel assembly and insert the axle.
2. Install and adjust the drive chain. (See page 6-20 for details about adjusting the drive chain slack.)
3. Install the axle nut.
4. Install the caliper and caliper bolts. Make sure there is enough gap between the brake pads before installing the caliper onto the brake disc.
5. Take the motorcycle off the centerstand.
6. Tighten the axle nut and brake torque rod bolt to the specified torques.

Tightening torque:

Axle nut:

105 Nm (10.5 m·kg)

Brake torque rod bolt:

23 Nm (2.3 m·kg)

Troubleshooting

Although Yamaha motorcycles receive a rigid inspection before shipment from the factory, trouble may occur during operation.

Any problem in the fuel, compression, or ignition systems can cause poor starting and loss of power. The troubleshooting chart describes a quick, easy procedure for making checks.

If your motorcycle requires any repair, bring it to a Yamaha dealer. The skilled technicians at a Yamaha dealership have the tools, experience, and know-how to properly service your motorcycle. Use only genuine Yamaha parts on your motorcycle. Imitation parts may look like Yamaha parts, but they are often inferior. Consequently, they have a shorter service life and can lead to expensive repair bills.

PERIODIC MAINTENANCE AND MINOR REPAIR

EAU01297

Troubleshooting chart

EW000125

WARNING

Never check the fuel system while smoking or in the vicinity of an open flame.

1. Fuel

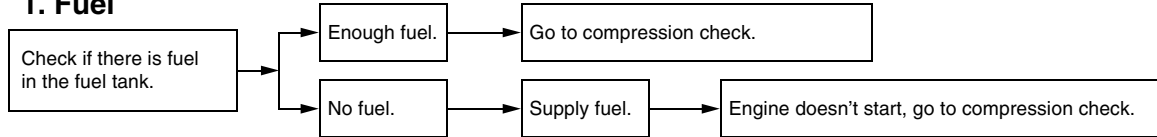

2. Compression

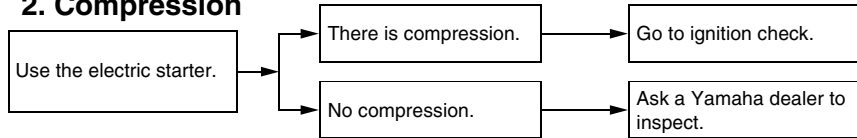

3. Ignition

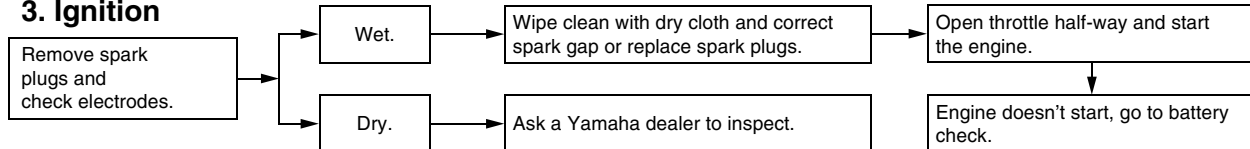

4. Battery

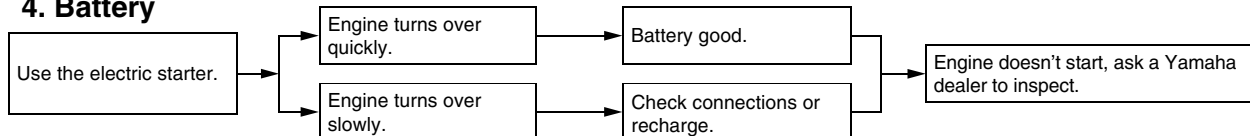

MOTORCYCLE CARE AND STORAGE

Care	7-1
Storage.....	7-4

Care

The exposure of its technology makes a motorcycle charming but also vulnerable. Although high-quality components are used, they are not all rust-resistant. While a rusty exhaust pipe may remain unnoticed on a car, it does look unattractive on a motorcycle. Frequent and proper care, however, will keep your motorcycle looking good, extend its life and maintain its performance. Moreover, the warranty states that the vehicle must be properly taken care of. For all these reasons, it is recommended that you observe the following cleaning and storing precautions.

Before cleaning

1. Cover up the muffler outlets with plastic bags.
2. Make sure that all caps and covers as well as all electrical couplers and connectors, including the spark plug caps, are tightly installed.
3. Remove extremely stubborn dirt, like oil burnt onto the crankcase, with a degreasing agent and a brush, but never apply such products onto seals, gaskets, sprockets, the drive chain and wheel axles. Always rinse the dirt and degreaser off with water.

Cleaning

After normal use

Remove dirt with warm water, a neutral detergent and a soft clean sponge, then rinse with plenty of clean water. Use a tooth or bottle brush for hard-to-reach parts. Tougher dirt and insects will come off more easily if the area is covered with a wet cloth for a few minutes before cleaning.

MOTORCYCLE CARE AND STORAGE

ECA00010

CAUTION: _____

- Avoid using strong acidic wheel cleaners, especially on spoked wheels. If you do use such products for hard-to-remove dirt, do not leave it on any longer than instructed, then thoroughly rinse it off with water, immediately dry the area and apply a corrosion protection spray.
- Improper cleaning can damage windshields, cowlings, panels and other plastic parts. Use only a soft, clean cloth or sponge with mild detergent and water to clean plastic.
- Do not use any harsh chemical products on plastic parts. Be sure to avoid using cloths or sponges which have been in contact with strong or abrasive cleaning products, solvent or thinner, fuel (gasoline), rust removers or inhibitors, brake fluid, antifreeze or electrolyte.
- Do not use high-pressure washers or steam-jet cleaners since they cause water seepage and deterioration in the following areas: seals (of wheel bearings, swingarm bearings, forks and brakes), electric components (couplers, connectors, instruments, switches and lights), breather hoses and vents.
- For motorcycles equipped with a windshield: Do not use strong cleaners or hard sponges as they will cause dulling or scratching. Some cleaning compounds for plastic may leave scratches on the windshield. Test the product on a small hidden part of the windshield to make sure they do not leave any marks. If the windshield is scratched, use a quality plastic polishing compound after washing.

After riding in the rain, near the sea or on salt-sprayed roads

Since sea salt or salt sprayed on the roads in the winter are extremely corrosive in combination with water, carry out the following steps after each ride in the rain, near the sea or on salt-sprayed roads. (Salt sprayed in the winter may remain on the roads well into spring.)

MOTORCYCLE CARE AND STORAGE

EWA00001

1. Clean your motorcycle with cold water and soap after the engine has cooled down.

ECA00012

CAUTION:

Do not use warm water since it increases the corrosive action of the salt.

2. Be sure to apply a corrosion protection spray on all (even chrome- and nickel-plated) metal surfaces to prevent corrosion.

After cleaning

1. Dry the motorcycle with a chamois or an absorbing cloth.
2. Immediately dry the drive chain and lubricate it to prevent it from rusting.
3. Use a chrome polish to shine chrome, aluminum and stainless-steel parts, including the exhaust system. (Even the thermally induced discoloring of stainless-steel exhaust systems can be removed through polishing.)
4. To prevent corrosion, it is recommended to apply a corrosion protection spray on all (even chrome- and nickel-plated) metal surfaces.
5. Use spray oil as a universal cleaner to remove any remaining dirt.
6. Touch up minor paint damage caused by stones, etc.
7. Wax all painted surfaces.
8. Let the motorcycle dry completely before storing it or covering it.

WARNING

Make sure that there is no oil or wax on the brakes and tires. If necessary, clean the brake discs and linings with a regular brake disc cleaner or acetone, and wash the tires with warm water and mild soap. Then, carefully test the motorcycle for its braking performance and cornering behavior.

MOTORCYCLE CARE AND STORAGE

ECA00013

CAUTION:

- **Apply spray oil and wax sparingly and wipe off any excess.**
- **Never apply oil or wax on rubber and plastic parts, but treat them with a suitable care product.**
- **Avoid using abrasive polishing compounds as they wear away the paint.**

NOTE:

Consult a Yamaha dealer for advice on what products to use.

Storage

Short-term

Always store your motorcycle in a cool, dry place and, if necessary, protect it against dust with a porous cover.

ECA00014

CAUTION:

- **Storing the motorcycle in a poorly ventilated room or covering it with a tarp while it is still wet will allow water and humidity to seep in and cause rust.**
- **To prevent corrosion, avoid damp cellars, stables (because of the presence of ammonia) and areas where strong chemicals are stored.**

Long-term

Before storing your motorcycle for several months:

1. Follow all the instructions in the “Care” section of this chapter.
2. Drain the carburetor float chambers by loosening the drain bolts; this will prevent fuel deposits from building up. Pour the drained fuel into the fuel tank.
3. Only for motorcycles equipped with a fuel cock which has an “OFF” position: Turn the fuel cock to “OFF”.
4. Fill up the fuel tank and add fuel stabilizer (if available) to prevent the fuel tank from rusting and the fuel from deteriorating.
5. Perform the following steps to protect the cylinders, piston rings, etc. from corrosion.
 - a. Remove the spark plug caps and spark plugs.
 - b. Pour a teaspoonful of engine oil into each spark plug bore.

MOTORCYCLE CARE AND STORAGE

- c. Install the spark plug caps onto the spark plugs and place the spark plugs on the cylinder head so that the electrodes are grounded. (This will limit sparking during the next step.)
 - d. Turn the engine over several times with the starter. (This will coat the cylinder walls with oil.)
 - e. Remove the spark plug caps from the spark plugs, install the spark plugs and then the spark plug caps.
- 7. Check and, if necessary, correct the tire air pressure, then raise the motorcycle so that both of its wheels are off the ground. Alternatively, turn the wheels a little every month in order to prevent the tires from becoming degraded in one spot.
 - 8. Cover up the muffler outlets with plastic bags to prevent moisture from entering.
 - 9. Remove the battery and fully charge it. Store it in a cool, dry place and recharge it once a month. Do not store the battery in an excessively cold or warm place (less than 0°C or more than 30°C). For more information, see “Battery storage” in the chapter “PERIODIC MAINTENANCE AND MINOR REPAIRS”.

EWA00003

WARNING

When turning the engine over, be sure to ground the spark plug electrodes to prevent damage or injury from sparking.

- 6. Lubricate all control cables and the pivoting points of all levers and pedals as well as of the side-stand/centerstand.

NOTE: _____
Make any necessary repairs before storing the motorcycle.

Specifications 8-1
HOW TO USE THE CONVERSION TABLE 8-5

Specifications

Model	XJ600S / XJ600N
Dimensions	
Overall length	2,170 mm
Overall width	735 mm
Overall height	
XJ600S	1,205 mm
XJ600N	1,090 mm
Seat height	770 mm
Wheelbase	1,445 mm
Ground clearance	150 mm
Minimum turning radius	2,700 mm
Basic weight (with oil and full fuel tank)	
XJ600S	213 kg
XJ600N	210 kg
Engine	
Engine type	Air-cooled 4-stroke, DOHC
Cylinder arrangement	Forward-inclined parallel 4-cylinder
Displacement	598 cm ³
Bore × Stroke	58.5 × 55.7 mm
Compression ratio	10:1
Starting system	Electric starter
Lubrication system	Wet sump

Engine oil

Type

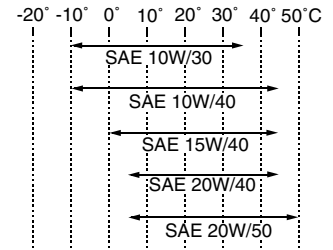

Recommended engine oil classification

API Service SE, SF, SG type or higher

CAUTION:

Be sure to use motor oils that do not contain anti-friction modifiers. Passenger car motor oils (often labeled "Energy Conserving") contain anti-friction additives which will cause clutch and/or starter clutch slippage, resulting in reduced component life and poor engine performance.

Quantity

Periodic oil change	2.3 L
With oil filter replacement	2.6 L
Total amount	3.1 L

SPECIFICATIONS

Air filter	Dry type element
Fuel	
Type	Regular unleaded gasoline
Fuel tank capacity	17.0 L
Reserve amount	3.5 L
Carburetor	
Type×quantity	BDS28 × 4
Manufacturer	MIKUNI
Spark plug	
Type/Manufacturer	CR8E / NGK U24ESR-N / DENSO
Gap	0.7 ~ 0.8 mm
Clutch type	Wet, multiple-disc
Transmission	
Primary reduction system	Spur gear
Primary reduction ratio	2.225
Secondary reduction system	Chain drive
Secondary reduction ratio	3.000 (except for CH, A) 2.875 (for CH, A)
Number of drive chain sprocket teeth (rear/front)	48/16 (except for CH, A) 46/16 (for CH, A)
Transmission type	Constant mesh 6-speed

Operation	Left foot operation	
Gear ratio		
	1st	2.733
	2nd	1.778
	3rd	1.333
	4th	1.074
	5th	0.913
	6th	0.821

Chassis

Frame type	Double cradle
Caster angle	25°
Trail	97 mm

Tire

Front	
Type	Tubeless
Size	110 / 80-17 57H
Manufacturer/model	MICHELIN / MACADAM 50 DUNLOP / D103FA
Rear	
Type	Tubeless
Size	130 / 70-18 63H
Manufacturer/model	MICHELIN / MACADAM 50 DUNLOP / D103A

SPECIFICATIONS

Maximum load*

XJ600S 184 kg

XJ600N 187 kg

Air pressure (cold tire)

Up to 90 kg load*

Front 200 kPa (2.00 kg/cm², 2.00 bar)

Rear 225 kPa (2.25 kg/cm², 2.25 bar)

90 kg load ~ maximum load*

Front 200 kPa (2.00 kg/cm², 2.00 bar)

Rear 250 kPa (2.50 kg/cm², 2.50 bar)

High speed riding

Front 200 kPa (2.00 kg/cm², 2.00 bar)

Rear 250 kPa (2.50 kg/cm², 2.50 bar)

* Load is total weight of cargo, rider, passenger and accessories.

Wheels

Front

Type Cast

Size 17 × MT 2.50

Rear

Type Cast

Size 18 × MT 3.50

Brakes

Front

Type Dual disc brake

Operation Right hand operation

Fluid DOT 4 or DOT 3

Rear

Type Single disc brake

Operation Right foot operation

Fluid DOT 4 or DOT 3

Suspension

Front

Type Telescopic fork

Rear

Type Swingarm (monocross suspension)

Shock absorbers

Front

Coil spring/oil damper

Rear

Coil spring/gas-oil damper

Wheel travel

Front

140 mm

Rear

110 mm

Electrical systems

Ignition system

T.C.I. (digital)

Charging system	
Type	A.C. magneto
Standard output	14 V, 20 A @ 5,000 r/min
Battery	
Type	YTX9-BS, GTX9-BS
Voltage, capacity	12 V, 8 AH
Headlight type	Quartz bulb (halogen)
Bulb voltage, wattage × quantity	
Headlight	12 V, 60/55 W × 1
Auxiliary light	12 V, 4 W × 1 (except for GB, IRL)
	12 V, 3.4 W × 1 (for GB, IRL)
Tail/brake light	12 V, 5/21 W × 1
Turn signal light	12 V, 21 W × 4
Meter light	
XJ600S	12 V, 1.7 W × 3
XJ600N	14 V, 3 W × 2
	12 V, 1.7 W × 2
Neutral indicator light	12 V, 3.4 W × 1
High beam indicator light	12 V, 3.4 W × 1
Oil level indicator light	
XJ600S	12 V, 3.4 W × 1
XJ600N	14 V, 3 W × 1
Turn indicator light	12 V, 3.4 W × 2

Fuses

Main fuse	30 A
Ignition fuse	10 A
Signaling system fuse	15 A
Headlight fuse	15 A
Hazard light fuse	10 A

SPECIFICATIONS

EAU01064

HOW TO USE THE CONVERSION TABLE

All specification data in this manual are listed in SI and METRIC UNITS.

Use this table to convert METRIC unit data to IMPERIAL unit data.

Ex.

METRIC		MULTIPLIER		IMPERIAL
**mm	×	0.03937	=	**in
2 mm	×	0.03937	=	0.08 in

CONVERSION TABLE

METRIC TO IMPERIAL			
	Metric unit	Multiplier	Imperial unit
Torque	m·kg	7.233	ft·lb
	m·kg	86.794	in·lb
	cm·kg	0.0723	ft·lb
	cm·kg	0.8679	in·lb
Weight	kg	2.205	lb
	g	0.03527	oz
Speed	km/hr	0.6214	mph
Distance	km	0.6214	mi
	m	3.281	ft
	m	1.094	yd
	cm	0.3937	in
	mm	0.03937	in
Volume / Capacity	cc (cm ³)	0.03527	oz (IMP liq.)
	cc (cm ³)	0.06102	cu-in
	lt (liter)	0.8799	qt (IMP liq.)
	lt (liter)	0.2199	gal (IMP liq.)
Misc.	kg/mm	55.997	lb/in
	kg/cm ²	14.2234	psi (lb/in ²)
	Centigrade (°C)	9/5 + 32	Fahrenheit (°F)

Identification number records.....	9-1
Key identification number (for XJ600S).....	9-1
Key identification number (for XJ600N)	9-1
Vehicle identification number	9-2
Model label.....	9-2

Identification number records

EAU02944

Record the key identification number, vehicle identification number and model label information in the spaces provided for assistance when ordering spare parts from a Yamaha dealer or for reference in case the vehicle is stolen.

1. KEY IDENTIFICATION NUMBER:

2. VEHICLE IDENTIFICATION NUMBER:

3. MODEL LABEL INFORMATION:

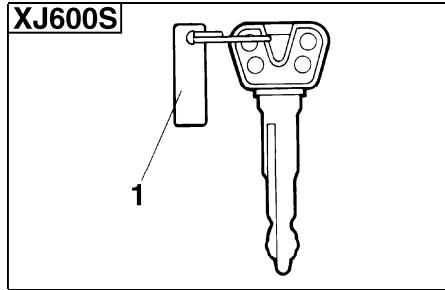

1. Key identification number

EAU01041

Key identification number (for XJ600S)

The key identification number is stamped on the key tag. Record this number in the space provided and use it for reference when obtaining a new key.

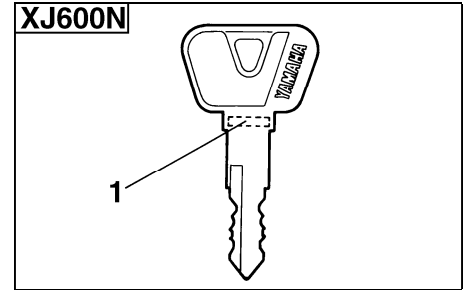

1. Key identification number

EAU01042

Key identification number (for XJ600N)

The key identification number is stamped on the key. Record this number in the space provided and use it for reference when obtaining a new key.

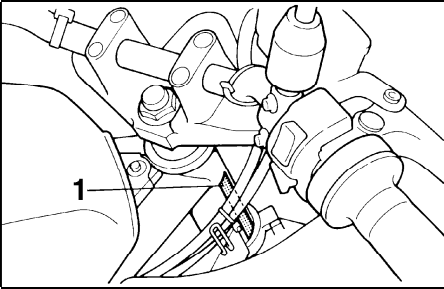

1. Vehicle identification number

EAU01043

Vehicle identification number

The vehicle identification number is stamped into the steering head pipe. Record this number in the space provided.

NOTE: _____

The vehicle identification number is used to identify your motorcycle and may be used to register your motorcycle with the licensing authority in your state.

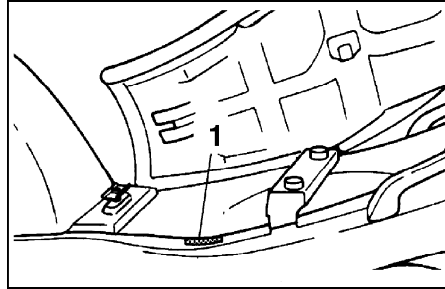

1. Model label

EAU01050

Model label

The model label is affixed to the frame under the seat. (See page 3-14 for seat removal procedures.) Record the information on this label in the space provided. This information will be needed to order spare parts from your Yamaha dealer.

INDEX

A

Air filter6-10

B

Battery6-25

Brake and clutch lever lubrication6-23

Brake and shift pedal lubrication6-22

Brake fluid replacement6-20

Brake light switch adjustment6-17

C

Cable inspection and lubrication6-22

Carburetor adjustment6-11

Care7-1

Center and sidestand lubrication6-23

Checking the front and rear brake pads6-18

Clutch lever3-9

Clutch lever free play adjustment6-15

Controls/Instruments (XJ600N)2-6

Controls/Instruments (XJ600S)2-3

D

Dimmer switch3-7

Drive chain lubrication6-21

Drive chain slack adjustment6-21

Drive chain slack check6-20

E

Engine break-in5-5

Engine oil6-7

Engine stop switch3-9

F

Front brake lever3-10

Front fork inspection6-24

Front wheel installation6-31

Front wheel removal6-31

Fuel3-12

Fuel cock3-13

Fuel tank breather hose
(for Germany only)3-12

Fuel tank cap3-11

Fuse replacement6-26

G

Give safety the right of way1-1

H

Handlebar switches3-7

Dimmer switch3-7

Engine stop switch3-9

Hazard switch3-8

Horn switch3-8

Lights switch3-9

Pass switch3-7

Start switch3-9

Turn signal switch3-8

Hazard switch3-8

Headlight bulb replacement
(for XJ600N)6-29

Headlight bulb replacement
(for XJ600S)6-27

Helmet holders3-15

High beam indicator light3-3

Horn switch3-8

I

Identification number records9-1

Idle speed adjustment6-12

Indicator lights3-3

High beam indicator light3-3

Neutral indicator light3-3

Oil level indicator light3-3

Turn indicator lights3-3

Inspecting the brake fluid level6-19

K

Key identification number
(for XJ600N)9-1

Key identification number
(for XJ600S)9-1

L

Left view (XJ600N)2-4

Left view (XJ600S)2-1

Lights switch3-9

Luggage strap holders3-16

M

Main switch3-1

Model label9-2

N

Neutral indicator light3-3

O

- Oil level indicator circuit check 3-5
- Oil level indicator light 3-3

P

- Panel A 6-5
- Panel removal and installation 6-5
- Parking 5-6
- Pass switch 3-7
- Periodic maintenance and lubrication 6-2
- Pre-operation check list 4-1

R

- Rear brake pedal 3-11
- Rear brake pedal height adjustment 6-17
- Rear shock absorber adjustment 3-15
- Rear suspension lubrication 6-23
- Rear wheel installation 6-34
- Rear wheel removal 6-33
- Recommended shift points
(for Switzerland only) 5-5
- Right view (XJ600N) 2-5
- Right view (XJ600S) 2-2

S

- Seat 3-14
- Shift pedal 3-10
- Shifting 5-4
- Sidestand 3-17
- Sidestand/clutch switch operation
check 3-17

- Spark plug inspection 6-6
- Specifications 8-1
- Speedometer (for XJ600N) 3-6
- Speedometer (for XJ600S) 3-6
- Start switch 3-9
- Starter (choke) “| \ |” 3-14
- Starting a warm engine 5-4
- Starting the engine 5-1
- Steering inspection 6-24
- Steering lock (for XJ600N) 3-3
- Storage 7-4
- Storage compartment 3-15

T

- Tachometer 3-7
- Throttle cable and grip lubrication 6-22
- Throttle cable free play inspection 6-12
- Tips for reducing fuel consumption 5-5
- Tires 6-13
- Tool kit 6-1
- Troubleshooting 6-34
- Troubleshooting chart 6-35
- Turn indicator lights 3-3
- Turn signal switch 3-8

V

- Valve clearance adjustment 6-13
- Vehicle identification number 9-2

W

- Wheel bearings 6-25
- Wheels 6-15



PRINTED ON RECYCLED PAPER

PRINTED IN JAPAN
99 · 4 - 0.3 × 1 CR
(E)