

4L80E HD SHIFT RECALIBRATION KIT
PART # 4L80ECC/HDSRK

Kit Contents:

- 1 Purple Pressure Regulator Spring**
- 1 Orange Pressure Regulator Spring**
- 1 .375" Cup Plug**
- 1 Separator Plate**
- 1 Upper Valve Body Gasket**
- 1 Lower valve Body Gasket**
- 1 Accumulator Delete Plate**
- 6 Accumulator Delete Plate Mounting Bolts**

NOTE: THIS KIT MAY BE INSTALLED WITHOUT PERFORMING THE INTERNAL MODIFICATIONS HOWEVER IT IS RECOMMENDED THAT ALL MODIFICATIONS BE PERFORMED, IF THE TRANSMISSION IS OUT OF THE VEHICLE, ESPECIALLY THE RELIEF OF THE SEAL DRAINBACK HOLE TO ELIMINATE SEAL BLOWOUT.

Pressure Regulator Modifications

Two pressure regulator springs are supplied in this kit. The purpose of the springs is to increase hydraulic system pressure at all throttle positions so that maximum clutch capacity may be obtained. The violet spring will furnish approximately 185-190 psi maximum hydraulic system pressure, and its use is recommended for engines producing up to 600 foot pounds of torque. The orange spring will furnish approximately 215-220 psi maximum hydraulic system pressure, and its use is recommended for engines producing over 600 foot pounds of torque. Select the appropriate pressure regulator spring based on the intended application. Remove and replace the OEM pressure regulator spring with the selected replacement. See Figure 1.

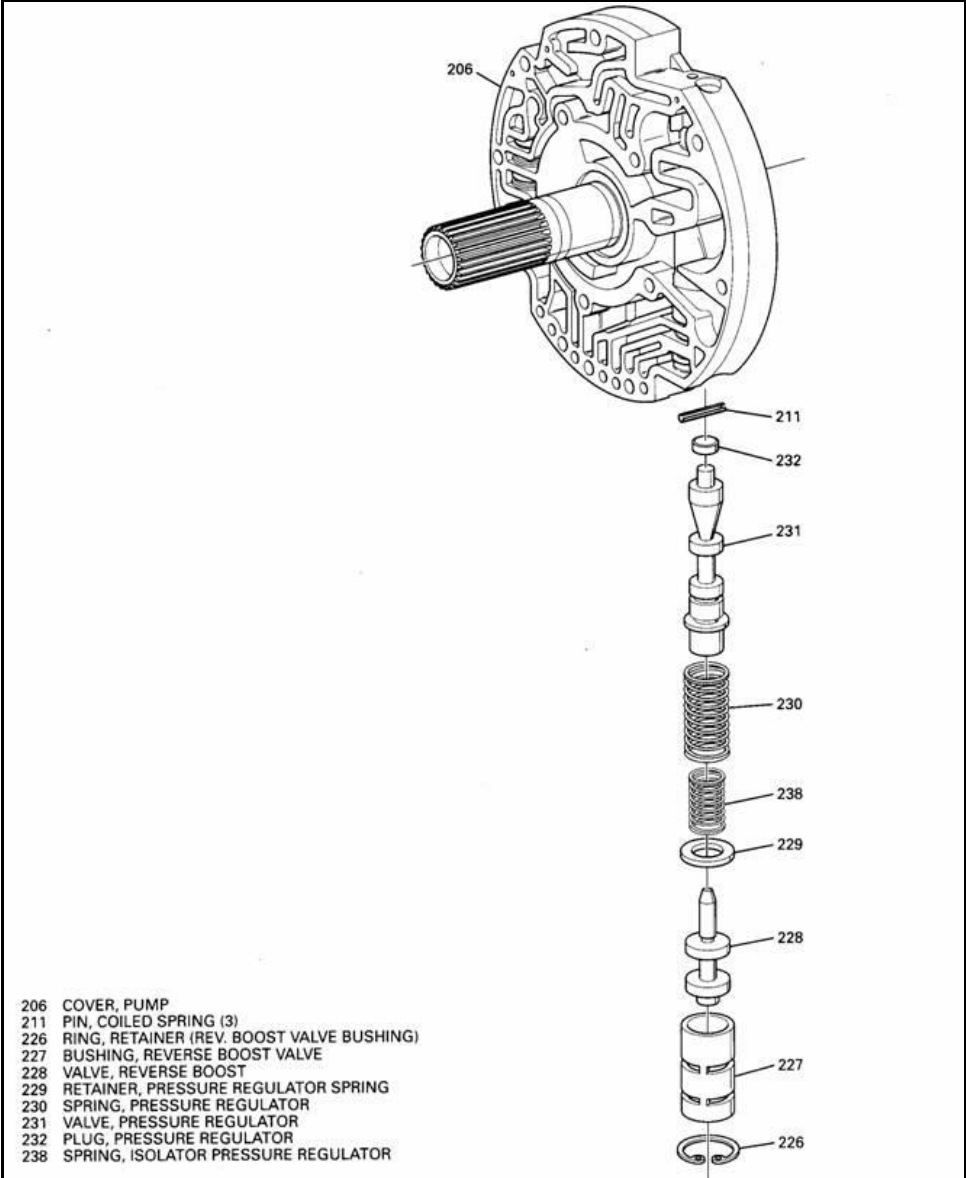

FIGURE 1

Valve Body and Separator Plate Upgrade

Drill out second, third, and fourth gear feed holes to the recommended size for the desired shift firmness. For stock type shifts, leave plate as is. For firm shifts drill holes from .090" to .100". For competition usage, drill holes from .115" to .120". Drill the plate as instructed in the Figure 2.

Replace the OEM accumulator housing and related components with the supplied accumulator delete plate and mounting hardware. No gasket is necessary between the delete plate and separator plate. Torque the mounting bolts to 130 inch pounds.

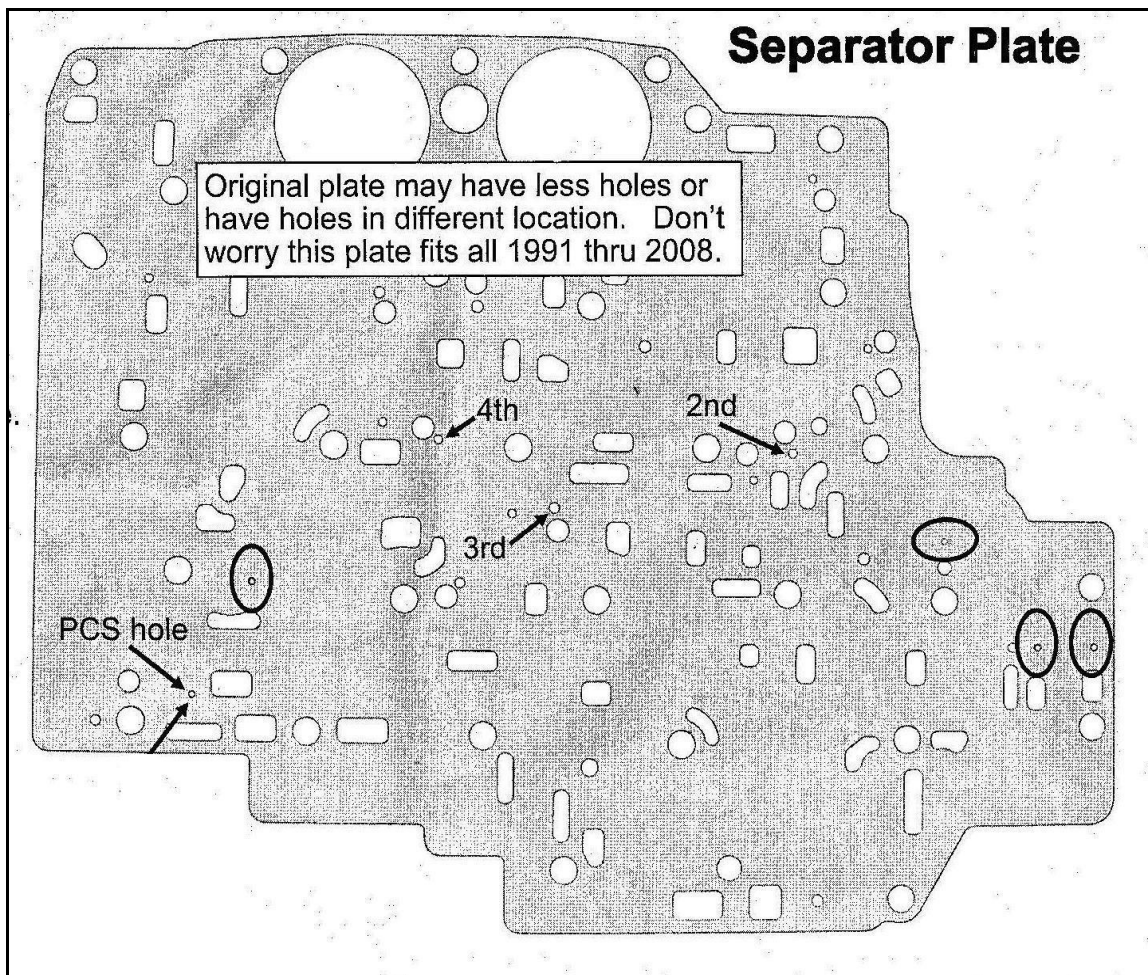

FIGURE 2

Reinstall all checkballs into the transmission case with the exception of the #5 and #6 checkballs. The #5 and #6 checkballs are nonfunctional once the accumulator delete plate has been fit to the valve body. See Figure 3.

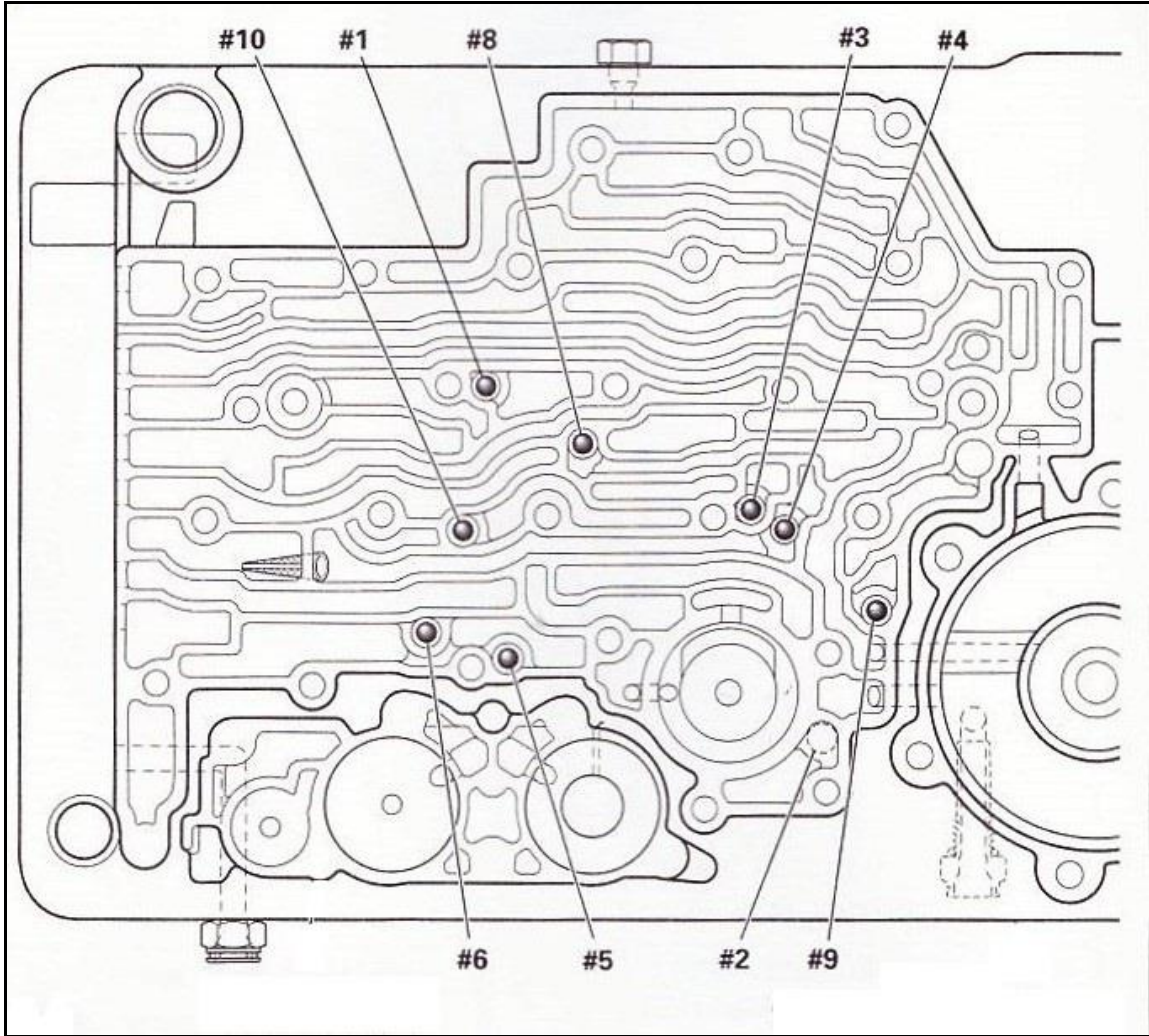

FIGURE 3

Additional Modifications If Transmission Is Out Of Vehicle

Drill a .055" to .067" hole between the line pressure and converter charge passages in the pump cover as shown in Figure 4. Center punch hole as a guide for the drill bit. This modification will provide the torque converter with charge oil regardless of pressure regulator valve position. Increased line pressure results in increased internal torque converter oil pressure and volume. This results in an increase in converter drain back oil pressure and volume. The diameter of the seal drain back hole in the pump cover is too small to effectively exhaust this increase in pressure and volume. This will result in front seal blow out. To eliminate seal blowout, enlarge the seal drain back hole in the pump cover with a .250" drill. This will provide adequate exhaust flow. See Figure 5.

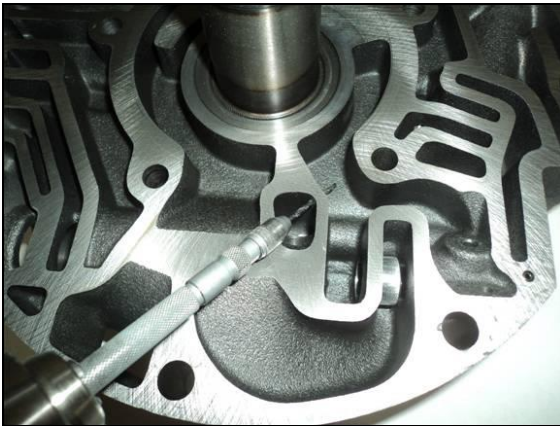

FIGURE 4



FIGURE 5

Lubrication Upgrades

Lube oil to the overdrive section of the transmission is supplied thru the feed passage at the rear of the stator support shown in Figure 6. To increase the volume of lube oil delivered to the overdrive section start by enlarging the feed passage with a .125" drill bit. Be sure to drill at a 45 degree angle to maximize oil flow.



FIGURE 6

Use the drill to enlarge the feed passage in the overrun clutch housing as well. See Figure 7. The installation of an OEM 4L80E fluted sun gear shaft bushing into the overrun clutch housing is highly recommended. See Figure 8. The flutes will channel a steady supply of lube oil directly to the overdrive planetary gearset.



FIGURE 7



FIGURE 8

Lube oil to the intermediate sprag and intermediate clutch assembly is supplied thru the feed passage in the center support shown in Figure 9. 1997 and up center lube models received a revised casting which included the reduction of this passage down to .067". This reduces the volume of lube oil delivered to these components, raising durability concerns in high load applications. To increase the volume of lube oil delivered to these components, enlarge the feed passage with a .125" drill bit. Be sure to deburr the inside diameter of the bushing after drilling. Always verify the cooler return passage in the support is free of debris and or obstructions by blowing it out with compressed air. See Figure 10.

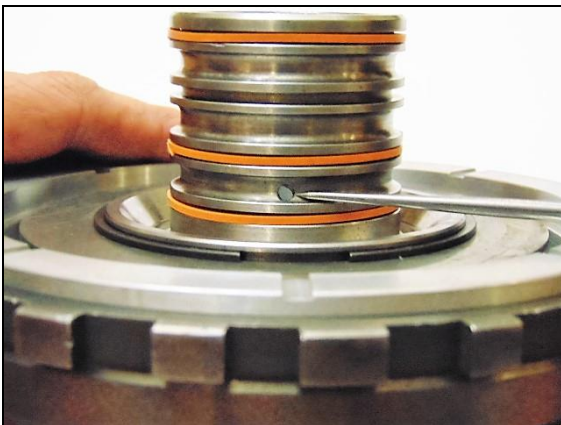

FIGURE 9

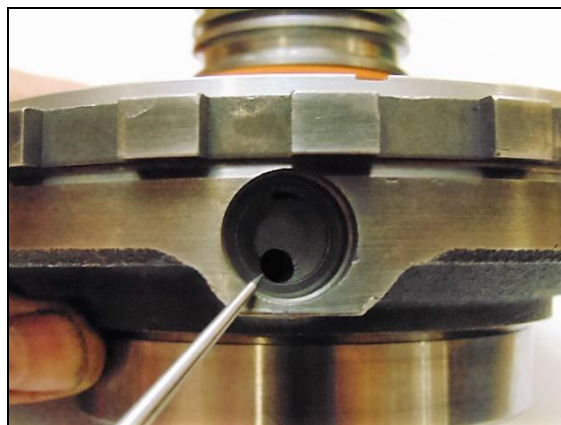

FIGURE 10

Dual Feed Direct Clutch Modification

Dual feeding the direct clutch allows both the inner and outer areas of the direct clutch piston to be exposed to direct clutch apply pressure, instead of just the smaller inner area. This roughly triples the clamping force used to apply and hold the direct pack assembly. To dual feed the direct clutch remove the center lip seal from the direct clutch housing and the second oil seal ring from the top of the sealing ring boss on the center support. See Figures 11 and 12.

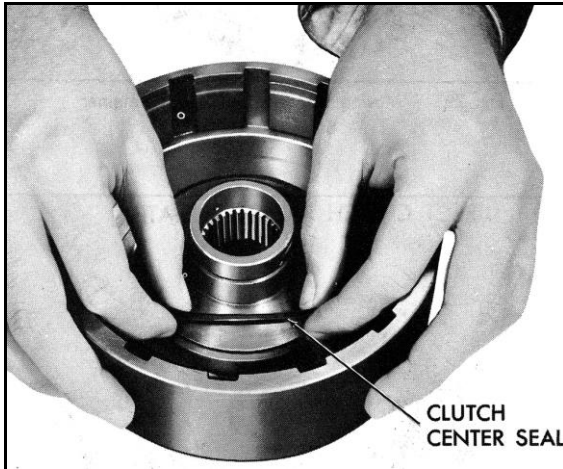

FIGURE 11



FIGURE 12

After the center support has been installed in the case, install the supplied .375" cup plug into the case at the location shown in Figure 13. Be sure the cup plug is seated against the center support.



FIGURE 13