

# 5-STAGE REVERSE OSMOSIS WATER PURIFICATION SYSTEM

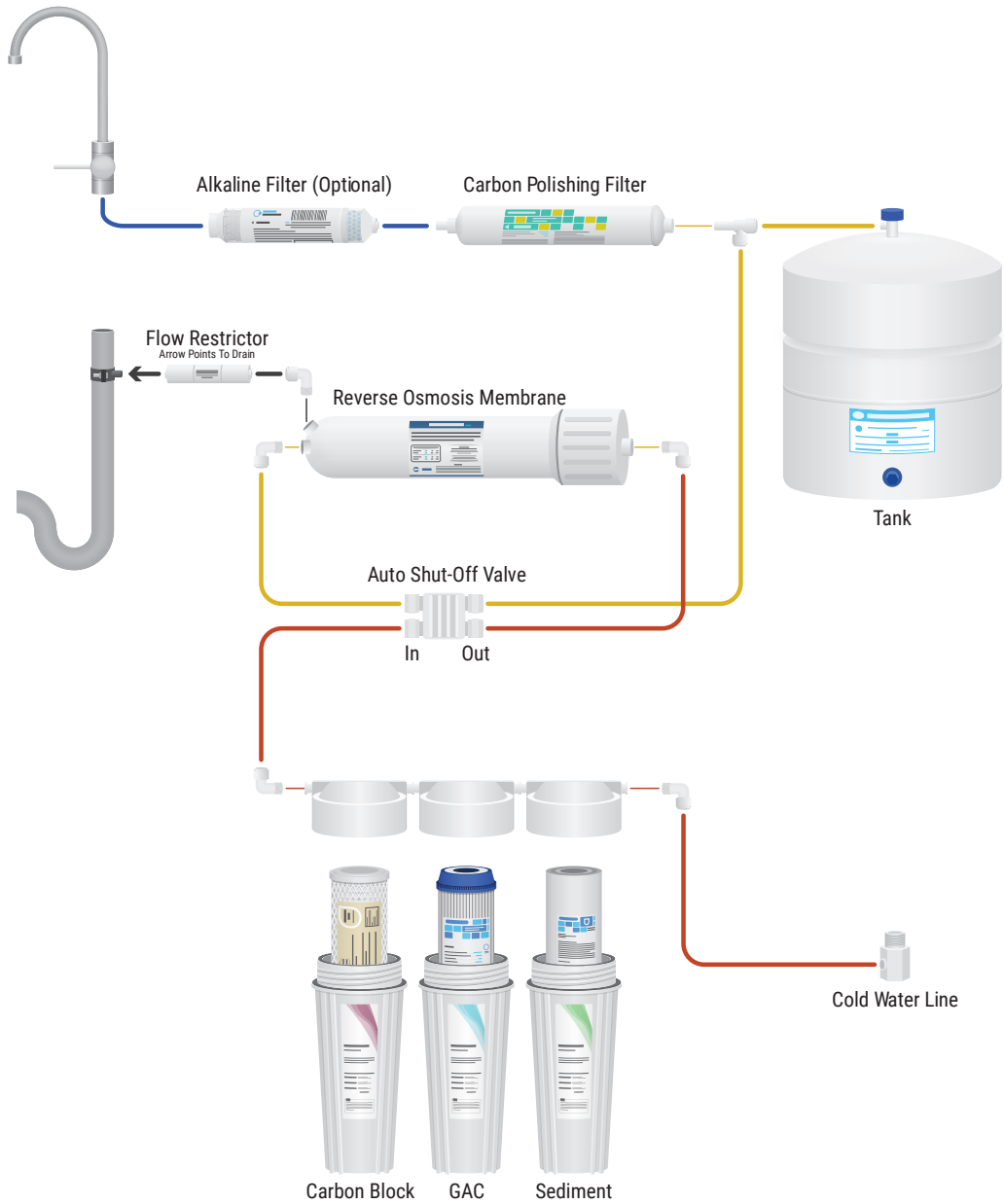

NAPLES  
NATURALS

# NAPLES NATURAL REVERSE OSMOSIS WATER SYSTEM DIAGRAM



## STEP 1: ASSEMBLING THE FILTER-STRUCTURE

Your Filter Housing should have arrived pre-assembled, and look like this. If that is the case, please skip to Step 2. If your Filter Housing Structure is not pre-assembled, continue on.



### Assembling the Main Housing

Place the Sediment Filter, the GAC Filter, and the Carbon Block filter into their respective containers.

With the Naples Naturally logo visible on the housing assembly, screw in the Sediment Filter container on the right, the GAC Filter container in the middle, and the Carbon Block Filter container on the left, tightening each with the housing wrench.



### Attaching the Elbows

1x

Screw the Large Thread Elbow into the narrow end of the In Line Activated Carbon Filter.

Screw the T-Connector Elbow into the wide end of the In Line Activated Carbon Filter.

1x

i



Anytime you screw in Elbows or the T-Connector, first wrap the threads with 12 layers of Teflon Tape. This will prevent leaking.

3x

Screw the three Small Thread Elbows into the RO Element Container.

2x



Using the Filter Clips, attach the In Line Activated Carbon Filter to the RO Element container, so that its wide end is next to the screw-on cap of the RO Element container.

### Assembling the RO Element and In Line Activated Carbon Filter

Place the RO Element in the corresponding container, and screw on the cap, tightening by hand.

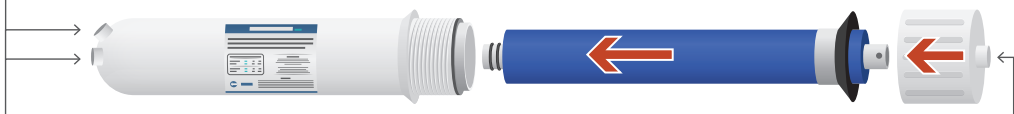

## Assembling the Valves and Tubing

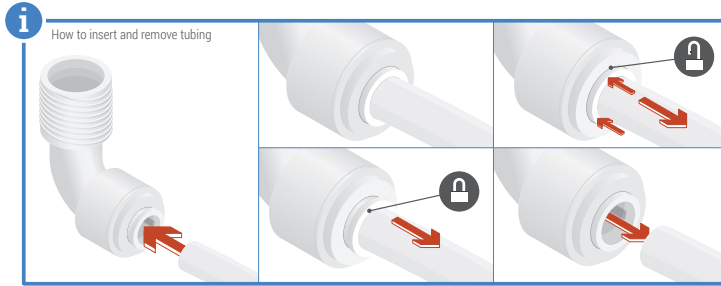

The top of the Automatic Shut Off Valve has the words IN and OUT on it, whereas the bottom has four screws.

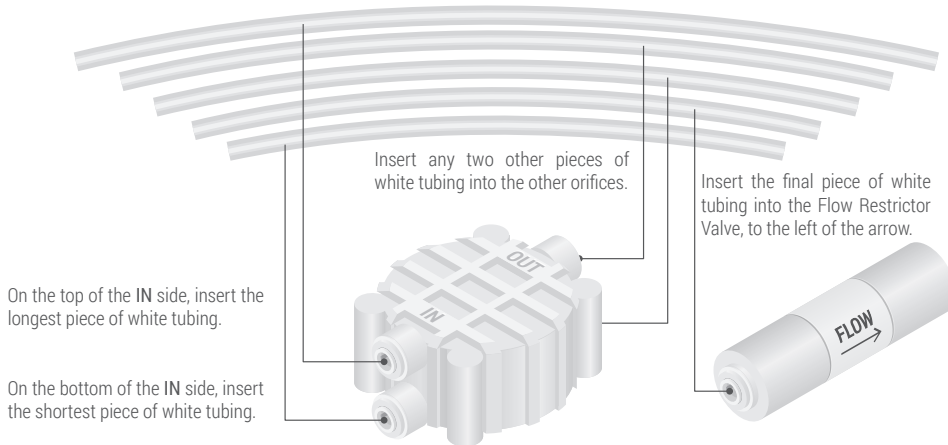

## Connecting the Valves

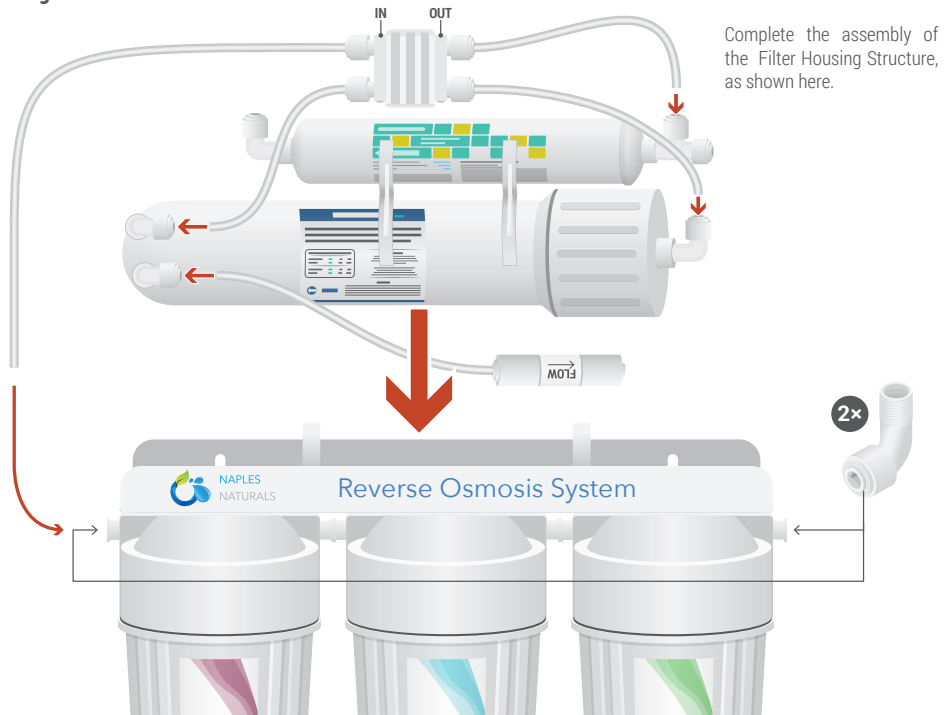

## STEP 2: ASSEMBLING THE STORAGE TANK

The Storage Tank is where your clean water is held. In order to filter water to a purity of 99.997%, water needs to pass through the filters very slowly. Nevertheless, you may want a full pitcher of water all at once, without having to wait. That's why clean water is stored in the tank, so it is ready for use at a moment's notice.

### Assembly

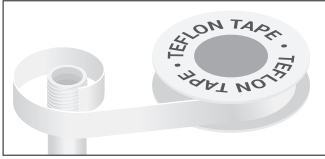

Wrap the threads at the top of the Storage Tank with 12 layers of Teflon Tape.

Screw the Storage Tank Ball Valve onto the top of the Storage Tank, tightening by hand.

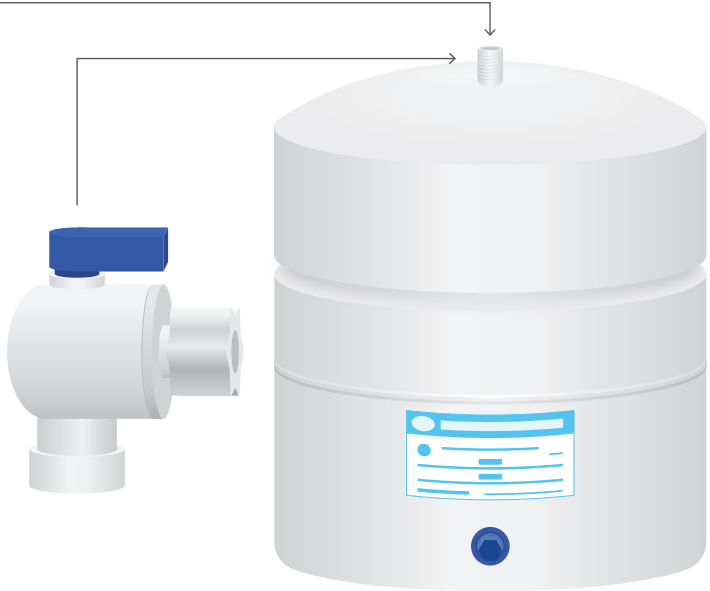

## STEP 3: TAPPING THE COLD WATER LINE



It is extremely important that you attach your Reverse Osmosis System to the **COLD** water line, and not the **HOT** water line. Hot water can damage your Reverse Osmosis System beyond repair.

### Tap Installation

Locate the **COLD** water supply under your sink.

Turn the water supply **OFF** by twisting the knob clockwise.

Loosen the water line by wrench, then completely disconnect the water line.



Insert the Black Rubber Washer into the Feed Adapter.

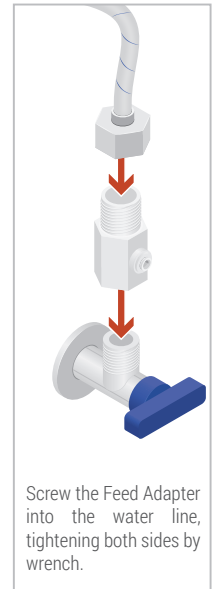

Screw the Feed Adapter into the water line, tightening both sides by wrench.

## STEP 4: MOUNTING THE DRAIN SADDLE VALVE

When your Reverse Osmosis System filters out contaminants, those contaminants have to go somewhere. They are sent through a tube down the drain. The Drain Saddle Valve is used to attach that tube to the drain, so the contaminants have somewhere to go.

### Drilling

Identify which pipe drains water from the sink.

Identify whether or not your drain pipe has a P-Trap (most do).

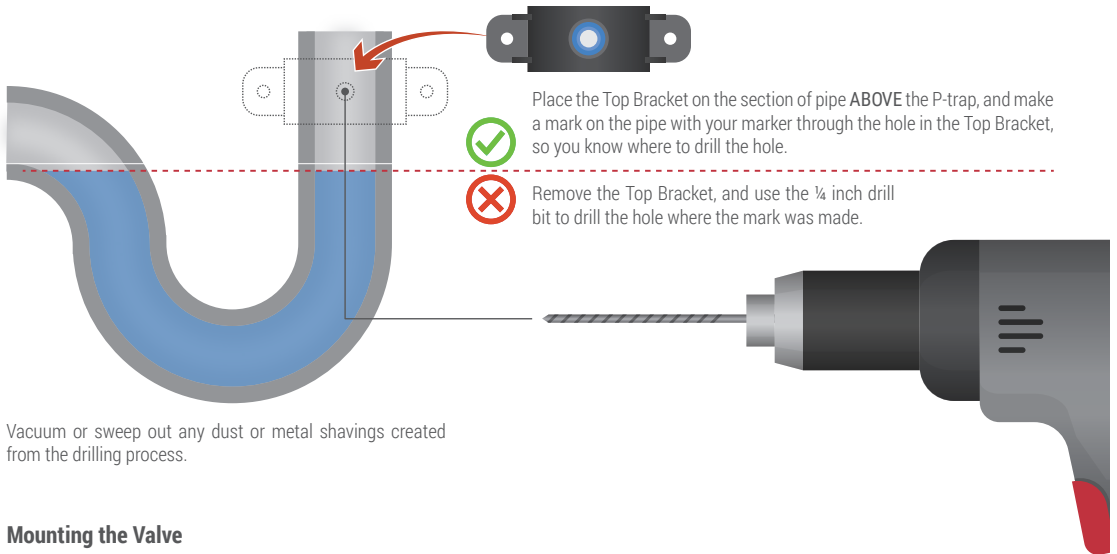

### Mounting the Valve

Punch out the center hole from the Foam Pad.

Remove the paper backing, exposing the sticky side.

Adhere the Foam Pad to the back of the Top Bracket, so that the holes line up.

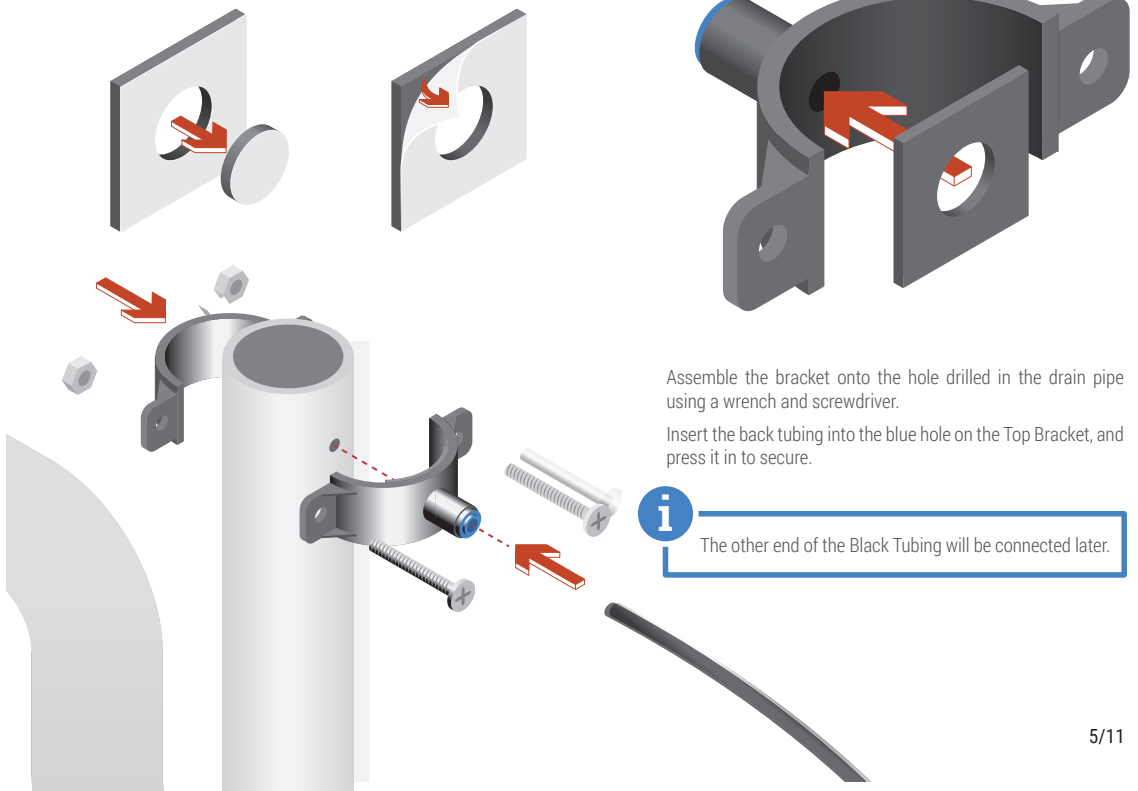

## STEP 5: DRILLING THE FAUCET HOLE

The Naples Naturals Reverse Osmosis Water Filtration System will dispense water for you out of a small faucet next to your kitchen faucet. If you have a soap dispenser or a spray nozzle, then you may choose to repurpose that pre-drilled hole for your new Reverse Osmosis Faucet.

### Preparing the Area for Drilling

Remove everything from the countertop within three feet of the drilling area.

Remove everything from the cupboard under the countertop.

Using a marker, make a dot exactly in the middle of where the hole will be drilled.

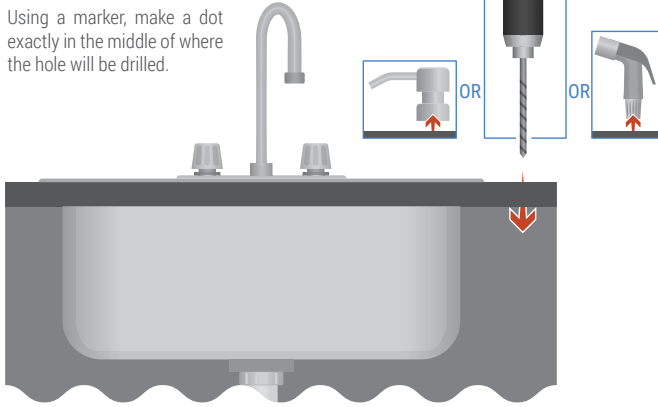

### Drilling the Hole

Start by making a smaller hole with the 1/8 inch drill bit, using a firm and steady downward pressure (if your sink is porcelain, drill very slowly to avoid chipping or shattering).

Widen the hole with the 1/2 inch drill bit in the same manner as when drilling the initial hole.

### Preparing the Area for Installation

Vacuum or sweep out any dust or shavings created from the drilling process.

Clean any sticky or dirty spots on the counter or below where the Reverse Osmosis System will be installed.

## STEP 6: INSTALLING THE FAUCET

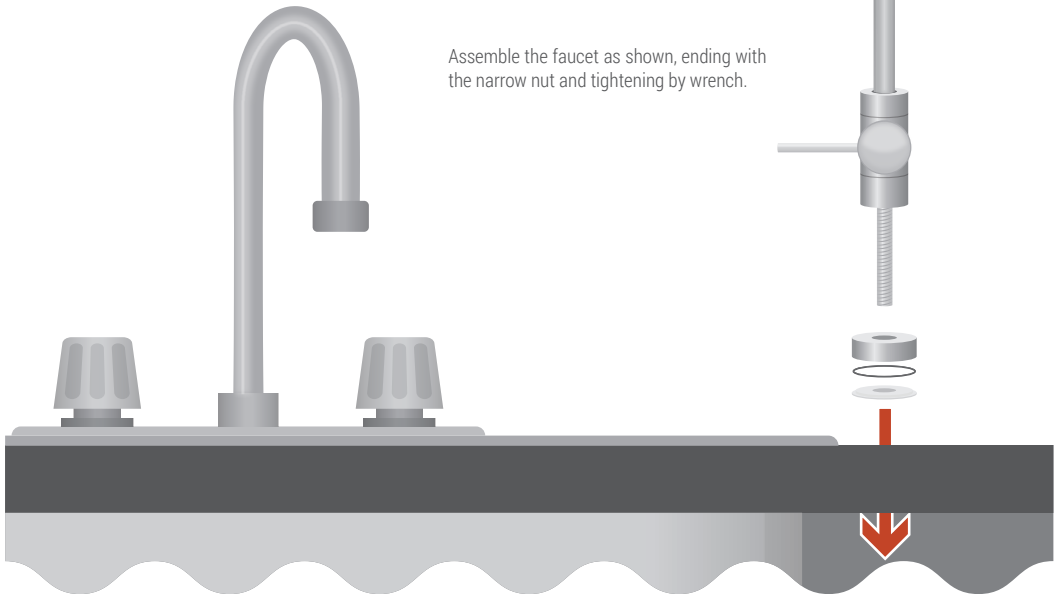

Assemble the faucet as shown, ending with the narrow nut and tightening by wrench.

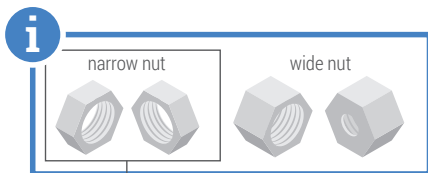

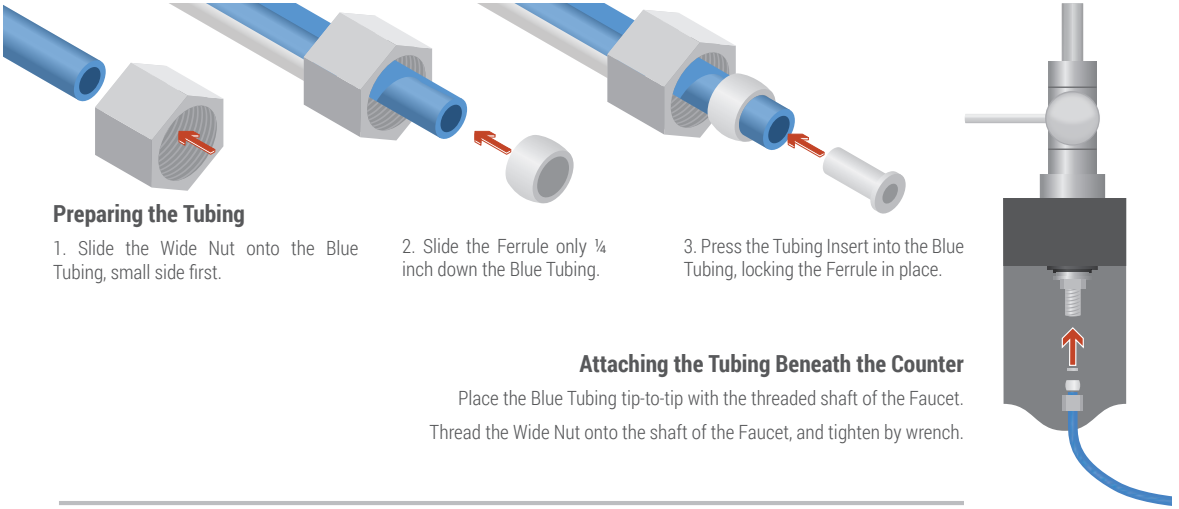

**Preparing the Tubing**

1. Slide the Wide Nut onto the Blue Tubing, small side first.
2. Slide the Ferrule only ¼ inch down the Blue Tubing.
3. Press the Tubing Insert into the Blue Tubing, locking the Ferrule in place.

**Attaching the Tubing Beneath the Counter**

Place the Blue Tubing tip-to-tip with the threaded shaft of the Faucet. Thread the Wide Nut onto the shaft of the Faucet, and tighten by wrench.

**STEP 7: INSTALLING THE WHOLE SYSTEM**

**Installation**

- Place the Filter Housing Assembly under the sink.
- Place the Storage Tank under the sink.



**Attaching the Tubing**

Cut the orange tubing in half, and use the Straight Valve to reconnect the two halves.

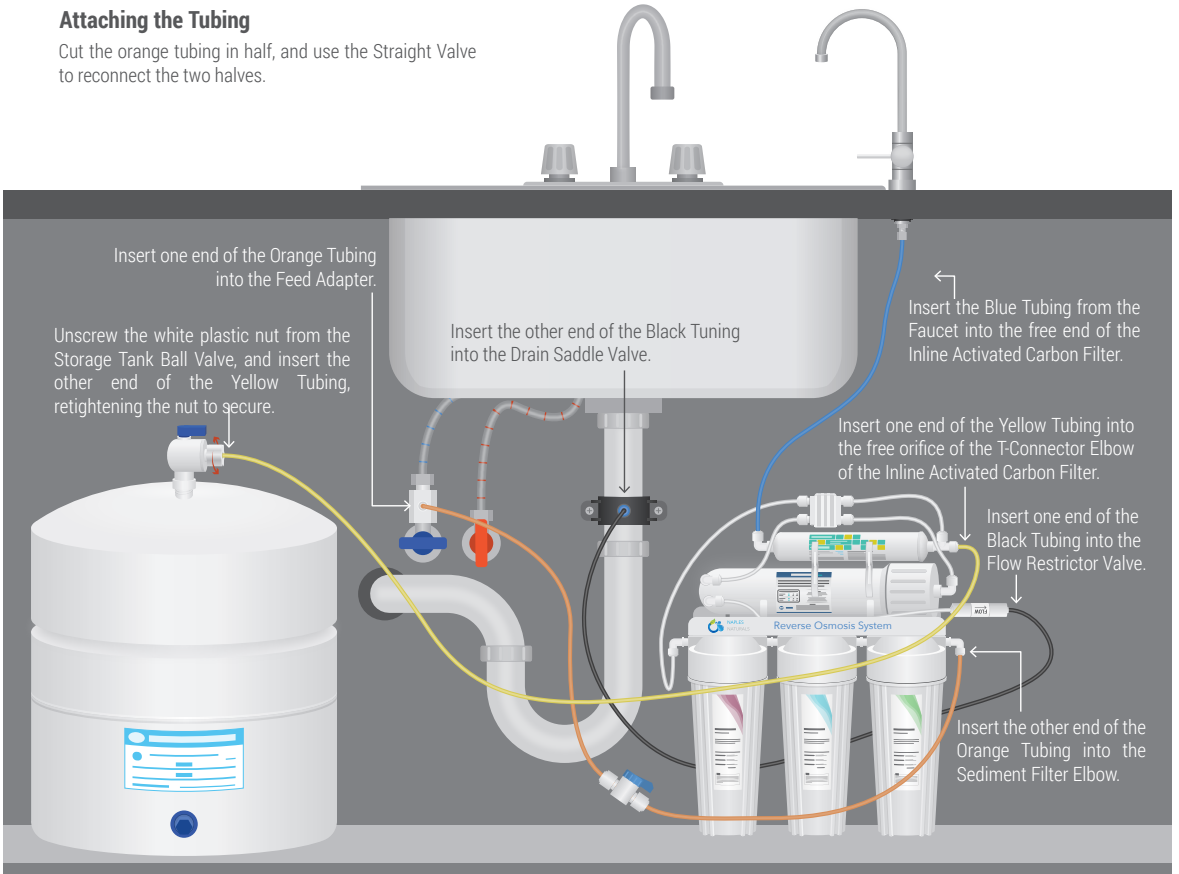

Insert one end of the Orange Tubing into the Feed Adapter.

Unscrew the white plastic nut from the Storage Tank Ball Valve, and insert the other end of the Yellow Tubing, retightening the nut to secure.

Insert the other end of the Black Tubing into the Drain Saddle Valve.

Insert the Blue Tubing from the Faucet into the free end of the Inline Activated Carbon Filter.

Insert one end of the Yellow Tubing into the free orifice of the T-Connector Elbow of the Inline Activated Carbon Filter.

Insert one end of the Black Tubing into the Flow Restrictor Valve.

Insert the other end of the Orange Tubing into the Sediment Filter Elbow.



**OPTIONAL: IF YOU HAVE THE NAPLES NATURALS ALKALINE FILTER ATTACHMENT, PLEASE FOLLOW THESE STEPS**

(1) Screw an elbow into each side of the Alkaline Filter, (2) then use the Filter Clips to attach the Alkaline Filter above the existing filters. (3) Cut the blue tubing, and (4) use the shorter part to connect the In-Line Activated Carbon Filter to the Alkaline Filter, and (5) the longer part to connect the Alkaline Filter to the faucet.

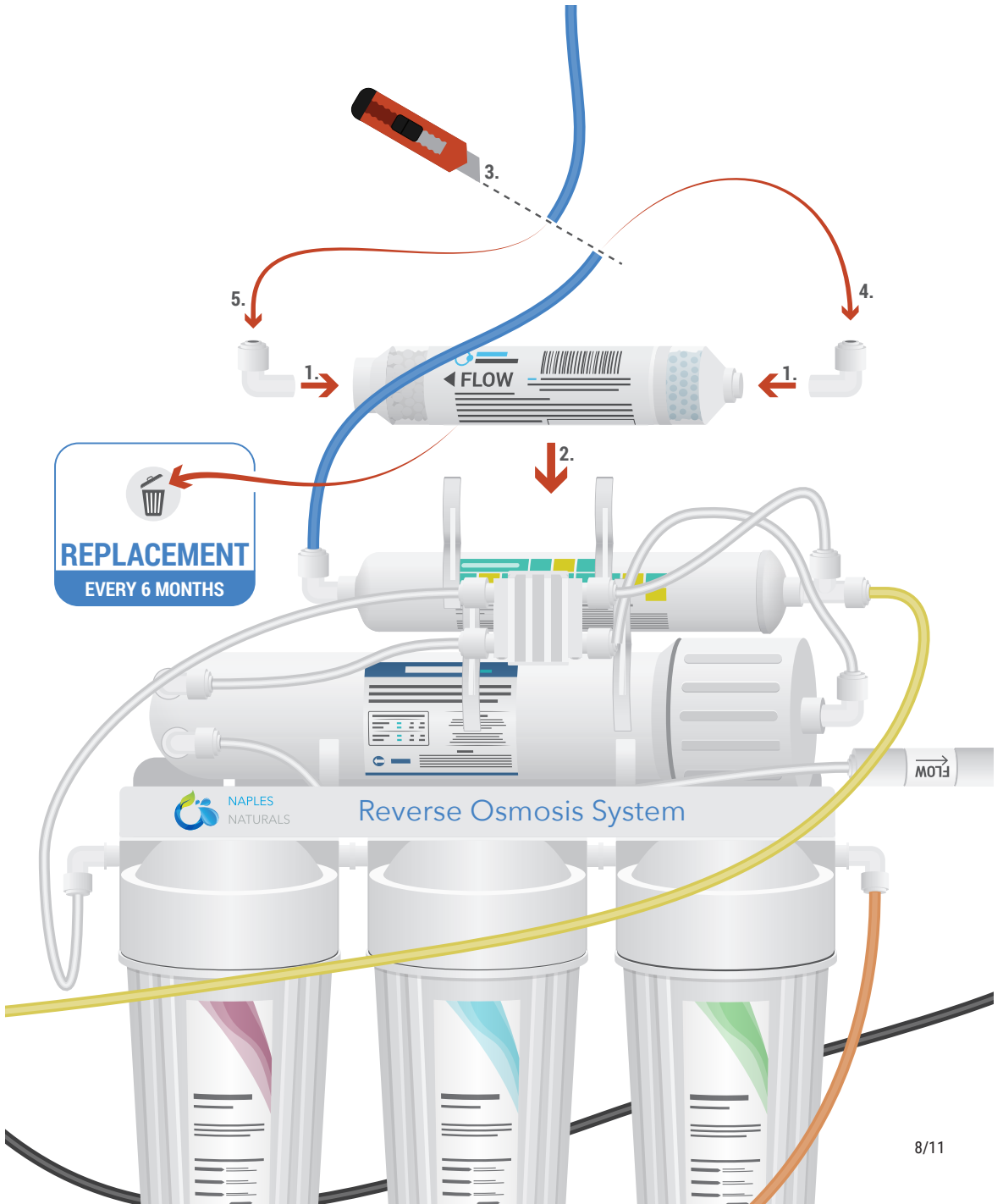

## STEP 8: SYSTEM START-UP

This procedure is intended to clean out your Reverse Osmosis System so the water you get will be pure and healthy. This process will take 12 hours. Please do not drink any water from your Reverse Osmosis Filter System until the System Start-Up has been completed.

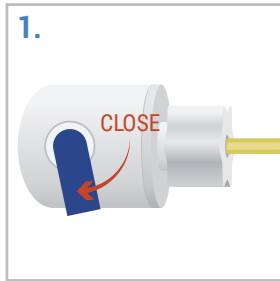

Turn the Tank Valve to the Closed position.

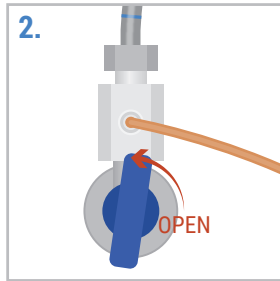

Slowly turn the Water Feed Adapter to the Open position.

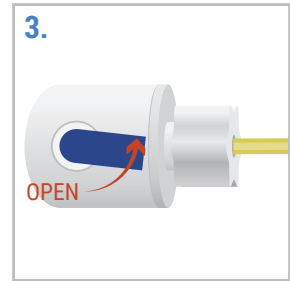

Turn the Tank Valve to the Open position.



Allow pressure to build for 10 minutes.

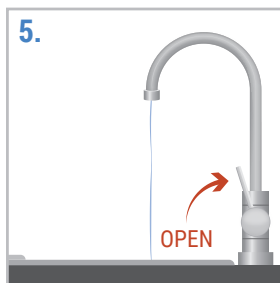

Open the Reverse Osmosis Faucet, to see if any water trickles out, then close the faucet.

a) If no water trickles out, make sure the Water Feed Adapter and Tank Valve are both open.

b) If they are both open, close the Reverse Osmosis Faucet and try again in 10 minutes.

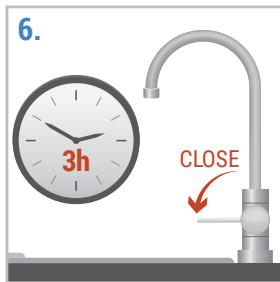

With the Reverse Osmosis Faucet closed, allow the Storage Tank to fill for three hours.

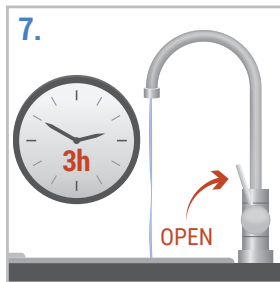

After three hours has passed, open the Reverse Osmosis Faucet and allow the water to empty from the Storage Tank for 5 minutes, at which point the flow should be reduced to a trickle, then close the Reverse Osmosis Faucet.

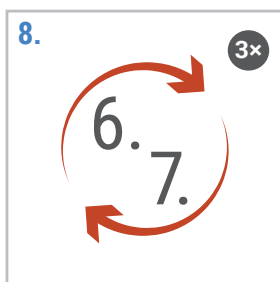

Repeat steps 6 and 7 three times (for a total of four times over all).



Allow 2-3 hours for your tank to refill a fifth time, now with clean, drinkable water.



The next day, check once more for leaks, just to make sure.

## VACATION MODE

If you are not going to be using your Reverse Osmosis system for two weeks or more, change it to Vacation Mode to prevent any leaks while you're away.

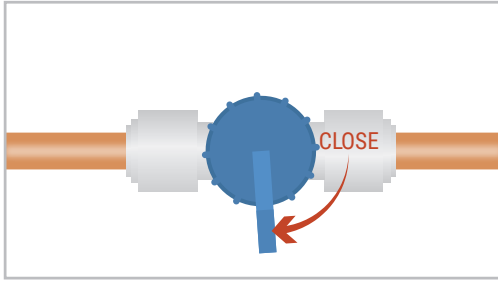

To Turn Vacation Mode ON: Locate the Straight Valve in the middle of the Orange Tubing, and turn it all the way clockwise.

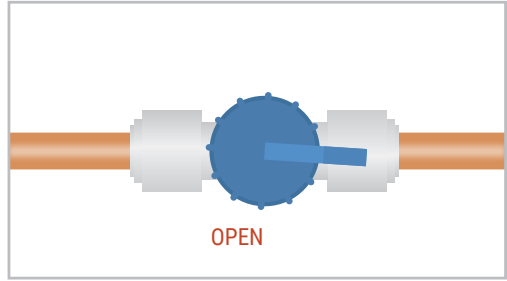

To Turn Vacation Mode OFF: Locate the Straight Valve in the middle of the Orange Tubing, and turn it all the way counter-clockwise.

## HOW TO REPLACE THE FILTERS

i

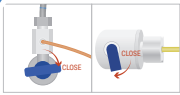

Turn the cold water line off and close the storage tank valve before changing any of the filters.

### Replacing the Sediment Filter: Every 6 months

This filter removes large particles from your water, like rust and sediment. It is important to remove these larger particles first, because otherwise the filters down the line would get clogged easily.

1. Using the Housing Wrench, unscrew the Sediment Filter container by turning it counterclockwise
2. Remove the old filter, and discard it
3. Insert the new filter
4. Screw the Sediment Filter container back on, tightening it with the Housing wrench

Your Sediment Filter has now been replaced. After you have replaced all the necessary filters, make sure to restart your system, following the instructions on p. 8, System Start-Up. If you do not do this, your water will not be clean.



### Replacing the GAC Filter: Every 6 months

This filter removes chlorine and foul-tasting volatile organic compounds from your water. The lifetime of this filter with normal use is 6 months.

1. Using the Housing Wrench, unscrew the GAC Filter container by turning it counterclockwise
2. Remove the old filter, and discard it
3. Insert the new filter
4. Screw the GAC Filter container back on, tightening it with the Housing wrench

Your GAC Filter has now been replaced. After you have replaced all the necessary filters, make sure to restart your system, following the instructions on p. 8, System Start-Up. If you do not do this, your water will not be clean.



### Replacing the Carbon Block Filter: Every 6 months

This filter removes small particles from your water, like bacteria and protozoa. It is important to remove these particles before the water moves on to the RO Element, which would otherwise be easily clogged. The lifetime of this filter with normal use is 6 months.

1. Using the Housing Wrench, unscrew the Carbon Block Filter container by turning it counterclockwise
2. Remove the old filter, and discard it
3. Insert the new filter
4. Screw the Carbon Block Filter container back on, tightening it with the Housing wrench

Your Carbon Block Filter has now been replaced. After you have replaced all the necessary filters, make sure to restart your system, following the instructions on p. 8, System Start-Up. If you do not do this, your water will not be clean.



### Replacing the RO Element: Every 1 year

This filter removes virtually everything from your water, besides the H<sub>2</sub>O molecule itself. Heavy metals, harmful chemicals, and even viruses are stopped at this stage. The lifetime of this filter with normal use is 1 year.

1. Remove the white tubing from the RO Element Container Lid, as shown in the picture.
2. Unscrew the RO Element Container Lid.
3. Using a pair of pliers, pull out the RO Element, and discard it.

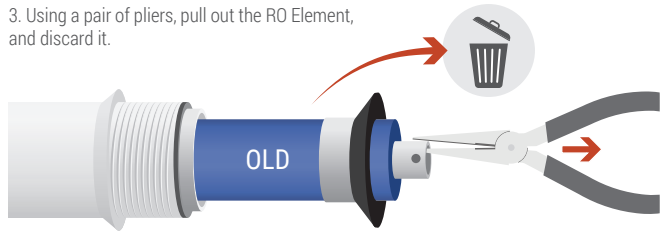
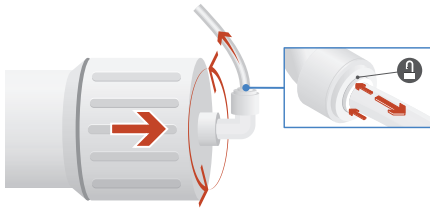

4. Using a pair of pliers, insert the new RO element into the RO Element Container, making sure not to touch the RO Element with your hands.



5. Screw the RO Element Container Lid back on.

6. Reconnect the disconnected white tubing.

### Replacing the Inline Activated Carbon Filter: Every 1 year

This filter provides one final scrubbing as the water goes from your Storage Tank to your Reverse Osmosis Faucet, making sure you have the cleanest and best tasting water possible. The lifetime of this filter with normal use is 1 year.

1. Remove the white tubing from the Inline Activated Carbon Filter, as shown in the picture.
3. Reconnect the disconnected white tubing to the new Activated Carbon Filter.

