



**50L, 65L, 95L, 120L,  
160L, 250L, 320L**

**6" Stainless Steel Submersible Pumps**

60 HZ HIGH CAPACITY - FOR 6" AND LARGER WELLS

### FEATURES

**Powered for Continuous Operation:** All ratings are within the working limits of the motor. Pump can be operated continuously.

**New Design Features:** Cast 304 SS discharge head and motor adapter.

**Field Serviceable:** Easy to install and service. All parts easily dismantled if field service is ever necessary.

**Diverse Application:** Designed for commercial, municipal and agricultural water needs.

**Stainless Steel Construction:** Durable in most waters.

**Bearings:** Replaceable, silicon carbide bearings allow excellent abrasives handling and wear resistance.

**Built-in Check Valve:** Positive sealing, stainless steel check valve assembly incorporated into discharge head.

**Impellers:** New stainless steel impeller design provides improved efficiency.

**Maximum Temperature:** 140°F (60°C) for pump.

**Four-Fluted Shaft Design:** Four sided stainless steel shaft eliminates impeller keys and provides positive drive.

**Coupling:** Removable heavy duty stainless steel, splined coupling for maximum load-carrying capability.

**Suction Strainer:** Stainless steel strainer restricts gravel and other debris from entering the pump.

**Cable Guard:** Stainless steel cable guard surrounds and protects motor leads.

**Fasteners:** All fasteners are stainless steel.

**CentriPro Motors:** Designed to NEMA standards. Stainless steel casing resists corrosion. Water filled design provides a constant supply of lubrication. Hermetically sealed stator assures moisture free windings. Durable Kingsbury type thrust bearing absorbs all thrust. Replaceable motor lead assembly.

**Certified to NSF/ANSI 61, Annex G.**

### SPECIFICATIONS

Model	Horsepower Range	Discharge Connection	Recommended GPM Operating Range	GPM at Best Efficiency	Minimum* Well Size	Rotation at Discharge End
50L	3 - 20	3" NPT	17 - 70	50	6" / 8" *	CCW
65L	3 - 40		20 - 90	65		
95L	5 - 40		25 - 130	90		
120L	5 - 50		40 - 170	120		
160L	3 - 60		50 - 240	160	6"	
250L	7.5 - 60		70 - 300	250		
320L	7.5 - 60	4" NPT	100 - 400	320		

\* Minimum well size refers only to dimensional fit in a well, the specifier or installer must determine the minimum required well diameter that will insure an adequate supply of water to the pump and also properly cool the motor. See Water End Data Chart for specific diameter by model number.

### AGENCY LISTINGS



NSF/ANSI 372 - Drinking Water System Components - Lead Content

CLASS 6853 01 - Low Lead Content Certification Program - Plumbing Products



Pump/Water End - Drinking Water System Components - Certified to NSF/ANSI 61, Annex G

### "L" SERIES MATERIALS OF CONSTRUCTION

Ref. No.	Part Name	Material	Material Code
1	Discharge Head	Stainless steel	ASTM CF-8 (AISI 304 cast)
2	Check Valve Support	Stainless steel	ASTM CF-8 (AISI 304 cast)
3	Check Valve	Stainless steel	AISI 304 SS
4	Elastomers	Ethylene propylene	EPDM
5	Bolts and Screws	Stainless steel	AISI 304 SS
6	Shaft Sleeve and Bushing	Tungsten carbide	-
7	Thrust Bearing	PTFE+Graphite	-
8	Impeller	Stainless steel	AISI 304 SS
9	Diffuser	Stainless steel	AISI 304 SS
10	Spacer	Stainless steel	AISI 431 SS
11	Tie Rod	Stainless steel	AISI 304 SS
12	Cable Guard	Stainless steel	AISI 304 SS
13	Wear Rings	Technopolymer PPO	Engineered polymer
14	Strainer	Stainless steel	AISI 304 SS
15	Shaft	Stainless steel	AISI 431 SS
16	Shaft Coupling	Stainless steel	AISI 431 SS
17	Motor Adapter	Stainless steel	ASTM CF-8 (AISI 304 cast)

### SYSTEM COMPONENTS

#### ■ Pump/Water End:

- 50L-250L with 3" NPT discharge.
- 320L with 4" NPT discharge.
- 3 HP Water Ends Have 4" Motor Adapters
- 5 & 7.5 HP Water Ends Have Either a 4" or 6" Motor Adapter (see Water End Data chart)
- 10 HP and Larger Water Ends Have 6" Motor Adapters

#### ■ Motor:

- 4" motor required for 3 HP and 5 HP pumps.
- 4" or 6" motors can be used for 7.5 HP pumps.
- 6" motor required for 10 HP and larger pumps.

■ **Control Box:** Required for all single phase motors.

■ **Magnetic Starter:** A magnetic starter with Class 10 overloads is required for all three phase units.

**WATER ENDS AND MOTORS MUST BE ORDERED SEPARATELY AND ARE PACKAGED SEPARATELY.**

### ORDER NUMBER CODE

	65	L	03	
				Horsepower Code =
	50			HP
	65			03 = 3
	95			05 = 5 (4" motor)
	120			05-6 = 5 (6" motor)
	160			07-4 = 7.5 (4" motor)
	250			07 = 7.5 (6" motor)
	320			10 = 10
Pump Size/ Gallons per minute at Best Efficiency Point				15 = 15
				20 = 20
Pump Series				25 = 25
				30 = 30
				40 = 40
				50 = 50
				60 = 60

### WATER END (PUMP) DATA

Model	Order No.	No. Stages	Min. HP Required	Required Motor Dia.	Dimensions & Weights						
					Length		Diameter		Weight		
					in.	mm	in.	mm	lbs.	kg.	
50L	50L03	4	3	4	20.6	522	5.59	142	25	11	
	50L05R**	7	5	4/6	25.8	656	5.67	144	35	16	
	50L05**	8	5		27.8	706			40	18	
	50L07**	11	7.5		33.3	844			49	22	
	50L10	15	10	6	40.2	1020			57	26	
	50L15	23	15		56.9	1446			82	37	
50L20	28	20	65.8		1670	94			43		
65L	65L03	3	3	4	18.6	472	5.59	142	26	12	
	65L05**	5	5	4/6	22.2	564	5.67	144	31	14	
	65L07**	7	7.5		25.8	656			35	16	
	65L10	10	10		31.3	794			44	20	
	65L15	16	15	6	42.1	1070			60	27	
	65L20	21	20		53.0	1346			75	34	
	65L25	27	25		63.9	1622			90	41	
	65L30*	32	30		98.7	2508			220	100	
65L40*	41	40	115.0		2922	6.97*			177	253	115
95L	95L05**	3	5	4/6	18.6	472	5.59	142	26	12	
	95L07**	5	7.5	4/6	22.2	564	5.67	144	31	14	
	95L10	7	10		25.8	656			35	16	
	95L15	10	15		31.3	794			44	20	
	95L20	14	20	6	38.5	978			53	24	
	95L25	17	25		43.9	1116			62	28	
	95L30	21	30		53.0	1346			75	34	
	95L40*	28	40		67.3	1710			6.97*	177	156
120L	120L05**	2	5		4/6	16.8			426	5.59	142
	120L07**	3	7.5	4/6	19.5	495	5.67	144	26	12	
	120L10	5	10		24.9	633			33	15	
	120L15	7	15		30.4	771			40	18	
	120L20	10	20	6	38.5	978			51	23	
	120L25	12	25		43.9	1116			57	26	
	120L30	15	30		52.1	1323			68	31	
	120L40	20	40		65.7	1668			86	39	
120L50*	24	50	80.9		2055	6.97*			177	179	81
160L	160L03	1	3	4	14.5	367	5.59	142	18	8	
	160L05**	2	5	4/6	17.2	436	5.67	144	22	10	
	160L07**	3	7.5		19.9	505			26	12	
	160L10	4	10		22.6	574			31	14	
	160L15	6	15	6	28.0	712			37	17	
	160L20	8	20		33.5	850			44	20	
	160L25	9	25		36.2	919			46	21	
	160L30	11	30		41.6	1057			53	24	
	160L40	15	40		52.5	1333			68	31	
	160L50	18	50		60.6	1540			77	35	
160L60	20	60	65.7		1668	86			39		
250L	250L07**	2	7.5	4/6	20.8	528	5.67	144	26	12	
	250L10	3	10	4/6	25.3	643			33	15	
	250L15	5	15		34.4	873			44	20	
	250L20	7	20		43.4	1103			55	25	
	250L25	8	25	6	48.0	1218			60	27	
	250L30	9	30		52.5	1333			66	30	
	250L40	13	40		70.6	1793			88	40	
	250L50	16	50		84.2	2138			104	47	
250L60	19	60	97.8		2484	128	58				
320L	320L07**	2	7.5	4/6	21.8	553	5.67	144	27	12	
	320L15	4	15	4/6	30.8	783			38	17	
	320L20	5	20		35.4	898			45	20	
	320L25	6	25		39.9	1013			50	22	
	320L30	8	30	6	49.0	1243			61	27	
	320L40	11	40		62.5	1588			78	35	
	320L50	13	50		71.6	1818			89	40	
	320L60	16	60		84.2	2138			104	47	

\* Note pump diameter - high pressure models have an exterior casing and larger diameters, verify they will fit your well.

\*\* Pumps can be configured to accommodate a 4" or 6" motor. See product order code.

### MOTOR DATA

**NOTE:** 4" diameter motors are required for 3 and 5 HP "L" Series pumps.  
 4" or 6" diameter motors can be used for 7.5 HP "L" Series pumps. See Water End Data Chart.  
 6" diameter motors are required for 10 HP and larger "L" Series pumps.

### CENTRIPRO 4" MOTORS

Single Phase Motors - Dimensions and Weights					
Motor Order No.	HP	Motor Dia.	Volts	Length in. (mm)	Weight lbs. (Kg)
M30412	3	4"	230	18.3 (466)	40 (18.1)
M50412	5			27.7 (703)	70 (31.8)
Three Phase Motors - Dimensions and Weights					
M30430	3	4"	200	15.3 (389)	32 (14.5)
M30432			230		
M30434			460		
M50430	5	4"	200	21.7 (550)	55 (24.9)
M50432			230		
M50434			460		
M75430	7.5	4"	200	27.7 (703)	70 (31.8)
M75432			230		
M75434			460		

### CENTRIPRO 6" MOTORS

Single Phase Motors - Dimensions and Weights					
Motor Order No.	HP	Motor Dia.	Volts	Length (inches)	Weight (lbs)
6M071	7.5	6"	230	29.9	128
6M101	10	6"	230		
6M151	15	6"	230	33.5	148
Three Phase Motors - Dimensions and Weights					
6M078	7.5	6"	200	24.8	99
6M072			230		
6M074			460		
6M108	10	6"	200	27.0	110
6M102			230		
6M104			460		
6M158	15	6"	200	29.9	128
6M152			230		
6M154			460		
6M208	20	6"	200	31.5	137
6M202			230		
6M204			460		
6M258	25	6"	200	36.2	161
6M252			230		
6M254			460		
6M308	30	6"	200	38.2	176
6M302			230		
6M304			460		
6M404	40	6" x 8"	460	40.6	187
66M504	50			41.7	198
86M504	50			46.4	353

### CENTRIPRO FM-SERIES 6" MOTORS

Single Phase Motors Dimensions and Weights					
Motor Order No.	HP	Motor Dia.	Volts	Length (inches)	Weight (lbs)
6F051	5	6"	230	25.6	143
6F071	7.5			28.1	161
6F101	10			30.3	161
6F151	15			32.8	181
Three Phase Motors Dimensions and Weights					
Motor Order No.	HP	Motor Dia.	Volts	Length (inches)	Weight (lbs)
6F058	5	6"	200-208	23.0	107.0
6F052			230		
6F054			460		
6F078	7.5	6"	200-208	24.3	117.0
6F072			230		
6F074			460		
6F108	10	6"	200-208	25.6	124.0
6F102			230		
6F104			460		
6F158	15	6"	200-208	28.1	127.0
6F152			230		
6F154			460		
6F208	20	6"	200-208	30.3	152.0
6F202			230		
6F204			460		
6F258	25	6"	200-208	32.8	164.0
6F252			230		
6F254			460		
6F308	30	6"	200-208	35.6	185.0
6F302			230		
6F304			460		
6F404	40	6"	460	39.3	207.0
6F504	50		460	54.1	285.0

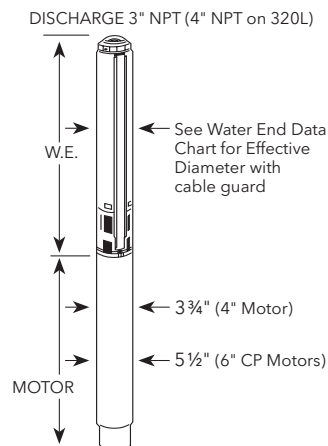

### MODEL 50L

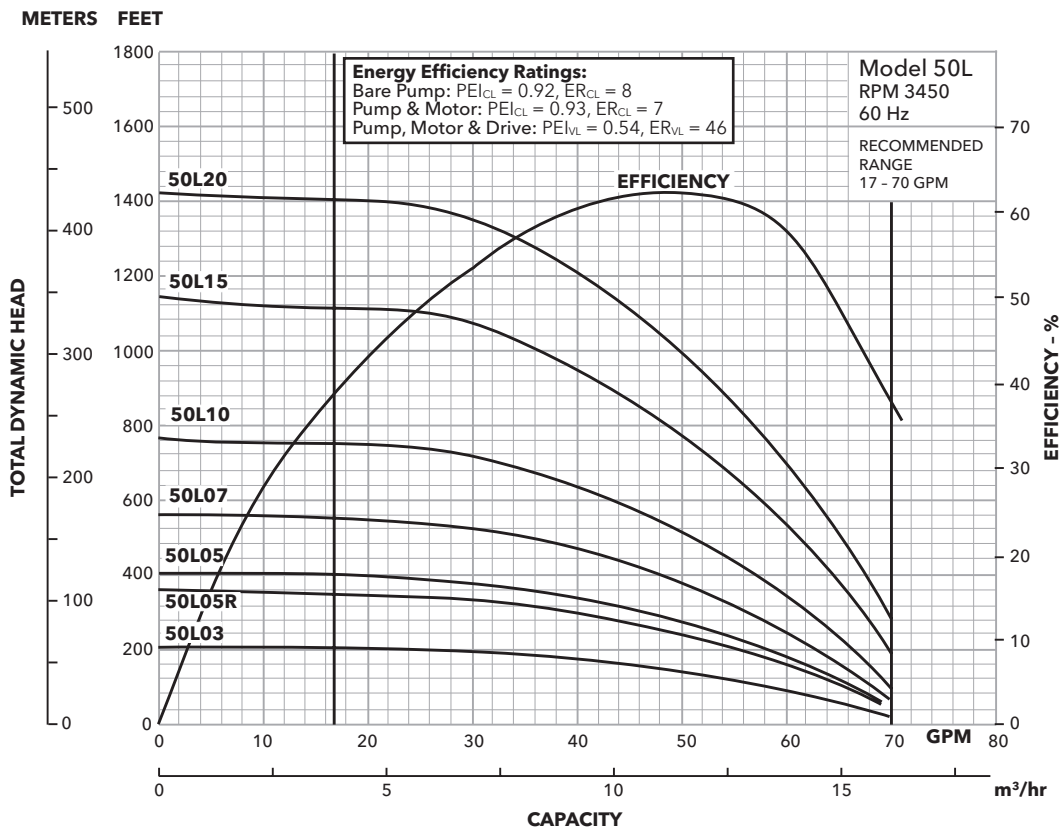

### MODEL 65L

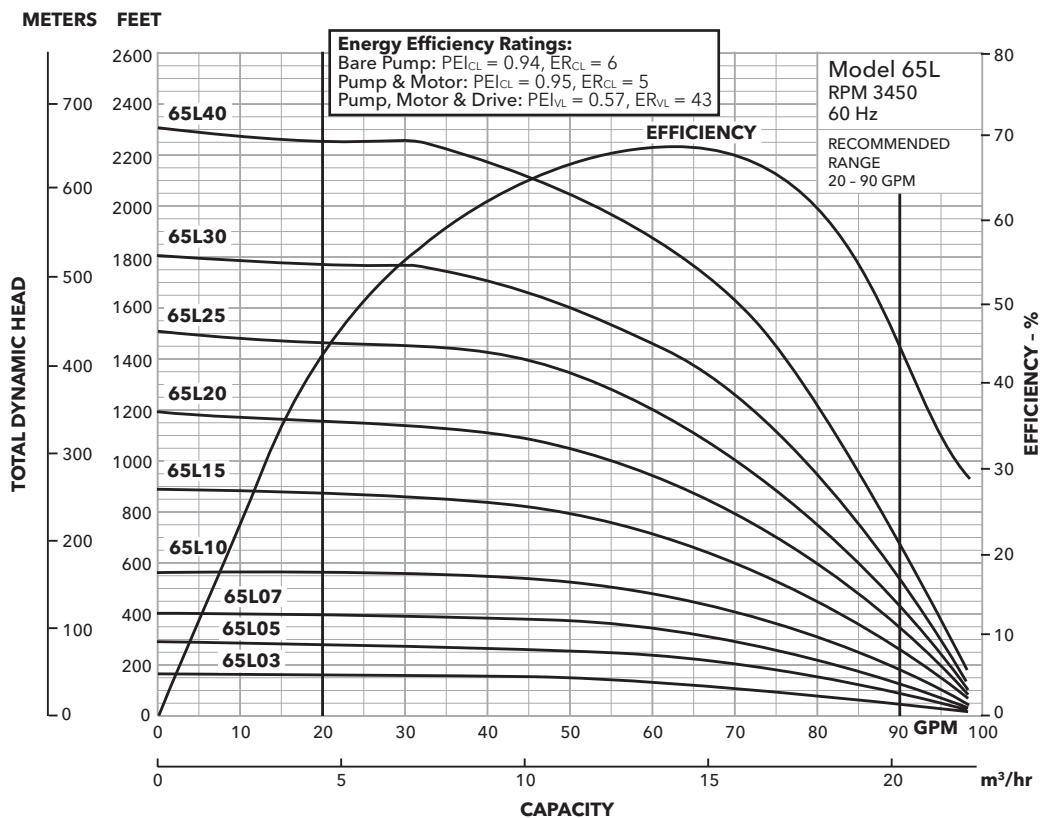

### MODEL 95L

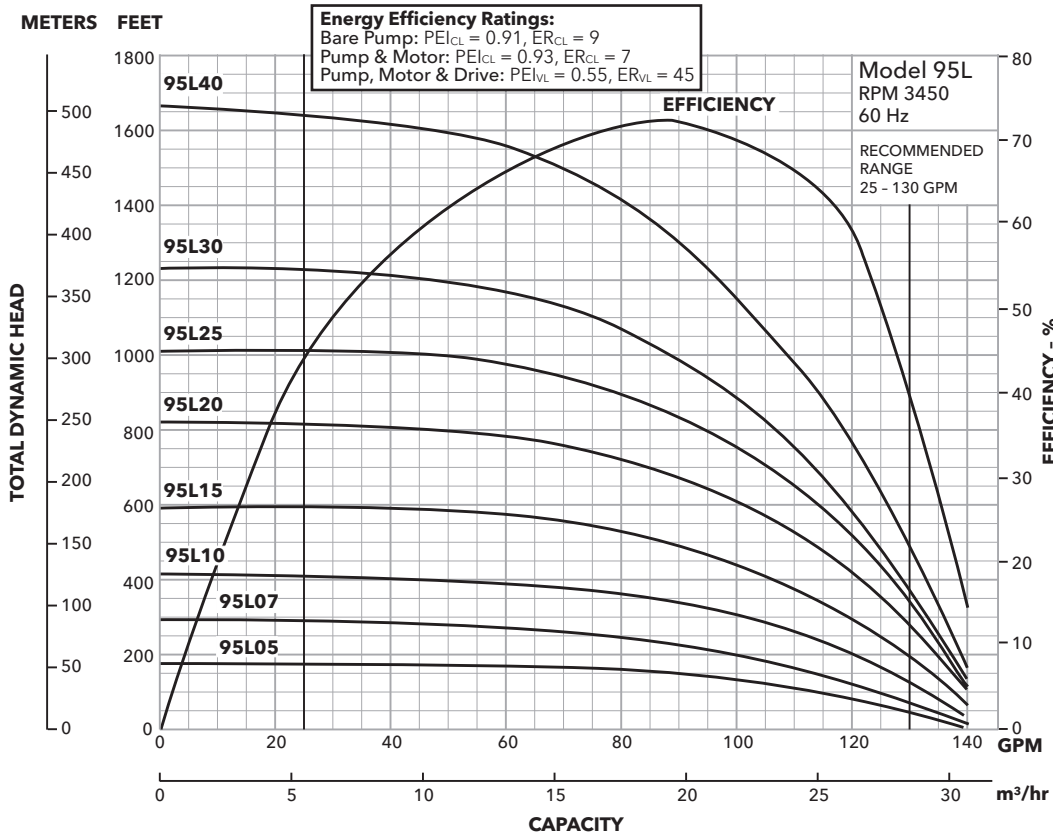

### MODEL 120L

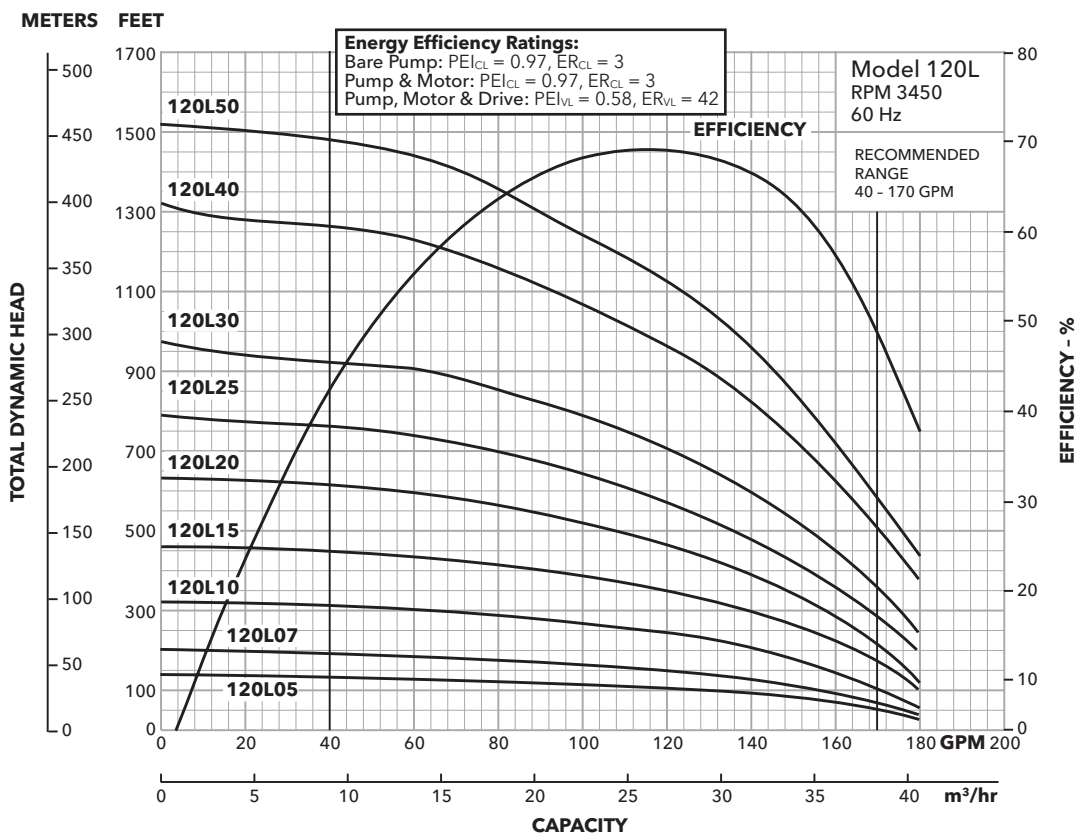

### MODEL 160L

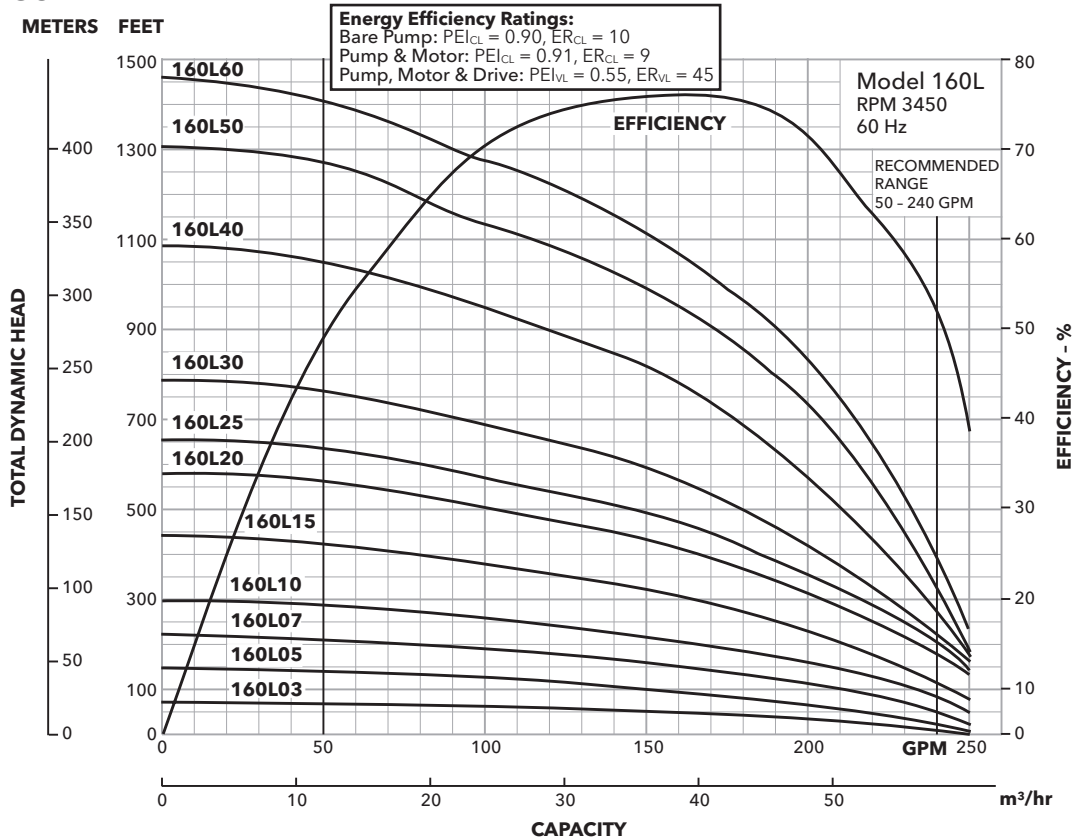

### MODEL 250L

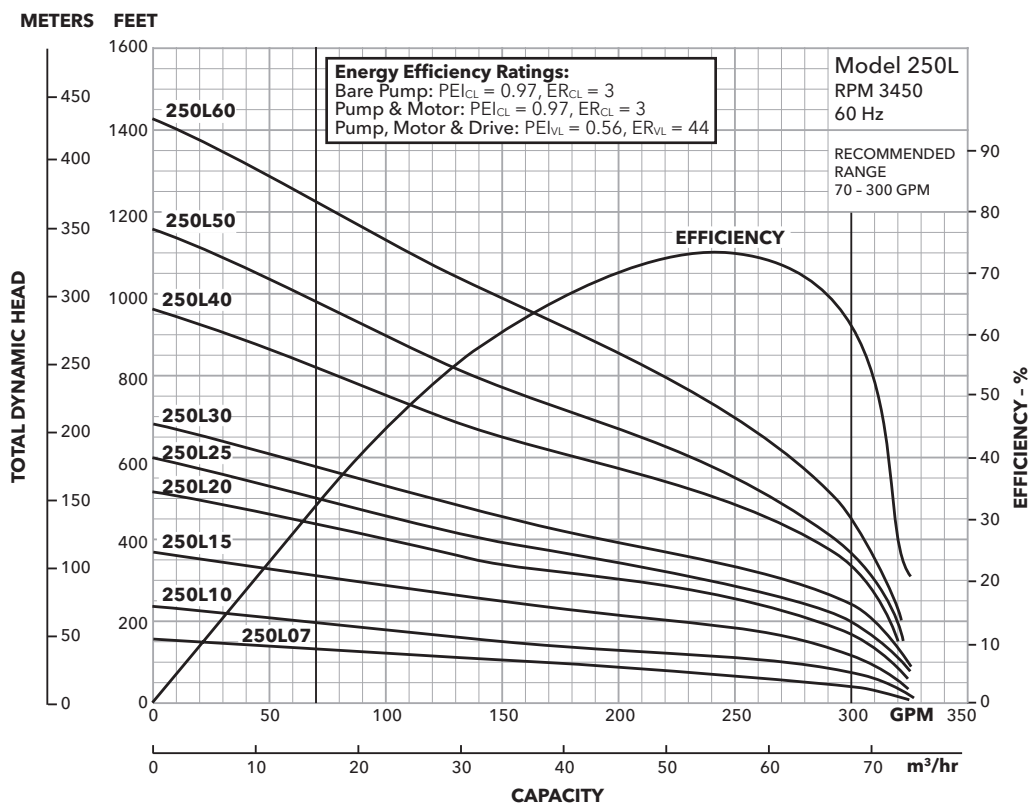

**NOTE:** On 250L, operation below minimum recommended flow will increase motor amp. draw and trip overloads.



### MODEL 320L

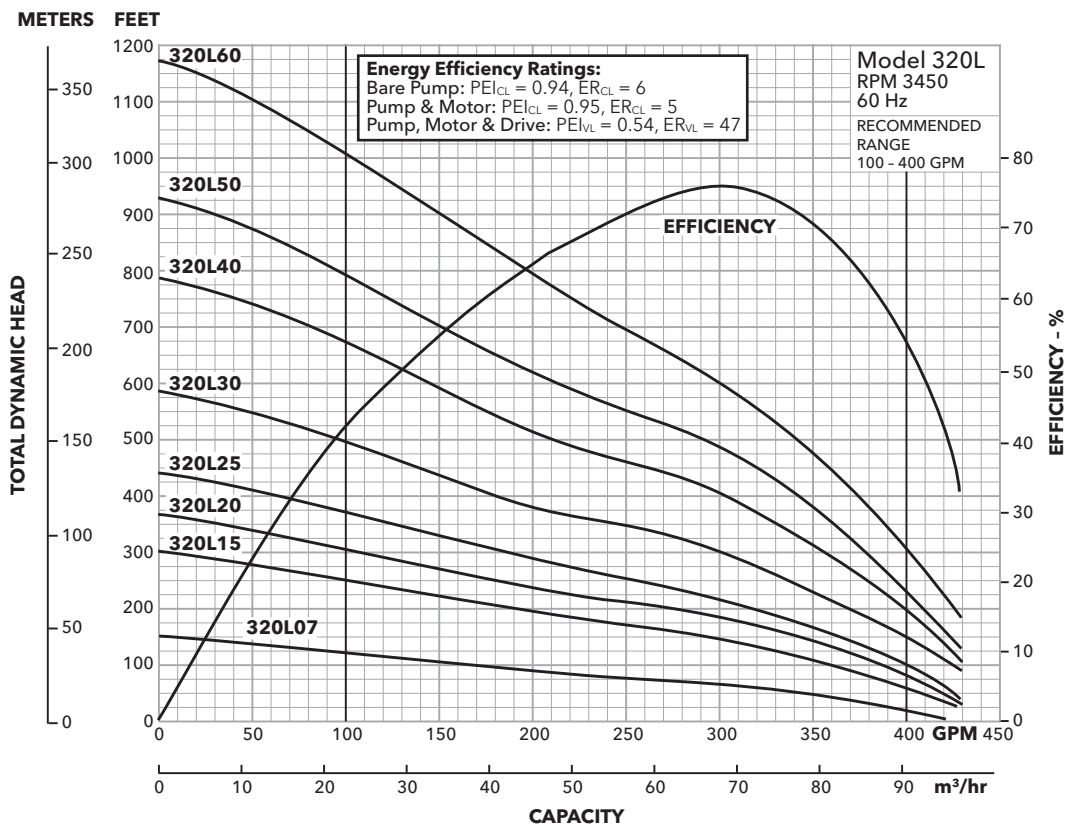

**NOTE:** On 320L, operation below minimum recommended flow will increase motor amp. draw and trip overloads.

## Residential Water Systems

### MODEL 50L SELECTION CHART

Horsepower Range 3 - 20, Recommended Range 17 - 70 GPM, 60 Hz, 3450 RPM

Pump Model	Depth to Water in Feet/Ratings in GPM (Gallons per Minute)																																			
	HP	PSI	25	50	75	100	125	150	175	200	225	250	275	300	325	350	375	400	425	450	475	500	525	550	575	600	625	650	675	700	725	750				
50L03 4 Stages	3	0		74	68	62	58	50	42	21																										
		20	69	63	59	52	43	27																												
		30	63	59	52	44	29																													
		40	59	53	45	31																														
		50	53	45	33																															
		60	46	35																																
50L05R 7 Stages	5	0			56	72	67	62	59	58	54	48	44	40	27																					
		20		49	72	68	62	60	58	55	49	44	41	31																						
		30	45	71	69	63	60	58	55	50	45	41	32																							
		40	71	69	63	60	58	55	50	45	41	33																								
		50	70	63	60	58	56	51	45	42	34																									
		60	64	60	59	56	51	46	42	35																										
50L05 8 Stages	5	0			65	74	72	68	64	62	60	58	54	50	46	42	36	21																		
		20	62	73	72	68	65	62	61	58	55	51	47	43	37	24																				
		30	73	73	69	65	63	61	58	55	51	47	43	37	26																					
		40	73	69	65	63	61	59	56	52	47	43	38	27																						
		50	69	65	63	61	59	56	52	48	44	39	28																							
		60	66	63	61	59	56	52	48	44	39	29																								
50L07 11 Stages	7.5	0			63	72	74	72	68	66	64	62	61	59	57	55	52	49	46	43	39	33	21													
		20		60	72	74	72	69	66	64	62	61	60	58	55	52	49	46	43	40	34	23														
		30	59	71	74	72	69	66	64	63	61	60	58	55	52	49	46	43	40	35	25															
		40	71	74	72	69	66	64	63	61	60	58	56	53	50	47	44	40	35	26																
		50	74	73	70	67	64	63	61	60	58	56	53	50	47	44	41	36	27																	
		60	73	70	67	65	63	61	60	58	56	53	50	47	44	41	36	27																		
50L10 15 Stages	10	0				57	68	73	74	73	71	68	66	65	63	62	61	60	59	57	56	54	51	49	47	45	43	40	36	30	21					
		20			54	67	72	74	73	71	69	67	65	63	62	61	60	59	58	56	54	52	49	47	45	43	40	37	32	23						
		30		53	66	72	74	73	71	69	67	65	64	62	61	60	59	58	56	54	52	50	47	45	43	41	37	32	24							
		40	52	65	72	74	73	71	69	67	65	64	63	62	61	59	58	56	54	52	50	48	45	43	41	38	33	24								
		50	65	72	74	73	71	69	67	65	64	63	62	61	59	58	56	54	52	50	48	46	43	41	38	33	25									
		60	71	74	73	72	69	67	65	64	63	62	61	60	58	56	55	52	50	48	46	44	41	38	33	26										

Pump Model	Depth to Water in Feet/Ratings in GPM (Gallons per Minute)																																		
	HP	PSI	50	100	150	200	250	300	350	400	450	500	550	600	650	700	750	800	850	900	950	1000	1050	1100	1150	1200	1250	1300	1350	1400	1450	1500			
50L15 23 Stages	15	0				63	72	74	72	68	66	64	62	61	59	57	55	52	49	46	43	39	33	21											
		20			62	72	74	72	69	66	64	62	61	59	57	55	52	49	46	43	39	34	22												
		30		50	68	74	73	70	67	65	63	62	60	59	56	54	51	48	45	41	37	29													
		40	33	60	72	74	72	69	66	64	62	61	60	58	55	52	49	46	43	40	34	23													
		50	48	67	73	73	71	68	65	63	62	60	59	57	54	51	48	45	42	38	30														
		60	59	71	74	72	69	66	64	63	61	60	58	55	52	49	46	43	40	35	25														
50L20 27 Stages	20	0				57	68	73	74	73	71	68	66	65	63	62	61	60	59	57	56	54	51	49	47	45	43	40	36	30	21				
		20			56	67	73	74	73	71	68	66	65	63	62	61	60	59	58	56	54	52	49	47	45	43	40	37	31	22					
		30		46	62	71	74	74	72	70	67	66	64	63	62	61	60	58	57	55	53	50	48	46	44	42	39	34	27						
		40		54	67	72	74	73	71	69	67	65	63	62	61	60	59	58	56	54	52	49	47	45	43	40	37	32	23						
		50		44	61	70	73	74	72	70	68	66	64	63	62	61	60	59	57	55	53	51	48	46	44	42	39	35	28						
		60	30	53	66	72	74	73	71	69	67	65	64	62	61	60	59	58	56	54	52	50	47	45	43	41	37	32	24						







Residential Water Systems

MODEL 160L

SELECTION CHART

Horsepower Range 3 - 60, Recommended Range 50 - 240 GPM, 60 Hz, 3450 RPM

Table for Pump Model 160L03, 3 HP, showing flow rates for depths from 0 to 250 feet.

Main selection chart table for models 160L05 to 160L30, providing flow rates for various pump stages and depths up to 250 feet.

Continuation of selection chart for models 160L40 to 160L60, providing flow rates for various pump stages and depths up to 1350 feet.



