

5G Antenna White Paper

New 5G, New Antenna



CONTENTS

1 5G, Gear Up for the New MBB Era	01
1.1 Unprecedented 5G Development	01
1.2 All-Band Transition to Support 5G Services	02
2 Antennas Are Key Elements of 5G Networks	04
3 All-Band Beamforming Is a Fundamental Characteristic of 5G Antennas	06
3.1 Band-Level Minimum 4T4R Configuration for 5G Antennas	06
3.2 High-Precision Beamforming Is Mandatory for 5G Antennas	07
4 Coordinated Design Is a Fundamental Attribute of 5G Antennas	08
4.1 Component-Level Collaboration Ensures 5G Network Configuration and Performance	08
4.1.1 Array Amplitude and Phase Consistency Enable High-Precision NR Beamforming	08
4.1.2 High Power Capacity and Thermal Design Meet 5G Requirements	09
4.2 Product-Level Collaboration Simplifies 5G Network Deployment	10
4.2.1 Integration Between Active and Passive Antennas	10
4.2.2 Multi-Band Ultra-Wideband Independent Control	10
4.3 Feature-Level Collaboration Facilitates Implementation of 5G Features	11
4.3.1 5G Antennas Support All-Band Calibration	11
4.3.2 5G Antennas Support Weight Management	11
4.3.3 5G Antennas Support Beam Configuration	12
5 Smart, Simplified Management Reflects the Value of 5G Antennas	13
5.1 Scenario-Specific 3D Beam Adaptation	13
5.2 Intelligent Channel Shutdown	14
5.3 High-Precision Real-Time Terminal Positioning	15
6 Summary	16
7 Acronyms and Abbreviations	17

01 | 5G, Gear Up for the New MBB Era

1.1 Unprecedented 5G Development

5G is enjoying an unprecedented development, with the user base forecast to grow to 500 million in three years, a scale that 3G and 4G took nine and six years, respectively, to achieve. 2019 is the first year of 5G scaled commercial adoption, with more than 60 5G commercial networks projected to be globally deployed. By H1 of 2019, 19 telecom carriers in 11 countries announced the launch of 5G services. Scaled commercial rollouts have already kicked off in the UK, the US, Japan, South Korea, and China.

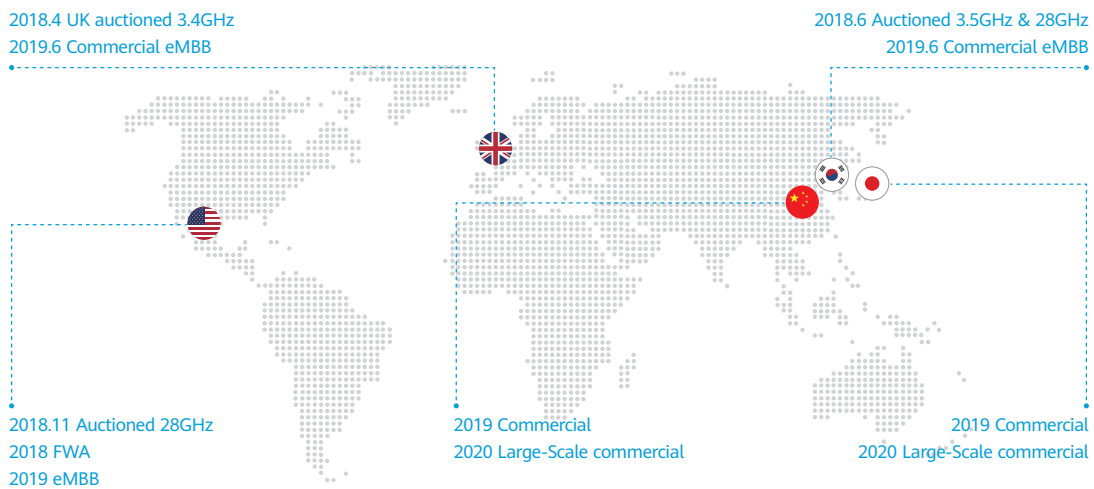

* Source: Huawei MI, 2019

Figure 1-1 Countries with scaled 5G deployments in 2019

Global 5G spectrum auctioning also signifies 5G's rapid development. By H1 of 2019, more than 30 countries auctioned 5G spectrum, with C Band in 22 countries, mmWave in 5, the 2.6 GHz band in 4, and the 700 MHz band in 3. The US, Mexico, and Canada assigned 600 MHz band. It is predicted that 5G spectrum will be auctioned in over 80 countries by 2020.

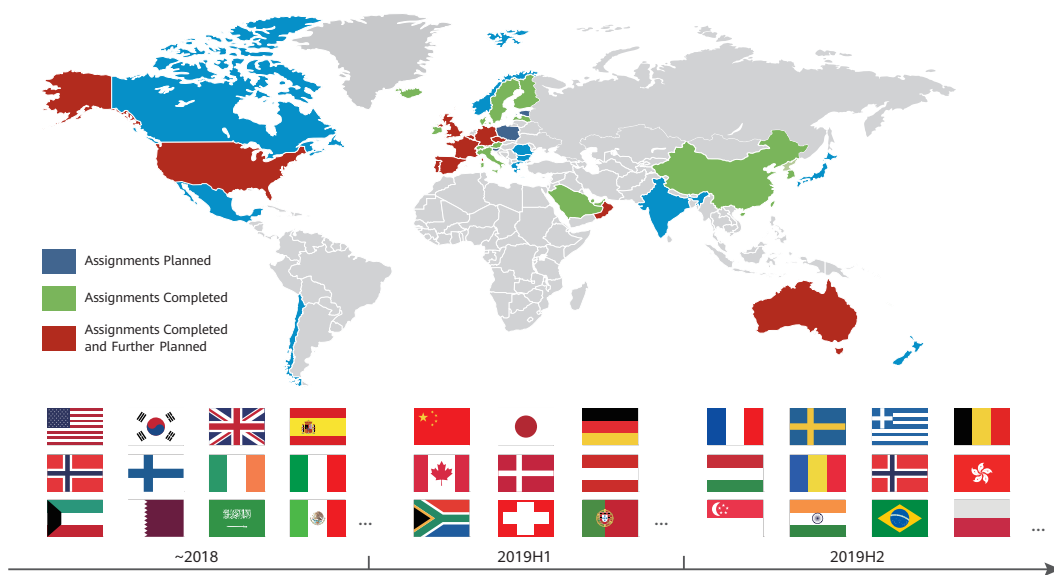

* Source: GSMA Intelligence, Apr, 2019

Figure 1-2 5G spectrum assignment from 2018 to 2019

1.2 All-Band Transition to Support 5G Services

5G provides users with a better experience and enables massive connectivity between people, between machines, and between people and machines. It supports low-latency transmissions, using which remote healthcare, VR/AR, self-driving, and other innovative services can be implemented, as illustrated in Figure 1-3.

5G services require 5G networks with 1000 times larger capacity and 10 to 100 times faster data speeds. The International Telecommunication Union (ITU) sets 1 Gbit/s as the benchmark for user-perceived peak rate, with an omnipresent perceived speed of 100 Mbit/s for outdoor places. The Next Generation Mobile Networks (NGMN) Alliance put forward a similar set of standards that include a perceived speed of above 1 Gbit/s in dense-urban areas, a ubiquitous 100 Mbit/s in urban areas, and a pervasive 50 Mbit/s in suburban areas.

5G ecosystem has seen accelerated development in maturity. By Q2 of 2019, Qualcomm, Samsung, and Huawei have all launched terminal chips that support 5G NSA, SA, and NSA-SA and the interconnection tests have been completed. Commercial terminals have been launched. Till May 2019, there are over 50 5G terminals available on the market, with the lowest price at US\$ 662. 5G networks have been commercially adopted in China, the United States, Japan, South Korea, and European countries. Forecast indicates that, by 2020, 5G smartphones will account for 20% of global smartphone shipment and the price of low-end mobile phones will be reduced to US\$ 300.

To meet data speed requirements and adapt to spectrum characteristics and terminal maturity, 5G target networks are designed to have a triple-layer structure, as illustrated in Figure 1-4.

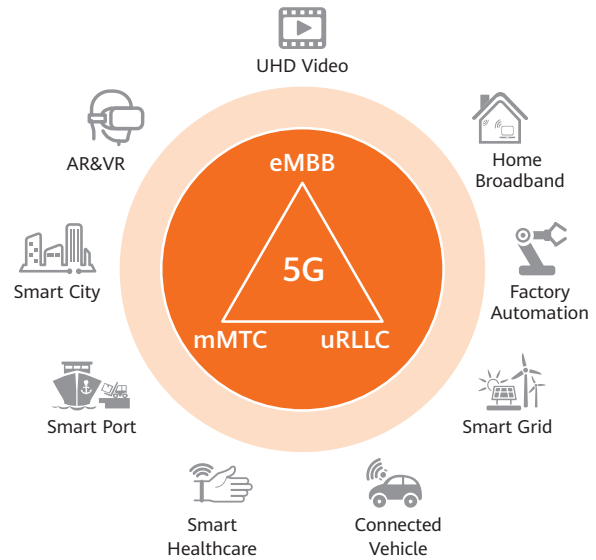
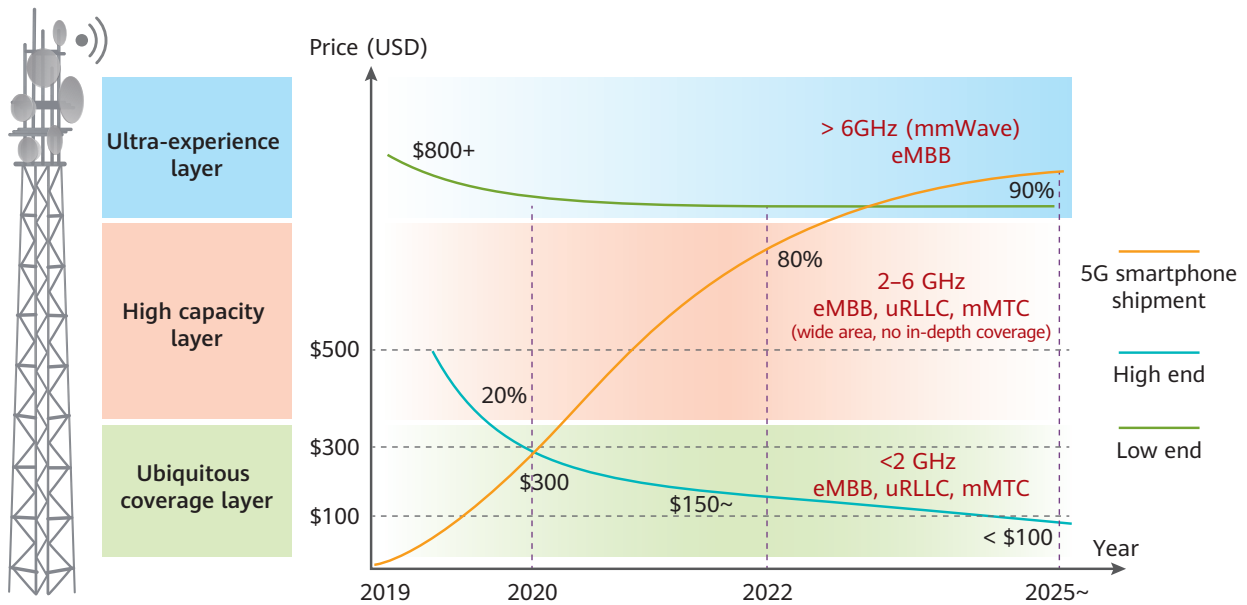

Figure 1-3 5G service models

- » Ultra-experience layer: Leverages the ultra-wide bandwidth of the mmWave spectrum to provide eMBB-needed capacity and data speeds in urban hotspots where premium experience is necessary.
- » High capacity layer: Serves to ensure wide coverage, universal 100 Mbit/s data speed in outdoor places, and massive connections through the C-band and 2.6 GHz resources (that support a 100 MHz bandwidth) and Massive MIMO technology.
- » Ubiquitous coverage layer: Implements wide and in-depth radio coverage and ensures universal connections and user experience by functioning on low and intermediate bands that have low path loss and strong penetration, such as 700 MHz and 1.8 GHz.



*Source: Huawei MI, 2019

Figure 1-4 Triple-layer structure of 5G target networks

The triple-layer structure of 5G target networks reflects 5G's development trajectory. To deliver the x Gbit/s experience, initial-stage 5G relies on the ultra-wide bandwidth of the C-band, 2.6 GHz, or mmWave resources, as well as Massive MIMO technology. Fundamental coverage is still achieved using FDD LTE and NR through EN-DC between FDD LTE and TDD NR and flexible resource sharing between LTE and NR in time and frequency domains.

With 5G applications continuously diversifying, spectral resources will be increasingly utilized to implement NR CA between FDD NR and TDD NR, allowing networks to better ensure capacity and connection needs while delivering high reliability and low latency. To adopt to growing maturity of the 5G industry chain and support the comprehensive adoption of eMBB, mMTC, and uRLLC applications, all bands will be required to implement 5G through dynamic spectrum sharing.

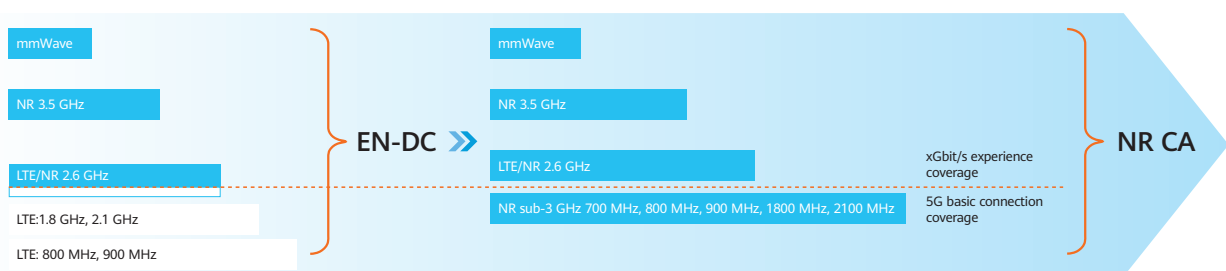

Figure 1-5 5G spectrum transition trends

02

Antennas Are Key Elements of 5G Networks

5G's accelerating growth is driving the need for all bands to implement 5G. 5G's multi-band and ultra-wide bandwidth capabilities are combined with Massive MIMO to enable 5G networks to support eight key features based on band characteristics in accordance with the triple-layer development trajectory of 5G target networks. This way, 5G applications of three major use cases can be fully supported. Figure 2-1 describes the eight key features on 5G networks.

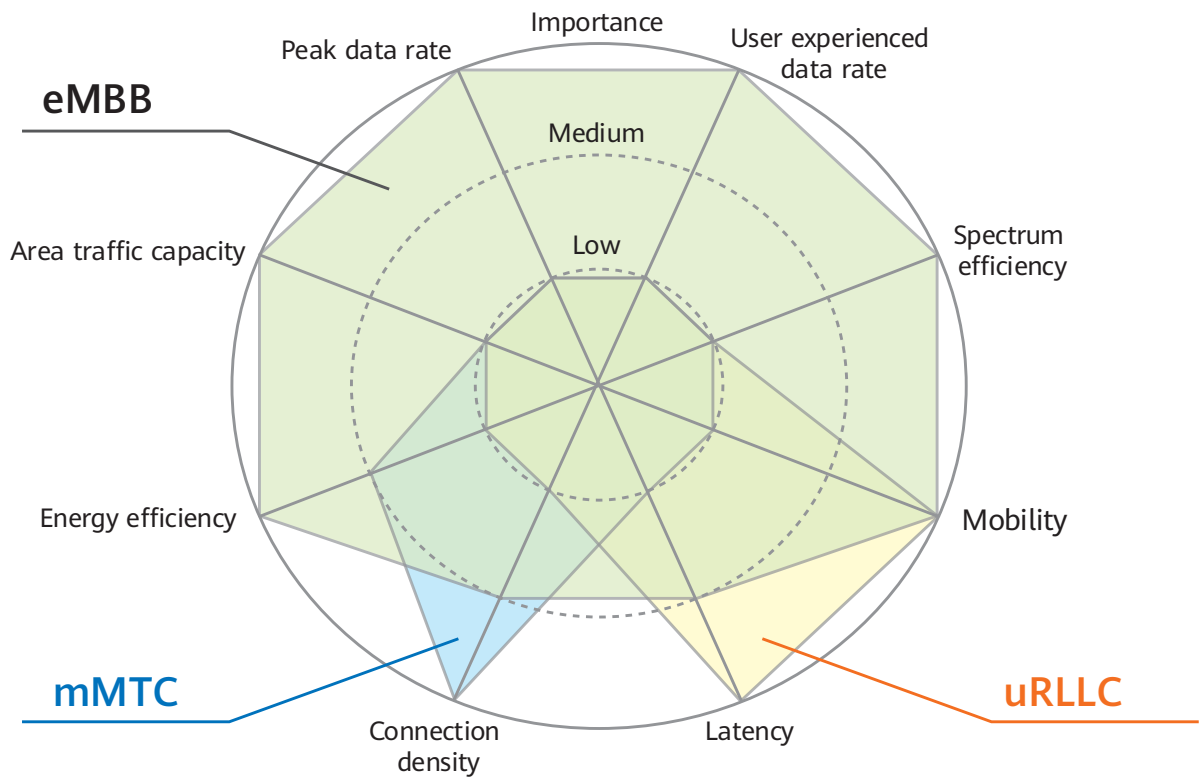

Figure 2-1 Importance of key features in diverse application scenarios



The "all-band-to-5G" transition requires antenna systems to support all bands. Considering 5G network characteristics, antennas must also flexibly adopt to diverse applications scenarios.

To achieve peak data rate and perceived data rate while meeting area traffic capacity and mobility requirements, antennas must support:

- » All-band configuration: One antenna must support the C Band and mmWave spectrum resources while enabling all sub-3 GHz bands to support 5G NTN features.
- » Precise beam coverage: Beam shapes must meet the requirements of application scenarios in the way that the beam energy is concentrated on desired areas and the interference to non-desired coverage areas is minimized.

Spectral efficiency is essential, which requires antennas to support:

- » Multi-user beamforming (MU beamforming), allowing multiple user beams to share time- and frequency-domain resources to thereby maximize 5G's spectral efficiency. This can be achieved by implementing accurate null-steering control on antennas to suppress the interference caused by resource sharing.

Power efficiency and connection density require antennas to support:

- » Radiation concentration: Antennas must support precise antenna pattern control in accordance with coverage scenarios to maximally concentrate radiated energy on desired areas.
- » Low loss: Antenna components are designed the way that the induced loss can be minimized so that the same radiation power can ensure coverage with a greater depth and width.

Unlike 3G and 4G antennas that provide coverage with fixed beam patterns and directivity, 5G antennas must support on-demand beam coverage according to applications scenarios and user distributions. 5G antennas must be able to function with RAN to support beam management so as to help deliver precise coverage in target areas while significantly suppressing interference in other areas. Antennas must evolve from plug-and-play components in 3G and 4G networks to key network elements that support flexible beam configuration and management in 5G networks. Therefore, 5G antennas will be a new type of antennas that are highly integrated, support flexible all-band configuration, and enable scenario-specific beam management.

03

All-Band Beamforming Is a Fundamental Characteristic of 5G Antennas

To deliver higher speeds, massive connections, ultra-low latency, and premium user experience, 5G networks cannot use fixed broadcast beams of 3G and 4G networks. 5G broadcast beams are a group of narrow beams of appropriate widths and varied directivity that are achieved by using beamforming technology, as illustrated in Figure 3-1. These narrow beams sweep across the target areas without leaving coverage holes in the target areas while having the minimal overlap coverage as well as the maximum RSRP and SINR. To create 5G broadcast beams with these characteristics, 5G antennas must support beamforming technology.

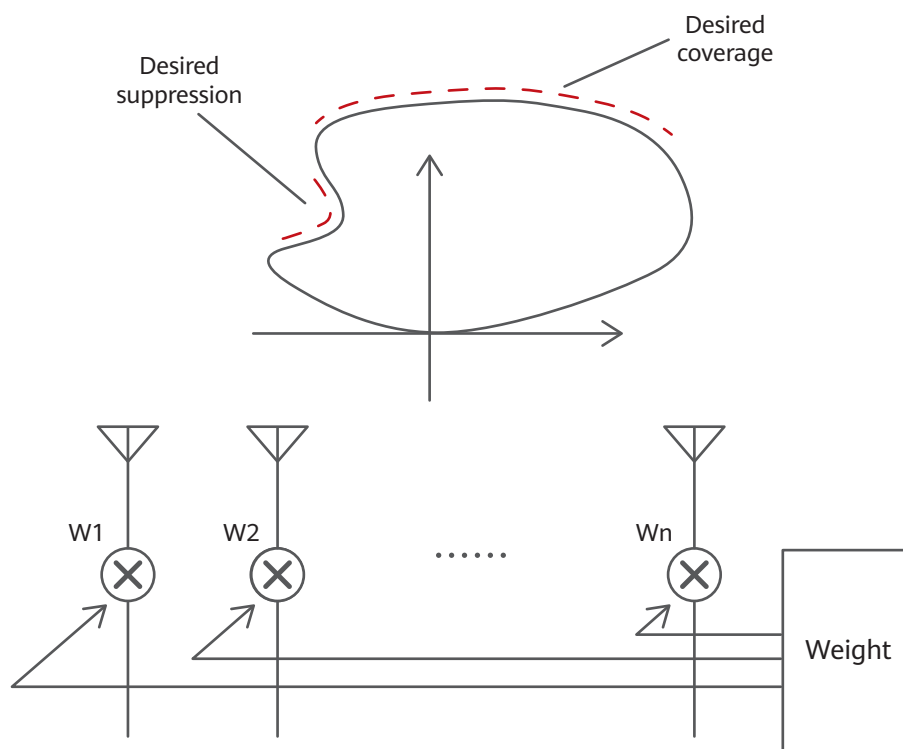

Figure 3-1 Principles of beamforming technology

With the "all-band to 5G" transition, 5G antennas must support beamforming for broadcast beams on all bands.

3.1 Band-Level Minimum 4T4R Configuration for 5G Antennas

3GPP Release 15 suggested that beamforming be used to improve 5G broadcast and traffic beam coverage, adding that the theoretical improvement can reach 3 dB. In TS 38.213, five SSB patterns are defined for 5G broadcast beams, with SSB beams capped at a maximum of four for sub-3 GHz bands and eight for 3–6 GHz bands, as illustrated in Figure 3-2. A minimum of two antenna arrays are required to generate beamforming beams. Beams with narrower widths mean more 5G broadcast beams available but require more antenna arrays. Therefore, 5G antennas have to support a minimum of two arrays on each band, meaning that they must support minimum 4T4R configuration on each band.

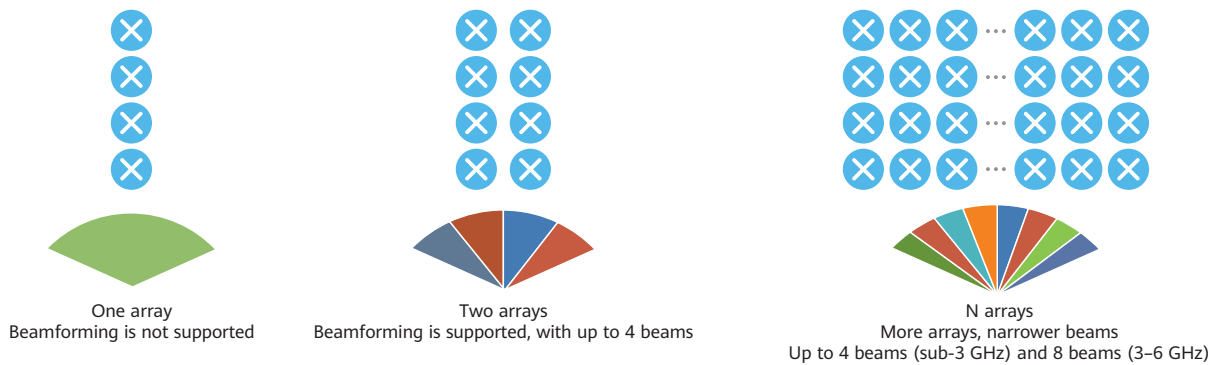

Figure 3-2 Beamforming of 5G broadcast beams

3.2 High-Precision Beamforming Is Mandatory for 5G Antennas

To ensure higher RSRP and SINR, 5G broadcast beams use beamforming to form a group of narrow beams of accurate widths and directivity. 5G traffic beams are more advanced than those for 4G and MU beamforming has become a standard function. This function requires not only accurate pointing toward multiple UEs to ensure maximal gains but also accurate null-steering to UEs. Only this way, can the UEs have maximum coverage, minimum interference, and optimal SINR, as illustrated in Figure 3-3. The accurate coverage of both 5G broadcast and traffic beams depends on beamforming. Therefore, high-precision beamforming is a mandatory feature for antennas to ensure consistent beam amplitudes and phases between antenna arrays.

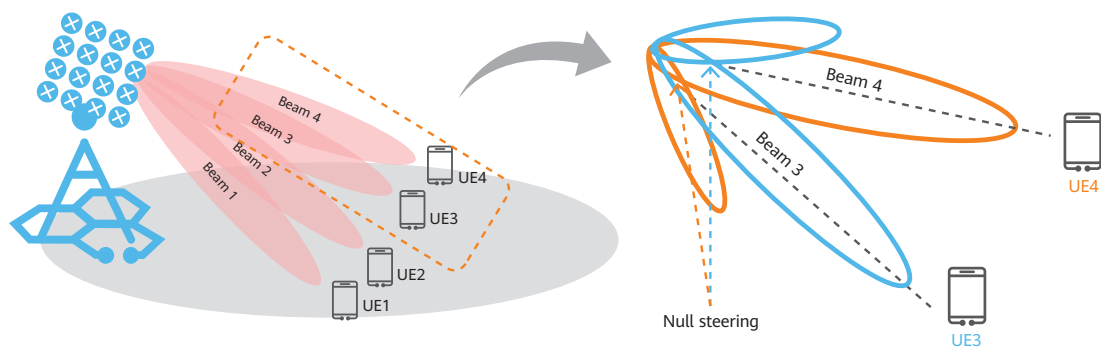

Figure 3-3 MU beamforming accurate coverage

MBB networks are transitioning to 5G target networks owing to maturing 5G industry chain, promoting the "all-band-to-5G" transition. 5G requires flexible, accurate coverage to target areas to ensure optimal user experience. Therefore, 5G antennas must:

- » Support 5G on all bands.
- » Support a minimum 4T4R configuration on a single band.
- » Support high-precision beamforming, which is a mandatory technology that requires antenna arrays to support accurate calibration and amplitude/phase consistency.

04

Coordinated Design Is a Fundamental Attribute of 5G Antennas

Coordinated design is a consistent focus of the industry. In 4G, this involves (component-level) simulation and tests that aim to maximize capacity and coverage performance through antenna pattern optimization. In 5G, RAN-antenna coordination will reach unprecedented levels. Depending on applicable object, it is categorized as component-level, product-level, and feature-level collaboration, as illustrated in Figure 4-1.

- » Component-level coordination focuses on the design and optimization of antenna elements, arrays, and feeding networks to meet 5G network configuration and performance requirements.
- » Product-level coordination focuses on the integration between active and passive antennas to improve 5G network deployment.
- » Feature-level coordination matches 5G network planning and applications with better implementation of high-precision beamforming, LTE-NR sharing, and other features.

The details of classic coordinated designs are provided in the following figure:

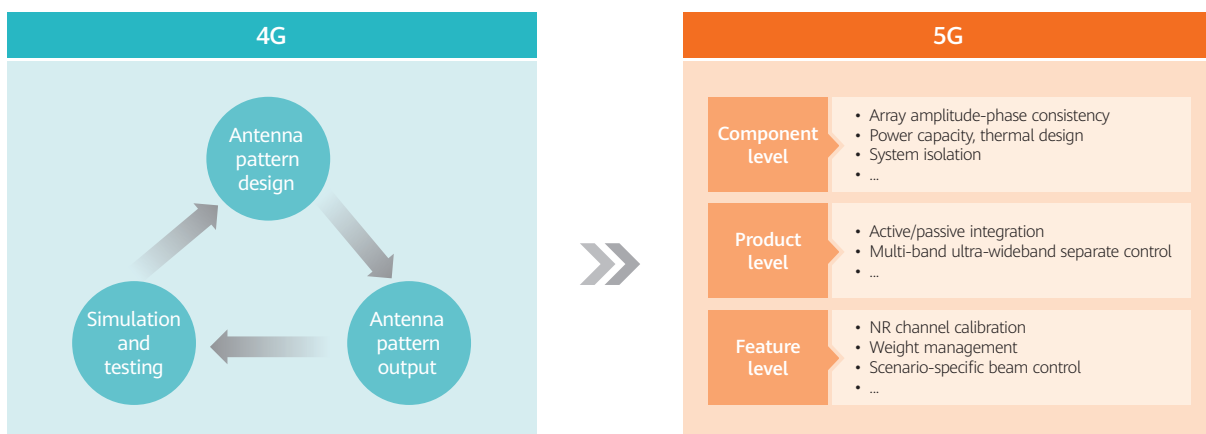

Figure 4-1 Coordinated design development between antennas and RANs

4.1 Component-Level Collaboration Ensures 5G Network Configuration and Performance

4.1.1 Array Amplitude and Phase Consistency Enable High-Precision NR Beamforming

High-precision beamforming is a key 5G network technology. The beamforming precision for 5G broadcast beams is determined by single-array beam vector and array phase difference.

- » Single-array beam vector: Determined by antenna design, which can be different among antennas possibly due to mutual coupling between antenna elements and array layout. For the same batches of antennas, phase and amplitude difference between antenna patterns exists as a result of accumulative assembly tolerance.
- » Array phase difference ($\Delta\Phi$): Determined by antenna array topologies, as illustrated in Figure 4-2, which are dependent on antenna design schemes. Array phase difference varies depending on vendors.

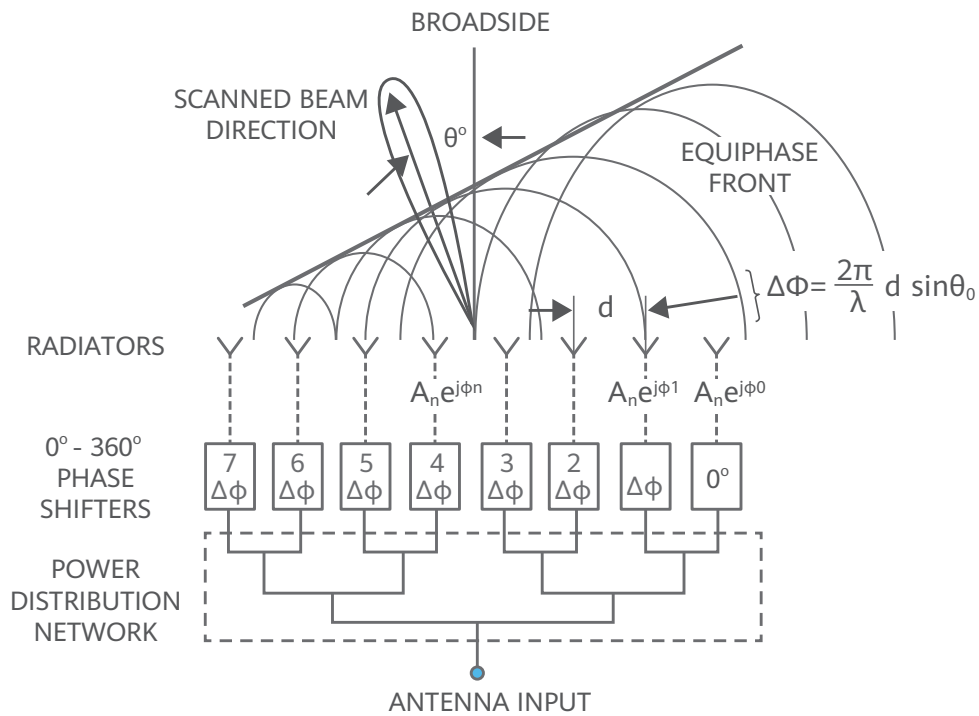

Figure 4-2 Phase difference ($\Delta\Phi$) of an array towards a radiating surface

The impact of single array beams and array spacing on beamforming precision must be considered in 5G antenna design. Antenna array vector difference recognition and compensation are necessary to ensure amplitude and phase consistency required for high-precision beamforming.

4.1.2 High Power Capacity and Thermal Design Meet 5G Requirements

Compared to 4G antennas, 5G antennas must support more bands and higher MIMO configurations. For example, power capacity and thermal design cannot be neglected when antenna arrays are upgraded from 2L4H to 2L4H + C band 8T8R or 2L4H + C band Massive MIMO. During antenna design, high power capacity and thermal design must match RAN requirements. The means to achieve this purpose includes introducing thermal-resistant materials and components, using cable-free and other designs that minimize insertion loss, and properly arranging air channels.

04 | Coordinated Design Is a Fundamental Attribute of 5G Antennas

4.2 Product-Level Collaboration Simplifies 5G Network Deployment

4.2.1 Integration Between Active and Passive Antennas

Active antennas have less on-cable loss and power loss than passive antennas, and they need less installation space and can be easily installed. Integrating Massive MIMO antennas with passive antennas further reduces installation space and shortens site acquisition time to facilitate faster rollout of 5G services.

The integration between active and passive antennas is achieved through interleaved design rather than a simple combination, further reducing the space occupied by antennas. Solutions to PIM issues, multi-system isolation, installation, and maintenance require RAN requirements to be considered during antenna design.

4.2.2 Multi-Band Ultra-Wideband Independent Control

The growing popularity of multi-band ultra-wideband RF modules is leading to new challenges regarding the independent optimization on the basis of per band and mode. Figure 4-3 illustrates how it is necessary to set separate band-level separate downtilt angles to solve the performance difference between bands in different modes. To ensure optimal performance on each band, 5G antennas must meet the new requirements of band-level separate control between antenna ports through RAN-antenna coordination.

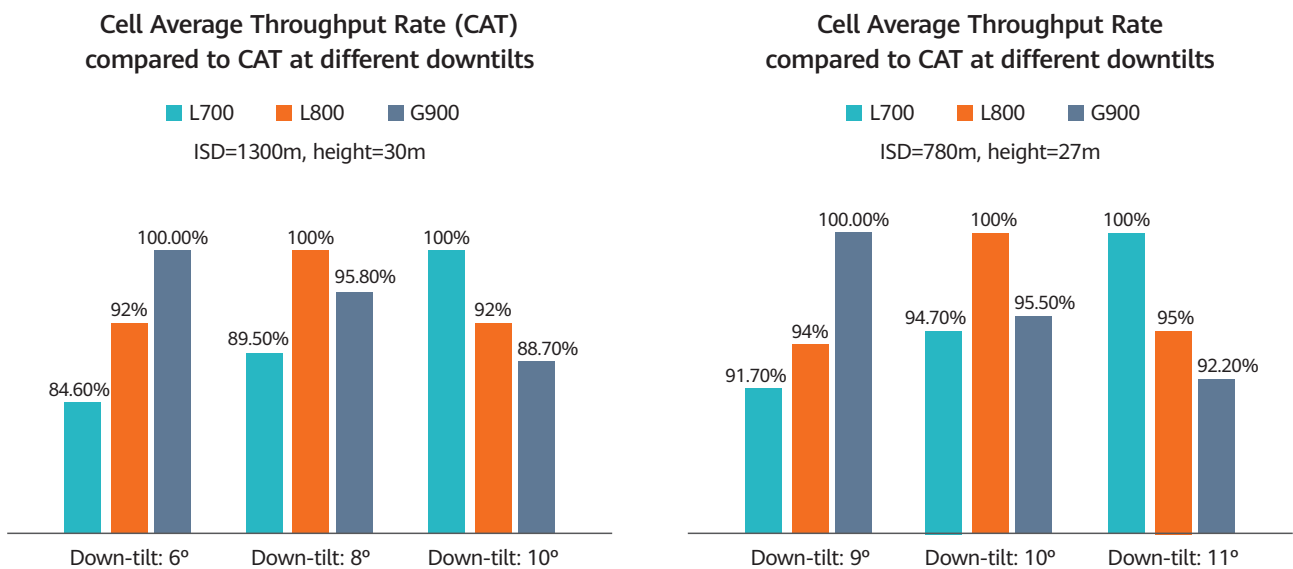

Figure 4-3 Test of proper downtilt of low band



4.3 Feature-Level Collaboration Facilitates Implementation of 5G Features

4.3.1 5G Antennas Support All-Band Calibration

In 4G, applications are MIMO prioritized and beamforming is optional. In 5G, beamforming is a basic capability for all bands, making all-band calibration a fundamental requirement.

For radio links, phase difference occurs as a baseband-configured weight assignment travels on RRUs, jumpers, and other devices before it reaches the antenna and as a result of accumulative tolerance of components and assembly. High-precision beamforming requires phase difference to be eliminated or measured, for which phase calibration for both RRU-antenna links and inside antennas must be used. Figure 4-4 illustrates how E2E calibration enables high-precision beamforming by accurately tuning phases for network links.

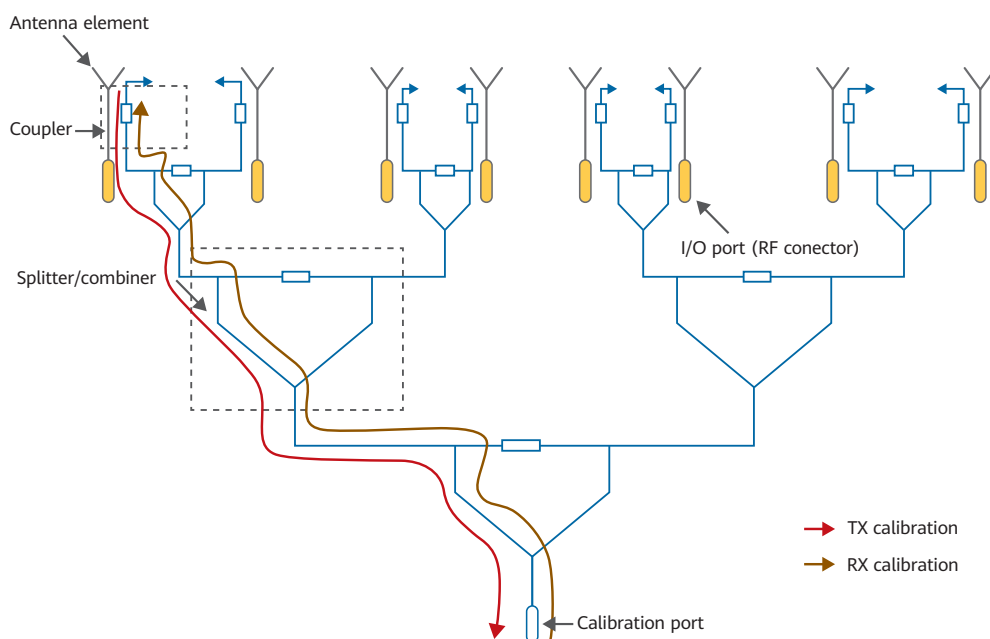

Figure 4-4 E2E calibration on a wireless network equipment

4.3.2 5G Antennas Support Weight Management

4G TDD 8T8R networks already apply weight management, and Figure 4-5 shows how it functions. Antenna suppliers store weight values in antennas and the equipment automatically fetches the weight values and configures them for the antennas. This solution, which has already been implemented by some telecom carriers, improves the accuracy and efficiency of weight configuration.

The all-band beamforming requirement of 5G makes weight management a basic standard. Weight management improves weight configuration efficiency and adaptability to optimal weight assignment of antennas, better ensuring beamforming accuracy. In addition, beam control and configuration are possible with weight management.

04 | Coordinated Design Is a Fundamental Attribute of 5G Antennas

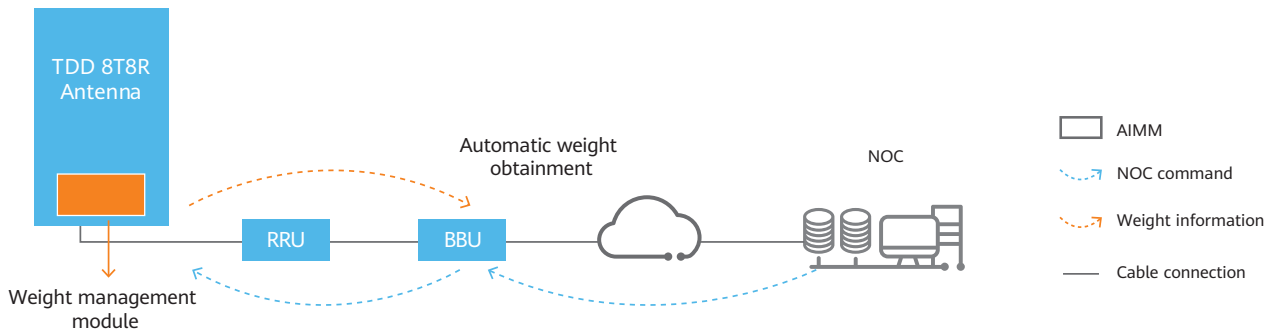

Figure 4-5 Weight management of 4G TDD 8T8R networks

4.3.3 5G Antennas Support Beam Configuration

In 3G and 4G, horizontal beam width is fixed at 65°, 90°, or 33° for antennas based on the empirical values of typical scenarios, from which telecom carriers select an appropriate one to ensure desired beam widths. To improve coverage accuracy and network capacity in 5G, antennas must be able to implement flexible beam configuration through beamforming technology in accordance with application scenarios to ensure precise coverage. Narrow beams with specific directivity are necessary for tunnels and highways, whereas wide beams are more suitable for seaside areas. In special scenarios, beams with special envelopes are required.

More complex beam shapes have higher requirements for baseband algorithms and phase control and require more resources to handle, yet generally producing unsatisfactory beam shapes. With antenna-RAN collaboration, RAN uses the beam weight assignments that are stored in antennas to help achieve desired beam shapes, as illustrated in Figure 4-6. This ensures accurate coverage in special cases and reduces resources needed.

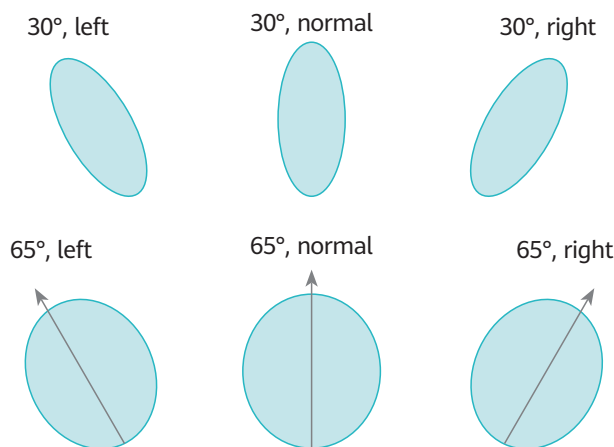

Figure 4-6 Beam shape adjustment

05 | Smart, Simplified Management Reflects the Value of 5G Antennas

5G's scaled deployment adds growing complexity to mobile cellular networks. Telecom carriers face greater challenges with regard to equipment deployment, network configuration, parameter optimization, and device management.

- » The coexistence of 2G, 3G, 4G, and 5G involving high, intermediate, and low bands in both FDD and TDD modes further complicates networking topologies.
- » The increasing number of physical sites and the simultaneous existence of macro, micro, and backhaul sites further complicate site structures.
- » Network KPIs are proliferated and network slices carry vastly different service preferences that suit various requirements. For example, B2C and B2H prioritize data speeds and coverage, while B2H prioritizes low latency, high reliability, and high positioning accuracy.
- » Energy efficiency will be a more urgent issue for networks, making time-based on-demand energy saving more necessary.

To address these 5G MBB challenges, networks must support AI-based operations and maintenance, which is a change that antenna systems must adapt to.

5.1 Scenario-Specific 3D Beam Adaptation

AI-based operations and maintenance leads to a transition from 4G's network element management to 5G's scenario-oriented management and increases the need for intelligent simulation, planning, and dynamic optimization. This requires antennas to support beam visibility and adjustment on the network operations center.

In the example illustrated in Figure 5-1, the network automatically recognizes scenarios and configures beams through AI-based operations and maintenance. The antennas generate differentiated beams of various widths and directions based on the beam configurations, improving user experience for the scenarios. For example, wide vertical beams are needed for buildings, whereas narrow beams with specific directivity are mandatory for highways. In irregular coverage areas, beams must vary according to target direction.

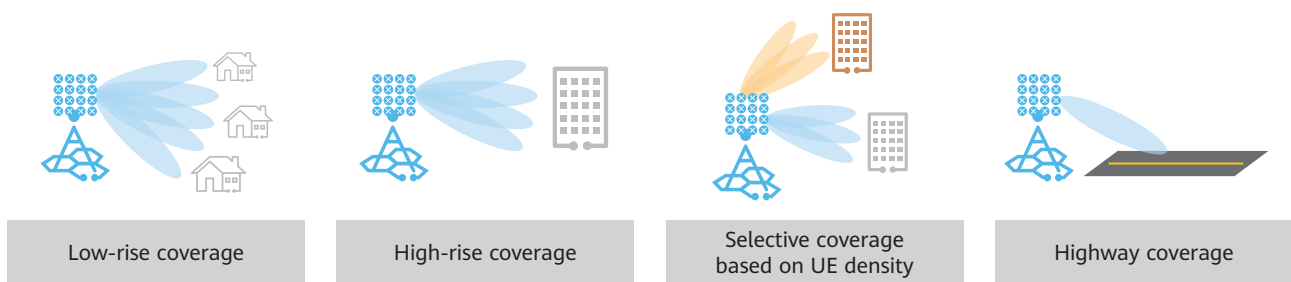

Figure 5-1 Beams for typical coverage scenarios

In addition to vertical adjustments through electrical downtilts in 4G, 5G must enable the network operations center to support the flexible adjustment of beam azimuth and width, which is referred to as scenario-specific 3D beam adjustment, as illustrated in Figure 5-2. This enables the manual-to-AI operations and maintenance transition, thereby improving efficiency and reducing OPEX.

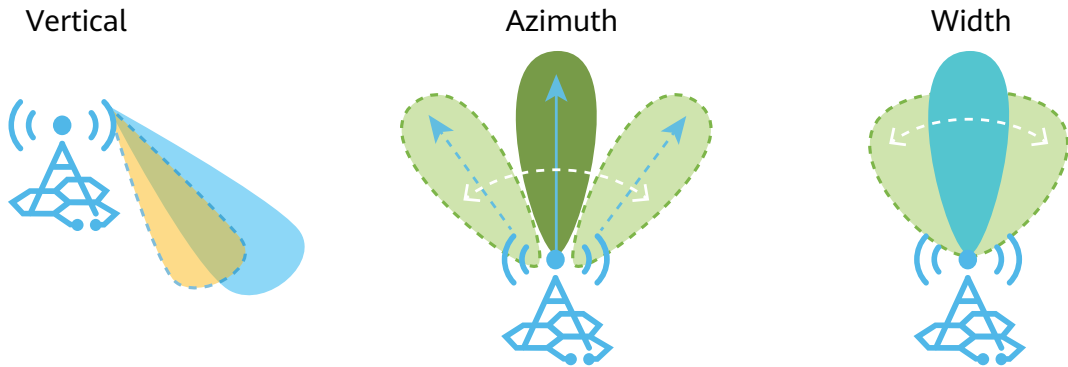

Figure 5-2 Scenario-specific 3D beam adjustment

5.2 Intelligent Channel Shutdown

Energy conservation is an important aim of 5G networks, and service-based dynamic port shutdown is essential for achieving this. Channel shutdown on RF units requires antennas that support intelligent channel shutdown. Specifically, antennas must change their working status based on RF channel switch status, thereby ensuring optimal coverage in real time.

Channel shutdown on RF units may stop some antenna elements from participating in beamforming, which results in SSB waveforms changes and negatively impacts the coverage of control channels, causing instabilities to network topologies. 5G antennas solve this problem through channel shutdown weight management. Figure 5-3 illustrates how this is implemented. In normal cases (left), each RF channel of a 5G antenna drives an antenna element, and the broadcast channel has 64 weight assignments. After energy conservation takes effect on RF units, eight channels corresponding to the white antenna elements (right) are shut down. The antenna detects the quantity and positions of the shutdown channels, then reassigns the broadcast channel's beam weights for the remaining 56 active elements to avoid a negative impact on network coverage.

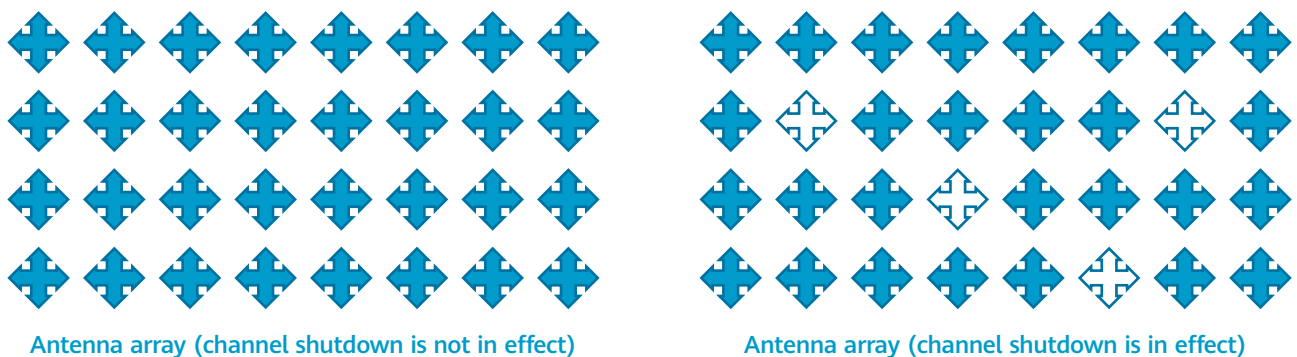

Figure 5-3 Channel shutdown for antenna arrays

Automatic service-based dynamic port shutdown facilitates network energy conservation while minimizing performance loss. To achieve this, antennas must support intelligent channel shutdown.



5.3 High-Precision Real-Time Terminal Positioning

mMTC is one of the three major use cases of 5G. As the 5G industry matures, the number of IoT terminals will significantly increase on 5G networks. In most cases, wired power supply is no longer applicable, which increases the importance of low power consumption. With a high power consumption, GPS positioning does not suit the positioning of IoT terminals. Commonly used in 4G, location-based service (LBS) is only capable of a positioning precision of greater than 10 meters, far falling short of the precision requirements for IoT terminals. 5G antennas will be helpful in solving this problem.

For signals reaching terminals, 5G antennas use beamforming technology to obtain their angles of arrival (AOA), including angles of the signals relative to antenna's boresight. Based on high-precision measurement results of azimuth, latitude and longitude data, and heights above sea level, they convert the AOAs to the AOAs relative to absolute geographical coordinates.

Figure 5-4 illustrates how positioning that involves three base stations is implemented in 4G and 5G networks. In 4G, base stations estimate the distances d_1 , d_2 , and d_3 from the UE to base stations 1, 2, and 3, respectively, based on TA and path loss, and calculate the UE's position by combining the GPS information of the three base stations. In 5G, base stations determine the distances d_1 , d_2 , and d_3 from the UE to base stations 1, 2, and 3, respectively. Antennas use beamforming technology to obtain AOAs a_1 , a_2 , and a_3 relative to antenna's boresight for the UE. The network calculates the UE's position based on the distances, AOAs, and the GPS information and high-precision engineering parameters of the three base stations. The precision is comparable to GPS's meter-level positioning, adding extra support for developing mMTC applications.

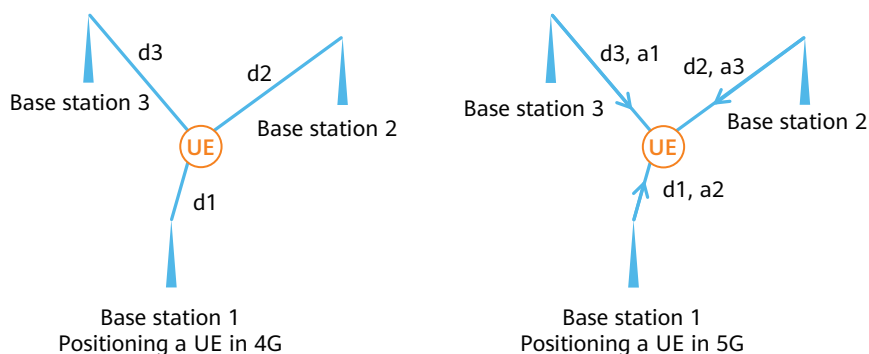

Figure 5-4 High-precision positioning that involves three base stations in 4G and 5G

These are the typical applications that 5G antennas can support when facilitated by AI-powered operations and maintenance. Antennas will become more intelligent and help simplify operations and maintenance. Instead being "black boxes that are invisible to network operations centers" in 4G, antennas will become basic network elements that enable network operations centers to achieve AI-powered operations and maintenance in 5G.



Figure 5-5 System diagram of a 5G network



06

Summary

5G applications and technologies transform MBB to eMBB for ubiquitous ultra-fast experience, enable massive machine-type communications, and empower network applications that require ultra-high reliability and ultra-low latency. Antennas are evolving from a key component in 3G and 4G into an essential network element in 5G networks where antennas must be configurable, controllable, and manageable. These trends require antennas to support the following features:

- » Adaptation to 5G-oriented network transition
- » Support for flexible coordination with other equipment
- » Support for intelligent network applications

07 | Acronyms and Abbreviations

AOA	Angle of Arrival
AR	Augmented Reality
AIMM	Antenna Information Management Module
BBU	Baseband Unit
CA	Carrier Aggregation
eMBB	Enhanced Mobile Broadband
EN-DC	E-UTRA-NR Dual Connectivity
E2E	End to End
FWA	Fixed Wireless Access
FDD	Frequency Division Duplex
ITU	International Telecommunication Union
LBS	Location Based Service
mMTC	Massive Machine-Type Communications
MBB	Mobile Broadband
MIMO	Multiple-input Multiple-output
MU-Beamforming	Multi-user Beamforming
NR	New Ratio
NGMN	Next Generation Mobile Network
NSA	Non-standalone
OMC	Operation and Maintenance Center
OPEX	Operating Expense
PIM	Passive Intermodulation
RSRP	Reference Signal Received Power
RAN	Radio Access Network
RRU	Remote Radio Unit
SSB	Synchronization Signal and PBCH Block
SINR	Signal to Interference plus Noise Ratio
SA	Standalone Architecture
TDD	Time Division Duplex
TA	Timing Advance
uRLLC	Ultra-reliable Low-latency Communication
UE	User Equipment
3GPP	3rd Generation Partnership Project



HUAWEI TECHNOLOGIES CO., LTD.

Huawei Industrial Base
Bantian Longgang
Shenzhen 518129, P. R. China
Tel: +86-755-28780808
www.huawei.com

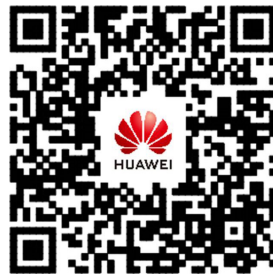
Scan the QR code to
download more technical white papers



Trademark Notice

 HUAWEI, HUAWEI,  are trademarks or registered trademarks of Huawei Technologies Co.,Ltd.
Other Trademarks, product, service and company names mentioned are the property of their respective owners.

General Disclaimer

The information in this document may contain predictive statement including, without limitation, statements regarding the future financial and operating results, future product portfolios, new technologies, etc. There are a number of factors that could cause actual results and developments to differ materially from those expressed or implied in the predictive statements. Therefore, such information is provided for reference purpose only and constitutes neither an offer nor an acceptance. Huawei may change the information at any time without notice.

Copyright © 2019 HUAWEI TECHNOLOGIES CO., LTD. All Rights Reserved.

No part of this document may be reproduced or transmitted in any form or by any means without prior written consent of Huawei Technologies Co.,Ltd.