

ATRA WEBINAR

6L50-6L80-6L90 Updates and Product Issues



**Presented by:
Steve Garrett
ATRA Presenter**



6L50

TCC Noise and/or Vibration

Cadillac DTS may exhibit a “BOOM, VIBRATION, or NOISE” when TCC is applied. The cause generally is engine firing pulses that are being transmitted through the drive train. Updated calibration has been released raising the TCC apply speed approximately 10 mph.

<http://tis2web.service.gm.com>

 Service and Parts Operations

To obtain the latest electronic controller calibration information for your vehicle, enter the vehicle's 17 character Vehicle Identification Number (VIN) and select 'Get CAL ID'.

To obtain the Calibration Verification Number (CVN) for any calibration part number, enter the part number of the calibration ID and select 'Get CVN.'

VIN:

Part Number:

Customer may notice a decrease in fuel economy

 Visit the General Motors site to see the entire GM family of brands.



General Motors Corporation 2003. All rights Reserved.

GM, the GM Emblem, Buick, the Buick Emblem, Chevrolet, the Chevrolet Emblem, Cadillac, the Cadillac Emblem, Geo, the Geo grille Emblem, GMC, the GMC Emblem, Oldsmobile, the Oldsmobile Emblem, Pontiac, the Pontiac Emblem, Saturn, the Saturn Emblem, and Chevy, are trademarks of the General Motors Corporation. Material contained in this site pertains to products and services for the U.S. market only. The information contained herein is designed to be as comprehensive and factual as possible. General Motors reserves the right, however, to make changes at any time, without notice. All rights reserved.

[Click here to view GM Privacy Policy.](#)

The TIS software application does not support the use of the browser's Forward and Back buttons. Errors will occur. Please only use the buttons that are displayed on the application screens and not on the toolbar.

6L50 Low/Rev 2-6 Clutch Snap Ring update

Clutch Backing Plate Retaining Ring Specifications (6L50)

Clutch Pack Travel Specification—1.65-2.33 mm (0.065-0.092 in)

- 1.98-2.08 mm 0.078-0.082 in Orange
- 2.28-2.38 mm 0.090-0.094 in Yellow Stripe
- 2.58-2.68 mm 0.102-0.106 in Light Blue Stripe
- 2.88-2.98 mm 0.113-0.117 in Purple Stripe
- 3.18-3.28 mm 0.125-0.129 in Green

6L50 - UPDATE

Delayed Engagement, Reverse Drain Down N-R – P-R Delay

3-5-Reverse Clutch Piston Capacity Reduction - SOP 2008 model year. Oil capacity was reduced by 20% for the 1-2-3-4/3-5-R clutches. This update limits the volume of oil required to stroke the piston. TCM Calibration was also changed due to this reduction of oil.

New Part Numbers:

2006-07

- 24234213 – Reverse Clutch Piston
- 24248576 – Seal Kit 1-2-3-4/3-5-R Drum (Car)
- 24248578 - Seal Kit 1-2-3-4/3-5-R Drum (Truck)

2008-09

- 24238696 – 3-5-R Clutch Piston
- 24238700 – 1-2-3-4 Clutch Piston
- 24243898 – 1-2-3-4/3-4-R Drum

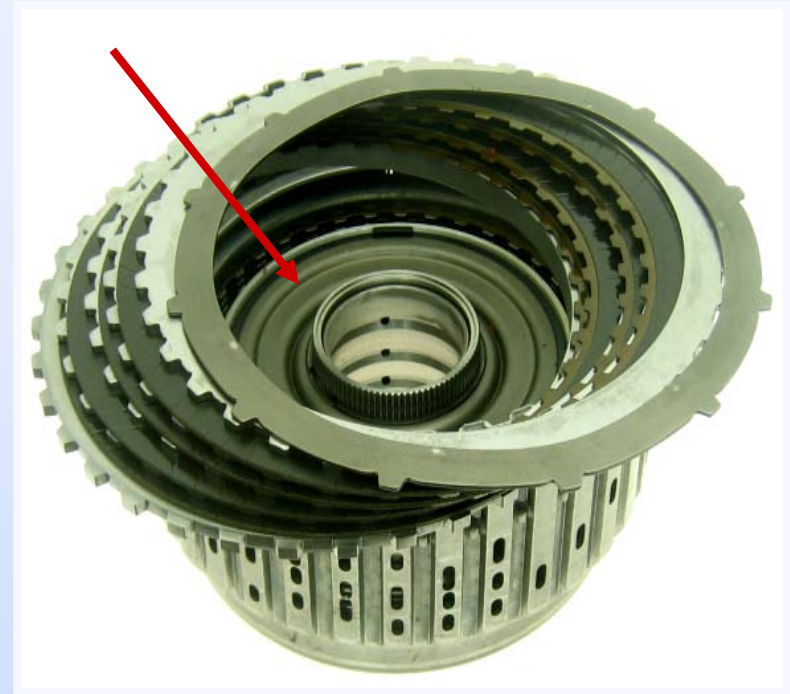

Note: Will NOT back service previous model years

6L45/50 AWD Applications

Grinding Noise, No FWD, No REV

2007-2010 Cadillac (RPO MYB) STS, SRX, CTS

The splines of the transmission output shaft or transfer case input shaft may be worn (rusted) or the shaft may have broke. The splines of the transmission output shaft have been updated with a groove for a O-Ring to help maintain the grease located between the transfer case input shaft and the transmission output shaft. Updated shafts require that “both the output shaft and input shaft be replaced as a set”.

**Most Common Cause
Is Rusted Splines**

Note:
If the splines of the
output shaft look ok,
use 2 o-rings GM#
24251228 along with
high temperature wheel
bearing grease during
assembly.

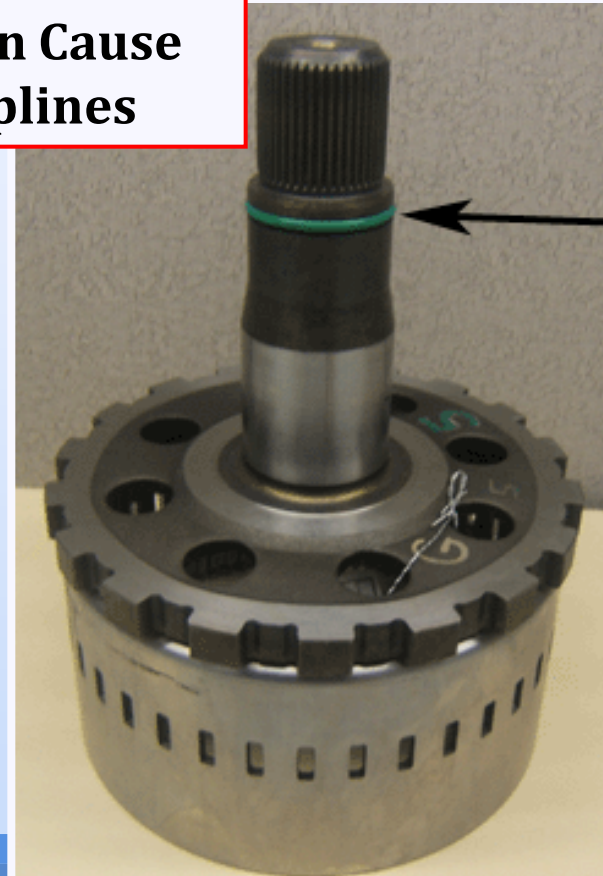

6L45/50 AWD Applications

Grinding Noise, No FWD, No REV

2007-2010 Cadillac (RPO MYB) STS, SRX, CTS (continued)

There were two other updates also made to the transmission output shaft. The hardening process was extended into the fillet radius (where output shaft usually breaks) and the design of the fillet changed to reduce the stress on that area of the shaft.

Updated Part #s

Transmission Output Shaft

(MYB-6L50) - 24251229

(MYA-6L45) - 96043341

Transfer Case Input Shaft

(CTS) - 19256369

(STS, SRX) - 19256370

(O-Rings) - 24251228



Small Fillet



Increased Fillet

Note:
Make sure the dowels are properly position during assembly, and make sure to use the proper lubrication on the shaft splilnes

6L80/6L90 (MYC, MYD)

1-2-3-4 Slip Condition, Possible No movement Forward

CONCERN: 6L80/6L90 (RPO MYC, MYD) applications built before June of 2010 may exhibit a slip condition related to the operation of the 1-2-3-4 clutch. This condition may be present in more than one forward gear or if the condition is bad enough, it may result in a no movement forward condition.

CAUSE: The 1-2-3-4 piston may be broken or cracked

CORRECTION: Replace the piston with the new design, The updated piston has 22% more rib area when compared to the previous design piston. The updated piston is sold under part number 24258159

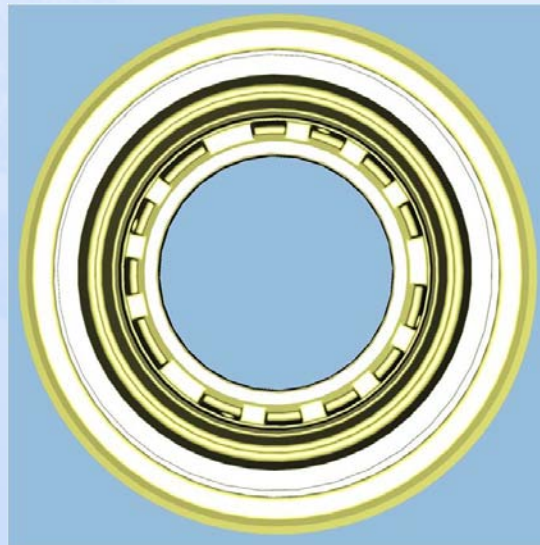

6L80 - UPDATE

No Forward Movement

1-2-3-4/3-5-R Clutch Housing was updated mid 2007 to address a NO FORWARD condition. The root cause is the snap ring popping out of the housing. The housing has been updated to prevent this. Additionally the 3-5-R waved plate was updated from 12 to 18 teeth and the 1-2-3-4 wave plate was updated from 9 to 18 teeth.

New Part Numbers:

- 24239828 – 3-5-R 18 tooth wave plate
- 24239615 – 1-2-3-4 18 tooth wave plate
- 24240194
- 24240201 – Selective Snap Rings
- 24241232 – Clutch housing Kit
(Includes Housing and Snap Rings)

Note: Will back service previous model years

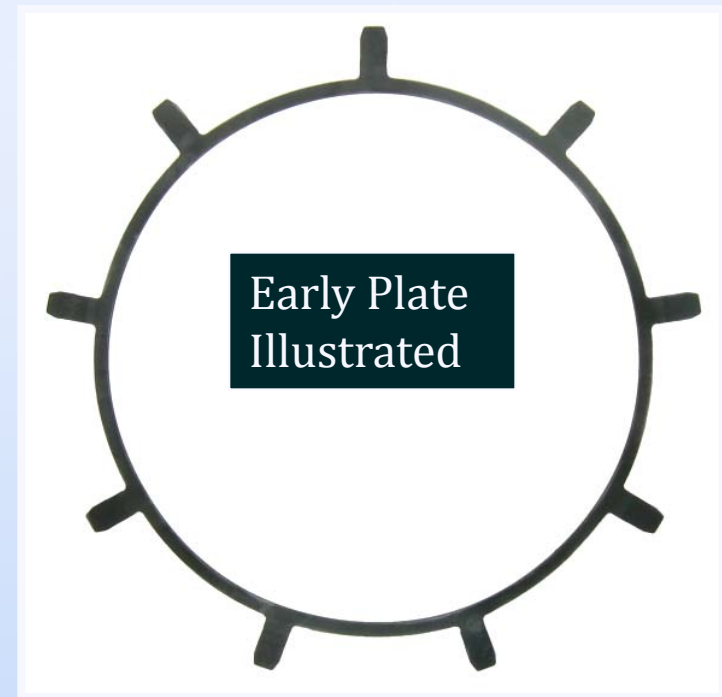

6L80 - UPDATE

No Forward Movement

1-2-3-4/3-5-R Clutch Housing

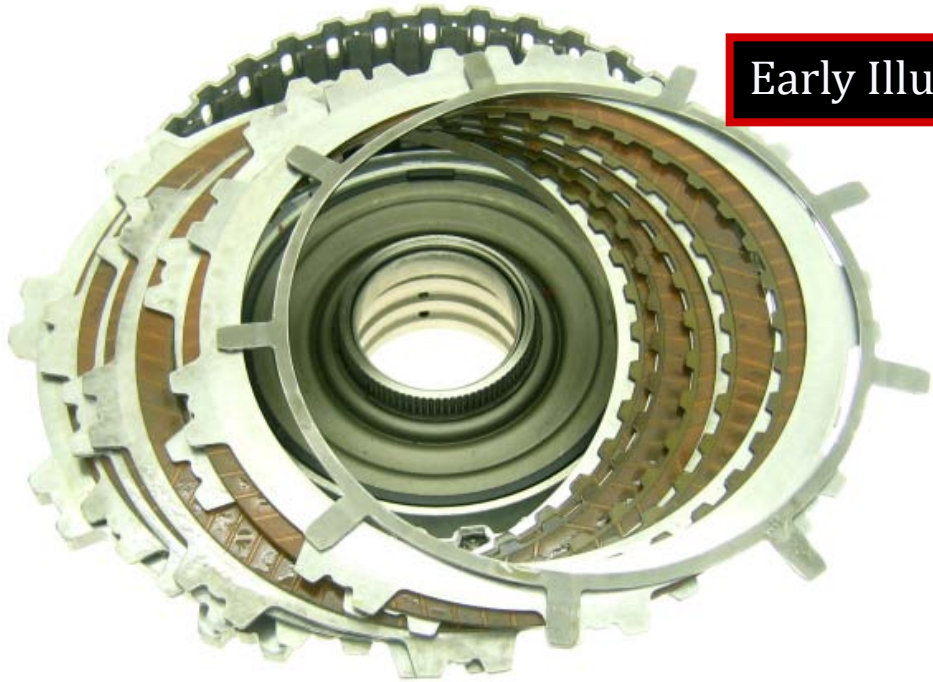

Early Illustration

1-2-3-4 Clutch



3-5-Reverse Clutch

6L80 - UPDATE

Clutch Shudder Condition

Low/Reverse Clutch Plates – Friction update was done to improve the Low/Reverse clutch apply (Shudder Complaint). Along with the frictions, a calibration update is needed when back servicing units

New Part Number:

- 24235460 – Clutch Plate



Note: Will back service previous model years

6L80 - UPDATE

Ticking and/or Rattling Noise

2-6 Clutch Friction Material – Friction design was changed from the X pattern to a radial groove to prevent the plates from rattling.

New Part Number:

- 24240221 – Clutch Plate

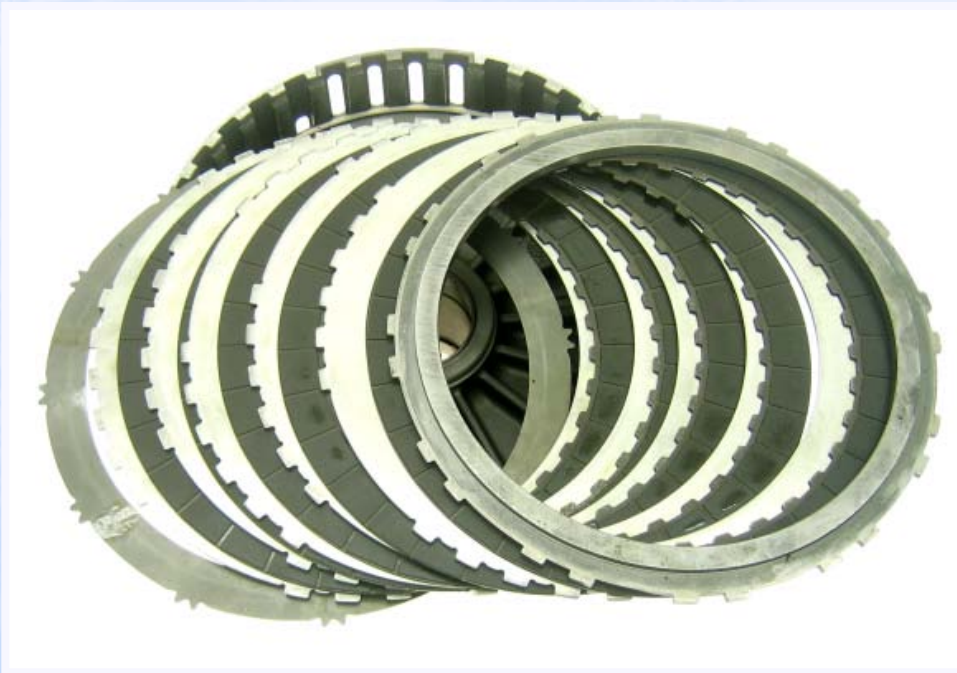

Note: Will back service previous model years

6L80 6L90 - UPDATE

DTC P1875

IMS Out of Range – IMS mid 2007, interim 2007 update. Oxidation was forming on the contacts leading to contact resistance. The updated IMS added additional nickel plating to the contacts and changed the lead frame to stainless steel to reduce the contact resistance.

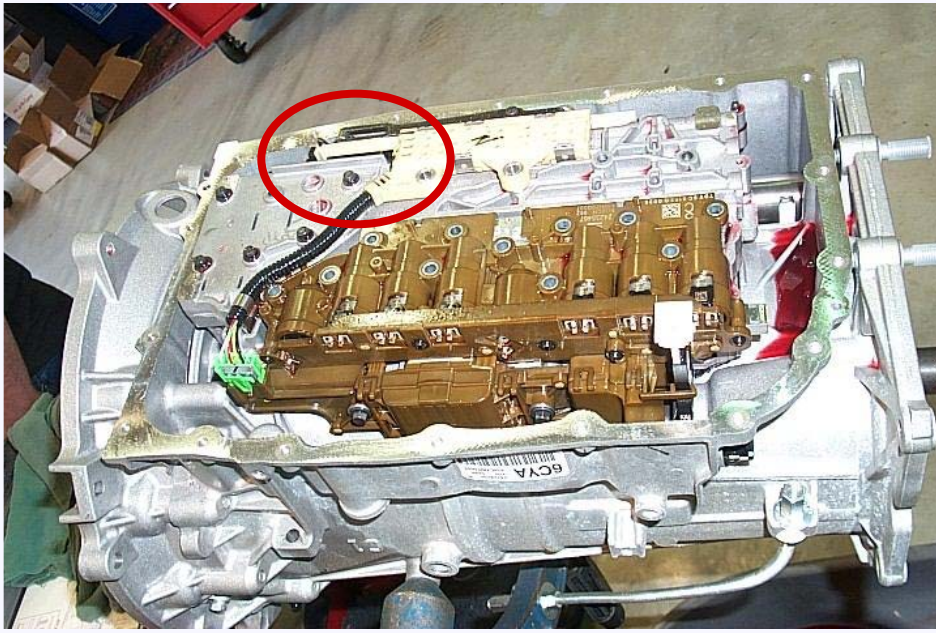

New Part Number:

- 24246427- IMS

Note: Will back service previous model years

6L80 - UPDATE

Low Sprag Update

The Low Sprag was updated as a mid 2007, interim 2007 change. Additional elements were added ,from 30 elements to 38 elements for greater holding strength. Oil hole positions changed,

New Part Number:

- 24248957- Low Sprag

Note: Will back service previous model years



6L80/6L90 (MYC, MYD)

Unigear Planetary Design Change, Speed Sensor Design Change 2012

UPDATE:

An update to the 6L80 and 6L90 (RPO MYC, MYD) transmission output ring gear and output shafts began to enter production starting with the March 2012 applications. All 6L80/6L90 transmissions will utilize the new design by the end of 2012. Known as a “UNIGEAR” design, the updated parts will incorporate the output ring gear and the output shaft into one assembly. The update was incorporated as a cost reduction measure and had nothing to do with durability. The new design will backservice the previous design applications as long as the speed sensor is replaced with it. The updated speed sensor is a different height because of the design of the unigear.

6L80/6L90 (MYC, MYD)

Unigear Planetary Design Change, Speed Sensor Design Change 2012

NOTE: If the previous design sensor is used with the Unigear design assembly damage to the sensor WILL occur and DTCs' will result as a result of the sensor damage. If the new design sensor is used with the previous design planetary/output shaft components Speed Sensor DTC's will result, as the air gap will be too wide.

The speed sensors are available separately by ordering one of the following part numbers

24265535 Previous design sensor 6L80/6L90

24265536 Updated Unigear design compatible speed sensor 6L80/6L90

The unigear assembly is available in a kit which also includes the new design sensor. Several part numbers are available for the kits depending on the length of the output shaft and the shaft spine count. To determine which Unigear or kit is required for you application, you will need to provide your VIN code to your parts person as the parts are VIN specific.

Unigear update

No Fill In Material

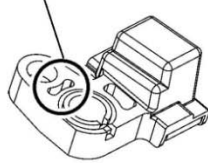

Fill In Material

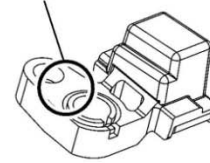

No Offset Step

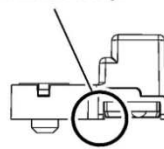

Offset Step

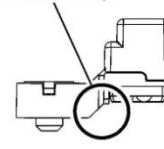

Output Speed Sensor
Current Design

Output Speed Sensor
New Design

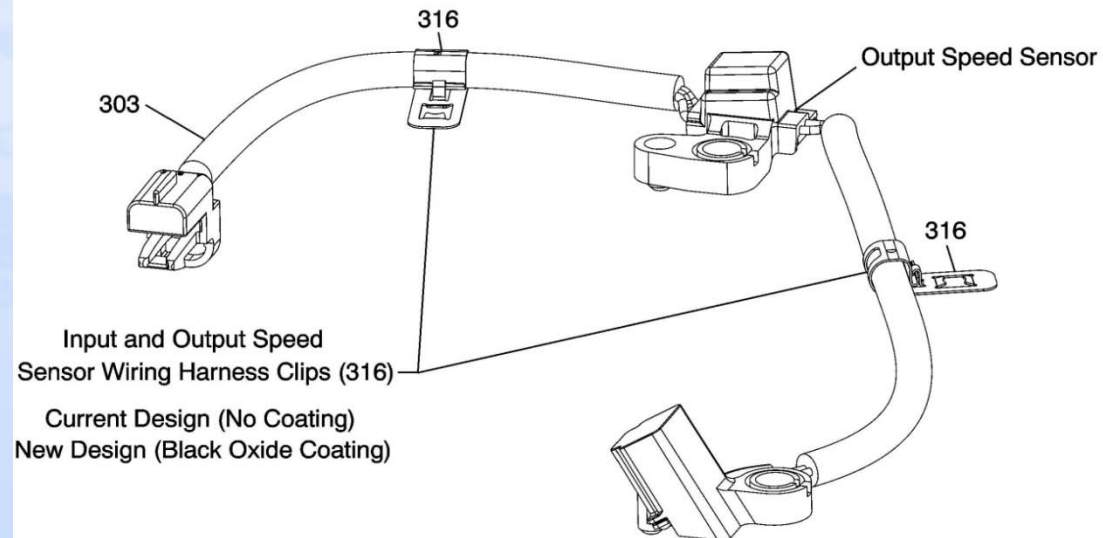

Unigear update

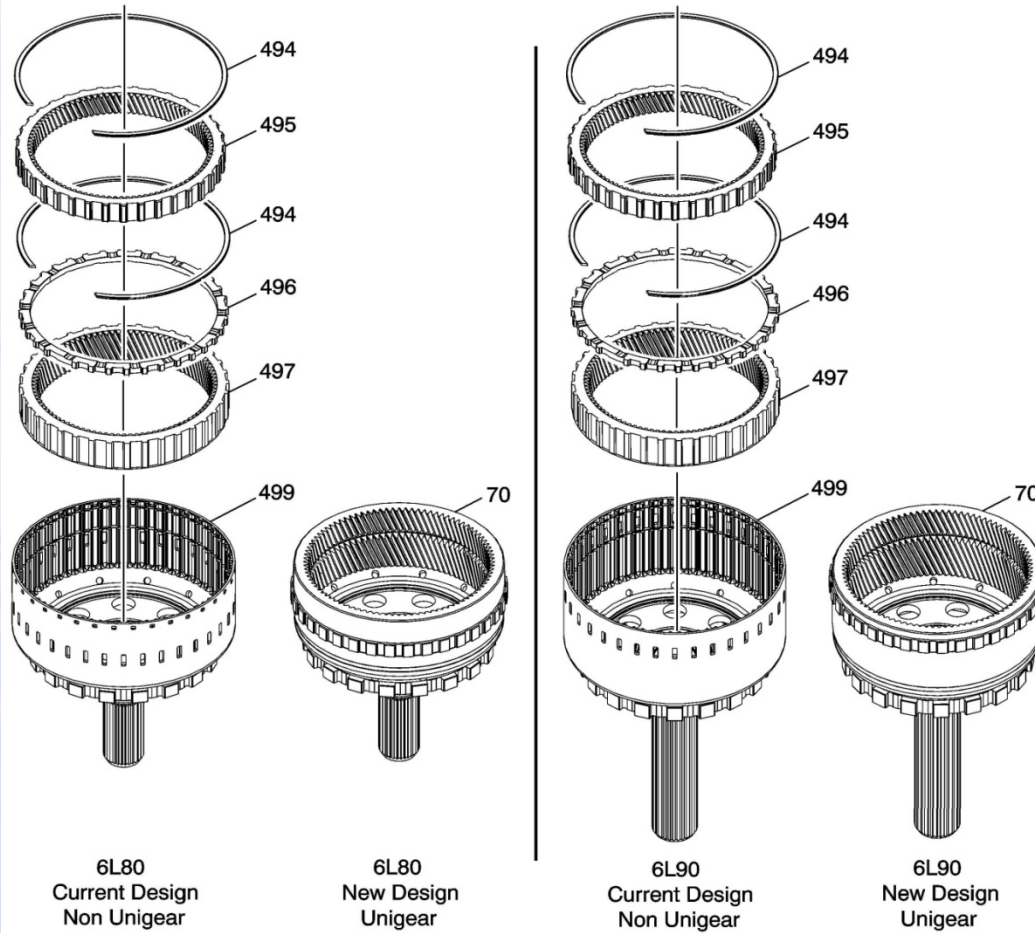

Park Pawl Actuator Guide

Assembly 6L50 6L80 6L90

Update was related to supplier Request, to improve production Volume. Part number changed For all models



Manual Shaft Pin Update 6L50 6L80 6L90



**Length changed 5mm (.19"), taper changed 2.5mm (.09")
Part numbers were updated, shaft will backservice**

6L80 - UPDATE

Spacer Plate and Valve Body Spring Updates

There have been 2 changes in the spacer plates used for the 6L80 starting in mid 2007 as a 2007 interim change adding an exhaust and a parallel path for a lube circuit bleed. In Mid 2008, interim 2008 change has also occurred to address a P0751 code. The spring load on the clutch select valves was lowered to allow the valves to move at a lower pressure reducing tendency of the P0751 code to set. These springs are not available individually.

New Part Numbers:

2006-07

- 24245720 – Spacer Plate
- 24250384 – Lower Valve Body with spring updates

Note: Will back service previous model years

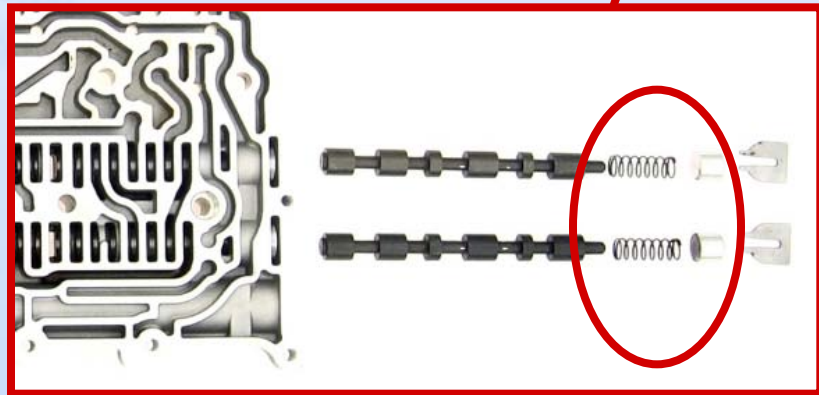
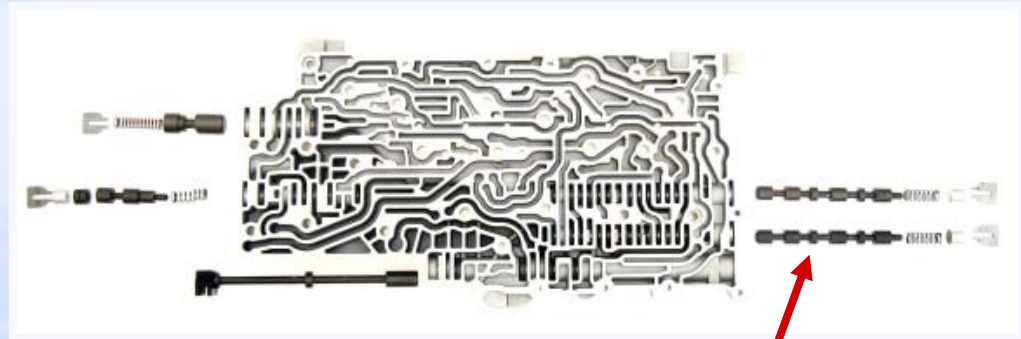

6L80 6L90 Valve Body & Spacer Plate Update 2010

Spacer Plate Update

6L80/6L90 2009 and earlier 242457520

6L80/6L90 2010 and later with updated valve bodies 24261077

		2009 prior	2010 Later
All Variants	Lwr Vlv Body Asm	24250384	24251431
6L45	Upr Vlv Body Asm	None-Launched W/New Design	96043296
6L50	Upr Vlv Body Asm	96043348	96043298
6L80	Upr Vlv Body Asm	24231442	24240961
6L90	Upr Vlv Body Asm	24226709	24240953

6L50/80/90

DTC's P1825, P182E, P1915

Mode Switch Codes – Chevrolet, Cadillac, GMC, Hummer and Pontiac vehicles may have any of these codes set along with the PRNDL display not functioning. These DTC's will set if the following conditions occur:

P1825 will set if:

- IMS range A is Low while in D6 range for more than 8 seconds
- IMS range C is High while in D6 range for more than 8 seconds
- IMS range A, B, P are Low while in Park range for more than 1 second
- P/N switch indicates park/neutral but the IMS shows a range other than P/N
- IMS indicates a INVALID range for more than 3.25 seconds
- VSS greater than 10 MPH
- P0722 or P0723 not set

P1915 will set if:

- Engine speed is greater than 525 RPM for more than 3.25 seconds
- The transmission input shaft speed is greater than 250 RPM
- Transmission output speed less than 90 RPM
- IMS voltage sequence does not follow the designed state

6L50/80/90

DTC's P1825, P182E, P1915

Continued

Mode Switch Codes – If P1825, P1915, or P182E set, the TCM will:

- Command MAX line pressure
- Turn off all solenoids resulting in 3rd or 6th gear default
- Freeze shift adapts

Monitor switch states
with scan tool data.

If switch states are proper,
look at the following
areas:

- Shift Cable
- Shift Lever
- Rooster comb / detent
assembly
- TCM Calibrations
- Replace IMS with new
design switch

Gear Position Selected	Scan Value	IMS Position	P/N Switch	PRNDL
PARK	L/H/H/L	PARK	P/N	PARK
PARK/REVERSE	L/L/H/L	-----	IN GEAR	BLANK
REVERSE	L/L/H/H	REVERSE	IN GEAR	REVERSE
REVERSE/NEUTRAL	H/L/H/L	-----	IN GEAR	BLANK
NEUTRAL	H/L/H/L	NEUTRAL	P/N	NEUTRAL
NEUTRAL/D6	H/L/L/H	-----	IN GEAR	BLANK
D6	H/L/L/H	D6	IN GEAR	DRIVE
D6/D4	L/L/L/H	-----	IN GEAR	BLANK
D4	L/L/L/L	D4	IN GEAR	MANUAL
D4/D3	L/H/L/L	-----	IN GEAR	BLANK
D3	L/H/L/H	D3	IN GEAR	D3
D3/D2	H/H/L/H	-----	IN GEAR	BLANK
D2	H/H/L/L	D2	IN GEAR	D2
INVALID	H/H/H/L	INVALID	IN GEAR	BLANK
INVALID	L/H/H/H	INVALID	IN GEAR	BLANK
INVALID	H/H/H/H	INVALID	IN GEAR	BLANK

6L50/80/90

DTC's P0751

SS1 Solenoid Performance, Stuck Off

P0751 will set if:

- No DTCs P0716, P0717, P0722, P0723, P1915 or P1825 are set
- First gear is commanded
- Commanded gear is 1st and the gear ratio indicates 4th or slip exceeds 35 RPM for .5 - 1.05 seconds

Use SCAN TOOL solenoid cleansing procedures covered in past ATRA seminars, while in vehicle. Do solenoid test with scan tool and TEST PLATE on the bench

Several Causes for P0751

- Debris in pan
- Cracks in filter
- Debris in Separator plate as well as check ball problems
- Clutch Select valve #2 bore plug improper size
- CBR1/C456 regulator valve sticking
- Calibration updates
- Updated Separator Plate and Valve Body Springs (previously covered)

Updated Spacer Plates All Models For a P0751

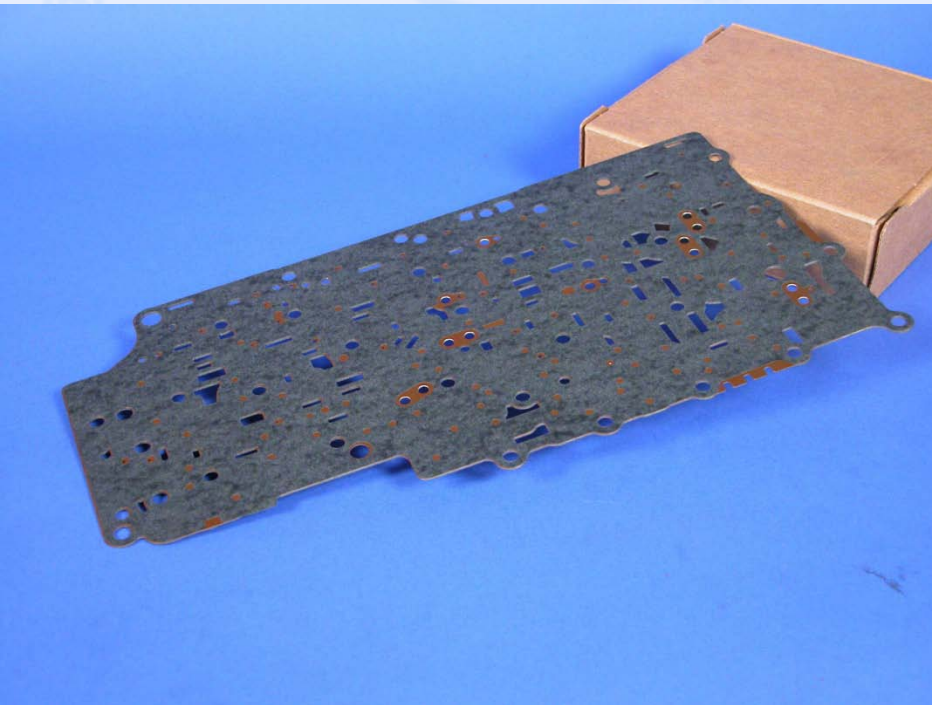

24245720

**(2007-08 MYD) (2008 MYB, MYC) Plate,
Control Valve Spacer**

24246916

**(2006-2007 MYC) Plate, Control Valve
Spacer**

24246917

(2007 MYB) Plate, Control Valve Spacer

24236934

**(MYC, MYD) Plate Kit, Control Solenoid
Valve Filter**

24238925

**(MYB) Plate Kit, Control Solenoid Valve
Filter**

6L50/80/90

DTC's P0751

Continued

SS1 Solenoid Performance, Stuck Off

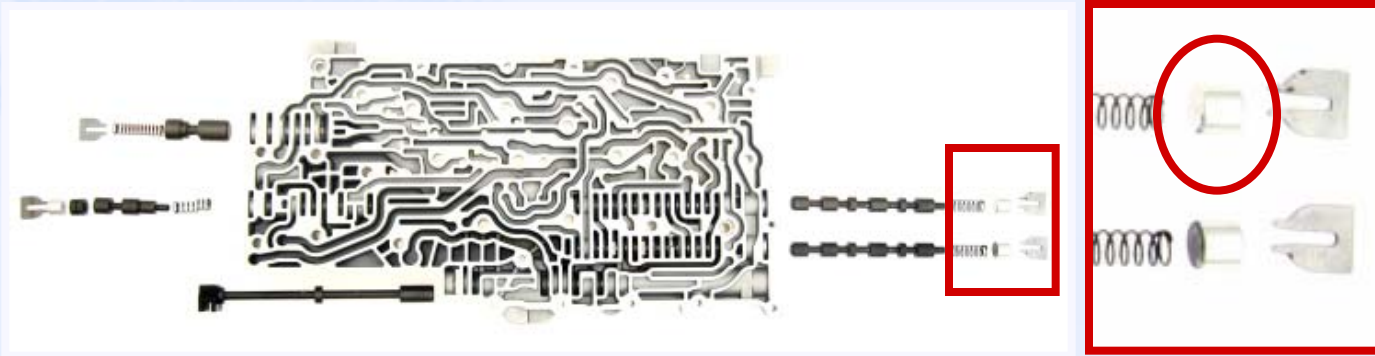

Clutch Select #2 Bore plug must be 11.502mm (0.453") +/- .004mm (0.002")

CBR1/C456 Regulator Valve (Sticking/Dragging)

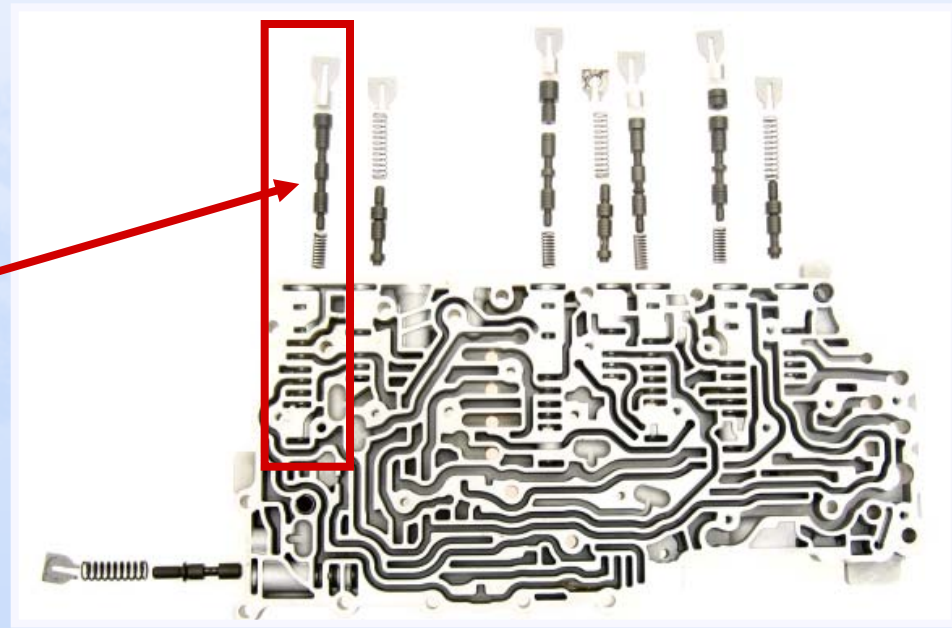

6L80 6L90

No or Slipping 3rd, 5th, and Reverse Flair on the 2-3 Shift

Tahoe, Suburban, C/K Trucks

Common Problem areas for these concerns:

- 3-5 Regulator Valve Sticking. (Upper Valve Body)
- Leak in the 3-5-Rev Drum (air test using soapy water)

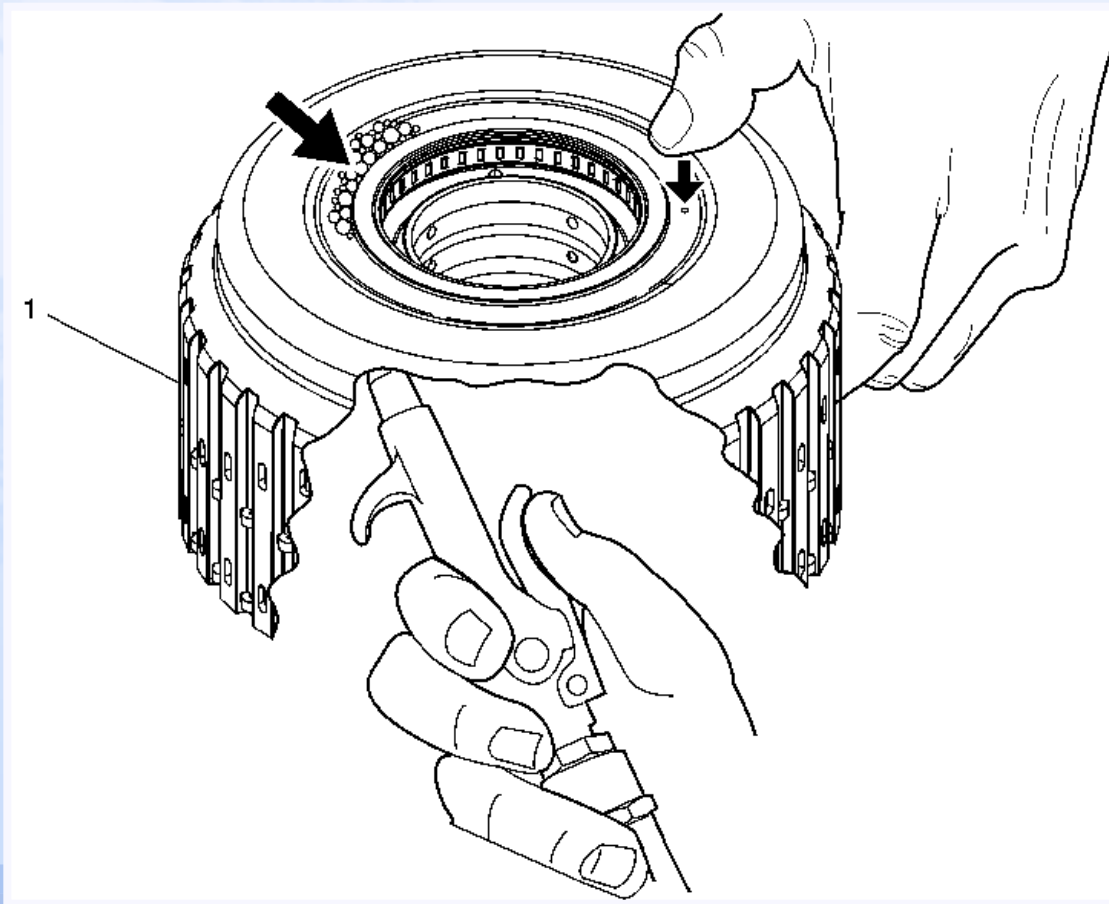

6L80/6L90

Slips in Reverse, 3rd, 5th P0776 Possibly Set, Cracked Drum

6L80 (RPO MYC) and 6L90 (RPO MYD) transmissions equipped in the GM C/K full size trucks and SUV's, Cadillac D body (STS-V) and the Cadillac/Chevrolet Y body (XLR, Corvette) may experience any or all of the following complaints.

- Slips in Reverse
- Slips in 3rd
- Slips in 5th
- Delayed Reverse Engagement
- Intermittent Hard Shifts into 3rd and/or 5th
- Problems change severity with transmission temp change
- P0776 DTC may set

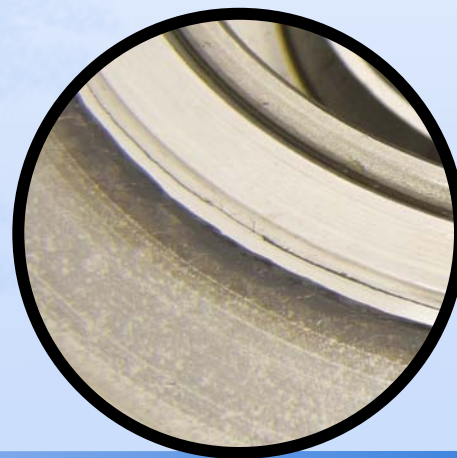

6L80-6L90 - UPDATE

1-2-3-4 / 3-5-R Clutch Pump Cover Seal Update P0776 Slip
Design Change for mid 2009, Interim 2009. Update includes the grooves and seals that are located on the back of the pump cover. Update address's 2-3 shift complaints. The depth of the groove is deeper to allow for a rubber o-ring under the seal.

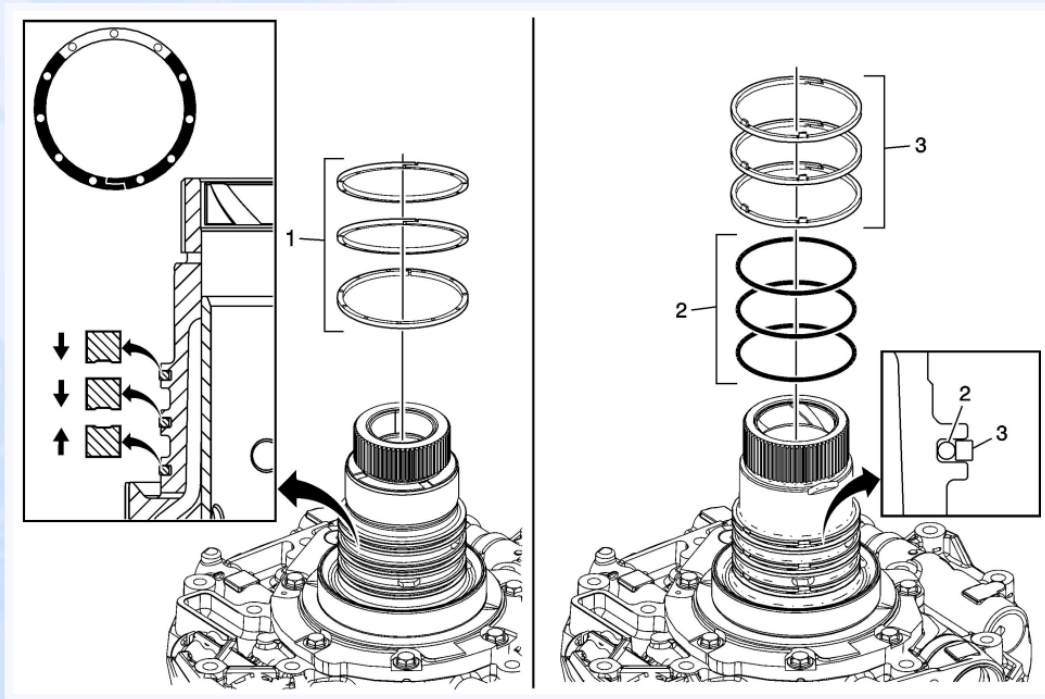

Part Numbers:

24248581 – Seal Kit (Old Design)

24248559 – Seal Kit (New Design)

24248573 – Pump Cover and Seal Kit

6L80 6L90

No or Slipping 3rd, 5th, and Reverse Flair on the 2-3 Shift

Tahoe, Suburban, C/K Trucks

In addition, may have code P0776 (Clutch Pressure Control (PC)-Stuck Off)

P0776 will set if:

- **P0716, P0717, P0722, P0723, P1825 are NOT set**
 - **TFT greater than 32 deg. F ((0 deg. C)**
 - **High side Driver 1 is operational**
 - **Driven wheel speed greater than 80 RPM**
 - **Driven and Non Driven wheel speeds are within 150 RPM**
 - **Input speed greater than 60 RPM**
 - **PCS 2 is ON**
 - **3rd or 5th gear ratio has been achieved**
 - **TCM detects an incorrect on-coming clutch gear ratio, flare when the 3-5-R clutch is commanded "ON" for 2.25 seconds and the transmission input shaft speed is greater than 60 to 100 RPM from the anticipated input shaft speed**
- When P0766 sets the TCM will: Command Max. Line Pressure, Inhibit TCC, and Freeze the shift adapts.**

6L80 6L90

No or Slipping 3rd, 5th, and Reverse Flair on the 2-3 Shift

Tahoe, Suburban, C/K Trucks (continued)

Common Problem areas for these concerns:

- 3-5 Regulator Valve Sticking. (Upper Valve Body)

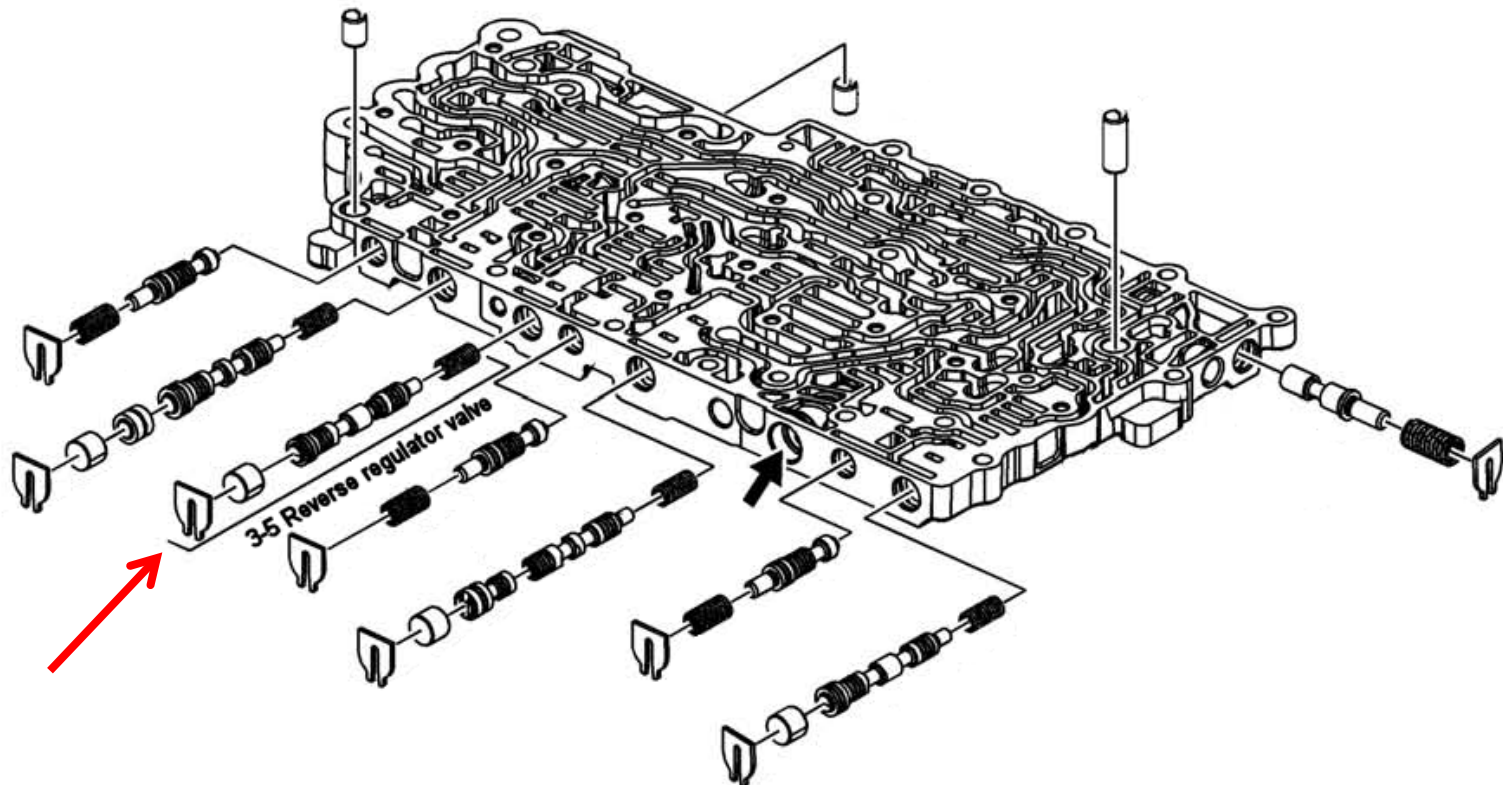

Park Pawl Rod 6L80-6L90 Update

**Update was designed
To address No Park
Concerns
08 and earlier
Heavier duty rod,
Updated part #
Will backservice**



6L80

New Valve Body Bolts

Inverted #50 Torx Plus Bolts

There are six new inverted #50 Torx Plus bolts used on late model 6L80 transmission valve body. If the tool is “Unavailable” at the time of inspection, use a bell housing bolt from a 4L60E late model (#50 Torx) along with a couple of jam nuts to assembly a tool that will work as a substitute.

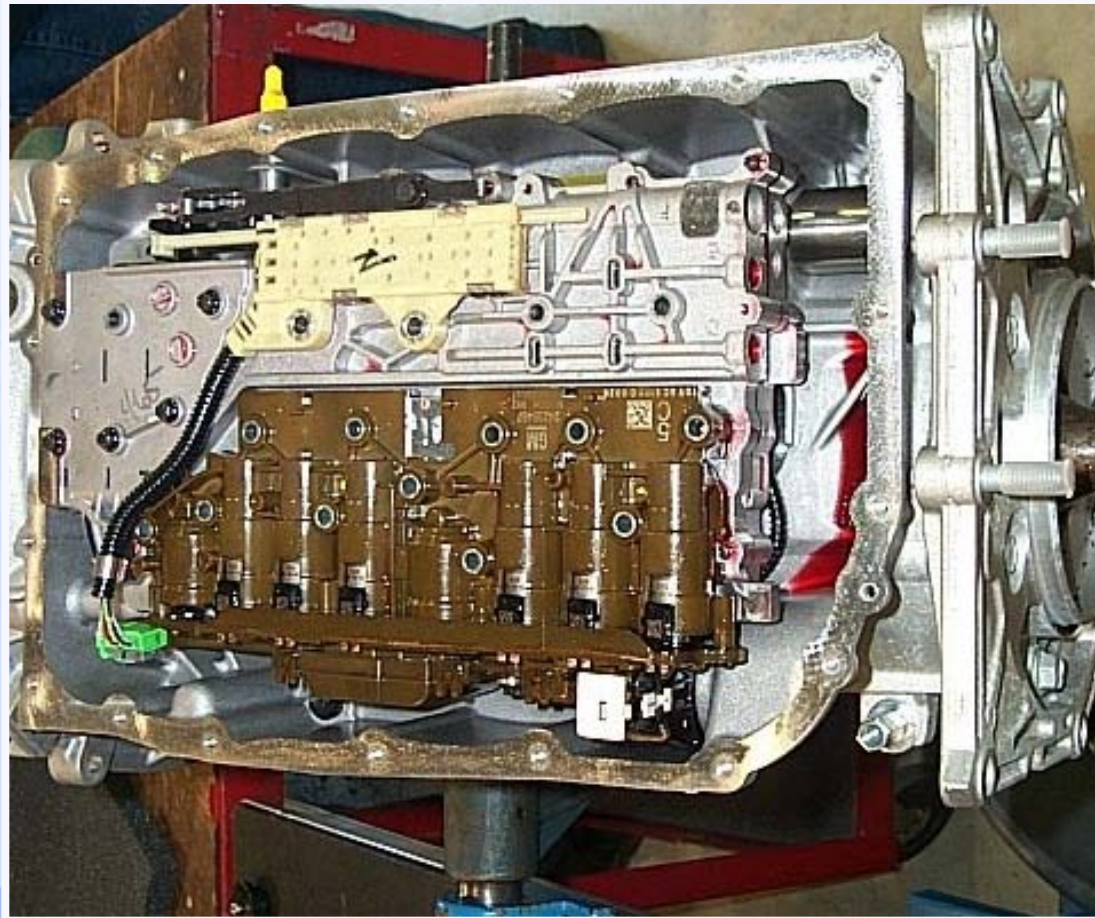

6L80

Intermittent Harsh Downshift, Chuggle or Shudder During Deceleration 5.3L

Tahoe, Suburban, C/K Trucks

Customer complaint may be harsh forced downshifts or the chuggle/shudder during a coast down intermittently.

This is considered “Normal” with this powertrain package. It is a self test for the O2 sensors.

Test runs with the vehicle speed above 45 MPH (72 kph) in 6th gear with the TCC applied. The ECM drives the fuel system rich and then into deceleration fuel cutoff mode (shutting the injectors off) to check the system. Test will end during the deceleration and fuel is restored. (This typically causes the Shudder/Chuggle shift feel in the vehicle).

Aggressive throttle response during this system check mode will cause the vehicle to have a “Harsh” downshift (this happens because the TCC remains applied during the test).

If the test runs while in 5th gear, the TCC will not be applied and the complaint will not likely occur.

Note: The test is designed to occur one time per key cycle, but can run up to 10 times if aborted due to throttle input.

6L80 or 6L90

Transmission Overtemp Indicated. Possible DTC set

Inspect the cooler lines for a restriction. In many instances, the cooler lines are kinked close to the radiator leading to the restriction. If the fluid appears to be distressed you may need to repair damage that may have occurred to the transmission. If the cooler lines are kinked try to straighten them. If the lines have been operating with a kink in them for some time, you may find it necessary to replace them as the restriction from the kink may cause the restriction to “take a set” in the line.

C/K Full Size
Trucks With
6L80 Or
6L90



6L80 or 6L90

Slipping, No Forward or Reverse

The filter may have developed a crack leading to air ingestion in the hydraulic circuits. This condition has been found on the OE as well as some aftermarket filter designs. Closely inspect the filter for cracks and separation in the seam area of the filter. Upon inspection of the filter, if a crack or damage is found, you may need to disassemble the pump and inspect it for damage. Replace the filter and any damaged pump components.

Some 6L80
(C/K/G
Trucks/Vans, Y,
F and D cars
(RPO MYC)) and
6L90 (C/K/G
Truck/ Vans
(RPO MYD)
transmissions



6L80/6L90

P0756, P0766, P0796, P2714, P2723

Clutch Pressure Control Solenoid Stuck Off Codes Caused by Valve Body Issues

DO NOT REPLACE TEHCM FOR THESE CODES!

Common to all the DTC's:

- Check balls not sealing on the spacer plate.
- Spacer plate damaged, worn check ball holes.
- Bore plugs undersized or the incorrect bore plug was used. Bore plugs should measure $0.4528" \pm 0.0001"$ or $11.502\text{mm} \pm 0.004\text{mm}$.
- Debris
- Cracks in the suspect drum or seal leakage feeding the suspect drum.

6L80/6L90

P0756, P0766, P0796, P2714, P2723

Clutch Pressure Control Solenoid Stuck Off Codes Caused by Valve Body Issues

Specific DTC Inspection:

- **P0756 – Inspect the Clutch select valve #3 in the lower valve body for evidence of wear and sticking.**
- **P0776 – Inspect the 3-5-R clutch regulator valve in the upper valve body for evidence of wear and sticking. Inspect the 3-6 reverse drum for cracks, inspect the seals for leakage.**
- **P0796 – Inspect the CBR1/4-5-6 clutch regulator valve in the upper valve body for evidence of wear and sticking. Inspect the seals/circuit for leakage.**
- **P2714 – Inspect the 2-6 clutch regulator valve in the upper valve body for evidence of wear and sticking. Inspect the seals/circuit for leakage.**
- **P2723 – Inspect the 1-2-3-4 clutch regulator valve in the upper valve body for evidence of wear and sticking. Inspect the seals/circuit for leakage.**

6L80/6L90

P0756, P0766, P0796, P2714, P2723

Clutch Pressure Control Solenoid Stuck Off Codes Caused by Valve Body Issues (continued)

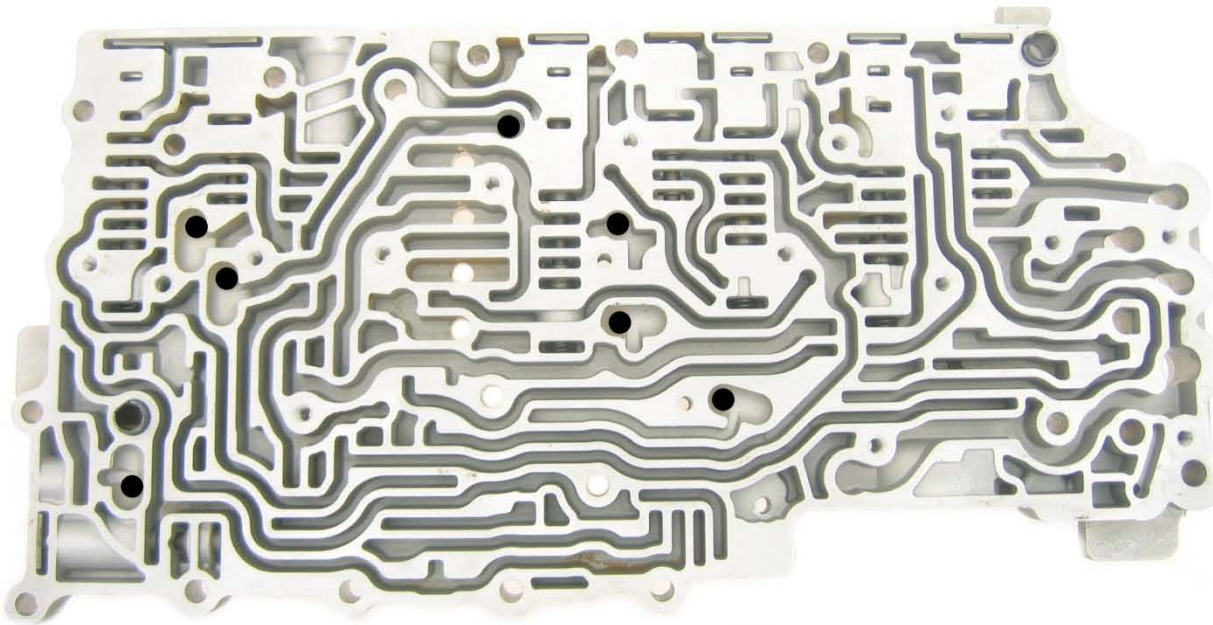

Clutch Select Valve #3



Clutch Select Valve #2

6L80/6L90

P0756, P0766, P0796, P2714, P2723

Clutch Pressure Control Solenoid Stuck Off Codes Caused by Valve Body Issues (continued)

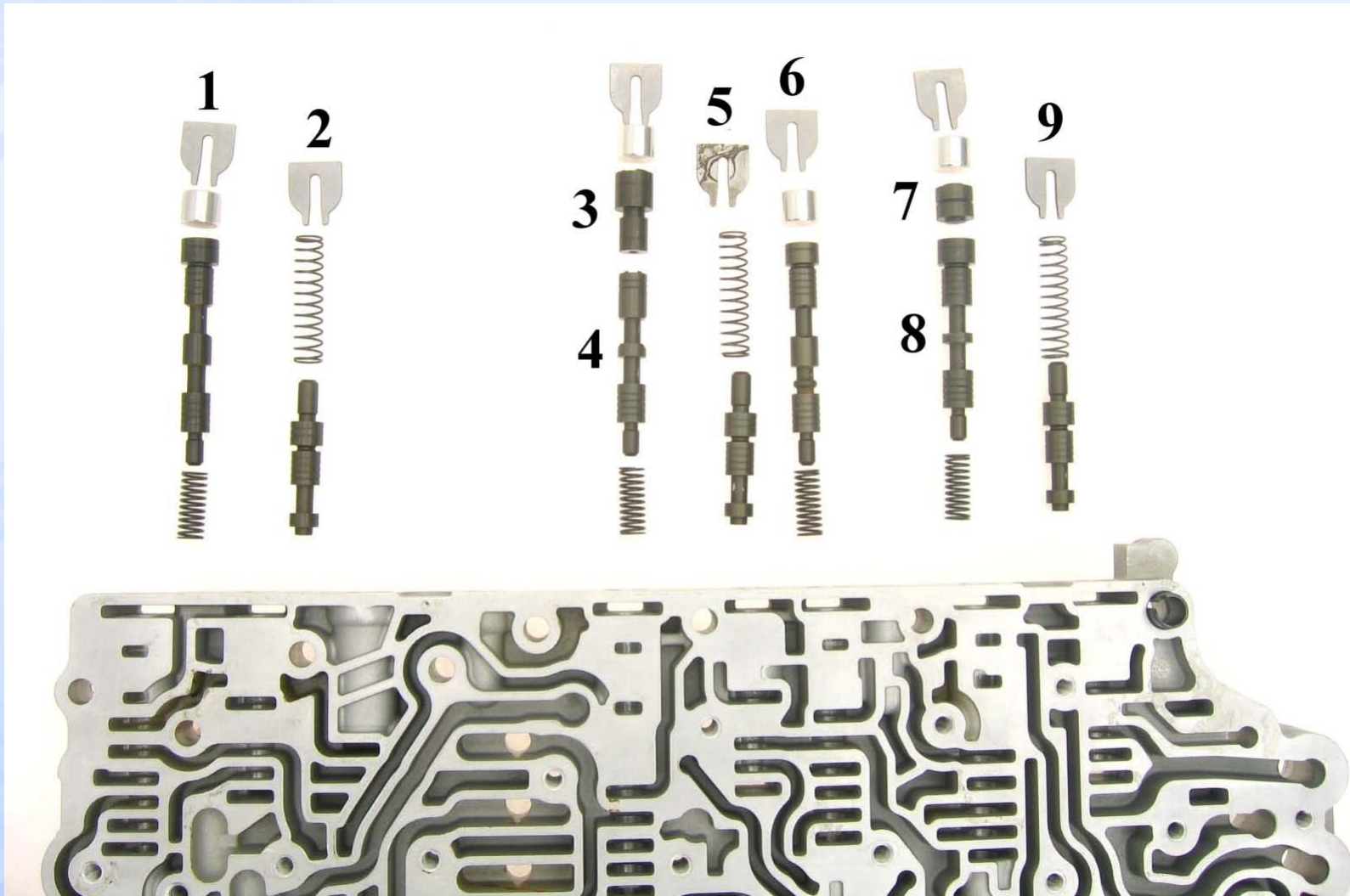

6L80/6L90 (MYC, MYD)

Excessive TCC Slip, Possible DTC P0741

CONCERN: On high mileage 6L80/6L90 (RPO MYC, MYD) applications a excessive TCC slip condition may occur. This condition may/may not set a code P0741.

CAUSE: The TCC friction material is delaminating. The root cause of this concern has not yet been determined.

REPAIR: To repair the concern, replace the torque converter.

6L80/6L90 (MYC, MYD)

Planetary Noise, Planetary Damage

CONCERN: Some 6L80/6L90 (RPO MYC, MYD) transmissions may exhibit a growling or rumble type noise from the transmission. The noise may change depending on the gear the transmission is in.

CAUSE: Inspect the input planetary carrier for damage to the teeth. Even when a noise is not present the technician should always inspect the planetary for physical damage. The race on Bearing #54 may be broken. Parts of the race may have gotten into the planetary which can lead to gear damage.

REPAIR: Replace the damaged planetary components and bearings.